



中认信通
CHINA CERTIFICATION ICT CO., LTD (DONGGUAN)



TEST REPORT

Applicant: AKUVOX (XIAMEN) NETWORKS CO., LTD.

Address: 10/F, No.56 Guanri Road, Software Park II, Xiamen 361009, China

FCC ID: 2AHCR-S563W

Product Name: Indoor Monitor

**Standard(s): 47 CFR Part 15, Subpart C(15.247)
ANSI C63.10-2013**

KDB 558074 D01 15.247 Meas Guidance v05r02

The above device has been tested and found compliant with the requirement of the relative standards by China Certification ICT Co., Ltd (Dongguan)

Report Number: CR231167748-00B

Date Of Issue: 2024/2/22

Reviewed By: Calvin Chen

Title: RF Engineer

Approved By: Sun Zhong

Title: Manager

Test Laboratory: China Certification ICT Co., Ltd (Dongguan)

No. 113, Pingkang Road, Dalang Town, Dongguan,
Guangdong, China
Tel: +86-769-82016888

Test Facility

The Test site used by China Certification ICT Co., Ltd (Dongguan) to collect test data is located on the No. 113, Pingkang Road, Dalang Town, Dongguan, Guangdong, China.

The lab has been recognized as the FCC accredited lab under the KDB 974614 D01 and is listed in the FCC Public Access Link (PAL) database, FCC Registration No. : 442868, the FCC Designation No. : CN1314.

Declarations

China Certification ICT Co., Ltd (Dongguan) is not responsible for the authenticity of any test data provided by the applicant. Data included from the applicant that may affect test results are marked with a triangle symbol “▲”. Customer model name, addresses, names, trademarks etc. are not considered data.

Unless otherwise stated the results shown in this test report refer only to the sample(s) tested.

This report cannot be reproduced except in full, without prior written approval of the Company.

This report is valid only with a valid digital signature. The digital signature may be available only under the Adobe software above version 7.0.

This report may contain data that are not covered by the accreditation scope and shall be marked with an asterisk “★”.

CONTENTS

DOCUMENT REVISION HISTORY	5
1. GENERAL INFORMATION	6
1.1 PRODUCT DESCRIPTION FOR EQUIPMENT UNDER TEST (EUT)	6
1.2 DESCRIPTION OF TEST CONFIGURATION.....	7
1.2.1 EUT Operation Condition:	7
1.2.2 Support Equipment List and Details	7
1.2.3 Support Cable List and Details	7
1.2.4 Block Diagram of Test Setup.....	8
1.3 MEASUREMENT UNCERTAINTY	10
2. SUMMARY OF TEST RESULTS	11
3. REQUIREMENTS AND TEST PROCEDURES	12
3.1 AC LINE CONDUCTED EMISSIONS.....	12
3.1.1 Applicable Standard.....	12
3.1.2 EUT Setup.....	13
3.1.3 EMI Test Receiver Setup	13
3.1.4 Test Procedure	14
3.1.5 Corrected Amplitude & Margin Calculation.....	14
3.2 RADIATED SPURIOUS EMISSIONS.....	15
3.2.1 Applicable Standard.....	15
3.2.2 EUT Setup.....	15
3.2.3 EMI Test Receiver & Spectrum Analyzer Setup	16
3.2.4 Test Procedure	17
3.2.5 Corrected Amplitude & Margin Calculation.....	17
3.3 20 DB EMISSION BANDWIDTH	18
3.3.1 Applicable Standard.....	18
3.3.2 EUT Setup.....	18
3.3.3 Test Procedure	18
3.4 CHANNEL SEPARATION	20
3.4.1 Applicable Standard.....	20
3.4.2 EUT Setup.....	20
3.4.3 Test Procedure	20
3.5 NUMBER OF HOPPING FREQUENCY.....	21
3.5.1 Applicable Standard.....	21
3.5.2 EUT Setup.....	21
3.5.3 Test Procedure	21
3.6 TIME OF OCCUPANCY (DWELL TIME).....	22
3.6.1 Applicable Standard.....	22
3.6.2 EUT Setup.....	22
3.6.3 Test Procedure	22
3.7 MAXIMUM CONDUCTED OUTPUT POWER.....	23
3.7.1 Applicable Standard.....	23
3.7.2 EUT Setup.....	23

3.7.3 Test Procedure23

3.8 100 KHZ BANDWIDTH OF FREQUENCY BAND EDGE.....24

3.8.1 Applicable Standard.....24

3.8.2 EUT Setup.....24

3.8.3 Test Procedure24

3.9 ANTENNA REQUIREMENT.....25

3.9.1 Applicable Standard.....25

3.9.2 Judgment.....25

4. TEST DATA AND RESULTS 26

4.1 AC LINE CONDUCTED EMISSIONS.....26

4.2 RADIATED SPURIOUS EMISSIONS.....31

4.3 20 dB EMISSION BANDWIDTH54

4.4 CHANNEL SEPARATION58

4.5 NUMBER OF HOPPING FREQUENCY.....62

4.6 TIME OF OCCUPANCY (DWELL TIME).....64

4.7 MAXIMUM CONDUCTED OUTPUT POWER.....68

4.8 100 KHZ BANDWIDTH OF FREQUENCY BAND EDGE.....75

5. EUT PHOTOGRAPHS 82

6. TEST SETUP PHOTOGRAPHS 83

DOCUMENT REVISION HISTORY

Revision Number	Report Number	Description of Revision	Date of Revision
1.0	CR231167748-00B	Original Report	2024/2/22

1. GENERAL INFORMATION

1.1 Product Description for Equipment under Test (EUT)

EUT Name:	Indoor Monitor
EUT Model:	S563W
Operation Frequency:	2402-2480 MHz
Maximum Peak Output Power (Conducted):	4.88 dBm
Modulation Type:	GFSK, $\pi/4$ -DQPSK, 8DPSK
Rated Input Voltage:	DC 12V From Adapter DC 48V From POE
Serial Number:	2DS2-1(For RF Conducted Test) 2DS2-2(For RE/CE Test)
EUT Received Date:	2023/11/16
EUT Received Status:	Good

Operation Frequency Detail:

Channel	Frequency (MHz)	Channel	Frequency (MHz)
0	2402	40	2442
1	2403	41	2443
...
...
...	...	78	2480
39	2441	/	/

Per section 15.31(m), the below frequencies were performed to test:

Test Channel	Frequency (MHz)
Lowest	2402
Middle	2441
Highest	2480

Antenna Information Detail▲:

Antenna Type	input impedance (Ohm)	Frequency Range	Antenna Gain
FPC	50	2.4~2.5GHz	3.1 dBi

The Method of §15.203 Compliance:

- Antenna was permanently attached to the unit.
 Antenna use a unique type of connector to attach to the EUT.
 Unit was professionally installed, and installer shall be responsible for verifying that the correct antenna is employed with the unit.

Accessory Information:

Accessory Description	Manufacturer	Model	Parameters
/	/	/	/

1.2 Description of Test Configuration

1.2.1 EUT Operation Condition:

EUT Operation Mode:	The system was configured for testing in Engineering Mode, which was provided by the manufacturer.		
Equipment Modifications:	No		
EUT Exercise Software:	CMD		
The software was provided by manufacturer. The maximum power was configured as below, that was provided by the manufacturer▲:			
Test Modes	Power Level Setting		
	Lowest	Middle	Highest
GFSK	default	default	default
$\pi/4$ -DQPSK	default	default	default
8DPSK	default	default	default

1.2.2 Support Equipment List and Details

Manufacturer	Description	Model	Serial Number
DEBOM	Adapter	DBS012A-1201000J	Unknown
TOTO Link	Router	LR1200	190924004S1
Nexhome	Door Phone	DH-I66S(P)	EMZBIU20113001
/	RS485 Load	RS485-X1	F-EM-PHRJ45X8011
DELL	Laptop	E6410	GMLGPM1
/	Relay Load	Relay-C1	EMRLLD20221010EN
Metke Skycom	POE	S213M-5	MT21090063
GWT	Bell	A-24	Unknown
GWT	Alarm	unknown	Unknown

1.2.3 Support Cable List and Details

Cable Description	Shielding Type	Ferrite Core	Length (m)	From Port	To
DC Cable	No	No	1	Adapter	EUT
RJ45 Cable	No	No	10	Router	EUT
RJ45 Cable	No	No	2	Router	Door Phone
RJ45 Cable	No	No	10	Router	POE
RJ45 Cable	No	No	0.3	POE	EUT
AC Cable	No	No	1	POE	LISN
RS485 Cable	No	No	3	RS485 Load	EUT
DC Cable	No	No	3	Relay Load	EUT
RJ45 Cable	No	No	10	Laptop	EUT
DC Cable	No	No	3	Bell	EUT
DC Cable	No	No	3	Alarm	EUT

1.2.4 Block Diagram of Test Setup

AC Line Conducted Emissions:

Adapter:

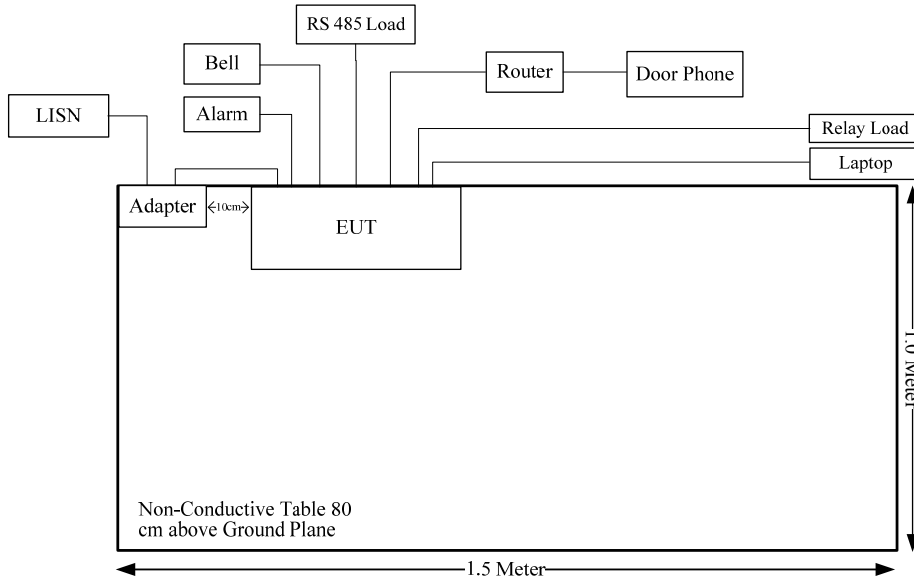

POE:

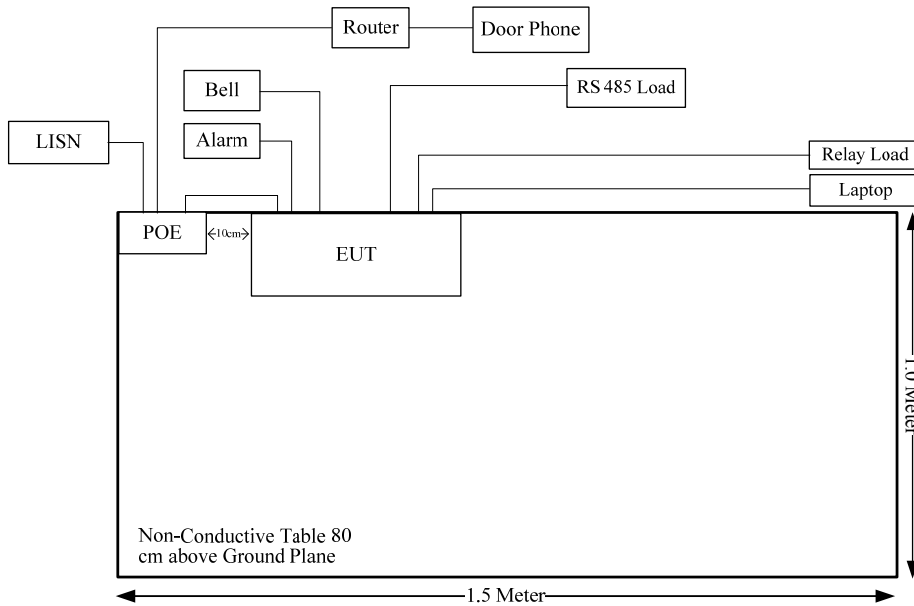

Radiation Spurious Emissions:

Adapter:

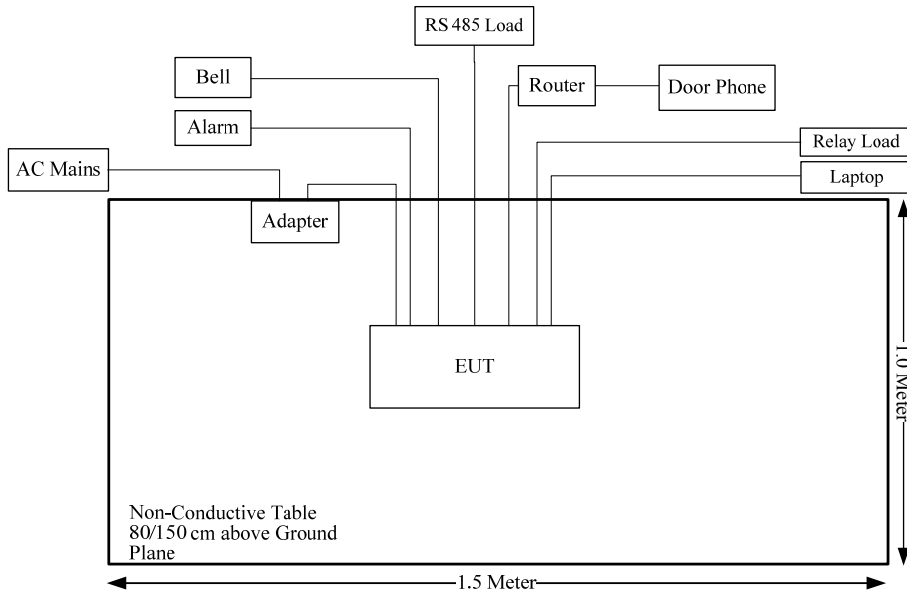

POE:

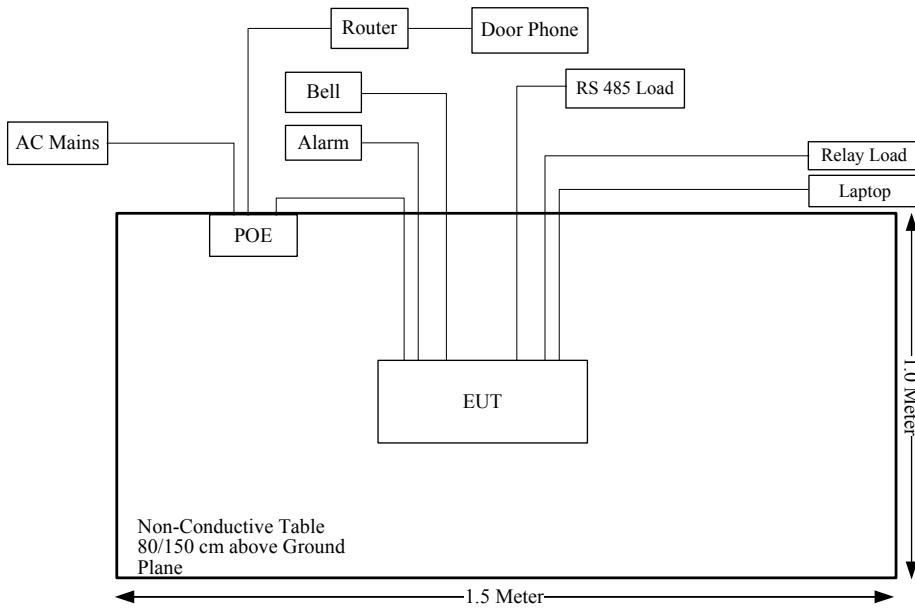

1.3 Measurement Uncertainty

Otherwise required by the applicant or Product Regulations, Decision Rule in this report did not consider the uncertainty. The extended uncertainty given in this report is obtained by combining the standard uncertainty times the coverage factor K with the 95% confidence interval.

Parameter	Measurement Uncertainty
Occupied Channel Bandwidth	±5 %
RF output power, conducted	±0.61dB
Power Spectral Density, conducted	±0.61 dB
Unwanted Emissions, radiated	9kHz~30MHz: 4.12dB, 30M~200MHz: 4.15 dB, 200M~1GHz: 5.61 dB,1G~6GHz: 5.14 dB, 6G~18GHz: 5.93 dB, 18G~26.5G:5.47 dB,26.5G~40G:5.63 dB
Unwanted Emissions, conducted	±1.26 dB
Temperature	±1 °C
Humidity	±5%
DC and low frequency voltages	±0.4%
Duty Cycle	1%
AC Power Lines Conducted Emission	2.8 dB (150 kHz to 30 MHz)

2. SUMMARY OF TEST RESULTS

FCC Rules	Description of Test	Result
FCC §15.207(a)	AC Line Conducted Emissions	Compliant
FCC §15.205, §15.209, §15.247(d)	Radiated Spurious Emissions	Compliant
FCC §15.247(a)(1)	20 dB Emission Bandwidth	Compliant
FCC §15.247(a)(1)	Channel Separation	Compliant
FCC §15.247(a)(1)(iii)	Number of Hopping Frequency	Compliant
FCC §15.247(a)(1)(iii)	Time of Occupancy (Dwell Time)	Compliant
FCC §15.247(b)(1)	Maximum Conducted Output Power	Compliant
FCC §15.247(d)	100 kHz Bandwidth of Frequency Band Edge	Compliant
FCC §15.203	Antenna Requirement	Compliant

3. REQUIREMENTS AND TEST PROCEDURES

3.1 AC Line Conducted Emissions

3.1.1 Applicable Standard

FCC§15.207(a).

(a) Except as shown in paragraphs (b) and (c) of this section, for an intentional radiator that is designed to be connected to the public utility (AC) power line, the radio frequency voltage that is conducted back onto the AC power line on any frequency or frequencies, within the band 150 kHz to 30 MHz, shall not exceed the limits in the following table, as measured using a 50 μ H/50 ohms line impedance stabilization network (LISN). Compliance with the provisions of this paragraph shall be based on the measurement of the radio frequency voltage between each power line and ground at the power terminal. The lower limit applies at the boundary between the frequency ranges.

Frequency of emission (MHz)	Conducted limit (dB μ V)	
	Quasi-peak	Average
0.15-0.5	66 to 56*	56 to 46*
0.5-5	56	46
5-30	60	50

*Decreases with the logarithm of the frequency.

(b) The limit shown in paragraph (a) of this section shall not apply to carrier current systems operating as intentional radiators on frequencies below 30 MHz. In lieu thereof, these carrier current systems shall be subject to the following standards:

(1) For carrier current system containing their fundamental emission within the frequency band 535-1705 kHz and intended to be received using a standard AM broadcast receiver: no limit on conducted emissions.

(2) For all other carrier current systems: 1000 μ V within the frequency band 535-1705 kHz, as measured using a 50 μ H/50 ohms LISN.

(3) Carrier current systems operating below 30 MHz are also subject to the radiated emission limits in §15.205, §15.209, §15.221, §15.223, or §15.227, as appropriate.

(c) Measurements to demonstrate compliance with the conducted limits are not required for devices which only employ battery power for operation and which do not operate from the AC power lines or contain provisions for operation while connected to the AC power lines. Devices that include, or make provisions for, the use of battery chargers which permit operating while charging, AC adapters or battery eliminators or that connect to the AC power lines indirectly, obtaining their power through another device which is connected to the AC power lines, shall be tested to demonstrate compliance with the conducted limits.

3.1.2 EUT Setup

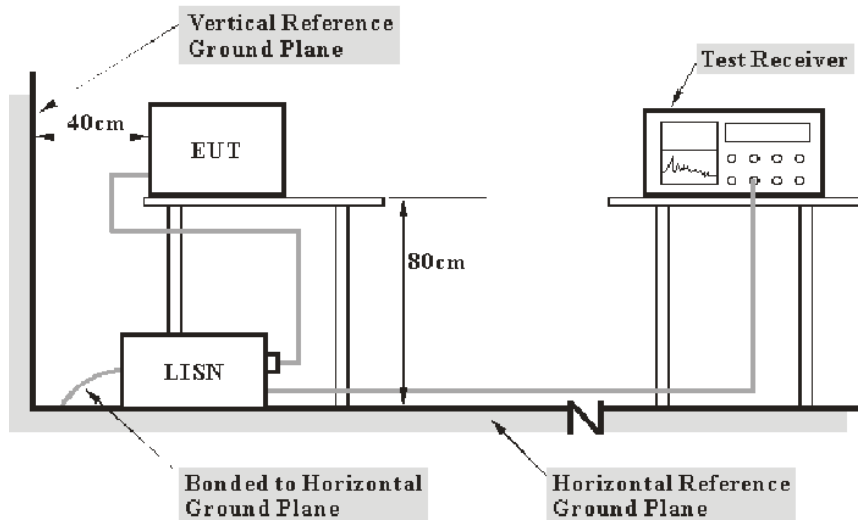

- Note: 1. Support units were connected to second LISN.
 2. Both of LISNs (AMN) 80 cm from EUT and at the least 80 cm from other units and other metal planes support units.

The setup of EUT is according with per ANSI C63.10-2013 measurement procedure. The specification used was with the FCC Part 15.207 limits.

The spacing between the peripherals was 10 cm.

3.1.3 EMI Test Receiver Setup

The EMI test receiver was set to investigate the spectrum from 150 kHz to 30 MHz.

During the conducted emission test, the EMI test receiver was set with the following configurations:

Frequency Range	IF B/W
150 kHz – 30 MHz	9 kHz

3.1.4 Test Procedure

The frequency and amplitude of the six highest ac power-line conducted emissions relative to the limit, measured over all the current-carrying conductors of the EUT power cords, and the operating frequency or frequency to which the EUT is tuned (if appropriate), should be reported, unless such emissions are more than 20 dB below the limit. AC power-line conducted emissions measurements are to be separately carried out only on each of the phase (“hot”) line(s) and (if used) on the neutral line(s), but not on the ground [protective earth] line(s). If less than six emission frequencies are within 20 dB of the limit, then the noise level of the measuring instrument at representative frequencies should be reported. The specific conductor of the power-line cord for each of the reported emissions should be identified. Measure the six highest emissions with respect to the limit on each current-carrying conductor of each power cord associated with the EUT (but not the power cords of associated or peripheral equipment that are part of the test configuration). Then, report the six highest emissions with respect to the limit from among all the measurements identifying the frequency and specific current-carrying conductor identified with the emission. The six highest emissions should be reported for each of the current-carrying conductors, or the six highest emissions may be reported over all the current-carrying conductors.

3.1.5 Corrected Amplitude & Margin Calculation

The basic equation is as follows:

Result = Reading + Factor

Factor = attenuation caused by cable loss + voltage division factor of AMN

The “**Margin**” column of the following data tables indicates the degree of compliance within the applicable limit. The equation for margin calculation is as follows:

Margin = Limit – Result

3.2 Radiated Spurious Emissions

3.2.1 Applicable Standard

FCC §15.247 (d);

In any 100 kHz bandwidth outside the frequency band in which the spread spectrum or digitally modulated intentional radiator is operating, the radio frequency power that is produced by the intentional radiator shall be at least 20 dB below that in the 100 kHz bandwidth within the band that contains the highest level of the desired power, based on either an RF conducted or a radiated measurement, provided the transmitter demonstrates compliance with the peak conducted power limits. If the transmitter complies with the conducted power limits based on the use of RMS averaging over a time interval, as permitted under paragraph (b)(3) of this section, the attenuation required under this paragraph shall be 30 dB instead of 20 dB. Attenuation below the general limits specified in §15.209(a) is not required. In addition, radiated emissions which fall in the restricted bands, as defined in §15.205(a), must also comply with the radiated emission limits specified in §15.209(a) (see §15.205(c)).

3.2.2 EUT Setup

9kHz~30MHz:

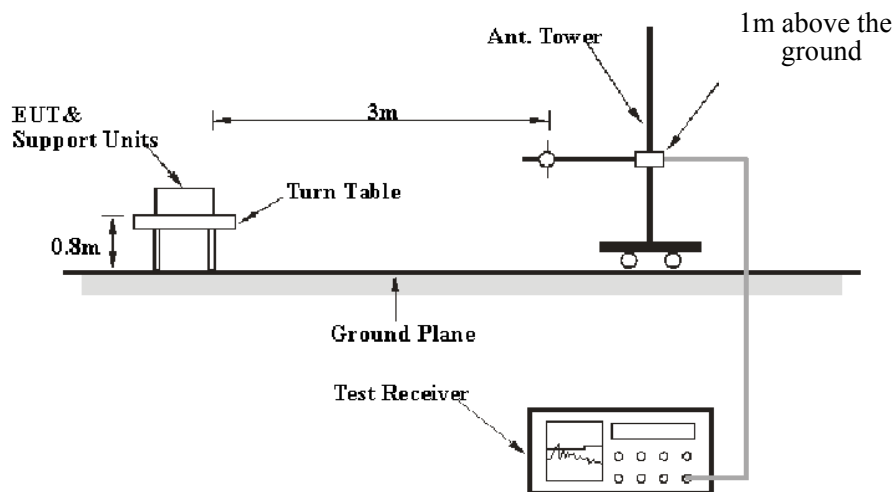

30MHz~1GHz:

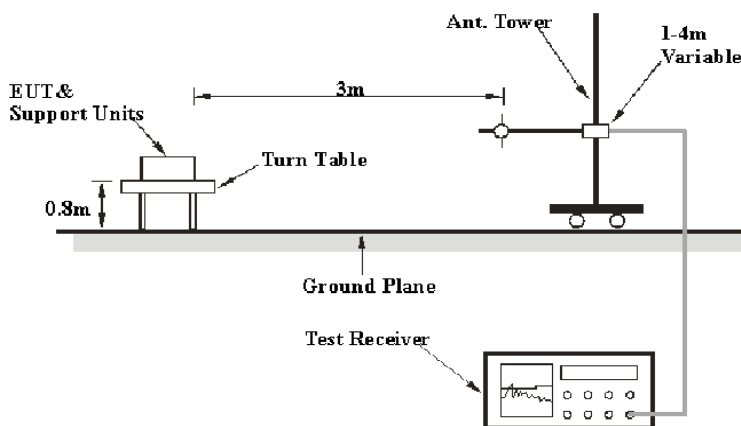

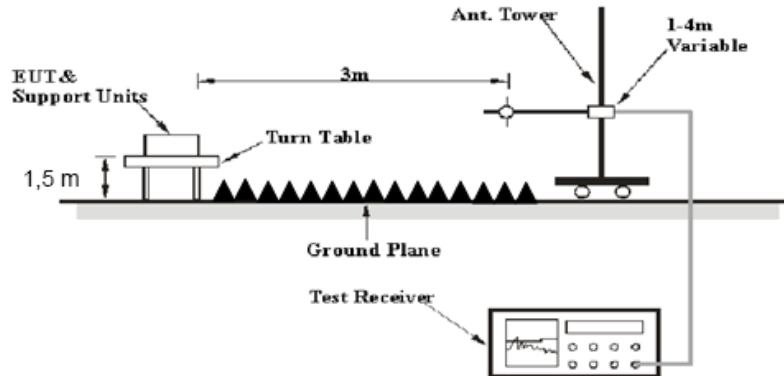
Above 1GHz:

The radiated emissions were performed in the 3 meters distance, using the setup accordance with the ANSI C63.10-2013. The specification used was the FCC 15.209, and FCC 15.247 limits.

The external I/O cables were draped along the test table and formed a bundle 30 to 40 cm long in the middle.

The spacing between the peripherals was 10 cm.

For 9kHz-30MHz test, the lowest height of the magnetic antenna shall be 1 m above the ground and three antenna orientations (parallel, perpendicular, and ground-parallel) shall be measured.

3.2.3 EMI Test Receiver & Spectrum Analyzer Setup

The system was investigated from 9kHz to 25 GHz.

During the radiated emission test, the EMI test receiver & Spectrum Analyzer Setup were set with the following configurations:

Frequency Range	RBW	Video B/W	IF B/W	Measurement
9 kHz – 150 kHz	200 Hz	1 kHz	/	PK
	/	/	200 Hz	QP/AV
150 kHz – 30 MHz	9 kHz	30 kHz	/	PK
	/	/	9 kHz	QP/AV
30 MHz – 1000 MHz	100 kHz	300 kHz	/	PK
	/	/	120 kHz	QP
Above 1 GHz	1MHz	3 MHz	/	PK
	1MHz	10 Hz	/	AV

If the maximized peak measured value complies with under the QP/Average limit more than 6dB, then it is unnecessary to perform an QP/Average measurement.

3.2.4 Test Procedure

Maximizing procedure was performed on the highest emissions to ensure that the EUT complied with all installation combinations.

Data was recorded in Quasi-peak detection mode for frequency range of 9 kHz-1 GHz except 9 - 90 kHz, 110 - 490 kHz, employing an average detector, peak and Average detection modes for frequencies above 1 GHz.

All emissions under the average limit and under the noise floor have not recorded in the report.

3.2.5 Corrected Amplitude & Margin Calculation

The basic equation is as follows:

Result = Reading + Factor

Factor = Antenna Factor + Cable Loss- Amplifier Gain

The “**Margin**” column of the following data tables indicates the degree of compliance within the applicable limit. The equation for margin calculation is as follows:

Margin = Limit – Result

3.3 20 dB Emission Bandwidth

3.3.1 Applicable Standard

FCC §15.247 (a)(1)

Frequency hopping systems shall have hopping channel carrier frequencies separated by a minimum of 25 kHz or the 20 dB bandwidth of the hopping channel, whichever is greater. Alternatively, frequency hopping systems operating in the 2400-2483.5 MHz band may have hopping channel carrier frequencies that are separated by 25 kHz or two-thirds of the 20 dB bandwidth of the hopping channel, whichever is greater, provided the systems operate with an output power no greater than 125 mW. The system shall hop to channel frequencies that are selected at the system hopping rate from a pseudo randomly ordered list of hopping frequencies. Each frequency must be used equally on the average by each transmitter. The system receivers shall have input bandwidths that match the hopping channel bandwidths of their corresponding transmitters and shall shift frequencies in synchronization with the transmitted signals.

3.3.2 EUT Setup

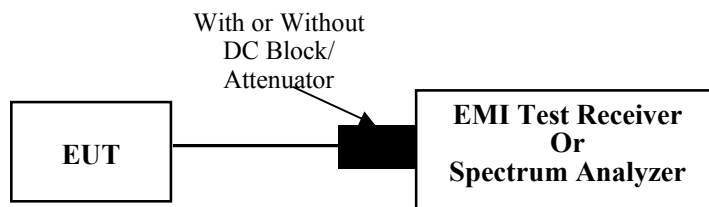

3.3.3 Test Procedure

According to ANSI C63.10-2013 Section 6.9.2

- a) The spectrum analyzer center frequency is set to the nominal EUT channel center frequency. The span range for the EMI receiver or spectrum analyzer shall be between two times and five times the OBW.
- b) The nominal IF filter bandwidth (3 dB RBW) shall be in the range of 1% to 5% of the OBW and video bandwidth (VBW) shall be approximately three times RBW, unless otherwise specified by the applicable requirement.
- c) Set the reference level of the instrument as required, keeping the signal from exceeding the maximum input mixer level for linear operation. In general, the peak of the spectral envelope shall be more than $[10 \log(\text{OBW}/\text{RBW})]$ below the reference level. Specific guidance is given in 4.1.5.2
- d) Steps a) through c) might require iteration to adjust within the specified tolerances.
- e) The dynamic range of the instrument at the selected RBW shall be more than 10 dB below the target “-xx dB down” requirement; that is, if the requirement calls for measuring the -20 dB OBW, the instrument noise floor at the selected RBW shall be at least 30 dB below the reference value.
- f) Set detection mode to peak and trace mode to max hold.
- g) Determine the reference value: Set the EUT to transmit an unmodulated carrier or modulated signal, as applicable. Allow the trace to stabilize. Set the spectrum analyzer marker to the highest level of the displayed trace (this is the reference value).
- h) Determine the “-xx dB down amplitude” using $[(\text{reference value}) - \text{xx}]$. Alternatively, this calculation may be made by using the marker-delta function of the instrument.
- i) If the reference value is determined by an unmodulated carrier, then turn the EUT modulation ON, and either clear the existing trace or start a new trace on the spectrum analyzer and allow the new trace to stabilize. Otherwise, the trace from step g) shall be used for step j).

- j) Place two markers, one at the lowest frequency and the other at the highest frequency of the envelope of the spectral display, such that each marker is at or slightly below the “-xx dB down amplitude” determined in step h). If a marker is below this “-xx dB down amplitude” value, then it shall be as close as possible to this value. The occupied bandwidth is the frequency difference between the two markers. Alternatively, set a marker at the lowest frequency of the envelope of the spectral display, such that the marker is at or slightly below the “-xx dB down amplitude” determined in step h). Reset the marker-delta function and move the marker to the other side of the emission until the delta marker amplitude is at the same level as the reference marker amplitude. The marker-delta frequency reading at this point is the specified emission bandwidth.
- k) The occupied bandwidth shall be reported by providing plot(s) of the measuring instrument display; the plot axes and the scale units per division shall be clearly labeled. Tabular data may be reported in addition to the plot(s).

3.4 Channel Separation

3.4.1 Applicable Standard

FCC §15.247 (a)(1)

Frequency hopping systems shall have hopping channel carrier frequencies separated by a minimum of 25 kHz or the 20 dB bandwidth of the hopping channel, whichever is greater. Alternatively, frequency hopping systems operating in the 2400-2483.5 MHz band may have hopping channel carrier frequencies that are separated by 25 kHz or two-thirds of the 20 dB bandwidth of the hopping channel, whichever is greater, provided the systems operate with an output power no greater than 125 mW. The system shall hop to channel frequencies that are selected at the system hopping rate from a pseudo randomly ordered list of hopping frequencies. Each frequency must be used equally on the average by each transmitter. The system receivers shall have input bandwidths that match the hopping channel bandwidths of their corresponding transmitters and shall shift frequencies in synchronization with the transmitted signals.

3.4.2 EUT Setup

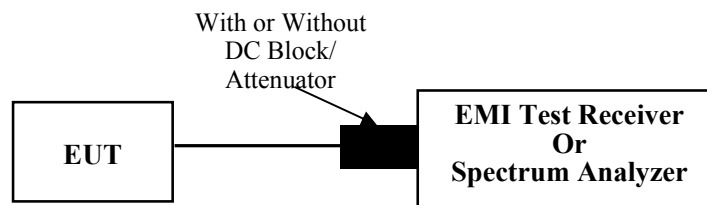

3.4.3 Test Procedure

According to ANSI C63.10-2013 Section 7.8.2

The EUT shall have its hopping function enabled. Use the following spectrum analyzer settings:

- a) Span: Wide enough to capture the peaks of two adjacent channels.
- b) RBW: Start with the RBW set to approximately 30% of the channel spacing; adjust as necessary to best identify the center of each individual channel.
- c) Video (or average) bandwidth (VBW) \geq RBW.
- d) Sweep: Auto.
- e) Detector function: Peak.
- f) Trace: Max hold.
- g) Allow the trace to stabilize.

Use the marker-delta function to determine the separation between the peaks of the adjacent channels. Compliance of an EUT with the appropriate regulatory limit shall be determined. A plot of the data shall be included in the test report.

3.5 Number of Hopping Frequency

3.5.1 Applicable Standard

FCC §15.247 (a)(1)(iii)

Frequency hopping systems in the 2400–2483.5 MHz band shall use at least 15 channels. The average time of occupancy on any channel shall not be greater than 0.4 seconds within a period of 0.4 seconds multiplied by the number of hopping channels employed. Frequency hopping systems may avoid or suppress transmissions on a particular hopping frequency provided that a minimum of 15 channels are used.

3.5.2 EUT Setup

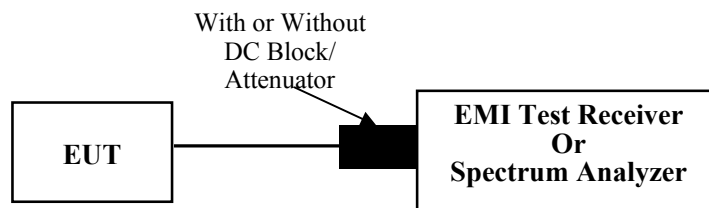

3.5.3 Test Procedure

According to ANSI C63.10-2013 Section 7.8.3

The EUT shall have its hopping function enabled. Use the following spectrum analyzer settings:

- a) Span: The frequency band of operation. Depending on the number of channels the device supports, it may be necessary to divide the frequency range of operation across multiple spans, to allow the individual channels to be clearly seen.
- b) RBW: To identify clearly the individual channels, set the RBW to less than 30% of the channel spacing or the 20 dB bandwidth, whichever is smaller.
- c) VBW \geq RBW.
- d) Sweep: Auto.
- e) Detector function: Peak.
- f) Trace: Max hold.
- g) Allow the trace to stabilize

It might prove necessary to break the span up into subranges to show clearly all of the hopping frequencies. Compliance of an EUT with the appropriate regulatory limit shall be determined for the number of hopping channels. A plot of the data shall be included in the test report.

3.6 Time of Occupancy (Dwell Time)

3.6.1 Applicable Standard

Frequency hopping systems in the 2400-2483.5 MHz shall use at least 15 channels. The average time of occupancy on any channel shall not be greater than 0.4 seconds within a period of 0.4 seconds multiplied by the number of hopping channels employed. Frequency hopping systems may avoid or suppress transmissions on a particular hopping frequency provided that a minimum of 15 channels are used.

3.6.2 EUT Setup

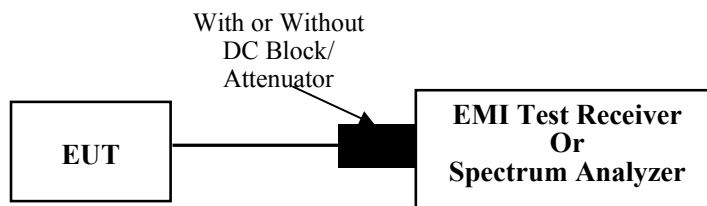

3.6.3 Test Procedure

According to ANSI C63.10-2013 Section 7.8.4

The EUT shall have its hopping function enabled. Use the following spectrum analyzer settings:

- Span: Zero span, centered on a hopping channel.
- RBW shall be \leq channel spacing and where possible RBW should be set $\gg 1 / T$, where T is the expected dwell time per channel.
- Sweep: As necessary to capture the entire dwell time per hopping channel; where possible use a video trigger and trigger delay so that the transmitted signal starts a little to the right of the start of the plot. The trigger level might need slight adjustment to prevent triggering when the system hops on an adjacent channel; a second plot might be needed with a longer sweep time to show two successive hops on a channel.
- Detector function: Peak.
- Trace: Max hold.

Use the marker-delta function to determine the transmit time per hop. If this value varies with different modes of operation (data rate, modulation format, number of hopping channels, etc.), then repeat this test for each variation in transmit time.

Repeat the measurement using a longer sweep time to determine the number of hops over the period specified in the requirements. The sweep time shall be equal to, or less than, the period specified in the requirements. Determine the number of hops over the sweep time and calculate the total number of hops in the period specified in the requirements, using the following equation:

$$(\text{Number of hops in the period specified in the requirements}) = (\text{number of hops on spectrum analyzer}) \times (\text{period specified in the requirements} / \text{analyzer sweep time})$$

The average time of occupancy is calculated from the transmit time per hop multiplied by the number of hops in the period specified in the requirements. If the number of hops in a specific time varies with different modes of operation (data rate, modulation format, number of hopping channels, etc.), then repeat this test for each variation.

The measured transmit time and time between hops shall be consistent with the values described in the operational description for the EUT.

3.7 Maximum Conducted Output Power

3.7.1 Applicable Standard

FCC §15.247 (b)(1)

For frequency hopping systems operating in the 2400–2483.5 MHz band employing at least 75 non-overlapping hopping channels, and all frequency hopping systems in the 5725-5850 MHz band: 1 watt. For all other frequency hopping systems in the 2400–2483.5 MHz band: 0.125 watts

3.7.2 EUT Setup

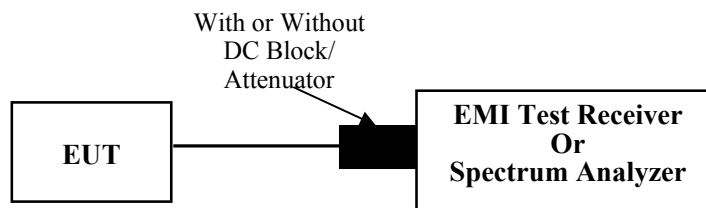

3.7.3 Test Procedure

According to ANSI C63.10-2013 Section 7.8.5

This is an RF-conducted test to evaluate maximum peak output power. Use a direct connection between the antenna port of the unlicensed wireless device and the spectrum analyzer, through suitable attenuation. Offset the Insertion loss of the RF cable, DC Block/ Attenuator into the spectrum analyzer. The hopping shall be disabled for this test:

- a) Use the following spectrum analyzer settings:
 - 1) Span: Approximately five times the 20 dB bandwidth, centered on a hopping channel.
 - 2) RBW > 20 dB bandwidth of the emission being measured.
 - 3) VBW \geq RBW.
 - 4) Sweep: Auto.
 - 5) Detector function: Peak.
 - 6) Trace: Max hold.
- b) Allow trace to stabilize.
- c) Use the marker-to-peak function to set the marker to the peak of the emission.
- d) The indicated level is the peak output power, after any corrections for external attenuators and cables.
- e) A plot of the test results and setup description shall be included in the test report.

NOTE—A peak responding power meter may be used, where the power meter and sensor system video bandwidth is greater than the occupied bandwidth of the unlicensed wireless device, rather than a spectrum analyzer.

3.8 100 kHz Bandwidth of Frequency Band Edge

3.8.1 Applicable Standard

FCC §15.247 (d);

In any 100 kHz bandwidth outside the frequency band in which the spread spectrum or digitally modulated intentional radiator is operating, the radio frequency power that is produced by the intentional radiator shall be at least 20 dB below that in the 100 kHz bandwidth within the band that contains the highest level of the desired power, based on either an RF conducted or a radiated measurement, provided the transmitter demonstrates compliance with the peak conducted power limits. If the transmitter complies with the conducted power limits based on the use of RMS averaging over a time interval, as permitted under paragraph (b)(3) of this section, the attenuation required under this paragraph shall be 30 dB instead of 20 dB. Attenuation below the general limits specified in §15.209(a) is not required. In addition, radiated emissions which fall in the restricted bands, as defined in §15.205(a), must also comply with the radiated emission limits specified in §15.209(a) (see §15.205(c)).

3.8.2 EUT Setup

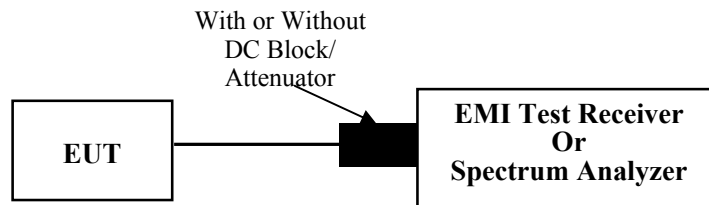

3.8.3 Test Procedure

According to ANSI C63.10-2013 Section 7.8.6

For band-edge measurements, use the band-edge procedure in 6.10. Band-edge measurements shall be tested both on single channels, and with the EUT hopping.

- a) Set the center frequency and span to encompass frequency range to be measured.
- b) Set the RBW = 100 kHz.
- c) Set the VBW $\geq [3 \times \text{RBW}]$.
- d) Detector = peak.
- e) Sweep time = auto couple.
- f) Trace mode = max hold.
- g) Allow trace to fully stabilize.
- h) Use the peak marker function to determine the maximum amplitude level.

Ensure that the amplitude of all unwanted emissions outside of the authorized frequency band (excluding restricted frequency bands) is attenuated by at least the minimum requirements. Report the three highest emissions relative to the limit.

3.9 Antenna Requirement

3.9.1 Applicable Standard

FCC §15.203

An intentional radiator shall be designed to ensure that no antenna other than that furnished by the responsible party shall be used with the device. The use of a permanently attached antenna or of an antenna that uses a unique coupling to the intentional radiator shall be considered sufficient to comply with the provisions of this section. The manufacturer may design the unit so that a broken antenna can be replaced by the user, but the use of a standard antenna jack or electrical connector is prohibited. This requirement does not apply to carrier current devices or to devices operated under the provisions of §§15.211, 15.213, 15.217, 15.219, 15.221, or §15.236. Further, this requirement does not apply to intentional radiators that must be professionally installed, such as perimeter protection systems and some field disturbance sensors, or to other intentional radiators which, in accordance with §15.31(d), must be measured at the installation site. However, the installer shall be responsible for ensuring that the proper antenna is employed so that the limits in this part are not exceeded.

3.9.2 Judgment

Compliant. Please refer to the Antenna Information detail in Section 1.

4. TEST DATA AND RESULTS

4.1 AC Line Conducted Emissions

Serial Number:	2DS2-2	Test Date:	2023/12/14
Test Site:	CE	Test Mode:	Transmitting(maximum output power mode, 8DPSK 2423 MHz)
Tester:	David Huang	Test Result:	Pass

Environmental Conditions:

Temperature: (°C)	27.7	Relative Humidity: (%)	49	ATM Pressure: (kPa)	101.4
----------------------	------	---------------------------	----	------------------------	-------

Test Equipment List and Details:

Manufacturer	Description	Model	Serial Number	Calibration Date	Calibration Due Date
R&S	LISN	ENV216	101134	2023/3/31	2024/3/30
R&S	EMI Test Receiver	ESR3	102726	2023/3/31	2024/3/30
MICRO-COAX	Coaxial Cable	UTIFLEX	C-0200-01	2023/8/6	2024/8/5
Audix	Test Software	E3	190306 (V9)	N/A	N/A

* Statement of Traceability: China Certification ICT Co., Ltd (Dongguan) attests that all calibrations have been performed, traceable to National Primary Standards and International System of Units (SI).

Adapter:

Project No.: CR231167748-RF
 Tester: David Huang
 Port: Line
 Note: Adapter BT

Date: 2023-12-14

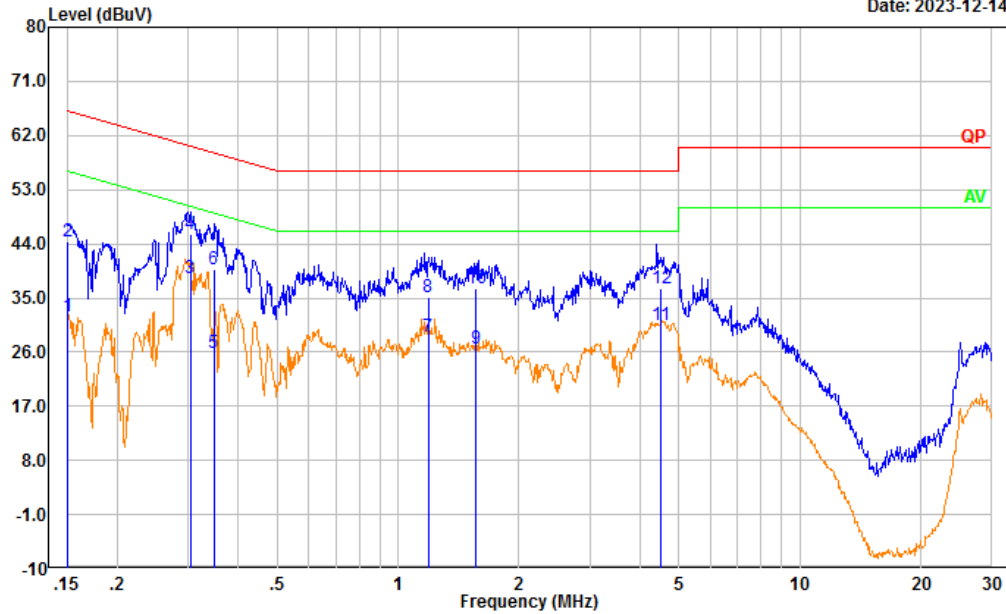

No.	Frequency (MHz)	Reading (dBuV)	Factor (dB)	Result (dBuV)	Limit (dBuV)	Margin (dB)	Detector
1	0.151	22.26	9.61	31.87	55.94	24.07	Average
2	0.151	34.85	9.61	44.46	65.94	21.48	QP
3	0.304	28.75	9.61	38.36	50.13	11.77	Average
4	0.304	36.09	9.61	45.70	60.13	14.43	QP
5	0.348	16.28	9.61	25.89	49.02	23.13	Average
6	0.348	30.27	9.61	39.88	59.02	19.14	QP
7	1.187	18.95	9.62	28.57	46.00	17.43	Average
8	1.187	25.41	9.62	35.03	56.00	20.97	QP
9	1.566	16.96	9.63	26.59	46.00	19.41	Average
10	1.566	26.97	9.63	36.60	56.00	19.40	QP
11	4.496	20.77	9.65	30.42	46.00	15.58	Average
12	4.496	26.89	9.65	36.54	56.00	19.46	QP

Project No.: CR231167748-RF
 Tester: David Huang
 Port: neutral
 Note: Adapter BT

Date: 2023-12-14

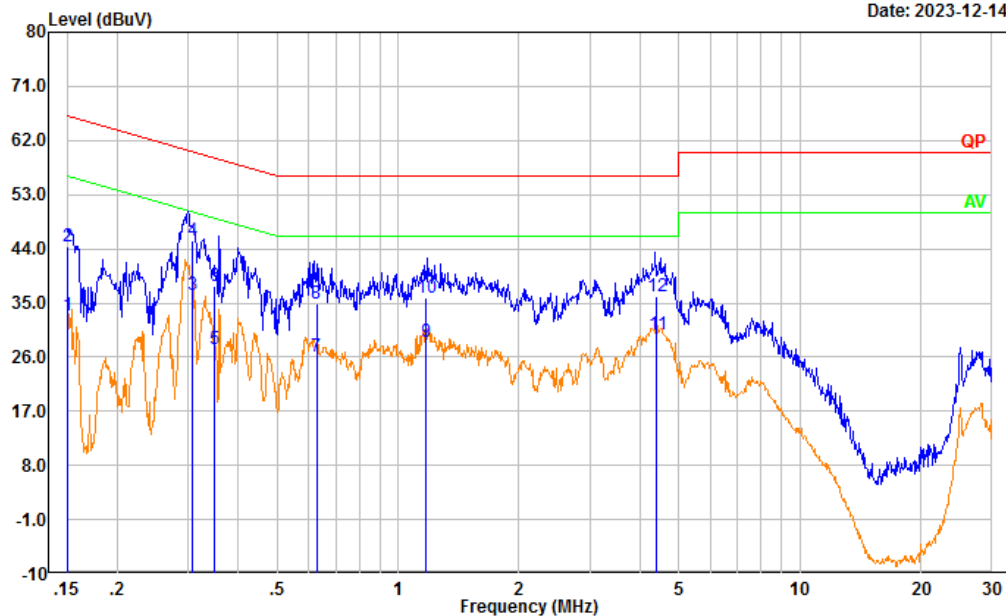

No.	Frequency (MHz)	Reading (dBμV)	Factor (dB)	Result (dBμV)	Limit (dBμV)	Margin (dB)	Detector
1	0.150	23.35	9.61	32.96	55.97	23.01	Average
2	0.150	34.76	9.61	44.37	65.97	21.60	QP
3	0.308	26.84	9.61	36.45	50.02	13.57	Average
4	0.308	35.82	9.61	45.43	60.02	14.59	QP
5	0.348	17.69	9.61	27.30	49.00	21.70	Average
6	0.348	28.18	9.61	37.79	59.00	21.21	QP
7	0.626	16.53	9.62	26.15	46.00	19.85	Average
8	0.626	25.30	9.62	34.92	56.00	21.08	QP
9	1.169	18.96	9.62	28.58	46.00	17.42	Average
10	1.169	26.19	9.62	35.81	56.00	20.19	QP
11	4.401	20.11	9.65	29.76	46.00	16.24	Average
12	4.401	26.54	9.65	36.19	56.00	19.81	QP

POE:

Project No.: CR231167748-RF
 Tester: David Huang
 Port: Line
 Note: POE BT

Date: 2023-12-14

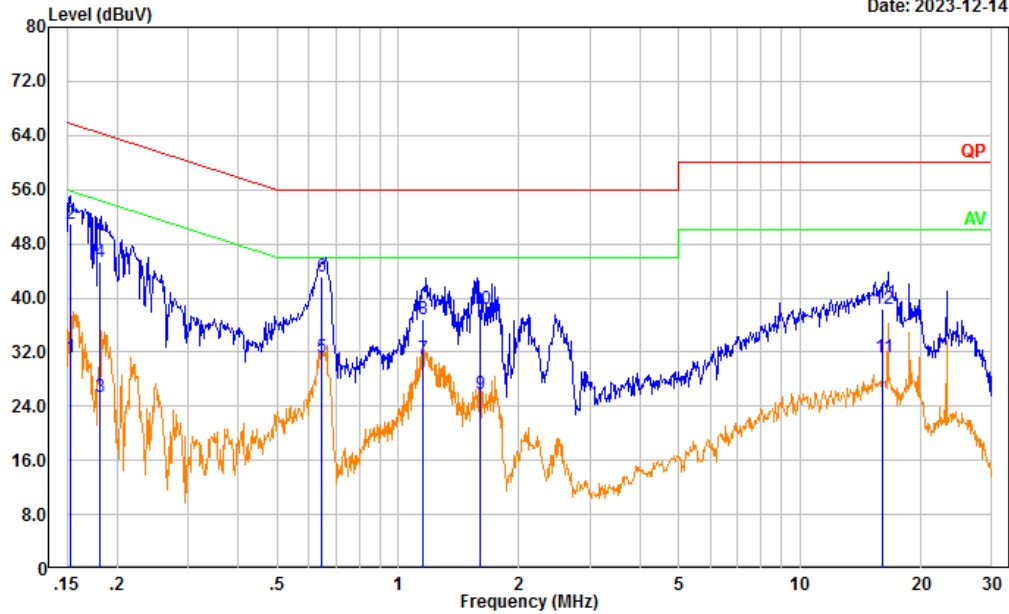

No.	Frequency (MHz)	Reading (dBμV)	Factor (dB)	Result (dBμV)	Limit (dBμV)	Margin (dB)	Detector
1	0.153	21.64	9.61	31.25	55.83	24.58	Average
2	0.153	41.32	9.61	50.93	65.83	14.90	QP
3	0.181	15.73	9.61	25.34	54.44	29.10	Average
4	0.181	35.61	9.61	45.22	64.44	19.22	QP
5	0.647	21.65	9.62	31.27	46.00	14.73	Average
6	0.647	33.45	9.62	43.07	56.00	12.93	QP
7	1.155	21.38	9.62	31.00	46.00	15.00	Average
8	1.155	27.30	9.62	36.92	56.00	19.08	QP
9	1.602	16.13	9.63	25.76	46.00	20.24	Average
10	1.602	28.66	9.63	38.29	56.00	17.71	QP
11	16.103	21.60	9.71	31.31	50.00	18.69	Average
12	16.103	28.70	9.71	38.41	60.00	21.59	QP

Project No.: CR231167748-RF
 Tester: David Huang
 Port: neutral
 Note: POE BT

Date: 2023-12-14

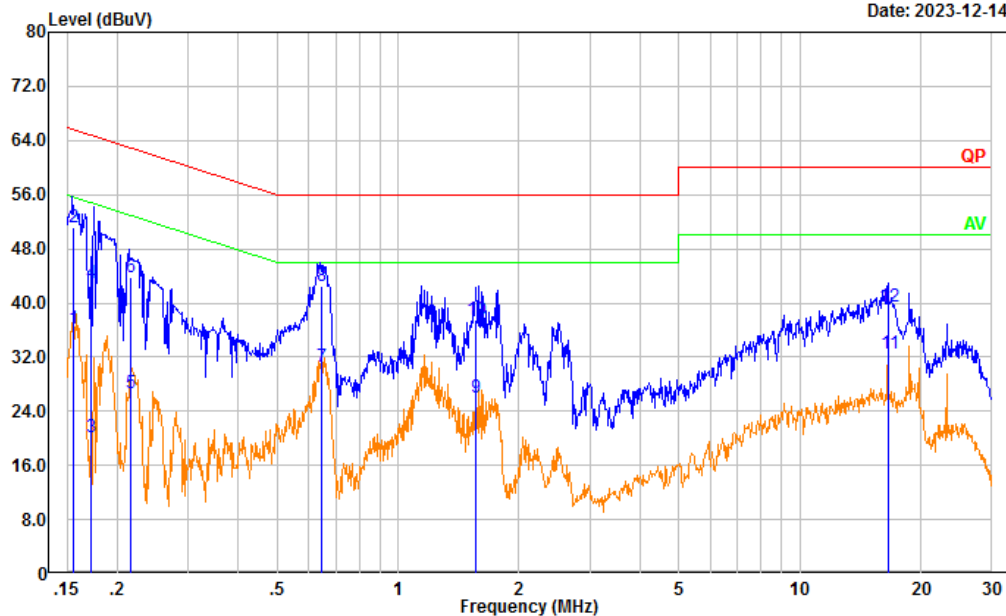

No.	Frequency (MHz)	Reading (dBμV)	Factor (dB)	Result (dBμV)	Limit (dBμV)	Margin (dB)	Detector
1	0.156	26.55	9.61	36.16	55.70	19.54	Average
2	0.156	41.49	9.61	51.10	65.70	14.60	QP
3	0.173	10.47	9.61	20.08	54.83	34.75	Average
4	0.173	33.37	9.61	42.98	64.83	21.85	QP
5	0.216	16.95	9.61	26.56	52.98	26.42	Average
6	0.216	34.25	9.61	43.86	62.98	19.12	QP
7	0.647	20.88	9.62	30.50	46.00	15.50	Average
8	0.647	32.93	9.62	42.55	56.00	13.45	QP
9	1.562	16.35	9.63	25.98	46.00	20.02	Average
10	1.562	27.78	9.63	37.41	56.00	18.59	QP
11	16.627	22.73	9.69	32.42	50.00	17.58	Average
12	16.627	29.75	9.69	39.44	60.00	20.56	QP

4.2 Radiated Spurious Emissions

Serial Number:	2DS2-2	Test Date:	2023/12/21~2024/1/4
Test Site:	966-2,966-1	Test Mode:	Transmitting
Tester:	Jeff Luo, Tao Zhu	Test Result:	Pass

Environmental Conditions:

Temperature: (°C)	24~25.7	Relative Humidity: (%)	35~59	ATM Pressure: (kPa)	101.5~102.1
----------------------	---------	---------------------------	-------	------------------------	-------------

Test Equipment List and Details:

Manufacturer	Description	Model	Serial Number	Calibration Date	Calibration Due Date
Radiation Spurious Emissions Below 1GHz					
Sunol Sciences	Antenna	JB6	A082520-6	2023/9/18	2026/9/17
BACL	Loop Antenna	1313-1P	3092721	2023/10/20	2026/10/19
R&S	EMI Test Receiver	ESR3	102724	2023/3/31	2024/3/30
TIMES MICROWAVE	Coaxial Cable	LMR-600-UltraFlex	C-0470-02	2023/7/16	2024/7/15
TIMES MICROWAVE	Coaxial Cable	LMR-600-UltraFlex	C-0780-01	2023/7/16	2024/7/15
Sonoma	Amplifier	310N	186165	2023/7/16	2024/7/15
Audix	Test Software	E3	201021 (V9)	N/A	N/A
Radiation Spurious Emissions Above 1GHz					
AH	Double Ridge Guide Horn Antenna	SAS-571	1394	2023/2/22	2026/2/21
R&S	Spectrum Analyzer	FSV40	101591	2023/3/31	2024/3/30
MICRO-COAX	Coaxial Cable	UFA210A-1-1200-70U300	217423-008	2023/8/6	2024/8/5
MICRO-COAX	Coaxial Cable	UFA210A-1-2362-300300	235780-001	2023/8/6	2024/8/5
Mini	Pre-amplifier	ZVA-183-S+	5969001149	2023/11/8	2024/11/7
Audix	Test Software	E3	201021 (V9)	N/A	N/A
PASTERNAK	Horn Antenna	PE9852/2F-20	112002	2021/2/5	2024/2/4
Quinstar	Preamplifier	QLW-18405536-JO	15964001005	2023/9/15	2024/9/14
MICRO-COAX	Coaxial Cable	UFB142A-1-2362-200200	235772-001	2023/8/6	2024/8/5
E-Microwave	Band Rejection Filter	2400-2483.5MHz	OE01902424	2023/8/6	2024/8/5
Mini Circuits	High Pass Filter	VHF-6010+	31119	2023/8/6	2024/8/5

* Statement of Traceability: China Certification ICT Co., Ltd (Dongguan) attests that all calibrations have been performed, traceable to National Primary Standards and International System of Units (SI).

Test Data:

Please refer to the below table and plots.

After pre-scan in the X, Y and Z axes of orientation, the worst case is below:

1) 9kHz~30MHz

The amplitude of spurious emissions attenuated more than 20 dB below the permissible value is not required to be report.

2) 30MHz-1GHz (Tested at maximum output power mode 8DPSK Mode)

Adapter:

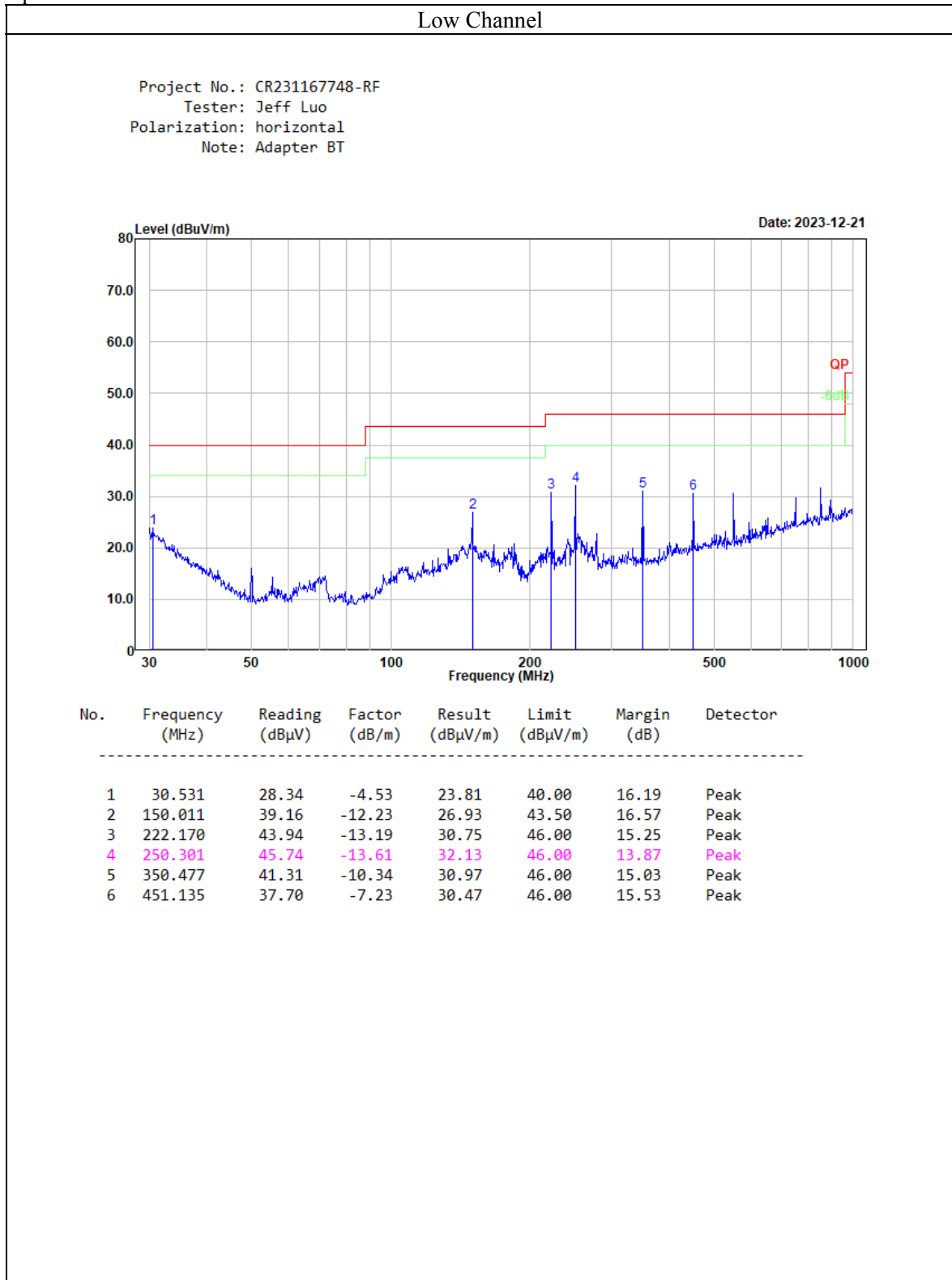

Project No.: CR231167748-RF
 Tester: Jeff Luo
 Polarization: vertical
 Note: Adapter BT

Date: 2023-12-21

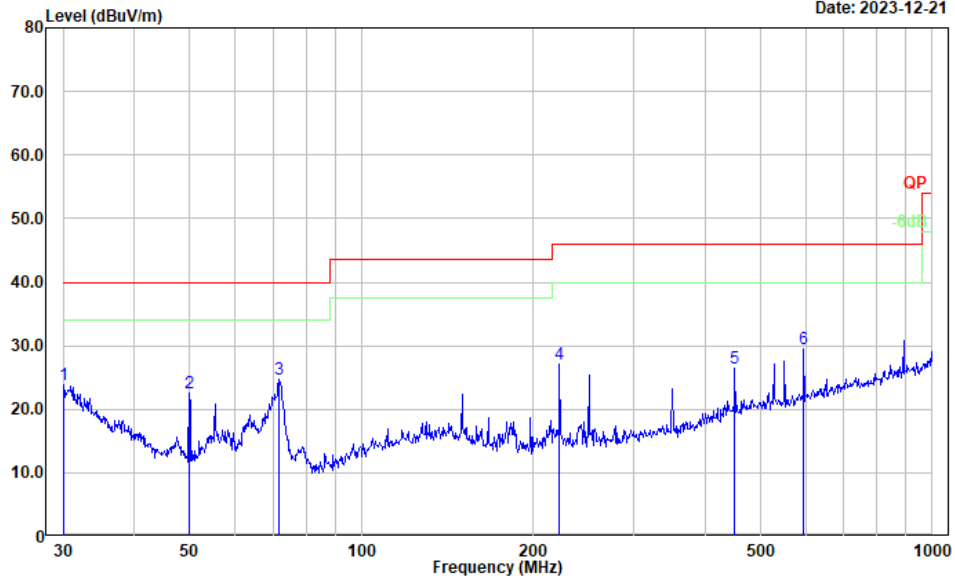

No.	Frequency (MHz)	Reading (dBμV)	Factor (dB/m)	Result (dBμV/m)	Limit (dBμV/m)	Margin (dB)	Detector
1	30.000	27.99	-4.12	23.87	40.00	16.13	Peak
2	49.881	39.77	-17.31	22.46	40.00	17.54	Peak
3	71.832	41.73	-17.10	24.63	40.00	15.37	Peak
4	222.170	40.21	-13.19	27.02	46.00	18.98	Peak
5	451.135	33.65	-7.23	26.42	46.00	19.58	Peak
6	595.133	35.06	-5.57	29.49	46.00	16.51	Peak

Middle Channel

Project No.: CR231167748-RF
 Tester: Jeff Luo
 Polarization: horizontal
 Note: Adapter BT

Date: 2023-12-21

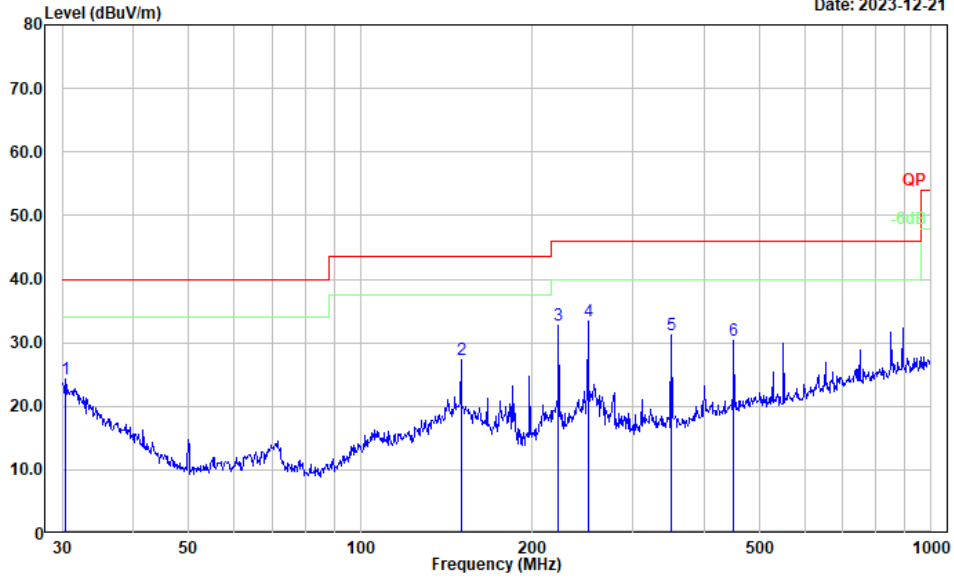

No.	Frequency (MHz)	Reading (dBμV)	Factor (dB/m)	Result (dBμV/m)	Limit (dBμV/m)	Margin (dB)	Detector
1	30.424	28.68	-4.45	24.23	40.00	15.77	Peak
2	150.011	39.46	-12.23	27.23	43.50	16.27	Peak
3	222.170	45.98	-13.19	32.79	46.00	13.21	Peak
4	250.301	46.95	-13.61	33.34	46.00	12.66	Peak
5	350.477	41.63	-10.34	31.29	46.00	14.71	Peak
6	451.135	37.60	-7.23	30.37	46.00	15.63	Peak

Project No.: CR231167748-RF
 Tester: Jeff Luo
 Polarization: vertical
 Note: Adapter BT

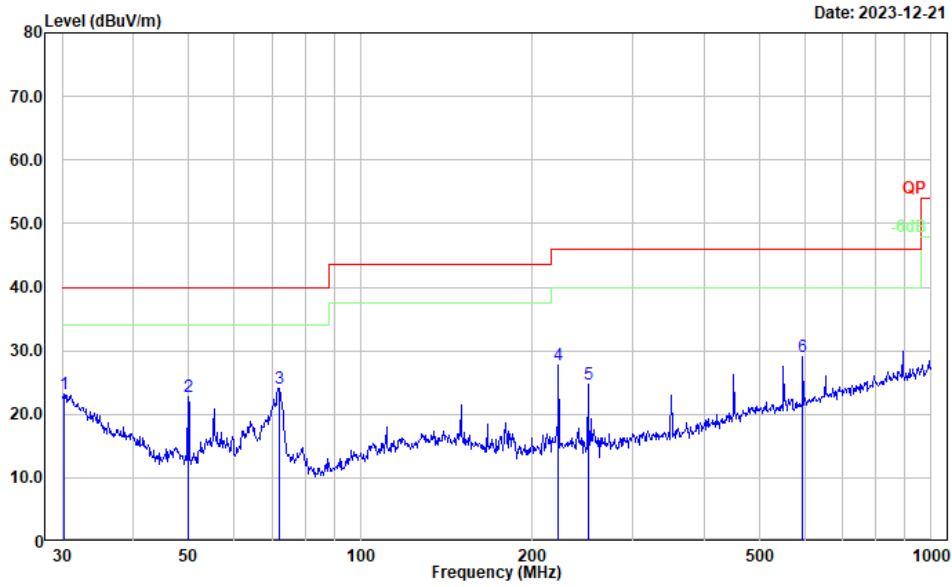

No.	Frequency (MHz)	Reading (dBμV)	Factor (dB/m)	Result (dBμV/m)	Limit (dBμV/m)	Margin (dB)	Detector
1	30.211	27.42	-4.28	23.14	40.00	16.86	Peak
2	49.881	40.02	-17.31	22.71	40.00	17.29	Peak
3	72.084	41.13	-17.13	24.00	40.00	16.00	Peak
4	222.170	41.05	-13.19	27.86	46.00	18.14	Peak
5	250.301	38.28	-13.61	24.67	46.00	21.33	Peak
6	595.133	34.65	-5.57	29.08	46.00	16.92	Peak

High Channel

Project No.: CR231167748-RF
 Tester: Jeff Luo
 Polarization: horizontal
 Note: Adapter BT

Date: 2023-12-21

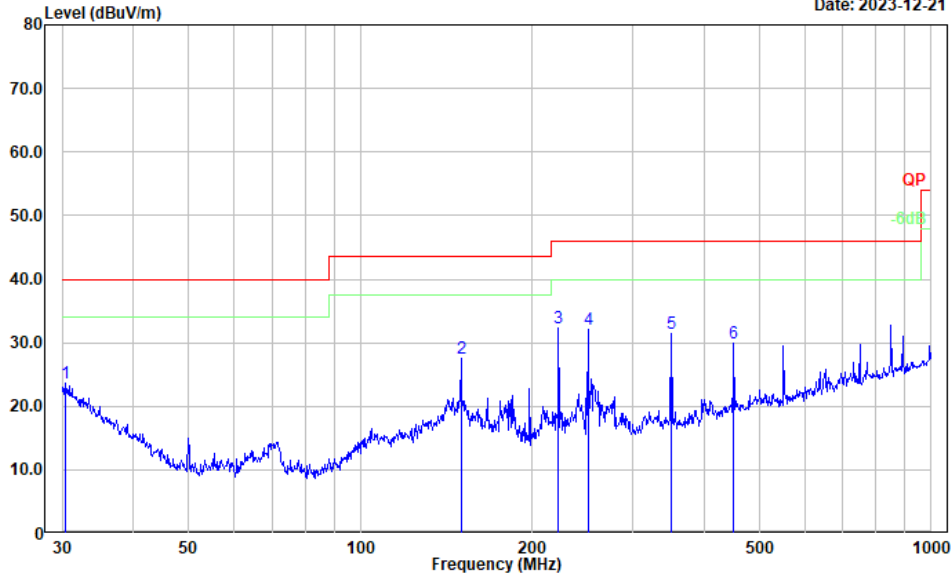

No.	Frequency (MHz)	Reading (dBμV)	Factor (dB/m)	Result (dBμV/m)	Limit (dBμV/m)	Margin (dB)	Detector
1	30.424	28.15	-4.45	23.70	40.00	16.30	Peak
2	150.011	39.80	-12.23	27.57	43.50	15.93	Peak
3	222.170	45.47	-13.19	32.28	46.00	13.72	Peak
4	250.301	45.79	-13.61	32.18	46.00	13.82	Peak
5	350.477	41.73	-10.34	31.39	46.00	14.61	Peak
6	451.135	37.26	-7.23	30.03	46.00	15.97	Peak

Project No.: CR231167748-RF
 Tester: Jeff Luo
 Polarization: vertical
 Note: Adapter BT

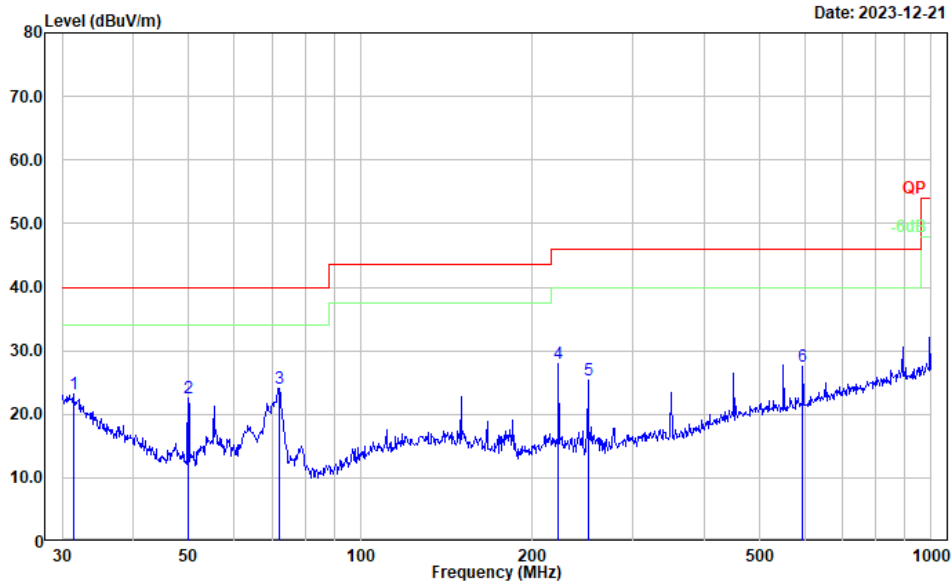

No.	Frequency (MHz)	Reading (dB μ V)	Factor (dB/m)	Result (dB μ V/m)	Limit (dB μ V/m)	Margin (dB)	Detector
1	31.399	28.43	-5.19	23.24	40.00	16.76	Peak
2	49.881	39.90	-17.31	22.59	40.00	17.41	Peak
3	72.084	41.23	-17.13	24.10	40.00	15.90	Peak
4	222.170	41.25	-13.19	28.06	46.00	17.94	Peak
5	250.301	38.88	-13.61	25.27	46.00	20.73	Peak
6	595.133	33.05	-5.57	27.48	46.00	18.52	Peak

POE:

Low Channel

Project No.: CR231167748-RF
 Tester: Jeff Luo
 Polarization: horizontal
 Note: POE BT

Date: 2023-12-21

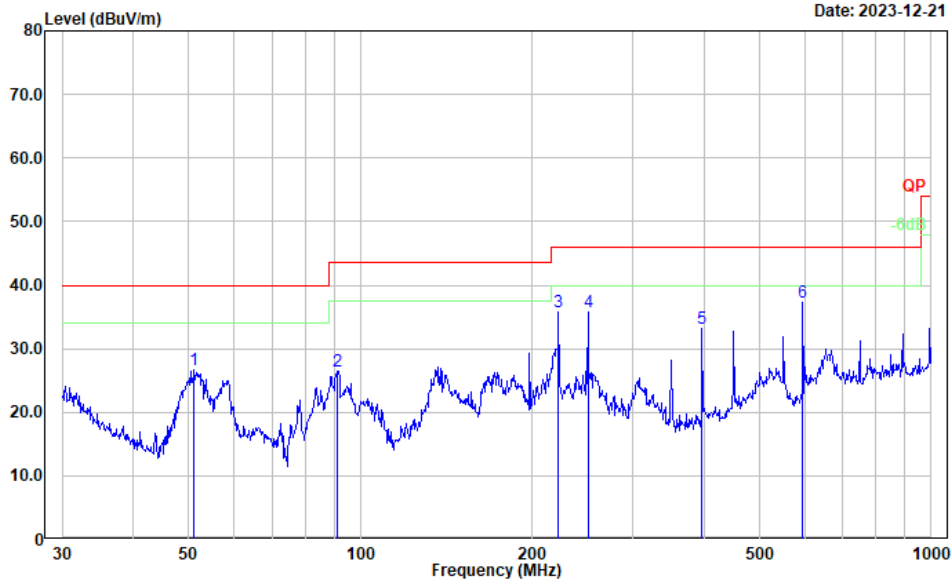

No.	Frequency (MHz)	Reading (dBμV)	Factor (dB/m)	Result (dBμV/m)	Limit (dBμV/m)	Margin (dB)	Detector
1	51.121	44.11	-17.44	26.67	40.00	13.33	Peak
2	91.175	43.34	-16.94	26.40	43.50	17.10	Peak
3	222.170	49.02	-13.19	35.83	46.00	10.17	Peak
4	250.301	49.30	-13.61	35.69	46.00	10.31	Peak
5	396.242	42.43	-9.20	33.23	46.00	12.77	Peak
6	595.133	42.85	-5.57	37.28	46.00	8.72	Peak

Project No.: CR231167748-RF
 Tester: Jeff Luo
 Polarization: vertical
 Note: POE BT

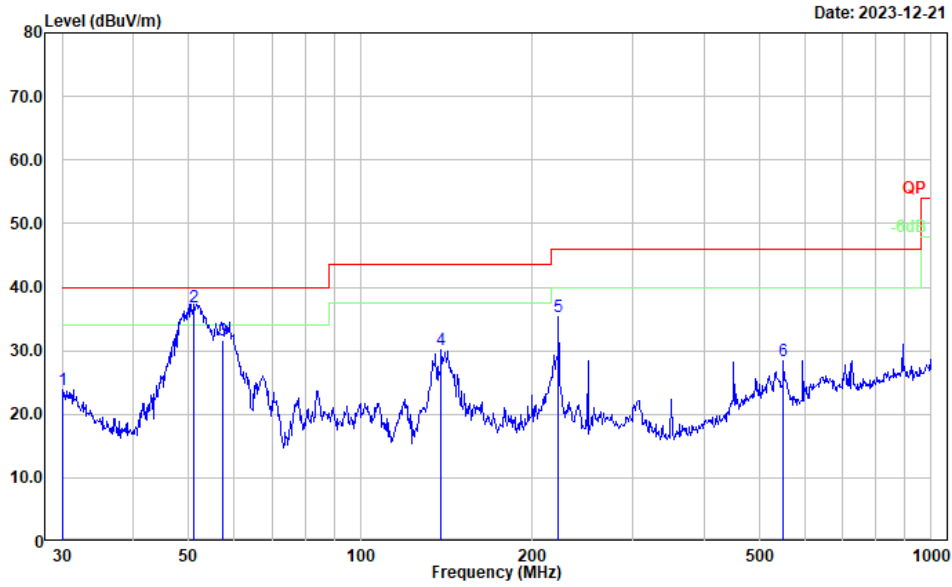

No.	Frequency (MHz)	Reading (dB μ V)	Factor (dB/m)	Result (dB μ V/m)	Limit (dB μ V/m)	Margin (dB)	Detector
1	30.000	28.00	-4.12	23.88	40.00	16.12	Peak
2	50.929	54.37	-17.44	36.93	40.00	3.07	QP
3	57.294	49.31	-17.56	31.75	40.00	8.25	QP
4	138.387	42.25	-12.02	30.23	43.50	13.27	Peak
5	222.170	48.43	-13.19	35.24	46.00	10.76	Peak
6	550.948	34.56	-6.17	28.39	46.00	17.61	Peak

Middle Channel

Project No.: CR231167748-RF
 Tester: Jeff Luo
 Polarization: horizontal
 Note: POE BT

Date: 2023-12-21

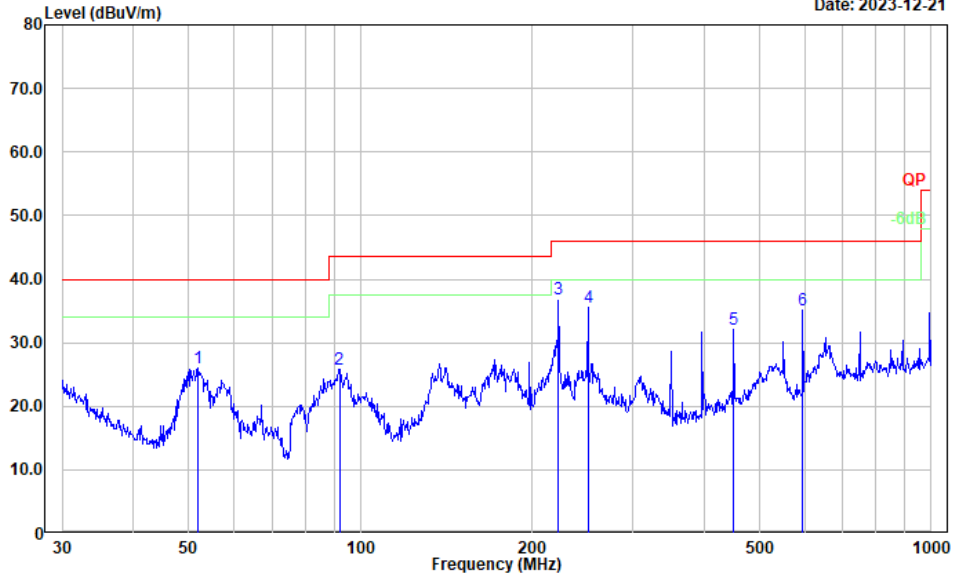

No.	Frequency (MHz)	Reading (dBμV)	Factor (dB/m)	Result (dBμV/m)	Limit (dBμV/m)	Margin (dB)	Detector
1	52.025	43.38	-17.44	25.94	40.00	14.06	Peak
2	91.816	42.65	-16.79	25.86	43.50	17.64	Peak
3	222.170	49.94	-13.19	36.75	46.00	9.25	Peak
4	250.301	49.21	-13.61	35.60	46.00	10.40	Peak
5	451.135	39.37	-7.23	32.14	46.00	13.86	Peak
6	595.133	40.80	-5.57	35.23	46.00	10.77	Peak

Project No.: CR231167748-RF
 Tester: Jeff Luo
 Polarization: vertical
 Note: POE BT

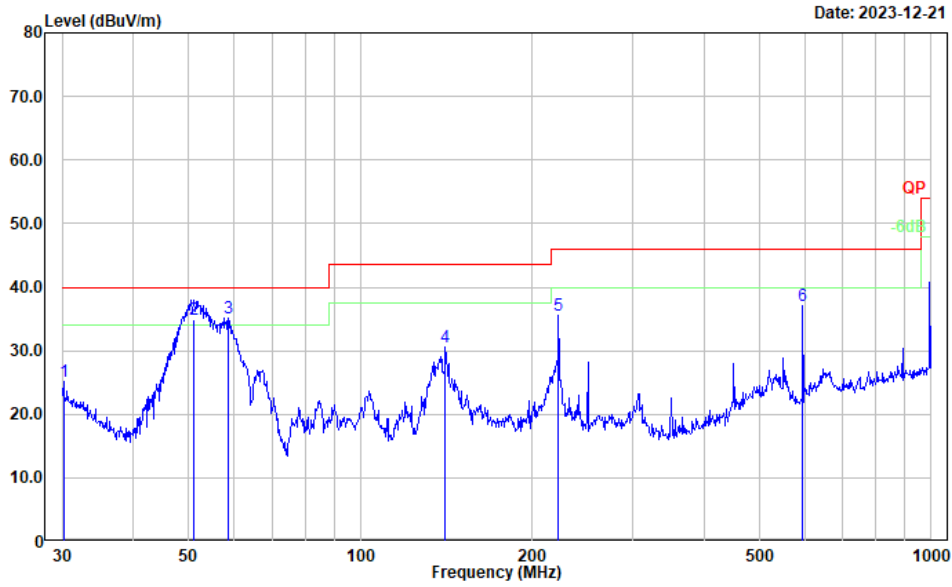

No.	Frequency (MHz)	Reading (dB μ V)	Factor (dB/m)	Result (dB μ V/m)	Limit (dB μ V/m)	Margin (dB)	Detector
1	30.211	29.39	-4.28	25.11	40.00	14.89	Peak
2	50.952	52.24	-17.44	34.80	40.00	5.20	QP
3	58.613	52.79	-17.61	35.18	40.00	4.82	Peak
4	140.835	42.75	-12.12	30.63	43.50	12.87	Peak
5	222.170	48.65	-13.19	35.46	46.00	10.54	Peak
6	595.133	42.61	-5.57	37.04	46.00	8.96	Peak

High Channel

Project No.: CR231167748-RF
 Tester: Jeff Luo
 Polarization: horizontal
 Note: POE BT

Date: 2023-12-21

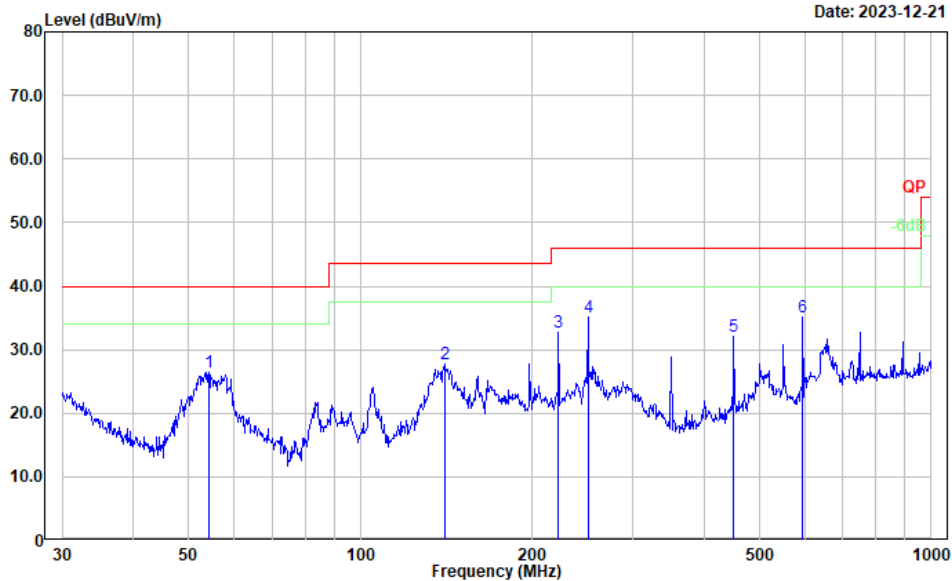

No.	Frequency (MHz)	Reading (dBμV)	Factor (dB/m)	Result (dBμV/m)	Limit (dBμV/m)	Margin (dB)	Detector
1	54.261	44.05	-17.50	26.55	40.00	13.45	Peak
2	140.342	39.82	-12.08	27.74	43.50	15.76	Peak
3	222.170	45.87	-13.19	32.68	46.00	13.32	Peak
4	250.301	48.73	-13.61	35.12	46.00	10.88	Peak
5	451.135	39.42	-7.23	32.19	46.00	13.81	Peak
6	595.133	40.60	-5.57	35.03	46.00	10.97	Peak

Project No.: CR231167748-RF
 Tester: Jeff Luo
 Polarization: vertical
 Note: POE BT

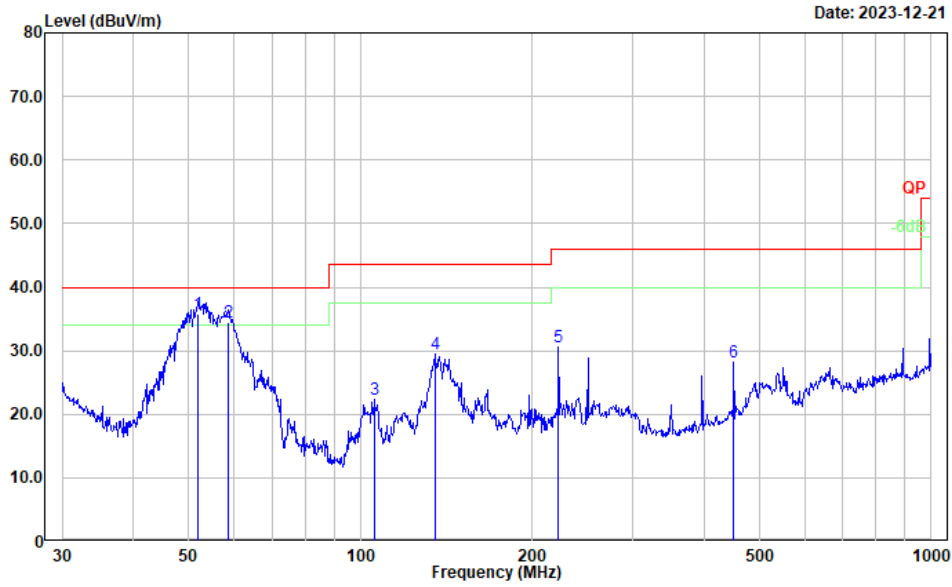

No.	Frequency (MHz)	Reading (dB μ V)	Factor (dB/m)	Result (dB μ V/m)	Limit (dB μ V/m)	Margin (dB)	Detector
1	52.025	53.15	-17.44	35.71	40.00	4.29	QP
2	58.613	52.09	-17.61	34.48	40.00	5.52	QP
3	105.642	35.90	-13.54	22.36	43.50	21.14	Peak
4	135.032	41.29	-11.83	29.46	43.50	14.04	Peak
5	222.170	43.75	-13.19	30.56	46.00	15.44	Peak
6	451.135	35.44	-7.23	28.21	46.00	17.79	Peak

3) 1-25GHz(POE mode was the worst):**BDR Mode(GFSK):**

Frequency (MHz)	Receiver		Polar (H/V)	Factor (dB/m)	Result (dB μ V/m)	Limit (dB μ V/m)	Margin (dB)
	Reading (dB μ V)	Detector					
Low Channel: 2402 MHz							
2390.000	26.71	PK	H	31.71	58.42	74.00	15.58
2390.000	13.68	AV	H	31.71	45.39	54.00	8.61
2390.000	26.76	PK	V	31.71	58.47	74.00	15.53
2390.000	13.70	AV	V	31.71	45.41	54.00	8.59
4804.000	33.68	PK	H	11.19	44.87	74.00	29.13
4804.000	20.65	AV	H	11.19	31.84	54.00	22.16
4804.000	33.78	PK	V	11.19	44.97	74.00	29.03
4804.000	20.74	AV	V	11.19	31.93	54.00	22.07
7206.000	33.68	PK	H	15.03	48.71	74.00	25.29
7206.000	20.74	AV	H	15.03	35.77	54.00	18.23
7206.000	33.86	PK	V	15.03	48.89	74.00	25.11
7206.000	20.76	AV	V	15.03	35.79	54.00	18.21
Middle Channel: 2441 MHz							
4882.000	33.82	PK	H	11.48	45.30	74.00	28.70
4882.000	20.71	AV	H	11.48	32.19	54.00	21.81
4882.000	33.89	PK	V	11.48	45.37	74.00	28.63
4882.000	20.78	AV	V	11.48	32.26	54.00	21.74
7323.000	33.71	PK	H	15.57	49.28	74.00	24.72
7323.000	20.62	AV	H	15.57	36.19	54.00	17.81
7323.000	33.83	PK	V	15.57	49.40	74.00	24.60
7323.000	20.87	AV	V	15.57	36.44	54.00	17.56
High Channel: 2480 MHz							
2483.500	26.82	PK	H	32.19	59.01	74.00	14.99
2483.500	13.77	AV	H	32.19	45.96	54.00	8.04
2483.500	26.86	PK	V	32.19	59.05	74.00	14.95
2483.500	13.79	AV	V	32.19	45.98	54.00	8.02
4960.000	33.56	PK	H	11.77	45.33	74.00	28.67
4960.000	20.58	AV	H	11.77	32.35	54.00	21.65
4960.000	33.84	PK	V	11.77	45.61	74.00	28.39
4960.000	20.74	AV	V	11.77	32.51	54.00	21.49
7440.000	33.70	PK	H	15.98	49.68	74.00	24.32
7440.000	20.66	AV	H	15.98	36.64	54.00	17.36
7440.000	33.72	PK	V	15.98	49.70	74.00	24.30
7440.000	20.89	AV	V	15.98	36.87	54.00	17.13

2EDR Mode ($\pi/4$ -DQPSK):

Frequency (MHz)	Receiver		Polar (H/V)	Factor (dB/m)	Result (dB μ V/m)	Limit (dB μ V/m)	Margin (dB)
	Reading (dB μ V)	Detector					
Low Channel: 2402 MHz							
2390.000	26.66	PK	H	31.71	58.37	74.00	15.63
2390.000	13.68	AV	H	31.71	45.39	54.00	8.61
2390.000	26.78	PK	V	31.71	58.49	74.00	15.51
2390.000	13.80	AV	V	31.71	45.51	54.00	8.49
4804.000	33.69	PK	H	11.19	44.88	74.00	29.12
4804.000	20.82	AV	H	11.19	32.01	54.00	21.99
4804.000	33.87	PK	V	11.19	45.06	74.00	28.94
4804.000	20.88	AV	V	11.19	32.07	54.00	21.93
7206.000	33.70	PK	H	15.03	48.73	74.00	25.27
7206.000	20.76	AV	H	15.03	35.79	54.00	18.21
7206.000	33.76	PK	V	15.03	48.79	74.00	25.21
7206.000	20.81	AV	V	15.03	35.84	54.00	18.16
Middle Channel: 2441 MHz							
4882.000	33.71	PK	H	11.48	45.19	74.00	28.81
4882.000	20.74	AV	H	11.48	32.22	54.00	21.78
4882.000	33.80	PK	V	11.48	45.28	74.00	28.72
4882.000	20.76	AV	V	11.48	32.24	54.00	21.76
7323.000	33.69	PK	H	15.57	49.26	74.00	24.74
7323.000	20.72	AV	H	15.57	36.29	54.00	17.71
7323.000	33.82	PK	V	15.57	49.39	74.00	24.61
7323.000	20.79	AV	V	15.57	36.36	54.00	17.64
High Channel: 2480 MHz							
2483.500	26.69	PK	H	32.19	58.88	74.00	15.12
2483.500	13.71	AV	H	32.19	45.90	54.00	8.10
2483.500	26.87	PK	V	32.19	59.06	74.00	14.94
2483.500	13.88	AV	V	32.19	46.07	54.00	7.93
4960.000	33.67	PK	H	11.77	45.44	74.00	28.56
4960.000	20.80	AV	H	11.77	32.57	54.00	21.43
4960.000	33.74	PK	V	11.77	45.51	74.00	28.49
4960.000	20.83	AV	V	11.77	32.60	54.00	21.40
7440.000	33.65	PK	H	15.98	49.63	74.00	24.37
7440.000	20.79	AV	H	15.98	36.77	54.00	17.23
7440.000	33.68	PK	V	15.98	49.66	74.00	24.34
7440.000	20.80	AV	V	15.98	36.78	54.00	17.22

3EDR Mode (8DPSK):

Frequency (MHz)	Receiver		Polar (H/V)	Factor (dB/m)	Result (dB μ V/m)	Limit (dB μ V/m)	Margin (dB)
	Reading (dB μ V)	Detector					
Low Channel: 2402 MHz							
2390.000	26.90	PK	H	31.71	58.61	74.00	15.39
2390.000	13.79	AV	H	31.71	45.50	54.00	8.50
2390.000	27.08	PK	V	31.71	58.79	74.00	15.21
2390.000	13.87	AV	V	31.71	45.58	54.00	8.42
4804.000	33.82	PK	H	11.19	45.01	74.00	28.99
4804.000	20.68	AV	H	11.19	31.87	54.00	22.13
4804.000	34.20	PK	V	11.19	45.39	74.00	28.61
4804.000	20.90	AV	V	11.19	32.09	54.00	21.91
7206.000	33.88	PK	H	15.03	48.91	74.00	25.09
7206.000	20.73	AV	H	15.03	35.76	54.00	18.24
7206.000	33.90	PK	V	15.03	48.93	74.00	25.07
7206.000	20.76	AV	V	15.03	35.79	54.00	18.21
Middle Channel: 2441 MHz							
4882.000	33.66	PK	H	11.48	45.14	74.00	28.86
4882.000	20.70	AV	H	11.48	32.18	54.00	21.82
4882.000	33.82	PK	V	11.48	45.30	74.00	28.70
4882.000	20.88	AV	V	11.48	32.36	54.00	21.64
7323.000	33.69	PK	H	15.57	49.26	74.00	24.74
7323.000	20.55	AV	H	15.57	36.12	54.00	17.88
7323.000	33.76	PK	V	15.57	49.33	74.00	24.67
7323.000	20.58	AV	V	15.57	36.15	54.00	17.85
High Channel: 2480 MHz							
2483.500	26.92	PK	H	32.19	59.11	74.00	14.89
2483.500	13.76	AV	H	32.19	45.95	54.00	8.05
2483.500	27.11	PK	V	32.19	59.30	74.00	14.70
2483.500	13.92	AV	V	32.19	46.11	54.00	7.89
4960.000	33.85	PK	H	11.77	45.62	74.00	28.38
4960.000	20.71	AV	H	11.77	32.48	54.00	21.52
4960.000	33.88	PK	V	11.77	45.65	74.00	28.35
4960.000	20.78	AV	V	11.77	32.55	54.00	21.45
7440.000	33.71	PK	H	15.98	49.69	74.00	24.31
7440.000	20.70	AV	H	15.98	36.68	54.00	17.32
7440.000	33.79	PK	V	15.98	49.77	74.00	24.23
7440.000	20.75	AV	V	15.98	36.73	54.00	17.27

Worst Radiation Spurious Emissions Margin Test plots(BDR High channel)

Horizontal

Project No.: CR231167748-RF
 Tester: Tao Zhu
 Polarization: horizontal
 Note:

Date: 2024-01-04

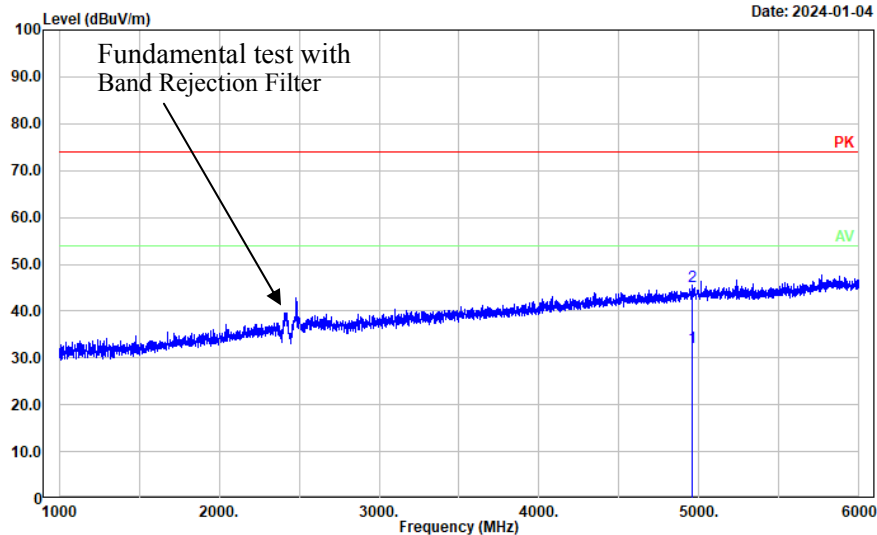

1-6GHz

No.	Frequency (MHz)	Reading (dBμV)	Factor (dB/m)	Result (dBμV/m)	Limit (dBμV/m)	Margin (dB)	Detector
1	4960.000	20.58	11.77	32.35	54.00	21.65	Average
2	4960.000	33.56	11.77	45.33	74.00	28.67	Peak

Horizontal

Project No.: CR231167748-RF
 Tester: Tao Zhu
 Polarization: horizontal
 Note:

Date: 2024-01-04

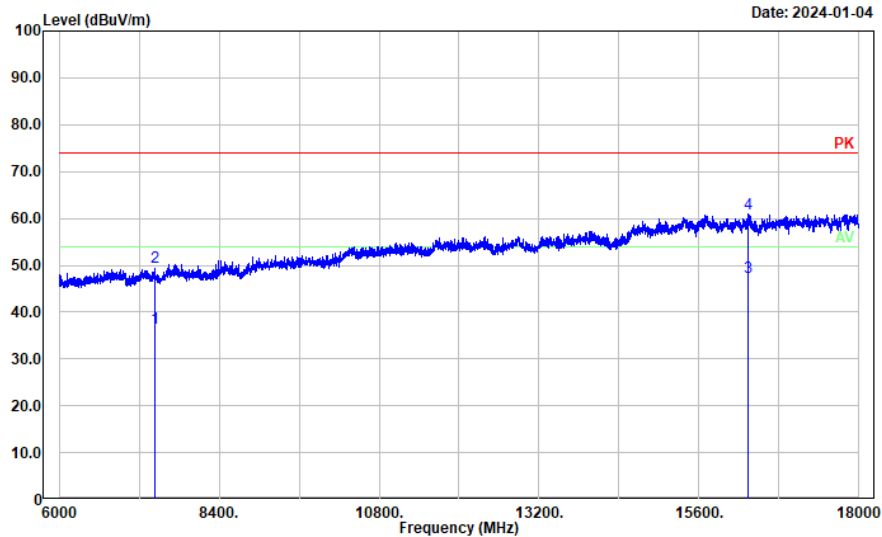

6-18GHz

No.	Frequency (MHz)	Reading (dBμV)	Factor (dB/m)	Result (dBμV/m)	Limit (dBμV/m)	Margin (dB)	Detector
1	7440.000	20.66	15.98	36.64	54.00	17.36	Average
2	7440.000	33.70	15.98	49.68	74.00	24.32	Peak
3	16339.200	21.68	25.68	47.36	54.00	6.64	Average
4	16339.200	35.24	25.68	60.92	74.00	13.08	Peak

Horizontal

Project No.: CR231167748-RF
 Tester: Tao Zhu
 Polarization: Horizontal
 Note:

Date: 2024-01-04

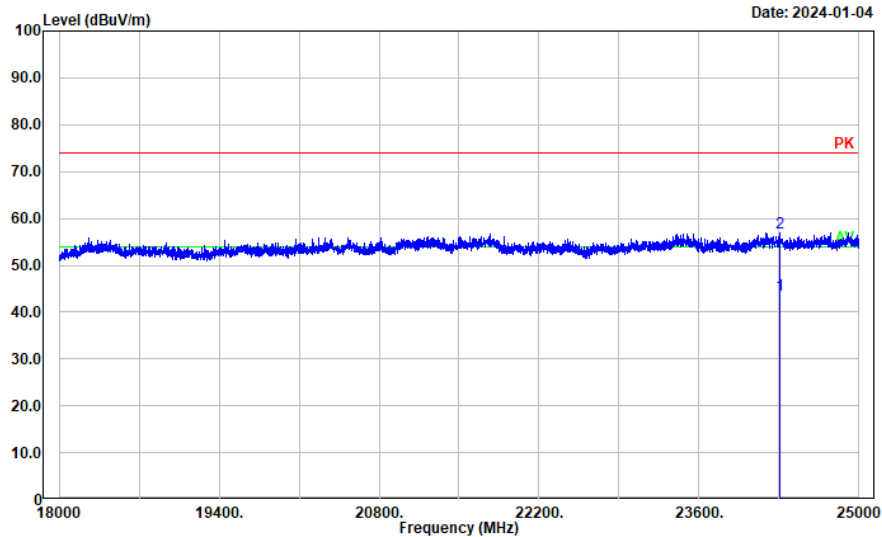

18-25GHz

No.	Frequency (MHz)	Reading (dBμV)	Factor (dB/m)	Result (dBμV/m)	Limit (dBμV/m)	Margin (dB)	Detector
1	24305.600	38.44	5.10	43.54	54.00	10.46	Average
2	24305.600	51.87	5.10	56.97	74.00	17.03	Peak

Vertical

Project No.: CR231167748-RF
 Tester: Tao Zhu
 Polarization: vertical
 Note:

Date: 2024-01-04

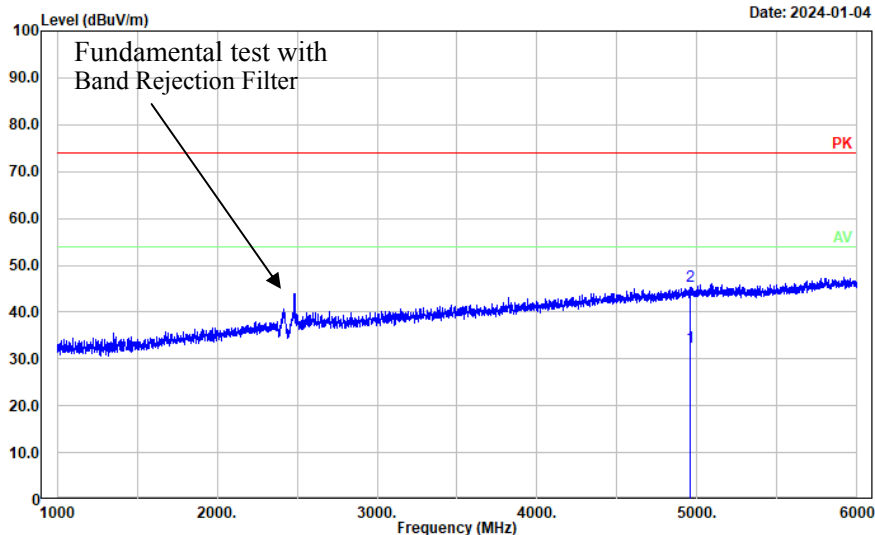

1-6GHz

No.	Frequency (MHz)	Reading (dBμV)	Factor (dB/m)	Result (dBμV/m)	Limit (dBμV/m)	Margin (dB)	Detector
1	4960.000	20.74	11.77	32.51	54.00	21.49	Average
2	4960.000	33.84	11.77	45.61	74.00	28.39	Peak

Vertical

Project No.: CR231167748-RF
 Tester: Tao Zhu
 Polarization: vertical
 Note:

Date: 2024-01-04

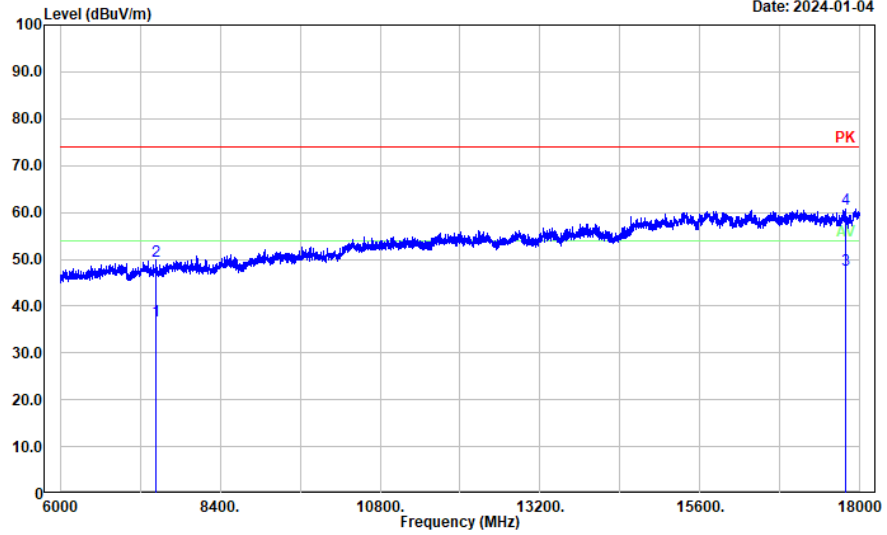

6-18GHz

No.	Frequency (MHz)	Reading (dBμV)	Factor (dB/m)	Result (dBμV/m)	Limit (dBμV/m)	Margin (dB)	Detector
1	7440.000	20.89	15.98	36.87	54.00	17.13	Average
2	7440.000	33.72	15.98	49.70	74.00	24.30	Peak
3	17774.400	16.06	31.53	47.59	54.00	6.41	Average
4	17774.400	29.12	31.53	60.65	74.00	13.35	Peak

Vertical

Project No.: CR231167748-RF
 Tester: Tao Zhu
 Polarization: Vertical
 Note:

Date: 2024-01-04

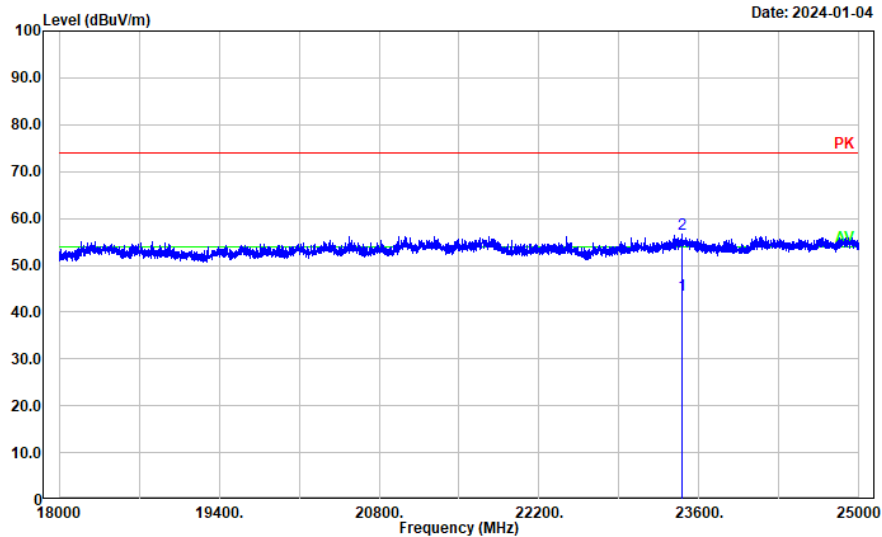

18-25GHz

No.	Frequency (MHz)	Reading (dBμV)	Factor (dB/m)	Result (dBμV/m)	Limit (dBμV/m)	Margin (dB)	Detector
1	23446.000	38.19	5.39	43.58	54.00	10.42	Average
2	23446.000	51.15	5.39	56.54	74.00	17.46	Peak

4.3 20 dB Emission Bandwidth

Serial Number:	2DS2-1	Test Date:	2023/12/29
Test Site:	RF	Test Mode:	Transmitting
Tester:	Morpheus Shi	Test Result:	N/A

Environmental Conditions:

Temperature: (°C)	23.7	Relative Humidity: (%)	45	ATM Pressure: (kPa)	101.5
----------------------	------	---------------------------	----	------------------------	-------

Test Equipment List and Details:

Manufacturer	Description	Model	Serial Number	Calibration Date	Calibration Due Date
R&S	Spectrum Analyzer	FSU26	200445	2023/3/31	2024/3/30
zhuoxiang	Coaxial Cable	SMA-178	211001	Each time	N/A
Mini-Circuits	DC Block	BLK-18-S+	1554403	Each time	N/A

* Statement of Traceability: China Certification ICT Co., Ltd (Dongguan) attests that all calibrations have been performed, traceable to National Primary Standards and International System of Units (SI).

Test Data:

Test Modes	Test Channel	Test Frequency (MHz)	20 dB Bandwidth (MHz)
BDR Mode (GFSK)	Lowest	2402	1.038
	Middle	2441	1.038
	Highest	2480	1.038
EDR Mode ($\pi/4$ -DQPSK)	Lowest	2402	1.329
	Middle	2441	1.329
	Highest	2480	1.329
EDR Mode (8DPSK)	Lowest	2402	1.288
	Middle	2441	1.288
	Highest	2480	1.288

BDR Mode (GFSK)	
Lowest Channel	<p> Ref 20 dBm *Att 25 dB *RBW 20 kHz Delta 1 [T1] -0.15 dB *VSW 50 kHz 1.038115385 MHz *SWT 30 ms Markers 1 [T1] -21.86 dBm 2.401487769 GHz 2.401487769 GHz </p> <p> 20 Offset 0.1 dB *Att 25 dB *RBW 20 kHz Delta 1 [T1] -0.41 dB *VSW 50 kHz 1.038115385 MHz *SWT 30 ms Markers 1 [T1] -21.91 dBm 2.442487769 GHz 2.442487769 GHz </p> <p> 20 Offset 0.1 dB *Att 25 dB *RBW 20 kHz Delta 1 [T1] -0.24 dB *VSW 50 kHz 1.038115385 MHz *SWT 30 ms Markers 1 [T1] -21.22 dBm 2.473487769 GHz 2.473487769 GHz </p> <p> ProjectNo.:CR231167748-RF Tester:Morpheus Shi Date: 29.DEC.2023 19:10:46 </p>
Middle Channel	<p> ProjectNo.:CR231167748-RF Tester:Morpheus Shi Date: 29.DEC.2023 19:18:31 </p>
Highest Channel	<p> ProjectNo.:CR231167748-RF Tester:Morpheus Shi Date: 29.DEC.2023 19:15:08 </p>

EDR Mode ($\pi/4$-DQPSK)	
Lowest Channel	<p> Ref 20 dBm *Att 25 dB *RBW 20 kHz Delta 1 [T1] -0.10 dB *VSW 50 kHz 1.328538462 MHz *SWT 30 ms 20 Offset 0.1 dB Markers 1 [T1] -24.10 dBm -24.29 dBm 2.401328346 GHz D1 -5.7 dBm D2 -25.71 dBm LVL 3dB Center 2.402 GHz 300 kHz/ Span 3 MHz </p> <p>ProjectNo.:CR231167748-RF Tester:Morpheus Shi Date: 29.DEC.2023 19:20:10</p>
Middle Channel	<p> Ref 20 dBm *Att 25 dB *RBW 20 kHz Delta 1 [T1] 0.75 dB *VSW 50 kHz 1.328538462 MHz *SWT 30 ms 20 Offset 0.1 dB Markers 1 [T1] -24.44 dBm -24.44 dBm 2.440315318 GHz D1 -5.7 dBm D2 -25.7 dBm LVL 3dB Center 2.441 GHz 300 kHz/ Span 3 MHz </p> <p>ProjectNo.:CR231167748-RF Tester:Morpheus Shi Date: 29.DEC.2023 19:22:47</p>
Highest Channel	<p> Ref 20 dBm *Att 25 dB *RBW 20 kHz Delta 1 [T1] 0.86 dB *VSW 50 kHz 1.328538462 MHz *SWT 30 ms 20 Offset 0.1 dB Markers 1 [T1] -24.54 dBm -24.54 dBm 2.478318318 GHz D1 -5.7 dBm D2 -25.7 dBm LVL 3dB Center 2.48 GHz 300 kHz/ Span 3 MHz </p> <p>ProjectNo.:CR231167748-RF Tester:Morpheus Shi Date: 29.DEC.2023 19:30:35</p>

EDR Mode (8DPSK)

<p>Lowest Channel</p>	<p>ProjectNo.:CR231167748-RF Tester:Morpheus Shi Date: 29.DEC.2023 19:33:01</p>
<p>Middle Channel</p>	<p>ProjectNo.:CR231167748-RF Tester:Morpheus Shi Date: 29.DEC.2023 19:34:57</p>
<p>Highest Channel</p>	<p>ProjectNo.:CR231167748-RF Tester:Morpheus Shi Date: 29.DEC.2023 19:36:29</p>

4.4 Channel Separation

Serial Number:	2DS2-1	Test Date:	2023/12/29
Test Site:	RF	Test Mode:	Transmitting
Tester:	Morpheus Shi	Test Result:	Pass

Environmental Conditions:

Temperature: (°C)	23.7	Relative Humidity: (%)	45	ATM Pressure: (kPa)	101.5
----------------------	------	---------------------------	----	------------------------	-------

Test Equipment List and Details:

Manufacturer	Description	Model	Serial Number	Calibration Date	Calibration Due Date
R&S	Spectrum Analyzer	FSU26	200445	2023/3/31	2024/3/30
zhuoxiang	Coaxial Cable	SMA-178	211001	Each time	N/A
Mini-Circuits	DC Block	BLK-18-S+	1554403	Each time	N/A

* Statement of Traceability: China Certification ICT Co., Ltd (Dongguan) attests that all calibrations have been performed, traceable to National Primary Standards and International System of Units (SI).

Test Data:

Test Modes	Test Frequency (MHz)	Channel Separation (MHz)	Limits (MHz)
BDR Mode (GFSK)	2402	1.002	0.692
	2441	1.002	0.692
	2480	1.002	0.692
EDR Mode ($\pi/4$ -DQPSK)	2402	1.002	0.886
	2441	1.002	0.886
	2480	1.002	0.886
EDR Mode (8DPSK)	2402	1.002	0.859
	2441	1.002	0.859
	2480	1.002	0.859

BDR Mode (GFSK)

<p>Lowest Channel</p>	<p>ProjectNo.:CR231167748-RF Tester:Morpheus Shi Date: 29.DEC.2023 20:18:04</p>
<p>Middle Channel</p>	<p>ProjectNo.:CR231167748-RF Tester:Morpheus Shi Date: 29.DEC.2023 20:19:11</p>
<p>Highest Channel</p>	<p>ProjectNo.:CR231167748-RF Tester:Morpheus Shi Date: 29.DEC.2023 20:20:14</p>

EDR Mode ($\pi/4$-DQPSK)	
Lowest Channel	<p> *RBW 30 kHz Delta 1 [T1] -0.01 dB *VBW 100 kHz *Att 25 dB 1.002000000 MHz Ref 20 dBm *Offet 0.1 dB SWF 15 ms Markers 1 [T1] -4.47 dBm 2.402250000 GHz </p> <p>Center 2.4025 GHz 300 kHz/ Span 3 MHz</p> <p>ProjectNo.:CR231167748-RF Tester:Morpheus Shi Date: 29.DEC.2023 20:21:52</p>
Middle Channel	<p> *RBW 30 kHz Delta 1 [T1] 0.02 dB *VBW 100 kHz *Att 25 dB 1.002000000 MHz Ref 20 dBm *Offet 0.1 dB SWF 15 ms Markers 1 [T1] -4.57 dBm 2.441250000 GHz </p> <p>Center 2.4415 GHz 300 kHz/ Span 3 MHz</p> <p>ProjectNo.:CR231167748-RF Tester:Morpheus Shi Date: 29.DEC.2023 20:22:46</p>
Highest Channel	<p> *RBW 30 kHz Delta 1 [T1] -0.03 dB *VBW 100 kHz *Att 25 dB 1.002000000 MHz Ref 20 dBm *Offet 0.1 dB SWF 15 ms Markers 1 [T1] -4.57 dBm 2.479250000 GHz </p> <p>Center 2.4795 GHz 300 kHz/ Span 3 MHz</p> <p>ProjectNo.:CR231167748-RF Tester:Morpheus Shi Date: 29.DEC.2023 20:23:37</p>

EDR Mode (8DPSK)

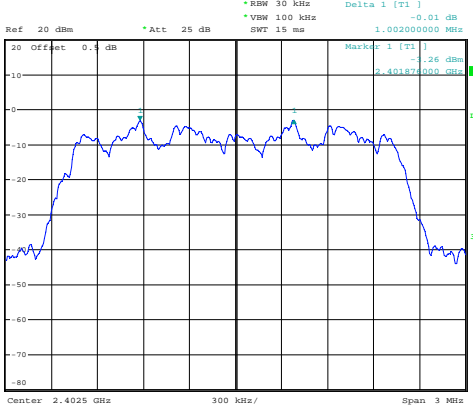
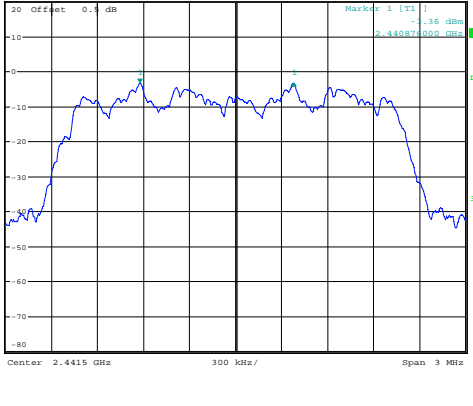
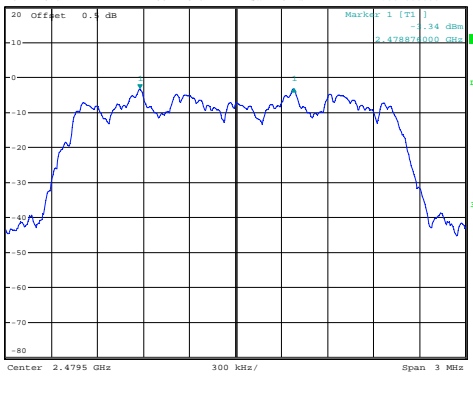
<p>Lowest Channel</p>	 <p>Ref: 20 dBm, Att: 25 dB, RBW: 30 kHz, VBW: 100 kHz, SWT: 15 ms, Delta 1 [T1]: -0.01 dB, 1.002000000 MHz</p> <p>Marker 1 [T1]: -1.26 dBm, 2.401870000 GHz</p> <p>Center: 2.4025 GHz, 300 kHz, Span: 3 MHz</p> <p>ProjectNo.: CR231167748-RF Tester: Morpheus Shi Date: 29.DEC.2023 20:27:30</p>
<p>Middle Channel</p>	 <p>Ref: 20 dBm, Att: 25 dB, RBW: 30 kHz, VBW: 100 kHz, SWT: 15 ms, Delta 1 [T1]: 0.02 dB, 1.002000000 MHz</p> <p>Marker 1 [T1]: -1.36 dBm, 2.440870000 GHz</p> <p>Center: 2.4415 GHz, 300 kHz, Span: 3 MHz</p> <p>ProjectNo.: CR231167748-RF Tester: Morpheus Shi Date: 29.DEC.2023 20:25:36</p>
<p>Highest Channel</p>	 <p>Ref: 20 dBm, Att: 25 dB, RBW: 30 kHz, VBW: 100 kHz, SWT: 15 ms, Delta 1 [T1]: -0.04 dB, 1.002000000 MHz</p> <p>Marker 1 [T1]: -1.34 dBm, 2.478870000 GHz</p> <p>Center: 2.4795 GHz, 300 kHz, Span: 3 MHz</p> <p>ProjectNo.: CR231167748-RF Tester: Morpheus Shi Date: 29.DEC.2023 20:26:35</p>

4.5 Number of Hopping Frequency

Serial Number:	2DS2-1	Test Date:	2023/12/29
Test Site:	RF	Test Mode:	Transmitting
Tester:	Morpheus Shi	Test Result:	Pass

Environmental Conditions:

Temperature: (°C)	23.7	Relative Humidity: (%)	45	ATM Pressure: (kPa)	101.5
----------------------	------	---------------------------	----	------------------------	-------

Test Equipment List and Details:

Manufacturer	Description	Model	Serial Number	Calibration Date	Calibration Due Date
R&S	Spectrum Analyzer	FSU26	200445	2023/3/31	2024/3/30
zhuoxiang	Coaxial Cable	SMA-178	211001	Each time	N/A
Mini-Circuits	DC Block	BLK-18-S+	1554403	Each time	N/A

* Statement of Traceability: China Certification ICT Co., Ltd (Dongguan) attests that all calibrations have been performed, traceable to National Primary Standards and International System of Units (SI).

Test Data:

Test Modes	Frequency Range (MHz)	Number of Hopping Channel	Limits
GFSK	2400-2483.5	79	≥15
$\pi/4$ -DQPSK	2400-2483.5	79	≥15
8DPSK	2400-2483.5	79	≥15

Number of Hopping Channel

**BDR Mode
(GFSK)**

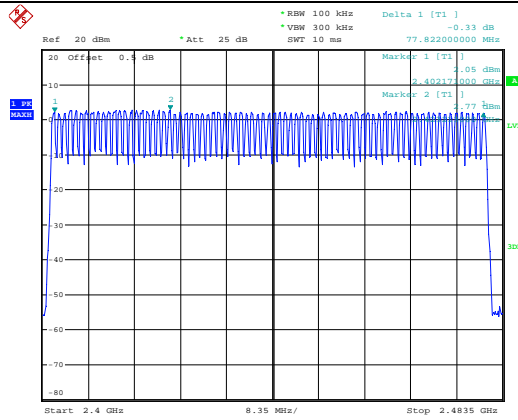

ProjectNo.:CR231167748-RF Tester:Morpheus Shi
 Date: 29.DEC.2023 20:59:25

**EDR Mode
($\pi/4$ -DQPSK)**

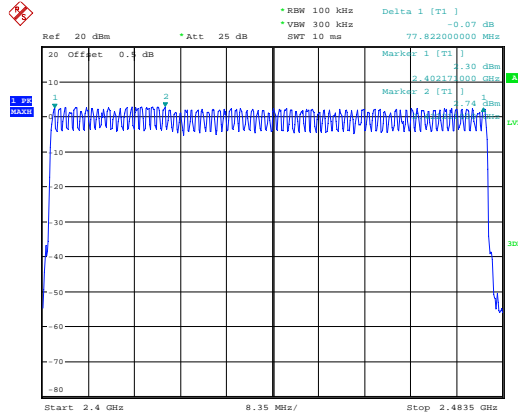

ProjectNo.:CR231167748-RF Tester:Morpheus Shi
 Date: 29.DEC.2023 21:10:01

**EDR Mode
(8DPSK)**

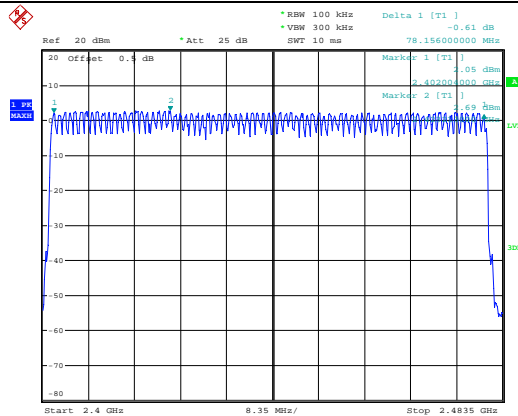

ProjectNo.:CR231167748-RF Tester:Morpheus Shi
 Date: 29.DEC.2023 21:22:35

4.6 Time of Occupancy (Dwell Time)

Serial Number:	2DS2-1	Test Date:	2023/12/29
Test Site:	RF	Test Mode:	Transmitting
Tester:	Morpheus Shi	Test Result:	Pass

Environmental Conditions:

Temperature: (°C)	23.7	Relative Humidity: (%)	45	ATM Pressure: (kPa)	101.5
----------------------	------	---------------------------	----	------------------------	-------

Test Equipment List and Details:

Manufacturer	Description	Model	Serial Number	Calibration Date	Calibration Due Date
R&S	Spectrum Analyzer	FSU26	200445	2023/3/31	2024/3/30
zhuoxiang	Coaxial Cable	SMA-178	211001	Each time	N/A
Mini-Circuits	DC Block	BLK-18-S+	1554403	Each time	N/A

* Statement of Traceability: China Certification ICT Co., Ltd (Dongguan) attests that all calibrations have been performed, traceable to National Primary Standards and International System of Units (SI).

Test Data:

Test Modes	Packet Type	Test Frequency (MHz)	Pulse width (ms)	Result (s)	Limit (s)
BDR Mode (GFSK)	DH1	2441	0.402	0.129	0.400
	DH3	2441	1.673	0.268	0.400
	DH5	2441	2.937	0.313	0.400
EDR Mode ($\pi/4$ -DQPSK)	2DH1	2441	0.408	0.131	0.400
	2DH3	2441	1.677	0.268	0.400
	2DH5	2441	2.944	0.314	0.400
EDR Mode (8DPSK)	3DH1	2441	0.416	0.133	0.400
	3DH3	2441	1.706	0.273	0.400
	3DH5	2441	2.956	0.315	0.400

Note:

DH1:Dwell time=Pulse time (ms) \times (1600/2/79) \times 31.6 s

DH3:Dwell time=Pulse time (ms) \times (1600/4/79) \times 31.6 s

DH5:Dwell time=Pulse time (ms) \times (1600/6/79) \times 31.6 s

BDR Mode (GFSK)	
DH1:	<p>Ref 20 dBm *Att 25 dB RBW 1 MHz Delta 1 [T1] -0.83 dB *VMW 3 MHz 401.600564 us SWT 3 ms</p> <p>20 Offset 0.1 db -10 0 -10 -20 -30 -40 -50 -60 -70 -80</p> <p>Center 2.441 GHz 100 µs/</p> <p>ProjectNo.:CR231167748-RF Tester:Morpheus Shi Date: 29.DEC.2023 21:57:08</p>
DH3:	<p>Ref 20 dBm *Att 25 dB RBW 1 MHz Delta 1 [T1] -1.45 dB *VMW 3 MHz 1.672615 ms SWT 3 ms</p> <p>20 Offset 0.1 db -10 0 -10 -20 -30 -40 -50 -60 -70 -80</p> <p>Center 2.441 GHz 300 µs/</p> <p>ProjectNo.:CR231167748-RF Tester:Morpheus Shi Date: 29.DEC.2023 22:02:33</p>
DH5:	<p>Ref 20 dBm *Att 25 dB RBW 1 MHz Delta 1 [T1] -0.27 dB *VMW 3 MHz 2.937128 ms SWT 4 ms</p> <p>20 Offset 0.1 db -10 0 -10 -20 -30 -40 -50 -60 -70 -80</p> <p>Center 2.441 GHz 400 µs/</p> <p>ProjectNo.:CR231167748-RF Tester:Morpheus Shi Date: 29.DEC.2023 22:18:07</p>

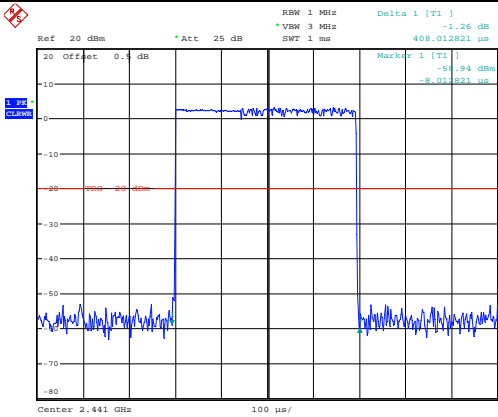
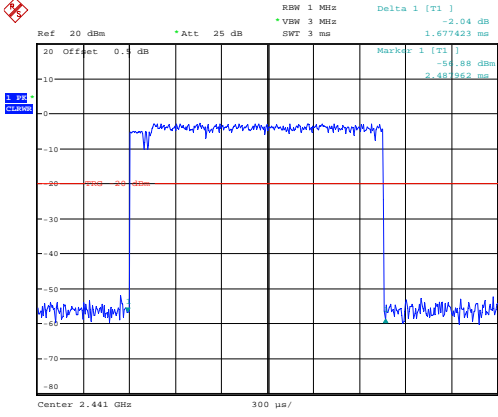
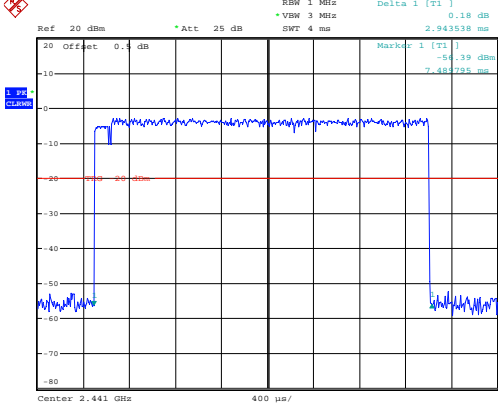
EDR Mode ($\pi/4$-DQPSK)	
2DH1:	 <p>Ref 20 dBm *Att 25 dB RBW 1 MHz Delta 1 [T1] -1.26 dB *VSW 3 MHz 408.010823 us SWT 3 ms</p> <p>20 Offset 0.4 db Markers 1 [T1] -54.94 dBm -8.012823 us</p> <p>Center 2.441 GHz 100 µs/</p> <p>ProjectNo.:CR231167748-RF Tester:Morpheus Shi Date: 29.DEC.2023 21:58:02</p>
2DH3:	 <p>Ref 20 dBm *Att 25 dB RBW 1 MHz Delta 1 [T1] -2.04 dB *VSW 3 MHz 1.677423 ms SWT 3 ms</p> <p>20 Offset 0.4 db Markers 1 [T1] -54.88 dBm 2.4877423 ms</p> <p>Center 2.441 GHz 300 µs/</p> <p>ProjectNo.:CR231167748-RF Tester:Morpheus Shi Date: 29.DEC.2023 22:11:50</p>
2DH5:	 <p>Ref 20 dBm *Att 25 dB RBW 1 MHz Delta 1 [T1] 0.18 dB *VSW 3 MHz 2.943558 ms SWT 4 ms</p> <p>20 Offset 0.4 db Markers 1 [T1] -54.39 dBm 7.487745 ms</p> <p>Center 2.441 GHz 400 µs/</p> <p>ProjectNo.:CR231167748-RF Tester:Morpheus Shi Date: 29.DEC.2023 22:19:57</p>

EDR Mode (8DPSK)	
3DH1:	<p>Ref 20 dBm *Att 25 dB RBW 1 MHz Delta 1 [T1] 1.25 dB *VMW 3 MHz 416.025643 us SWT 3 ms</p> <p>20 Offset 0.4 db Markers 1 [T1] -61.57 dBm -14.421077 us</p> <p>Center 2.441 GHz 100 µs/</p> <p>ProjectNo.:CR231167748-RF Tester:Morpheus Shi Date: 29.DEC.2023 21:58:59</p>
3DH3:	<p>Ref 20 dBm *Att 25 dB RBW 1 MHz Delta 1 [T1] 0.90 dB *VMW 3 MHz 1.706269 ms SWT 3 ms</p> <p>20 Offset 0.4 db Markers 1 [T1] -51.92 dBm 2.467711 ms</p> <p>Center 2.441 GHz 300 µs/</p> <p>ProjectNo.:CR231167748-RF Tester:Morpheus Shi Date: 29.DEC.2023 22:12:57</p>
3DH5:	<p>Ref 20 dBm *Att 25 dB RBW 1 MHz Delta 1 [T1] -1.09 dB *VMW 3 MHz 2.986369 ms SWT 4 ms</p> <p>20 Offset 0.4 db Markers 1 [T1] -51.76 dBm 7.481725 ms</p> <p>Center 2.441 GHz 400 µs/</p> <p>ProjectNo.:CR231167748-RF Tester:Morpheus Shi Date: 29.DEC.2023 22:24:02</p>

4.7 Maximum Conducted Output Power

Serial Number:	2DS2-1	Test Date:	2023/12/29
Test Site:	RF	Test Mode:	Transmitting
Tester:	Morpheus Shi	Test Result:	Pass

Environmental Conditions:

Temperature: (°C)	23.7	Relative Humidity: (%)	45	ATM Pressure: (kPa)	101.5
----------------------	------	---------------------------	----	------------------------	-------

Test Equipment List and Details:

Manufacturer	Description	Model	Serial Number	Calibration Date	Calibration Due Date
R&S	Spectrum Analyzer	FSU26	200445	2023/3/31	2024/3/30
zhuoxiang	Coaxial Cable	SMA-178	211001	Each time	N/A
Mini-Circuits	DC Block	BLK-18-S+	1554403	Each time	N/A

* Statement of Traceability: China Certification ICT Co., Ltd (Dongguan) attests that all calibrations have been performed, traceable to National Primary Standards and International System of Units (SI).

Test Data:

Test Modes	Test Frequency (MHz)	Peak Conducted Output Power (dBm)	Limits (dBm)
BDR Mode (GFSK)	2402	3.11	21
	2441	3.06	21
	2480	3.08	21
	2423	3.51	21
EDR Mode ($\pi/4$ -DQPSK)	2402	4.35	21
	2441	4.31	21
	2480	4.34	21
	2422	4.71	21
EDR Mode (8DPSK)	2402	4.59	21
	2441	4.58	21
	2480	4.63	21
	2423	4.88	21

BDR Mode (GFSK)	
Lowest Channel	<p> *RBW 3 MHz Marker 1 [T1] *VBW 10 MHz 3.11 dBm *SWT 2.5 ms 2.401856680 GHz Ref 20 dBm *Att 25 dB 20 Offset 0.1 db 1 0 dBm 1 0 dBm LVL 30dB Center 2.402 GHz 519 kHz/ Span 5.19 MHz </p> <p> ProjectNo.:CR231167748-RF Tester:Morpheus Shi Date: 29.DEC.2023 22:50:13 </p>
Middle Channel	<p> *RBW 3 MHz Marker 1 [T1] *VBW 10 MHz 3.06 dBm *SWT 2.5 ms 2.440937720 GHz Ref 20 dBm *Att 25 dB 20 Offset 0.1 db 1 0 dBm 1 0 dBm LVL 30dB Center 2.441 GHz 519 kHz/ Span 5.19 MHz </p> <p> ProjectNo.:CR231167748-RF Tester:Morpheus Shi Date: 29.DEC.2023 22:51:02 </p>
Highest Channel	<p> *RBW 3 MHz Marker 1 [T1] *VBW 10 MHz 3.08 dBm *SWT 2.5 ms 2.479948100 GHz Ref 20 dBm *Att 25 dB 20 Offset 0.1 db 1 0 dBm 1 0 dBm LVL 30dB Center 2.48 GHz 519 kHz/ Span 5.19 MHz </p> <p> ProjectNo.:CR231167748-RF Tester:Morpheus Shi Date: 29.DEC.2023 22:51:50 </p>

2423 MHz

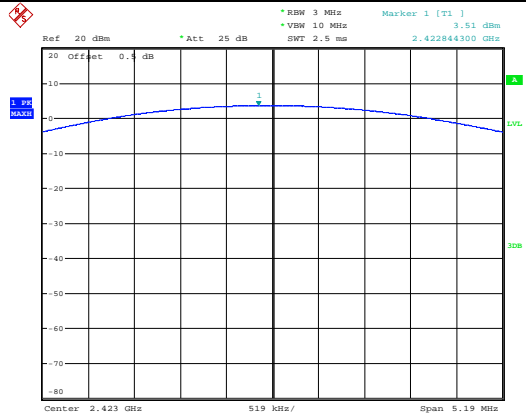

ProjectNo.:CR231167748-RF Tester:Morpheus Shi
Date: 29.DEC.2023 22:52:51

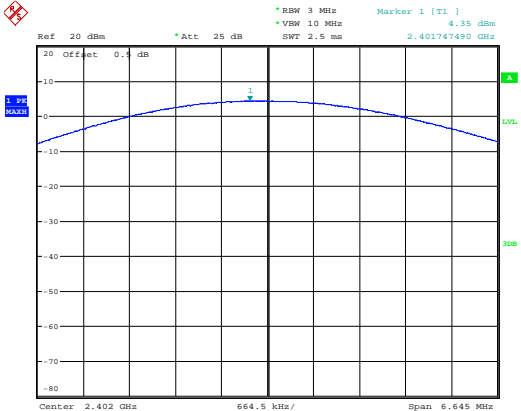
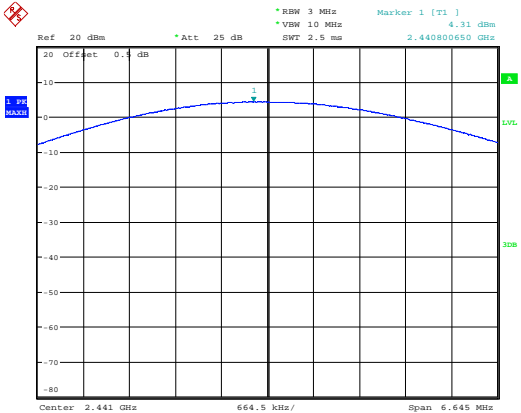
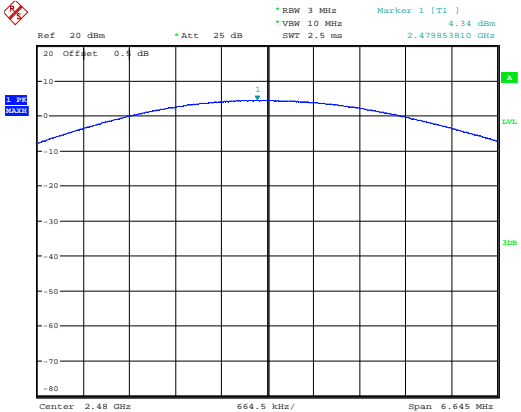
EDR Mode ($\pi/4$-DQPSK)	
Lowest Channel	 <p>ProjectNo.:CR231167748-RF Tester:Morpheus Shi Date: 29.DEC.2023 22:53:51</p>
Middle Channel	 <p>ProjectNo.:CR231167748-RF Tester:Morpheus Shi Date: 29.DEC.2023 22:54:25</p>
Highest Channel	 <p>ProjectNo.:CR231167748-RF Tester:Morpheus Shi Date: 29.DEC.2023 22:55:13</p>

2422 MHz

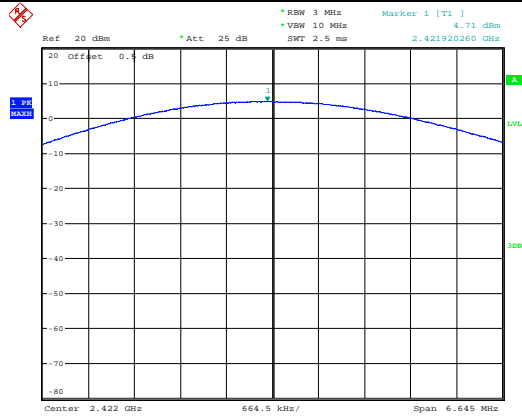

ProjectNo.:CR231167748-RF Tester:Morpheus Shi
Date: 29.DEC.2023 22:56:19

EDR Mode (8DPSK)

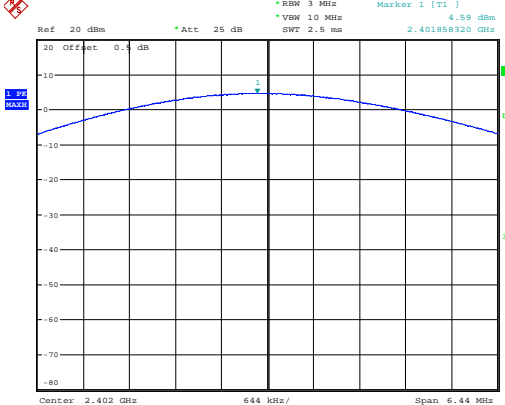
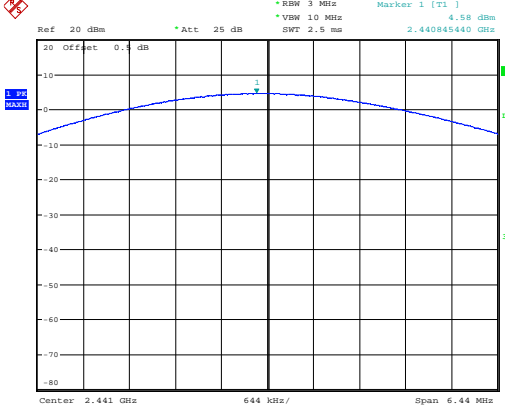
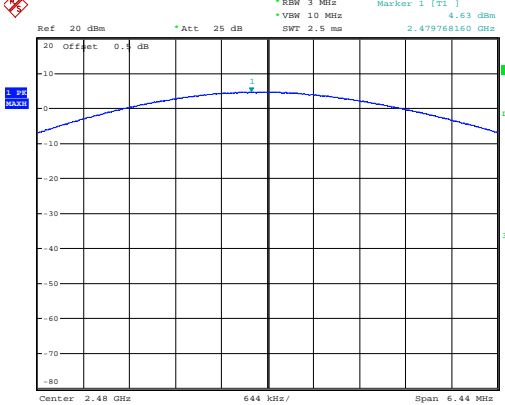
<p>Lowest Channel</p>	 <p>ProjectNo.:CR231167748-RF Tester:Morpheus Shi Date: 29.DEC.2023 22:57:10</p>
<p>Middle Channel</p>	 <p>ProjectNo.:CR231167748-RF Tester:Morpheus Shi Date: 29.DEC.2023 22:57:52</p>
<p>Highest Channel</p>	 <p>ProjectNo.:CR231167748-RF Tester:Morpheus Shi Date: 29.DEC.2023 22:58:30</p>

2423 MHz

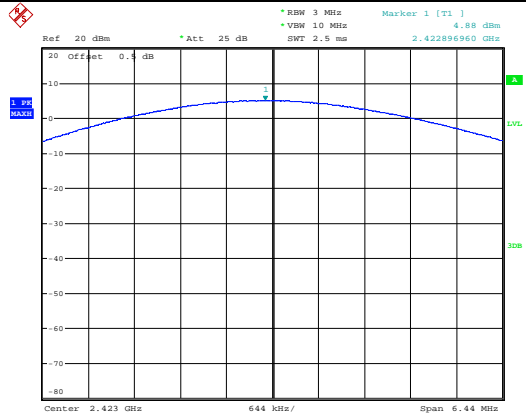

ProjectNo.:CR231167748-RP Tester:Morpheus Shi
Date: 29.DEC.2023 22:59:47

4.8 100 kHz Bandwidth of Frequency Band Edge

Serial Number:	2DS2-1	Test Date:	2023/12/29
Test Site:	RF	Test Mode:	Transmitting
Tester:	Morpheus Shi	Test Result:	Pass

Environmental Conditions:

Temperature: (°C)	23.7	Relative Humidity: (%)	45	ATM Pressure: (kPa)	101.5
----------------------	------	---------------------------	----	------------------------	-------

Test Equipment List and Details:

Manufacturer	Description	Model	Serial Number	Calibration Date	Calibration Due Date
R&S	Spectrum Analyzer	FSU26	200445	2023/3/31	2024/3/30
zhuoxiang	Coaxial Cable	SMA-178	211001	Each time	N/A
Mini-Circuits	DC Block	BLK-18-S+	1554403	Each time	N/A

* Statement of Traceability: China Certification ICT Co., Ltd (Dongguan) attests that all calibrations have been performed, traceable to National Primary Standards and International System of Units (SI).

Test Data:

Band Edge, Single Channel

**BDR Mode
(GFSK),
Left Side**

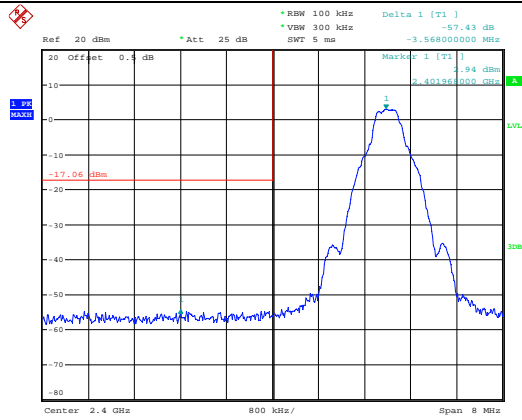

ProjectNo.:CR231167748-RF Tester:Morpheus Shi
Date: 29.DEC.2023 20:02:18

**BDR Mode
(GFSK),
Right Side**

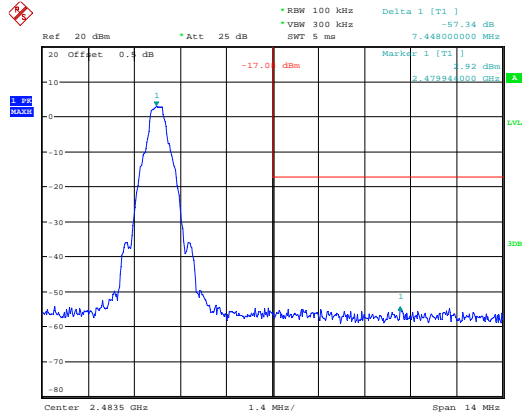

ProjectNo.:CR231167748-RF Tester:Morpheus Shi
Date: 29.DEC.2023 20:03:10

Band Edge, Single Channel

**EDR Mode
($\pi/4$ -DQPSK),
Left Side**

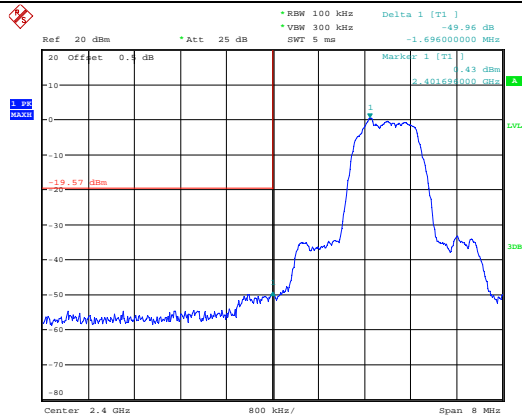

ProjectNo.:CR231167748-RF Tester:Morpheus Shi
Date: 29.DEC.2023 20:03:57

**EDR Mode
($\pi/4$ -DQPSK),
Right Side**

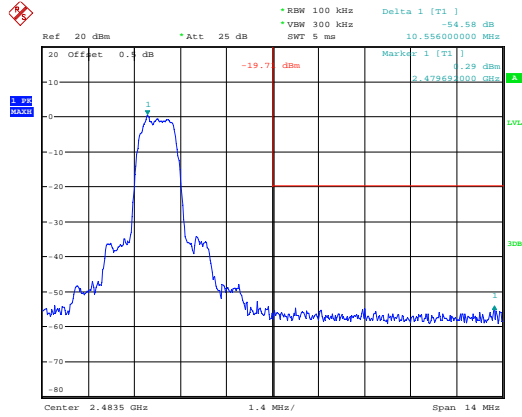

ProjectNo.:CR231167748-RF Tester:Morpheus Shi
Date: 29.DEC.2023 20:04:39

Band Edge, Single Channel

**EDR Mode
(8DPSK),
Left Side**

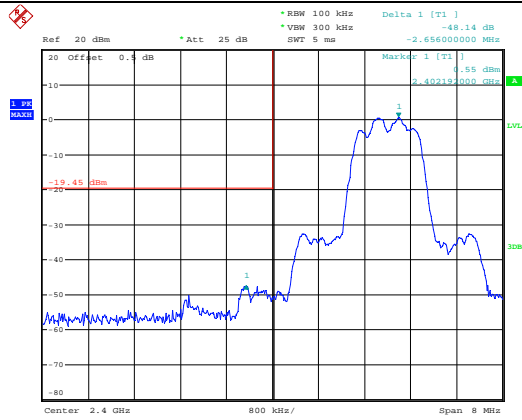

ProjectNo.:CR231167748-RF Tester:Morpheus Shi
Date: 29.DEC.2023 20:05:29

**EDR Mode
(8DPSK),
Right Side**

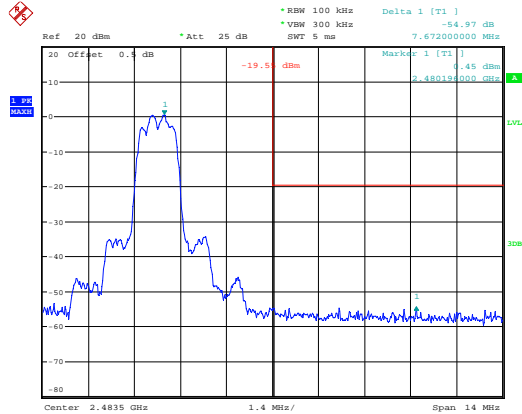

ProjectNo.:CR231167748-RF Tester:Morpheus Shi
Date: 29.DEC.2023 20:06:36

Band Edge, Hopping Channel

**BDR Mode
(GFSK),
Left Side**

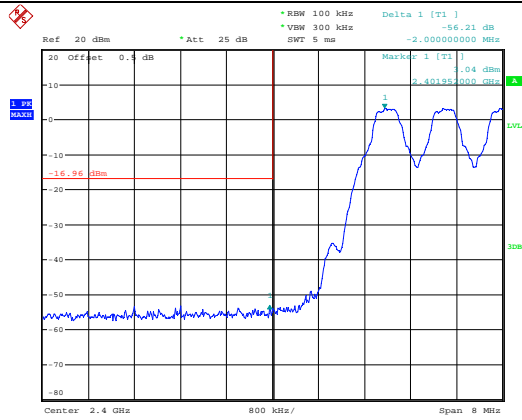

ProjectNo.:CR231167748-RF Tester:Morpheus Shi
Date: 29.DEC.2023 20:08:37

**BDR Mode
(GFSK),
Right Side**

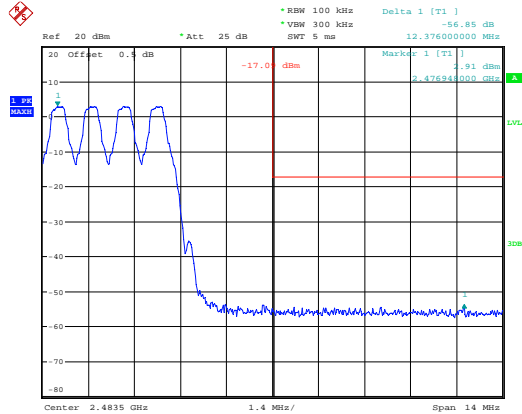

ProjectNo.:CR231167748-RF Tester:Morpheus Shi
Date: 29.DEC.2023 20:10:19

Band Edge, Hopping Channel

**EDR Mode
($\pi/4$ -DQPSK),
Left Side**

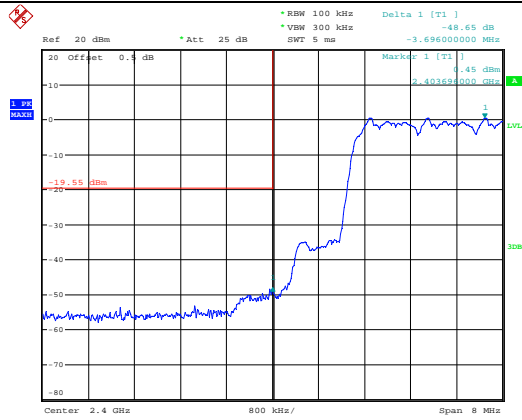

ProjectNo.:CR231167748-RF Tester:Morpheus Shi
Date: 29.DEC.2023 20:11:50

**EDR Mode
($\pi/4$ -DQPSK),
Right Side**

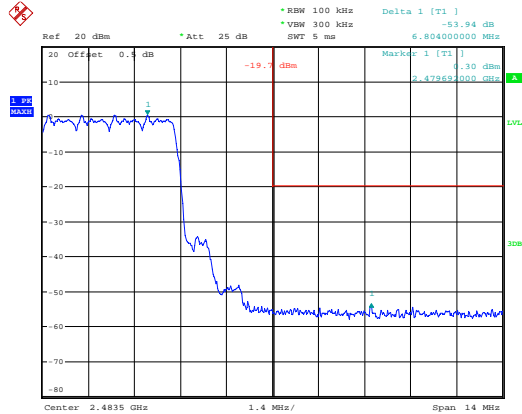

ProjectNo.:CR231167748-RF Tester:Morpheus Shi
Date: 29.DEC.2023 20:13:18

Band Edge, Hopping Channel

**EDR Mode
(8DPSK),
Left Side**

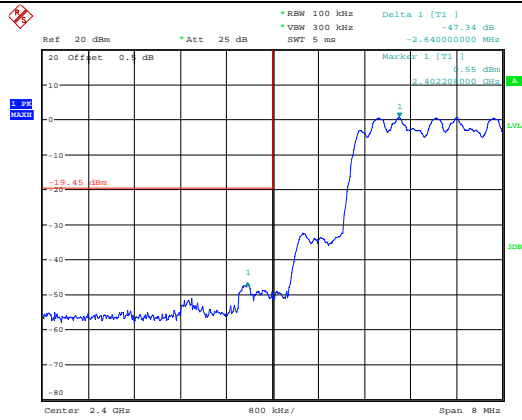

ProjectNo.:CR231167748-RF Tester:Morpheus Shi
Date: 29.DEC.2023 20:14:37

**EDR Mode
(8DPSK),
Right Side**

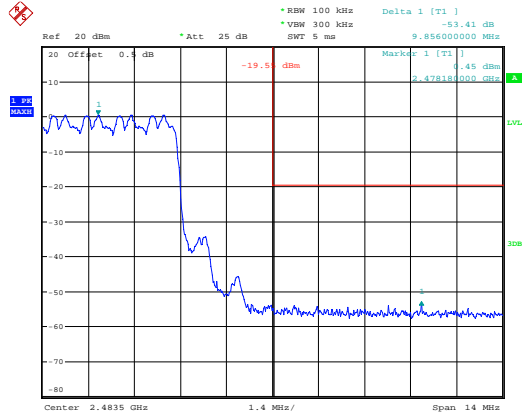

ProjectNo.:CR231167748-RF Tester:Morpheus Shi
Date: 29.DEC.2023 20:16:07

5. EUT PHOTOGRAPHS

Please refer to the attachment CR231167748-EXP EUT EXTERNAL PHOTOGRAPHS and CR231167748-INP EUT INTERNAL PHOTOGRAPHS

6. TEST SETUP PHOTOGRAPHS

Please refer to the attachment CR231167748-00B-TSP TEST SETUP PHOTOGRAPHS.

===== END OF REPORT =====