



**中认信通**

CHINA CERTIFICATION ICT CO., LTD (DONGGUAN)



## TEST REPORT

**Applicant: AKUVOX (XIAMEN) NETWORKS CO., LTD.**

Address: 10/F, No.56 Guanri Road, Software Park II, Xiamen 361009, China

**FCC ID: 2AHCR-R20BV2**

**Product Name: Door Phone**

**Model Number: R20BX5, R20BX4, R20BX3, R20BX2**

**Standard(s): 47 CFR Part 15, Subpart C(15.225)  
ANSI C63.10-2013**

The above equipment has been tested and found compliance with the requirement of the relative standards by China Certification ICT Co., Ltd (Dongguan)

**Report Number: CR220944127-00C**

**Date Of Issue: 2022-10-26**

**Reviewed By: Sun Zhong**

*Sun Zhong*

Title: Manager

**Test Laboratory: China Certification ICT Co., Ltd (Dongguan)**

No. 113, Pingkang Road, Dalang Town, Dongguan,  
Guangdong, China

Tel: +86-769-82016888

## Test Facility

The Test site used by China Certification ICT Co., Ltd (Dongguan) to collect test data is located on the No. 113, Pingkang Road, Dalang Town, Dongguan, Guangdong, China.

The lab has been recognized as the FCC accredited lab under the KDB 974614 D01 and is listed in the FCC Public Access Link (PAL) database, FCC Registration No. : 442868, the FCC Designation No. : CN1314.

The lab has been recognized by Innovation, Science and Economic Development Canada to test to Canadian radio equipment requirements, the CAB identifier: CN0123.

## Declarations

China Certification ICT Co., Ltd (Dongguan) is not responsible for the authenticity of any test data provided by the applicant. Data included from the applicant that may affect test results are marked with a triangle symbol “▲”. Customer model name, addresses, names, trademarks etc. are not considered data.

Unless otherwise stated the results shown in this test report refer only to the sample(s) tested.

This report cannot be reproduced except in full, without prior written approval of the Company.

This report is valid only with a valid digital signature. The digital signature may be available only under the Adobe software above version 7.0.

This report may contain data that are not covered by the accreditation scope and shall be marked with an asterisk “★”.

## CONTENTS

<b>TEST FACILITY .....</b>	<b>2</b>
<b>DECLARATIONS.....</b>	<b>2</b>
<b>1. GENERAL INFORMATION .....</b>	<b>4</b>
<b>1.1 PRODUCT DESCRIPTION FOR EQUIPMENT UNDER TEST (EUT) .....</b>	<b>4</b>
<b>1.2 DESCRIPTION OF TEST CONFIGURATION.....</b>	<b>5</b>
1.2.2 Support Equipment List and Details .....	5
1.2.3 Support Cable List and Details .....	5
1.2.4 Block Diagram of Test Setup.....	6
<b>1.3 MEASUREMENT UNCERTAINTY .....</b>	<b>7</b>
<b>2. SUMMARY OF TEST RESULTS .....</b>	<b>8</b>
<b>3. REQUIREMENTS AND TEST PROCEDURES .....</b>	<b>9</b>
<b>3.1 AC LINE CONDUCTED EMISSIONS.....</b>	<b>9</b>
3.1.1 Applicable Standard.....	9
3.1.2 EUT Setup.....	10
3.1.3 EMI Test Receiver Setup .....	10
3.1.4 Test Procedure .....	11
3.1.5 Corrected Amplitude & Margin Calculation.....	11
<b>3.2 RADIATED EMISSIONS .....</b>	<b>12</b>
3.2.1 Applicable Standard.....	12
3.2.2 EUT Setup.....	12
3.2.3 EMI Test Receiver & Spectrum Analyzer Setup .....	13
3.2.4 Corrected Amplitude & Margin Calculation.....	13
<b>3.3 20 dB EMISSION BANDWIDTH: .....</b>	<b>14</b>
3.3.1 Applicable Standard.....	14
3.3.2 EUT Setup.....	14
3.3.3 Test Procedure .....	14
<b>3.4 FREQUENCY STABILITY.....</b>	<b>15</b>
3.4.1 Applicable Standard.....	15
3.4.2 EUT Setup.....	15
3.4.3 Test Procedure .....	15
<b>3.5 ANTENNA REQUIREMENT.....</b>	<b>16</b>
3.5.1 Applicable Standard.....	16
3.5.2 Judgment.....	16
<b>4. TEST DATA AND RESULTS .....</b>	<b>17</b>
<b>4.1 AC LINE CONDUCTED EMISSIONS.....</b>	<b>17</b>
<b>4.2 RADIATION SPURIOUS EMISSIONS .....</b>	<b>20</b>
<b>4.3 20 dB EMISSION BANDWIDTH .....</b>	<b>32</b>
<b>4.4 FREQUENCY STABILITY.....</b>	<b>34</b>

## 1. GENERAL INFORMATION

### 1.1 Product Description for Equipment under Test (EUT)

<b>EUT Name:</b>	Door Phone
<b>EUT Model:</b>	R20BX5
<b>Multiple Model(s):</b>	R20BX4,R20BX3,R20BX2
<b>Operation Frequency:</b>	13.56 MHz
<b>Modulation Type:</b>	ASK
<b>Rated Input Voltage:</b>	DC 12V or 48Vdc from POE
<b>Serial Number:</b>	CR220944127-RF-S1
<b>EUT Received Date:</b>	2022.10.10
<b>EUT Received Status:</b>	Good

Note: The Multiple models are electrically identical with the test model. Please refer to the declaration letter for more detail, which was provided by manufacturer. Conducted Emissions Test only performed with Adapter mode since it is the worst mode per test for CR220944127-00B report. Radiated Emission Test only performed with PoE mode since it is the worst mode per test for CR220944127-00B report.

#### Antenna Information Detail▲:

Antenna Manufacturer Antenna Type	input impedance (Ohm)	Antenna Gain /Frequency Range	§15.203 Requirement
PCB Loop	50	Unknow	Compliance

The Method of §15.203 Compliance:

- Antenna must be permanently attached to the unit.
- Antenna must use a unique type of connector to attach to the EUT.
- Unit must be professionally installed, and installer shall be responsible for verifying that the correct antenna is employed with the unit.

#### Accessory Information:

Accessory Description	Manufacturer	Model	Parameters
RJ45 Cable	Unknown	Unknown	Unshielded, 0.5m

## 1.2 Description of Test Configuration

### 1.2.1 EUT Operation Condition:

<b>EUT Operation Mode:</b>	The system was configured for testing in Engineering Mode, which was provided by the manufacturer.
<b>Equipment Modifications:</b>	No
<b>EUT Exercise Software:</b>	No
Engineering Mode was provided by manufacturer▲. The maximum power was configured default setting.	

### 1.2.2 Support Equipment List and Details

Manufacturer	Description	Model	Serial Number
DELL	Laptop	E6410	G4JJPM1
TOTO LINK	Router	X5000R	X5000RK9T0560
HUAWEI	Adapter(POE)	POE35-56A	POE21103004
AKUVOX	Card reader(WG)	N5632	MN52P0024
Unknown	Load 1	20W	2001
Unknown	Load 2	20W	2002
DJI	Adapter	QC24-EU	A211105009
LANDI	NFC Card	EINOLDA	EMZBNC21103001
XinLianYing	POE Combiner	POE-QZ02	PQZC001

### 1.2.3 Support Cable List and Details

Cable Description	Shielding Type	Ferrite Core	Length (m)	From Port	To
Cable	No	No	2	EUT(Door)	Load 1
Cable	No	No	2	EUT(Relay)	Load 2
Cable	No	No	2	EUT(RS485)	Laptop
Cable	No	No	1.8	EUT(WG)	Card reader(WG)
RJ45 Cable	No	Yes	3	EUT	Router
RJ45 Cable	No	No	1	EUT	POE
RJ45 Cable	No	Yes	3	Router	POE
Power Cable	No	Yes	1	EUT	Adapter
Power Cable	No	No	1.2	LISN	Adapter

### 1.2.4 Block Diagram of Test Setup

Conducted emissions:

Adapter :

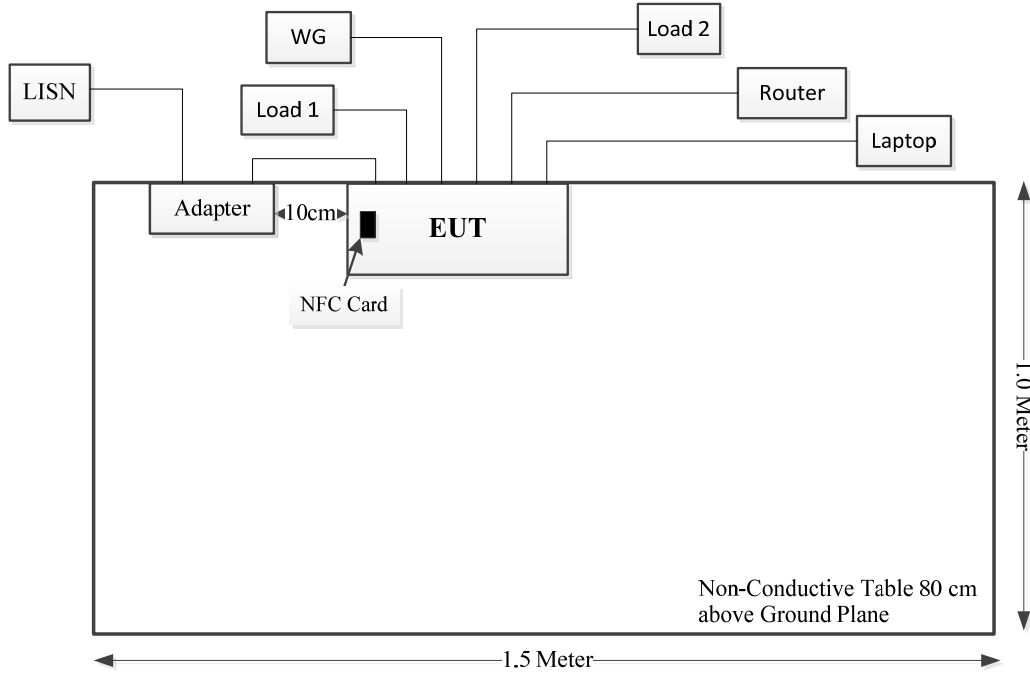

Radiated emissions:

POE:

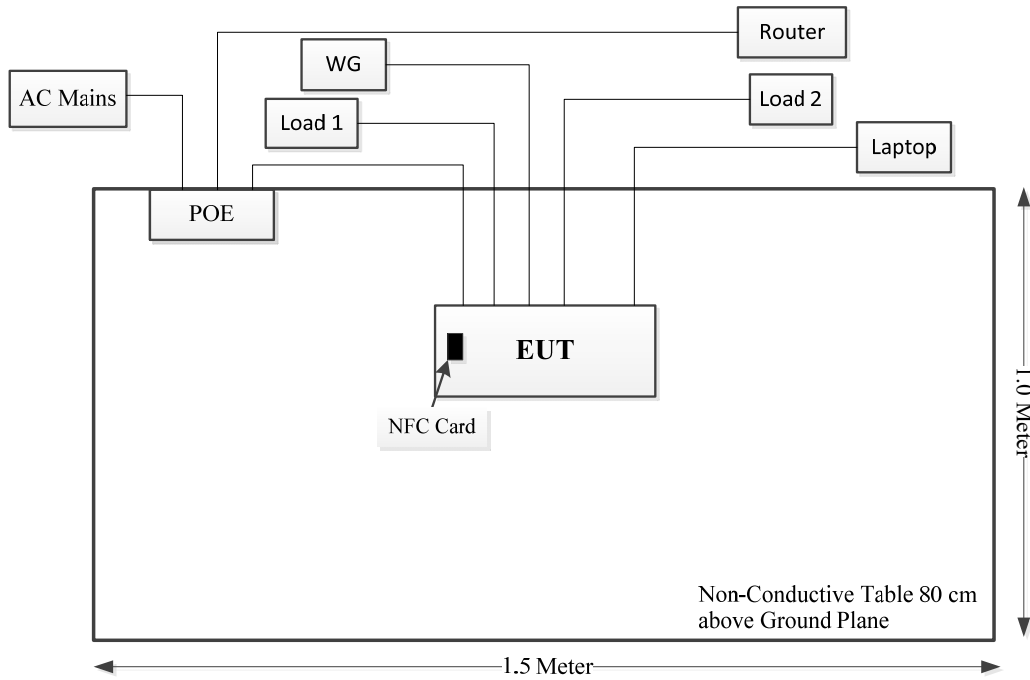

### 1.3 Measurement Uncertainty

Otherwise required by the applicant or Product Regulations, Decision Rule in this report did not consider the uncertainty. The extended uncertainty given in this report is obtained by combining the standard uncertainty times the coverage factor K with the 95% confidence interval.

Parameter	Measurement Uncertainty
Occupied Channel Bandwidth	±5 %
Unwanted Emissions, radiated	9kHz~30MHz: 4.12dB 30M~200MHz: 4.15 dB,200M~1GHz: 5.61 dB,1G~6GHz: 5.14 dB, 6G~18GHz: 5.93 dB,18G~26.5G:5.47 dB,26.5G~40G:5.63 dB
Temperature	±1 °C
Humidity	±5%
DC and low frequency voltages	±0.4%
Duty Cycle	1%
AC Power Lines Conducted Emission	2.8 dB (150 kHz to 30 MHz)

## 2. SUMMARY OF TEST RESULTS

FCC Rules	Description of Test	Result
FCC§15.203	Antenna Requirement	Compliant
FCC§15.207 (a)	Conducted Emissions	Compliant
§15.225 §15.209 §15.205	Radiated Emission Test	Compliant
§15.225(e)	Frequency Stability	Compliant
§15.215(c)	20 dB Bandwidth	Compliant



### 3. REQUIREMENTS AND TEST PROCEDURES

#### 3.1 AC Line Conducted Emissions

##### 3.1.1 Applicable Standard

FCC§15.207(a).

(a) Except as shown in paragraphs (b) and (c) of this section, for an intentional radiator that is designed to be connected to the public utility (AC) power line, the radio frequency voltage that is conducted back onto the AC power line on any frequency or frequencies, within the band 150 kHz to 30 MHz, shall not exceed the limits in the following table, as measured using a 50  $\mu$ H/50 ohms line impedance stabilization network (LISN). Compliance with the provisions of this paragraph shall be based on the measurement of the radio frequency voltage between each power line and ground at the power terminal. The lower limit applies at the boundary between the frequency ranges.

Frequency of emission (MHz)	Conducted limit (dB $\mu$ V)	
	Quasi-peak	Average
0.15-0.5	66 to 56*	56 to 46*
0.5-5	56	46
5-30	60	50

\*Decreases with the logarithm of the frequency.

(b) The limit shown in paragraph (a) of this section shall not apply to carrier current systems operating as intentional radiators on frequencies below 30 MHz. In lieu thereof, these carrier current systems shall be subject to the following standards:

(1) For carrier current system containing their fundamental emission within the frequency band 535-1705 kHz and intended to be received using a standard AM broadcast receiver: no limit on conducted emissions.

(2) For all other carrier current systems: 1000  $\mu$ V within the frequency band 535-1705 kHz, as measured using a 50  $\mu$ H/50 ohms LISN.

(3) Carrier current systems operating below 30 MHz are also subject to the radiated emission limits in §15.205, §15.209, §15.221, §15.223, or §15.227, as appropriate.

(c) Measurements to demonstrate compliance with the conducted limits are not required for devices which only employ battery power for operation and which do not operate from the AC power lines or contain provisions for operation while connected to the AC power lines. Devices that include, or make provisions for, the use of battery chargers which permit operating while charging, AC adapters or battery eliminators or that connect to the AC power lines indirectly, obtaining their power through another device which is connected to the AC power lines, shall be tested to demonstrate compliance with the conducted limits.

### 3.1.2 EUT Setup

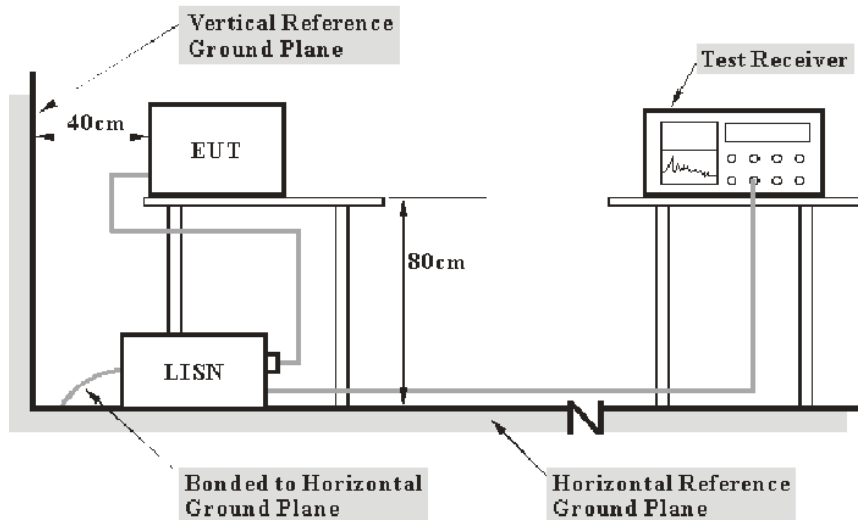

- Note: 1. Support units were connected to second LISN.  
 2. Both of LISNs (AMN) 80 cm from EUT and at the least 80 cm from other units and other metal planes support units.

The setup of EUT is according with per ANSI C63.10-2013 measurement procedure. The specification used was with the FCC Part 15.207 limits.

The spacing between the peripherals was 10 cm.

The adapter or EUT was connected to the main LISN with a 120 V/60 Hz AC power source.

### 3.1.3 EMI Test Receiver Setup

The EMI test receiver was set to investigate the spectrum from 150 kHz to 30 MHz.

During the conducted emission test, the EMI test receiver was set with the following configurations:

Frequency Range	IF B/W
150 kHz – 30 MHz	9 kHz

### 3.1.4 Test Procedure

During the conducted emission test, the adapter was connected to the outlet of the LISN.

The frequency and amplitude of the six highest ac power-line conducted emissions relative to the limit, measured over all the current-carrying conductors of the EUT power cords, and the operating frequency or frequency to which the EUT is tuned (if appropriate), should be reported, unless such emissions are more than 20 dB below the limit. AC power-line conducted emissions measurements are to be separately carried out only on each of the phase (“hot”) line(s) and (if used) on the neutral line(s), but not on the ground [protective earth] line(s). If less than six emission frequencies are within 20 dB of the limit, then the noise level of the measuring instrument at representative frequencies should be reported. The specific conductor of the power-line cord for each of the reported emissions should be identified. Measure the six highest emissions with respect to the limit on each current-carrying conductor of each power cord associated with the EUT (but not the power cords of associated or peripheral equipment that are part of the test configuration). Then, report the six highest emissions with respect to the limit from among all the measurements identifying the frequency and specific current-carrying conductor identified with the emission. The six highest emissions should be reported for each of the current-carrying conductors, or the six highest emissions may be reported over all the current-carrying conductors.

According FCC publication number 174176, for a device with a permanent antenna operating at or below 30 MHz, the measurements done with a suitable dummy load, in lieu of the permanent antenna under the following conditions: (1) perform the AC line conducted tests with the permanent antenna to determine compliance with the Section 15.207 limits outside the transmitter's fundamental emission band; (2) retest with a dummy load in lieu of the permanent antenna to determine compliance with the Section 15.207 limits within the transmitter's fundamental emission band.

### 3.1.5 Corrected Amplitude & Margin Calculation

The basic equation is as follows:

Result = Reading + Factor

Factor = attenuation caused by cable loss + voltage division factor of AMN

The “**Margin**” column of the following data tables indicates the degree of compliance within the applicable limit. The equation for margin calculation is as follows:

Margin = Limit – Result

### 3.2 Radiated Emissions

#### 3.2.1 Applicable Standard

As per FCC Part 15.225

- (a) The field strength of any emissions within the band 13.553–13.567 MHz shall not exceed 15,848 microvolts/meter at 30 meters.
- (b) Within the bands 13.410–13.553 MHz and 13.567–13.710 MHz, the field strength of any emissions shall not exceed 334 microvolts/meter at 30 meters.
- (c) Within the bands 13.110–13.410 MHz and 13.710–14.010 MHz the field strength of any emissions shall not exceed 106 microvolts/meter at 30 meters.
- (d) The field strength of any emissions appearing outside of the 13.110–14.010 MHz band shall not exceed the general radiated emission limits in §15.209.

#### 3.2.2 EUT Setup

9kHz-30MHz:

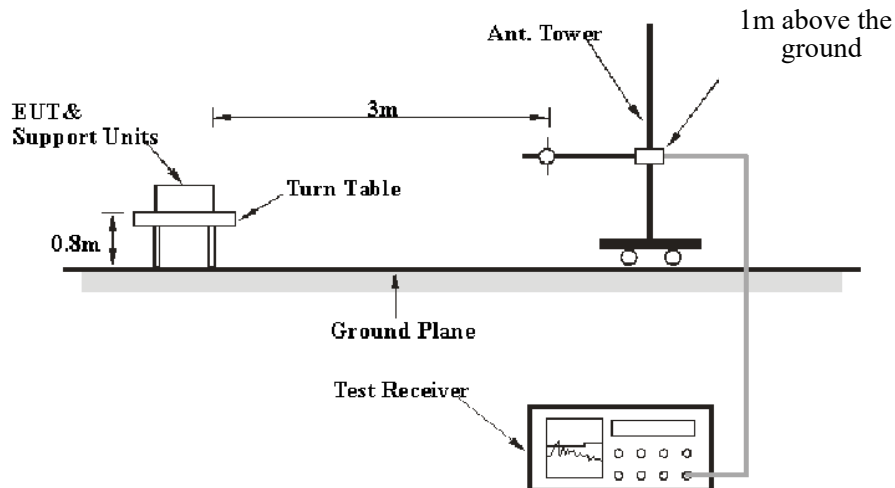

30MHz-1GHz:

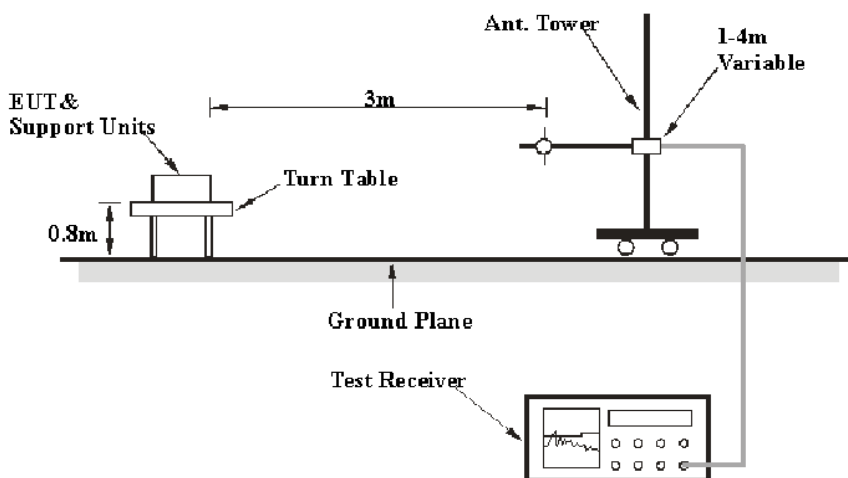

The radiated emission tests were performed in the 3-meter chamber test site, using the setup accordance with the ANSI C63.10-2013.

The spacing between the peripherals was 10 cm.

For 9kHz-30MHz test, the lowest height of the magnetic antenna shall be 1 m above the ground and three antenna orientations (parallel, perpendicular, and ground-parallel) shall be measured.

### 3.2.3 EMI Test Receiver & Spectrum Analyzer Setup

The system was investigated from 9 kHz to 1 GHz.

During the radiated emission test, the EMI test Receiver was set with the following configurations:

Frequency Range	RBW	Video B/W	Detector
9 kHz – 150 kHz	200 Hz	1 kHz	QP
150 kHz – 30 MHz	9 kHz	30 kHz	QP
30 MHz – 1000 MHz	120 kHz	300 kHz	QP

If the maximized peak measured value complies with the limit, then it is unnecessary to perform an QP measurement

### 3.2.4 Corrected Amplitude & Margin Calculation

The basic equation is as follows:

Result = Reading + Factor

Factor = Antenna Factor + Cable Loss- Amplifier Gain

The “**Margin**” column of the following data tables indicates the degree of compliance within the applicable limit. The equation for margin calculation is as follows:

Margin = Limit – Result

### 3.3 20 dB Emission Bandwidth:

#### 3.3.1 Applicable Standard

FCC §15.215

Intentional radiators operating under the alternative provisions to the general emission limits, as contained in §15.217 through § 15.257 and in Subpart E of this part, must be designed to ensure that the 20 dB bandwidth of the emission, or whatever bandwidth may otherwise be specified in the specific rule section under which the equipment operates, is contained within the frequency band designated in the rule section under which the equipment is operated. The requirement to contain the designated bandwidth of the emission within the specified frequency band includes the effects from frequency sweeping, frequency hopping and other modulation techniques that may be employed as well as the frequency stability of the transmitter over expected variations in temperature and supply voltage. If a frequency stability is not specified in the regulations, it is recommended that the fundamental emission be kept within at least the central 80% of the permitted band in order to minimize the possibility of out-of band operation.

#### 3.3.2 EUT Setup

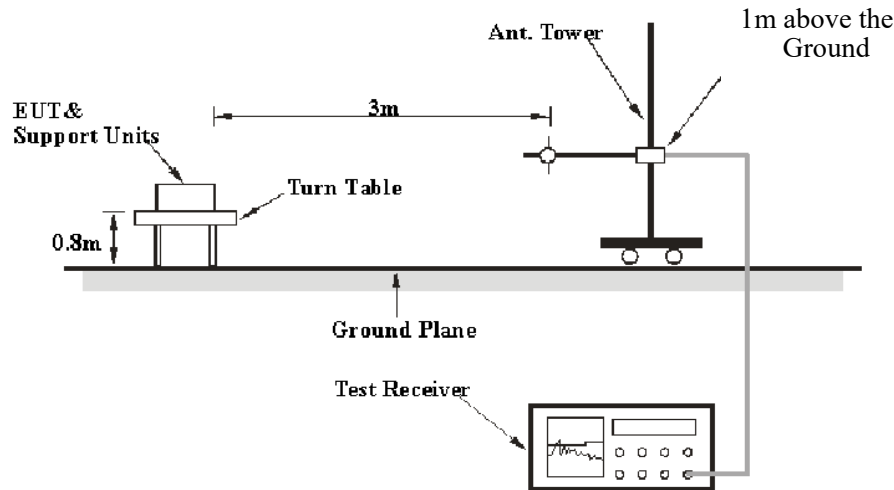

#### 3.3.3 Test Procedure

1. Position the EUT on the test table without connection to measurement instrument. Turn on the EUT. Then set it to any one convenient frequency within its operating range. Set a reference level on the measuring instrument equal to the highest peak value.
2. Measure the frequency difference of two frequencies that were attenuated 20 dB from the reference level. Record the frequency difference as the emission bandwidth.

### 3.4 Frequency Stability

#### 3.4.1 Applicable Standard

As per FCC Part 15.225:

The frequency tolerance of the carrier signal shall be maintained within  $\pm 0.01\%$  of the operating frequency over a temperature variation of  $-20$  degrees to  $+50$  degrees C at normal supply voltage, and for a variation in the primary supply voltage from 85% to 115% of the rated supply voltage at a temperature of 20 degrees C. For battery operated equipment, the equipment tests shall be performed using a new battery.

#### 3.4.2 EUT Setup

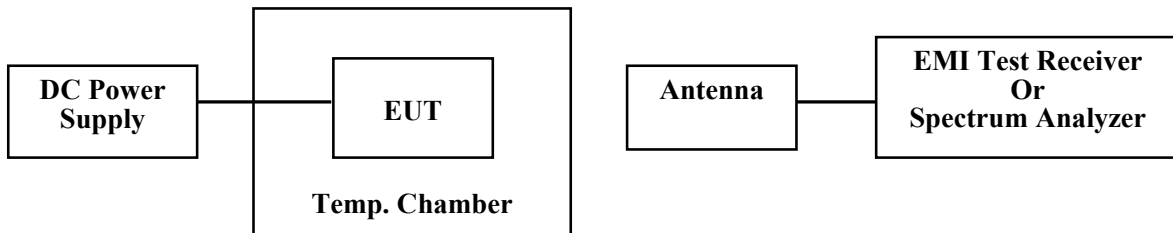

#### 3.4.3 Test Procedure

Frequency Stability vs. Temperature: The equipment under test was connected to an external DC power.

The EUT was placed inside the temperature chamber.

After the temperature stabilized for approximately 20 minutes, the frequency output was recorded from the Spectrum Analyzer.

Frequency Stability vs. Voltage: An external variable DC power supply Source. The voltage was set to the end point of the battery. The output frequency was recorded for each voltage.

### **3.5 Antenna Requirement**

#### **3.5.1 Applicable Standard**

FCC §15.203

An intentional radiator shall be designed to ensure that no antenna other than that furnished by the responsible party shall be used with the device. The use of a permanently attached antenna or of an antenna that uses a unique coupling to the intentional radiator shall be considered sufficient to comply with the provisions of this section. The manufacturer may design the unit so that a broken antenna can be replaced by the user, but the user of a standard antenna jack or electrical connector is prohibited. The structure and application of the EUT were analyzed to determine compliance with section §15.203 of the rules. §15.203 state that the subject device must meet the following criteria:

- a. Antenna must be permanently attached to the unit.
- b. Antenna must use a unique type of connector to attach to the EUT.
- c. Unit must be professionally installed, and installer shall be responsible for verifying that the correct antenna is employed with the unit.

#### **3.5.2 Judgment**

Please refer to the Antenna Information detail in Section 1.



## 4. TEST DATA AND RESULTS

### 4.1 AC Line Conducted Emissions

Serial Number:	CR220944127-RF-S1	Test Date:	2022/10/13
Test Site:	CE	Test Mode:	Transmitting
Tester:	Vic Du	Test Result:	Pass

Environmental Conditions:					
Temperature: (°C)	24.2	Relative Humidity: (%)	49	ATM Pressure: (kPa)	100.9

#### Test Equipment List and Details:

Manufacturer	Description	Model	Serial Number	Calibration Date	Calibration Due Date
R&S	LISN	ENV216	101134	2022/04/01	2023/03/31
R&S	EMI Test Receiver	ESR3	102726	2022/07/15	2023/07/14
MICRO-COAX	Coaxial Cable	UTIFLEX	C-0200-01	2022/08/07	2023/08/06
Audix	Test Software	E3	190306 (V9)	N/A	N/A

\* Statement of Traceability: China Certification ICT Co., Ltd (Dongguan) attests that all calibrations have been performed, traceable to National Primary Standards and International System of Units (SI).

Adapter :

Test Mode: Transmitting  
 Port: Line  
 Note:

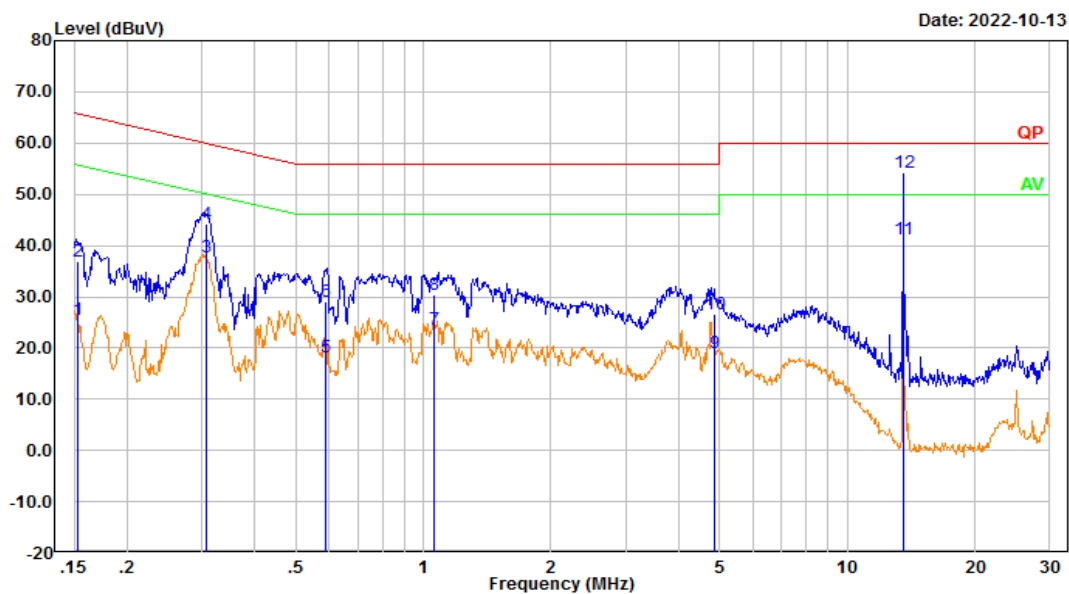

No.	Frequency (MHz)	Reading (dBuV)	Factor (dB)	Result (dBuV)	Limit (dBuV)	Margin (dB)	Detector
1	0.153	15.81	9.61	25.42	55.85	30.43	Average
2	0.153	27.38	9.61	36.99	65.85	28.86	QP
3	0.307	28.16	9.61	37.77	50.06	12.29	Average
4	0.307	34.64	9.61	44.25	60.06	15.81	QP
5	0.588	8.62	9.62	18.24	46.00	27.76	Average
6	0.588	19.33	9.62	28.95	56.00	27.05	QP
7	1.058	14.14	9.62	23.76	46.00	22.24	Average
8	1.058	20.83	9.62	30.45	56.00	25.55	QP
9	4.846	9.31	9.66	18.97	46.00	27.03	Average
10	4.846	16.95	9.66	26.61	56.00	29.39	QP
11	13.560	31.53	9.68	41.21	50.00	8.79	Average
12	13.560	44.44	9.68	54.12	60.00	5.88	QP

Test Mode: Transmitting  
 Port: neutral  
 Note:

Date: 2022-10-13

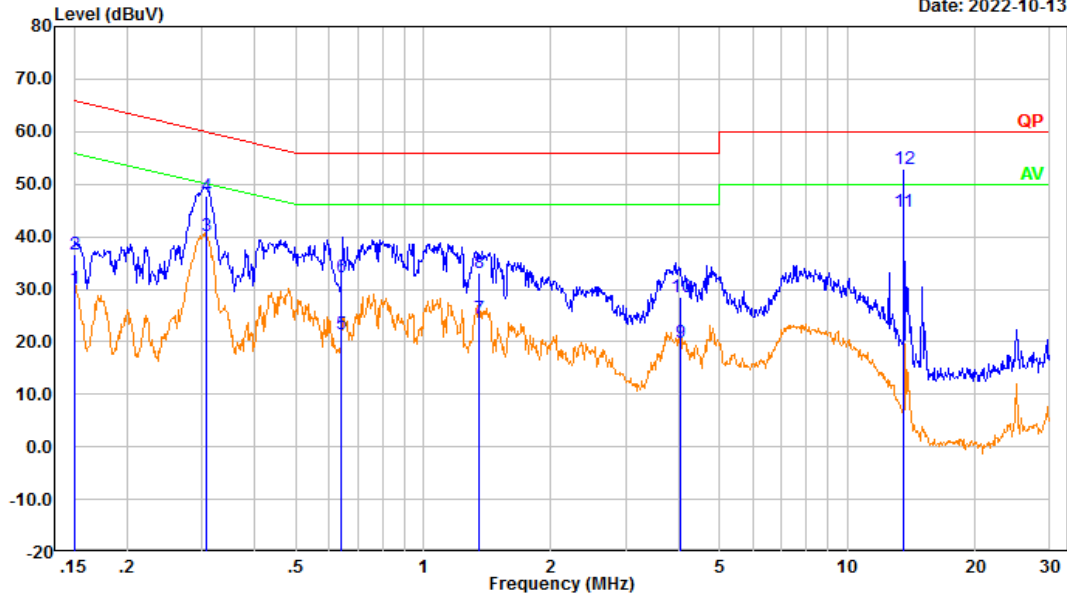

No.	Frequency (MHz)	Reading (dBuV)	Factor (dB)	Result (dBuV)	Limit (dBuV)	Margin (dB)	Detector
1	0.151	20.50	9.61	30.11	55.94	25.83	Average
2	0.151	26.91	9.61	36.52	65.94	29.42	QP
3	0.307	30.65	9.61	40.26	50.05	9.79	Average
4	0.307	38.09	9.61	47.70	60.05	12.35	QP
5	0.642	11.78	9.62	21.40	46.00	24.60	Average
6	0.642	22.81	9.62	32.43	56.00	23.57	QP
7	1.354	14.69	9.62	24.31	46.00	21.69	Average
8	1.354	23.60	9.62	33.22	56.00	22.78	QP
9	4.039	10.17	9.65	19.82	46.00	26.18	Average
10	4.039	18.92	9.65	28.57	56.00	27.43	QP
11	13.560	35.12	9.68	44.80	50.00	5.20	Average
12	13.560	43.22	9.68	52.90	60.00	7.10	QP

**4.2 Radiation Spurious Emissions**

Serial Number:	CR220944127-RF-S1	Test Date:	2022/10/15~2022/10/17
Test Site:	966-2	Test Mode:	Transmitting
Tester:	Carl Xue	Test Result:	Pass

**Environmental Conditions:**

Temperature: (°C)	26.4~26.7	Relative Humidity: (%)	46~51	ATM Pressure: (kPa)	100.5~100.7
----------------------	-----------	---------------------------	-------	---------------------------	-------------

**Test Equipment List and Details:**

Manufacturer	Description	Model	Serial Number	Calibration Date	Calibration Due Date
TESEQ	HF Loop Antenna	HLA6120	33561	2021/02/03	2024/02/02
Sunol Sciences	Antenna	JB6	A082520-5	2020/10/19	2023/10/18
R&S	EMI Test Receiver	ESR3	102724	2022/07/15	2023/07/14
TIMES MICROWAVE	Coaxial Cable	LMR-600- UltraFlex	C-0470-02	2022/07/17	2023/07/16
TIMES MICROWAVE	Coaxial Cable	LMR-600- UltraFlex	C-0780-01	2022/07/17	2023/07/16
Sonoma	Amplifier	310N	186165	2022/07/17	2023/07/16
Audix	Test Software	E3	201021 (V9)	N/A	N/A

\* Statement of Traceability: China Certification ICT Co., Ltd (Dongguan) attests that all calibrations have been performed, traceable to National Primary Standards and International System of Units (SI).

1) 9 kHz~30MHz:  
POE Parallel:

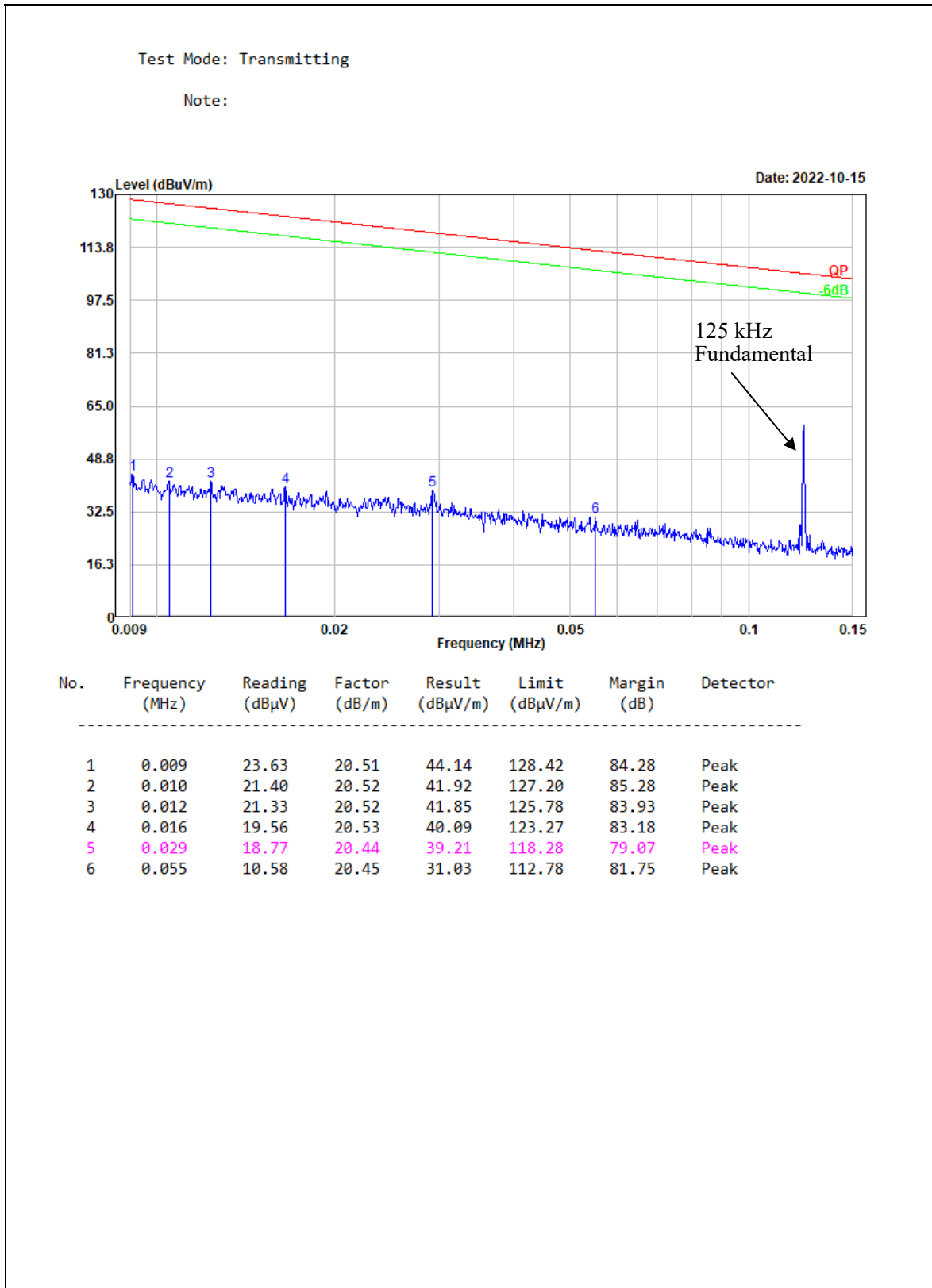

Test Mode: Transmitting

Note:

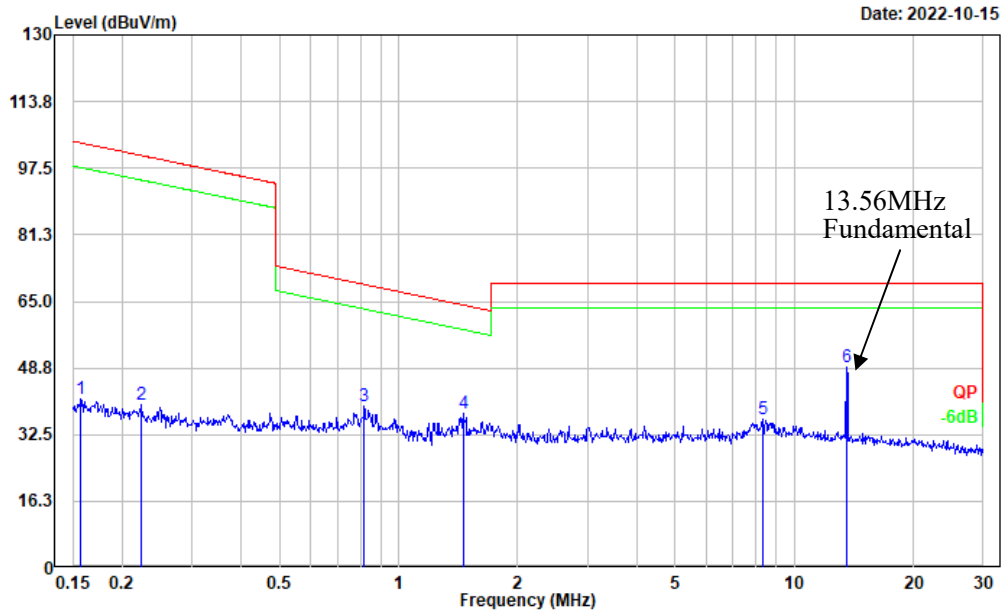

No.	Frequency (MHz)	Reading (dBμV)	Factor (dB/m)	Result (dBμV/m)	Limit (dBμV/m)	Margin (dB)	Detector
1	0.157	21.05	20.27	41.32	103.67	62.35	Peak
2	0.224	19.71	20.22	39.93	100.58	60.65	Peak
3	0.817	19.36	20.10	39.46	69.26	29.80	Peak
4	1.456	17.61	20.04	37.65	64.14	26.49	Peak
5	8.323	15.97	20.28	36.25	69.54	33.29	Peak
6	13.551	28.58	20.52	49.10	69.54	20.44	Peak

Test Mode: Transmitting

Note:

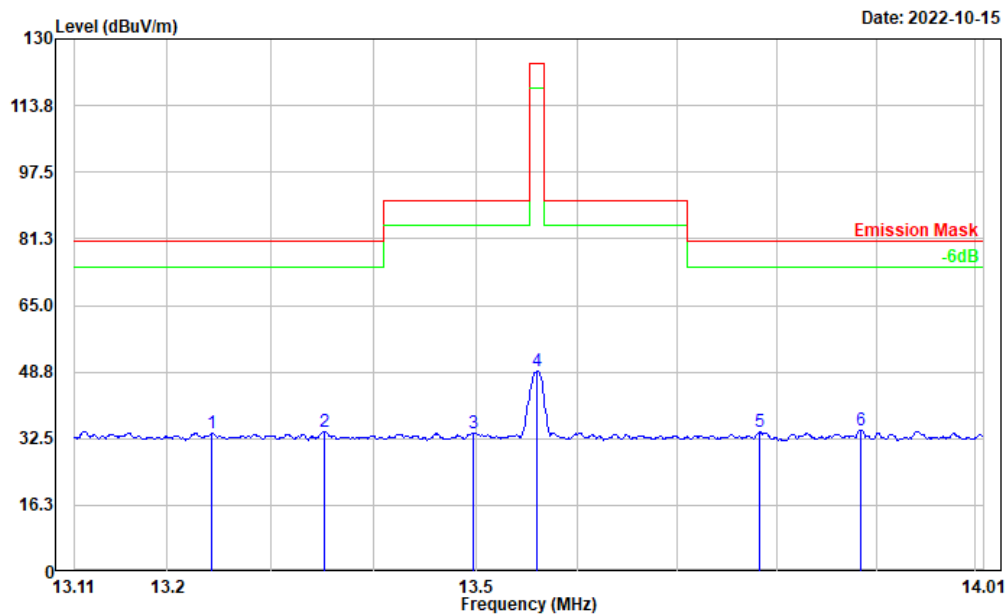

No.	Frequency (MHz)	Reading (dBμV)	Factor (dB/m)	Result (dBμV/m)	Limit (dBμV/m)	Margin (dB)	Detector
1	13.243	13.31	20.50	33.81	80.51	46.70	Peak
2	13.352	13.69	20.51	34.20	80.51	46.31	Peak
3	13.498	13.28	20.51	33.79	90.47	56.68	Peak
4	13.561	28.51	20.52	49.03	124.00	74.97	Peak
5	13.782	13.48	20.53	34.01	80.51	46.50	Peak
6	13.885	14.05	20.53	34.58	80.51	45.93	Peak

POE Perpendicular:

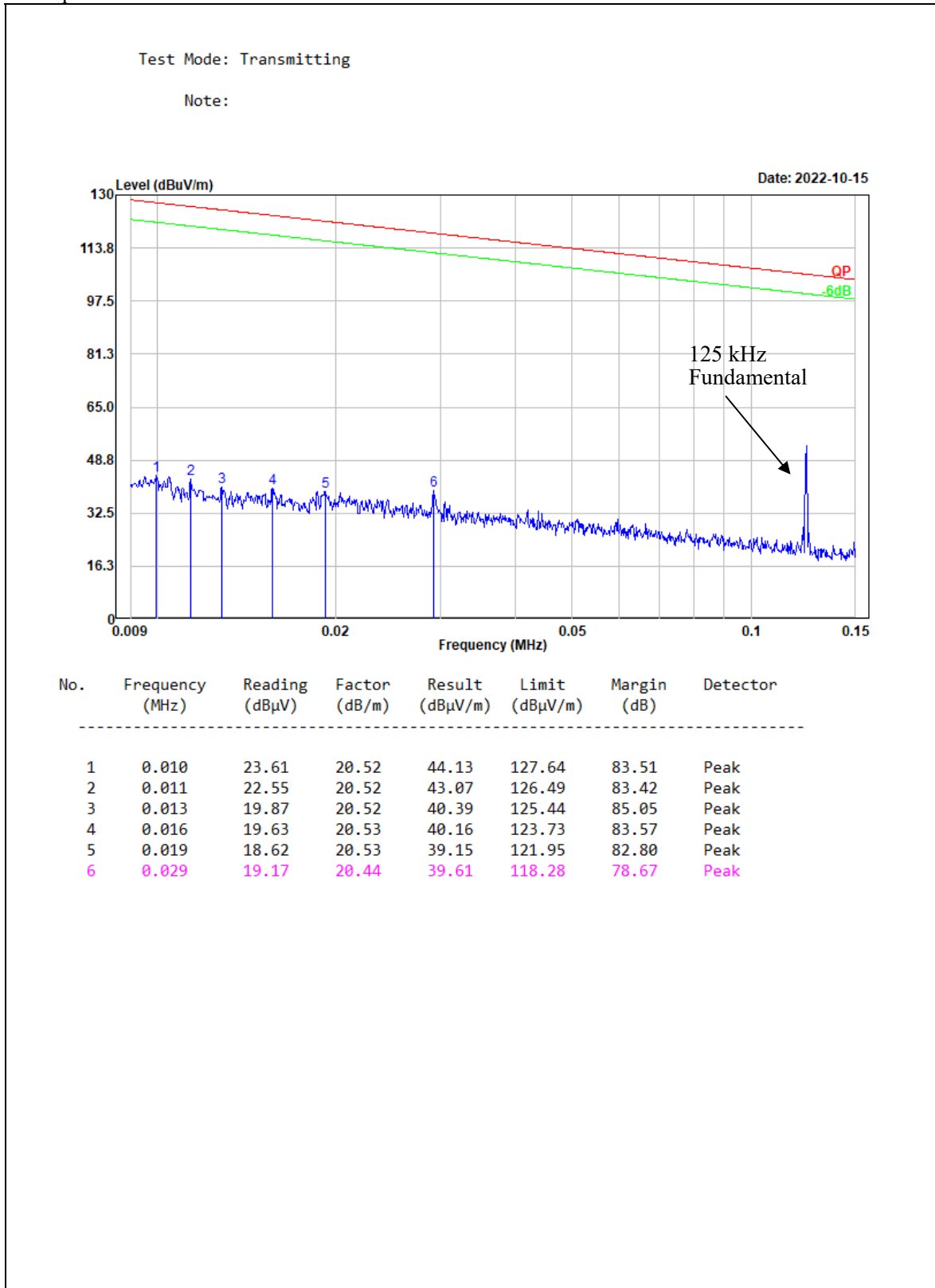



Test Mode: Transmitting

Note:

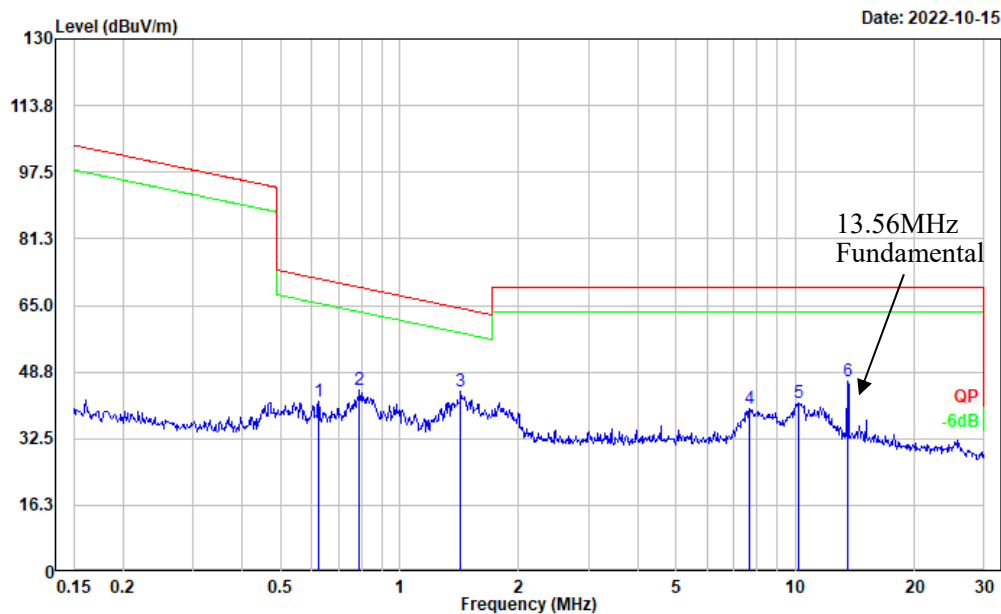

No.	Frequency (MHz)	Reading (dBμV)	Factor (dB/m)	Result (dBμV/m)	Limit (dBμV/m)	Margin (dB)	Detector
1	0.624	21.42	20.09	41.51	71.66	30.15	Peak
2	0.792	24.16	20.10	44.26	69.54	25.28	Peak
3	1.426	24.15	20.04	44.19	64.32	20.13	Peak
4	7.646	19.43	20.22	39.65	69.54	29.89	Peak
5	10.179	20.64	20.41	41.05	69.54	28.49	Peak
6	13.551	26.06	20.52	46.58	69.54	22.96	Peak

Test Mode: Transmitting

Note:

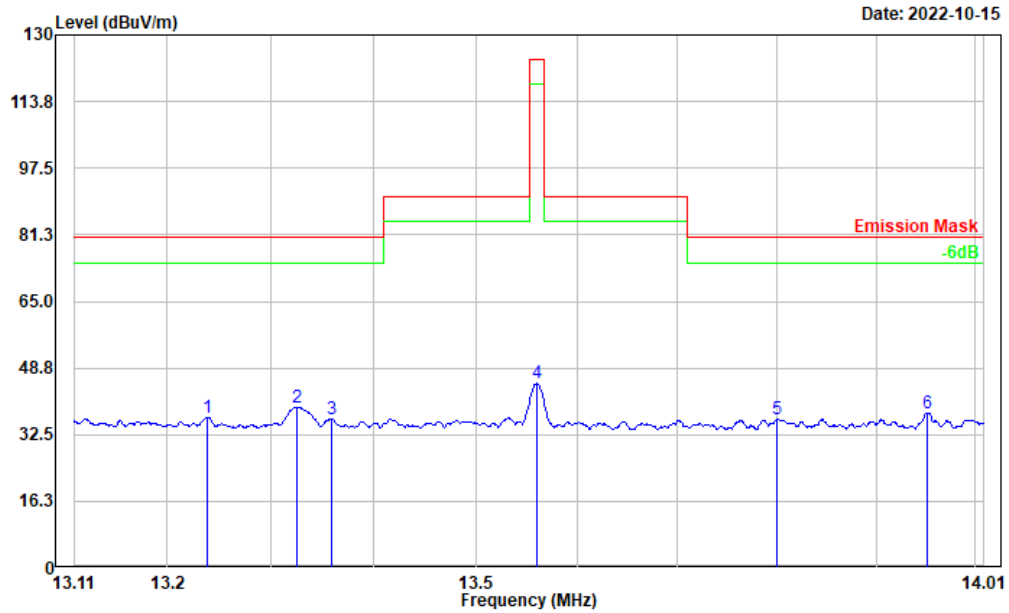

No.	Frequency (MHz)	Reading (dBμV)	Factor (dB/m)	Result (dBμV/m)	Limit (dBμV/m)	Margin (dB)	Detector
1	13.239	16.14	20.50	36.64	80.51	43.87	Peak
2	13.325	18.68	20.51	39.19	80.51	41.32	Peak
3	13.358	15.91	20.51	36.42	80.51	44.09	Peak
4	13.560	24.51	20.52	45.03	124.00	78.97	Peak
5	13.800	15.69	20.53	36.22	80.51	44.29	Peak
6	13.952	17.30	20.53	37.83	80.51	42.68	Peak

POE Ground-parallel:

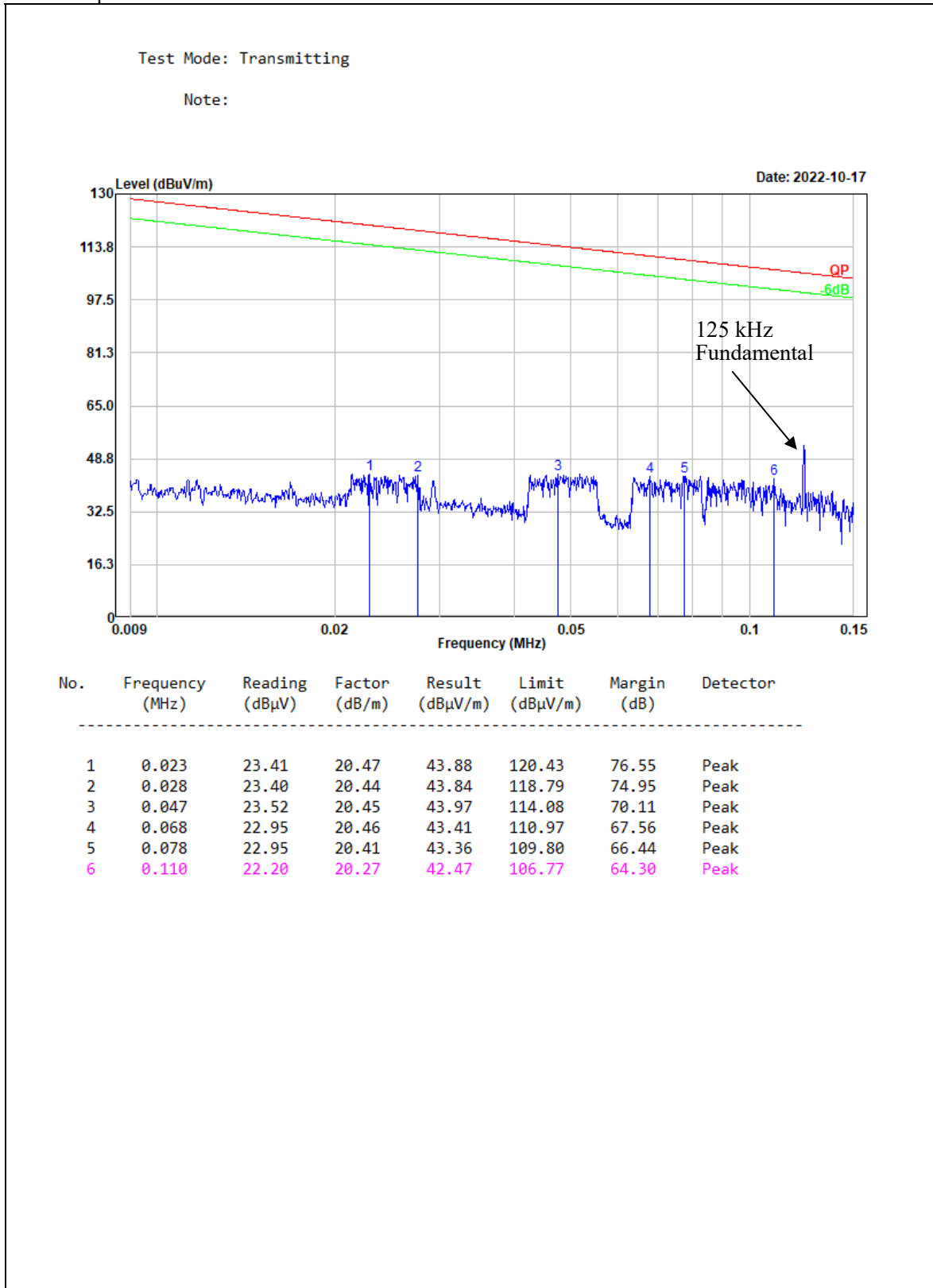

Test Mode: Transmitting

Note:

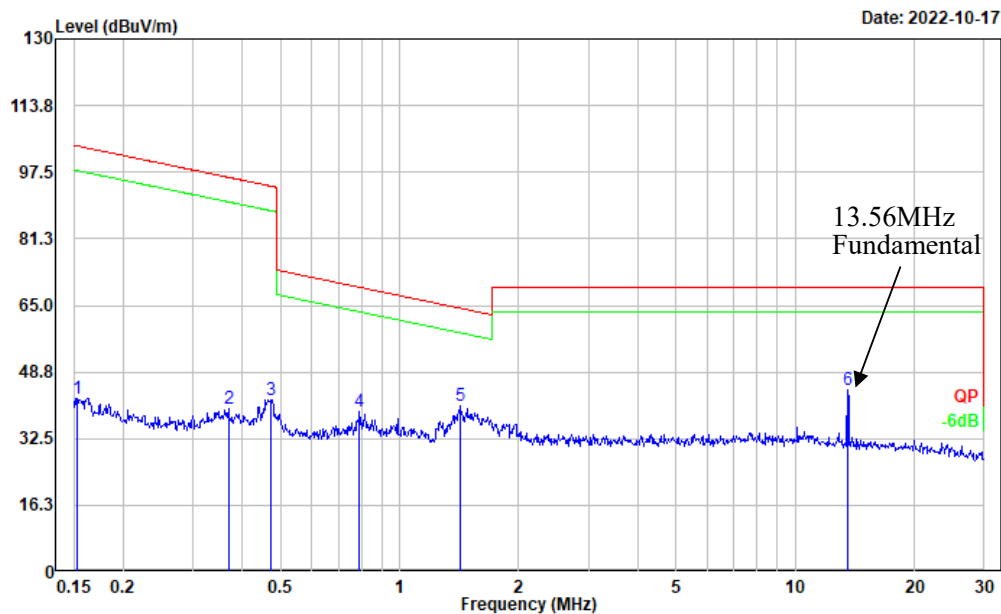

No.	Frequency (MHz)	Reading (dBμV)	Factor (dB/m)	Result (dBμV/m)	Limit (dBμV/m)	Margin (dB)	Detector
1	0.153	22.14	20.27	42.41	103.90	61.49	Peak
2	0.369	19.72	20.15	39.87	96.26	56.39	Peak
3	0.474	21.87	20.10	41.97	94.10	52.13	Peak
4	0.792	18.96	20.10	39.06	69.54	30.48	Peak
5	1.426	20.51	20.04	40.55	64.33	23.78	Peak
6	13.551	23.83	20.52	44.35	69.54	25.19	Peak

Test Mode: Transmitting

Note:

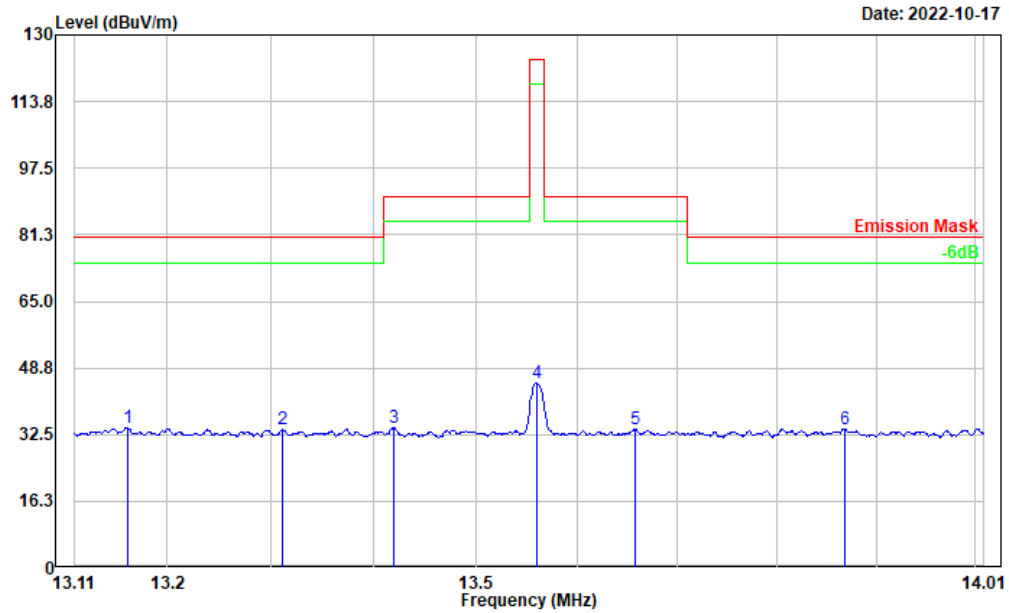

Date: 2022-10-17

No.	Frequency (MHz)	Reading (dBμV)	Factor (dB/m)	Result (dBμV/m)	Limit (dBμV/m)	Margin (dB)	Detector
1	13.161	13.74	20.50	34.24	80.51	46.27	Peak
2	13.312	13.16	20.51	33.67	80.51	46.84	Peak
3	13.420	13.63	20.51	34.14	90.47	56.33	Peak
4	13.560	24.53	20.52	45.05	124.00	78.95	Peak
5	13.658	13.24	20.52	33.76	90.47	56.71	Peak
6	13.868	13.37	20.53	33.90	80.51	46.61	Peak

2) 30 MHz~1GHz

POE:

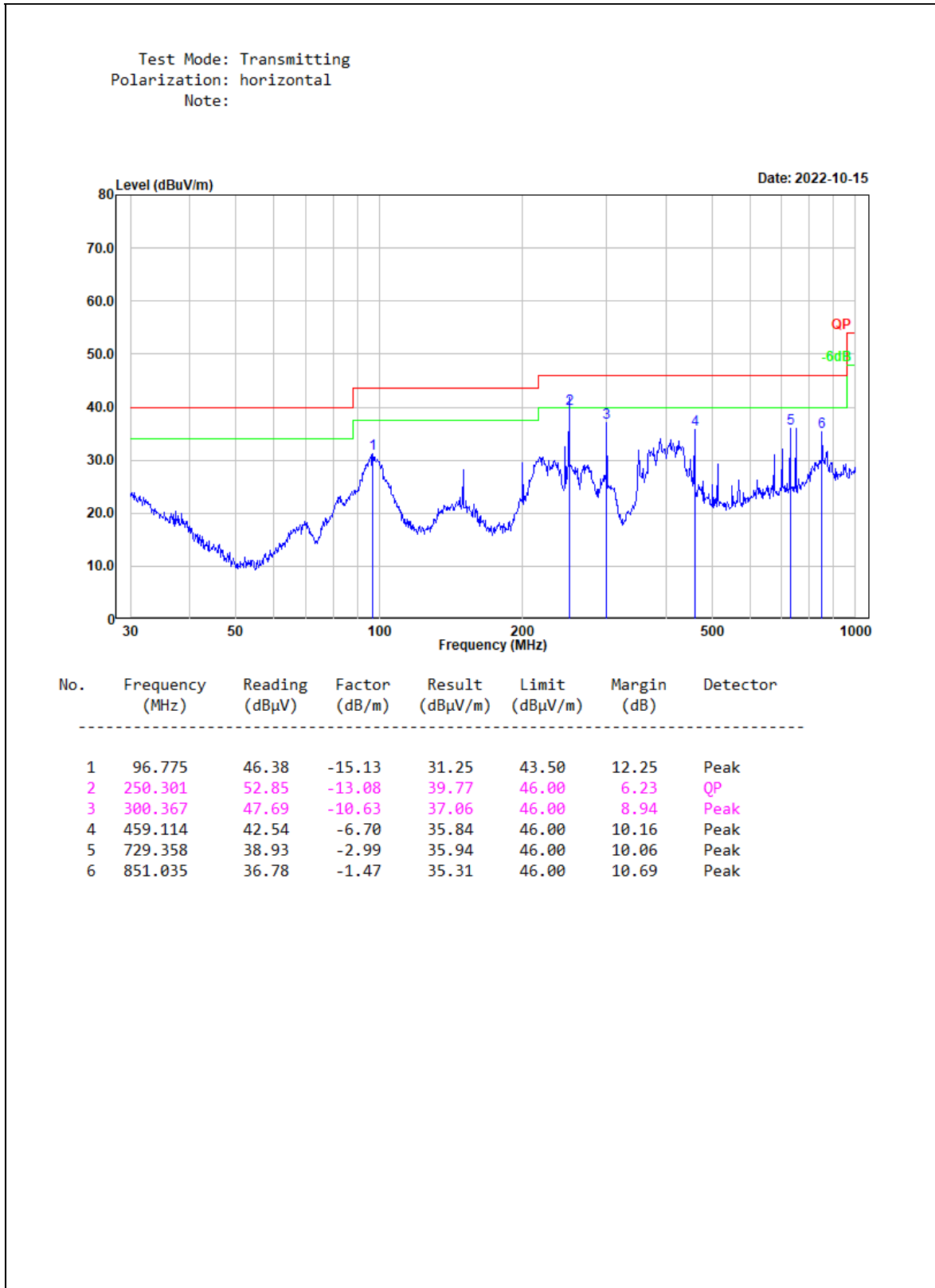

Test Mode: Transmitting  
 Polarization: vertical  
 Note:

Date: 2022-10-15

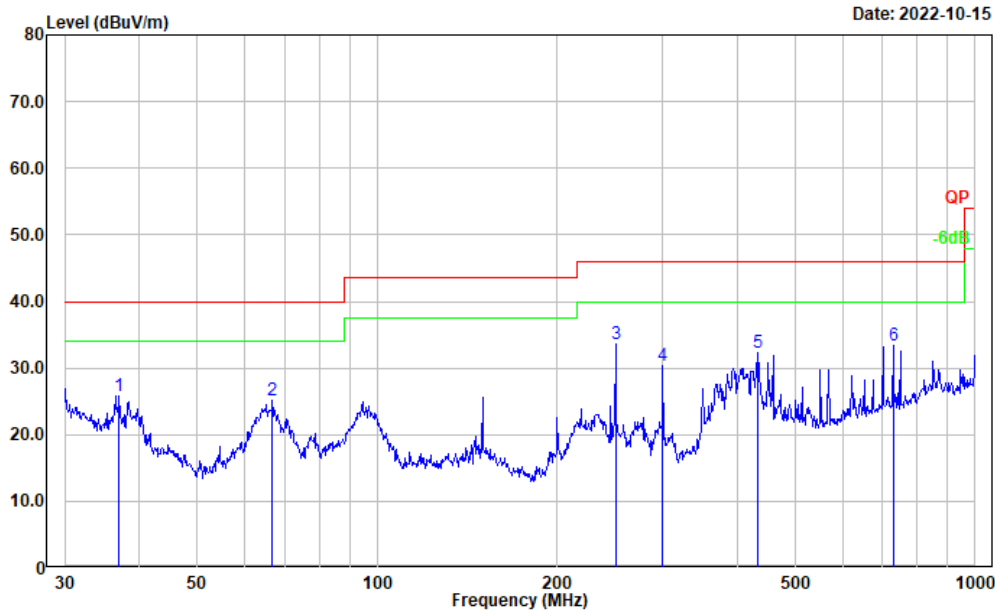

No.	Frequency (MHz)	Reading (dB $\mu$ V)	Factor (dB/m)	Result (dB $\mu$ V/m)	Limit (dB $\mu$ V/m)	Margin (dB)	Detector
1	37.025	34.84	-9.03	25.81	40.00	14.19	Peak
2	66.733	41.97	-16.79	25.18	40.00	14.82	Peak
3	250.301	46.65	-13.08	33.57	46.00	12.43	Peak
4	300.367	40.94	-10.63	30.31	46.00	15.69	Peak
5	432.546	39.71	-7.42	32.29	46.00	13.71	Peak
6	729.358	36.38	-2.99	33.39	46.00	12.61	Peak

**4.3 20 dB Emission Bandwidth**

Serial Number:	CR220944127-RF-S1	Test Date:	2022/10/15
Test Site:	966-2	Test Mode:	Transmitting
Tester:	Carl Xue	Test Result:	Pass

**Environmental Conditions:**

Temperature: (°C)	26.7	Relative Humidity: (%)	46	ATM Pressure: (kPa)	100.5
----------------------	------	---------------------------	----	---------------------------	-------

**Test Equipment List and Details:**

Manufacturer	Description	Model	Serial Number	Calibration Date	Calibration Due Date
TESEQ	HF Loop Antenna	HLA6120	33561	2021/02/03	2024/02/02
R&S	EMI Test Receiver	ESR3	102724	2022/07/15	2023/07/14
TIMES MICROWAVE	Coaxial Cable	LMR-600-UltraFlex	C-0470-02	2022/07/17	2023/07/16
TIMES MICROWAVE	Coaxial Cable	LMR-600-UltraFlex	C-0780-01	2022/07/17	2023/07/16
Audix	Test Software	E3	201021 (V9)	N/A	N/A

*\* Statement of Traceability: China Certification ICT Co., Ltd (Dongguan) attests that all calibrations have been performed, traceable to National Primary Standards and International System of Units (SI).*

**Test Data:**

Test Frequency (MHz)	20 dB Bandwidth (Hz)
13.56	1518



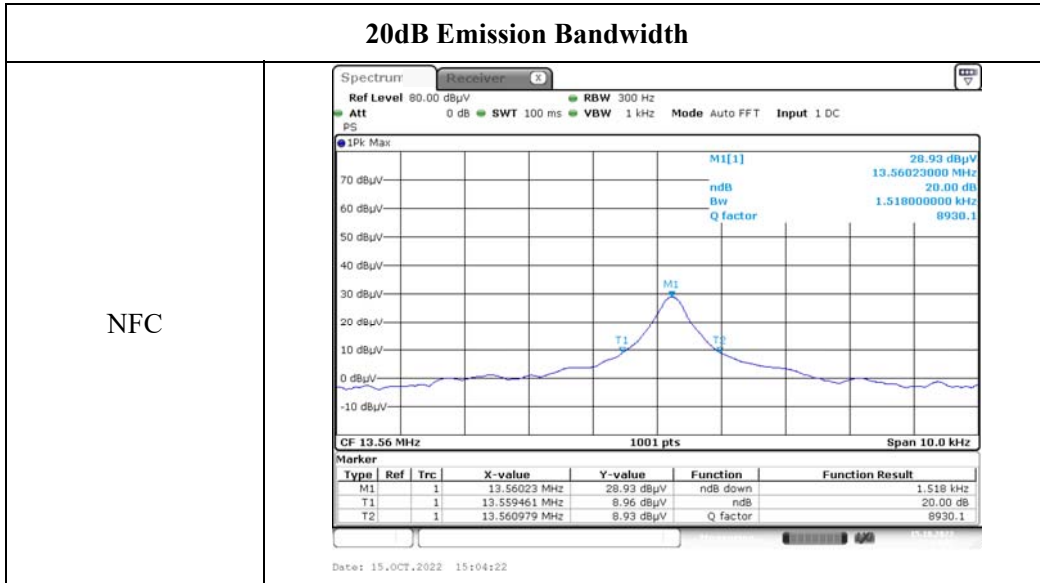

**4.4 Frequency Stability**

Serial Number:	CR220944127-RF-S1	Test Date:	2022/10/15
Test Site:	RF	Test Mode:	Transmitting
Tester:	Carl Xue	Test Result:	Pass

**Environmental Conditions:**

Temperature: (°C)	26.1	Relative Humidity: (%)	48	ATM Pressure: (kPa)	100.5
----------------------	------	---------------------------	----	---------------------------	-------

**Test Equipment List and Details:**

Manufacturer	Description	Model	Serial Number	Calibration Date	Calibration Due Date
TESEQ	HF Loop Antenna	HLA6120	33561	2021/02/03	2024/02/02
R&S	EMI Test Receiver	ESR3	102724	2022/07/15	2023/07/14
BACL	TEMP&HUMI Test Chamber	BTH-150-40	30174	2022/04/06	2023/04/05
YINSAIGE	Coaxial Cable	SS402	SJ0300001	Each time	N/A
UNI-T	Multimeter	UT39A+	C210582554	2022/09/29	2023/09/28
ZHAOXIN	DC Power Supply	RXN-6010D	21R6010D0912386	N/A	N/A

\* **Statement of Traceability:** China Certification ICT Co., Ltd (Dongguan) attests that all calibrations have been performed, traceable to National Primary Standards and International System of Units (SI).

**Test Data:****DC 12V:**

<b><math>f_0 = 13.56 \text{ MHz}</math></b>				
Temperature	Voltage	Measured frequency	Frequency Error	Limit
°C	V <sub>DC</sub>	MHz	Hz	Hz
-20	12	13.5602188	218.8	±1356
-10		13.5602503	250.3	±1356
0		13.5602374	237.4	±1356
10		13.5602441	244.1	±1356
20		13.5602300	230.0	±1356
25		13.5602231	223.1	±1356
30		13.5602614	261.4	±1356
40		13.5602550	255.0	±1356
50		13.5602297	229.7	±1356
20		10.2	13.5602349	234.9
20	13.8	13.5602420	242.0	±1356

**Test Data:**  
**DC 48V:**

<b><math>f_0 = 13.56</math> MHz</b>				
<b>Temperature</b>	<b>Voltage</b>	<b>Measured frequency</b>	<b>Frequency Error</b>	<b>Limit</b>
<b>°C</b>	<b>V<sub>DC</sub></b>	<b>MHz</b>	<b>Hz</b>	<b>Hz</b>
-20	48	13.5601508	150.8	±1356
-10		13.5603032	303.2	±1356
0		13.5602073	207.3	±1356
10		13.5602553	255.3	±1356
20		13.5602250	225.0	±1356
25		13.5602350	235.0	±1356
30		13.5603208	320.8	±1356
40		13.5601792	179.2	±1356
50		13.5603138	313.8	±1356
20		40.8	13.5602637	263.7
20	55.2	13.5602993	299.3	±1356

===== END OF REPORT =====