



SETUP PHOTOS REPORT

Report Number : R12453250-EP1

Applicant : Tosibox Oy
Teknologiantie 12A
90590 OULU
FINLAND

Model : Lock 500, Lock 500iC

FCC ID : 2AHCNLOCK500I

IC : 25009-LOCK500IC

EUT Description : Remote access device with wireless router functionality

Test Standard(s) : FCC 47 CFR PART 15 SUBPART C
ISED RSS-247 ISSUE 2
ISED RSS-GEN ISSUE 5

Date Of Issue:

2019-09-04

Prepared by:

UL LLC

12 Laboratory Dr.

Research Triangle Park, NC 27709 USA

Tel: (919) 549-1400



NVLAP Lab code: 200246-0

REPORT REVISION HISTORY

Ver.	Issue Date	Revisions	Revised By
1	2019-08-30	Initial Issue	Brian T. Kiewra
2	2019-09-04	Updated IDs	Niklas Haydon

TABLE OF CONTENTS

REPORT REVISION HISTORY	2
TABLE OF CONTENTS	3
1. DESCRIPTION OF TEST SETUP.....	4
2. SETUP PHOTOS.....	6
END OF TEST REPORT	13

1. DESCRIPTION OF TEST SETUP

SUPPORT EQUIPMENT

Support Equipment List				
Description	Manufacturer	Model	Serial Number	FCC ID
Laptop	Lenovo	T430	PB-C346V	N/A
Power Supply	Cool Power Solutions	ATS018T-W240V	NA	NA

I/O CABLES

I/O Cable List						
Cable No.	Port	# of Identical Ports	Connector Type	Cable Type	Cable Length (m)	Remarks
1	Ethernet	5	Ethernet	Unshielded	<3m	None
2	Power	1	Barrel	Power	<3m	None

SETUP DIAGRAM

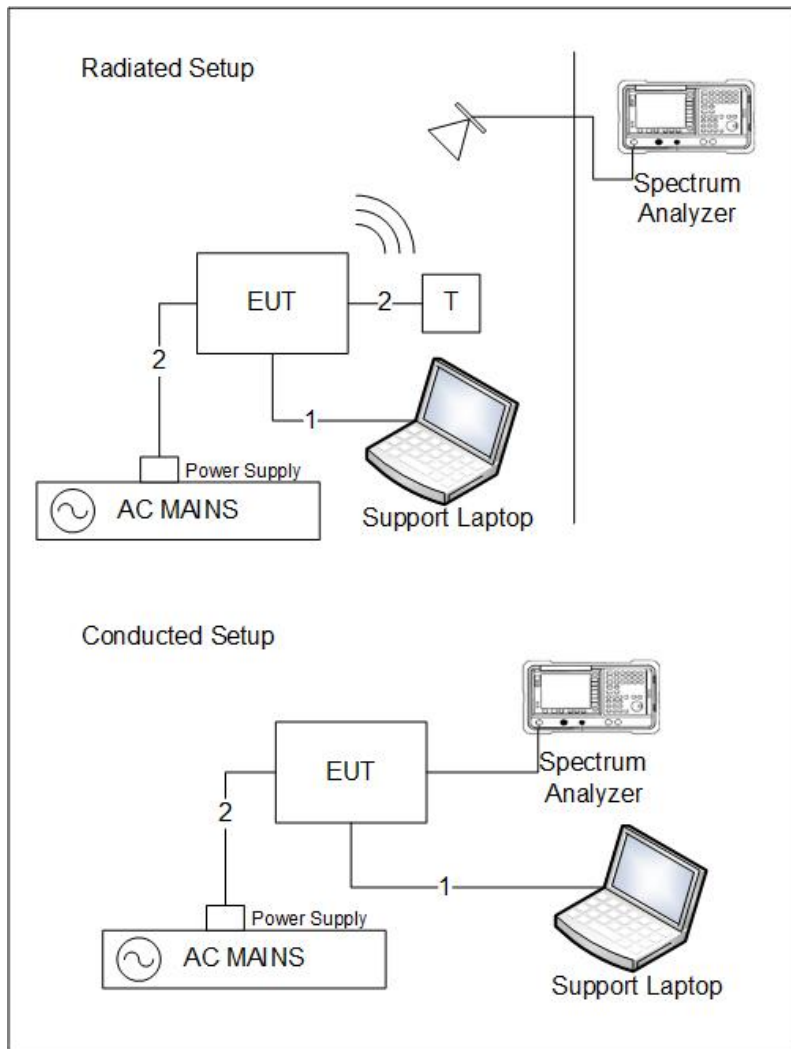

2. SETUP PHOTOS

RF CONDUCTED MEASUREMENT AT ANTENNA PORT

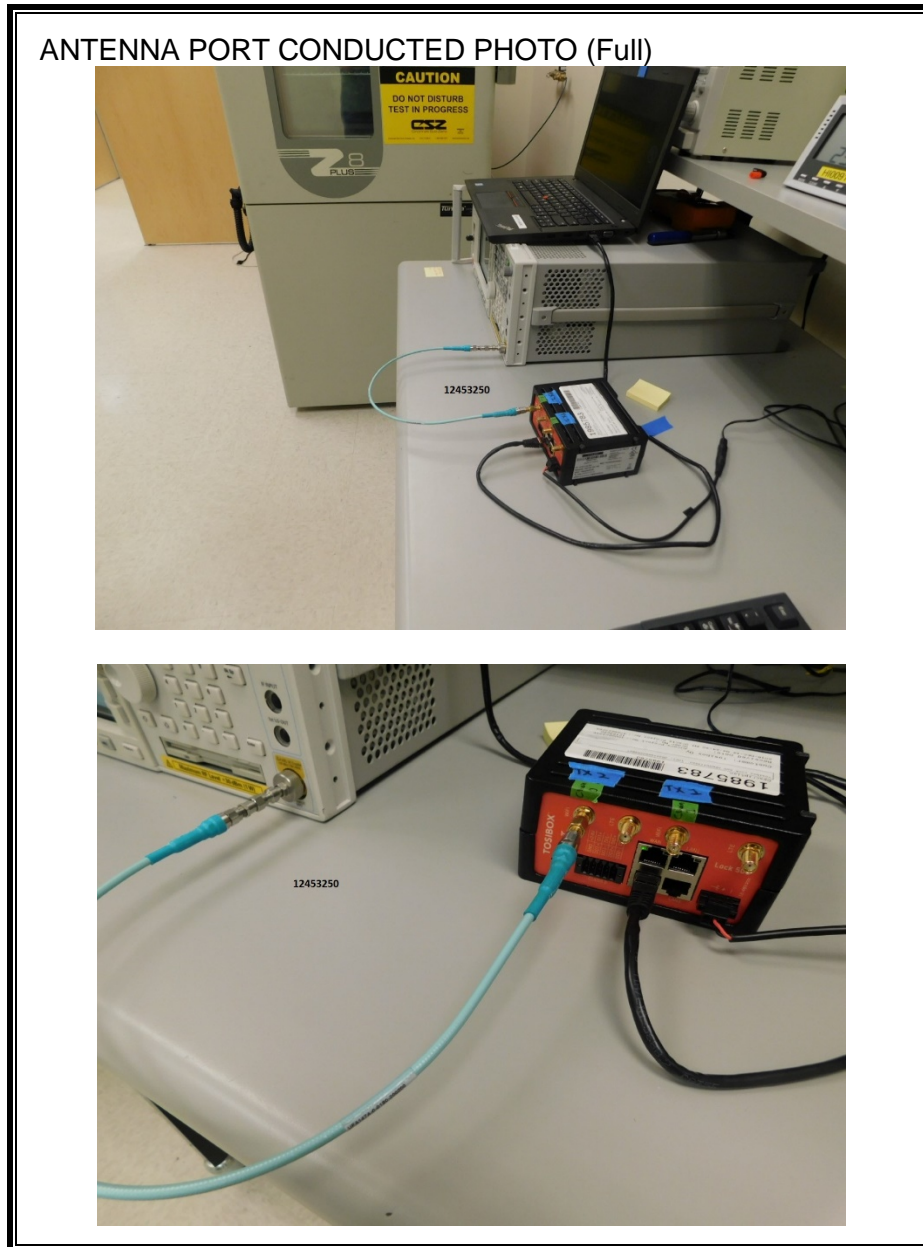

RADIATED EMISSIONS MEASUREMENT



Radiated Emissions >1GHz, Chain 0

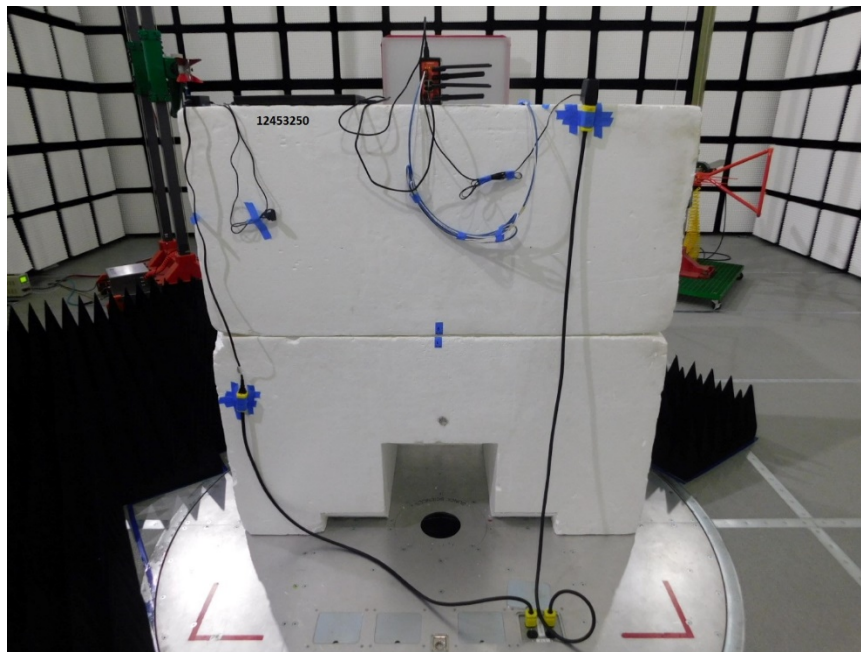

Radiated Emissions >1GHz, Chain 1

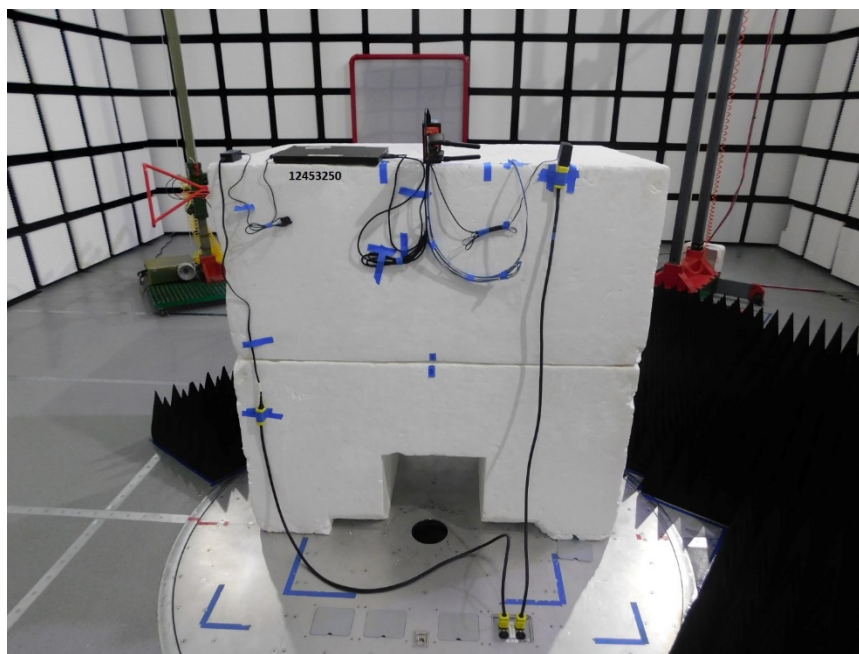
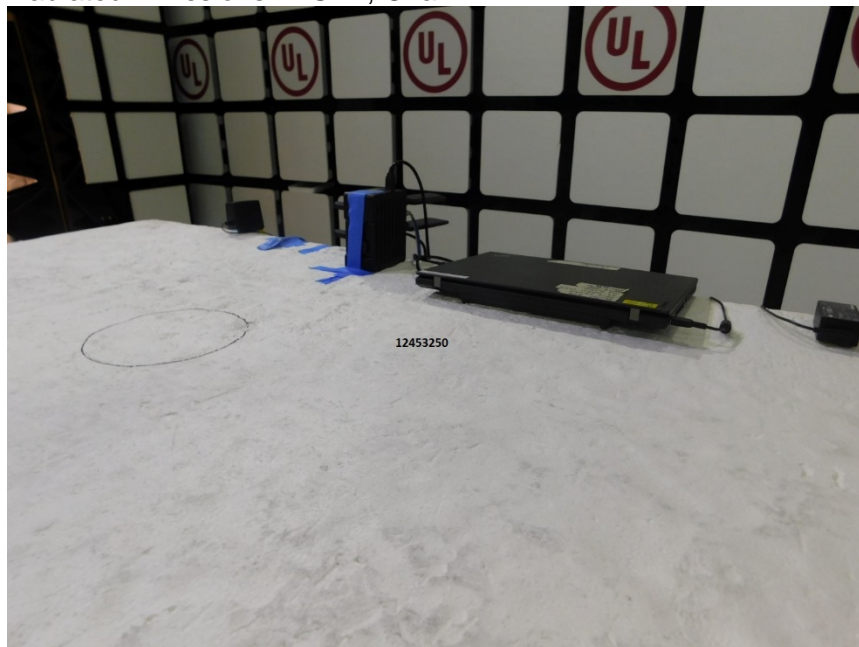

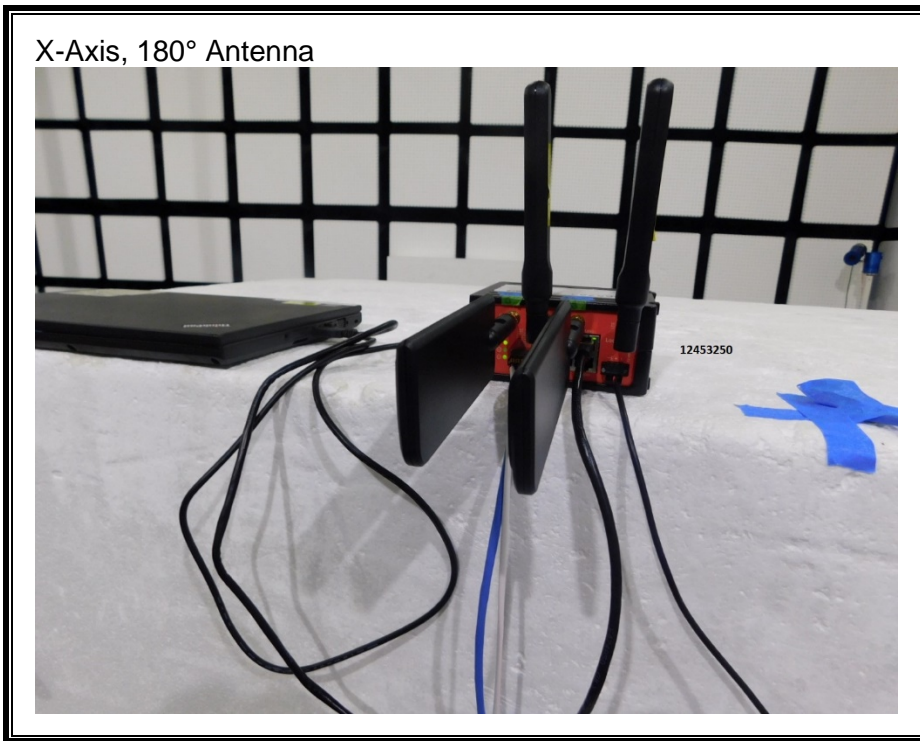
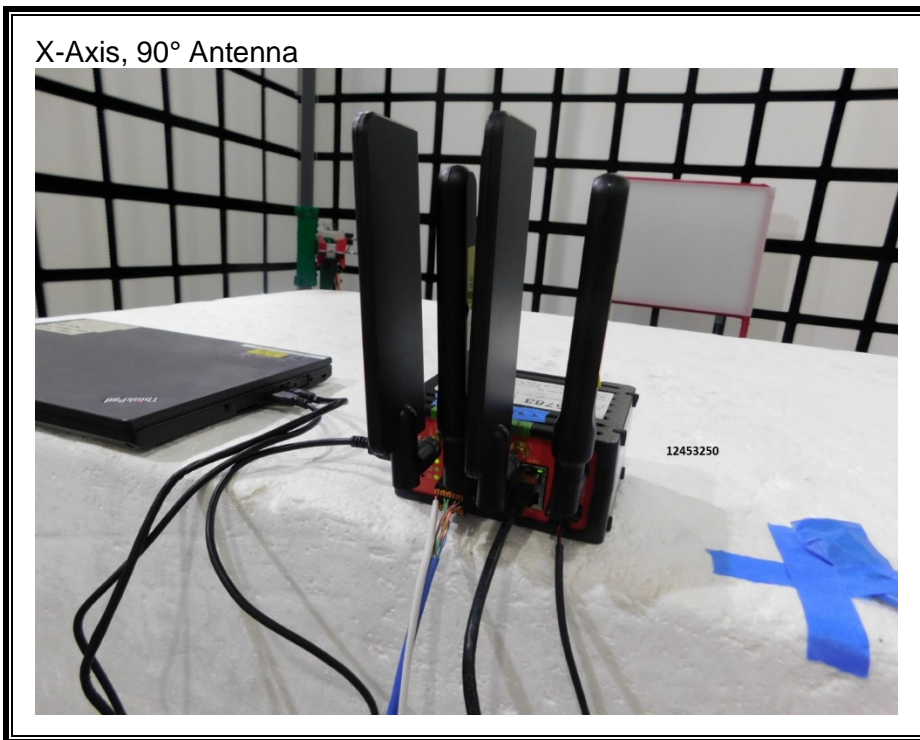

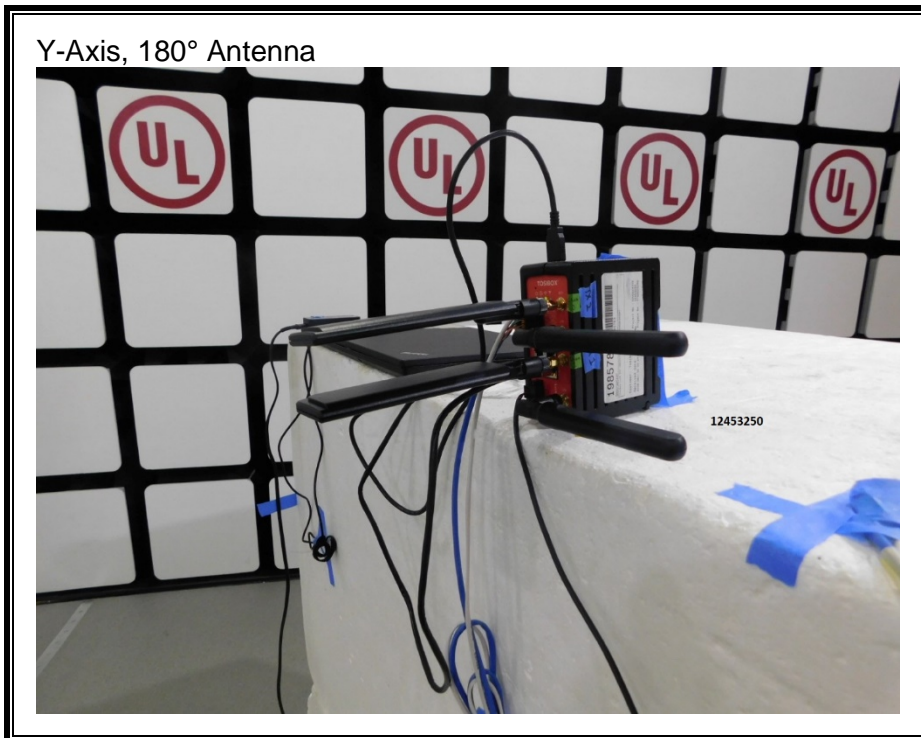
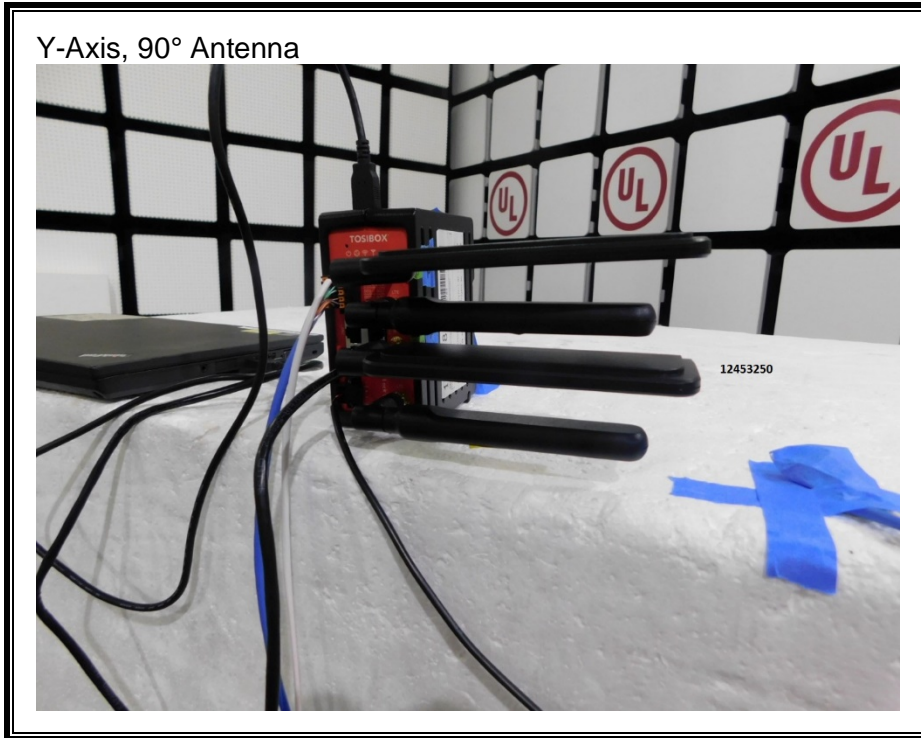

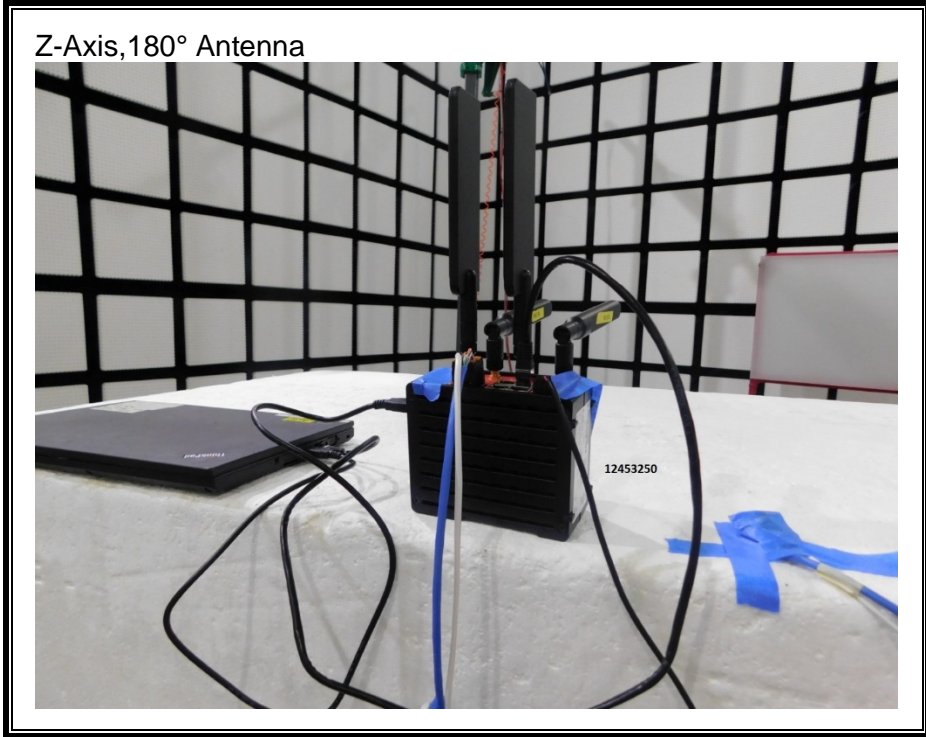
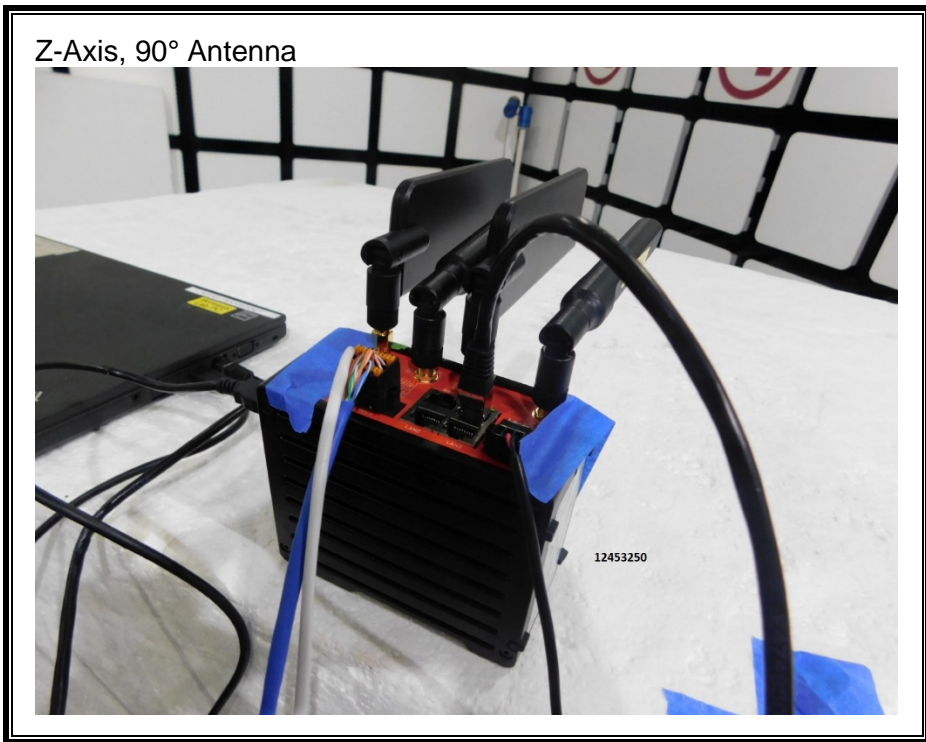

AC MAINS EMISSIONS MEASUREMENT

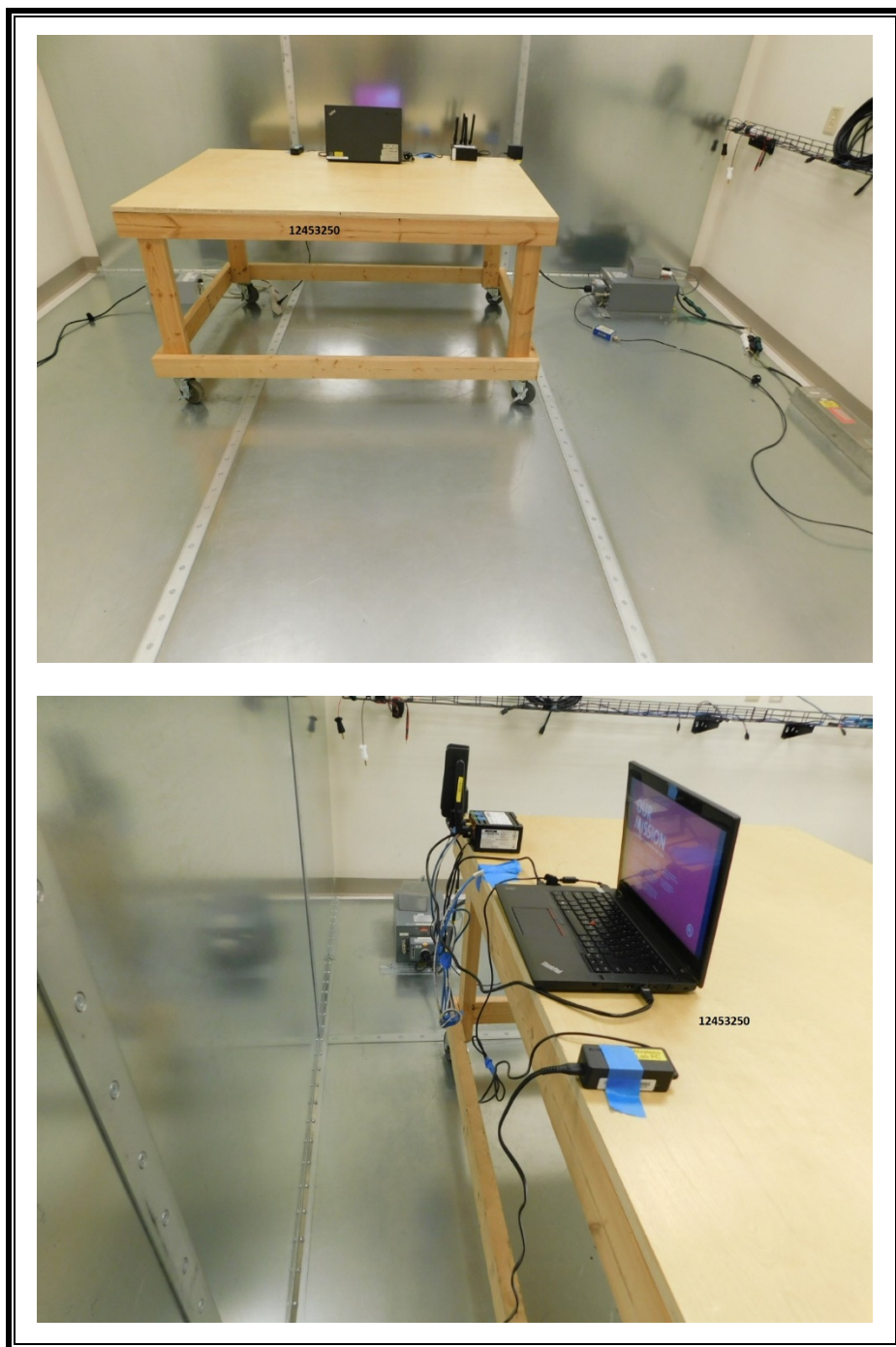

END OF TEST REPORT