



FCC Part 15C Test Report

FCC ID: 2AHCADV6000W

Product Name:	Action Camera
Trademark:	N/A
Model Name :	DV6000W DV4000W
Prepared For :	Transtyle Electronics Co., Ltd
Address :	Building #1, Dabuxiang industrial area, Guanlan Town, Longhua district, Shenzhen City, Guangdong province, China
Prepared By :	Shenzhen BCTC Technology Co., Ltd.
Address :	No.101, Yousong Road, Longhua New District, Shenzhen, China
Test Date:	Jan. 16 - Jan. 25, 2016
Date of Report :	Jan. 26, 2016
Report No.:	BCTC-160100527E

**Table of Contents**

	Page
1 . SUMMARY OF TEST RESULTS	5
1.1 TEST FACILITY	6
1.2 MEASUREMENT UNCERTAINTY	6
2 . GENERAL INFORMATION	7
2.1 GENERAL DESCRIPTION OF EUT	7
2.2 DESCRIPTION OF TEST MODES	8
2.3 BLOCK DIGRAM SHOWING THE CONFIGURATION OF SYSTEM TESTED	9
2.4 DESCRIPTION OF SUPPORT UNITS(CONDUCTED MODE)	9
2.5 EQUIPMENTS LIST FOR ALL TEST ITEMS	10
3 . EMC EMISSION TEST	11
3.1 CONDUCTED EMISSION MEASUREMENT	11
3.1.1 POWER LINE CONDUCTED EMISSION LIMITS	11
3.1.2 TEST PROCEDURE	11
3.1.3 DEVIATION FROM TEST STANDARD	11
3.1.4 TEST SETUP	12
3.1.5 EUT OPERATING CONDITIONS	12
3.1.6 TEST RESULTS	13
3.2 RADIATED EMISSION MEASUREMENT	15
3.2.1 RADIATED EMISSION LIMITS	15
3.2.2 TEST PROCEDURE	16
3.2.3 DEVIATION FROM TEST STANDARD	16
3.2.4 TEST SETUP	16
3.2.5 EUT OPERATING CONDITIONS	17
3.2.6 TEST RESULTS (BETWEEN 9KHZ – 30 MHZ)	18
3.2.7 TEST RESULTS (BETWEEN 30MHZ – 1GHZ)	19
3.2.8 TEST RESULTS (1GHZ~25GHZ)	21
4 . POWER SPECTRAL DENSITY TEST	25
4.1 APPLIED PROCEDURES / LIMIT	25
4.1.1 TEST PROCEDURE	25
4.1.2 DEVIATION FROM STANDARD	25
4.1.3 TEST SETUP	25
4.1.4 EUT OPERATION CONDITIONS	25
4.1.5 TEST RESULTS	26



Table of Contents	Page
5 . BANDWIDTH TEST	34
5.1 APPLIED PROCEDURES / LIMIT	34
5.1.1 TEST PROCEDURE	34
5.1.2 DEVIATION FROM STANDARD	34
5.1.3 TEST SETUP	34
5.1.4 EUT OPERATION CONDITIONS	34
5.1.5 TEST RESULTS	35
6 . PEAK OUTPUT POWER TEST	43
6.1 APPLIED PROCEDURES / LIMIT	43
6.1.1 TEST PROCEDURE	43
6.1.2 DEVIATION FROM STANDARD	43
6.1.3 TEST SETUP	43
6.1.4 EUT OPERATION CONDITIONS	43
6.1.5 TEST RESULTS	44
7 . 100 KHZ BANDWIDTH OF FREQUENCY BAND EDGE	45
7.1 DEVIATION FROM STANDARD	45
7.2 TEST SETUP	45
7.3 EUT OPERATION CONDITIONS	46
7.4 TEST RESULTS	46
8 . ANTENNA REQUIREMENT	51
8.1 STANDARD REQUIREMENT	51
8.2 EUT ANTENNA	51
9 . EUT TEST PHOTO	52
10 . EUT PHOTO	54
APPENDIX-PHOTOGRAPHS OF EUT CONSTRUCTIONAL DETAILS	



1. SUMMARY OF TEST RESULTS

Test procedures according to the technical standards:

FCC Part15 (15.247) , Subpart C			
Standard Section	Test Item	Judgment	Remark
15.207	Conducted Emission	PASS	
15.247 (a)(2)	6dB Bandwidth	PASS	
15.247 (b)	Peak Output Power	PASS	
15.247 (c)	Radiated Spurious Emission	PASS	
15.247 (d)	Power Spectral Density	PASS	
15.205	Band Edge Emission	PASS	
15.203	Antenna Requirement	PASS	

NOTE:

(1) "N/A" denotes test is not applicable in this Test Report



1.1 TEST FACILITY

Shenzhen BCTC Technology Co., Ltd.

Add. : No.101,Yousong Road,Longhua New District, Shenzhen,China

FCC Registered No.: 187086

1.2 MEASUREMENT UNCERTAINTY

The reported uncertainty of measurement $y \pm U$, where expanded uncertainty U is based on a standard uncertainty multiplied by a coverage factor of $k=2$, providing a level of confidence of approximately **95 %**.

No.	Item	Uncertainty
1	Conducted Emission Test	$\pm 1.38\text{dB}$
2	RF power,conducted	$\pm 0.16\text{dB}$
3	Spurious emissions,conducted	$\pm 0.21\text{dB}$
4	All emissions,radiated(<1G)	$\pm 4.68\text{dB}$
5	All emissions,radiated(>1G)	$\pm 4.89\text{dB}$
6	Temperature	$\pm 0.5^{\circ}\text{C}$
7	Humidity	$\pm 2\%$



2. GENERAL INFORMATION

2.1 GENERAL DESCRIPTION OF EUT

Equipment	Action Camera	
Trade Name	N/A	
Model Name	DV6000W DV4000W	
Model Difference	The product is different for model number and outlook color.	
Product Description	The EUT is a Action Camera	
	Operation Frequency:	802.11b/g/n20MHz:2412~2462 MHz 802.11n40MHz:2422~2452MHz
	Modulation Type:	OFDM/DSSS
	Bit Rate of Transmitter	802.11b:11/5.5/2/1 Mbps 802.11g:54/48/36/24/18/12/9/6Mbps 802.11n Up to 150Mbps
	Number Of Channel	802.11b/g/n20MHz:11 CH 802.11n40MHz:7CH
	Antenna type:	Internal antenna
	Antenna Gain (dBi)	1.4dbi
	Based on the application, features, or specification exhibited in User's Manual, the EUT is considered as an ITE/Computing Device. More details of EUT technical specification, please refer to the User's Manual.	
Channel List	Please refer to the Note 2.	
Battery	DC 3.7V DC 5V from PC	
Connecting I/O Port(s)	Please refer to the User's Manual	

Note:

1. For a more detailed features description, please refer to the manufacturer's specifications or the User's Manual.

2.

Channel List for 802.11b/g/n(20)							
Channel	Frequency (MHz)	Channel	Frequency (MHz)	Channel	Frequency (MHz)	Channel	Frequency (MHz)
01	2412	04	2427	07	2442	10	2457
02	2417	05	2432	08	2447	11	2462
03	2422	06	2437	09	2452		



Channel List for 802.11b/g/n(40)							
Channel	Frequency (MHz)	Channel	Frequency (MHz)	Channel	Frequency (MHz)	Channel	Frequency (MHz)
		04	2427	07	2442		
		05	2432	08	2447		
03	2422	06	2437	09	2452		

2.2 DESCRIPTION OF TEST MODES

To investigate the maximum EMI emission characteristics generates from EUT, the test system was pre-scanning tested base on the consideration of following EUT operation mode or test configuration mode which possible have effect on EMI emission level. Each of these EUT operation mode(s) or test configuration mode(s) mentioned above was evaluated respectively.

Pretest Mode	Description
Mode 1	802.11b CH1/ CH6/ CH11
Mode 2	802.11g CH1/ CH6/ CH11
Mode 3	802.11n20 CH1/ CH6/ CH11
Mode 4	802.11n40 CH3/ CH6/ CH9
Mode 5	Link Mode

For Conducted Emission	
Final Test Mode	Description
Mode 5	Link Mode

For Radiated Emission	
Final Test Mode	Description
Mode 1	802.11b CH1/ CH6/ CH11
Mode 2	802.11g CH1/ CH6/ CH11
Mode 3	802.11n20 CH1/ CH6/ CH11
Mode 4	802.11n40 CH3/ CH6/ CH9

Note:

- (1) The measurements are performed at the highest, middle, lowest available channels.
- (2) The measurements are performed at all Bit Rate of Transmitter, the worst data was reported



2.3 BLOCK DIGRAM SHOWING THE CONFIGURATION OF SYSTEM TESTED

Conducted Emission Test

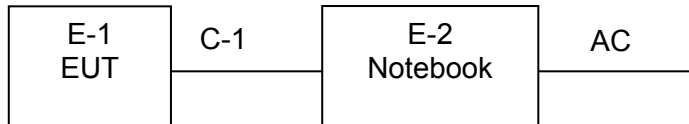

2.4 DESCRIPTION OF SUPPORT UNITS(CONDUCTED MODE)

The EUT has been tested as an independent unit toge^{AC} other necessary accessories or support units. The following support units or accessories were used to form a representative test configuration during the tests.

Item	Equipment	Mfr/Brand	Model/Type No.	Series No.	Note
E-1	Action Camera	N/A	DV6000W	N/A	EUT
E-2	Notebook	ASUS	A1580TW	N/A	

Item	Shielded Type	Ferrite Core	Length	Note
C1	NO	NO	0.8M	

Note:

- (1) The support equipment was authorized by Declaration of Confirmation.
- (2) For detachable type I/O cable should be specified the length in cm in 『Length』 column.



2.5 EQUIPMENTS LIST FOR ALL TEST ITEMS

Radiation Test equipment

Equipment	Manufacturer	Model#	Serial#	Last Cal.	Next Cal.
Spectrum Analyzer	Agilent	E4407B	MY4510804 0	2015.07.06	2016.07.05
Test Receiver	R&S	ESPI	101318	2015.07.06	2016.07.05
Bilog Antenna	R&S	VULB 9168	VULB91 68-438	2015.07.06	2016.07.05
50Ω Coaxial Switch	Anritsu	MP59B	620026441 6	2015.07.06	2016.07.05
Spectrum Analyzer	ADVANTEST	R3132	150900201	2015.07.06	2016.07.05
Horn Antenna	R&S	HF906	10027	2015.07.06	2016.07.05
Horn Ant	Schwarzbeck	BBHA 9170	9170-181	2015.07.06	2016.07.05
Amplifier	R&S	BBV9743	9743-01 9	2015.12.22	2016.12.21
Loop Antenna	ARA	PLA-1030/B	1029	2015.07.06	2016.07.05
RF cables	R&S	R203	R20X	2015.07.06	2016.07.05
Antenna connector	Florida RFLabs	Lab-Fle	RF 01#	2015.07.06	2016.07.05
Power Metter	ANRITSU	ML2487A	6K0000156 8	2015.07.06	2016.07.05
Power Sensor (AV)	ANRITSU	ML2491A	030989	2015.07.06	2016.07.05
Signal Analyzer	Agilent	N9010A	MY4803049 4	2015.07.06	2016.07.05

Conduction Test equipment

Equipment	Manufacturer	Model#	Serial#	Last Cal.	Next Cal.
843 Shielded Room	ChengYu	843 Room	843	Aug. 25, 2015	Aug. 24, 2016
EMI Receiver	R&S	ESCI	101421	Aug. 27, 2015	Aug. 26, 2016
LISN	Schwarzbeck	NSLK8127	8127739	Sep. 07, 2015	Sep. 06, 2016
Attenuator	R&S	ESH3-Z2	BCTC021E	Aug. 25, 2015	Aug. 24, 2016
843 Cable 1#	FUJIKURA	843C1#	001	Aug. 25, 2015	Aug. 24, 2016



3. EMC EMISSION TEST

3.1 CONDUCTED EMISSION MEASUREMENT

3.1.1 POWER LINE CONDUCTED EMISSION Limits (Frequency Range 150KHz-30MHz)

FREQUENCY (MHz)	Class B (dBuV)		Standard
	Quasi -peak	Average	
0.15 -0.5	66 - 56 *	56 - 46 *	FCC
0.50 -5.0	56.00	46.00	FCC
5.0 -30.0	60.00	50.00	FCC

Note:

- (1) The tighter limit applies at the band edges.
- (2) The limit of " * " marked band means the limitation decreases linearly with the logarithm of the frequency in the range.

The following table is the setting of the receiver

Receiver Parameters	Setting
Attenuation	10 dB
Start Frequency	0.15 MHz
Stop Frequency	30 MHz
IF Bandwidth	9 kHz

3.1.2 TEST PROCEDURE

- a. The EUT was placed 0.8 meters from the horizontal ground plane with EUT being connected to the power mains through a line impedance stabilization network (LISN). All other support equipments powered from additional LISN(s). The LISN provide 50 Ohm/ 50uH of coupling impedance for the measuring instrument.
- b. Interconnecting cables that hang closer than 40 cm to the ground plane shall be folded back and forth in the center forming a bundle 30 to 40 cm long.
- c. I/O cables that are not connected to a peripheral shall be bundled in the center. The end of the cable may be terminated, if required, using the correct terminating impedance. The overall length shall not exceed 1 m.
- d. LISN at least 80 cm from nearest part of EUT chassis.
- e. For the actual test configuration, please refer to the related Item –EUT Test Photos.

3.1.3 DEVIATION FROM TEST STANDARD

No deviation

3.1.4 TEST SETUP

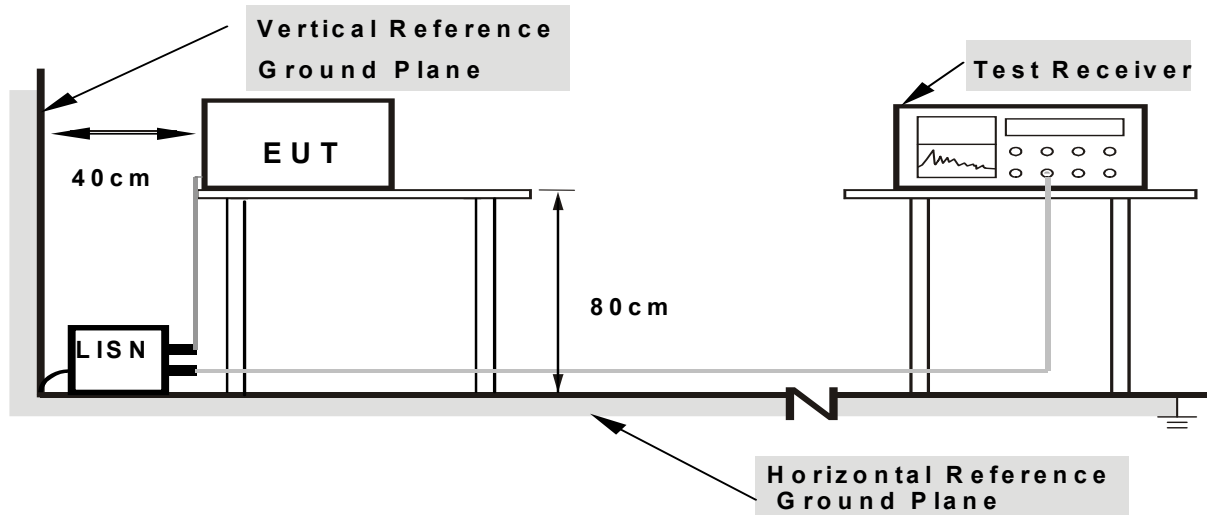

Note: 1. Support units were connected to second LISN.

2. Both of LISNs (AMN) are 80 cm from EUT and at least 80 cm from other units and other metal planes

3.1.5 EUT OPERATING CONDITIONS

The EUT was configured for testing in a typical fashion (as a customer would normally use it). The EUT has been programmed to continuously transmit during test. This operating condition was tested and used to collect the included data.

We pretest AC 120V and AC 240V, the worst voltage was AC 120V and the data recording in the report.



3.1.6 TEST RESULTS

EUT :	Action Camera	Model Name. :	DV6000W
Temperature :	26°C	Relative Humidity :	54%
Pressure :	1010hPa	Phase :	L
Test Voltage :	DC 5V from PC	Test Mode :	Mode 5

No.	Mk.	Freq.	Reading Level	Correct Factor	Measurement	Limit	Over	Detector	Comment
		MHz	dBuV	dB	dBuV	dBuV	dB		
1		0.1580	24.62	10.05	34.67	65.56	-30.89	QP	
2		0.1580	11.12	10.05	21.17	55.56	-34.39	AVG	
3		0.3300	26.29	10.10	36.39	59.45	-23.06	QP	
4		0.3300	18.06	10.10	28.16	49.45	-21.29	AVG	
5		0.5620	21.05	10.12	31.17	56.00	-24.83	QP	
6		0.5620	6.88	10.12	17.00	46.00	-29.00	AVG	
7		5.5660	16.72	10.12	26.84	60.00	-33.16	QP	
8		5.5660	5.33	10.12	15.45	50.00	-34.55	AVG	
9		9.9860	26.71	10.12	36.83	60.00	-23.17	QP	
10		9.9860	9.35	10.12	19.47	50.00	-30.53	AVG	
11	*	16.7340	29.21	10.16	39.37	60.00	-20.63	QP	
12		16.7340	15.98	10.16	26.14	50.00	-23.86	AVG	

Remark:

1. All readings are Quasi-Peak and Average values.
2. Factor = Insertion Loss + Cable Loss.

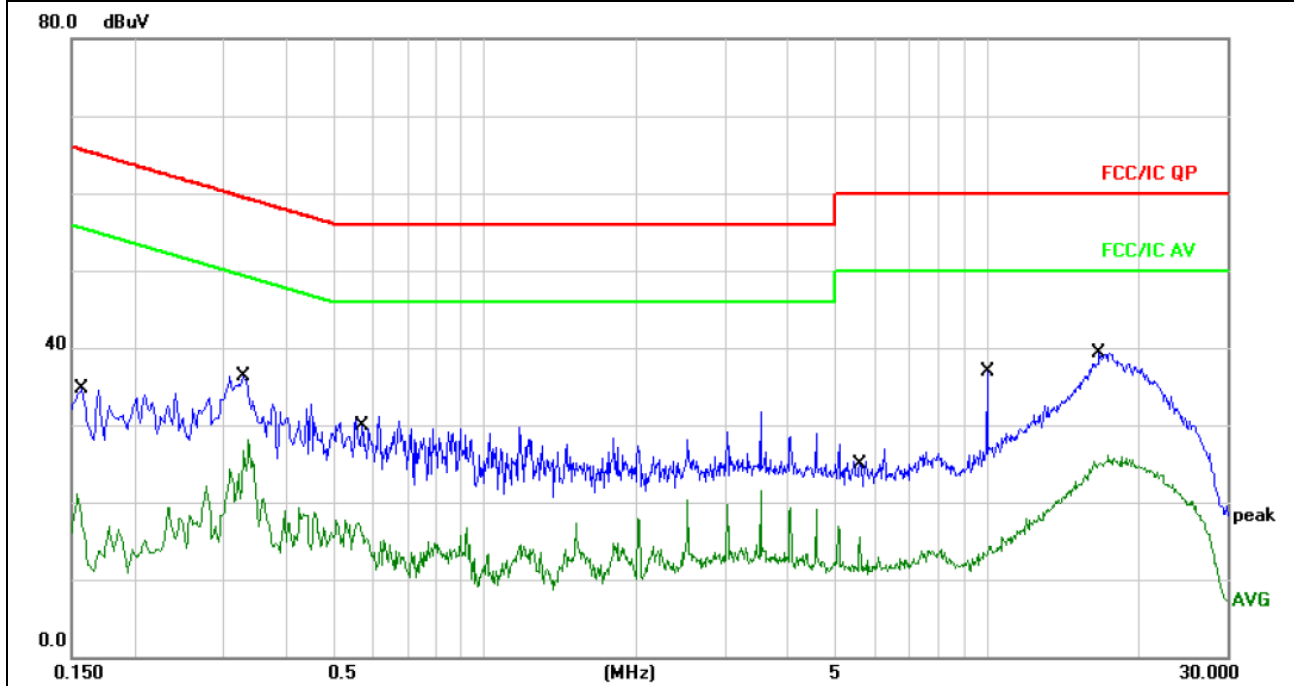



EUT :	Action Camera	Model Name. :	DV6000W
Temperature :	26°C	Relative Humidity :	54%
Pressure :	1010hPa	Phase :	N
Test Voltage :	DC 5V from PC	Test Mode :	Mode 5

No.	Mk.	Freq.	Reading Level	Correct Factor	Measurement	Limit	Over	Detector	Comment
		MHz	dBuV	dB	dBuV	dBuV	dB		
1		0.3392	27.82	10.10	37.92	59.22	-21.30	QP	
2	*	0.3392	22.50	10.10	32.60	49.22	-16.62	AVG	
3		0.8020	22.30	10.15	32.45	56.00	-23.55	QP	
4		0.8020	10.10	10.15	20.25	46.00	-25.75	AVG	
5		1.7660	19.50	10.18	29.68	56.00	-26.32	QP	
6		1.7660	8.61	10.18	18.79	46.00	-27.21	AVG	
7		4.0460	16.17	10.16	26.33	56.00	-29.67	QP	
8		4.0460	5.37	10.16	15.53	46.00	-30.47	AVG	
9		17.2820	29.34	10.16	39.50	60.00	-20.50	QP	
10		17.2820	13.55	10.16	23.71	50.00	-26.29	AVG	
11		24.6500	20.53	10.20	30.73	60.00	-29.27	QP	
12		24.6500	8.78	10.20	18.98	50.00	-31.02	AVG	

Remark:

1. All readings are Quasi-Peak and Average values.
2. Factor = Insertion Loss + Cable Loss.

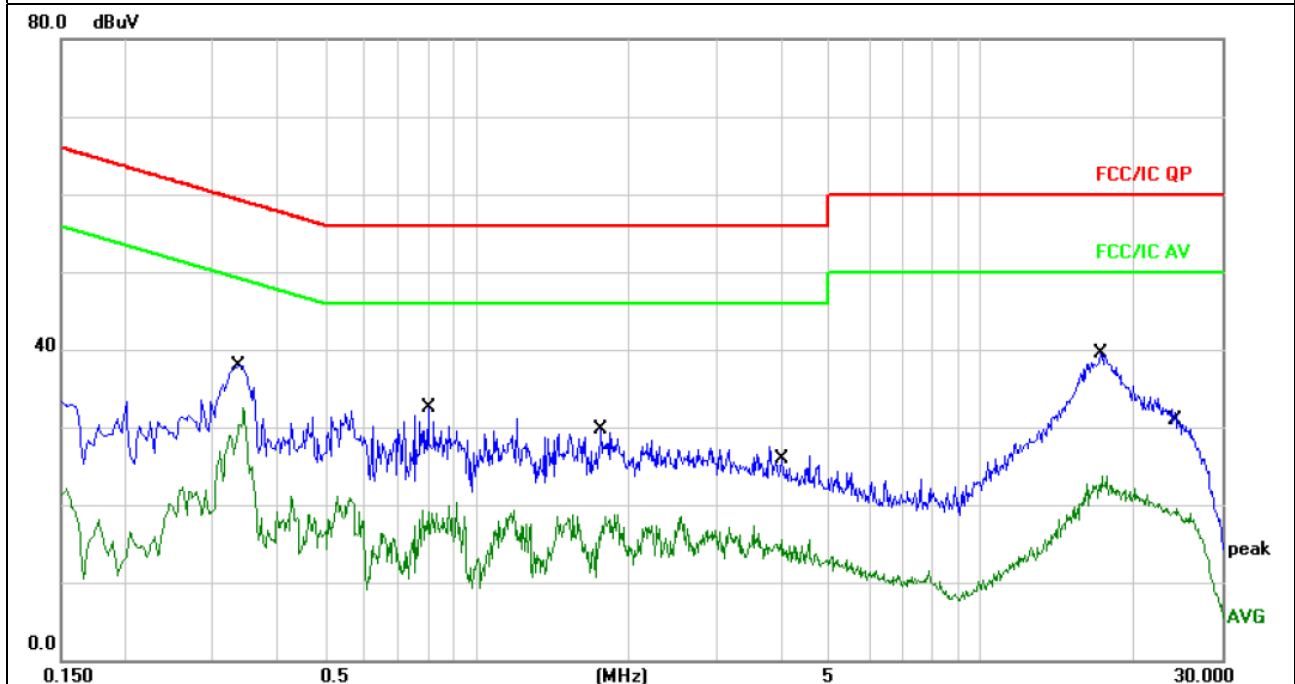



3.2 RADIATED EMISSION MEASUREMENT

3.2.1 RADIATED EMISSION LIMITS (Frequency Range 9kHz-1000MHz)

20dBc in any 100 kHz bandwidth outside the operating frequency band. In case the emission fall within the restricted band specified on 15.205(a), then the 15.209(a) limit in the table below has to be followed.

Frequencies (MHz)	Field Strength (micorvolts/meter)	Measurement Distance (meters)
0.009~0.490	2400/F(KHz)	300
0.490~1.705	24000/F(KHz)	30
1.705~30.0	30	30
30~88	100	3
88~216	150	3
216~960	200	3
Above 960	500	3

LIMITS OF RADIATED EMISSION MEASUREMENT (Above 1000MHz)

FREQUENCY (MHz)	Class B (dBuV/m) (at 3M)	
	PEAK	AVERAGE
Above 1000	74	54

Notes:

- (1) The limit for radiated test was performed according to FCC PART 15C.
- (2) The tighter limit applies at the band edges.
- (3) Emission level (dBuV/m)=20log Emission level (uV/m).

Spectrum Parameter	Setting
Attenuation	Auto
Start Frequency	1000 MHz
Stop Frequency	25GHz
RB / VB (emission in restricted band)	1 MHz / 1 MHz for Peak, 1 MHz / 10Hz for Average

Receiver Parameter	Setting
Attenuation	Auto
Start ~ Stop Frequency	9kHz~150kHz / RB 200Hz for QP
Start ~ Stop Frequency	150kHz~30MHz / RB 9kHz for QP
Start ~ Stop Frequency	30MHz~1000MHz / RB 120kHz for QP

3.2.2 TEST PROCEDURE

- a. The measuring distance of at 3 m shall be used for measurements at frequency up to 1GHz. For frequencies above 1GHz, any suitable measuring distance may be used.
- b. The EUT was placed on the top of a rotating table 0.8 meters above the ground at a 3 meter open area test site. The table was rotated 360 degrees to determine the position of the highest radiation.
- c. The height of the equipment or of the substitution antenna shall be 0.8 m; the height of the test antenna shall vary between 1 m to 4 m. Both horizontal and vertical polarizations of the antenna are set to make the measurement.
- d. The initial step in collecting conducted emission data is a spectrum analyzer peak detector mode pre-scanning the measurement frequency range. Significant peaks are then marked and then Quasi Peak detector mode re-measured.
- e. If the Peak Mode measured value compliance with and lower than Quasi Peak Mode Limit, the EUT shall be deemed to meet QP Limits and then no additional QP Mode measurement performed.
- f. For the actual test configuration, please refer to the related Item –EUT Test Photos.

Note:

Both horizontal and vertical antenna polarities were tested and performed pretest to three orthogonal axis. The worst case emissions were reported We pretest AC 120V and AC 240V, the worst voltage was AC 120V and the data recording in the report.

3.2.3 DEVIATION FROM TEST STANDARD

No deviation

3.2.4 TEST SETUP

(A) Radiated Emission Test-Up Frequency Below 30MHz

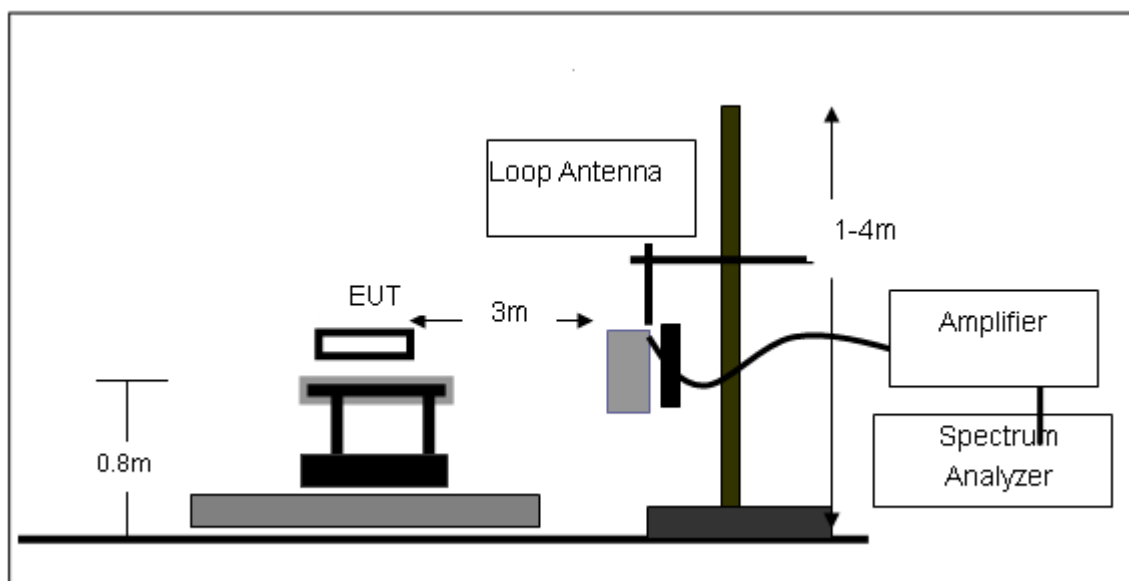

(B) Radiated Emission Test-Up Frequency 30MHz~1GHz

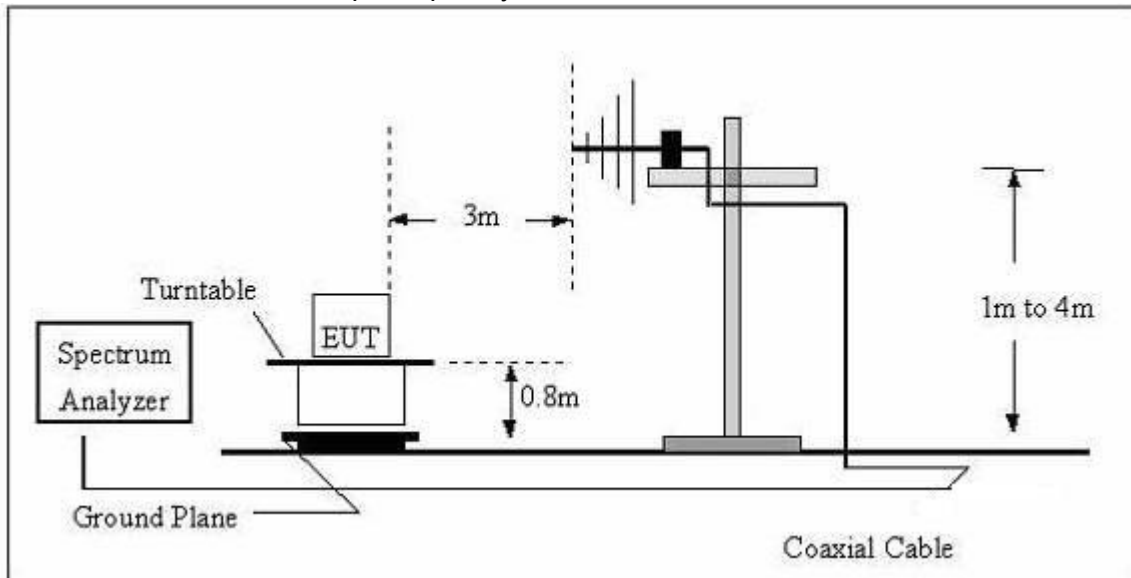

(C) Radiated Emission Test-Up Frequency Above 1GHz

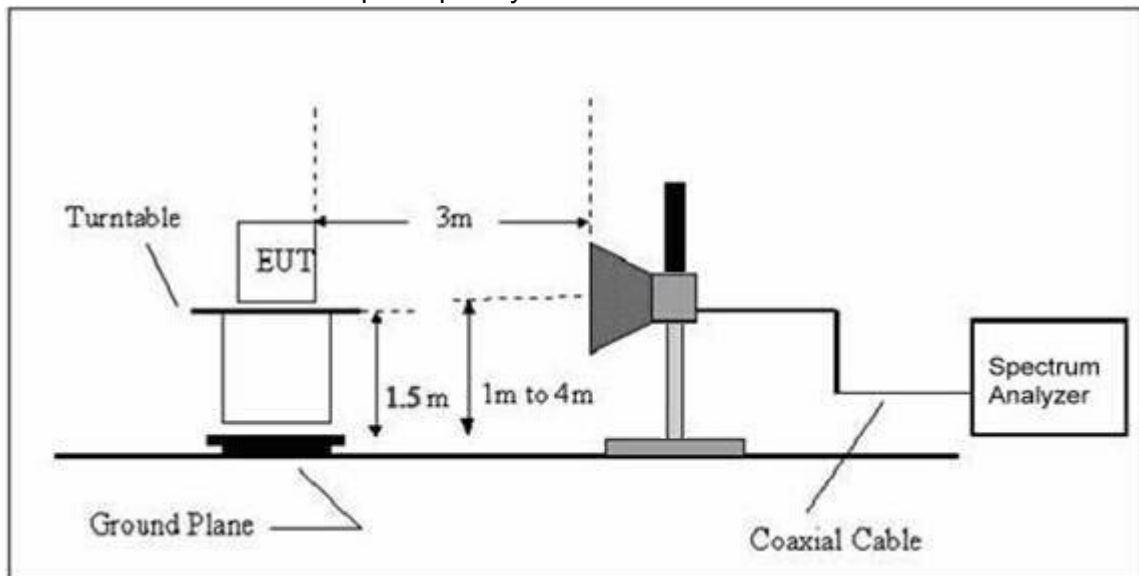

3.2.5 EUT OPERATING CONDITIONS

The EUT tested system was configured as the statements of 2.4 Unless otherwise a special operating condition is specified in the follows during the testing.

**3.2.6 TEST RESULTS (BETWEEN 9KHZ – 30 MHZ)**

EUT:	Action Camera	Model Name. :	DV6000W
Temperature:	20°C	Relative Humidity:	48%
Pressure:	1010 hPa	Test Voltage :	DC 5V from PC
Test Mode :	Mode 5	Polarization :	--

Freq. (MHz)	Reading (dBuV/m)	Limit (dBuV/m)	Margin (dB)	State P/F
--	--	--	--	PASS
--	--	--	--	PASS

NOTE:

The amplitude of spurious emissions which are attenuated by more than 20dB below the permissible value has no need to be reported.

Distance extrapolation factor = $40 \log(\text{specific distance}/\text{test distance})$ (dB);

Limit line = specific limits(dBuv) + distance extrapolation factor.



3.2.7 TEST RESULTS (BETWEEN 30MHZ – 1GHZ)

EUT :	Action Camera	Model Name :	DV6000W
Temperature :	26°C	Relative Humidity :	54%
Pressure :	1010 hPa	Polarization :	Horizontal
Test Voltage :	DC 5V from PC		
Test Mode :	Mode 5		

No.	Mk.	Freq.	Reading Level	Correct Factor	Measurement	Limit	Over	Antenna Height	Table Degree	
		MHz	dBuV	dB/m	dBuV/m	dBuV/m	dB	cm	degree	Comment
1	*	49.8600	47.50	-10.27	37.23	40.00	-2.77	QP		
2		64.3869	46.15	-12.39	33.76	40.00	-6.24	QP		
3		80.8270	49.33	-18.09	31.24	40.00	-8.76	QP		
4	!	199.6870	54.70	-16.18	38.52	43.50	-4.98	QP		
5	!	250.1670	56.28	-14.20	42.08	46.00	-3.92	QP		
6		651.8670	42.77	-5.06	37.71	46.00	-8.29	QP		

Remark:

Factor = Antenna Factor + Cable Loss – Pre-amplifier.

All interfaces was connected, and BT TX mode was link.

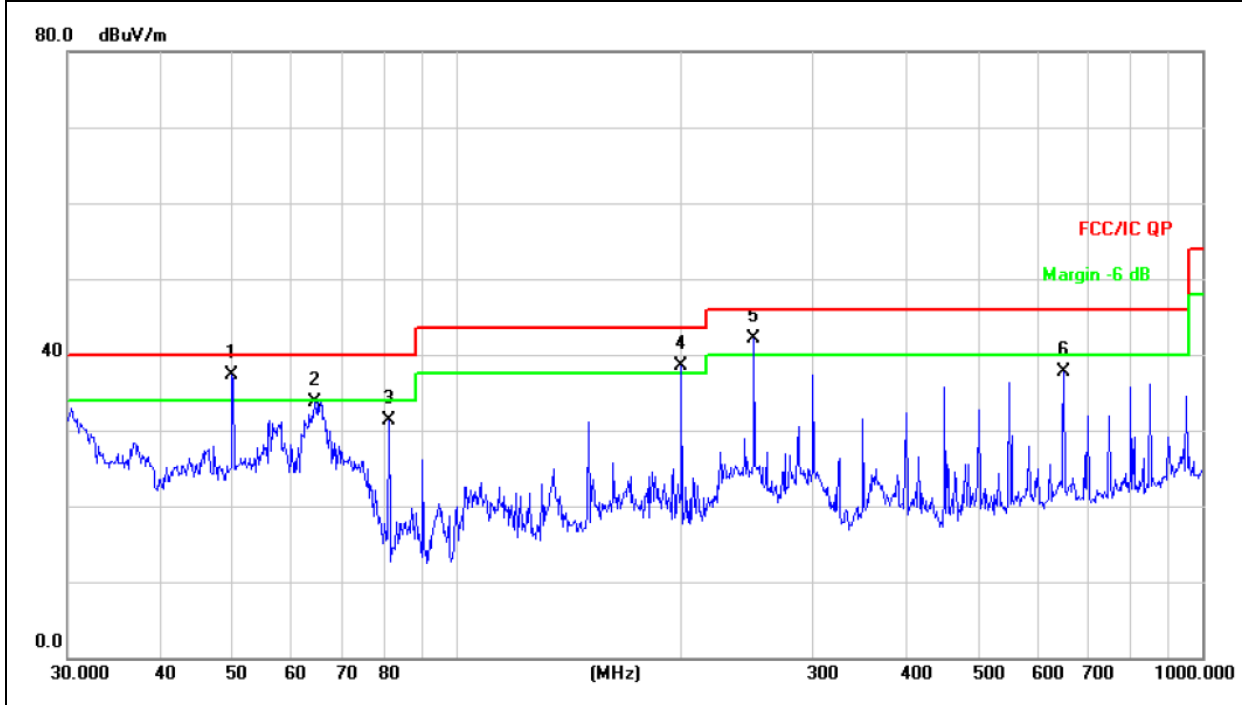



EUT :	Action Camera	Model Name :	DV6000W
Temperature :	26°C	Relative Humidity :	54%
Pressure :	1010 hPa	Polarization :	Vertical
Test Voltage :	DC 5V from PC		
Test Mode :	Mode 5		

No.	Mk.	Freq.	Reading Level	Correct Factor	Measurement	Limit	Over	Antenna Height	Table Degree	
		MHz	dBuV	dB/m	dBuV/m	dBuV/m	dB	cm	degree	Comment
1	!	199.8760	56.54	-16.19	40.35	43.50	-3.15			QP
2	!	250.1380	55.98	-14.20	41.78	46.00	-4.22			QP
3	*	300.1270	55.53	-12.58	42.95	46.00	-3.05			QP
4	!	450.9670	49.89	-9.00	40.89	46.00	-5.11			QP
5	!	550.6780	49.31	-7.09	42.22	46.00	-3.78			QP
6	!	651.2540	47.62	-5.07	42.55	46.00	-3.45			QP

Remark:
 Factor = Antenna Factor + Cable Loss – Pre-amplifier.
 All interfaces was connected, and BT TX mode was link.

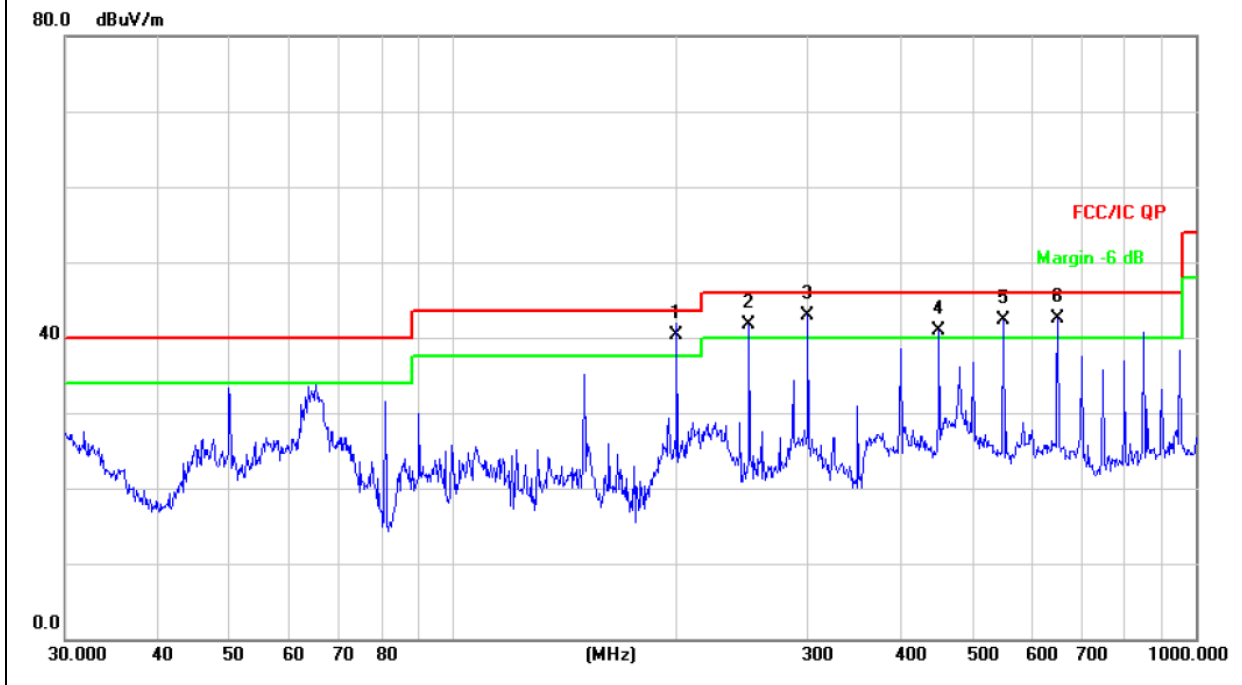



3.2.8 TEST RESULTS (1GHZ~25GHZ)

802.11b

Normal Voltage

Polar (H/V)	Frequency	Meter Reading	Factor	Emission Level	Limits	Margin	Detector Type
	(MHz)	(dBuV)	(dB)	(dBuV/m)	(dBuV/m)	(dB)	
operation frequency:2412							
V	4825.166	65.75	-3.64	62.11	74	-11.89	Pk
V	4825.166	47.27	-3.64	43.63	54	-10.37	AV
H	4825.215	65.26	-3.64	61.62	74	-12.38	Pk
H	4825.215	45.97	-3.64	42.33	54	-11.67	AV

Remark:

Absolute Level= ReadingLevel+ Factor, Margin= Limit- Absolute Level

802.11b

Normal Voltage

Polar (H/V)	Frequency	Meter Reading	Factor	Emission Level	Limits	Margin	Detector Type
	(MHz)	(dBuV)	(dB)	(dBuV/m)	(dBuV/m)	(dB)	
operation frequency:2437							
V	4876.053	63.52	-3.63	59.89	74	-14.11	Pk
V	4876.053	45.28	-3.63	41.65	54	-12.35	AV
H	4876.211	64.47	-3.64	60.83	74	-13.17	Pk
H	4876.211	44.95	-3.64	41.31	54	-12.69	AV

Remark:

Absolute Level= ReadingLevel+ Factor, Margin= Limit- Absolute Level

802.11b

Normal Voltage

Polar (H/V)	Frequency	Meter Reading	Factor	Emission Level	Limits	Margin	Detector Type
	(MHz)	(dBuV)	(dB)	(dBuV/m)	(dBuV/m)	(dB)	
operation frequency:2462							
V	4913.115	66.16	-3.64	62.52	74	-11.48	Pk
V	4913.115	48.13	-3.64	44.49	74	-9.51	AV
H	4912.732	64.94	-3.66	61.28	74	-12.72	Pk
H	4912.732	47.90	-3.66	44.24	54	-9.76	AV

Remark:

Absolute Level= ReadingLevel+ Factor, Margin= Limit- Absolute Level

Note: The amplitude of spurious emissions which are attenuated by more than 20dB below the permissible value has no need to be reported.



802.11g

Normal Voltage

Polar (H/V)	Frequency	Meter Reading	Factor	Emission Level	Limits	Margin	Detector Type
	(MHz)	(dBuV)	(dB)	(dBuV/m)	(dBuV/m)	(dB)	
operation frequency:2412							
V	4821.224	68.76	-3.6	65.16	74	-8.84	Pk
V	4821.224	46.85	-3.6	43.25	54	-10.75	AV
H	4821.527	66.91	-3.6	63.31	74	-10.69	Pk
H	4821.527	46.57	-3.6	42.97	54	-11.03	AV
Remark:							
Absolute Level= ReadingLevel+ Factor, Margin= Limit- Absolute Level							

802.11g

Normal Voltage

Polar (H/V)	Frequency	Meter Reading	Factor	Emission Level	Limits	Margin	Detector Type
	(MHz)	(dBuV)	(dB)	(dBuV/m)	(dBuV/m)	(dB)	
operation frequency:2437							
V	4874.354	66.26	-3.63	62.63	74	-11.37	Pk
V	4874.354	47.34	-3.63	43.71	54	-10.29	AV
H	4874.145	66.84	-3.64	63.20	74	-10.80	Pk
H	4874.145	46.45	-3.64	42.81	54	-11.19	AV
Remark:							
Absolute Level= ReadingLevel+ Factor, Margin= Limit- Absolute Level							

802.11g

Normal Voltage

Polar (H/V)	Frequency	Meter Reading	Factor	Emission Level	Limits	Margin	Detector Type
	(MHz)	(dBuV)	(dB)	(dBuV/m)	(dBuV/m)	(dB)	
operation frequency:2462							
V	4914.103	65.94	-3.62	62.32	74	-11.68	pk
V	4914.103	46.90	-3.62	43.28	54	-10.72	pk
H	4914.032	64.73	-3.62	61.11	74	-12.89	pk
H	4914.032	47.69	-3.62	44.07	54	-9.93	pk
Remark:							
Absolute Level= ReadingLevel+ Factor, Margin= Limit- Absolute Level							

Note: The amplitude of spurious emissions which are attenuated by more than 20dB below the permissible value has no need to be reported.



802.11n(20MHz)

Normal Voltage

Polar (H/V)	Frequency	Meter Reading	Factor	Emission Level	Limits	Margin	Detector Type
	(MHz)	(dBuV)	(dB)	(dBuV/m)	(dBuV/m)	(dB)	
operation frequency:2412							
V	4822.217	65.55	-3.58	61.97	74	-12.03	Pk
V	4822.217	47.10	-3.58	43.52	54	-10.48	AV
H	4822.322	65.72	-3.6	62.12	74	-11.88	Pk
H	4822.322	46.35	-3.6	42.75	54	-11.25	AV
Remark:							
Absolute Level= ReadingLevel+ Factor, Margin= Limit- Absolute Level							

802.11n(20MHz)

Normal Voltage

Polar (H/V)	Frequency	Meter Reading	Factor	Emission Level	Limits	Margin	Detector Type
	(MHz)	(dBuV)	(dB)	(dBuV/m)	(dBuV/m)	(dB)	
operation frequency:2437							
V	4874.054	67.38	-3.63	63.75	74	-10.25	Pk
V	4874.054	46.79	-3.63	43.16	54	-10.84	AV
H	4874.312	65.93	-3.64	62.29	74	-11.71	Pk
H	4874.312	46.02	-3.64	42.38	54	-11.62	AV
Remark:							
Absolute Level= ReadingLevel+ Factor, Margin= Limit- Absolute Level							

802.11n(20MHz)

Normal Voltage

Polar (H/V)	Frequency	Meter Reading	Factor	Emission Level	Limits	Margin	Detector Type
	(MHz)	(dBuV)	(dB)	(dBuV/m)	(dBuV/m)	(dB)	
operation frequency:2462							
V	4922.213	64.71	-3.64	61.07	74	-12.93	pk
V	4922.213	43.98	-3.64	40.34	54	-13.66	AV
H	4923.144	59.75	-3.66	56.09	74	-17.91	pk
H	4923.144	42.71	-3.66	39.05	54	-14.95	pk
Remark:							
Absolute Level= ReadingLevel+ Factor, Margin= Limit- Absolute Level							

Note: The amplitude of spurious emissions which are attenuated by more than 20dB below the permissible value has no need to be reported.



802.11n(40MHz)

Normal Voltage

Polar (H/V)	Frequency	Meter Reading	Factor	Emission Level	Limits	Margin	Detector Type
	(MHz)	(dBuV)	(dB)	(dBuV/m)	(dBuV/m)	(dB)	
operation frequency:2422							
V	4844.000	64.90	-3.61	61.29	74	-12.71	Pk
V	4844.000	46.63	-3.61	43.02	54	-10.98	AV
H	4844.000	65.07	-3.61	61.46	74	-12.54	Pk
H	4844.000	45.89	-3.61	42.28	54	-11.72	AV
Remark:							
Absolute Level= ReadingLevel+ Factor, Margin= Limit- Absolute Level							

802.11n(40MHz)

Normal Voltage

Polar (H/V)	Frequency	Meter Reading	Factor	Emission Level	Limits	Margin	Detector Type
	(MHz)	(dBuV)	(dB)	(dBuV/m)	(dBuV/m)	(dB)	
operation frequency:2437							
V	4874.000	66.71	-3.65	63.06	74	-10.94	Pk
V	4874.000	46.33	-3.65	42.68	54	-11.32	AV
H	4874.000	65.28	-3.65	61.63	74	-12.37	Pk
H	4874.000	45.56	-3.65	41.91	54	-12.09	AV
Remark:							
Absolute Level= ReadingLevel+ Factor, Margin= Limit- Absolute Level							

802.11n(40MHz)

Normal Voltage

Polar (H/V)	Frequency	Meter Reading	Factor	Emission Level	Limits	Margin	Detector Type
	(MHz)	(dBuV)	(dB)	(dBuV/m)	(dBuV/m)	(dB)	
operation frequency:2452							
V	4904.000	64.06	-3.66	60.40	74	-13.60	pk
V	4904.000	43.54	-3.66	39.88	54	-14.12	AV
H	4904.000	59.15	-3.66	55.49	74	-18.51	pk
H	4904.000	42.28	-3.66	38.62	54	-15.38	pk
Remark:							
Absolute Level= ReadingLevel+ Factor, Margin= Limit- Absolute Level							

Note: The amplitude of spurious emissions which are attenuated by more than 20dB below the permissible value has no need to be reported.



4. POWER SPECTRAL DENSITY TEST

4.1 APPLIED PROCEDURES / LIMIT

FCC Part15 (15.247) , Subpart C				
Section	Test Item	Limit	Frequency Range (MHz)	Result
15.247	Power Spectral Density	8 dBm (in any 3KHz)	2400-2483.5	PASS

4.1.1 TEST PROCEDURE

1. Set analyzer center frequency to DTS channel center frequency.
2. Set the span to 1.5 times the DTS bandwidth.
3. Set the RBW to: $3\text{ kHz} \leq \text{RBW} \leq 100\text{ kHz}$.
4. Set the VBW $\geq 3 \times \text{RBW}$.
5. Detector = peak.
6. Sweep time = auto couple.
7. Trace mode = max hold.
8. Allow trace to fully stabilize.
9. Use the peak marker function to determine the maximum amplitude level within the RBW.
10. If measured value exceeds limit, reduce RBW (no less than 3 kHz) and repeat.

4.1.2 DEVIATION FROM STANDARD

No deviation.

4.1.3 TEST SETUP

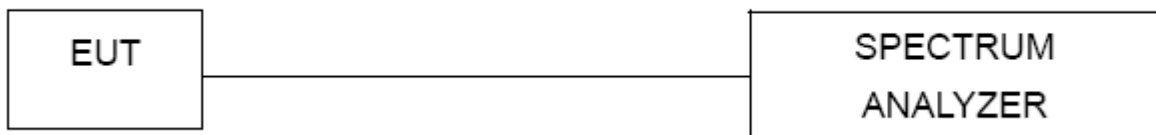

4.1.4 EUT OPERATION CONDITIONS

The EUT tested system was configured as the statements of 2.1 Unless otherwise a special operating condition is specified in the follows during the testing.



4.1.5 TEST RESULTS

EUT :	Action Camera	Model Name :	DV6000W
Temperature :	25°C	Relative Humidity :	60%
Pressure :	1015 hPa	Test Voltage :	DC 5V from PC
Test Mode :	TX b Mode /CH01, CH06, CH11		

Frequency	Power Density (dBm)	Limit (dBm)	Result
2412 MHz	3.622	8	PASS
2437 MHz	4.990	8	PASS
2462 MHz	5.478	8	PASS

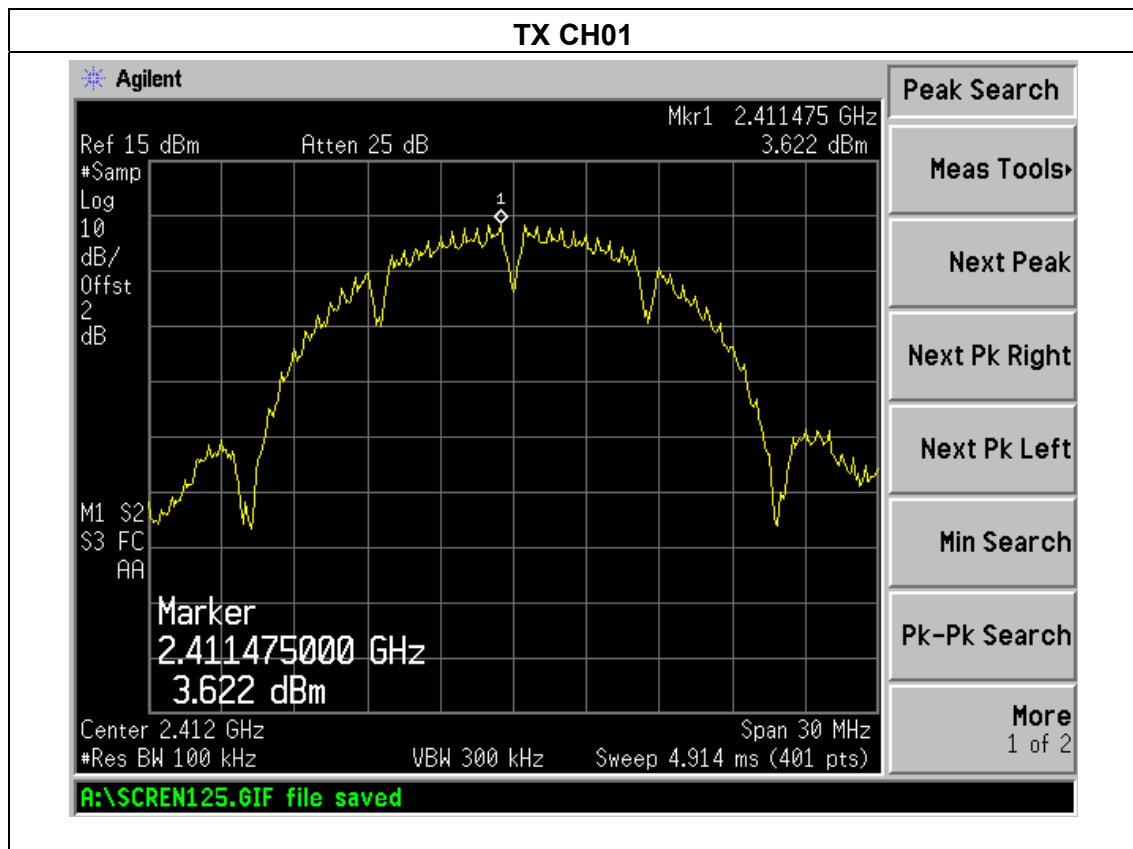

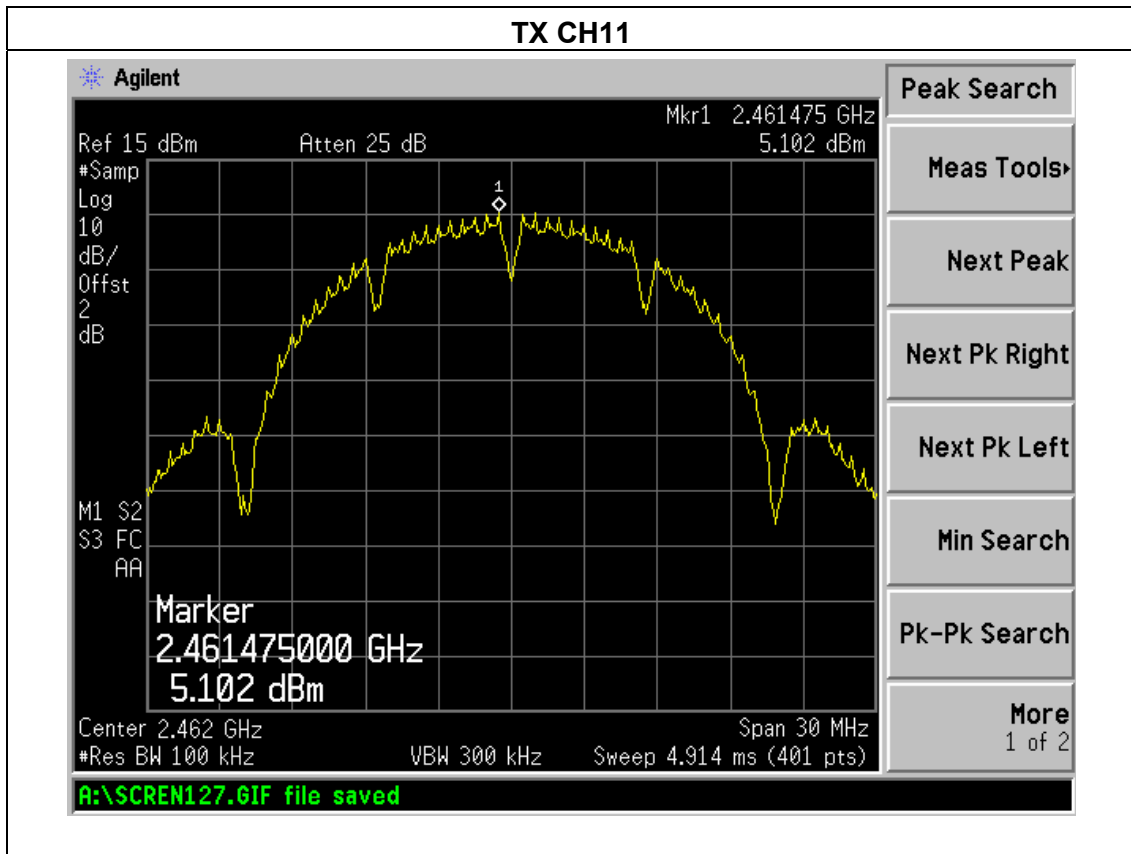
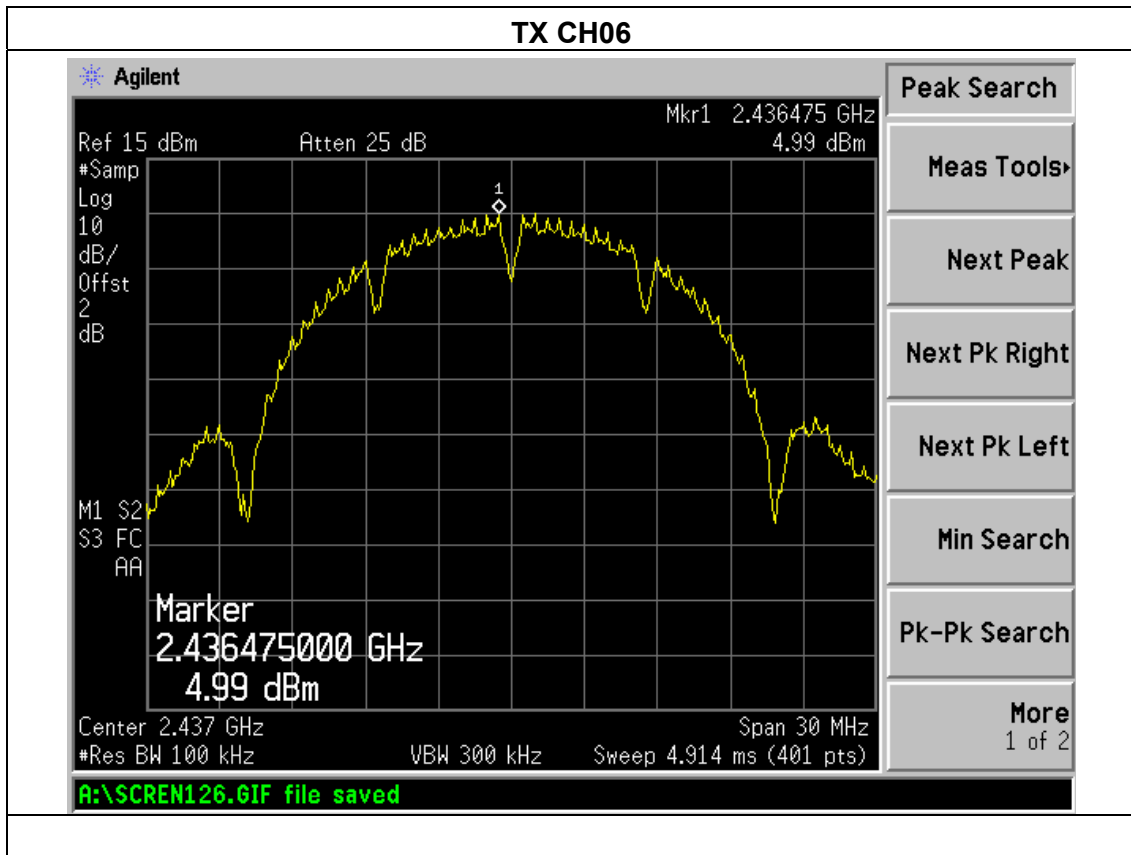



EUT :	Action Camera	Model Name :	DV6000W
Temperature :	25°C	Relative Humidity :	60%
Pressure :	1015 hPa	Test Voltage :	DC 5V from PC
Test Mode :	TX g Mode /CH01, CH06, CH11		

Frequency	Power Density (dBm)	Limit (dBm)	Result
2412 MHz	-4.145	8	PASS
2437 MHz	-3.053	8	PASS
2462 MHz	-2.835	8	PASS

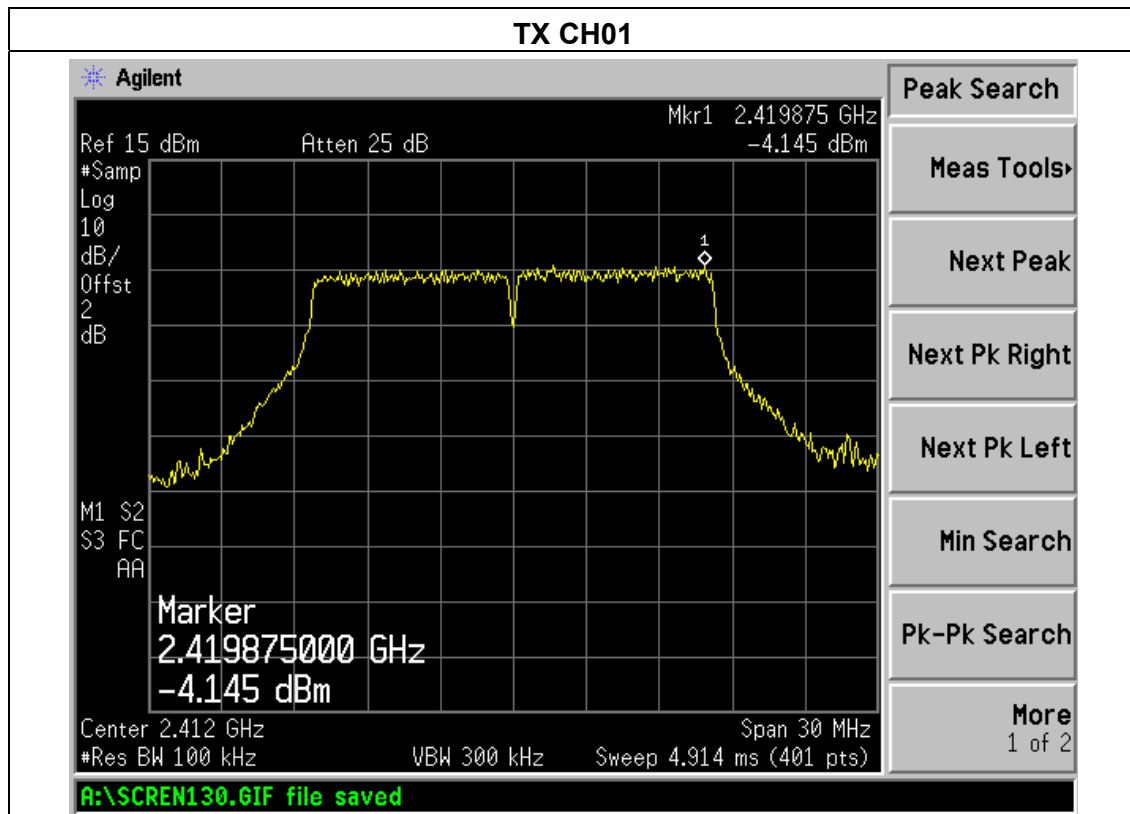



EUT :	Action Camera	Model Name :	DV6000W
Temperature :	25°C	Relative Humidity :	60%
Pressure :	1015 hPa	Test Voltage :	DC 5V from PC
Test Mode :	TX n Mode(20M) /CH01, CH06, CH11		

Frequency	Power Density (dBm)	Limit (dBm)	Result
2412 MHz	-4.444	8	PASS
2437 MHz	-3.306	8	PASS
2462 MHz	-3.863	8	PASS

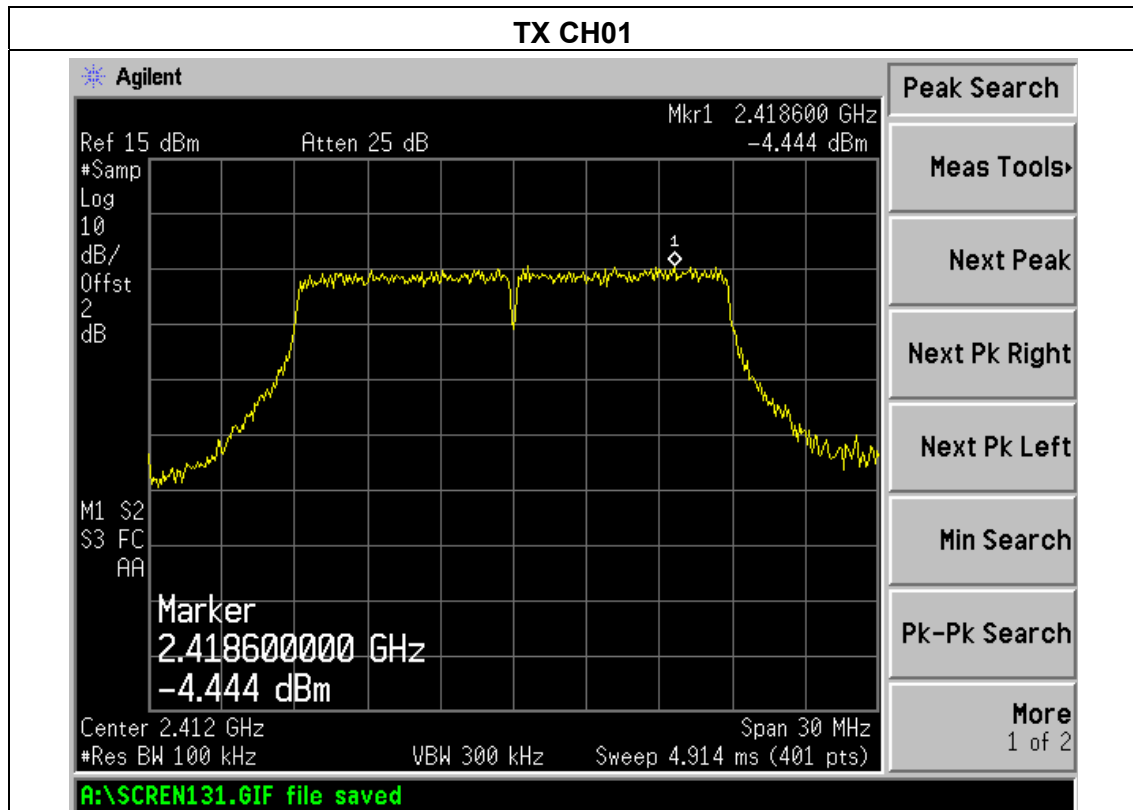

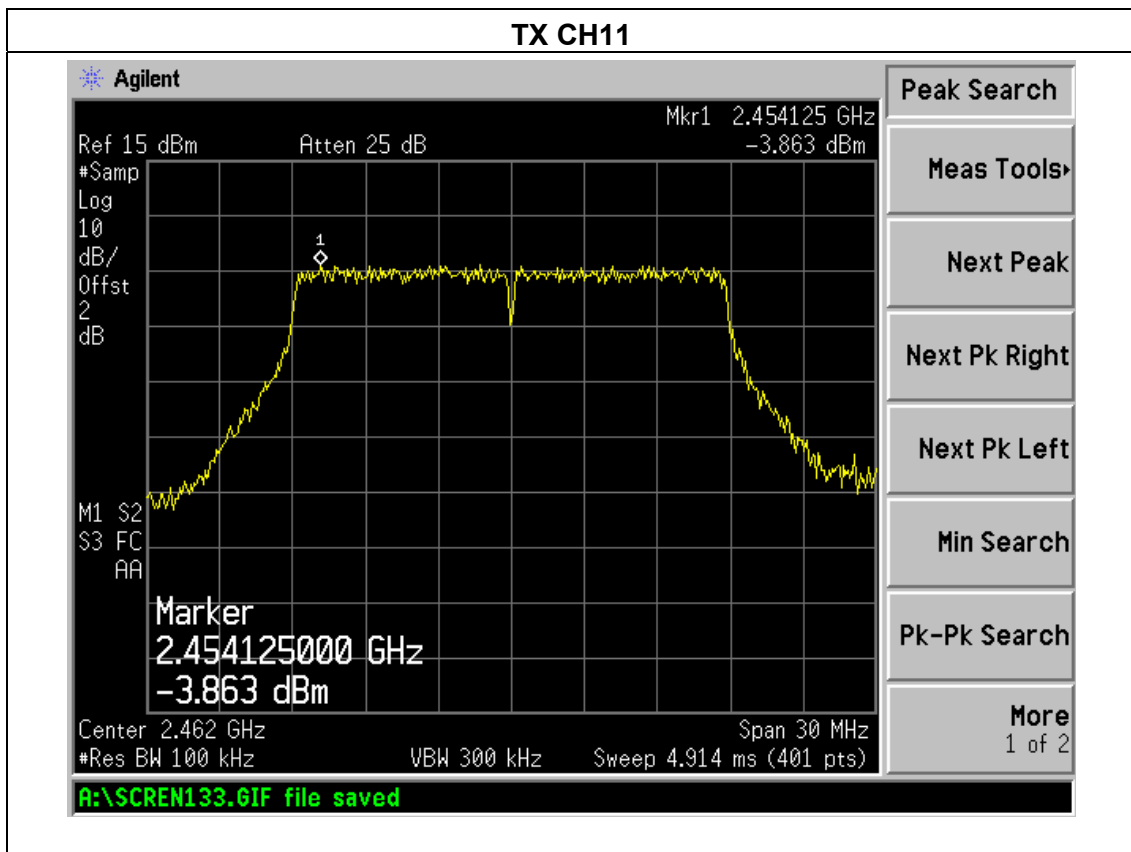
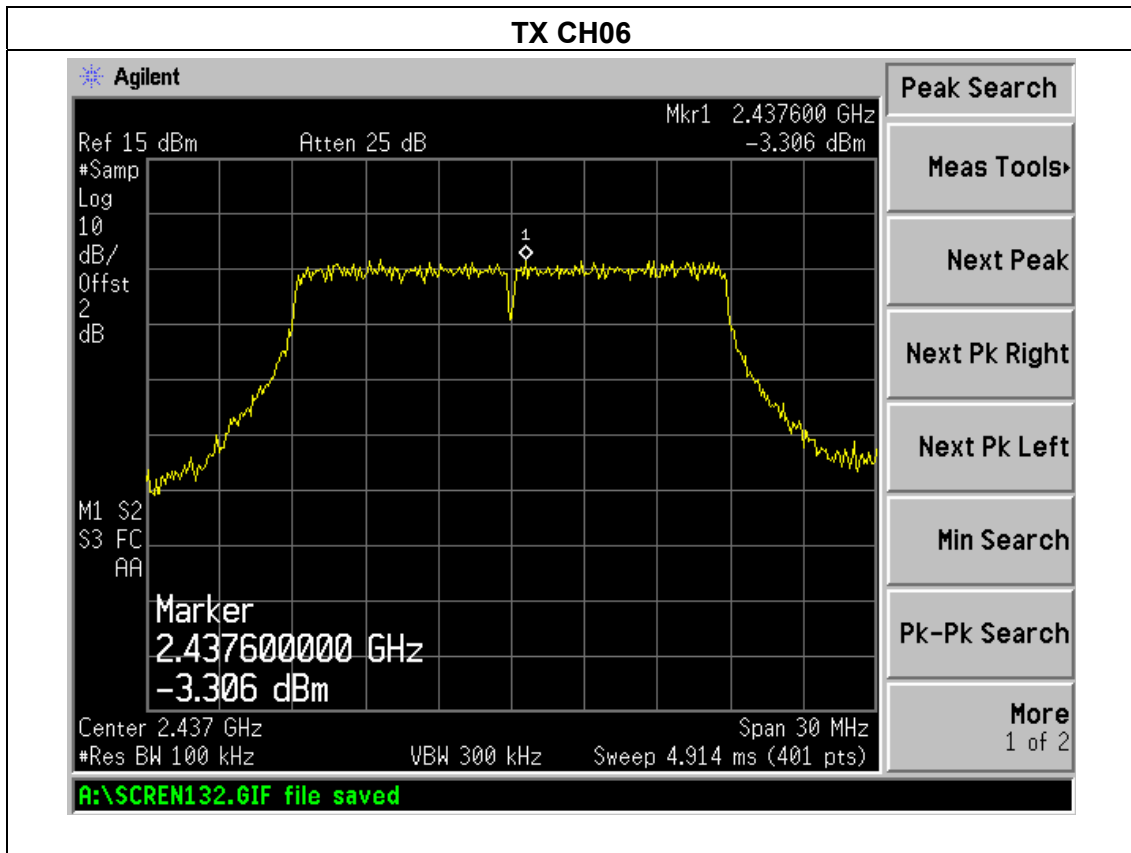



EUT :	Action Camera	Model Name :	DV6000W
Temperature :	25°C	Relative Humidity :	60%
Pressure :	1015 hPa	Test Voltage :	DC 5V from PC
Test Mode :	TX n Mode(40M) /CH03, CH06, CH9		

Frequency	Power Density (dBm)	Limit (dBm)	Result
2422 MHz	-8.388	8	PASS
2437 MHz	-7.467	8	PASS
2452 MHz	-7.262	8	PASS

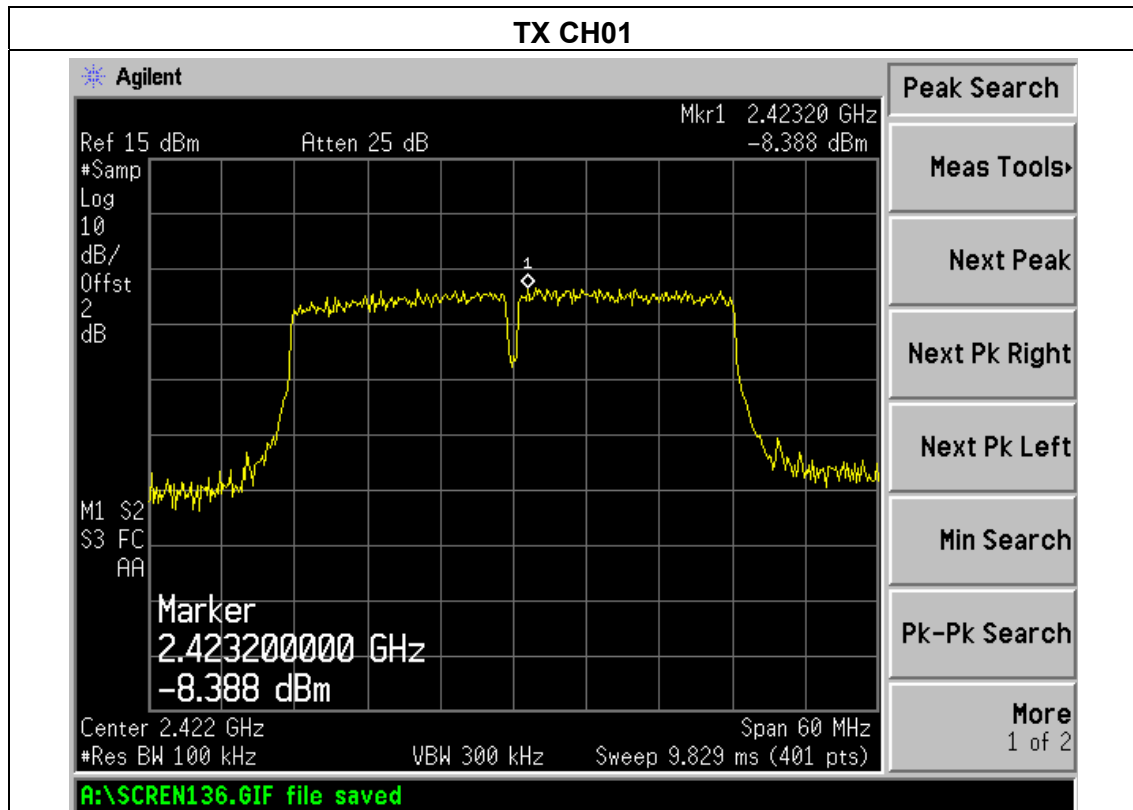

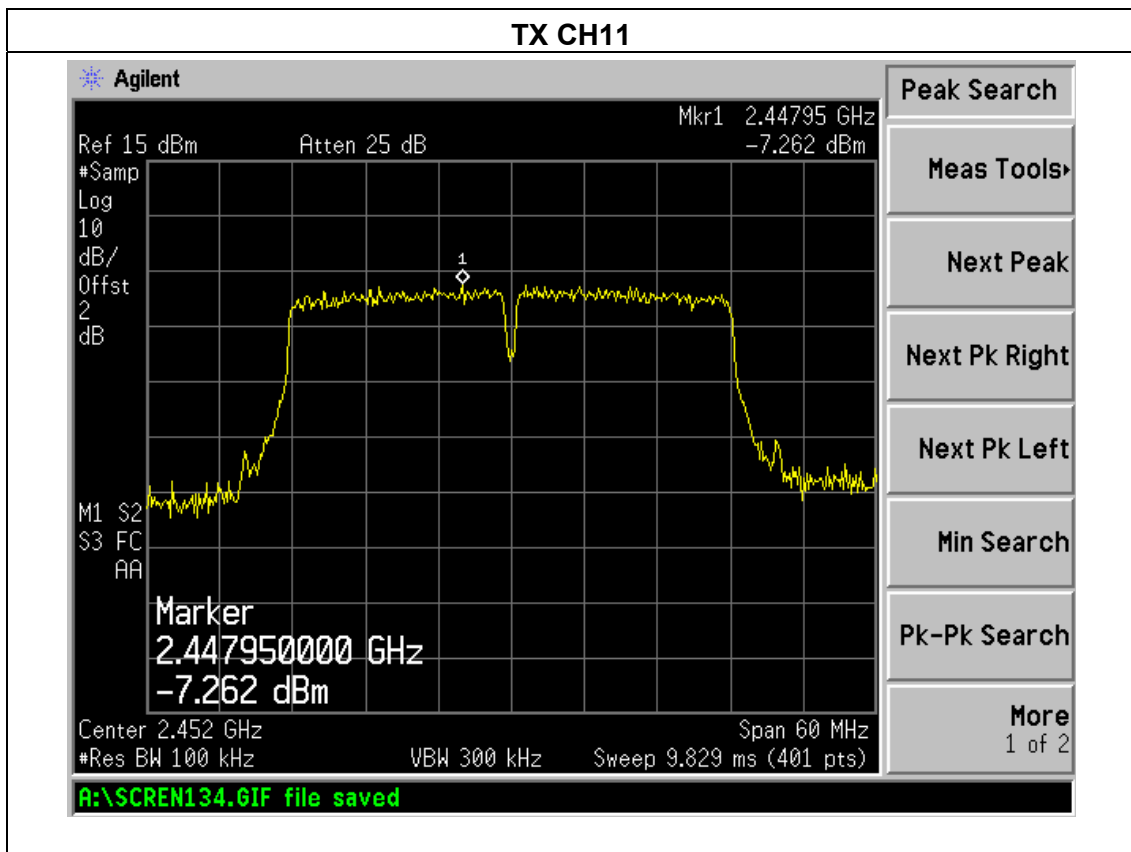
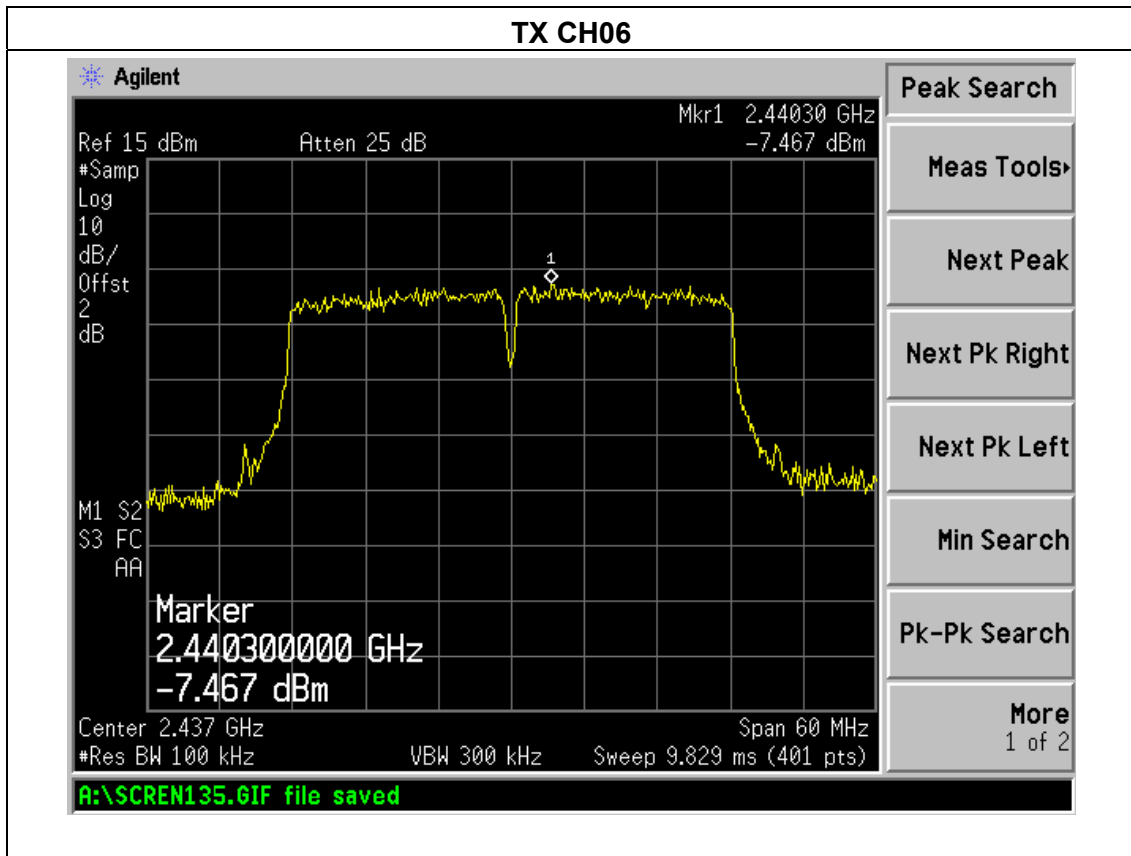



5. BANDWIDTH TEST

5.1 APPLIED PROCEDURES / LIMIT

FCC Part15 (15.247) , Subpart C				
Section	Test Item	Limit	Frequency Range (MHz)	Result
15.247(a)(2)	Bandwidth	$\geq 500\text{KHz}$ (6dB bandwidth)	2400-2483.5	PASS

5.1.1 TEST PROCEDURE

1. Set RBW = 100 kHz.
2. Set the video bandwidth (VBW) $\geq 3 \times$ RBW.
3. Detector = Peak.
4. Trace mode = max hold.
5. Sweep = auto couple.
6. Allow the trace to stabilize.
7. Measure the maximum width of the emission that is constrained by the frequencies associated with the two outermost amplitude points (upper and lower frequencies) that are attenuated by 6 dB relative to the maximum level measured in the fundamental emission.

5.1.2 DEVIATION FROM STANDARD

No deviation.

5.1.3 TEST SETUP



5.1.4 EUT OPERATION CONDITIONS

The EUT tested system was configured as the statements of 2.4 Unless otherwise a special operating condition is specified in the follows during the testing.



5.1.5 TEST RESULTS

EUT :	Action Camera	Model Name :	DV6000W
Temperature :	25°C	Relative Humidity :	60%
Pressure :	1012 hPa	Test Voltage :	DC 5V from PC
Test Mode :	TX b Mode /CH01, CH06, CH11		

Channel	Frequency (MHz)	6dB bandwidth (MHz)	Limit (kHz)	Result
Low	2412	10.038	500	Pass
Middle	2437	10.013	500	Pass
High	2462	10.088	500	Pass

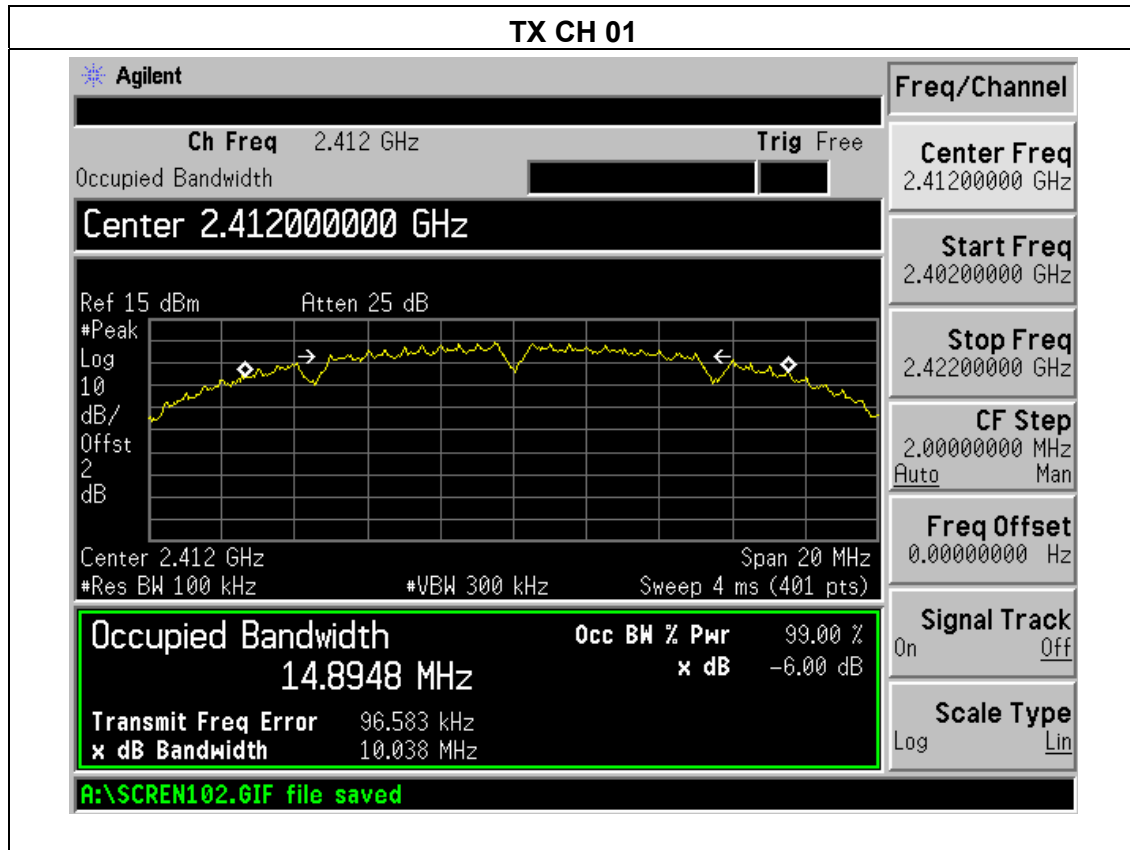

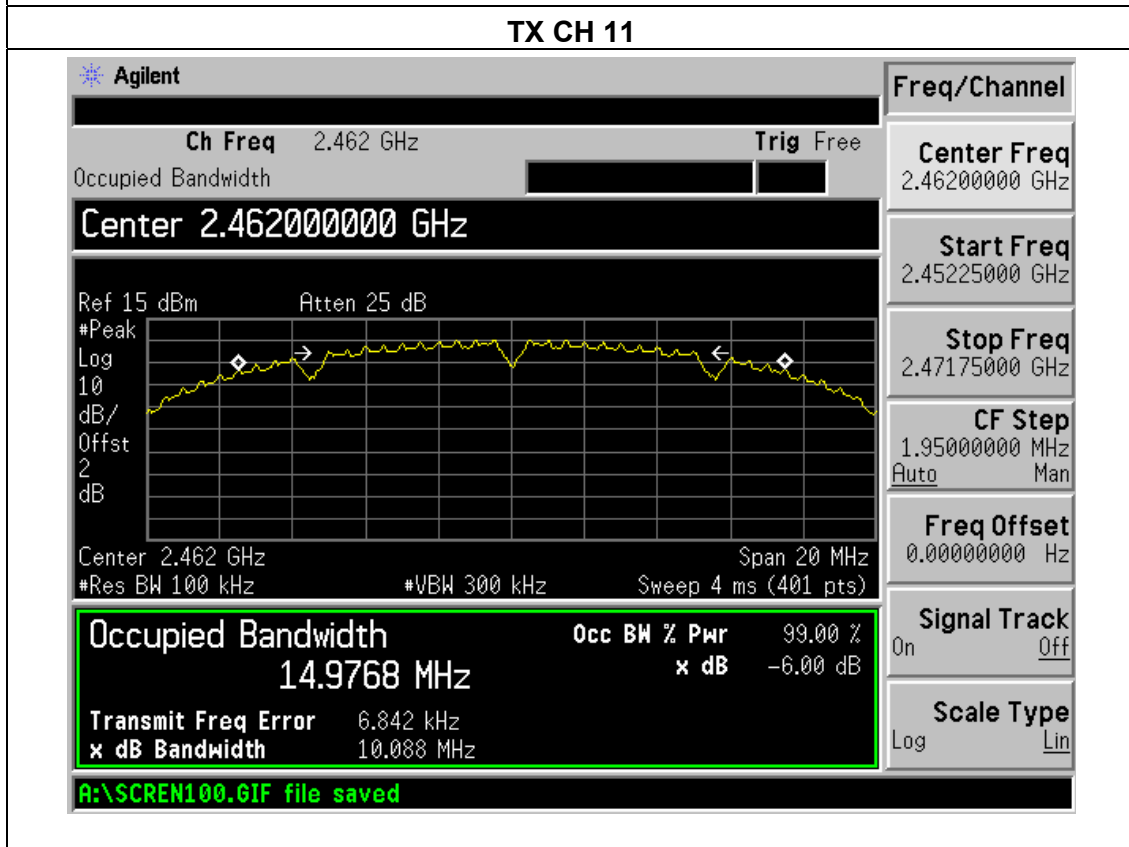
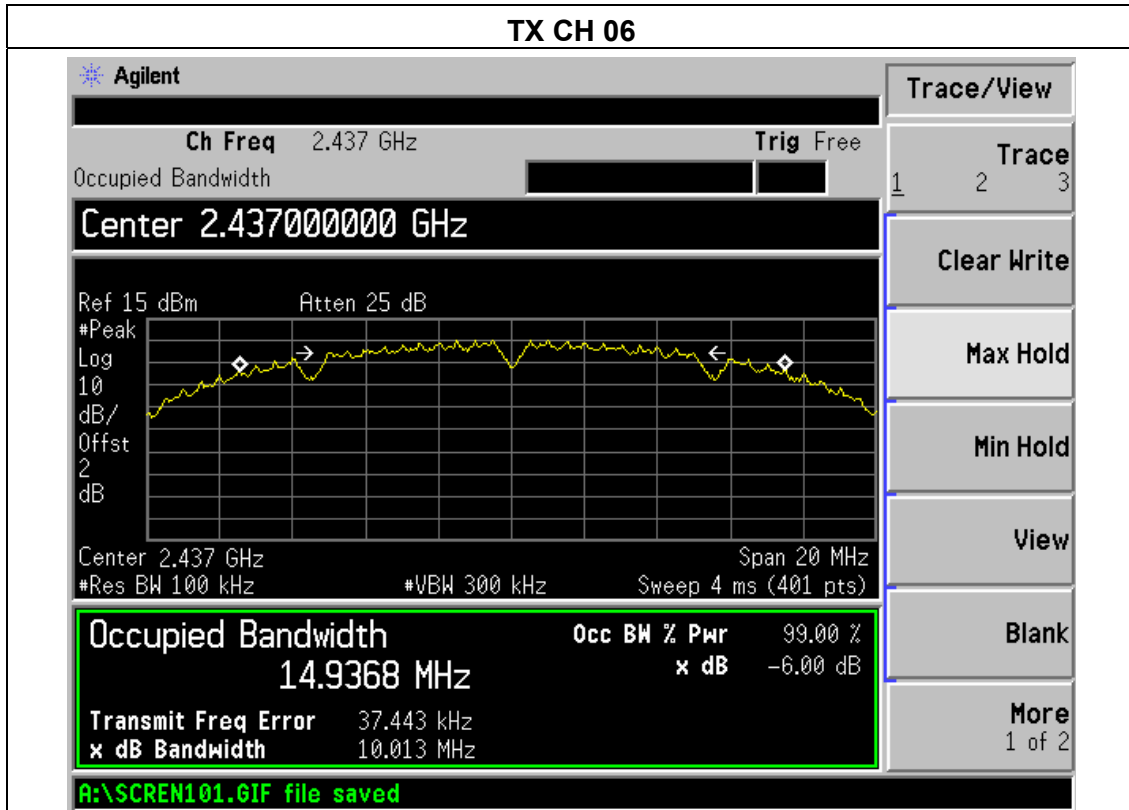



EUT :	Action Camera	Model Name :	DV6000W
Temperature :	25°C	Relative Humidity :	60%
Pressure :	1012 hPa	Test Voltage :	DC 5V from PC
Test Mode :	TX g Mode /CH01, CH06, CH11		

Channel	Frequency (MHz)	6dB bandwidth (MHz)	Limit (kHz)	Result
Low	2412	16.551	500	Pass
Middle	2437	16.506	500	Pass
High	2462	16.582	500	Pass

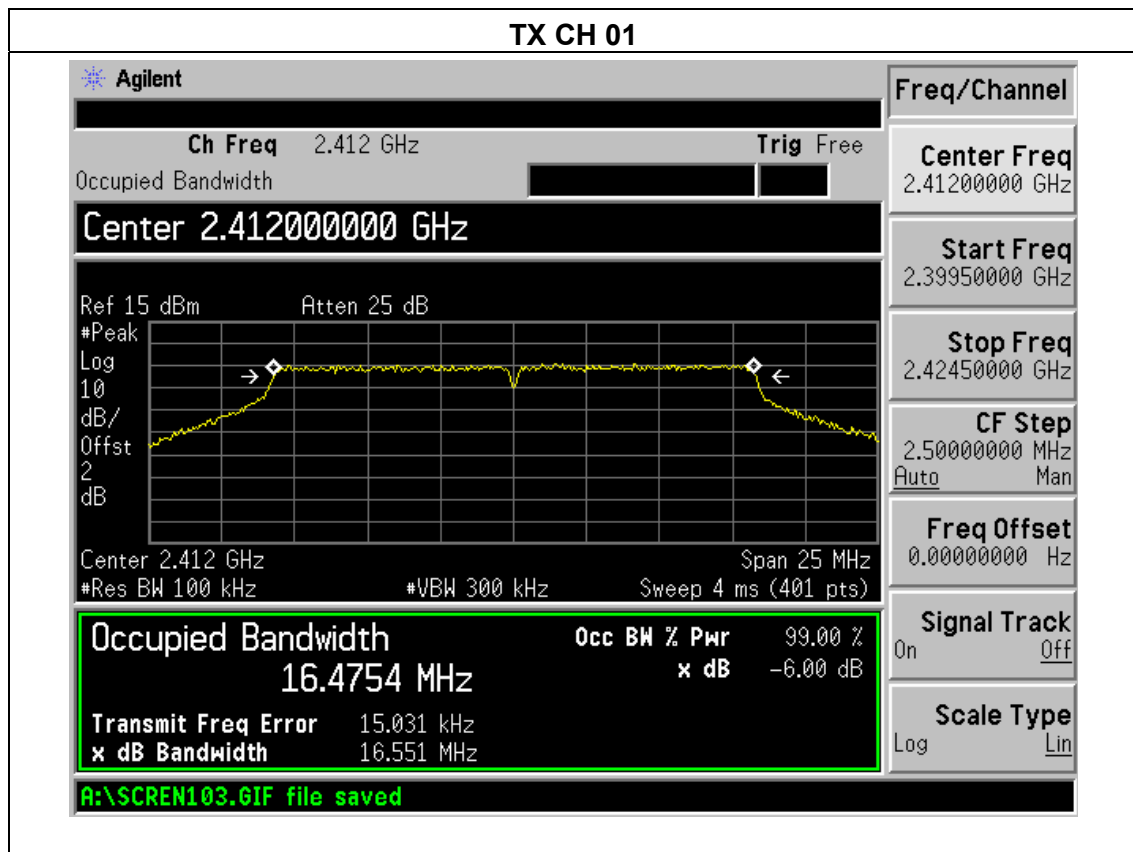

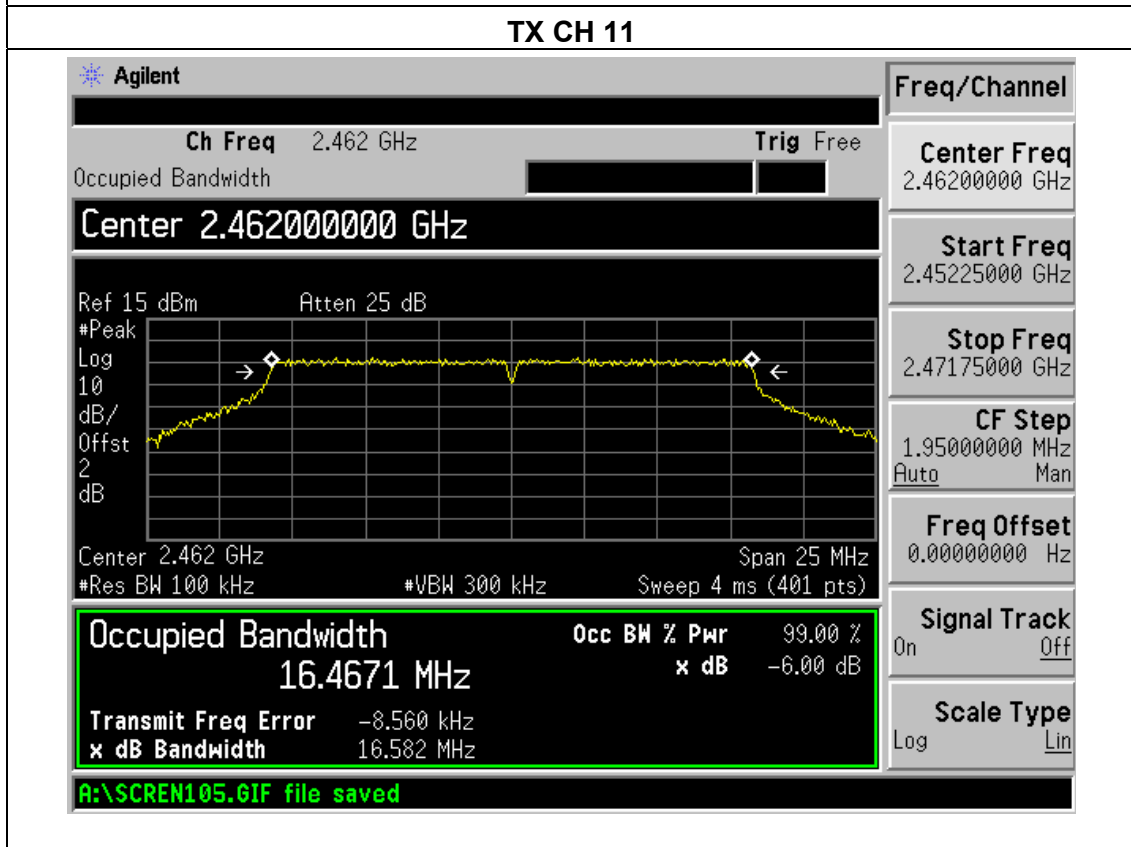
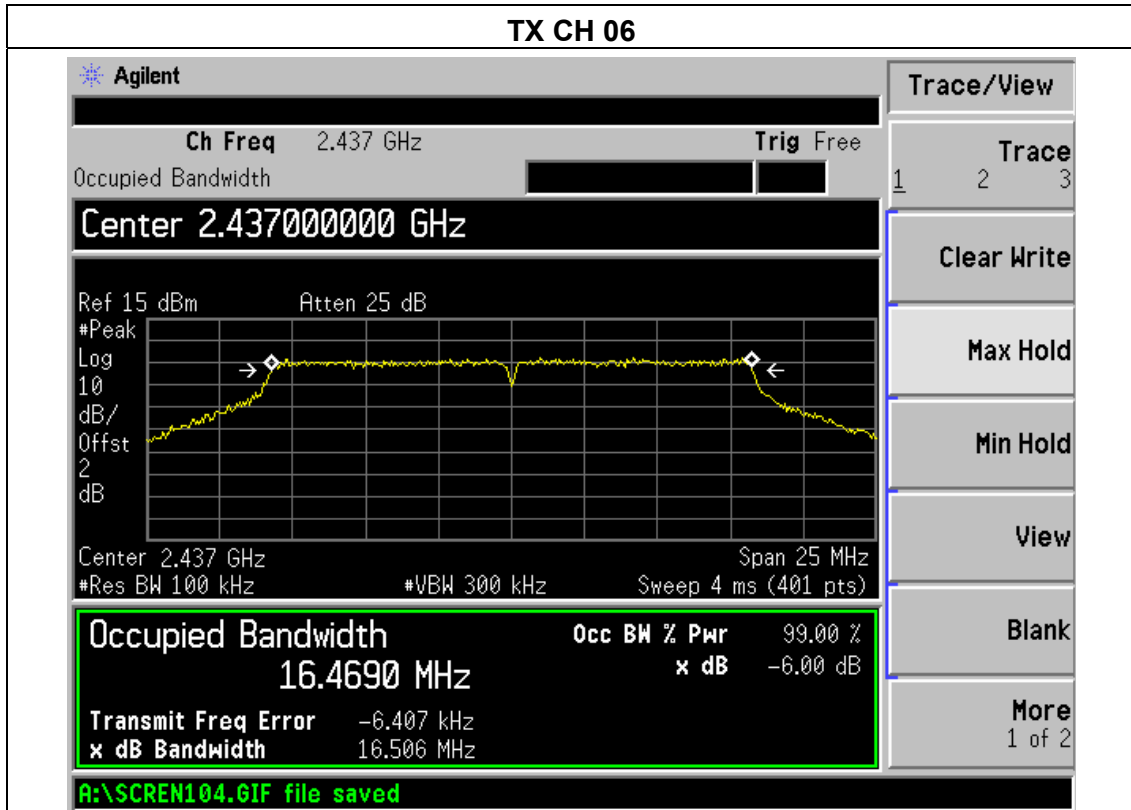



EUT :	Action Camera	Model Name :	DV6000W
Temperature :	25°C	Relative Humidity :	60%
Pressure :	1012 hPa	Test Voltage :	DC 5V from PC
Test Mode :	TX n Mode(20M) /CH01, CH06, CH11		

Channel	Frequency (MHz)	6dB bandwidth (MHz)	Limit (kHz)	Result
Low	2412	17.780	500	Pass
Middle	2437	17.798	500	Pass
High	2462	17.808	500	Pass

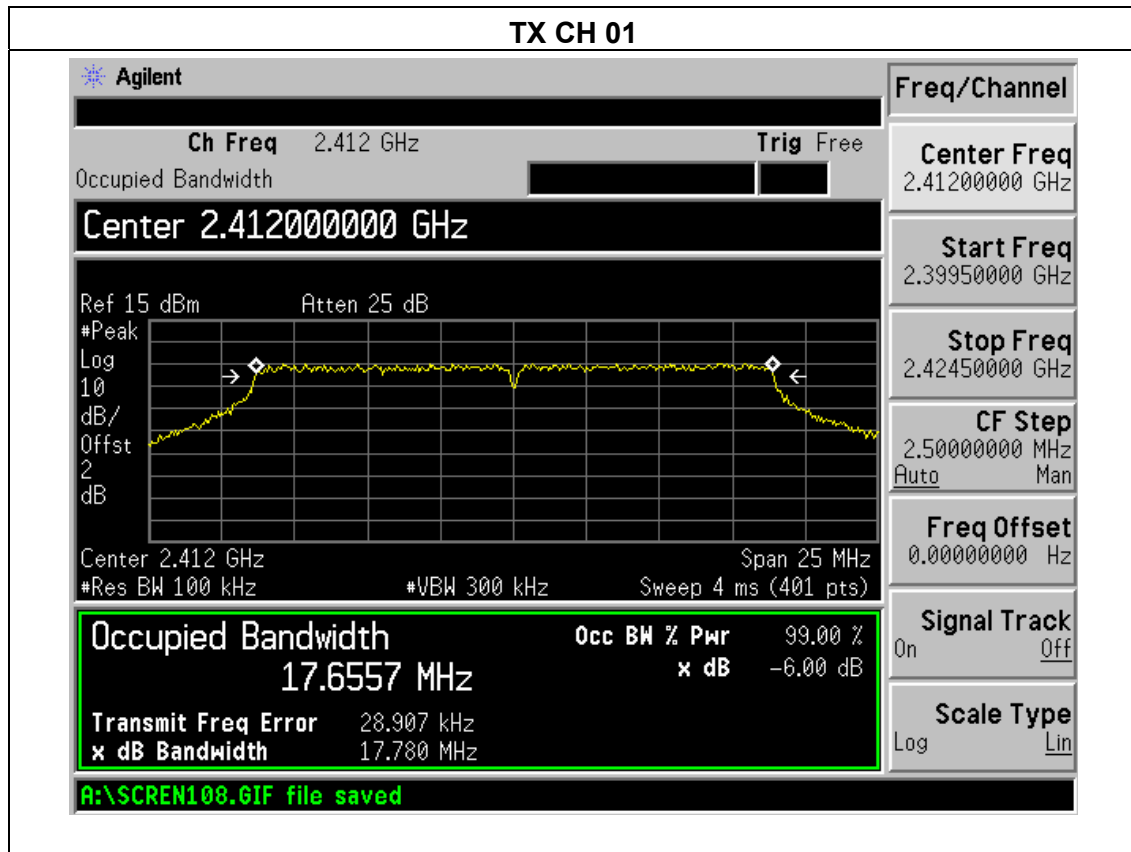

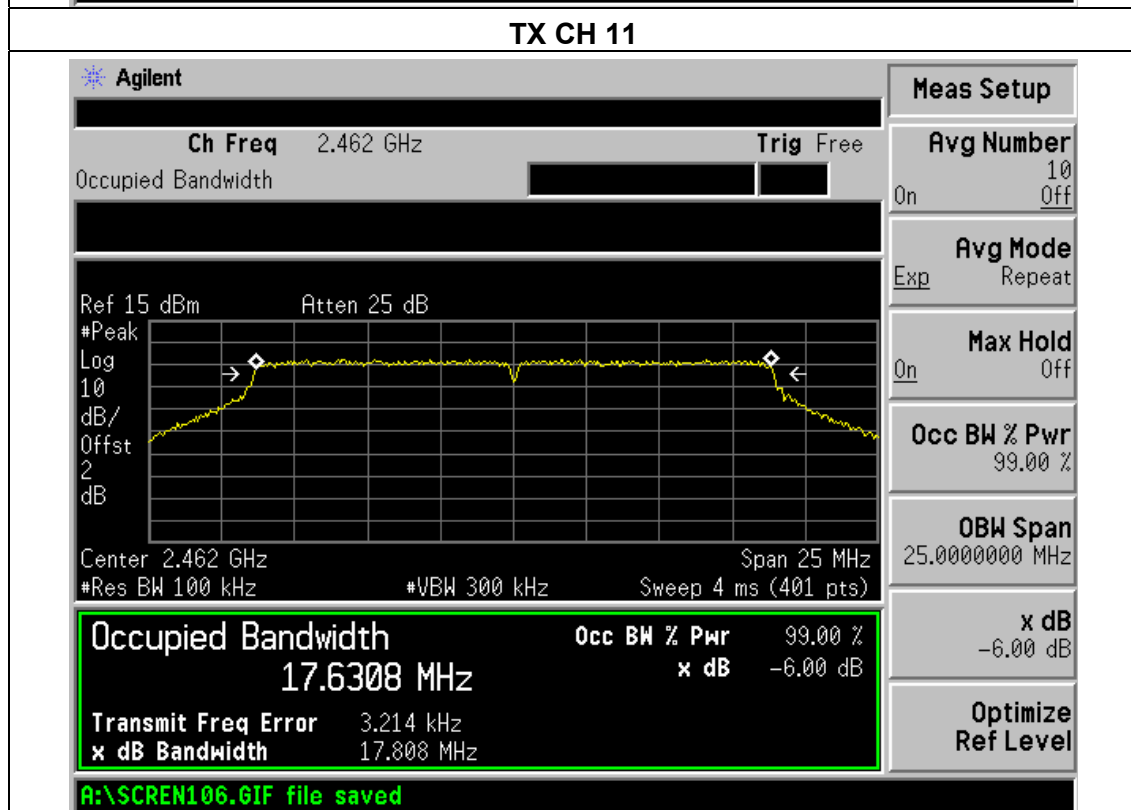
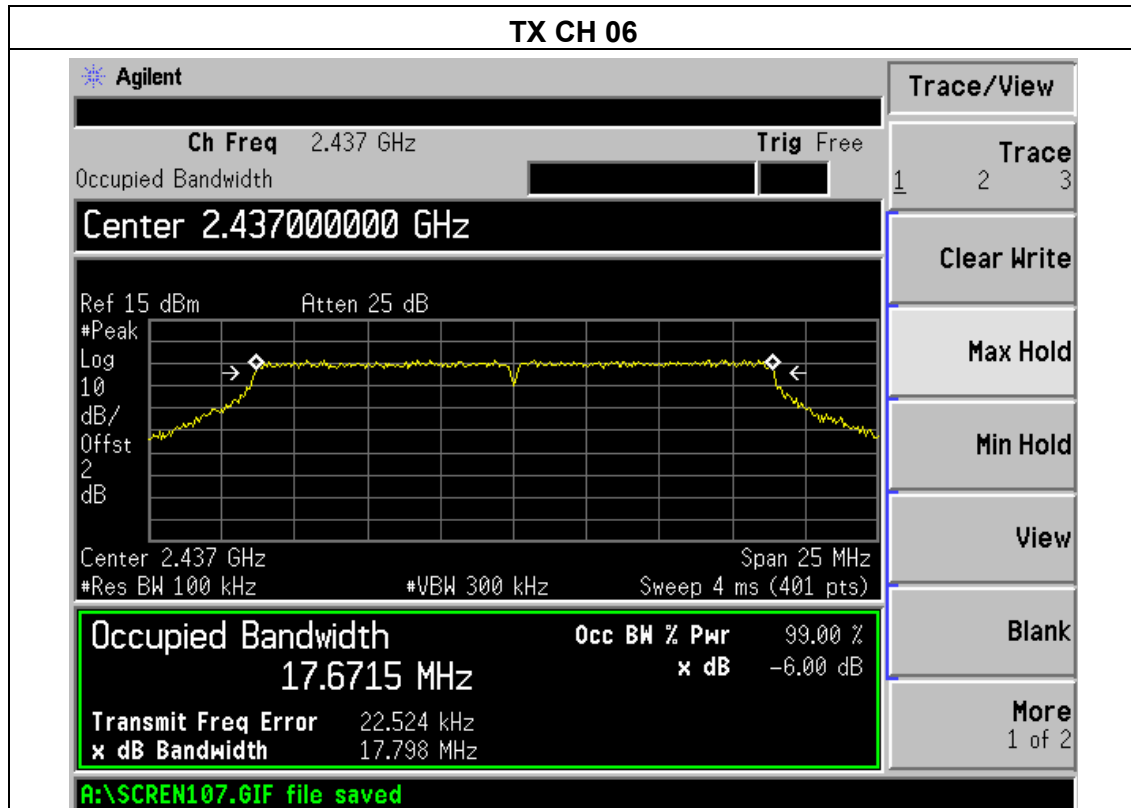



EUT :	Action Camera	Model Name :	DV6000W
Temperature :	25°C	Relative Humidity :	60%
Pressure :	1012 hPa	Test Voltage :	DC 5V from PC
Test Mode :	TX n Mode(40M) /CH03, CH06, CH9		

Channel	Frequency (MHz)	6dB bandwidth (MHz)	Limit (kHz)	Result
Low	2422	36.466	500	Pass
Middle	2437	36.450	500	Pass
High	2452	36.410	500	Pass

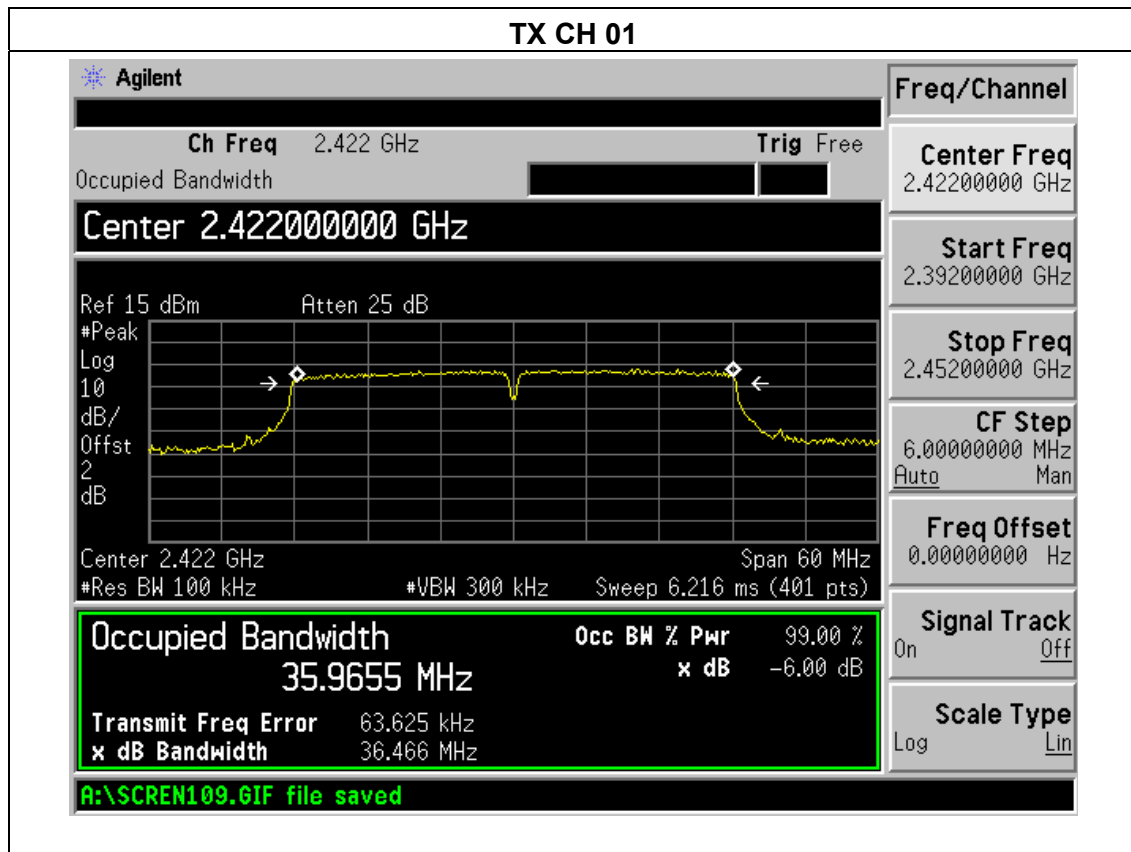

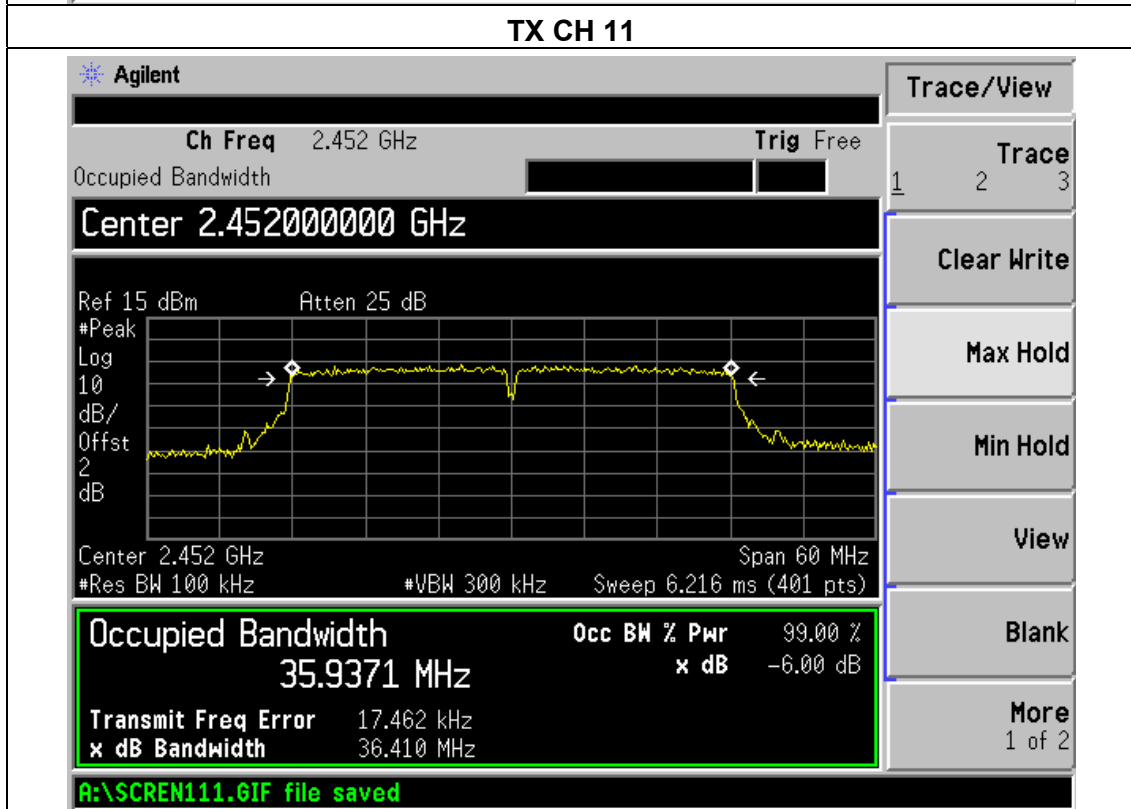
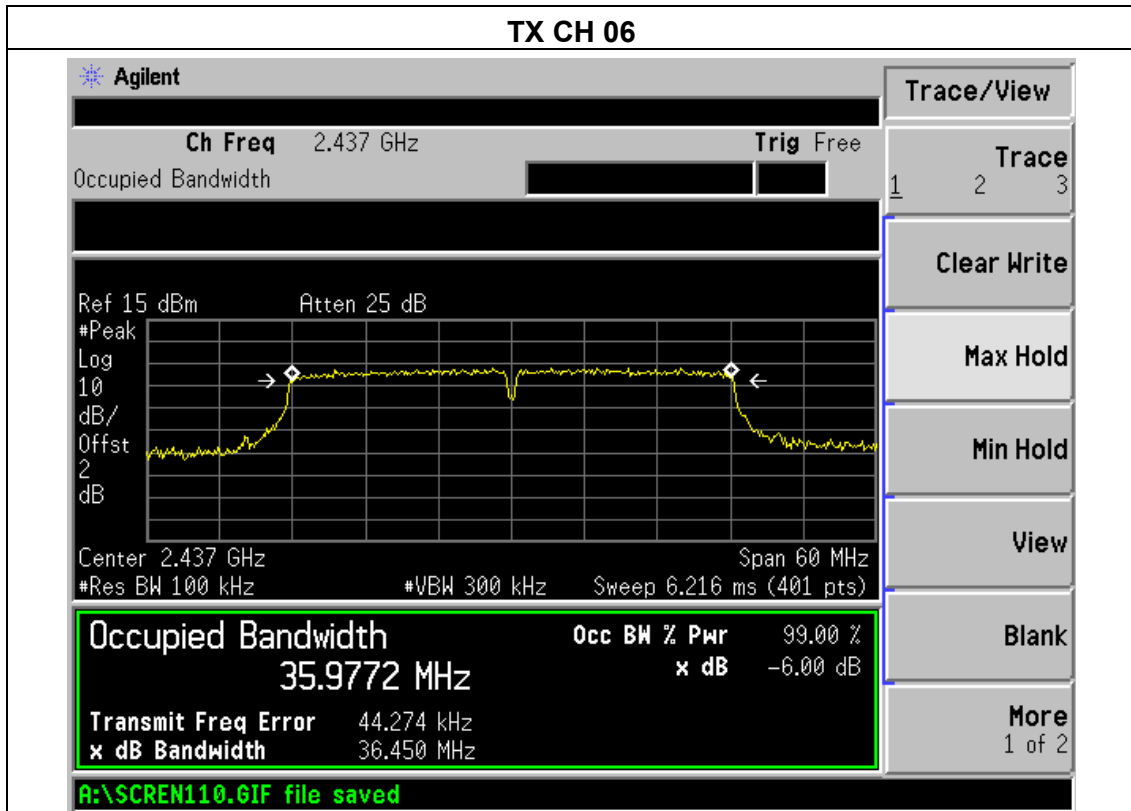



6. PEAK OUTPUT POWER TEST

6.1 APPLIED PROCEDURES / LIMIT

FCC Part15 (15.247) , Subpart C				
Section	Test Item	Limit	Frequency Range (MHz)	Result
15.247(b)(3)	Peak Output Power	1 watt or 30dBm	2400-2483.5	PASS

6.1.1 TEST PROCEDURE

- a. The EUT was directly connected to the Power meter

6.1.2 DEVIATION FROM STANDARD

No deviation.

6.1.3 TEST SETUP



6.1.4 EUT OPERATION CONDITIONS

The EUT tested system was configured as the statements of 2.4 Unless otherwise a special operating condition is specified in the follows during the testing.



6.1.5 TEST RESULTS

EUT :	Action Camera	Model Name :	DV6000W
Temperature :	25°C	Relative Humidity :	60%
Pressure :	1012 hPa	Test Voltage :	DC 5V from PC
Test Mode :	TX b/g/n(20M)		

TX 802.11b Mode			
Test Channe	Frequency	Maximum Conducted Output Power(PK)	LIMIT
	(MHz)	(dBm)	dBm
CH01	2412	17.63	30
CH06	2437	17.53	30
CH11	2462	17.49	30
TX 802.11g Mode			
CH01	2412	15.33	30
CH06	2437	15.29	30
CH11	2462	15.31	30
TX 802.11n-HT20 Mode			
CH01	2412	14.27	30
CH06	2437	14.22	30
CH11	2462	14.24	30
TX 802.11n-HT40 Mode			
CH01	2422	13.78	30
CH06	2437	13.84	30
CH11	2452	13.77	30



7. 100 KHZ BANDWIDTH OF FREQUENCY BAND EDGE

APPLICABLE STANDARD

In any 100 kHz bandwidth outside the frequency band in which the spread spectrum or digitally modulated intentional radiator is operating, the radio frequency power that is produced by the intentional radiator shall be at least 20 dB below that in the 100 kHz bandwidth within the band that contains the highest level of the desired power, based on either an RF conducted or a radiated measurement, provided the transmitter demonstrates compliance with the peak conducted power limits. If the transmitter complies with the conducted power limits based on the use of RMS averaging over a time interval, as permitted under paragraph (b)(3) of this section, the attenuation required under this paragraph shall be 30 dB instead of 20 dB. Attenuation below the general limits specified in §15.209(a) is not required. In addition, radiated emissions which fall in the restricted bands, as defined in §15.205(a), must also comply with the radiated emission limits specified in §15.209(a) (see §15.205(c)).

TEST PROCEDURE

- a) Check the calibration of the measuring instrument using either an internal calibrator or a known signal from an external generator.
- b) Position the EUT without connection to measurement instrument. Turn on the EUT and connect its antenna terminal to measurement instrument via a low loss cable. Then set it to any one measured frequency within its operating range, and make sure the instrument is operated in its linear range.
- c) Set RBW to 100 kHz and VBW of spectrum analyzer to 300 kHz with a convenient frequency span including 100 kHz bandwidth from band edge.
- d) Measure the highest amplitude appearing on spectral display and set it as a reference level. Plot the graph with marking the highest point and edge frequency.
- e) Repeat above procedures until all measured frequencies were complete.

7.1 DEVIATION FROM STANDARD

No deviation.

7.2 TEST SETUP

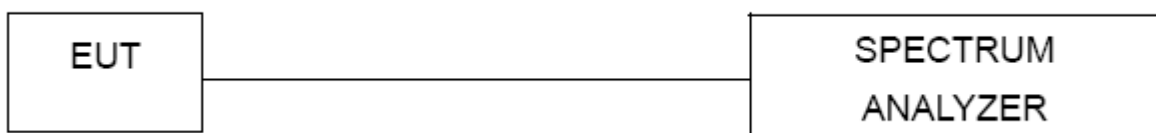



7.3 EUT OPERATION CONDITIONS

The EUT tested system was configured as the statements of 2.4 Unless otherwise a special operating condition is specified in the follows during the testing.

7.4 TEST RESULTS

EUT :	Action Camera	Model Name :	DV6000W
Temperature :	25°C	Relative Humidity :	60%
Pressure :	1012 hPa	Test Voltage :	DC 5V from PC

Radiated

Modulation Type:	Frequency (MHz)	Antenna polarization (H/V)	Factor (dB)	Emission (dBuV/m)	Band edge Limit (dBuV/m)		Result
				PK	PK	AV	
802.11b	<2400	H	1.42	50.59	74.00	54.00	Pass
	<2400	V	1.39	49.79	74.00	54.00	Pass
	>2483.5	H	1.62	49.63	74.00	54.00	Pass
	>2483.5	V	1.75	50.24	74.00	54.00	Pass
802.11g	<2400	H	1.42	49.85	74.00	54.00	Pass
	<2400	V	1.39	49.57	74.00	54.00	Pass
	>2483.5	H	1.62	49.89	74.00	54.00	Pass
	>2483.5	V	1.75	50.31	74.00	54.00	Pass
802.11n20	<2400	H	1.42	50.36	74.00	54.00	Pass
	<2400	V	1.39	49.84	74.00	54.00	Pass
	>2483.5	H	1.62	49.68	74.00	54.00	Pass
	>2483.5	V	1.75	50.37	74.00	54.00	Pass
802.11n40	<2400	H	1.42	50.14	74.00	54.00	Pass
	<2400	V	1.39	49.78	74.00	54.00	Pass
	>2483.5	H	1.62	49.83	74.00	54.00	Pass
	>2483.5	V	1.75	50.42	74.00	54.00	Pass

Remark:

Factor = Antenna Factor + Cable Loss – Pre-amplifier.

If peak level below the average limit, the average level was no recording.



802.11b: Band Edge, Left Side

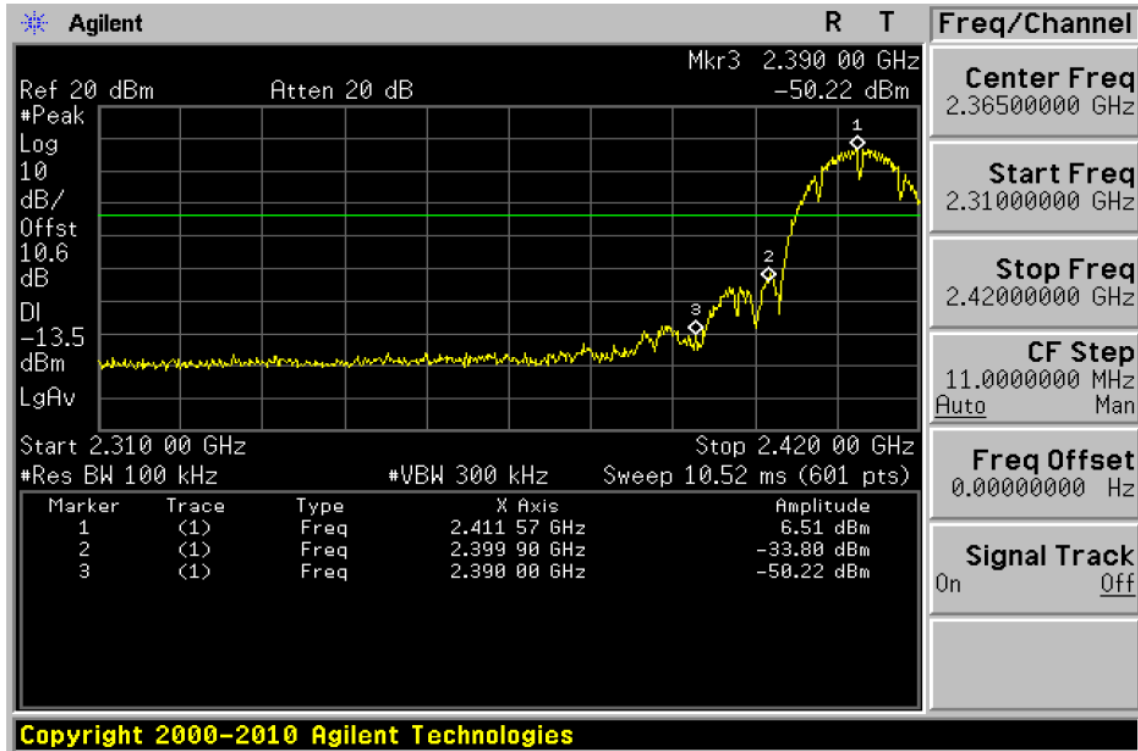

802.11b: Band Edge, Right Side





802.11g: Band Edge, Left Side

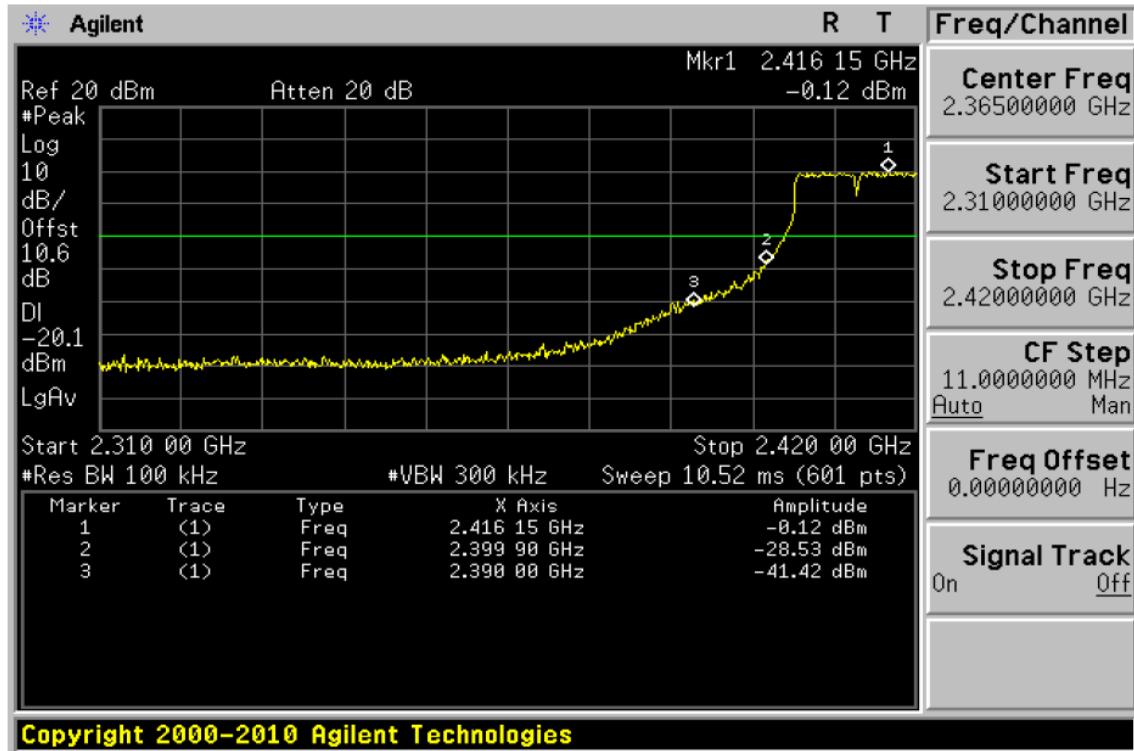

802.11g: Band Edge, Right Side

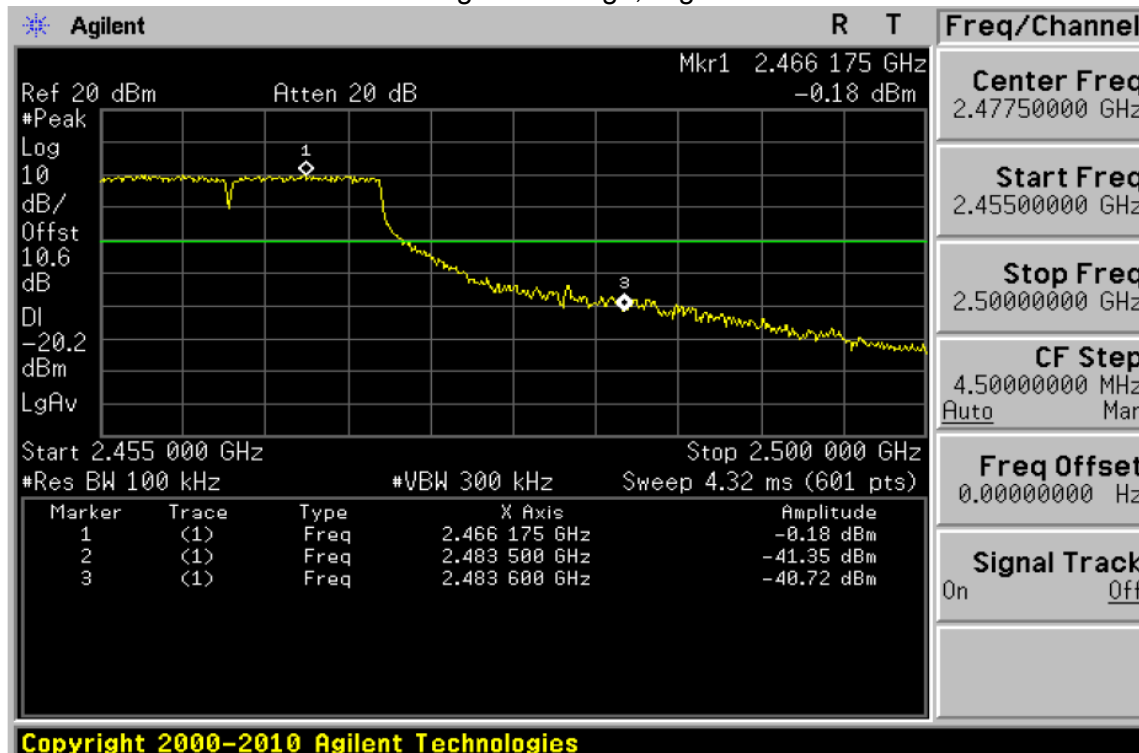



802.11n-HT20: Band Edge, Left Side

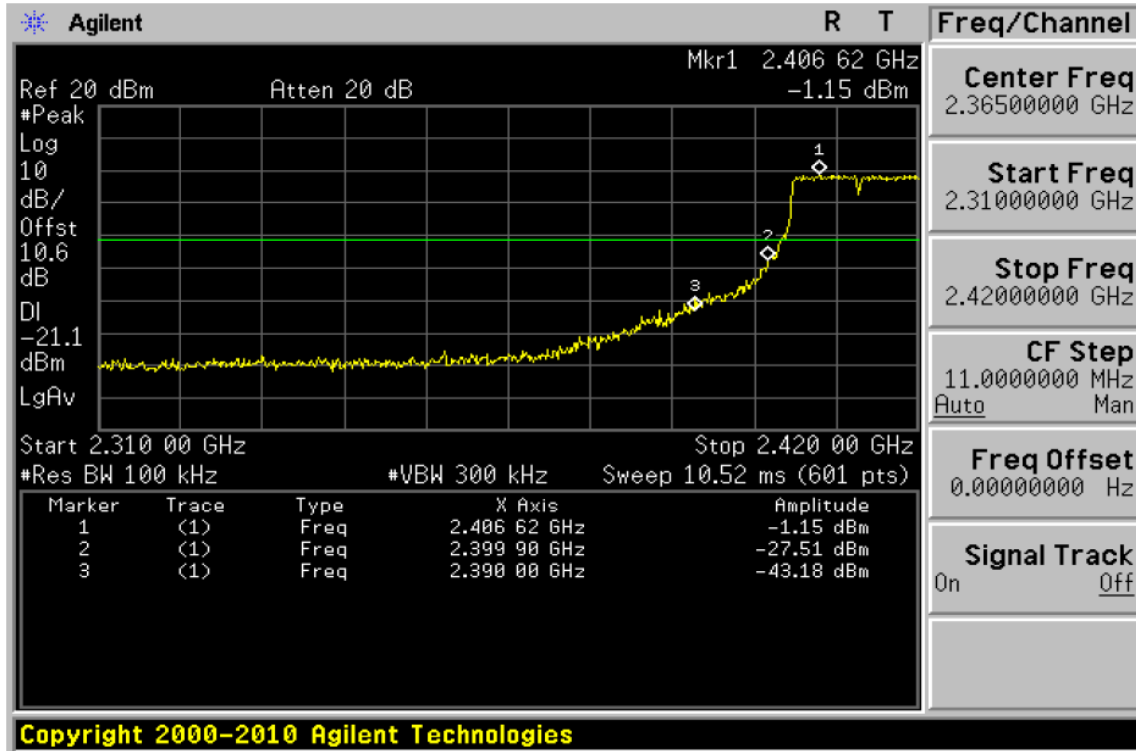

802.11n-HT20: Band Edge, Right Side

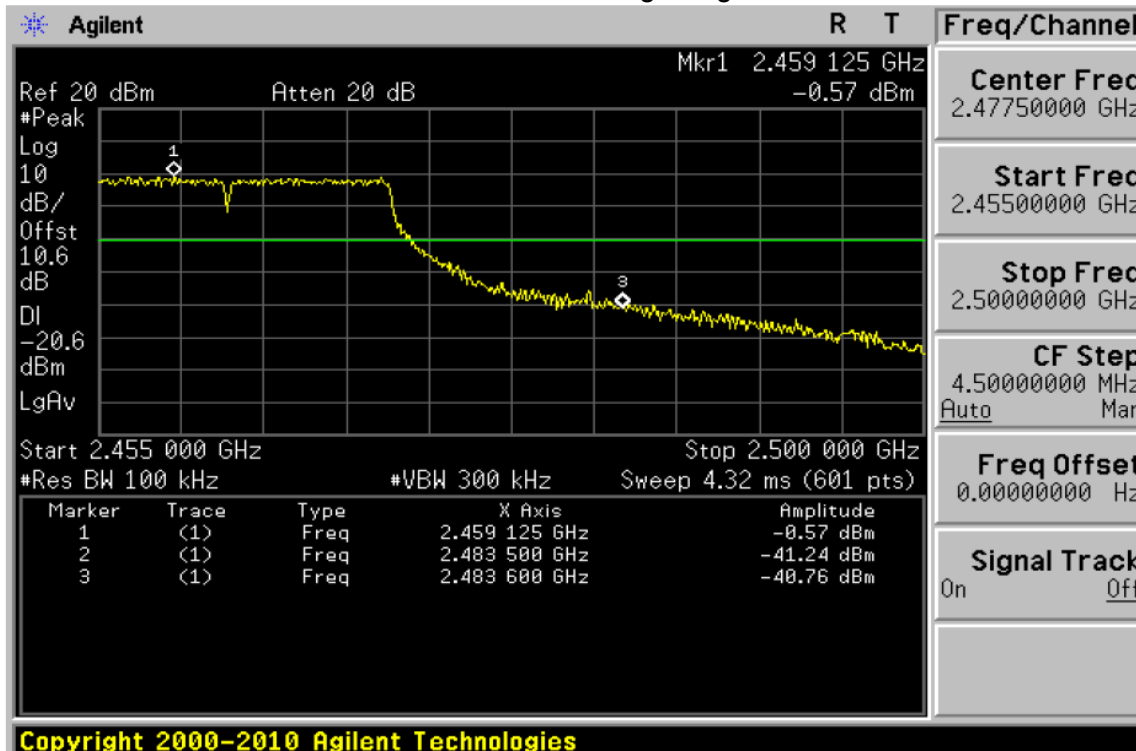



802.11n-HT40: Band Edge, Left Side

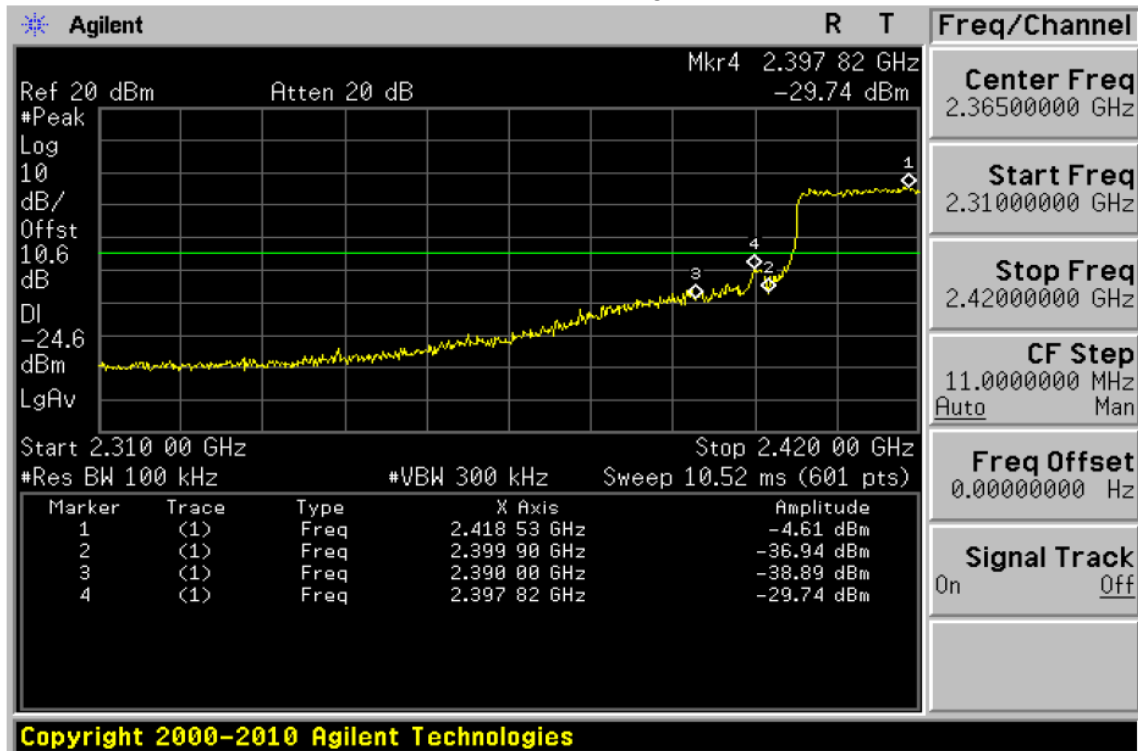

802.11n-HT40: Band Edge, Right Side

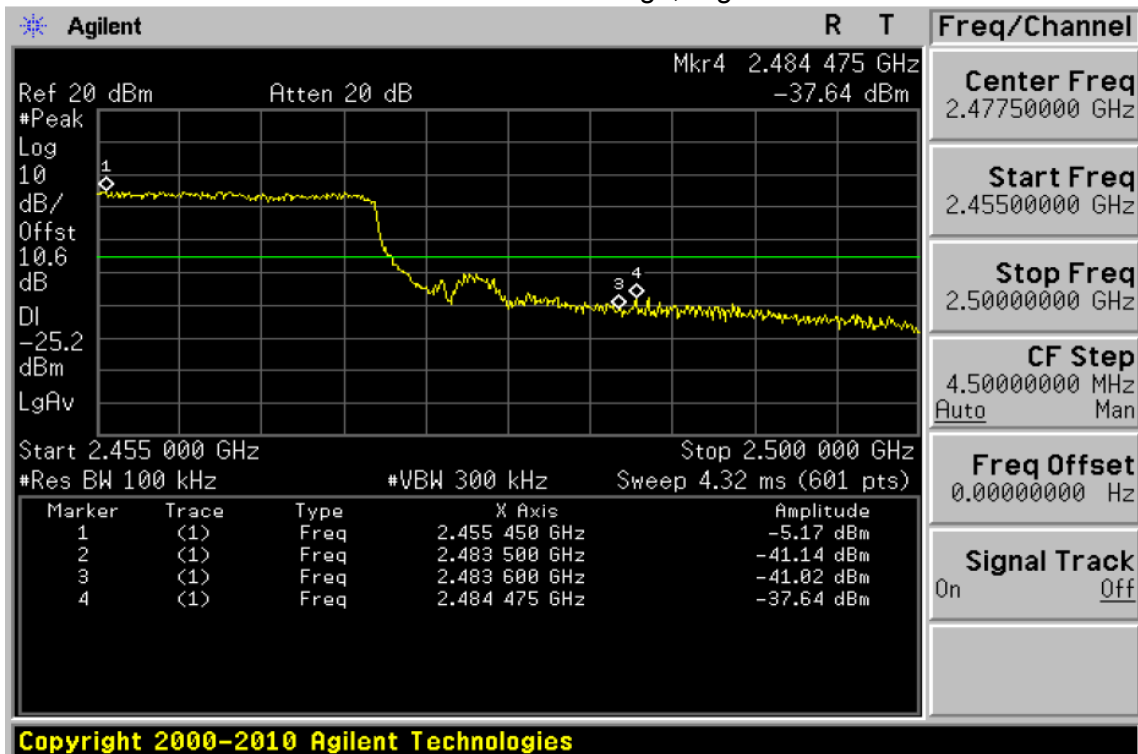



8. ANTENNA REQUIREMENT

8.1 STANDARD REQUIREMENT

15.203 requirement: For intentional device, according to 15.203: an intentional radiator shall be designed to ensure that no antenna other than that furnished by the responsible party shall be used with the device.

8.2 EUT ANTENNA

The EUT antenna is PCB antenna,. It comply with the standard requirement.

9. EUT TEST PHOTO

Radiated Measurement Photos

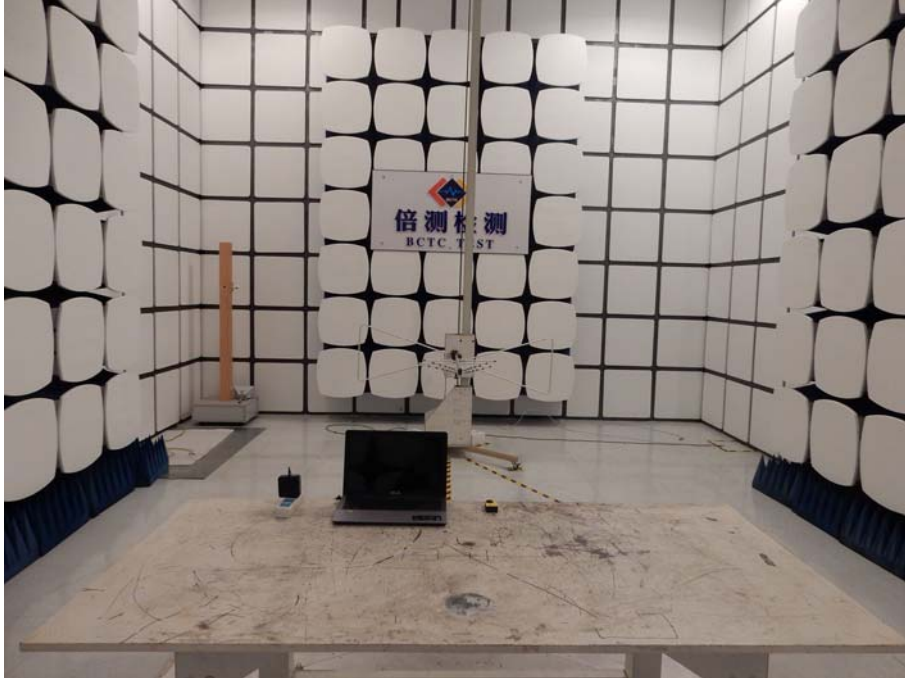

Radiated Measurement Photos





Conducted Measurement Photos



10. EUT PHOTO

EUT Photo 1



EUT Photo 2



EUT Photo 3



EUT Photo 4

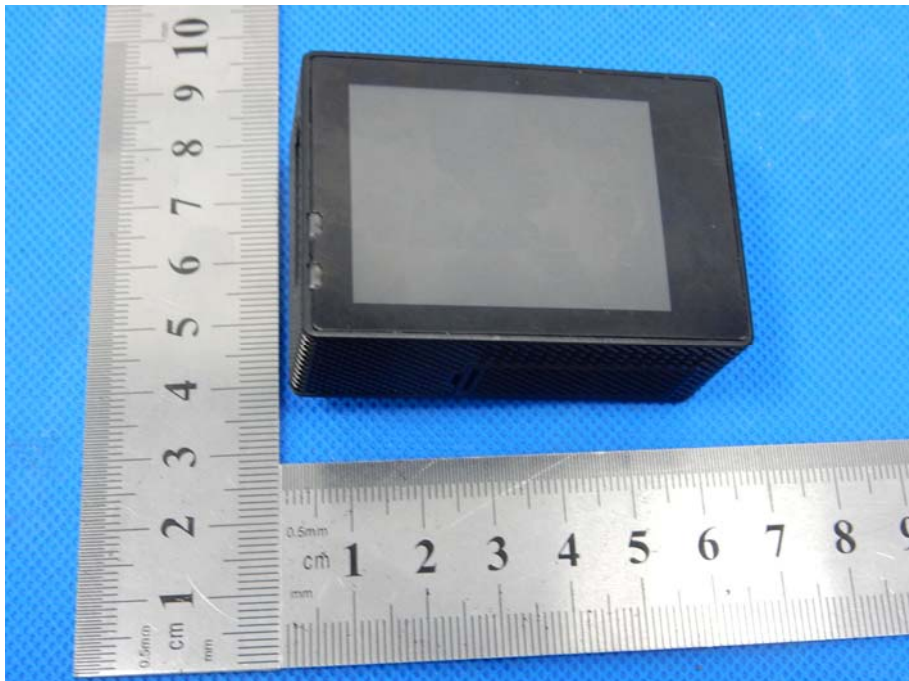

EUT Photo 5

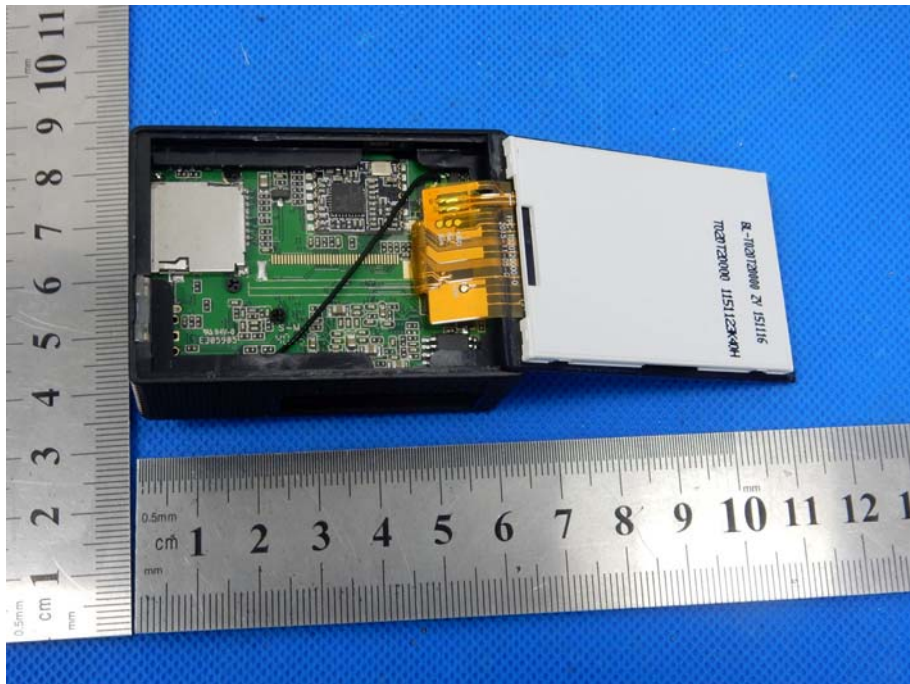

***** END OF REPORT *****