

FCC Test Report (WLAN)

Report No.: RF170912E01

FCC ID: 2AHBN-AP61

Test Model: AP61

Received Date: Sep. 14, 2017

Test Date: Sep. 25 to Oct. 05, 2017

Issued Date: Oct. 27, 2017

Applicant: Mist Systems, Inc.

Address: 1601 South De Anza Blvd. Suite 248 Cupertino California United States
95014

Issued By: Bureau Veritas Consumer Products Services (H.K.) Ltd., Taoyuan Branch
Hsin Chu Laboratory

Lab Address: E-2, No.1, Li Hsin 1st Road, Hsinchu Science Park, Hsinchu City 300,
Taiwan R.O.C.

Test Location: E-2, No.1, Li Hsin 1st Road, Hsinchu Science Park, Hsinchu City 300,
Taiwan R.O.C.



This report is for your exclusive use. Any copying or replication of this report to or for any other person or entity, or use of our name or trademark, is permitted only with our prior written permission. This report sets forth our findings solely with respect to the test samples identified herein. The results set forth in this report are not indicative or representative of the quality or characteristics of the lot from which a test sample was taken or any similar or identical product unless specifically and expressly noted. Our report includes all of the tests requested by you and the results thereof based upon the information that you provided to us. You have 60 days from date of issuance of this report to notify us of any material error or omission caused by our negligence, provided, however, that such notice shall be in writing and shall specifically address the issue you wish to raise. A failure to raise such issue within the prescribed time shall constitute your unqualified acceptance of the completeness of this report, the tests conducted and the correctness of the report contents. Unless specific mention, the uncertainty of measurement has been explicitly taken into account to declare the compliance or non-compliance to the specification. The report must not be used by the client to claim product certification, approval, or endorsement by TAF or any government agencies.

Table of Contents

Release Control Record	4
1 Certificate of Conformity	5
2 Summary of Test Results	6
2.1 Measurement Uncertainty	6
2.2 Modification Record	6
3 General Information	7
3.1 General Description of EUT (WLAN)	7
3.2 Description of Test Modes	11
3.2.1 Test Mode Applicability and Tested Channel Detail	12
3.3 Duty Cycle of Test Signal	14
3.4 Description of Support Units	15
3.4.1 Configuration of System under Test	16
3.5 General Description of Applied Standards	18
4 Test Types and Results	19
4.1 Radiated Emission and Bandedge Measurement	19
4.1.1 Limits of Radiated Emission and Bandedge Measurement	19
4.1.2 Test Instruments	20
4.1.3 Test Procedures	22
4.1.4 Deviation from Test Standard	22
4.1.5 Test Setup	23
4.1.6 EUT Operating Conditions	24
4.1.7 Test Results (Mode 1)	25
4.1.8 Test Results (Mode 2)	38
4.1.9 Test Results (Mode 3)	51
4.1.10 Test Results (Mode 4)	64
4.2 Conducted Emission Measurement	77
4.2.1 Limits of Conducted Emission Measurement	77
4.2.2 Test Instruments	77
4.2.3 Test Procedures	78
4.2.4 Deviation from Test Standard	78
4.2.5 Test Setup	78
4.2.6 EUT Operating Conditions	78
4.2.7 Test Results (Mode 1)	79
4.3 6dB Bandwidth Measurement	81
4.3.1 Limits of 6dB Bandwidth Measurement	81
4.3.2 Test Setup	81
4.3.3 Test Instruments	81
4.3.4 Test Procedure	81
4.3.5 Deviation from Test Standard	81
4.3.6 EUT Operating Conditions	81
4.3.7 Test Result (Mode 1)	82
4.3.8 Test Result (Mode 2)	84
4.3.9 Test Result (Mode 3)	86
4.3.10 Test Result (Mode 4)	88
4.4 Conducted Output Power Measurement	90
4.4.1 Limits of Conducted Output Power Measurement	90
4.4.2 Test Setup	90
4.4.3 Test Instruments	90
4.4.4 Test Procedures	90
4.4.5 Deviation from Test Standard	90
4.4.6 EUT Operating Conditions	90
4.4.7 Test Results (Mode 1)	91
4.4.8 Test Results (Mode 2)	92

4.4.9 Test Results (Mode 3).....	93
4.4.10 Test Results (Mode 4).....	94
4.5 Power Spectral Density Measurement.....	95
4.5.1 Limits of Power Spectral Density Measurement	95
4.5.2 Test Setup.....	95
4.5.3 Test Instruments	95
4.5.4 Test Procedure	95
4.5.5 Deviation from Test Standard	95
4.5.6 EUT Operating Condition	95
4.5.7 Test Results (Mode 1).....	96
4.5.8 Test Results (Mode 2).....	99
4.5.9 Test Results (Mode 3).....	102
4.5.10 Test Results (Mode 4).....	105
4.6 Conducted Out of Band Emission Measurement.....	107
4.6.1 Limits of Conducted Out of Band Emission Measurement.....	107
4.6.2 Test Setup.....	107
4.6.3 Test Instruments	107
4.6.4 Test Procedure	107
4.6.5 Deviation from Test Standard	107
4.6.6 EUT Operating Condition	107
4.6.7 Test Results	107
5 Pictures of Test Arrangements.....	148
Appendix – Information on the Testing Laboratories	149

Release Control Record

Issue No.	Description	Date Issued
RF170912E01	Original release.	Oct. 27, 2017

1 Certificate of Conformity

Product: Premium Outdoor Wi-Fi & BLE Array AP

Brand: Mist

Test Model: AP61

Sample Status: ENGINEERING SAMPLE

Applicant: Mist Systems, Inc.

Test Date: Sep. 25 to Oct. 05, 2017

Standards: 47 CFR FCC Part 15, Subpart C (Section 15.247)
ANSI C63.10: 2013

The above equipment has been tested by **Bureau Veritas Consumer Products Services (H.K.) Ltd., Taoyuan Branch**, and found compliance with the requirement of the above standards. The test record, data evaluation & Equipment Under Test (EUT) configurations represented herein are true and accurate accounts of the measurements of the sample's EMC characteristics under the conditions specified in this report.

Prepared by : Mary Ko , **Date:** Oct. 27, 2017
Mary Ko / Specialist

Approved by : May Chen , **Date:** Oct. 27, 2017
May Chen / Manager

2 Summary of Test Results

47 CFR FCC Part 15, Subpart C (SECTION 15.247)			
FCC Clause	Test Item	Result	Remarks
15.207	AC Power Conducted Emission	PASS	Meet the requirement of limit. Minimum passing margin is -12.66dB at 0.16253MHz.
15.205 / 15.209 / 15.247(d)	Radiated Emissions and Band Edge Measurement	PASS	Meet the requirement of limit. Minimum passing margin is -0.1dB at 2389.00MHz, 2390.00MHz, 2483.50MHz,
15.247(d)	Antenna Port Emission	PASS	Meet the requirement of limit.
15.247(a)(2)	6dB bandwidth	PASS	Meet the requirement of limit.
15.247(b)	Conducted power	PASS	Meet the requirement of limit.
15.247(e)	Power Spectral Density	PASS	Meet the requirement of limit.
15.203	Antenna Requirement	PASS	Antenna connector is i-pex(MHF) not a standard connector.

2.1 Measurement Uncertainty

Where relevant, the following measurement uncertainty levels have been estimated for tests performed on the EUT as specified in CISPR 16-4-2:

Measurement	Frequency	Expanded Uncertainty (k=2) (\pm)
Conducted Emissions at mains ports	150kHz ~ 30MHz	1.84 dB
Radiated Emissions up to 1 GHz	30MHz ~ 1GHz	5.32 dB
Radiated Emissions above 1 GHz	1GHz ~ 6GHz	5.14 dB
	6GHz ~ 18GHz	5.04 dB
	18GHz ~ 40GHz	5.25 dB

2.2 Modification Record

There were no modifications required for compliance.

3 General Information

3.1 General Description of EUT (WLAN)

Product	Premium Outdoor Wi-Fi & BLE Array AP
Brand	Mist
Test Model	AP61
Status of EUT	ENGINEERING SAMPLE
Power Supply Rating	802.3at (50-57Vdc)
Modulation Type	CCK, DQPSK, DBPSK for DSSS 64QAM, 16QAM, QPSK, BPSK for OFDM 256QAM for OFDM in 11ac mode and VHT (20/40) mode in 2.4GHz
Modulation Technology	DSSS, OFDM
Transfer Rate	802.11b: up to 11Mbps 802.11a/g: up to 54Mbps 802.11n: up to 600Mbps 802.11ac: up to 1733.3Mbps
Operating Frequency	2.4GHz: 2.412 ~ 2.462GHz 5GHz: 5.18~ 5.24GHz, 5.745 ~ 5.825GHz
Number of Channel	2.4GHz: 802.11b, 802.11g, 802.11n (HT20), VHT20: 11 802.11n (HT40), VHT40: 7 5GHz: 802.11a, 802.11n (HT20), 802.11ac (VHT20): 9 802.11n (HT40), 802.11ac (VHT40): 4 802.11ac (VHT80): 2
Output Power	2.4GHz: 1TX: 210.863mW CDD Mode: 4TX: 631.677mW 3TX: 476.598mW 2TX: 333.374mW Beamforming Mode: 4TX: 388.252mW 3TX: 464.678mW 2TX: 362.241mW 5GHz: 5.18 ~ 5.24GHz: 1TX: 40.272mW CDD Mode: 4TX: 39.684mW 3TX: 37.834mW 2TX: 37.892mW Beamforming Mode: 4TX: 10.899mW 3TX: 13.663mW 2TX: 19.981mW 5.745 ~ 5.825GHz: 1TX: 241.546mW CDD Mode: 4TX: 957.748mW 3TX: 743.952mW 2TX: 480.319mW Beamforming Mode: 4TX: 323.662mW 3TX: 433.745mW 2TX: 522.933mW

Antenna Type	Refer to Note
Antenna Connector	Refer to Note
Accessory Device	NA
Data Cable Supplied	NA

Note:

1. There are WLAN and Bluetooth technology used for the EUT. The EUT has three radios as following table:

Radio 1	Radio 2	Radio 3
WLAN - 2.4GHz + 5GHz	(Scanning Radio) WLAN RX only - 2.4GHz + 5GHz	Bluetooth

2. Simultaneously transmission condition.

Condition	Technology	
1	WLAN 2.4GHz (Radio 1)	Bluetooth(Radio 3)
2	WLAN 5GHz (Radio 1)	Bluetooth(Radio 3)

Note: The emission of the simultaneous operation has been evaluated and no non-compliance was found.

3. The EUT must be supplied with a POE (only for test not for sale) as following table:

Brand	Model No.	Spec.
Microsemi	PD-9001GR/AT/AC	Input: 100-240Vac, 50/60Hz, 0.67A Output: 55Vdc, 0.6A

4. The antennas provided to the EUT, please refer to the following table:

Radio 1					
WLAN - 2.4GHz + 5GHz (Internal antenna)					
Antenna No.	Transmitter Circuit	Antenna Net Gain (dBi)	Frequency Range (GHz)	Antenna Type	Connector Type
1	Chain (0)	3.87	2.4~2.4835	PIFA	i-pex(MHF)
		4.94	5.15~5.25		
		4.66	5.25~5.35		
		4.25	5.47~5.725		
		4.42	5.725~5.85		
2	Chain (1)	3.91	2.4~2.4835	PIFA	i-pex(MHF)
		4.23	5.15~5.25		
		4.54	5.25~5.35		
		4.66	5.47~5.725		
		4.70	5.725~5.85		
3	Chain (2)	3.93	2.4~2.4835	PIFA	i-pex(MHF)
		4.53	5.15~5.25		
		4.86	5.25~5.35		
		4.95	5.47~5.725		
		4.94	5.725~5.85		
4	Chain (3)	3.81	2.4~2.4835	PIFA	i-pex(MHF)
		4.50	5.15~5.25		
		4.92	5.25~5.35		
		4.71	5.47~5.725		
		4.90	5.725~5.85		
Radio 2					
WLAN RX only - 2.4GHz + 5GHz (Scanning radio antenna)					
Antenna No.	Transmitter Circuit	Antenna Net Gain (dBi)	Frequency Range (GHz)	Antenna Type	Connector Type
1	Chain (0)	3.85	2.4~2.4835	PIFA	i-pex(MHF)
		4.61	5.15~5.25		
		4.71	5.25~5.35		
		4.72	5.47~5.725		
		4.73	5.725~5.85		
Radio 3					
Bluetooth					
Antenna No.	Transmitter Circuit	Antenna Net Gain (dBi)	Frequency Range (GHz)	Antenna Type	Connector Type
1	Chain (0)	3.56	2.4~2.4835	Omni	i-pex(MHF)
2	Chain (1)	5.01	2.4~2.4835	Patch	i-pex(MHF)
Note: Max. gain was selected for the final test.					

5. The EUT incorporates a MIMO function:

2.4GHz Band			
MODULATION MODE	DATA RATE (MCS)	TX & RX CONFIGURATION	
802.11b	1 ~ 11Mbps	4TX	4RX
802.11g	6 ~ 54Mbps	4TX	4RX
802.11n (HT20)	MCS 0~7	4TX	4RX
	MCS 8~15	4TX	4RX
	MCS 16~23	4TX	4RX
	MCS 24~31	4TX	4RX
802.11n (HT40)	MCS 0~7	4TX	4RX
	MCS 8~15	4TX	4RX
	MCS 16~23	4TX	4RX
	MCS 24~31	4TX	4RX
VHT20	MCS 0~7	4TX	4RX
	MCS 8~15	4TX	4RX
	MCS 16~23	4TX	4RX
	MCS 24~31	4TX	4RX
VHT40	MCS 0~7	4TX	4RX
	MCS 8~15	4TX	4RX
	MCS 16~23	4TX	4RX
	MCS 24~31	4TX	4RX
5GHz Band			
MODULATION MODE	DATA RATE (MCS)	TX & RX CONFIGURATION	
802.11a	6 ~ 54Mbps	4TX	4RX
802.11n (HT20)	MCS 0~7	4TX	4RX
	MCS 8~15	4TX	4RX
	MCS 16~23	4TX	4RX
	MCS 24~31	4TX	4RX
802.11n (HT40)	MCS 0~7	4TX	4RX
	MCS 8~15	4TX	4RX
	MCS 16~23	4TX	4RX
	MCS 24~31	4TX	4RX
802.11ac (VHT20)	MCS 0~8, Nss=1	4TX	4RX
	MCS 0~8, Nss=2	4TX	4RX
	MCS 0~9, Nss=3	4TX	4RX
	MCS 0~8, Nss=4	4TX	4RX
802.11ac (VHT40)	MCS 0~9, Nss=1	4TX	4RX
	MCS 0~9, Nss=2	4TX	4RX
	MCS 0~9, Nss=3	4TX	4RX
	MCS 0~9, Nss=4	4TX	4RX
802.11ac (VHT80)	MCS 0~9, Nss=1	4TX	4RX
	MCS 0~9, Nss=2	4TX	4RX
	MCS 0~9, Nss=3	4TX	4RX
	MCS 0~9, Nss=4	4TX	4RX

Note:

- All of modulation mode support beamforming function except 802.11a/b/g modulation mode.
- The EUT support Beamforming and CDD mode, therefore both mode were investigated and the worst case scenario was identified. The worst case data were presented in test report.

6. The above EUT information is declared by manufacturer and for more detailed features description, please refer to the manufacturer's specifications or user's manual.

3.2 Description of Test Modes

11 channels are provided for 802.11b, 802.11g and 802.11n (HT20), VHT20:

Channel	Frequency	Channel	Frequency
1	2412MHz	7	2442MHz
2	2417MHz	8	2447MHz
3	2422MHz	9	2452MHz
4	2427MHz	10	2457MHz
5	2432MHz	11	2462MHz
6	2437MHz		

7 channels are provided for 802.11n (HT40), VHT40:

Channel	Frequency	Channel	Frequency
3	2422MHz	7	2442MHz
4	2427MHz	8	2447MHz
5	2432MHz	9	2452MHz
6	2437MHz		

3.2.1 Test Mode Applicability and Tested Channel Detail

EUT CONFIGURE MODE	APPLICABLE TO				DESCRIPTION
	RE \geq 1G	RE<1G	PLC	APCM	
1	√	√	√	√	4TX Mode
2	√	-	-	√	3TX Mode
3	√	-	-	√	2TX Mode
4	√	-	-	√	1TX Mode

Where **RE \geq 1G**: Radiated Emission above 1GHz & Bandedge Measurement
RE<1G: Radiated Emission below 1GHz
PLC: Power Line Conducted Emission
APCM: Antenna Port Conducted Measurement

NOTE: "-" means no effect.

Radiated Emission Test (Above 1GHz):

- Pre-Scan has been conducted to determine the worst-case mode from all possible combinations between available modulations, data rates and antenna ports (if EUT with antenna diversity architecture).
- Following channel(s) was (were) selected for the final test as listed below.

4TX/3TX/2TX-CDD Mode					
MODE	AVAILABLE CHANNEL	TESTED CHANNEL	MODULATION TECHNOLOGY	MODULATION TYPE	DATA RATE (Mbps)
802.11b	1 to 11	1, 6, 11	DSSS	DBPSK	1
802.11g	1 to 11	1, 6, 11	OFDM	BPSK	6
4TX/3TX/2TX-Beamforming Mode					
MODE	AVAILABLE CHANNEL	TESTED CHANNEL	MODULATION TECHNOLOGY	MODULATION TYPE	DATA RATE (Mbps)
802.11n (HT20)	1 to 11	1, 6, 11	OFDM	BPSK	6.5
802.11n (HT40)	3 to 9	3, 6, 9	OFDM	BPSK	13.5
1TX					
MODE	AVAILABLE CHANNEL	TESTED CHANNEL	MODULATION TECHNOLOGY	MODULATION TYPE	DATA RATE (Mbps)
802.11b	1 to 11	1, 6, 11	DSSS	DBPSK	1
802.11g	1 to 11	1, 6, 11	OFDM	BPSK	6
802.11n (HT20)	1 to 11	1, 6, 11	OFDM	BPSK	6.5
802.11n (HT40)	3 to 9	3, 6, 9	OFDM	BPSK	13.5

Radiated Emission Test (Below 1GHz):

- Pre-Scan has been conducted to determine the worst-case mode from all possible combinations between available modulations, data rates and antenna ports (if EUT with antenna diversity architecture).
- Following channel(s) was (were) selected for the final test as listed below.

4TX-CDD Mode					
MODE	AVAILABLE CHANNEL	TESTED CHANNEL	MODULATION TECHNOLOGY	MODULATION TYPE	DATA RATE (Mbps)
802.11b	1 to 11	6	DSSS	DBPSK	1

Power Line Conducted Emission Test:

- Pre-Scan has been conducted to determine the worst-case mode from all possible combinations between available modulations, data rates and antenna ports (if EUT with antenna diversity architecture).
- Following channel(s) was (were) selected for the final test as listed below.

4TX-CDD Mode					
MODE	AVAILABLE CHANNEL	TESTED CHANNEL	MODULATION TECHNOLOGY	MODULATION TYPE	DATA RATE (Mbps)
802.11b	1 to 11	6	DSSS	DBPSK	1

Antenna Port Conducted Measurement:

- This item includes all test value of each mode, but only includes spectrum plot of worst value of each mode.
- Pre-Scan has been conducted to determine the worst-case mode from all possible combinations between available modulations, data rates and antenna ports (if EUT with antenna diversity architecture).
- Following channel(s) was (were) selected for the final test as listed below.

4TX/3TX/2TX-CDD Mode					
MODE	AVAILABLE CHANNEL	TESTED CHANNEL	MODULATION TECHNOLOGY	MODULATION TYPE	DATA RATE (Mbps)
802.11b	1 to 11	1, 6, 11	DSSS	DBPSK	1
802.11g	1 to 11	1, 6, 11	OFDM	BPSK	6
4TX/3TX/2TX-Beamforming Mode					
MODE	AVAILABLE CHANNEL	TESTED CHANNEL	MODULATION TECHNOLOGY	MODULATION TYPE	DATA RATE (Mbps)
802.11n (HT20)	1 to 11	1, 6, 11	OFDM	BPSK	6.5
802.11n (HT40)	3 to 9	3, 6, 9	OFDM	BPSK	13.5
1TX					
MODE	AVAILABLE CHANNEL	TESTED CHANNEL	MODULATION TECHNOLOGY	MODULATION TYPE	DATA RATE (Mbps)
802.11b	1 to 11	1, 6, 11	DSSS	DBPSK	1
802.11g	1 to 11	1, 6, 11	OFDM	BPSK	6
802.11n (HT20)	1 to 11	1, 6, 11	OFDM	BPSK	6.5
802.11n (HT40)	3 to 9	3, 6, 9	OFDM	BPSK	13.5

Test Condition:

APPLICABLE TO	ENVIRONMENTAL CONDITIONS	INPUT POWER (SYSTEM)	TESTED BY
RE \geq 1G	22deg. C, 72%RH	120Vac, 60Hz	Weiwei Lo Rey chen
RE $<$ 1G	25deg. C, 65%RH	120Vac, 60Hz	Eason Tseng
PLC	26deg. C, 74%RH	120Vac, 60Hz	Andy Ho
APCM	25deg. C, 60%RH	120Vac, 60Hz	Anderson Chen

3.3 Duty Cycle of Test Signal

If duty cycle of test signal is $\geq 98\%$, duty factor is not required.

802.11b: Duty cycle = $12.456/12.55 = 0.993$

802.11g: Duty cycle = $2.063/2.1 = 0.982$

802.11n (HT20): Duty cycle = $1.919/1.949 = 0.985$

802.11n (HT40): Duty cycle = $0.947/0.966 = 0.98$

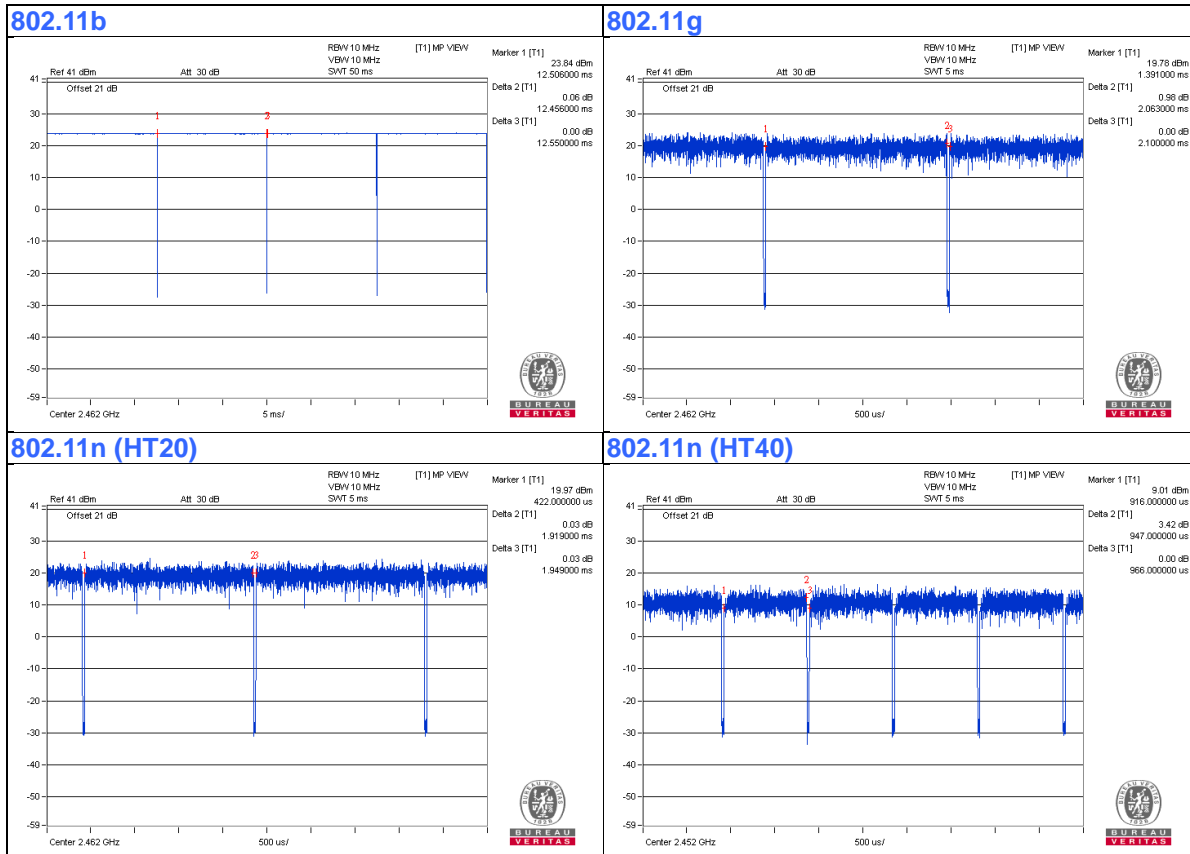

3.4 Description of Support Units

The EUT has been tested as an independent unit together with other necessary accessories or support units. The following support units or accessories were used to form a representative test configuration during the tests.

ID	Product	Brand	Model No.	Serial No.	FCC ID	Remarks
A.	Laptop	DELL	E6420	B92T3R1	FCC DoC	Provided by Lab
B.	Laptop	DELL	E6420	482T3R1	FCC DoC	Provided by Lab
C.	PoE	Microsemi	PD-9001GR/AT/AC	NA	NA	Supplied by client

Note:

1. All power cords of the above support units are non-shielded (1.8m).

ID	Descriptions	Qty.	Length (m)	Shielding (Yes/No)	Cores (Qty.)	Remarks
1.	RJ-45 Cable	1	10	No	0	Provided by Lab
2.	RJ-45 Cable	1	3	No	0	Provided by Lab
3.	RJ-45 Cable	1	10	No	0	Provided by Lab
4.	Earth Cable	1	3	No	0	Provided by Lab

3.4.1 Configuration of System under Test

For Conducted Emission:

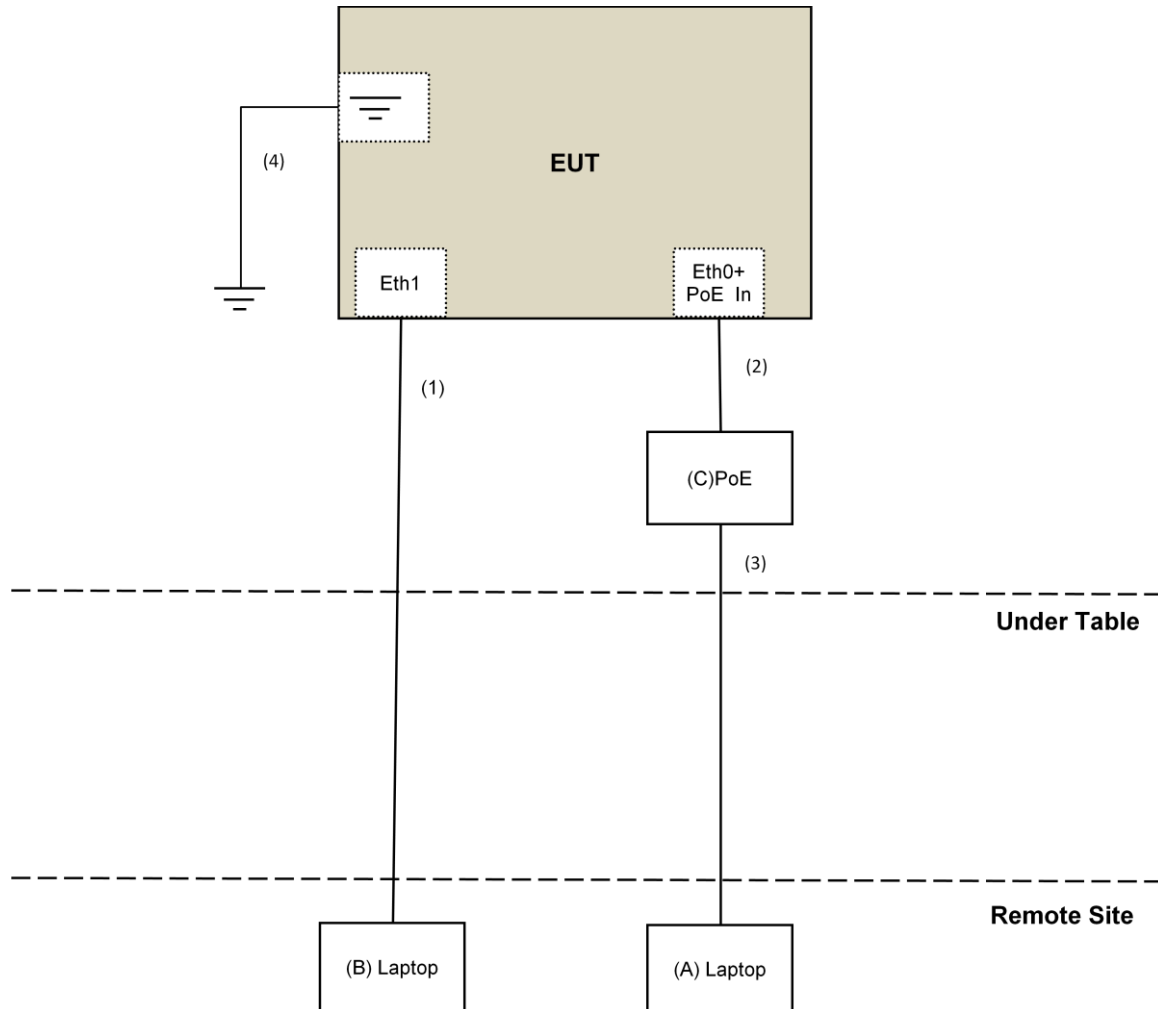

For other test:

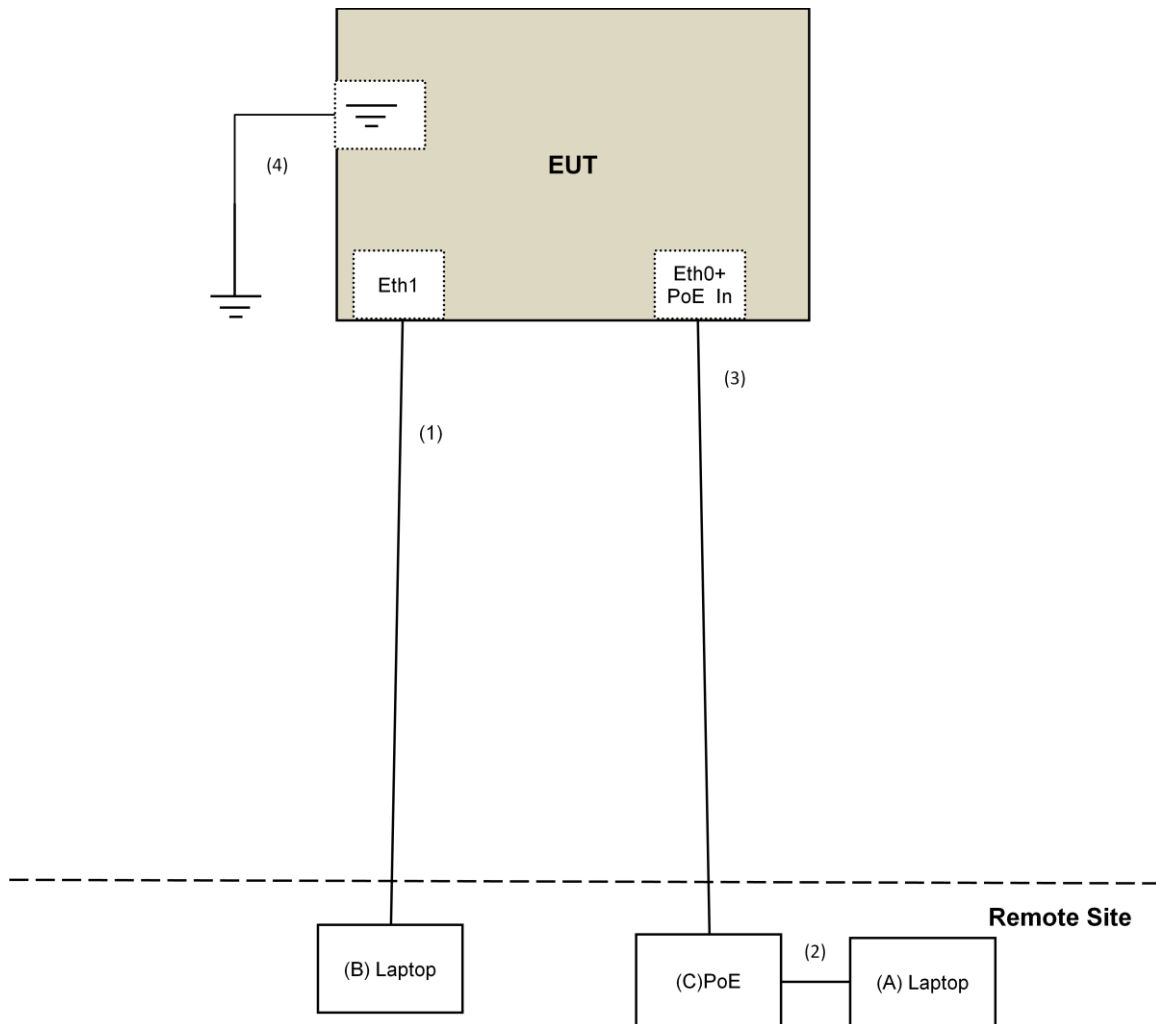

3.5 General Description of Applied Standards

The EUT is a RF Product. According to the specifications of the manufacturer, it must comply with the requirements of the following standards:

FCC Part 15, Subpart C (15.247)
KDB 558074 D01 DTS Meas Guidance v04
KDB 662911 D01 Multiple Transmitter Output v02r01
ANSI C63.10-2013

All test items have been performed and recorded as per the above standards.

NOTE: The EUT has been verified to comply with the requirements of FCC Part 15, Subpart B, Class B (DoC). The test report has been issued separately.

4 Test Types and Results

4.1 Radiated Emission and Bandedge Measurement

4.1.1 Limits of Radiated Emission and Bandedge Measurement

Radiated emissions which fall in the restricted bands must comply with the radiated emission limits specified as below table. Other emissions shall be at least 30dB below the highest level of the desired power:

Frequencies (MHz)	Field Strength (microvolts/meter)	Measurement Distance (meters)
0.009 ~ 0.490	2400/F(kHz)	300
0.490 ~ 1.705	24000/F(kHz)	30
1.705 ~ 30.0	30	30
30 ~ 88	100	3
88 ~ 216	150	3
216 ~ 960	200	3
Above 960	500	3

NOTE:

1. The lower limit shall apply at the transition frequencies.
2. Emission level (dBuV/m) = 20 log Emission level (uV/m).
3. For frequencies above 1000MHz, the field strength limits are based on average detector, however, the peak field strength of any emission shall not exceed the maximum permitted average limits, specified above by more than 20dB under any condition of modulation.

4.1.2 Test Instruments

For other test:

DESCRIPTION & MANUFACTURER	MODEL NO.	SERIAL NO.	CALIBRATED DATE	CALIBRATED UNTIL
Test Receiver Agilent	N9038A	MY50010156	July 12, 2017	July 11, 2018
Pre-Amplifier ^(*) EMCI	EMC001340	980142	Jan. 20, 2016	Jan. 19, 2018
Loop Antenna ^(*) Electro-Metrics	EM-6879	264	Dec. 16, 2016	Dec. 15, 2018
RF Cable	NA	LOOPCAB-001 LOOPCAB-002	Jan. 17, 2017	Jan. 16, 2018
Pre-Amplifier Mini-Circuits	ZFL-1000VH2B	AMP-ZFL-05	May 06, 2017	May 05, 2018
Trilog Broadband Antenna SCHWARZBECK	VULB 9168	9168-361	Dec. 29, 2016	Dec. 28, 2017
RF Cable	8D	966-3-1 966-3-2 966-3-3	Apr. 01, 2017	Mar. 31, 2018
Fixed attenuator Mini-Circuits	UNAT-5+	PAD-3m-3-01	Oct. 05, 2016	Oct. 04, 2017
Horn_Antenna SCHWARZBECK	BBHA9120-D	9120D-406	Dec. 28, 2016	Dec. 27, 2017
Pre-Amplifier EMCI	EMC12630SE	980384	Feb. 02, 2017	Feb. 01, 2018
RF Cable	EMC104-SM-SM-1200 EMC104-SM-SM-2000 EMC104-SM-SM-5000	160922 150317 150322	Feb. 02, 2017 Mar. 29, 2017 Mar. 29, 2017	Feb. 01, 2018 Mar. 28, 2018 Mar. 28, 2018
Spectrum Analyzer Keysight	N9030A	MY54490679	July 25, 2017	July 24, 2018
Pre-Amplifier EMCI	EMC184045SE	980386	Feb. 02, 2017	Feb. 01, 2018
Horn_Antenna SCHWARZBECK	BBHA 9170	BBHA9170608	Dec. 15, 2016	Dec. 14, 2017
RF Cable	SUCOFLEX 102	36432/2 36433/2	Jan. 15, 2017	Jan. 14, 2018
Software	ADT_Radiated_V8.7.08	NA	NA	NA
Antenna Tower & Turn Table Max-Full	MF-7802	MF780208406	NA	NA
Boresight Antenna Fixture	FBA-01	FBA-SIP01	NA	NA

Note:

1. The calibration interval of the above test instruments is 12 months and the calibrations are traceable to NML/ROC and NIST/USA.
2. *The calibration interval of the above test instruments is 24 months and the calibrations are traceable to NML/ROC and NIST/USA.
3. The test was performed in 966 Chamber No. 3.
4. Loop antenna was used for all emissions below 30 MHz.
5. The FCC Designation Number is TW2022.
6. The CANADA Site Registration No. is 20331-1.
7. Tested Date: Sep. 30 to Oct. 03, 2017.

For power test:

DESCRIPTION & MANUFACTURER	MODEL NO.	SERIAL NO.	CALIBRATED DATE	CALIBRATED UNTIL
Spectrum Analyzer R&S	FSV40	100964	July 1, 2017	June 30, 2018
Power meter Anritsu	ML2495A	1014008	May 11, 2017	May 10, 2018
Power sensor Anritsu	MA2411B	0917122	May 11, 2017	May 10, 2018

Note:

1. The calibration interval of the above test instruments is 12 months and the calibrations are traceable to NML/ROC and NIST/USA.
2. *The calibration interval of the above test instruments is 24 months and the calibrations are traceable to NML/ROC and NIST/USA.
3. The test was performed in 966 Chamber No. 3.
4. Loop antenna was used for all emissions below 30 MHz.
5. The FCC Designation Number is TW2022.
6. The CANADA Site Registration No. is 20331-1.
7. Tested Date: Oct. 05, 2017.

4.1.3 Test Procedures

For Radiated emission below 30MHz

- a. The EUT was placed on the top of a rotating table 0.8 meters above the ground at a 3 meter chamber room. The table was rotated 360 degrees to determine the position of the highest radiation.
- b. The EUT was set 3 meters away from the interference-receiving antenna, which was mounted on the top of a variable-height antenna tower.
- c. Both X and Y axes of the antenna are set to make the measurement.
- d. For each suspected emission, the EUT was arranged to its worst case and the rotatable table was turned from 0 degrees to 360 degrees to find the maximum reading.
- e. The test-receiver system was set to Quasi-Peak Detect Function and Specified Bandwidth with Maximum Hold Mode.

NOTE:

1. The resolution bandwidth and video bandwidth of test receiver/spectrum analyzer is 9kHz at frequency below 30MHz.

For Radiated emission above 30MHz

- a. The EUT was placed on the top of a rotating table 0.8 meters (for 30MHz ~ 1GHz) / 1.5 meters (for above 1GHz) above the ground at 3 meter chamber room for test. The table was rotated 360 degrees to determine the position of the highest radiation.
- b. The EUT was set 3 meters away from the interference-receiving antenna, which was mounted on the top of a variable-height antenna tower.
- c. The height of antenna is varied from one meter to four meters above the ground to determine the maximum value of the field strength. Both horizontal and vertical polarizations of the antenna are set to make the measurement.
- d. For each suspected emission, the EUT was arranged to its worst case and then the antenna was tuned to heights from 1 meter to 4 meters and the rotatable table was turned from 0 degrees to 360 degrees to find the maximum reading.
- e. The test-receiver system was set to quasi-peak detect function and specified bandwidth with maximum hold mode when the test frequency is below 1 GHz.
- f. The test-receiver system was set to peak and average detect function and specified bandwidth with maximum hold mode when the test frequency is above 1 GHz. If the peak reading value also meets average limit, measurement with the average detector is unnecessary.

Note:

1. The resolution bandwidth and video bandwidth of test receiver/spectrum analyzer is 120kHz for Quasi-peak detection (QP) at frequency below 1GHz.
2. The resolution bandwidth of test receiver/spectrum analyzer is 1 MHz and the video bandwidth is 3 MHz for Peak detection (PK) at frequency above 1GHz.
3. The resolution bandwidth of test receiver/spectrum analyzer is 1MHz and the video bandwidth is $\geq 1/T$ (Duty cycle < 98%) or 10Hz (Duty cycle $\geq 98\%$) for Average detection (AV) at frequency above 1GHz.
4. All modes of operation were investigated and the worst-case emissions are reported.

4.1.4 Deviation from Test Standard

No deviation.

4.1.5 Test Setup

For Radiated emission below 30MHz

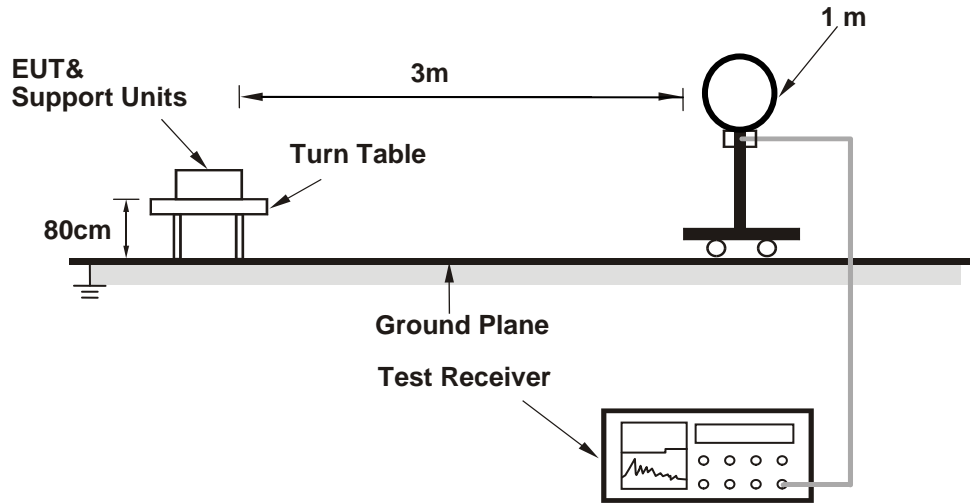

For Radiated emission 30MHz to 1GHz

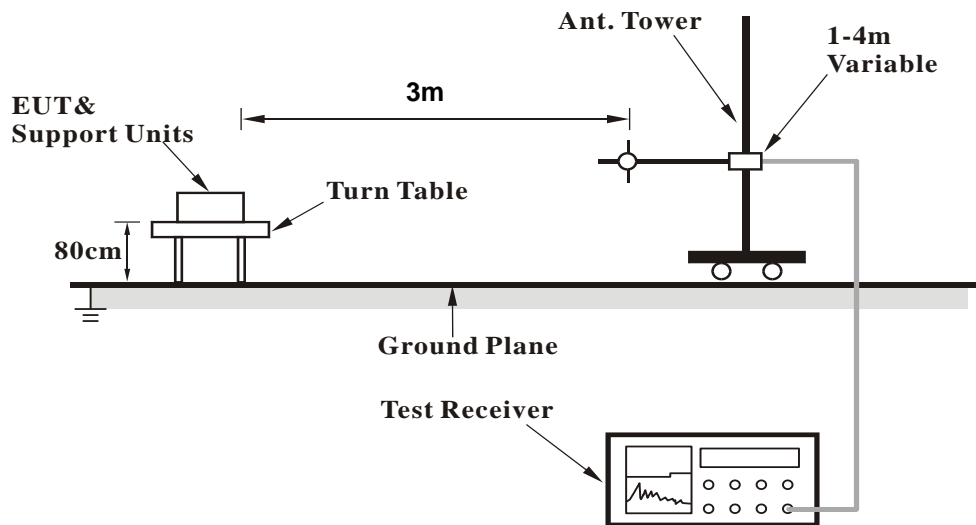

For Radiated emission above 1GHz

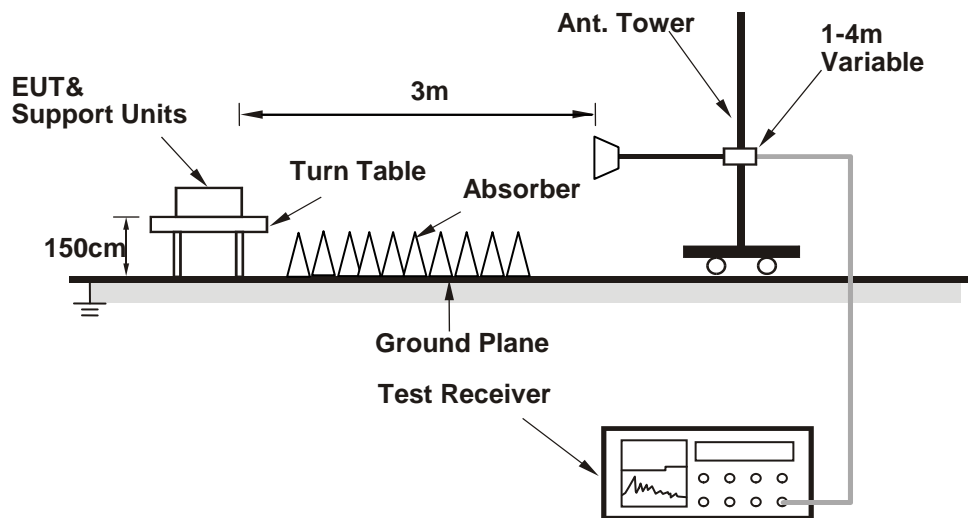

For the actual test configuration, please refer to the attached file (Test Setup Photo).

4.1.6 EUT Operating Conditions

- a. Connected the EUT with the Laptop which is placed on remote site.
- b. Controlling software (Mtool_2_0_0_7) has been activated to set the EUT on specific status.

4.1.7 Test Results (Mode 1)

Above 1GHz Data:

802.11b

CHANNEL	TX Channel 1	DETECTOR FUNCTION	Peak (PK)
FREQUENCY RANGE	1GHz ~ 25GHz		Average (AV)

ANTENNA POLARITY & TEST DISTANCE: HORIZONTAL AT 3 M

NO.	FREQ. (MHz)	EMISSION LEVEL (dBuV/m)	LIMIT (dBuV/m)	MARGIN (dB)	ANTENNA HEIGHT (m)	TABLE ANGLE (Degree)	RAW VALUE (dBuV)	CORRECTION FACTOR (dB/m)
1	2390.00	63.6 PK	74.0	-10.4	1.33 H	308	65.2	-1.6
2	2390.00	53.7 AV	54.0	-0.3	1.33 H	308	55.3	-1.6
3	*2412.00	118.5 PK			1.33 H	308	120.0	-1.5
4	*2412.00	116.1 AV			1.33 H	308	117.6	-1.5
5	4824.00	38.2 PK	74.0	-35.8	2.06 H	57	35.2	3.0
6	4824.00	35.1 AV	54.0	-18.9	2.06 H	57	32.1	3.0

ANTENNA POLARITY & TEST DISTANCE: VERTICAL AT 3 M

NO.	FREQ. (MHz)	EMISSION LEVEL (dBuV/m)	LIMIT (dBuV/m)	MARGIN (dB)	ANTENNA HEIGHT (m)	TABLE ANGLE (Degree)	RAW VALUE (dBuV)	CORRECTION FACTOR (dB/m)
1	2390.00	55.6 PK	74.0	-18.4	1.50 V	344	57.2	-1.6
2	2390.00	47.6 AV	54.0	-6.4	1.50 V	344	49.2	-1.6
3	*2412.00	112.2 PK			1.50 V	344	113.7	-1.5
4	*2412.00	110.0 AV			1.50 V	344	111.5	-1.5
5	4824.00	40.5 PK	74.0	-33.5	2.80 V	360	37.5	3.0
6	4824.00	33.6 AV	54.0	-20.4	2.80 V	360	30.6	3.0

REMARKS:

1. Emission Level(dBuV/m) = Raw Value(dBuV) + Correction Factor(dB/m)
2. Correction Factor(dB/m) = Antenna Factor(dB/m) + Cable Factor(dB) – Pre-Amplifier Factor(dB)
3. The other emission levels were very low against the limit.
4. Margin value = Emission Level – Limit value
5. " * ": Fundamental frequency.

CHANNEL	TX Channel 6	DETECTOR FUNCTION	Peak (PK)
FREQUENCY RANGE	1GHz ~ 25GHz		Average (AV)

ANTENNA POLARITY & TEST DISTANCE: HORIZONTAL AT 3 M

NO.	FREQ. (MHz)	EMISSION LEVEL (dBuV/m)	LIMIT (dBuV/m)	MARGIN (dB)	ANTENNA HEIGHT (m)	TABLE ANGLE (Degree)	RAW VALUE (dBuV)	CORRECTION FACTOR (dB/m)
1	2390.00	54.8 PK	74.0	-19.2	1.35 H	345	56.4	-1.6
2	2390.00	41.5 AV	54.0	-12.5	1.35 H	345	43.1	-1.6
3	*2437.00	119.3 PK			1.35 H	345	120.8	-1.5
4	*2437.00	117.2 AV			1.35 H	345	118.7	-1.5
5	2483.50	55.2 PK	74.0	-18.8	1.35 H	345	56.6	-1.4
6	2483.50	42.1 AV	54.0	-11.9	1.35 H	345	43.5	-1.4
7	4874.00	43.1 PK	74.0	-30.9	1.51 H	37	39.9	3.2
8	4874.00	40.9 AV	54.0	-13.1	1.51 H	37	37.7	3.2
9	7311.00	40.8 PK	74.0	-33.2	1.41 H	17	31.9	8.9
10	7311.00	33.6 AV	54.0	-20.4	1.41 H	17	24.7	8.9

ANTENNA POLARITY & TEST DISTANCE: VERTICAL AT 3 M

NO.	FREQ. (MHz)	EMISSION LEVEL (dBuV/m)	LIMIT (dBuV/m)	MARGIN (dB)	ANTENNA HEIGHT (m)	TABLE ANGLE (Degree)	RAW VALUE (dBuV)	CORRECTION FACTOR (dB/m)
1	2390.00	50.6 PK	74.0	-23.4	1.51 V	358	52.2	-1.6
2	2390.00	33.2 AV	54.0	-20.8	1.51 V	358	34.8	-1.6
3	*2437.00	113.0 PK			1.51 V	358	114.5	-1.5
4	*2437.00	111.1 AV			1.51 V	358	112.6	-1.5
5	2483.50	51.2 PK	74.0	-22.8	1.51 V	358	52.6	-1.4
6	2483.50	34.7 AV	54.0	-19.3	1.51 V	358	36.1	-1.4
7	4874.00	42.1 PK	74.0	-31.9	2.75 V	354	38.9	3.2
8	4874.00	40.1 AV	54.0	-13.9	2.75 V	354	36.9	3.2
9	7311.00	40.2 PK	74.0	-33.8	1.72 V	45	31.3	8.9
10	7311.00	33.2 AV	54.0	-20.8	1.72 V	45	24.3	8.9

REMARKS:

1. Emission Level(dBuV/m) = Raw Value(dBuV) + Correction Factor(dB/m)
2. Correction Factor(dB/m) = Antenna Factor(dB/m) + Cable Factor(dB) – Pre-Amplifier Factor(dB)
3. The other emission levels were very low against the limit.
4. Margin value = Emission Level – Limit value
5. " * ": Fundamental frequency.

CHANNEL	TX Channel 11	DETECTOR FUNCTION	Peak (PK)
FREQUENCY RANGE	1GHz ~ 25GHz		Average (AV)

ANTENNA POLARITY & TEST DISTANCE: HORIZONTAL AT 3 M

NO.	FREQ. (MHz)	EMISSION LEVEL (dBuV/m)	LIMIT (dBuV/m)	MARGIN (dB)	ANTENNA HEIGHT (m)	TABLE ANGLE (Degree)	RAW VALUE (dBuV)	CORRECTION FACTOR (dB/m)
1	*2462.00	118.6 PK			1.38 H	308	120.0	-1.4
2	*2462.00	116.3 AV			1.38 H	308	117.7	-1.4
3	2483.50	62.9 PK	74.0	-11.1	1.38 H	308	64.3	-1.4
4	2483.50	53.9 AV	54.0	-0.1	1.38 H	308	55.3	-1.4
5	4924.00	40.6 PK	74.0	-33.4	1.89 H	41	37.3	3.3
6	4924.00	39.1 AV	54.0	-14.9	1.89 H	41	35.8	3.3
7	7386.00	30.2 PK	74.0	-43.8	1.36 H	1	21.1	9.1
8	7386.00	28.2 AV	54.0	-25.8	1.36 H	1	19.1	9.1

ANTENNA POLARITY & TEST DISTANCE: VERTICAL AT 3 M

NO.	FREQ. (MHz)	EMISSION LEVEL (dBuV/m)	LIMIT (dBuV/m)	MARGIN (dB)	ANTENNA HEIGHT (m)	TABLE ANGLE (Degree)	RAW VALUE (dBuV)	CORRECTION FACTOR (dB/m)
1	*2462.00	112.3 PK			1.52 V	328	113.7	-1.4
2	*2462.00	110.2 AV			1.52 V	328	111.6	-1.4
3	2483.50	55.3 PK	74.0	-18.7	1.52 V	328	56.7	-1.4
4	2483.50	47.6 AV	54.0	-6.4	1.52 V	328	49.0	-1.4
5	4924.00	42.2 PK	74.0	-31.8	2.80 V	360	38.9	3.3
6	4924.00	40.4 AV	54.0	-13.6	2.80 V	360	37.1	3.3
7	7386.00	40.5 PK	74.0	-33.5	1.71 V	52	31.4	9.1
8	7386.00	33.7 AV	54.0	-20.3	1.71 V	52	24.6	9.1

REMARKS:

1. Emission Level(dBuV/m) = Raw Value(dBuV) + Correction Factor(dB/m)
2. Correction Factor(dB/m) = Antenna Factor(dB/m) + Cable Factor(dB) – Pre-Amplifier Factor(dB)
3. The other emission levels were very low against the limit.
4. Margin value = Emission Level – Limit value
5. " * ": Fundamental frequency.

802.11g

CHANNEL	TX Channel 1	DETECTOR FUNCTION	Peak (PK)
FREQUENCY RANGE	1GHz ~ 25GHz		Average (AV)

ANTENNA POLARITY & TEST DISTANCE: HORIZONTAL AT 3 M

NO.	FREQ. (MHz)	EMISSION LEVEL (dBuV/m)	LIMIT (dBuV/m)	MARGIN (dB)	ANTENNA HEIGHT (m)	TABLE ANGLE (Degree)	RAW VALUE (dBuV)	CORRECTION FACTOR (dB/m)
1	2390.00	73.7 PK	74.0	-0.3	1.36 H	308	75.3	-1.6
2	2390.00	52.2 AV	54.0	-1.8	1.36 H	308	53.8	-1.6
3	*2412.00	116.1 PK			1.36 H	308	117.6	-1.5
4	*2412.00	106.4 AV			1.36 H	308	107.9	-1.5
5	4824.00	36.5 PK	74.0	-37.5	2.18 H	137	33.5	3.0
6	4824.00	26.9 AV	54.0	-27.1	2.18 H	137	23.9	3.0

ANTENNA POLARITY & TEST DISTANCE: VERTICAL AT 3 M

NO.	FREQ. (MHz)	EMISSION LEVEL (dBuV/m)	LIMIT (dBuV/m)	MARGIN (dB)	ANTENNA HEIGHT (m)	TABLE ANGLE (Degree)	RAW VALUE (dBuV)	CORRECTION FACTOR (dB/m)
1	2390.00	69.8 PK	74.0	-4.2	1.47 V	344	71.4	-1.6
2	2390.00	48.6 AV	54.0	-5.4	1.47 V	344	50.2	-1.6
3	*2412.00	111.4 PK			1.47 V	344	112.9	-1.5
4	*2412.00	102.1 AV			1.47 V	344	103.6	-1.5
5	4824.00	36.3 PK	74.0	-37.7	1.45 V	305	33.3	3.0
6	4824.00	26.4 AV	54.0	-27.6	1.45 V	305	23.4	3.0

REMARKS:

1. Emission Level(dBuV/m) = Raw Value(dBuV) + Correction Factor(dB/m)
2. Correction Factor(dB/m) = Antenna Factor(dB/m) + Cable Factor(dB) – Pre-Amplifier Factor(dB)
3. The other emission levels were very low against the limit.
4. Margin value = Emission Level – Limit value
5. " * ": Fundamental frequency.

CHANNEL	TX Channel 6	DETECTOR FUNCTION	Peak (PK)
FREQUENCY RANGE	1GHz ~ 25GHz		Average (AV)

ANTENNA POLARITY & TEST DISTANCE: HORIZONTAL AT 3 M

NO.	FREQ. (MHz)	EMISSION LEVEL (dBuV/m)	LIMIT (dBuV/m)	MARGIN (dB)	ANTENNA HEIGHT (m)	TABLE ANGLE (Degree)	RAW VALUE (dBuV)	CORRECTION FACTOR (dB/m)
1	2390.00	73.6 PK	74.0	-0.4	1.30 H	307	75.2	-1.6
2	2390.00	52.0 AV	54.0	-2.0	1.30 H	307	53.6	-1.6
3	*2437.00	122.8 PK			1.30 H	307	124.3	-1.5
4	*2437.00	113.3 AV			1.30 H	307	114.8	-1.5
5	2483.50	70.7 PK	74.0	-3.3	1.30 H	307	72.1	-1.4
6	2483.50	50.4 AV	54.0	-3.6	1.30 H	307	51.8	-1.4
7	4874.00	36.9 PK	74.0	-37.1	2.14 H	154	33.7	3.2
8	4874.00	27.1 AV	54.0	-26.9	2.14 H	154	23.9	3.2
9	7311.00	41.5 PK	74.0	-32.5	1.46 H	220	32.6	8.9
10	7311.00	30.5 AV	54.0	-23.5	1.46 H	220	21.6	8.9

ANTENNA POLARITY & TEST DISTANCE: VERTICAL AT 3 M

NO.	FREQ. (MHz)	EMISSION LEVEL (dBuV/m)	LIMIT (dBuV/m)	MARGIN (dB)	ANTENNA HEIGHT (m)	TABLE ANGLE (Degree)	RAW VALUE (dBuV)	CORRECTION FACTOR (dB/m)
1	2390.00	69.4 PK	74.0	-4.6	1.64 V	344	71.0	-1.6
2	2390.00	50.8 AV	54.0	-3.2	1.64 V	344	52.4	-1.6
3	*2437.00	117.9 PK			1.64 V	344	119.4	-1.5
4	*2437.00	108.6 AV			1.64 V	344	110.1	-1.5
5	2483.50	69.5 PK	74.0	-4.5	1.64 V	344	70.9	-1.4
6	2483.50	49.1 AV	54.0	-4.9	1.64 V	344	50.5	-1.4
7	4874.00	36.1 PK	74.0	-37.9	1.43 V	302	32.9	3.2
8	4874.00	26.4 AV	54.0	-27.6	1.43 V	302	23.2	3.2
9	7311.00	42.3 PK	74.0	-31.7	2.10 V	179	33.4	8.9
10	7311.00	31.9 AV	54.0	-22.1	2.10 V	179	23.0	8.9

REMARKS:

1. Emission Level(dBuV/m) = Raw Value(dBuV) + Correction Factor(dB/m)
2. Correction Factor(dB/m) = Antenna Factor(dB/m) + Cable Factor(dB) – Pre-Amplifier Factor(dB)
3. The other emission levels were very low against the limit.
4. Margin value = Emission Level – Limit value
5. " * ": Fundamental frequency.

CHANNEL	TX Channel 11	DETECTOR FUNCTION	Peak (PK)
FREQUENCY RANGE	1GHz ~ 25GHz		Average (AV)

ANTENNA POLARITY & TEST DISTANCE: HORIZONTAL AT 3 M

NO.	FREQ. (MHz)	EMISSION LEVEL (dBuV/m)	LIMIT (dBuV/m)	MARGIN (dB)	ANTENNA HEIGHT (m)	TABLE ANGLE (Degree)	RAW VALUE (dBuV)	CORRECTION FACTOR (dB/m)
1	*2462.00	117.3 PK			1.27 H	303	118.7	-1.4
2	*2462.00	106.8 AV			1.27 H	303	108.2	-1.4
3	2483.50	73.8 PK	74.0	-0.2	1.27 H	303	75.2	-1.4
4	2483.50	53.7 AV	54.0	-0.3	1.27 H	303	55.1	-1.4
5	4924.00	36.4 PK	74.0	-37.6	2.17 H	129	33.1	3.3
6	4924.00	26.8 AV	54.0	-27.2	2.17 H	129	23.5	3.3
7	7386.00	42.1 PK	74.0	-31.9	1.45 H	236	33.0	9.1
8	7386.00	30.9 AV	54.0	-23.1	1.45 H	236	21.8	9.1

ANTENNA POLARITY & TEST DISTANCE: VERTICAL AT 3 M

NO.	FREQ. (MHz)	EMISSION LEVEL (dBuV/m)	LIMIT (dBuV/m)	MARGIN (dB)	ANTENNA HEIGHT (m)	TABLE ANGLE (Degree)	RAW VALUE (dBuV)	CORRECTION FACTOR (dB/m)
1	*2462.00	113.6 PK			1.38 V	342	115.0	-1.4
2	*2462.00	102.5 AV			1.38 V	342	103.9	-1.4
3	2483.50	70.5 PK	74.0	-3.5	1.38 V	342	71.9	-1.4
4	2483.50	50.4 AV	54.0	-3.6	1.38 V	342	51.8	-1.4
5	4924.00	36.4 PK	74.0	-37.6	1.38 V	290	33.1	3.3
6	4924.00	26.4 AV	54.0	-27.6	1.38 V	290	23.1	3.3
7	7386.00	42.1 PK	74.0	-31.9	2.11 V	176	33.0	9.1
8	7386.00	31.9 AV	54.0	-22.1	2.11 V	176	22.8	9.1

REMARKS:

1. Emission Level(dBuV/m) = Raw Value(dBuV) + Correction Factor(dB/m)
2. Correction Factor(dB/m) = Antenna Factor(dB/m) + Cable Factor(dB) – Pre-Amplifier Factor(dB)
3. The other emission levels were very low against the limit.
4. Margin value = Emission Level – Limit value
5. " * ": Fundamental frequency.

802.11n (HT20)

CHANNEL	TX Channel 1	DETECTOR FUNCTION	Peak (PK)
FREQUENCY RANGE	1GHz ~ 25GHz		Average (AV)

ANTENNA POLARITY & TEST DISTANCE: HORIZONTAL AT 3 M

NO.	FREQ. (MHz)	EMISSION LEVEL (dBuV/m)	LIMIT (dBuV/m)	MARGIN (dB)	ANTENNA HEIGHT (m)	TABLE ANGLE (Degree)	RAW VALUE (dBuV)	CORRECTION FACTOR (dB/m)
1	2390.00	73.5 PK	74.0	-0.5	1.28 H	303	75.1	-1.6
2	2390.00	51.8 AV	54.0	-2.2	1.28 H	303	53.4	-1.6
3	*2412.00	114.9 PK			1.28 H	303	116.4	-1.5
4	*2412.00	105.7 AV			1.28 H	303	107.2	-1.5
5	4824.00	36.4 PK	74.0	-37.6	2.23 H	150	33.4	3.0
6	4824.00	26.8 AV	54.0	-27.2	2.23 H	150	23.8	3.0

ANTENNA POLARITY & TEST DISTANCE: VERTICAL AT 3 M

NO.	FREQ. (MHz)	EMISSION LEVEL (dBuV/m)	LIMIT (dBuV/m)	MARGIN (dB)	ANTENNA HEIGHT (m)	TABLE ANGLE (Degree)	RAW VALUE (dBuV)	CORRECTION FACTOR (dB/m)
1	2390.00	69.4 PK	74.0	-4.6	1.51 V	354	71.0	-1.6
2	2390.00	50.6 AV	54.0	-3.4	1.51 V	354	52.2	-1.6
3	*2412.00	113.9 PK			1.51 V	354	115.4	-1.5
4	*2412.00	102.3 AV			1.51 V	354	103.8	-1.5
5	4824.00	36.3 PK	74.0	-37.7	1.46 V	295	33.3	3.0
6	4824.00	26.8 AV	54.0	-27.2	1.46 V	295	23.8	3.0

REMARKS:

1. Emission Level(dBuV/m) = Raw Value(dBuV) + Correction Factor(dB/m)
2. Correction Factor(dB/m) = Antenna Factor(dB/m) + Cable Factor(dB) – Pre-Amplifier Factor(dB)
3. The other emission levels were very low against the limit.
4. Margin value = Emission Level – Limit value
5. " * ": Fundamental frequency.

CHANNEL	TX Channel 6	DETECTOR FUNCTION	Peak (PK)
FREQUENCY RANGE	1GHz ~ 25GHz		Average (AV)

ANTENNA POLARITY & TEST DISTANCE: HORIZONTAL AT 3 M

NO.	FREQ. (MHz)	EMISSION LEVEL (dBuV/m)	LIMIT (dBuV/m)	MARGIN (dB)	ANTENNA HEIGHT (m)	TABLE ANGLE (Degree)	RAW VALUE (dBuV)	CORRECTION FACTOR (dB/m)
1	*2437.00	121.3 PK			1.31 H	304	122.8	-1.5
2	*2437.00	111.1 AV			1.31 H	304	112.6	-1.5
3	2483.50	72.7 PK	74.0	-1.3	1.31 H	304	74.1	-1.4
4	2483.50	53.8 AV	54.0	-0.2	1.31 H	304	55.2	-1.4
5	4874.00	36.6 PK	74.0	-37.4	2.18 H	149	33.4	3.2
6	4874.00	26.9 AV	54.0	-27.1	2.18 H	149	23.7	3.2
7	7311.00	41.6 PK	74.0	-32.4	1.47 H	244	32.7	8.9
8	7311.00	30.4 AV	54.0	-23.6	1.47 H	244	21.5	8.9

ANTENNA POLARITY & TEST DISTANCE: VERTICAL AT 3 M

NO.	FREQ. (MHz)	EMISSION LEVEL (dBuV/m)	LIMIT (dBuV/m)	MARGIN (dB)	ANTENNA HEIGHT (m)	TABLE ANGLE (Degree)	RAW VALUE (dBuV)	CORRECTION FACTOR (dB/m)
1	2390.00	69.7 PK	74.0	-4.3	1.68 V	350	71.3	-1.6
2	2390.00	50.9 AV	54.0	-3.1	1.68 V	350	52.5	-1.6
3	*2437.00	117.6 PK			1.68 V	350	119.1	-1.5
4	*2437.00	108.1 AV			1.68 V	350	109.6	-1.5
5	2483.50	70.2 PK	74.0	-3.8	1.68 V	350	71.6	-1.4
6	2483.50	49.6 AV	54.0	-4.4	1.68 V	350	51.0	-1.4
7	4874.00	36.2 PK	74.0	-37.8	1.51 V	287	33.0	3.2
8	4874.00	26.3 AV	54.0	-27.7	1.51 V	287	23.1	3.2
9	7311.00	41.7 PK	74.0	-32.3	2.12 V	178	32.8	8.9
10	7311.00	31.6 AV	54.0	-22.4	2.12 V	178	22.7	8.9

REMARKS:

1. Emission Level(dBuV/m) = Raw Value(dBuV) + Correction Factor(dB/m)
2. Correction Factor(dB/m) = Antenna Factor(dB/m) + Cable Factor(dB) – Pre-Amplifier Factor(dB)
3. The other emission levels were very low against the limit.
4. Margin value = Emission Level – Limit value
5. " * ": Fundamental frequency.

CHANNEL	TX Channel 11	DETECTOR FUNCTION	Peak (PK)
FREQUENCY RANGE	1GHz ~ 25GHz		Average (AV)

ANTENNA POLARITY & TEST DISTANCE: HORIZONTAL AT 3 M

NO.	FREQ. (MHz)	EMISSION LEVEL (dBuV/m)	LIMIT (dBuV/m)	MARGIN (dB)	ANTENNA HEIGHT (m)	TABLE ANGLE (Degree)	RAW VALUE (dBuV)	CORRECTION FACTOR (dB/m)
1	*2462.00	115.8 PK			1.25 H	302	117.2	-1.4
2	*2462.00	106.1 AV			1.25 H	302	107.5	-1.4
3	2483.50	72.8 PK	74.0	-1.2	1.25 H	302	74.2	-1.4
4	2483.50	53.8 AV	54.0	-0.2	1.25 H	302	55.2	-1.4
5	4924.00	36.4 PK	74.0	-37.6	2.21 H	128	33.1	3.3
6	4924.00	26.6 AV	54.0	-27.4	2.21 H	128	23.3	3.3
7	7386.00	41.7 PK	74.0	-32.3	1.49 H	227	32.6	9.1
8	7386.00	30.8 AV	54.0	-23.2	1.49 H	227	21.7	9.1

ANTENNA POLARITY & TEST DISTANCE: VERTICAL AT 3 M

NO.	FREQ. (MHz)	EMISSION LEVEL (dBuV/m)	LIMIT (dBuV/m)	MARGIN (dB)	ANTENNA HEIGHT (m)	TABLE ANGLE (Degree)	RAW VALUE (dBuV)	CORRECTION FACTOR (dB/m)
1	*2462.00	114.1 PK			1.54 V	360	115.5	-1.4
2	*2462.00	103.0 AV			1.54 V	360	104.4	-1.4
3	2483.50	71.0 PK	74.0	-3.0	1.54 V	360	72.4	-1.4
4	2483.50	51.0 AV	54.0	-3.0	1.54 V	360	52.4	-1.4
5	4924.00	35.5 PK	74.0	-38.5	1.40 V	287	32.2	3.3
6	4924.00	26.1 AV	54.0	-27.9	1.40 V	287	22.8	3.3
7	7386.00	41.8 PK	74.0	-32.2	2.13 V	189	32.7	9.1
8	7386.00	31.4 AV	54.0	-22.6	2.13 V	189	22.3	9.1

REMARKS:

1. Emission Level(dBuV/m) = Raw Value(dBuV) + Correction Factor(dB/m)
2. Correction Factor(dB/m) = Antenna Factor(dB/m) + Cable Factor(dB) – Pre-Amplifier Factor(dB)
3. The other emission levels were very low against the limit.
4. Margin value = Emission Level – Limit value
5. " * ": Fundamental frequency.

802.11n (HT40)

CHANNEL	TX Channel 3	DETECTOR FUNCTION	Peak (PK)
FREQUENCY RANGE	1GHz ~ 25GHz		Average (AV)

ANTENNA POLARITY & TEST DISTANCE: HORIZONTAL AT 3 M								
NO.	FREQ. (MHz)	EMISSION LEVEL (dBuV/m)	LIMIT (dBuV/m)	MARGIN (dB)	ANTENNA HEIGHT (m)	TABLE ANGLE (Degree)	RAW VALUE (dBuV)	CORRECTION FACTOR (dB/m)
1	2390.00	67.9 PK	74.0	-6.1	1.14 H	298	69.5	-1.6
2	2390.00	53.8 AV	54.0	-0.2	1.14 H	298	55.4	-1.6
3	*2422.00	109.5 PK			1.14 H	298	111.1	-1.6
4	*2422.00	99.3 AV			1.14 H	298	100.9	-1.6
5	4844.00	37.1 PK	74.0	-36.9	2.22 H	149	34.0	3.1
6	4844.00	27.1 AV	54.0	-26.9	2.22 H	149	24.0	3.1
7	7266.00	41.8 PK	74.0	-32.2	1.47 H	242	32.9	8.9
8	7266.00	30.7 AV	54.0	-23.3	1.47 H	242	21.8	8.9

ANTENNA POLARITY & TEST DISTANCE: VERTICAL AT 3 M								
NO.	FREQ. (MHz)	EMISSION LEVEL (dBuV/m)	LIMIT (dBuV/m)	MARGIN (dB)	ANTENNA HEIGHT (m)	TABLE ANGLE (Degree)	RAW VALUE (dBuV)	CORRECTION FACTOR (dB/m)
1	2390.00	68.4 PK	74.0	-5.6	1.55 V	360	70.0	-1.6
2	2390.00	48.9 AV	54.0	-5.1	1.55 V	360	50.5	-1.6
3	*2422.00	107.5 PK			1.55 V	360	109.1	-1.6
4	*2422.00	96.2 AV			1.55 V	360	97.8	-1.6
5	4844.00	35.8 PK	74.0	-38.2	1.45 V	313	32.7	3.1
6	4844.00	26.4 AV	54.0	-27.6	1.45 V	313	23.3	3.1
7	7266.00	42.3 PK	74.0	-31.7	2.15 V	185	33.4	8.9
8	7266.00	31.8 AV	54.0	-22.2	2.15 V	185	22.9	8.9

REMARKS:

1. Emission Level(dBuV/m) = Raw Value(dBuV) + Correction Factor(dB/m)
2. Correction Factor(dB/m) = Antenna Factor(dB/m) + Cable Factor(dB) – Pre-Amplifier Factor(dB)
3. The other emission levels were very low against the limit.
4. Margin value = Emission Level – Limit value
5. " * ": Fundamental frequency.

CHANNEL	TX Channel 6	DETECTOR FUNCTION	Peak (PK)
FREQUENCY RANGE	1GHz ~ 25GHz		Average (AV)

ANTENNA POLARITY & TEST DISTANCE: HORIZONTAL AT 3 M

NO.	FREQ. (MHz)	EMISSION LEVEL (dBuV/m)	LIMIT (dBuV/m)	MARGIN (dB)	ANTENNA HEIGHT (m)	TABLE ANGLE (Degree)	RAW VALUE (dBuV)	CORRECTION FACTOR (dB/m)
1	2390.00	69.6 PK	74.0	-4.4	1.15 H	302	71.2	-1.6
2	2390.00	53.8 AV	54.0	-0.2	1.15 H	302	55.4	-1.6
3	*2437.00	111.4 PK			1.15 H	302	112.9	-1.5
4	*2437.00	101.6 AV			1.15 H	302	103.1	-1.5
5	2483.50	66.8 PK	74.0	-7.2	1.15 H	302	68.2	-1.4
6	2483.50	49.6 AV	54.0	-4.4	1.15 H	302	51.0	-1.4
7	4874.00	36.5 PK	74.0	-37.5	2.17 H	142	33.3	3.2
8	4874.00	26.7 AV	54.0	-27.3	2.17 H	142	23.5	3.2
9	7311.00	41.9 PK	74.0	-32.1	1.44 H	232	33.0	8.9
10	7311.00	30.8 AV	54.0	-23.2	1.44 H	232	21.9	8.9

ANTENNA POLARITY & TEST DISTANCE: VERTICAL AT 3 M

NO.	FREQ. (MHz)	EMISSION LEVEL (dBuV/m)	LIMIT (dBuV/m)	MARGIN (dB)	ANTENNA HEIGHT (m)	TABLE ANGLE (Degree)	RAW VALUE (dBuV)	CORRECTION FACTOR (dB/m)
1	2390.00	68.2 PK	74.0	-5.8	1.44 V	360	69.8	-1.6
2	2390.00	48.4 AV	54.0	-5.6	1.44 V	360	50.0	-1.6
3	*2437.00	110.2 PK			1.44 V	360	111.7	-1.5
4	*2437.00	99.0 AV			1.44 V	360	100.5	-1.5
5	2483.50	69.9 PK	74.0	-4.1	1.44 V	360	71.3	-1.4
6	2483.50	49.3 AV	54.0	-4.7	1.44 V	360	50.7	-1.4
7	4874.00	35.9 PK	74.0	-38.1	1.47 V	294	32.7	3.2
8	4874.00	25.9 AV	54.0	-28.1	1.47 V	294	22.7	3.2
9	7311.00	42.2 PK	74.0	-31.8	2.16 V	190	33.3	8.9
10	7311.00	31.9 AV	54.0	-22.1	2.16 V	190	23.0	8.9

REMARKS:

1. Emission Level(dBuV/m) = Raw Value(dBuV) + Correction Factor(dB/m)
2. Correction Factor(dB/m) = Antenna Factor(dB/m) + Cable Factor(dB) – Pre-Amplifier Factor(dB)
3. The other emission levels were very low against the limit.
4. Margin value = Emission Level – Limit value
5. " * ": Fundamental frequency.

CHANNEL	TX Channel 9	DETECTOR FUNCTION	Peak (PK)
FREQUENCY RANGE	1GHz ~ 25GHz		Average (AV)

ANTENNA POLARITY & TEST DISTANCE: HORIZONTAL AT 3 M

NO.	FREQ. (MHz)	EMISSION LEVEL (dBuV/m)	LIMIT (dBuV/m)	MARGIN (dB)	ANTENNA HEIGHT (m)	TABLE ANGLE (Degree)	RAW VALUE (dBuV)	CORRECTION FACTOR (dB/m)
1	*2452.00	109.2 PK			1.16 H	302	110.7	-1.5
2	*2452.00	99.4 AV			1.16 H	302	100.9	-1.5
3	2483.50	61.3 PK	74.0	-12.7	1.16 H	302	62.7	-1.4
4	2483.50	53.6 AV	54.0	-0.4	1.16 H	302	55.0	-1.4
5	4904.00	36.7 PK	74.0	-37.3	2.11 H	145	33.5	3.2
6	4904.00	26.6 AV	54.0	-27.4	2.11 H	145	23.4	3.2
7	7356.00	41.3 PK	74.0	-32.7	1.41 H	236	32.2	9.1
8	7356.00	30.4 AV	54.0	-23.6	1.41 H	236	21.3	9.1

ANTENNA POLARITY & TEST DISTANCE: VERTICAL AT 3 M

NO.	FREQ. (MHz)	EMISSION LEVEL (dBuV/m)	LIMIT (dBuV/m)	MARGIN (dB)	ANTENNA HEIGHT (m)	TABLE ANGLE (Degree)	RAW VALUE (dBuV)	CORRECTION FACTOR (dB/m)
1	*2452.00	107.6 PK			1.51 V	360	109.1	-1.5
2	*2452.00	96.1 AV			1.51 V	360	97.6	-1.5
3	2483.50	68.9 PK	74.0	-5.1	1.51 V	360	70.3	-1.4
4	2483.50	49.0 AV	54.0	-5.0	1.51 V	360	50.4	-1.4
5	4904.00	36.4 PK	74.0	-37.6	1.42 V	298	33.2	3.2
6	4904.00	26.9 AV	54.0	-27.1	1.42 V	298	23.7	3.2
7	7356.00	42.8 PK	74.0	-31.2	2.15 V	171	33.7	9.1
8	7356.00	32.3 AV	54.0	-21.7	2.15 V	171	23.2	9.1

REMARKS:

1. Emission Level(dBuV/m) = Raw Value(dBuV) + Correction Factor(dB/m)
2. Correction Factor(dB/m) = Antenna Factor(dB/m) + Cable Factor(dB) – Pre-Amplifier Factor(dB)
3. The other emission levels were very low against the limit.
4. Margin value = Emission Level – Limit value
5. " * ": Fundamental frequency.

Below 1GHz Data:

802.11b

CHANNEL	TX Channel 6	DETECTOR FUNCTION	Quasi-Peak (QP)
FREQUENCY RANGE	9kHz ~ 1GHz		

ANTENNA POLARITY & TEST DISTANCE: HORIZONTAL AT 3 M

NO.	FREQ. (MHz)	EMISSION LEVEL (dBuV/m)	LIMIT (dBuV/m)	MARGIN (dB)	ANTENNA HEIGHT (m)	TABLE ANGLE (Degree)	RAW VALUE (dBuV)	CORRECTION FACTOR (dB/m)
1	50.49	28.8 QP	40.0	-11.2	3.00 H	38	37.1	-8.3
2	108.42	32.1 QP	43.5	-11.4	3.00 H	278	43.3	-11.2
3	221.38	37.9 QP	46.0	-8.1	1.00 H	86	49.0	-11.1
4	252.88	31.2 QP	46.0	-14.8	1.00 H	1	40.6	-9.4
5	341.25	35.8 QP	46.0	-10.2	3.00 H	78	42.3	-6.5
6	461.02	42.6 QP	46.0	-3.4	1.00 H	0	46.3	-3.7

ANTENNA POLARITY & TEST DISTANCE: VERTICAL AT 3 M

NO.	FREQ. (MHz)	EMISSION LEVEL (dBuV/m)	LIMIT (dBuV/m)	MARGIN (dB)	ANTENNA HEIGHT (m)	TABLE ANGLE (Degree)	RAW VALUE (dBuV)	CORRECTION FACTOR (dB/m)
1	62.52	36.3 QP	40.0	-3.7	1.50 V	223	45.6	-9.3
2	91.20	35.0 QP	43.5	-8.5	2.50 V	123	48.8	-13.8
3	179.62	32.2 QP	43.5	-11.3	2.00 V	264	41.9	-9.7
4	384.69	42.5 QP	46.0	-3.5	2.00 V	238	48.2	-5.7
5	438.64	42.4 QP	46.0	-3.6	3.00 V	182	46.3	-3.9
6	550.87	34.2 QP	46.0	-11.8	2.00 V	360	36.4	-2.2

REMARKS:

1. Emission Level(dBuV/m) = Raw Value(dBuV) + Correction Factor(dB/m)
2. Correction Factor(dB/m) = Antenna Factor(dB/m) + Cable Factor(dB) – Pre-Amplifier Factor(dB)
3. The other emission levels were very low against the limit.
4. Margin value = Emission Level – Limit value

4.1.8 Test Results (Mode 2)

Above 1GHz Data:

802.11b

CHANNEL	TX Channel 1	DETECTOR FUNCTION	Peak (PK)
FREQUENCY RANGE	1GHz ~ 25GHz		Average (AV)

ANTENNA POLARITY & TEST DISTANCE: HORIZONTAL AT 3 M

NO.	FREQ. (MHz)	EMISSION LEVEL (dBuV/m)	LIMIT (dBuV/m)	MARGIN (dB)	ANTENNA HEIGHT (m)	TABLE ANGLE (Degree)	RAW VALUE (dBuV)	CORRECTION FACTOR (dB/m)
1	2390.00	61.9 PK	74.0	-12.1	1.15 H	306	63.5	-1.6
2	2390.00	53.9 AV	54.0	-0.1	1.15 H	306	55.5	-1.6
3	*2412.00	116.1 PK			1.15 H	306	117.6	-1.5
4	*2412.00	113.7 AV			1.15 H	306	115.2	-1.5
5	4824.00	47.9 PK	74.0	-26.1	1.95 H	3	44.9	3.0
6	4824.00	45.7 AV	54.0	-8.3	1.95 H	3	42.7	3.0

ANTENNA POLARITY & TEST DISTANCE: VERTICAL AT 3 M

NO.	FREQ. (MHz)	EMISSION LEVEL (dBuV/m)	LIMIT (dBuV/m)	MARGIN (dB)	ANTENNA HEIGHT (m)	TABLE ANGLE (Degree)	RAW VALUE (dBuV)	CORRECTION FACTOR (dB/m)
1	2390.00	61.1 PK	74.0	-12.9	3.90 V	341	62.7	-1.6
2	2390.00	53.1 AV	54.0	-0.9	3.90 V	341	54.7	-1.6
3	*2412.00	112.1 PK			3.90 V	341	113.6	-1.5
4	*2412.00	109.7 AV			3.90 V	341	111.2	-1.5
5	4824.00	46.5 PK	74.0	-27.5	3.92 V	360	43.5	3.0
6	4824.00	43.0 AV	54.0	-11.0	3.92 V	360	40.0	3.0

REMARKS:

1. Emission Level(dBuV/m) = Raw Value(dBuV) + Correction Factor(dB/m)
2. Correction Factor(dB/m) = Antenna Factor(dB/m) + Cable Factor(dB) – Pre-Amplifier Factor(dB)
3. The other emission levels were very low against the limit.
4. Margin value = Emission Level – Limit value
5. " * ": Fundamental frequency.

CHANNEL	TX Channel 6	DETECTOR FUNCTION	Peak (PK)
FREQUENCY RANGE	1GHz ~ 25GHz		Average (AV)

ANTENNA POLARITY & TEST DISTANCE: HORIZONTAL AT 3 M

NO.	FREQ. (MHz)	EMISSION LEVEL (dBuV/m)	LIMIT (dBuV/m)	MARGIN (dB)	ANTENNA HEIGHT (m)	TABLE ANGLE (Degree)	RAW VALUE (dBuV)	CORRECTION FACTOR (dB/m)
1	2390.00	55.2 PK	74.0	-18.8	1.13 H	298	56.8	-1.6
2	2390.00	43.4 AV	54.0	-10.6	1.13 H	298	45.0	-1.6
3	*2437.00	119.1 PK			1.13 H	298	120.6	-1.5
4	*2437.00	116.8 AV			1.13 H	298	118.3	-1.5
5	2483.50	56.1 PK	74.0	-17.9	1.13 H	298	57.5	-1.4
6	2483.50	43.9 AV	54.0	-10.1	1.13 H	298	45.3	-1.4
7	4874.00	48.1 PK	74.0	-25.9	1.92 H	41	44.9	3.2
8	4874.00	45.9 AV	54.0	-8.1	1.92 H	41	42.7	3.2
9	7311.00	42.2 PK	74.0	-31.8	1.24 H	58	33.3	8.9
10	7311.00	28.9 AV	54.0	-25.1	1.24 H	58	20.0	8.9

ANTENNA POLARITY & TEST DISTANCE: VERTICAL AT 3 M

NO.	FREQ. (MHz)	EMISSION LEVEL (dBuV/m)	LIMIT (dBuV/m)	MARGIN (dB)	ANTENNA HEIGHT (m)	TABLE ANGLE (Degree)	RAW VALUE (dBuV)	CORRECTION FACTOR (dB/m)
1	2390.00	54.4 PK	74.0	-19.6	3.99 V	345	56.0	-1.6
2	2390.00	42.5 AV	54.0	-11.5	3.99 V	345	44.1	-1.6
3	*2437.00	115.0 PK			3.99 V	345	116.5	-1.5
4	*2437.00	112.8 AV			3.99 V	345	114.3	-1.5
5	2483.50	55.6 PK	74.0	-18.4	3.99 V	345	57.0	-1.4
6	2483.50	43.1 AV	54.0	-10.9	3.99 V	345	44.5	-1.4
7	4874.00	46.3 PK	74.0	-27.7	3.87 V	360	43.1	3.2
8	4874.00	43.1 AV	54.0	-10.9	3.87 V	360	39.9	3.2
9	7311.00	41.4 PK	74.0	-32.6	1.81 V	254	32.5	8.9
10	7311.00	28.6 AV	54.0	-25.4	1.81 V	254	19.7	8.9

REMARKS:

1. Emission Level(dBuV/m) = Raw Value(dBuV) + Correction Factor(dB/m)
2. Correction Factor(dB/m) = Antenna Factor(dB/m) + Cable Factor(dB) – Pre-Amplifier Factor(dB)
3. The other emission levels were very low against the limit.
4. Margin value = Emission Level – Limit value
5. " * ": Fundamental frequency.

CHANNEL	TX Channel 11	DETECTOR FUNCTION	Peak (PK)
FREQUENCY RANGE	1GHz ~ 25GHz		Average (AV)

ANTENNA POLARITY & TEST DISTANCE: HORIZONTAL AT 3 M

NO.	FREQ. (MHz)	EMISSION LEVEL (dBuV/m)	LIMIT (dBuV/m)	MARGIN (dB)	ANTENNA HEIGHT (m)	TABLE ANGLE (Degree)	RAW VALUE (dBuV)	CORRECTION FACTOR (dB/m)
1	*2462.00	116.7 PK			1.14 H	302	118.1	-1.4
2	*2462.00	114.5 AV			1.14 H	302	115.9	-1.4
3	2486.00	61.7 PK	74.0	-12.3	1.14 H	302	63.1	-1.4
4	2486.00	53.8 AV	54.0	-0.2	1.14 H	302	55.2	-1.4
5	4924.00	47.8 PK	74.0	-26.2	1.95 H	25	44.5	3.3
6	4924.00	45.2 AV	54.0	-8.8	1.95 H	25	41.9	3.3
7	7386.00	41.0 PK	74.0	-33.0	1.18 H	60	31.9	9.1
8	7386.00	27.8 AV	54.0	-26.2	1.18 H	60	18.7	9.1

ANTENNA POLARITY & TEST DISTANCE: VERTICAL AT 3 M

NO.	FREQ. (MHz)	EMISSION LEVEL (dBuV/m)	LIMIT (dBuV/m)	MARGIN (dB)	ANTENNA HEIGHT (m)	TABLE ANGLE (Degree)	RAW VALUE (dBuV)	CORRECTION FACTOR (dB/m)
1	*2462.00	112.6 PK			3.93 V	331	114.0	-1.4
2	*2462.00	110.5 AV			3.93 V	331	111.9	-1.4
3	2483.50	61.1 PK	74.0	-12.9	3.93 V	331	62.5	-1.4
4	2483.50	53.0 AV	54.0	-1.0	3.93 V	331	54.4	-1.4
5	4924.00	46.4 PK	74.0	-27.6	3.88 V	360	43.1	3.3
6	4924.00	42.9 AV	54.0	-11.1	3.88 V	360	39.6	3.3
7	7386.00	41.0 PK	74.0	-33.0	1.76 V	278	31.9	9.1
8	7386.00	27.8 AV	54.0	-26.2	1.76 V	278	18.7	9.1

REMARKS:

1. Emission Level(dBuV/m) = Raw Value(dBuV) + Correction Factor(dB/m)
2. Correction Factor(dB/m) = Antenna Factor(dB/m) + Cable Factor(dB) – Pre-Amplifier Factor(dB)
3. The other emission levels were very low against the limit.
4. Margin value = Emission Level – Limit value
5. " * ": Fundamental frequency.

802.11g

CHANNEL	TX Channel 1	DETECTOR FUNCTION	Peak (PK)
FREQUENCY RANGE	1GHz ~ 25GHz		Average (AV)

ANTENNA POLARITY & TEST DISTANCE: HORIZONTAL AT 3 M

NO.	FREQ. (MHz)	EMISSION LEVEL (dBuV/m)	LIMIT (dBuV/m)	MARGIN (dB)	ANTENNA HEIGHT (m)	TABLE ANGLE (Degree)	RAW VALUE (dBuV)	CORRECTION FACTOR (dB/m)
1	2390.00	73.4 PK	74.0	-0.6	1.53 H	55	75.0	-1.6
2	2390.00	53.8 AV	54.0	-0.2	1.53 H	55	55.4	-1.6
3	*2412.00	112.8 PK			1.53 H	55	114.3	-1.5
4	*2412.00	102.6 AV			1.53 H	55	104.1	-1.5
5	4824.00	47.5 PK	74.0	-26.5	1.97 H	10	44.5	3.0
6	4824.00	45.6 AV	54.0	-8.4	1.97 H	10	42.6	3.0

ANTENNA POLARITY & TEST DISTANCE: VERTICAL AT 3 M

NO.	FREQ. (MHz)	EMISSION LEVEL (dBuV/m)	LIMIT (dBuV/m)	MARGIN (dB)	ANTENNA HEIGHT (m)	TABLE ANGLE (Degree)	RAW VALUE (dBuV)	CORRECTION FACTOR (dB/m)
1	2390.00	72.6 PK	74.0	-1.4	3.85 V	348	74.2	-1.6
2	2390.00	52.9 AV	54.0	-1.1	3.85 V	348	54.5	-1.6
3	*2412.00	108.7 PK			3.85 V	348	110.2	-1.5
4	*2412.00	98.6 AV			3.85 V	348	100.1	-1.5
5	4824.00	46.3 PK	74.0	-27.7	3.88 V	349	43.3	3.0
6	4824.00	42.9 AV	54.0	-11.1	3.88 V	349	39.9	3.0

REMARKS:

1. Emission Level(dBuV/m) = Raw Value(dBuV) + Correction Factor(dB/m)
2. Correction Factor(dB/m) = Antenna Factor(dB/m) + Cable Factor(dB) – Pre-Amplifier Factor(dB)
3. The other emission levels were very low against the limit.
4. Margin value = Emission Level – Limit value
5. " * ": Fundamental frequency.

CHANNEL	TX Channel 6	DETECTOR FUNCTION	Peak (PK)
FREQUENCY RANGE	1GHz ~ 25GHz		Average (AV)

ANTENNA POLARITY & TEST DISTANCE: HORIZONTAL AT 3 M

NO.	FREQ. (MHz)	EMISSION LEVEL (dBuV/m)	LIMIT (dBuV/m)	MARGIN (dB)	ANTENNA HEIGHT (m)	TABLE ANGLE (Degree)	RAW VALUE (dBuV)	CORRECTION FACTOR (dB/m)
1	2388.00	68.8 PK	74.0	-5.2	1.52 H	53	70.4	-1.6
2	2388.00	53.8 AV	54.0	-0.2	1.52 H	53	55.4	-1.6
3	*2437.00	120.3 PK			1.52 H	53	121.8	-1.5
4	*2437.00	112.2 AV			1.52 H	53	113.7	-1.5
5	2485.00	64.3 PK	74.0	-9.7	1.52 H	53	65.7	-1.4
6	2485.00	47.7 AV	54.0	-6.3	1.52 H	53	49.1	-1.4
7	4874.00	48.1 PK	74.0	-25.9	1.89 H	26	44.9	3.2
8	4874.00	46.0 AV	54.0	-8.0	1.89 H	26	42.8	3.2
9	7311.00	42.3 PK	74.0	-31.7	1.21 H	50	33.4	8.9
10	7311.00	29.0 AV	54.0	-25.0	1.21 H	50	20.1	8.9

ANTENNA POLARITY & TEST DISTANCE: VERTICAL AT 3 M

NO.	FREQ. (MHz)	EMISSION LEVEL (dBuV/m)	LIMIT (dBuV/m)	MARGIN (dB)	ANTENNA HEIGHT (m)	TABLE ANGLE (Degree)	RAW VALUE (dBuV)	CORRECTION FACTOR (dB/m)
1	2388.00	67.9 PK	74.0	-6.1	3.90 V	353	69.5	-1.6
2	2388.00	52.9 AV	54.0	-1.1	3.90 V	353	54.5	-1.6
3	*2437.00	116.2 PK			3.90 V	353	117.7	-1.5
4	*2437.00	108.3 AV			3.90 V	353	109.8	-1.5
5	2485.00	63.8 PK	74.0	-10.2	3.90 V	353	65.2	-1.4
6	2485.00	46.9 AV	54.0	-7.1	3.90 V	353	48.3	-1.4
7	4874.00	46.2 PK	74.0	-27.8	3.92 V	360	43.0	3.2
8	4874.00	43.3 AV	54.0	-10.7	3.92 V	360	40.1	3.2
9	7311.00	40.9 PK	74.0	-33.1	1.77 V	238	32.0	8.9
10	7311.00	28.3 AV	54.0	-25.7	1.77 V	238	19.4	8.9

REMARKS:

1. Emission Level(dBuV/m) = Raw Value(dBuV) + Correction Factor(dB/m)
2. Correction Factor(dB/m) = Antenna Factor(dB/m) + Cable Factor(dB) – Pre-Amplifier Factor(dB)
3. The other emission levels were very low against the limit.
4. Margin value = Emission Level – Limit value
5. " * ": Fundamental frequency.

CHANNEL	TX Channel 11	DETECTOR FUNCTION	Peak (PK)
FREQUENCY RANGE	1GHz ~ 25GHz		Average (AV)

ANTENNA POLARITY & TEST DISTANCE: HORIZONTAL AT 3 M

NO.	FREQ. (MHz)	EMISSION LEVEL (dBuV/m)	LIMIT (dBuV/m)	MARGIN (dB)	ANTENNA HEIGHT (m)	TABLE ANGLE (Degree)	RAW VALUE (dBuV)	CORRECTION FACTOR (dB/m)
1	*2462.00	115.7 PK			1.62 H	57	117.1	-1.4
2	*2462.00	105.7 AV			1.62 H	57	107.1	-1.4
3	2483.50	73.1 PK	74.0	-0.9	1.62 H	57	74.5	-1.4
4	2483.50	53.9 AV	54.0	-0.1	1.62 H	57	55.3	-1.4
5	4924.00	47.7 PK	74.0	-26.3	1.93 H	19	44.4	3.3
6	4924.00	45.2 AV	54.0	-8.8	1.93 H	19	41.9	3.3
7	7386.00	40.5 PK	74.0	-33.5	1.13 H	45	31.4	9.1
8	7386.00	27.5 AV	54.0	-26.5	1.13 H	45	18.4	9.1

ANTENNA POLARITY & TEST DISTANCE: VERTICAL AT 3 M

NO.	FREQ. (MHz)	EMISSION LEVEL (dBuV/m)	LIMIT (dBuV/m)	MARGIN (dB)	ANTENNA HEIGHT (m)	TABLE ANGLE (Degree)	RAW VALUE (dBuV)	CORRECTION FACTOR (dB/m)
1	*2462.00	111.6 PK			3.93 V	354	113.0	-1.4
2	*2462.00	101.7 AV			3.93 V	354	103.1	-1.4
3	2483.50	72.6 PK	74.0	-1.4	3.93 V	354	74.0	-1.4
4	2483.50	53.1 AV	54.0	-0.9	3.93 V	354	54.5	-1.4
5	4924.00	46.9 PK	74.0	-27.1	3.83 V	348	43.6	3.3
6	4924.00	43.1 AV	54.0	-10.9	3.83 V	348	39.8	3.3
7	7386.00	41.0 PK	74.0	-33.0	1.78 V	265	31.9	9.1
8	7386.00	27.8 AV	54.0	-26.2	1.78 V	265	18.7	9.1

REMARKS:

1. Emission Level(dBuV/m) = Raw Value(dBuV) + Correction Factor(dB/m)
2. Correction Factor(dB/m) = Antenna Factor(dB/m) + Cable Factor(dB) – Pre-Amplifier Factor(dB)
3. The other emission levels were very low against the limit.
4. Margin value = Emission Level – Limit value
5. " * ": Fundamental frequency.

802.11n (HT20)

CHANNEL	TX Channel 1	DETECTOR FUNCTION	Peak (PK)
FREQUENCY RANGE	1GHz ~ 25GHz		Average (AV)

ANTENNA POLARITY & TEST DISTANCE: HORIZONTAL AT 3 M

NO.	FREQ. (MHz)	EMISSION LEVEL (dBuV/m)	LIMIT (dBuV/m)	MARGIN (dB)	ANTENNA HEIGHT (m)	TABLE ANGLE (Degree)	RAW VALUE (dBuV)	CORRECTION FACTOR (dB/m)
1	2388.00	71.5 PK	74.0	-2.5	2.13 H	309	73.1	-1.6
2	2388.00	53.8 AV	54.0	-0.2	2.13 H	309	55.4	-1.6
3	*2412.00	112.8 PK			2.13 H	309	114.3	-1.5
4	*2412.00	102.1 AV			2.13 H	309	103.6	-1.5
5	4824.00	47.9 PK	74.0	-26.1	1.89 H	18	44.9	3.0
6	4824.00	45.6 AV	54.0	-8.4	1.89 H	18	42.6	3.0

ANTENNA POLARITY & TEST DISTANCE: VERTICAL AT 3 M

NO.	FREQ. (MHz)	EMISSION LEVEL (dBuV/m)	LIMIT (dBuV/m)	MARGIN (dB)	ANTENNA HEIGHT (m)	TABLE ANGLE (Degree)	RAW VALUE (dBuV)	CORRECTION FACTOR (dB/m)
1	2390.00	70.7 PK	74.0	-3.3	3.91 V	328	72.3	-1.6
2	2390.00	52.9 AV	54.0	-1.1	3.91 V	328	54.5	-1.6
3	*2412.00	108.7 PK			3.91 V	328	110.2	-1.5
4	*2412.00	98.2 AV			3.91 V	328	99.7	-1.5
5	4824.00	46.9 PK	74.0	-27.1	3.96 V	359	43.9	3.0
6	4824.00	43.5 AV	54.0	-10.5	3.96 V	359	40.5	3.0

REMARKS:

1. Emission Level(dBuV/m) = Raw Value(dBuV) + Correction Factor(dB/m)
2. Correction Factor(dB/m) = Antenna Factor(dB/m) + Cable Factor(dB) – Pre-Amplifier Factor(dB)
3. The other emission levels were very low against the limit.
4. Margin value = Emission Level – Limit value
5. " * ": Fundamental frequency.

CHANNEL	TX Channel 6	DETECTOR FUNCTION	Peak (PK)
FREQUENCY RANGE	1GHz ~ 25GHz		Average (AV)

ANTENNA POLARITY & TEST DISTANCE: HORIZONTAL AT 3 M

NO.	FREQ. (MHz)	EMISSION LEVEL (dBuV/m)	LIMIT (dBuV/m)	MARGIN (dB)	ANTENNA HEIGHT (m)	TABLE ANGLE (Degree)	RAW VALUE (dBuV)	CORRECTION FACTOR (dB/m)
1	2389.00	69.5 PK	74.0	-4.5	2.02 H	311	71.1	-1.6
2	2389.00	53.6 AV	54.0	-0.4	2.02 H	311	55.2	-1.6
3	*2437.00	120.2 PK			2.02 H	311	121.7	-1.5
4	*2437.00	109.5 AV			2.02 H	311	111.0	-1.5
5	2483.50	67.9 PK	74.0	-6.1	2.02 H	311	69.3	-1.4
6	2483.50	51.1 AV	54.0	-2.9	2.02 H	311	52.5	-1.4
7	4874.00	47.9 PK	74.0	-26.1	1.93 H	31	44.7	3.2
8	4874.00	45.9 AV	54.0	-8.1	1.93 H	31	42.7	3.2
9	7311.00	42.9 PK	74.0	-31.1	1.22 H	63	34.0	8.9
10	7311.00	29.4 AV	54.0	-24.6	1.22 H	63	20.5	8.9

ANTENNA POLARITY & TEST DISTANCE: VERTICAL AT 3 M

NO.	FREQ. (MHz)	EMISSION LEVEL (dBuV/m)	LIMIT (dBuV/m)	MARGIN (dB)	ANTENNA HEIGHT (m)	TABLE ANGLE (Degree)	RAW VALUE (dBuV)	CORRECTION FACTOR (dB/m)
1	2389.00	68.7 PK	74.0	-5.3	3.93 V	327	70.3	-1.6
2	2389.00	52.7 AV	54.0	-1.3	3.93 V	327	54.3	-1.6
3	*2437.00	116.3 PK			3.93 V	327	117.8	-1.5
4	*2437.00	105.5 AV			3.93 V	327	107.0	-1.5
5	2483.50	67.4 PK	74.0	-6.6	3.93 V	327	68.8	-1.4
6	2483.50	50.3 AV	54.0	-3.7	3.93 V	327	51.7	-1.4
7	4874.00	46.1 PK	74.0	-27.9	3.87 V	360	42.9	3.2
8	4874.00	42.9 AV	54.0	-11.1	3.87 V	360	39.7	3.2
9	7311.00	41.9 PK	74.0	-32.1	1.85 V	268	33.0	8.9
10	7311.00	29.0 AV	54.0	-25.0	1.85 V	268	20.1	8.9

REMARKS:

1. Emission Level(dBuV/m) = Raw Value(dBuV) + Correction Factor(dB/m)
2. Correction Factor(dB/m) = Antenna Factor(dB/m) + Cable Factor(dB) – Pre-Amplifier Factor(dB)
3. The other emission levels were very low against the limit.
4. Margin value = Emission Level – Limit value
5. " * ": Fundamental frequency.

CHANNEL	TX Channel 11	DETECTOR FUNCTION	Peak (PK)
FREQUENCY RANGE	1GHz ~ 25GHz		Average (AV)

ANTENNA POLARITY & TEST DISTANCE: HORIZONTAL AT 3 M

NO.	FREQ. (MHz)	EMISSION LEVEL (dBuV/m)	LIMIT (dBuV/m)	MARGIN (dB)	ANTENNA HEIGHT (m)	TABLE ANGLE (Degree)	RAW VALUE (dBuV)	CORRECTION FACTOR (dB/m)
1	*2462.00	115.2 PK			2.02 H	308	116.6	-1.4
2	*2462.00	104.6 AV			2.02 H	308	106.0	-1.4
3	2483.50	72.5 PK	74.0	-1.5	2.02 H	308	73.9	-1.4
4	2483.50	53.7 AV	54.0	-0.3	2.02 H	308	55.1	-1.4
5	4924.00	47.6 PK	74.0	-26.4	1.93 H	24	44.3	3.3
6	4924.00	45.2 AV	54.0	-8.8	1.93 H	24	41.9	3.3
7	7386.00	40.4 PK	74.0	-33.6	1.20 H	45	31.3	9.1
8	7386.00	27.5 AV	54.0	-26.5	1.20 H	45	18.4	9.1

ANTENNA POLARITY & TEST DISTANCE: VERTICAL AT 3 M

NO.	FREQ. (MHz)	EMISSION LEVEL (dBuV/m)	LIMIT (dBuV/m)	MARGIN (dB)	ANTENNA HEIGHT (m)	TABLE ANGLE (Degree)	RAW VALUE (dBuV)	CORRECTION FACTOR (dB/m)
1	*2462.00	111.1 PK			3.87 V	354	112.5	-1.4
2	*2462.00	100.7 AV			3.87 V	354	102.1	-1.4
3	2483.50	71.9 PK	74.0	-2.1	3.87 V	354	73.3	-1.4
4	2483.50	52.9 AV	54.0	-1.1	3.87 V	354	54.3	-1.4
5	4924.00	46.4 PK	74.0	-27.6	3.90 V	360	43.1	3.3
6	4924.00	43.0 AV	54.0	-11.0	3.90 V	360	39.7	3.3
7	7386.00	41.0 PK	74.0	-33.0	1.76 V	264	31.9	9.1
8	7386.00	27.8 AV	54.0	-26.2	1.76 V	264	18.7	9.1

REMARKS:

1. Emission Level(dBuV/m) = Raw Value(dBuV) + Correction Factor(dB/m)
2. Correction Factor(dB/m) = Antenna Factor(dB/m) + Cable Factor(dB) – Pre-Amplifier Factor(dB)
3. The other emission levels were very low against the limit.
4. Margin value = Emission Level – Limit value
5. " * ": Fundamental frequency.

802.11n (HT40)

CHANNEL	TX Channel 3	DETECTOR FUNCTION	Peak (PK)
FREQUENCY RANGE	1GHz ~ 25GHz		Average (AV)

ANTENNA POLARITY & TEST DISTANCE: HORIZONTAL AT 3 M								
NO.	FREQ. (MHz)	EMISSION LEVEL (dBuV/m)	LIMIT (dBuV/m)	MARGIN (dB)	ANTENNA HEIGHT (m)	TABLE ANGLE (Degree)	RAW VALUE (dBuV)	CORRECTION FACTOR (dB/m)
1	2390.00	65.2 PK	74.0	-8.8	1.44 H	55	66.8	-1.6
2	2390.00	53.9 AV	54.0	-0.1	1.44 H	55	55.5	-1.6
3	*2422.00	107.2 PK			1.44 H	55	108.8	-1.6
4	*2422.00	97.5 AV			1.44 H	55	99.1	-1.6
5	4844.00	36.7 PK	74.0	-37.3	2.17 H	154	33.6	3.1
6	4844.00	26.8 AV	54.0	-27.2	2.17 H	154	23.7	3.1
7	7266.00	42.3 PK	74.0	-31.7	1.45 H	223	33.4	8.9
8	7266.00	30.9 AV	54.0	-23.1	1.45 H	223	22.0	8.9

ANTENNA POLARITY & TEST DISTANCE: VERTICAL AT 3 M								
NO.	FREQ. (MHz)	EMISSION LEVEL (dBuV/m)	LIMIT (dBuV/m)	MARGIN (dB)	ANTENNA HEIGHT (m)	TABLE ANGLE (Degree)	RAW VALUE (dBuV)	CORRECTION FACTOR (dB/m)
1	2390.00	56.6 PK	74.0	-17.4	1.52 V	38	58.2	-1.6
2	2390.00	48.2 AV	54.0	-5.8	1.52 V	38	49.8	-1.6
3	*2422.00	102.2 PK			1.52 V	38	103.8	-1.6
4	*2422.00	92.8 AV			1.52 V	38	94.4	-1.6
5	4844.00	36.0 PK	74.0	-38.0	1.45 V	310	32.9	3.1
6	4844.00	25.8 AV	54.0	-28.2	1.45 V	310	22.7	3.1
7	7266.00	42.5 PK	74.0	-31.5	2.15 V	185	33.6	8.9
8	7266.00	31.8 AV	54.0	-22.2	2.15 V	185	22.9	8.9

REMARKS:

1. Emission Level(dBuV/m) = Raw Value(dBuV) + Correction Factor(dB/m)
2. Correction Factor(dB/m) = Antenna Factor(dB/m) + Cable Factor(dB) – Pre-Amplifier Factor(dB)
3. The other emission levels were very low against the limit.
4. Margin value = Emission Level – Limit value
5. " * ": Fundamental frequency.

CHANNEL	TX Channel 6	DETECTOR FUNCTION	Peak (PK)
FREQUENCY RANGE	1GHz ~ 25GHz		Average (AV)

ANTENNA POLARITY & TEST DISTANCE: HORIZONTAL AT 3 M

NO.	FREQ. (MHz)	EMISSION LEVEL (dBuV/m)	LIMIT (dBuV/m)	MARGIN (dB)	ANTENNA HEIGHT (m)	TABLE ANGLE (Degree)	RAW VALUE (dBuV)	CORRECTION FACTOR (dB/m)
1	2389.00	70.9 PK	74.0	-3.1	1.42 H	46	72.5	-1.6
2	2389.00	53.9 AV	54.0	-0.1	1.42 H	46	55.5	-1.6
3	*2437.00	106.7 PK			1.42 H	46	108.2	-1.5
4	*2437.00	97.6 AV			1.42 H	46	99.1	-1.5
5	2485.00	70.2 PK	74.0	-3.8	1.42 H	46	71.6	-1.4
6	2485.00	50.6 AV	54.0	-3.4	1.42 H	46	52.0	-1.4
7	4874.00	36.7 PK	74.0	-37.3	2.20 H	144	33.5	3.2
8	4874.00	26.8 AV	54.0	-27.2	2.20 H	144	23.6	3.2
9	7311.00	42.0 PK	74.0	-32.0	1.44 H	218	33.1	8.9
10	7311.00	30.9 AV	54.0	-23.1	1.44 H	218	22.0	8.9

ANTENNA POLARITY & TEST DISTANCE: VERTICAL AT 3 M

NO.	FREQ. (MHz)	EMISSION LEVEL (dBuV/m)	LIMIT (dBuV/m)	MARGIN (dB)	ANTENNA HEIGHT (m)	TABLE ANGLE (Degree)	RAW VALUE (dBuV)	CORRECTION FACTOR (dB/m)
1	2390.00	62.3 PK	74.0	-11.7	1.46 V	30	63.9	-1.6
2	2390.00	48.2 AV	54.0	-5.8	1.46 V	30	49.8	-1.6
3	*2437.00	101.7 PK			1.46 V	30	103.2	-1.5
4	*2437.00	92.9 AV			1.46 V	30	94.4	-1.5
5	2483.50	60.1 PK	74.0	-13.9	1.46 V	30	61.5	-1.4
6	2483.50	44.1 AV	54.0	-9.9	1.46 V	30	45.5	-1.4
7	4874.00	36.1 PK	74.0	-37.9	1.46 V	309	32.9	3.2
8	4874.00	26.1 AV	54.0	-27.9	1.46 V	309	22.9	3.2
9	7311.00	42.4 PK	74.0	-31.6	2.12 V	198	33.5	8.9
10	7311.00	31.9 AV	54.0	-22.1	2.12 V	198	23.0	8.9

REMARKS:

1. Emission Level(dBuV/m) = Raw Value(dBuV) + Correction Factor(dB/m)
2. Correction Factor(dB/m) = Antenna Factor(dB/m) + Cable Factor(dB) – Pre-Amplifier Factor(dB)
3. The other emission levels were very low against the limit.
4. Margin value = Emission Level – Limit value
5. " * ": Fundamental frequency.

CHANNEL	TX Channel 9	DETECTOR FUNCTION	Peak (PK)
FREQUENCY RANGE	1GHz ~ 25GHz		Average (AV)

ANTENNA POLARITY & TEST DISTANCE: HORIZONTAL AT 3 M

NO.	FREQ. (MHz)	EMISSION LEVEL (dBuV/m)	LIMIT (dBuV/m)	MARGIN (dB)	ANTENNA HEIGHT (m)	TABLE ANGLE (Degree)	RAW VALUE (dBuV)	CORRECTION FACTOR (dB/m)
1	*2452.00	107.1 PK			1.34 H	48	108.6	-1.5
2	*2452.00	97.5 AV			1.34 H	48	99.0	-1.5
3	2484.00	72.5 PK	74.0	-1.5	1.34 H	48	73.9	-1.4
4	2484.00	53.8 AV	54.0	-0.2	1.34 H	48	55.2	-1.4
5	4904.00	36.6 PK	74.0	-37.4	2.21 H	137	33.4	3.2
6	4904.00	26.7 AV	54.0	-27.3	2.21 H	137	23.5	3.2
7	7356.00	41.7 PK	74.0	-32.3	1.41 H	209	32.6	9.1
8	7356.00	30.9 AV	54.0	-23.1	1.41 H	209	21.8	9.1

ANTENNA POLARITY & TEST DISTANCE: VERTICAL AT 3 M

NO.	FREQ. (MHz)	EMISSION LEVEL (dBuV/m)	LIMIT (dBuV/m)	MARGIN (dB)	ANTENNA HEIGHT (m)	TABLE ANGLE (Degree)	RAW VALUE (dBuV)	CORRECTION FACTOR (dB/m)
1	*2452.00	102.1 PK			1.42 V	34	103.6	-1.5
2	*2452.00	92.8 AV			1.42 V	34	94.3	-1.5
3	2483.50	62.4 PK	74.0	-11.6	1.42 V	34	63.8	-1.4
4	2483.50	47.2 AV	54.0	-6.8	1.42 V	34	48.6	-1.4
5	4904.00	35.7 PK	74.0	-38.3	1.41 V	301	32.5	3.2
6	4904.00	25.6 AV	54.0	-28.4	1.41 V	301	22.4	3.2
7	7356.00	43.1 PK	74.0	-30.9	2.17 V	182	34.0	9.1
8	7356.00	32.4 AV	54.0	-21.6	2.17 V	182	23.3	9.1

REMARKS:

1. Emission Level(dBuV/m) = Raw Value(dBuV) + Correction Factor(dB/m)
2. Correction Factor(dB/m) = Antenna Factor(dB/m) + Cable Factor(dB) – Pre-Amplifier Factor(dB)
3. The other emission levels were very low against the limit.
4. Margin value = Emission Level – Limit value
5. " * ": Fundamental frequency.

Below 1GHz Data:

802.11b

CHANNEL	TX Channel 6	DETECTOR FUNCTION	Quasi-Peak (QP)
FREQUENCY RANGE	9kHz ~ 1GHz		

ANTENNA POLARITY & TEST DISTANCE: HORIZONTAL AT 3 M

NO.	FREQ. (MHz)	EMISSION LEVEL (dBuV/m)	LIMIT (dBuV/m)	MARGIN (dB)	ANTENNA HEIGHT (m)	TABLE ANGLE (Degree)	RAW VALUE (dBuV)	CORRECTION FACTOR (dB/m)
1	50.49	29.1 QP	40.0	-10.9	1.00 H	123	37.4	-8.3
2	108.42	32.2 QP	43.5	-11.3	1.50 H	351	43.4	-11.2
3	221.42	35.9 QP	46.0	-10.1	4.00 H	124	47.0	-11.1
4	252.88	31.2 QP	46.0	-14.8	1.00 H	1	40.6	-9.4
5	341.15	34.5 QP	46.0	-11.5	1.50 H	135	41.0	-6.5
6	461.12	42.4 QP	46.0	-3.6	1.50 H	97	46.1	-3.7

ANTENNA POLARITY & TEST DISTANCE: VERTICAL AT 3 M

NO.	FREQ. (MHz)	EMISSION LEVEL (dBuV/m)	LIMIT (dBuV/m)	MARGIN (dB)	ANTENNA HEIGHT (m)	TABLE ANGLE (Degree)	RAW VALUE (dBuV)	CORRECTION FACTOR (dB/m)
1	62.52	36.0 QP	40.0	-4.0	1.00 V	151	45.3	-9.3
2	91.23	35.2 QP	43.5	-8.3	1.50 V	200	49.0	-13.8
3	179.62	31.9 QP	43.5	-11.6	2.50 V	173	41.6	-9.7
4	384.66	42.2 QP	46.0	-3.8	1.50 V	249	47.9	-5.7
5	438.64	42.0 QP	46.0	-4.0	1.50 V	137	45.9	-3.9
6	550.87	34.4 QP	46.0	-11.6	1.50 V	239	36.6	-2.2

REMARKS:

1. Emission Level(dBuV/m) = Raw Value(dBuV) + Correction Factor(dB/m)
2. Correction Factor(dB/m) = Antenna Factor(dB/m) + Cable Factor(dB) – Pre-Amplifier Factor(dB)
3. The other emission levels were very low against the limit.
4. Margin value = Emission Level – Limit value

4.1.9 Test Results (Mode 3)

Above 1GHz Data:

802.11b

CHANNEL	TX Channel 1	DETECTOR FUNCTION	Peak (PK)
FREQUENCY RANGE	1GHz ~ 25GHz		Average (AV)

ANTENNA POLARITY & TEST DISTANCE: HORIZONTAL AT 3 M

NO.	FREQ. (MHz)	EMISSION LEVEL (dBuV/m)	LIMIT (dBuV/m)	MARGIN (dB)	ANTENNA HEIGHT (m)	TABLE ANGLE (Degree)	RAW VALUE (dBuV)	CORRECTION FACTOR (dB/m)
1	2390.00	60.6 PK	74.0	-13.4	1.37 H	57	62.2	-1.6
2	2390.00	53.8 AV	54.0	-0.2	1.37 H	57	55.4	-1.6
3	*2412.00	113.1 PK			1.37 H	57	114.6	-1.5
4	*2412.00	111.1 AV			1.37 H	57	112.6	-1.5
5	4824.00	47.3 PK	74.0	-26.7	1.85 H	57	44.3	3.0
6	4824.00	45.3 AV	54.0	-8.7	1.85 H	57	42.3	3.0

ANTENNA POLARITY & TEST DISTANCE: VERTICAL AT 3 M

NO.	FREQ. (MHz)	EMISSION LEVEL (dBuV/m)	LIMIT (dBuV/m)	MARGIN (dB)	ANTENNA HEIGHT (m)	TABLE ANGLE (Degree)	RAW VALUE (dBuV)	CORRECTION FACTOR (dB/m)
1	2390.00	59.9 PK	74.0	-14.1	3.96 V	349	61.5	-1.6
2	2390.00	50.7 AV	54.0	-3.3	3.96 V	349	52.3	-1.6
3	*2412.00	109.2 PK			3.96 V	349	110.7	-1.5
4	*2412.00	107.0 AV			3.96 V	349	108.5	-1.5
5	4824.00	46.0 PK	74.0	-28.0	3.86 V	360	43.0	3.0
6	4824.00	43.0 AV	54.0	-11.0	3.86 V	360	40.0	3.0

REMARKS:

1. Emission Level(dBuV/m) = Raw Value(dBuV) + Correction Factor(dB/m)
2. Correction Factor(dB/m) = Antenna Factor(dB/m) + Cable Factor(dB) – Pre-Amplifier Factor(dB)
3. The other emission levels were very low against the limit.
4. Margin value = Emission Level – Limit value
5. " * ": Fundamental frequency.

CHANNEL	TX Channel 6	DETECTOR FUNCTION	Peak (PK)
FREQUENCY RANGE	1GHz ~ 25GHz		Average (AV)

ANTENNA POLARITY & TEST DISTANCE: HORIZONTAL AT 3 M

NO.	FREQ. (MHz)	EMISSION LEVEL (dBuV/m)	LIMIT (dBuV/m)	MARGIN (dB)	ANTENNA HEIGHT (m)	TABLE ANGLE (Degree)	RAW VALUE (dBuV)	CORRECTION FACTOR (dB/m)
1	2390.00	55.1 PK	74.0	-18.9	1.48 H	51	56.7	-1.6
2	2390.00	44.9 AV	54.0	-9.1	1.48 H	51	46.5	-1.6
3	*2437.00	116.3 PK			1.48 H	51	117.8	-1.5
4	*2437.00	114.3 AV			1.48 H	51	115.8	-1.5
5	2483.50	56.7 PK	74.0	-17.3	1.48 H	51	58.1	-1.4
6	2483.50	44.6 AV	54.0	-9.4	1.48 H	51	46.0	-1.4
7	4874.00	48.1 PK	74.0	-25.9	1.92 H	41	44.9	3.2
8	4874.00	45.9 AV	54.0	-8.1	1.92 H	41	42.7	3.2
9	7311.00	42.2 PK	74.0	-31.8	1.24 H	58	33.3	8.9
10	7311.00	28.9 AV	54.0	-25.1	1.24 H	58	20.0	8.9

ANTENNA POLARITY & TEST DISTANCE: VERTICAL AT 3 M

NO.	FREQ. (MHz)	EMISSION LEVEL (dBuV/m)	LIMIT (dBuV/m)	MARGIN (dB)	ANTENNA HEIGHT (m)	TABLE ANGLE (Degree)	RAW VALUE (dBuV)	CORRECTION FACTOR (dB/m)
1	2390.00	54.5 PK	74.0	-19.5	3.98 V	342	56.1	-1.6
2	2390.00	41.8 AV	54.0	-12.2	3.98 V	342	43.4	-1.6
3	*2437.00	112.5 PK			3.98 V	342	114.0	-1.5
4	*2437.00	110.2 AV			3.98 V	342	111.7	-1.5
5	2483.50	54.7 PK	74.0	-19.3	3.98 V	342	56.1	-1.4
6	2483.50	41.4 AV	54.0	-12.6	3.98 V	342	42.8	-1.4
7	4874.00	46.3 PK	74.0	-27.7	3.87 V	360	43.1	3.2
8	4874.00	43.1 AV	54.0	-10.9	3.87 V	360	39.9	3.2
9	7311.00	41.4 PK	74.0	-32.6	1.81 V	254	32.5	8.9
10	7311.00	28.6 AV	54.0	-25.4	1.81 V	254	19.7	8.9

REMARKS:

1. Emission Level(dBuV/m) = Raw Value(dBuV) + Correction Factor(dB/m)
2. Correction Factor(dB/m) = Antenna Factor(dB/m) + Cable Factor(dB) – Pre-Amplifier Factor(dB)
3. The other emission levels were very low against the limit.
4. Margin value = Emission Level – Limit value
5. " * ": Fundamental frequency.

CHANNEL	TX Channel 11	DETECTOR FUNCTION	Peak (PK)
FREQUENCY RANGE	1GHz ~ 25GHz		Average (AV)

ANTENNA POLARITY & TEST DISTANCE: HORIZONTAL AT 3 M

NO.	FREQ. (MHz)	EMISSION LEVEL (dBuV/m)	LIMIT (dBuV/m)	MARGIN (dB)	ANTENNA HEIGHT (m)	TABLE ANGLE (Degree)	RAW VALUE (dBuV)	CORRECTION FACTOR (dB/m)
1	*2462.00	113.1 PK			1.50 H	48	114.5	-1.4
2	*2462.00	111.2 AV			1.50 H	48	112.6	-1.4
3	2483.50	60.2 PK	74.0	-13.8	1.50 H	48	61.6	-1.4
4	2483.50	53.9 AV	54.0	-0.1	1.50 H	48	55.3	-1.4
5	4924.00	47.6 PK	74.0	-26.4	1.88 H	44	44.3	3.3
6	4924.00	45.4 AV	54.0	-8.6	1.88 H	44	42.1	3.3
7	7386.00	41.8 PK	74.0	-32.2	1.24 H	63	32.7	9.1
8	7386.00	28.5 AV	54.0	-25.5	1.24 H	63	19.4	9.1

ANTENNA POLARITY & TEST DISTANCE: VERTICAL AT 3 M

NO.	FREQ. (MHz)	EMISSION LEVEL (dBuV/m)	LIMIT (dBuV/m)	MARGIN (dB)	ANTENNA HEIGHT (m)	TABLE ANGLE (Degree)	RAW VALUE (dBuV)	CORRECTION FACTOR (dB/m)
1	*2462.00	109.3 PK			3.85 V	346	110.7	-1.4
2	*2462.00	107.1 AV			3.85 V	346	108.5	-1.4
3	2483.50	58.1 PK	74.0	-15.9	3.85 V	346	59.5	-1.4
4	2483.50	50.6 AV	54.0	-3.4	3.85 V	346	52.0	-1.4
5	4924.00	45.8 PK	74.0	-28.2	3.83 V	360	42.5	3.3
6	4924.00	42.6 AV	54.0	-11.4	3.83 V	360	39.3	3.3
7	7386.00	41.1 PK	74.0	-32.9	1.81 V	242	32.0	9.1
8	7386.00	28.2 AV	54.0	-25.8	1.81 V	242	19.1	9.1

REMARKS:

1. Emission Level(dBuV/m) = Raw Value(dBuV) + Correction Factor(dB/m)
2. Correction Factor(dB/m) = Antenna Factor(dB/m) + Cable Factor(dB) – Pre-Amplifier Factor(dB)
3. The other emission levels were very low against the limit.
4. Margin value = Emission Level – Limit value
5. " * ": Fundamental frequency.

802.11g

CHANNEL	TX Channel 1	DETECTOR FUNCTION	Peak (PK)
FREQUENCY RANGE	1GHz ~ 25GHz		Average (AV)

ANTENNA POLARITY & TEST DISTANCE: HORIZONTAL AT 3 M

NO.	FREQ. (MHz)	EMISSION LEVEL (dBuV/m)	LIMIT (dBuV/m)	MARGIN (dB)	ANTENNA HEIGHT (m)	TABLE ANGLE (Degree)	RAW VALUE (dBuV)	CORRECTION FACTOR (dB/m)
1	2390.00	70.3 PK	74.0	-3.7	2.48 H	319	71.9	-1.6
2	2390.00	53.7 AV	54.0	-0.3	2.48 H	319	55.3	-1.6
3	*2412.00	111.7 PK			2.48 H	319	113.2	-1.5
4	*2412.00	104.0 AV			2.48 H	319	105.5	-1.5
5	4824.00	47.1 PK	74.0	-26.9	1.89 H	58	44.1	3.0
6	4824.00	45.4 AV	54.0	-8.6	1.89 H	58	42.4	3.0

ANTENNA POLARITY & TEST DISTANCE: VERTICAL AT 3 M

NO.	FREQ. (MHz)	EMISSION LEVEL (dBuV/m)	LIMIT (dBuV/m)	MARGIN (dB)	ANTENNA HEIGHT (m)	TABLE ANGLE (Degree)	RAW VALUE (dBuV)	CORRECTION FACTOR (dB/m)
1	2390.00	69.4 PK	74.0	-4.6	3.87 V	336	71.0	-1.6
2	2390.00	50.6 AV	54.0	-3.4	3.87 V	336	52.2	-1.6
3	*2412.00	107.8 PK			3.87 V	336	109.3	-1.5
4	*2412.00	99.9 AV			3.87 V	336	101.4	-1.5
5	4824.00	46.2 PK	74.0	-27.8	3.84 V	360	43.2	3.0
6	4824.00	43.0 AV	54.0	-11.0	3.84 V	360	40.0	3.0

REMARKS:

1. Emission Level(dBuV/m) = Raw Value(dBuV) + Correction Factor(dB/m)
2. Correction Factor(dB/m) = Antenna Factor(dB/m) + Cable Factor(dB) – Pre-Amplifier Factor(dB)
3. The other emission levels were very low against the limit.
4. Margin value = Emission Level – Limit value
5. " * ": Fundamental frequency.

CHANNEL	TX Channel 6	DETECTOR FUNCTION	Peak (PK)
FREQUENCY RANGE	1GHz ~ 25GHz		Average (AV)

ANTENNA POLARITY & TEST DISTANCE: HORIZONTAL AT 3 M

NO.	FREQ. (MHz)	EMISSION LEVEL (dBuV/m)	LIMIT (dBuV/m)	MARGIN (dB)	ANTENNA HEIGHT (m)	TABLE ANGLE (Degree)	RAW VALUE (dBuV)	CORRECTION FACTOR (dB/m)
1	2390.00	66.9 PK	74.0	-7.1	2.50 H	310	68.5	-1.6
2	2390.00	53.9 AV	54.0	-0.1	2.50 H	310	55.5	-1.6
3	*2437.00	118.9 PK			2.50 H	310	120.4	-1.5
4	*2437.00	111.1 AV			2.50 H	310	112.6	-1.5
5	2487.00	65.4 PK	74.0	-8.6	2.50 H	310	66.8	-1.4
6	2487.00	50.2 AV	54.0	-3.8	2.50 H	310	51.6	-1.4
7	4874.00	47.7 PK	74.0	-26.3	1.92 H	41	44.5	3.2
8	4874.00	45.4 AV	54.0	-8.6	1.92 H	41	42.2	3.2
9	7311.00	42.7 PK	74.0	-31.3	1.26 H	55	33.8	8.9
10	7311.00	29.3 AV	54.0	-24.7	1.26 H	55	20.4	8.9

ANTENNA POLARITY & TEST DISTANCE: VERTICAL AT 3 M

NO.	FREQ. (MHz)	EMISSION LEVEL (dBuV/m)	LIMIT (dBuV/m)	MARGIN (dB)	ANTENNA HEIGHT (m)	TABLE ANGLE (Degree)	RAW VALUE (dBuV)	CORRECTION FACTOR (dB/m)
1	2390.00	66.2 PK	74.0	-7.8	3.91 V	353	67.8	-1.6
2	2390.00	50.7 AV	54.0	-3.3	3.91 V	353	52.3	-1.6
3	*2437.00	115.1 PK			3.91 V	353	116.6	-1.5
4	*2437.00	107.0 AV			3.91 V	353	108.5	-1.5
5	2483.50	63.4 PK	74.0	-10.6	3.91 V	353	64.8	-1.4
6	2483.50	47.0 AV	54.0	-7.0	3.91 V	353	48.4	-1.4
7	4874.00	46.5 PK	74.0	-27.5	3.85 V	360	43.3	3.2
8	4874.00	43.4 AV	54.0	-10.6	3.85 V	360	40.2	3.2
9	7311.00	41.9 PK	74.0	-32.1	1.84 V	258	33.0	8.9
10	7311.00	29.1 AV	54.0	-24.9	1.84 V	258	20.2	8.9

REMARKS:

1. Emission Level(dBuV/m) = Raw Value(dBuV) + Correction Factor(dB/m)
2. Correction Factor(dB/m) = Antenna Factor(dB/m) + Cable Factor(dB) – Pre-Amplifier Factor(dB)
3. The other emission levels were very low against the limit.
4. Margin value = Emission Level – Limit value
5. " * ": Fundamental frequency.

CHANNEL	TX Channel 11	DETECTOR FUNCTION	Peak (PK)
FREQUENCY RANGE	1GHz ~ 25GHz		Average (AV)

ANTENNA POLARITY & TEST DISTANCE: HORIZONTAL AT 3 M

NO.	FREQ. (MHz)	EMISSION LEVEL (dBuV/m)	LIMIT (dBuV/m)	MARGIN (dB)	ANTENNA HEIGHT (m)	TABLE ANGLE (Degree)	RAW VALUE (dBuV)	CORRECTION FACTOR (dB/m)
1	*2462.00	114.3 PK			2.46 H	312	115.7	-1.4
2	*2462.00	106.3 AV			2.46 H	312	107.7	-1.4
3	2486.00	68.9 PK	74.0	-5.1	2.46 H	312	70.3	-1.4
4	2486.00	53.8 AV	54.0	-0.2	2.46 H	312	55.2	-1.4
5	4924.00	47.6 PK	74.0	-26.4	1.82 H	52	44.3	3.3
6	4924.00	45.7 AV	54.0	-8.3	1.82 H	52	42.4	3.3
7	7386.00	41.7 PK	74.0	-32.3	1.21 H	71	32.6	9.1
8	7386.00	28.2 AV	54.0	-25.8	1.21 H	71	19.1	9.1

ANTENNA POLARITY & TEST DISTANCE: VERTICAL AT 3 M

NO.	FREQ. (MHz)	EMISSION LEVEL (dBuV/m)	LIMIT (dBuV/m)	MARGIN (dB)	ANTENNA HEIGHT (m)	TABLE ANGLE (Degree)	RAW VALUE (dBuV)	CORRECTION FACTOR (dB/m)
1	*2462.00	110.5 PK			3.82 V	351	111.9	-1.4
2	*2462.00	102.1 AV			3.82 V	351	103.5	-1.4
3	2483.50	66.7 PK	74.0	-7.3	3.82 V	351	68.1	-1.4
4	2483.50	50.6 AV	54.0	-3.4	3.82 V	351	52.0	-1.4
5	4924.00	45.9 PK	74.0	-28.1	3.82 V	360	42.6	3.3
6	4924.00	42.8 AV	54.0	-11.2	3.82 V	360	39.5	3.3
7	7386.00	41.0 PK	74.0	-33.0	1.77 V	230	31.9	9.1
8	7386.00	28.2 AV	54.0	-25.8	1.77 V	230	19.1	9.1

REMARKS:

1. Emission Level(dBuV/m) = Raw Value(dBuV) + Correction Factor(dB/m)
2. Correction Factor(dB/m) = Antenna Factor(dB/m) + Cable Factor(dB) – Pre-Amplifier Factor(dB)
3. The other emission levels were very low against the limit.
4. Margin value = Emission Level – Limit value
5. " * ": Fundamental frequency.

802.11n (HT20)

CHANNEL	TX Channel 1	DETECTOR FUNCTION	Peak (PK)
FREQUENCY RANGE	1GHz ~ 25GHz		Average (AV)

ANTENNA POLARITY & TEST DISTANCE: HORIZONTAL AT 3 M

NO.	FREQ. (MHz)	EMISSION LEVEL (dBuV/m)	LIMIT (dBuV/m)	MARGIN (dB)	ANTENNA HEIGHT (m)	TABLE ANGLE (Degree)	RAW VALUE (dBuV)	CORRECTION FACTOR (dB/m)
1	2390.00	68.5 PK	74.0	-5.5	2.25 H	318	70.1	-1.6
2	2390.00	53.7 AV	54.0	-0.3	2.25 H	318	55.3	-1.6
3	*2412.00	111.3 PK			2.25 H	318	112.8	-1.5
4	*2412.00	103.8 AV			2.25 H	318	105.3	-1.5
5	4824.00	47.1 PK	74.0	-26.9	1.85 H	56	44.1	3.0
6	4824.00	45.2 AV	54.0	-8.8	1.85 H	56	42.2	3.0

ANTENNA POLARITY & TEST DISTANCE: VERTICAL AT 3 M

NO.	FREQ. (MHz)	EMISSION LEVEL (dBuV/m)	LIMIT (dBuV/m)	MARGIN (dB)	ANTENNA HEIGHT (m)	TABLE ANGLE (Degree)	RAW VALUE (dBuV)	CORRECTION FACTOR (dB/m)
1	2390.00	67.8 PK	74.0	-6.2	3.84 V	347	69.4	-1.6
2	2390.00	50.5 AV	54.0	-3.5	3.84 V	347	52.1	-1.6
3	*2412.00	107.5 PK			3.84 V	347	109.0	-1.5
4	*2412.00	99.7 AV			3.84 V	347	101.2	-1.5
5	4824.00	45.5 PK	74.0	-28.5	3.85 V	360	42.5	3.0
6	4824.00	42.6 AV	54.0	-11.4	3.85 V	360	39.6	3.0

REMARKS:

1. Emission Level(dBuV/m) = Raw Value(dBuV) + Correction Factor(dB/m)
2. Correction Factor(dB/m) = Antenna Factor(dB/m) + Cable Factor(dB) – Pre-Amplifier Factor(dB)
3. The other emission levels were very low against the limit.
4. Margin value = Emission Level – Limit value
5. " * ": Fundamental frequency.

CHANNEL	TX Channel 6	DETECTOR FUNCTION	Peak (PK)
FREQUENCY RANGE	1GHz ~ 25GHz		Average (AV)

ANTENNA POLARITY & TEST DISTANCE: HORIZONTAL AT 3 M

NO.	FREQ. (MHz)	EMISSION LEVEL (dBuV/m)	LIMIT (dBuV/m)	MARGIN (dB)	ANTENNA HEIGHT (m)	TABLE ANGLE (Degree)	RAW VALUE (dBuV)	CORRECTION FACTOR (dB/m)
1	2390.00	67.5 PK	74.0	-6.5	2.27 H	307	69.1	-1.6
2	2390.00	53.9 AV	54.0	-0.1	2.27 H	307	55.5	-1.6
3	*2437.00	120.3 PK			2.27 H	307	121.8	-1.5
4	*2437.00	111.4 AV			2.27 H	307	112.9	-1.5
5	2483.50	67.7 PK	74.0	-6.3	2.27 H	307	69.1	-1.4
6	2483.50	53.2 AV	54.0	-0.8	2.27 H	307	54.6	-1.4
7	4874.00	48.4 PK	74.0	-25.6	1.94 H	44	45.2	3.2
8	4874.00	46.1 AV	54.0	-7.9	1.94 H	44	42.9	3.2
9	7311.00	41.7 PK	74.0	-32.3	1.20 H	72	32.8	8.9
10	7311.00	28.5 AV	54.0	-25.5	1.20 H	72	19.6	8.9

ANTENNA POLARITY & TEST DISTANCE: VERTICAL AT 3 M

NO.	FREQ. (MHz)	EMISSION LEVEL (dBuV/m)	LIMIT (dBuV/m)	MARGIN (dB)	ANTENNA HEIGHT (m)	TABLE ANGLE (Degree)	RAW VALUE (dBuV)	CORRECTION FACTOR (dB/m)
1	2390.00	66.8 PK	74.0	-7.2	3.90 V	331	68.4	-1.6
2	2390.00	50.8 AV	54.0	-3.2	3.90 V	331	52.4	-1.6
3	*2437.00	116.5 PK			3.90 V	331	118.0	-1.5
4	*2437.00	107.3 AV			3.90 V	331	108.8	-1.5
5	2483.50	65.7 PK	74.0	-8.3	3.90 V	331	67.1	-1.4
6	2483.50	50.1 AV	54.0	-3.9	3.90 V	331	51.5	-1.4
7	4874.00	46.4 PK	74.0	-27.6	3.91 V	360	43.2	3.2
8	4874.00	43.2 AV	54.0	-10.8	3.91 V	360	40.0	3.2
9	7311.00	41.3 PK	74.0	-32.7	1.80 V	267	32.4	8.9
10	7311.00	28.6 AV	54.0	-25.4	1.80 V	267	19.7	8.9

REMARKS:

1. Emission Level(dBuV/m) = Raw Value(dBuV) + Correction Factor(dB/m)
2. Correction Factor(dB/m) = Antenna Factor(dB/m) + Cable Factor(dB) – Pre-Amplifier Factor(dB)
3. The other emission levels were very low against the limit.
4. Margin value = Emission Level – Limit value
5. " * ": Fundamental frequency.

CHANNEL	TX Channel 11	DETECTOR FUNCTION	Peak (PK)
FREQUENCY RANGE	1GHz ~ 25GHz		Average (AV)

ANTENNA POLARITY & TEST DISTANCE: HORIZONTAL AT 3 M

NO.	FREQ. (MHz)	EMISSION LEVEL (dBuV/m)	LIMIT (dBuV/m)	MARGIN (dB)	ANTENNA HEIGHT (m)	TABLE ANGLE (Degree)	RAW VALUE (dBuV)	CORRECTION FACTOR (dB/m)
1	*2462.00	114.3 PK			2.26 H	306	115.7	-1.4
2	*2462.00	106.2 AV			2.26 H	306	107.6	-1.4
3	2483.50	71.4 PK	74.0	-2.6	2.26 H	306	72.8	-1.4
4	2483.50	53.6 AV	54.0	-0.4	2.26 H	306	55.0	-1.4
5	4924.00	47.5 PK	74.0	-26.5	1.93 H	40	44.2	3.3
6	4924.00	45.4 AV	54.0	-8.6	1.93 H	40	42.1	3.3
7	7386.00	42.0 PK	74.0	-32.0	1.23 H	76	32.9	9.1
8	7386.00	28.9 AV	54.0	-25.1	1.23 H	76	19.8	9.1

ANTENNA POLARITY & TEST DISTANCE: VERTICAL AT 3 M

NO.	FREQ. (MHz)	EMISSION LEVEL (dBuV/m)	LIMIT (dBuV/m)	MARGIN (dB)	ANTENNA HEIGHT (m)	TABLE ANGLE (Degree)	RAW VALUE (dBuV)	CORRECTION FACTOR (dB/m)
1	*2462.00	110.5 PK			3.82 V	346	111.9	-1.4
2	*2462.00	102.1 AV			3.82 V	346	103.5	-1.4
3	2483.50	69.3 PK	74.0	-4.7	3.82 V	346	70.7	-1.4
4	2483.50	50.3 AV	54.0	-3.7	3.82 V	346	51.7	-1.4
5	4924.00	45.3 PK	74.0	-28.7	3.82 V	360	42.0	3.3
6	4924.00	42.3 AV	54.0	-11.7	3.82 V	360	39.0	3.3
7	7386.00	41.6 PK	74.0	-32.4	1.83 V	239	32.5	9.1
8	7386.00	28.7 AV	54.0	-25.3	1.83 V	239	19.6	9.1

REMARKS:

1. Emission Level(dBuV/m) = Raw Value(dBuV) + Correction Factor(dB/m)
2. Correction Factor(dB/m) = Antenna Factor(dB/m) + Cable Factor(dB) – Pre-Amplifier Factor(dB)
3. The other emission levels were very low against the limit.
4. Margin value = Emission Level – Limit value
5. " * ": Fundamental frequency.

802.11n (HT40)

CHANNEL	TX Channel 3	DETECTOR FUNCTION	Peak (PK)
FREQUENCY RANGE	1GHz ~ 25GHz		Average (AV)

ANTENNA POLARITY & TEST DISTANCE: HORIZONTAL AT 3 M

NO.	FREQ. (MHz)	EMISSION LEVEL (dBuV/m)	LIMIT (dBuV/m)	MARGIN (dB)	ANTENNA HEIGHT (m)	TABLE ANGLE (Degree)	RAW VALUE (dBuV)	CORRECTION FACTOR (dB/m)
1	2390.00	64.3 PK	74.0	-9.7	1.71 H	56	65.9	-1.6
2	2390.00	53.9 AV	54.0	-0.1	1.71 H	56	55.5	-1.6
3	*2422.00	104.2 PK			1.71 H	56	105.8	-1.6
4	*2422.00	96.0 AV			1.71 H	56	97.6	-1.6
5	4844.00	36.4 PK	74.0	-37.6	2.14 H	155	33.3	3.1
6	4844.00	26.7 AV	54.0	-27.3	2.14 H	155	23.6	3.1
7	7266.00	41.5 PK	74.0	-32.5	1.43 H	217	32.6	8.9
8	7266.00	30.6 AV	54.0	-23.4	1.43 H	217	21.7	8.9

ANTENNA POLARITY & TEST DISTANCE: VERTICAL AT 3 M

NO.	FREQ. (MHz)	EMISSION LEVEL (dBuV/m)	LIMIT (dBuV/m)	MARGIN (dB)	ANTENNA HEIGHT (m)	TABLE ANGLE (Degree)	RAW VALUE (dBuV)	CORRECTION FACTOR (dB/m)
1	2390.00	60.2 PK	74.0	-13.8	1.66 V	360	61.8	-1.6
2	2390.00	49.9 AV	54.0	-4.1	1.66 V	360	51.5	-1.6
3	*2422.00	99.8 PK			1.66 V	360	101.4	-1.6
4	*2422.00	91.9 AV			1.66 V	360	93.5	-1.6
5	4844.00	35.9 PK	74.0	-38.1	1.48 V	312	32.8	3.1
6	4844.00	26.1 AV	54.0	-27.9	1.48 V	312	23.0	3.1
7	7266.00	41.8 PK	74.0	-32.2	2.10 V	188	32.9	8.9
8	7266.00	31.5 AV	54.0	-22.5	2.10 V	188	22.6	8.9

REMARKS:

- Emission Level(dBuV/m) = Raw Value(dBuV) + Correction Factor(dB/m)
- Correction Factor(dB/m) = Antenna Factor(dB/m) + Cable Factor(dB) – Pre-Amplifier Factor(dB)
- The other emission levels were very low against the limit.
- Margin value = Emission Level – Limit value
- " * ": Fundamental frequency.

CHANNEL	TX Channel 6	DETECTOR FUNCTION	Peak (PK)
FREQUENCY RANGE	1GHz ~ 25GHz		Average (AV)

ANTENNA POLARITY & TEST DISTANCE: HORIZONTAL AT 3 M

NO.	FREQ. (MHz)	EMISSION LEVEL (dBuV/m)	LIMIT (dBuV/m)	MARGIN (dB)	ANTENNA HEIGHT (m)	TABLE ANGLE (Degree)	RAW VALUE (dBuV)	CORRECTION FACTOR (dB/m)
1	2390.00	66.0 PK	74.0	-8.0	1.86 H	47	67.6	-1.6
2	2390.00	53.4 AV	54.0	-0.6	1.86 H	47	55.0	-1.6
3	*2437.00	106.7 PK			1.86 H	47	108.2	-1.5
4	*2437.00	99.3 AV			1.86 H	47	100.8	-1.5
5	2485.00	65.3 PK	74.0	-8.7	1.86 H	47	66.7	-1.4
6	2485.00	50.5 AV	54.0	-3.5	1.86 H	47	51.9	-1.4
7	4874.00	36.8 PK	74.0	-37.2	2.14 H	162	33.6	3.2
8	4874.00	27.0 AV	54.0	-27.0	2.14 H	162	23.8	3.2
9	7311.00	42.1 PK	74.0	-31.9	1.41 H	233	33.2	8.9
10	7311.00	31.0 AV	54.0	-23.0	1.41 H	233	22.1	8.9

ANTENNA POLARITY & TEST DISTANCE: VERTICAL AT 3 M

NO.	FREQ. (MHz)	EMISSION LEVEL (dBuV/m)	LIMIT (dBuV/m)	MARGIN (dB)	ANTENNA HEIGHT (m)	TABLE ANGLE (Degree)	RAW VALUE (dBuV)	CORRECTION FACTOR (dB/m)
1	2390.00	60.0 PK	74.0	-14.0	1.65 V	360	61.6	-1.6
2	2390.00	49.8 AV	54.0	-4.2	1.65 V	360	51.4	-1.6
3	*2437.00	102.3 PK			1.65 V	360	103.8	-1.5
4	*2437.00	95.3 AV			1.65 V	360	96.8	-1.5
5	2485.00	61.4 PK	74.0	-12.6	1.65 V	360	62.8	-1.4
6	2485.00	46.6 AV	54.0	-7.4	1.65 V	360	48.0	-1.4
7	4874.00	36.6 PK	74.0	-37.4	1.46 V	300	33.4	3.2
8	4874.00	26.5 AV	54.0	-27.5	1.46 V	300	23.3	3.2
9	7311.00	42.0 PK	74.0	-32.0	2.15 V	184	33.1	8.9
10	7311.00	31.5 AV	54.0	-22.5	2.15 V	184	22.6	8.9

REMARKS:

1. Emission Level(dBuV/m) = Raw Value(dBuV) + Correction Factor(dB/m)
2. Correction Factor(dB/m) = Antenna Factor(dB/m) + Cable Factor(dB) – Pre-Amplifier Factor(dB)
3. The other emission levels were very low against the limit.
4. Margin value = Emission Level – Limit value
5. " * ": Fundamental frequency.

CHANNEL	TX Channel 9	DETECTOR FUNCTION	Peak (PK)
FREQUENCY RANGE	1GHz ~ 25GHz		Average (AV)

ANTENNA POLARITY & TEST DISTANCE: HORIZONTAL AT 3 M

NO.	FREQ. (MHz)	EMISSION LEVEL (dBuV/m)	LIMIT (dBuV/m)	MARGIN (dB)	ANTENNA HEIGHT (m)	TABLE ANGLE (Degree)	RAW VALUE (dBuV)	CORRECTION FACTOR (dB/m)
1	*2452.00	104.5 PK			1.90 H	49	106.0	-1.5
2	*2452.00	97.1 AV			1.90 H	49	98.6	-1.5
3	2483.50	71.7 PK	74.0	-2.3	1.90 H	49	73.1	-1.4
4	2483.50	53.4 AV	54.0	-0.6	1.90 H	49	54.8	-1.4
5	4904.00	36.7 PK	74.0	-37.3	2.17 H	168	33.5	3.2
6	4904.00	26.8 AV	54.0	-27.2	2.17 H	168	23.6	3.2
7	7356.00	40.9 PK	74.0	-33.1	1.38 H	206	31.8	9.1
8	7356.00	30.2 AV	54.0	-23.8	1.38 H	206	21.1	9.1

ANTENNA POLARITY & TEST DISTANCE: VERTICAL AT 3 M

NO.	FREQ. (MHz)	EMISSION LEVEL (dBuV/m)	LIMIT (dBuV/m)	MARGIN (dB)	ANTENNA HEIGHT (m)	TABLE ANGLE (Degree)	RAW VALUE (dBuV)	CORRECTION FACTOR (dB/m)
1	*2452.00	100.2 PK			1.63 V	360	101.7	-1.5
2	*2452.00	93.1 AV			1.63 V	360	94.6	-1.5
3	2483.50	67.7 PK	74.0	-6.3	1.63 V	360	69.1	-1.4
4	2483.50	49.3 AV	54.0	-4.7	1.63 V	360	50.7	-1.4
5	4904.00	35.6 PK	74.0	-38.4	1.52 V	328	32.4	3.2
6	4904.00	26.0 AV	54.0	-28.0	1.52 V	328	22.8	3.2
7	7356.00	41.9 PK	74.0	-32.1	2.05 V	192	32.8	9.1
8	7356.00	31.4 AV	54.0	-22.6	2.05 V	192	22.3	9.1

REMARKS:

1. Emission Level(dBuV/m) = Raw Value(dBuV) + Correction Factor(dB/m)
2. Correction Factor(dB/m) = Antenna Factor(dB/m) + Cable Factor(dB) – Pre-Amplifier Factor(dB)
3. The other emission levels were very low against the limit.
4. Margin value = Emission Level – Limit value
5. " * ": Fundamental frequency.

Below 1GHz Data:

802.11b

CHANNEL	TX Channel 6	DETECTOR FUNCTION	Quasi-Peak (QP)
FREQUENCY RANGE	9kHz ~ 1GHz		

ANTENNA POLARITY & TEST DISTANCE: HORIZONTAL AT 3 M

NO.	FREQ. (MHz)	EMISSION LEVEL (dBuV/m)	LIMIT (dBuV/m)	MARGIN (dB)	ANTENNA HEIGHT (m)	TABLE ANGLE (Degree)	RAW VALUE (dBuV)	CORRECTION FACTOR (dB/m)
1	94.17	39.4 QP	43.5	-4.1	2.00 H	304	53.0	-13.6
2	219.52	33.9 QP	46.0	-12.1	1.00 H	143	45.1	-11.2
3	380.69	39.9 QP	46.0	-6.1	1.50 H	237	45.7	-5.8
4	470.74	42.6 QP	46.0	-3.4	2.00 H	133	46.2	-3.6
5	700.00	30.6 QP	46.0	-15.4	1.50 H	255	30.2	0.4
6	840.21	31.0 QP	46.0	-15.0	2.00 H	351	28.7	2.3

ANTENNA POLARITY & TEST DISTANCE: VERTICAL AT 3 M

NO.	FREQ. (MHz)	EMISSION LEVEL (dBuV/m)	LIMIT (dBuV/m)	MARGIN (dB)	ANTENNA HEIGHT (m)	TABLE ANGLE (Degree)	RAW VALUE (dBuV)	CORRECTION FACTOR (dB/m)
1	53.25	32.1 QP	40.0	-7.9	1.50 V	266	40.3	-8.2
2	113.26	27.2 QP	43.5	-16.3	1.50 V	143	38.0	-10.8
3	190.68	30.3 QP	43.5	-13.2	1.50 V	55	41.2	-10.9
4	373.19	42.2 QP	46.0	-3.8	3.00 V	135	48.1	-5.9
5	470.23	37.3 QP	46.0	-8.7	1.50 V	214	40.9	-3.6
6	896.21	35.9 QP	46.0	-10.1	2.00 V	143	33.0	2.9

REMARKS:

1. Emission Level(dBuV/m) = Raw Value(dBuV) + Correction Factor(dB/m)
2. Correction Factor(dB/m) = Antenna Factor(dB/m) + Cable Factor(dB) – Pre-Amplifier Factor(dB)
3. The other emission levels were very low against the limit.
4. Margin value = Emission Level – Limit value

4.1.10 Test Results (Mode 4)

Above 1GHz Data:

802.11b

CHANNEL	TX Channel 1	DETECTOR FUNCTION	Peak (PK)
FREQUENCY RANGE	1GHz ~ 25GHz		Average (AV)

ANTENNA POLARITY & TEST DISTANCE: HORIZONTAL AT 3 M

NO.	FREQ. (MHz)	EMISSION LEVEL (dBuV/m)	LIMIT (dBuV/m)	MARGIN (dB)	ANTENNA HEIGHT (m)	TABLE ANGLE (Degree)	RAW VALUE (dBuV)	CORRECTION FACTOR (dB/m)
1	2390.00	64.9 PK	74.0	-9.1	1.69 H	49	66.5	-1.6
2	2390.00	53.8 AV	54.0	-0.2	1.69 H	49	55.4	-1.6
3	*2412.00	110.9 PK			1.69 H	49	112.4	-1.5
4	*2412.00	109.7 AV			1.69 H	49	111.2	-1.5
5	4824.00	47.8 PK	74.0	-26.2	1.92 H	16	44.8	3.0
6	4824.00	45.6 AV	54.0	-8.4	1.92 H	16	42.6	3.0

ANTENNA POLARITY & TEST DISTANCE: VERTICAL AT 3 M

NO.	FREQ. (MHz)	EMISSION LEVEL (dBuV/m)	LIMIT (dBuV/m)	MARGIN (dB)	ANTENNA HEIGHT (m)	TABLE ANGLE (Degree)	RAW VALUE (dBuV)	CORRECTION FACTOR (dB/m)
1	2390.00	54.6 PK	74.0	-19.4	1.23 V	28	56.2	-1.6
2	2390.00	43.4 AV	54.0	-10.6	1.23 V	28	45.0	-1.6
3	*2412.00	105.8 PK			1.23 V	28	107.3	-1.5
4	*2412.00	103.1 AV			1.23 V	28	104.6	-1.5
5	4824.00	46.2 PK	74.0	-27.8	3.90 V	360	43.2	3.0
6	4824.00	42.8 AV	54.0	-11.2	3.90 V	360	39.8	3.0

REMARKS:

1. Emission Level(dBuV/m) = Raw Value(dBuV) + Correction Factor(dB/m)
2. Correction Factor(dB/m) = Antenna Factor(dB/m) + Cable Factor(dB) – Pre-Amplifier Factor(dB)
3. The other emission levels were very low against the limit.
4. Margin value = Emission Level – Limit value
5. " * ": Fundamental frequency.

CHANNEL	TX Channel 6	DETECTOR FUNCTION	Peak (PK)
FREQUENCY RANGE	1GHz ~ 25GHz		Average (AV)

ANTENNA POLARITY & TEST DISTANCE: HORIZONTAL AT 3 M

NO.	FREQ. (MHz)	EMISSION LEVEL (dBuV/m)	LIMIT (dBuV/m)	MARGIN (dB)	ANTENNA HEIGHT (m)	TABLE ANGLE (Degree)	RAW VALUE (dBuV)	CORRECTION FACTOR (dB/m)
1	2390.00	55.1 PK	74.0	-18.9	1.59 H	58	56.7	-1.6
2	2390.00	44.0 AV	54.0	-10.0	1.59 H	58	45.6	-1.6
3	*2437.00	110.0 PK			1.59 H	58	111.5	-1.5
4	*2437.00	107.9 AV			1.59 H	58	109.4	-1.5
5	2483.50	54.4 PK	74.0	-19.6	1.59 H	58	55.8	-1.4
6	2483.50	42.3 AV	54.0	-11.7	1.59 H	58	43.7	-1.4
7	4874.00	48.1 PK	74.0	-25.9	1.91 H	26	44.9	3.2
8	4874.00	45.9 AV	54.0	-8.1	1.91 H	26	42.7	3.2
9	7311.00	41.8 PK	74.0	-32.2	1.22 H	63	32.9	8.9
10	7311.00	28.4 AV	54.0	-25.6	1.22 H	63	19.5	8.9

ANTENNA POLARITY & TEST DISTANCE: VERTICAL AT 3 M

NO.	FREQ. (MHz)	EMISSION LEVEL (dBuV/m)	LIMIT (dBuV/m)	MARGIN (dB)	ANTENNA HEIGHT (m)	TABLE ANGLE (Degree)	RAW VALUE (dBuV)	CORRECTION FACTOR (dB/m)
1	2390.00	54.9 PK	74.0	-19.1	1.80 V	0	56.5	-1.6
2	2390.00	41.2 AV	54.0	-12.8	1.80 V	0	42.8	-1.6
3	*2437.00	105.9 PK			1.80 V	0	107.4	-1.5
4	*2437.00	103.6 AV			1.80 V	0	105.1	-1.5
5	2483.50	54.8 PK	74.0	-19.2	1.80 V	0	56.2	-1.4
6	2483.50	41.6 AV	54.0	-12.4	1.80 V	0	43.0	-1.4
7	4874.00	46.5 PK	74.0	-27.5	3.87 V	360	43.3	3.2
8	4874.00	43.1 AV	54.0	-10.9	3.87 V	360	39.9	3.2
9	7311.00	41.2 PK	74.0	-32.8	1.75 V	270	32.3	8.9
10	7311.00	28.4 AV	54.0	-25.6	1.75 V	270	19.5	8.9

REMARKS:

1. Emission Level(dBuV/m) = Raw Value(dBuV) + Correction Factor(dB/m)
2. Correction Factor(dB/m) = Antenna Factor(dB/m) + Cable Factor(dB) – Pre-Amplifier Factor(dB)
3. The other emission levels were very low against the limit.
4. Margin value = Emission Level – Limit value
5. " * ": Fundamental frequency.

CHANNEL	TX Channel 11	DETECTOR FUNCTION	Peak (PK)
FREQUENCY RANGE	1GHz ~ 25GHz		Average (AV)

ANTENNA POLARITY & TEST DISTANCE: HORIZONTAL AT 3 M

NO.	FREQ. (MHz)	EMISSION LEVEL (dBuV/m)	LIMIT (dBuV/m)	MARGIN (dB)	ANTENNA HEIGHT (m)	TABLE ANGLE (Degree)	RAW VALUE (dBuV)	CORRECTION FACTOR (dB/m)
1	*2462.00	111.1 PK			1.81 H	54	112.5	-1.4
2	*2462.00	109.0 AV			1.81 H	54	110.4	-1.4
3	2483.50	61.5 PK	74.0	-12.5	1.81 H	54	62.9	-1.4
4	2483.50	53.9 AV	54.0	-0.1	1.81 H	54	55.3	-1.4
5	4924.00	47.7 PK	74.0	-26.3	1.89 H	16	44.4	3.3
6	4924.00	45.2 AV	54.0	-8.8	1.89 H	16	41.9	3.3
7	7386.00	41.5 PK	74.0	-32.5	1.20 H	75	32.4	9.1
8	7386.00	28.1 AV	54.0	-25.9	1.20 H	75	19.0	9.1

ANTENNA POLARITY & TEST DISTANCE: VERTICAL AT 3 M

NO.	FREQ. (MHz)	EMISSION LEVEL (dBuV/m)	LIMIT (dBuV/m)	MARGIN (dB)	ANTENNA HEIGHT (m)	TABLE ANGLE (Degree)	RAW VALUE (dBuV)	CORRECTION FACTOR (dB/m)
1	*2462.00	105.7 PK			1.77 V	4	107.1	-1.4
2	*2462.00	103.5 AV			1.77 V	4	104.9	-1.4
3	2483.50	55.6 PK	74.0	-18.4	1.77 V	4	57.0	-1.4
4	2483.50	41.4 AV	54.0	-12.6	1.77 V	4	42.8	-1.4
5	4924.00	46.2 PK	74.0	-27.8	3.89 V	360	42.9	3.3
6	4924.00	43.0 AV	54.0	-11.0	3.89 V	360	39.7	3.3
7	7386.00	40.9 PK	74.0	-33.1	1.78 V	265	31.8	9.1
8	7386.00	28.0 AV	54.0	-26.0	1.78 V	265	18.9	9.1

REMARKS:

1. Emission Level(dBuV/m) = Raw Value(dBuV) + Correction Factor(dB/m)
2. Correction Factor(dB/m) = Antenna Factor(dB/m) + Cable Factor(dB) – Pre-Amplifier Factor(dB)
3. The other emission levels were very low against the limit.
4. Margin value = Emission Level – Limit value
5. " * ": Fundamental frequency.

802.11g

CHANNEL	TX Channel 1	DETECTOR FUNCTION	Peak (PK)
FREQUENCY RANGE	1GHz ~ 25GHz		Average (AV)

ANTENNA POLARITY & TEST DISTANCE: HORIZONTAL AT 3 M

NO.	FREQ. (MHz)	EMISSION LEVEL (dBuV/m)	LIMIT (dBuV/m)	MARGIN (dB)	ANTENNA HEIGHT (m)	TABLE ANGLE (Degree)	RAW VALUE (dBuV)	CORRECTION FACTOR (dB/m)
1	2390.00	70.9 PK	74.0	-3.1	1.67 H	48	72.5	-1.6
2	2390.00	53.8 AV	54.0	-0.2	1.67 H	48	55.4	-1.6
3	*2412.00	101.5 PK			1.67 H	48	103.0	-1.5
4	*2412.00	99.0 AV			1.67 H	48	100.5	-1.5
5	4824.00	48.5 PK	74.0	-25.5	1.98 H	6	45.5	3.0
6	4824.00	46.0 AV	54.0	-8.0	1.98 H	6	43.0	3.0

ANTENNA POLARITY & TEST DISTANCE: VERTICAL AT 3 M

NO.	FREQ. (MHz)	EMISSION LEVEL (dBuV/m)	LIMIT (dBuV/m)	MARGIN (dB)	ANTENNA HEIGHT (m)	TABLE ANGLE (Degree)	RAW VALUE (dBuV)	CORRECTION FACTOR (dB/m)
1	2390.00	64.6 PK	74.0	-9.4	1.59 V	13	66.2	-1.6
2	2390.00	45.0 AV	54.0	-9.0	1.59 V	13	46.6	-1.6
3	*2412.00	103.3 PK			1.59 V	13	104.8	-1.5
4	*2412.00	93.1 AV			1.59 V	13	94.6	-1.5
5	4824.00	45.8 PK	74.0	-28.2	3.92 V	353	42.8	3.0
6	4824.00	42.5 AV	54.0	-11.5	3.92 V	353	39.5	3.0

REMARKS:

1. Emission Level(dBuV/m) = Raw Value(dBuV) + Correction Factor(dB/m)
2. Correction Factor(dB/m) = Antenna Factor(dB/m) + Cable Factor(dB) – Pre-Amplifier Factor(dB)
3. The other emission levels were very low against the limit.
4. Margin value = Emission Level – Limit value
5. " * ": Fundamental frequency.

CHANNEL	TX Channel 6	DETECTOR FUNCTION	Peak (PK)
FREQUENCY RANGE	1GHz ~ 25GHz		Average (AV)

ANTENNA POLARITY & TEST DISTANCE: HORIZONTAL AT 3 M

NO.	FREQ. (MHz)	EMISSION LEVEL (dBuV/m)	LIMIT (dBuV/m)	MARGIN (dB)	ANTENNA HEIGHT (m)	TABLE ANGLE (Degree)	RAW VALUE (dBuV)	CORRECTION FACTOR (dB/m)
1	2390.00	65.2 PK	74.0	-8.8	1.56 H	58	66.8	-1.6
2	2390.00	49.2 AV	54.0	-4.8	1.56 H	58	50.8	-1.6
3	*2437.00	113.5 PK			1.56 H	58	115.0	-1.5
4	*2437.00	103.7 AV			1.56 H	58	105.2	-1.5
5	2483.50	63.1 PK	74.0	-10.9	1.56 H	58	64.5	-1.4
6	2483.50	44.6 AV	54.0	-9.4	1.56 H	58	46.0	-1.4
7	4874.00	48.2 PK	74.0	-25.8	1.96 H	22	45.0	3.2
8	4874.00	45.9 AV	54.0	-8.1	1.96 H	22	42.7	3.2
9	7311.00	41.5 PK	74.0	-32.5	1.23 H	56	32.6	8.9
10	7311.00	28.3 AV	54.0	-25.7	1.23 H	56	19.4	8.9

ANTENNA POLARITY & TEST DISTANCE: VERTICAL AT 3 M

NO.	FREQ. (MHz)	EMISSION LEVEL (dBuV/m)	LIMIT (dBuV/m)	MARGIN (dB)	ANTENNA HEIGHT (m)	TABLE ANGLE (Degree)	RAW VALUE (dBuV)	CORRECTION FACTOR (dB/m)
1	2390.00	55.7 PK	74.0	-18.3	1.39 V	24	57.3	-1.6
2	2390.00	42.2 AV	54.0	-11.8	1.39 V	24	43.8	-1.6
3	*2437.00	109.0 PK			1.39 V	24	110.5	-1.5
4	*2437.00	99.1 AV			1.39 V	24	100.6	-1.5
5	2483.50	56.7 PK	74.0	-17.3	1.39 V	24	58.1	-1.4
6	2483.50	42.3 AV	54.0	-11.7	1.39 V	24	43.7	-1.4
7	4874.00	46.5 PK	74.0	-27.5	3.89 V	360	43.3	3.2
8	4874.00	43.2 AV	54.0	-10.8	3.89 V	360	40.0	3.2
9	7311.00	41.0 PK	74.0	-33.0	1.80 V	263	32.1	8.9
10	7311.00	28.2 AV	54.0	-25.8	1.80 V	263	19.3	8.9

REMARKS:

1. Emission Level(dBuV/m) = Raw Value(dBuV) + Correction Factor(dB/m)
2. Correction Factor(dB/m) = Antenna Factor(dB/m) + Cable Factor(dB) – Pre-Amplifier Factor(dB)
3. The other emission levels were very low against the limit.
4. Margin value = Emission Level – Limit value
5. " * ": Fundamental frequency.

CHANNEL	TX Channel 11	DETECTOR FUNCTION	Peak (PK)
FREQUENCY RANGE	1GHz ~ 25GHz		Average (AV)

ANTENNA POLARITY & TEST DISTANCE: HORIZONTAL AT 3 M

NO.	FREQ. (MHz)	EMISSION LEVEL (dBuV/m)	LIMIT (dBuV/m)	MARGIN (dB)	ANTENNA HEIGHT (m)	TABLE ANGLE (Degree)	RAW VALUE (dBuV)	CORRECTION FACTOR (dB/m)
1	*2462.00	101.0 PK			1.77 H	50	102.4	-1.4
2	*2462.00	100.9 AV			1.77 H	50	102.3	-1.4
3	2483.50	70.4 PK	74.0	-3.6	1.77 H	50	71.8	-1.4
4	2483.50	53.8 AV	54.0	-0.2	1.77 H	50	55.2	-1.4
5	4924.00	46.9 PK	74.0	-27.1	1.94 H	21	43.6	3.3
6	4924.00	44.7 AV	54.0	-9.3	1.94 H	21	41.4	3.3
7	7386.00	41.5 PK	74.0	-32.5	1.20 H	88	32.4	9.1
8	7386.00	28.4 AV	54.0	-25.6	1.20 H	88	19.3	9.1

ANTENNA POLARITY & TEST DISTANCE: VERTICAL AT 3 M

NO.	FREQ. (MHz)	EMISSION LEVEL (dBuV/m)	LIMIT (dBuV/m)	MARGIN (dB)	ANTENNA HEIGHT (m)	TABLE ANGLE (Degree)	RAW VALUE (dBuV)	CORRECTION FACTOR (dB/m)
1	*2462.00	106.0 PK			1.75 V	0	107.4	-1.4
2	*2462.00	95.5 AV			1.75 V	0	96.9	-1.4
3	2483.50	61.8 PK	74.0	-12.2	1.75 V	0	63.2	-1.4
4	2483.50	44.8 AV	54.0	-9.2	1.75 V	0	46.2	-1.4
5	4924.00	46.1 PK	74.0	-27.9	3.89 V	354	42.8	3.3
6	4924.00	43.1 AV	54.0	-10.9	3.89 V	354	39.8	3.3
7	7386.00	41.0 PK	74.0	-33.0	1.83 V	275	31.9	9.1
8	7386.00	28.2 AV	54.0	-25.8	1.83 V	275	19.1	9.1

REMARKS:

1. Emission Level(dBuV/m) = Raw Value(dBuV) + Correction Factor(dB/m)
2. Correction Factor(dB/m) = Antenna Factor(dB/m) + Cable Factor(dB) – Pre-Amplifier Factor(dB)
3. The other emission levels were very low against the limit.
4. Margin value = Emission Level – Limit value
5. " * ": Fundamental frequency.

802.11n (HT20)

CHANNEL	TX Channel 1	DETECTOR FUNCTION	Peak (PK)
FREQUENCY RANGE	1GHz ~ 25GHz		Average (AV)

ANTENNA POLARITY & TEST DISTANCE: HORIZONTAL AT 3 M

NO.	FREQ. (MHz)	EMISSION LEVEL (dBuV/m)	LIMIT (dBuV/m)	MARGIN (dB)	ANTENNA HEIGHT (m)	TABLE ANGLE (Degree)	RAW VALUE (dBuV)	CORRECTION FACTOR (dB/m)
1	2390.00	69.2 PK	74.0	-4.8	1.67 H	48	70.8	-1.6
2	2390.00	53.7 AV	54.0	-0.3	1.67 H	48	55.3	-1.6
3	*2412.00	108.9 PK			1.67 H	48	110.4	-1.5
4	*2412.00	98.5 AV			1.67 H	48	100.0	-1.5
5	4824.00	47.8 PK	74.0	-26.2	1.90 H	2	44.8	3.0
6	4824.00	45.6 AV	54.0	-8.4	1.90 H	2	42.6	3.0

ANTENNA POLARITY & TEST DISTANCE: VERTICAL AT 3 M

NO.	FREQ. (MHz)	EMISSION LEVEL (dBuV/m)	LIMIT (dBuV/m)	MARGIN (dB)	ANTENNA HEIGHT (m)	TABLE ANGLE (Degree)	RAW VALUE (dBuV)	CORRECTION FACTOR (dB/m)
1	2390.00	63.3 PK	74.0	-10.7	1.44 V	14	64.9	-1.6
2	2390.00	44.5 AV	54.0	-9.5	1.44 V	14	46.1	-1.6
3	*2412.00	103.8 PK			1.44 V	14	105.3	-1.5
4	*2412.00	93.4 AV			1.44 V	14	94.9	-1.5
5	4824.00	46.3 PK	74.0	-27.7	3.90 V	360	43.3	3.0
6	4824.00	42.7 AV	54.0	-11.3	3.90 V	360	39.7	3.0

REMARKS:

1. Emission Level(dBuV/m) = Raw Value(dBuV) + Correction Factor(dB/m)
2. Correction Factor(dB/m) = Antenna Factor(dB/m) + Cable Factor(dB) – Pre-Amplifier Factor(dB)
3. The other emission levels were very low against the limit.
4. Margin value = Emission Level – Limit value
5. " * ": Fundamental frequency.

CHANNEL	TX Channel 6	DETECTOR FUNCTION	Peak (PK)
FREQUENCY RANGE	1GHz ~ 25GHz		Average (AV)

ANTENNA POLARITY & TEST DISTANCE: HORIZONTAL AT 3 M

NO.	FREQ. (MHz)	EMISSION LEVEL (dBuV/m)	LIMIT (dBuV/m)	MARGIN (dB)	ANTENNA HEIGHT (m)	TABLE ANGLE (Degree)	RAW VALUE (dBuV)	CORRECTION FACTOR (dB/m)
1	2390.00	65.8 PK	74.0	-8.2	1.60 H	59	67.4	-1.6
2	2390.00	48.4 AV	54.0	-5.6	1.60 H	59	50.0	-1.6
3	*2437.00	113.7 PK			1.60 H	59	115.2	-1.5
4	*2437.00	103.1 AV			1.60 H	59	104.6	-1.5
5	2483.50	63.4 PK	74.0	-10.6	1.60 H	59	64.8	-1.4
6	2483.50	46.1 AV	54.0	-7.9	1.60 H	59	47.5	-1.4
7	4874.00	48.4 PK	74.0	-25.6	1.88 H	27	45.2	3.2
8	4874.00	46.3 AV	54.0	-7.7	1.88 H	27	43.1	3.2
9	7311.00	41.3 PK	74.0	-32.7	1.18 H	64	32.4	8.9
10	7311.00	28.0 AV	54.0	-26.0	1.18 H	64	19.1	8.9

ANTENNA POLARITY & TEST DISTANCE: VERTICAL AT 3 M

NO.	FREQ. (MHz)	EMISSION LEVEL (dBuV/m)	LIMIT (dBuV/m)	MARGIN (dB)	ANTENNA HEIGHT (m)	TABLE ANGLE (Degree)	RAW VALUE (dBuV)	CORRECTION FACTOR (dB/m)
1	2390.00	61.0 PK	74.0	-13.0	1.85 V	349	62.6	-1.6
2	2390.00	43.9 AV	54.0	-10.1	1.85 V	349	45.5	-1.6
3	*2437.00	109.5 PK			1.85 V	349	111.0	-1.5
4	*2437.00	98.5 AV			1.85 V	349	100.0	-1.5
5	2483.50	58.1 PK	74.0	-15.9	1.85 V	349	59.5	-1.4
6	2483.50	41.5 AV	54.0	-12.5	1.85 V	349	42.9	-1.4
7	4874.00	45.9 PK	74.0	-28.1	3.89 V	360	42.7	3.2
8	4874.00	42.9 AV	54.0	-11.1	3.89 V	360	39.7	3.2
9	7311.00	41.6 PK	74.0	-32.4	1.83 V	263	32.7	8.9
10	7311.00	28.5 AV	54.0	-25.5	1.83 V	263	19.6	8.9

REMARKS:

1. Emission Level(dBuV/m) = Raw Value(dBuV) + Correction Factor(dB/m)
2. Correction Factor(dB/m) = Antenna Factor(dB/m) + Cable Factor(dB) – Pre-Amplifier Factor(dB)
3. The other emission levels were very low against the limit.
4. Margin value = Emission Level – Limit value
5. " * ": Fundamental frequency.

CHANNEL	TX Channel 11	DETECTOR FUNCTION	Peak (PK)
FREQUENCY RANGE	1GHz ~ 25GHz		Average (AV)

ANTENNA POLARITY & TEST DISTANCE: HORIZONTAL AT 3 M

NO.	FREQ. (MHz)	EMISSION LEVEL (dBuV/m)	LIMIT (dBuV/m)	MARGIN (dB)	ANTENNA HEIGHT (m)	TABLE ANGLE (Degree)	RAW VALUE (dBuV)	CORRECTION FACTOR (dB/m)
1	*2462.00	110.3 PK			1.76 H	55	111.7	-1.4
2	*2462.00	99.7 AV			1.76 H	55	101.1	-1.4
3	2483.50	72.8 PK	74.0	-1.2	1.76 H	55	74.2	-1.4
4	2483.50	53.9 AV	54.0	-0.1	1.76 H	55	55.3	-1.4
5	4924.00	47.7 PK	74.0	-26.3	1.92 H	32	44.4	3.3
6	4924.00	45.4 AV	54.0	-8.6	1.92 H	32	42.1	3.3
7	7386.00	41.4 PK	74.0	-32.6	1.25 H	69	32.3	9.1
8	7386.00	27.9 AV	54.0	-26.1	1.25 H	69	18.8	9.1

ANTENNA POLARITY & TEST DISTANCE: VERTICAL AT 3 M

NO.	FREQ. (MHz)	EMISSION LEVEL (dBuV/m)	LIMIT (dBuV/m)	MARGIN (dB)	ANTENNA HEIGHT (m)	TABLE ANGLE (Degree)	RAW VALUE (dBuV)	CORRECTION FACTOR (dB/m)
1	*2462.00	103.2 PK			1.70 V	2	104.6	-1.4
2	*2462.00	92.9 AV			1.70 V	2	94.3	-1.4
3	2483.50	64.4 PK	74.0	-9.6	1.70 V	2	65.8	-1.4
4	2483.50	45.1 AV	54.0	-8.9	1.70 V	2	46.5	-1.4
5	4924.00	46.2 PK	74.0	-27.8	3.95 V	356	42.9	3.3
6	4924.00	42.8 AV	54.0	-11.2	3.95 V	356	39.5	3.3
7	7386.00	41.1 PK	74.0	-32.9	1.73 V	267	32.0	9.1
8	7386.00	28.4 AV	54.0	-25.6	1.73 V	267	19.3	9.1

REMARKS:

1. Emission Level(dBuV/m) = Raw Value(dBuV) + Correction Factor(dB/m)
2. Correction Factor(dB/m) = Antenna Factor(dB/m) + Cable Factor(dB) – Pre-Amplifier Factor(dB)
3. The other emission levels were very low against the limit.
4. Margin value = Emission Level – Limit value
5. " * ": Fundamental frequency.

802.11n (HT40)

CHANNEL	TX Channel 3	DETECTOR FUNCTION	Peak (PK)
FREQUENCY RANGE	1GHz ~ 25GHz		Average (AV)

ANTENNA POLARITY & TEST DISTANCE: HORIZONTAL AT 3 M								
NO.	FREQ. (MHz)	EMISSION LEVEL (dBuV/m)	LIMIT (dBuV/m)	MARGIN (dB)	ANTENNA HEIGHT (m)	TABLE ANGLE (Degree)	RAW VALUE (dBuV)	CORRECTION FACTOR (dB/m)
1	2390.00	72.6 PK	74.0	-1.4	1.64 H	51	74.2	-1.6
2	2390.00	53.9 AV	54.0	-0.1	1.64 H	51	55.5	-1.6
3	*2422.00	104.6 PK			1.64 H	51	106.2	-1.6
4	*2422.00	93.7 AV			1.64 H	51	95.3	-1.6
5	4844.00	37.6 PK	74.0	-36.4	1.63 H	23	34.5	3.1
6	4844.00	25.1 AV	54.0	-28.9	1.63 H	23	22.0	3.1
7	7266.00	43.2 PK	74.0	-30.8	2.30 H	252	34.3	8.9
8	7266.00	30.0 AV	54.0	-24.0	2.30 H	252	21.1	8.9

ANTENNA POLARITY & TEST DISTANCE: VERTICAL AT 3 M								
NO.	FREQ. (MHz)	EMISSION LEVEL (dBuV/m)	LIMIT (dBuV/m)	MARGIN (dB)	ANTENNA HEIGHT (m)	TABLE ANGLE (Degree)	RAW VALUE (dBuV)	CORRECTION FACTOR (dB/m)
1	2390.00	60.2 PK	74.0	-13.8	1.46 V	20	61.8	-1.6
2	2390.00	45.6 AV	54.0	-8.4	1.46 V	20	47.2	-1.6
3	*2422.00	97.6 PK			1.46 V	20	99.2	-1.6
4	*2422.00	86.4 AV			1.46 V	20	88.0	-1.6
5	4844.00	37.5 PK	74.0	-36.5	1.65 V	126	34.4	3.1
6	4844.00	25.2 AV	54.0	-28.8	1.65 V	126	22.1	3.1
7	7266.00	42.1 PK	74.0	-31.9	1.00 V	33	33.2	8.9
8	7266.00	29.7 AV	54.0	-24.3	1.00 V	33	20.8	8.9

REMARKS:

- Emission Level(dBuV/m) = Raw Value(dBuV) + Correction Factor(dB/m)
- Correction Factor(dB/m) = Antenna Factor(dB/m) + Cable Factor(dB) – Pre-Amplifier Factor(dB)
- The other emission levels were very low against the limit.
- Margin value = Emission Level – Limit value
- " * ": Fundamental frequency.

CHANNEL	TX Channel 6	DETECTOR FUNCTION	Peak (PK)
FREQUENCY RANGE	1GHz ~ 25GHz		Average (AV)

ANTENNA POLARITY & TEST DISTANCE: HORIZONTAL AT 3 M

NO.	FREQ. (MHz)	EMISSION LEVEL (dBuV/m)	LIMIT (dBuV/m)	MARGIN (dB)	ANTENNA HEIGHT (m)	TABLE ANGLE (Degree)	RAW VALUE (dBuV)	CORRECTION FACTOR (dB/m)
1	2390.00	71.0 PK	74.0	-3.0	1.46 H	60	72.6	-1.6
2	2390.00	53.9 AV	54.0	-0.1	1.46 H	60	55.5	-1.6
3	*2437.00	104.2 PK			1.46 H	60	105.7	-1.5
4	*2437.00	93.5 AV			1.46 H	60	95.0	-1.5
5	2483.50	70.5 PK	74.0	-3.5	1.46 H	60	71.9	-1.4
6	2483.50	50.5 AV	54.0	-3.5	1.46 H	60	51.9	-1.4
7	4874.00	36.5 PK	74.0	-37.5	2.16 H	150	33.3	3.2
8	4874.00	26.8 AV	54.0	-27.2	2.16 H	150	23.6	3.2
9	7311.00	42.2 PK	74.0	-31.8	1.48 H	219	33.3	8.9
10	7311.00	31.0 AV	54.0	-23.0	1.48 H	219	22.1	8.9

ANTENNA POLARITY & TEST DISTANCE: VERTICAL AT 3 M

NO.	FREQ. (MHz)	EMISSION LEVEL (dBuV/m)	LIMIT (dBuV/m)	MARGIN (dB)	ANTENNA HEIGHT (m)	TABLE ANGLE (Degree)	RAW VALUE (dBuV)	CORRECTION FACTOR (dB/m)
1	2390.00	67.7 PK	74.0	-6.3	1.70 V	15	69.3	-1.6
2	2390.00	50.9 AV	54.0	-3.1	1.70 V	15	52.5	-1.6
3	*2437.00	100.0 PK			1.70 V	15	101.5	-1.5
4	*2437.00	89.6 AV			1.70 V	15	91.1	-1.5
5	2483.50	60.9 PK	74.0	-13.1	1.70 V	15	62.3	-1.4
6	2483.50	43.6 AV	54.0	-10.4	1.70 V	15	45.0	-1.4
7	4874.00	36.4 PK	74.0	-37.6	1.43 V	320	33.2	3.2
8	4874.00	26.3 AV	54.0	-27.7	1.43 V	320	23.1	3.2
9	7311.00	42.0 PK	74.0	-32.0	2.08 V	183	33.1	8.9
10	7311.00	31.6 AV	54.0	-22.4	2.08 V	183	22.7	8.9

REMARKS:

1. Emission Level(dBuV/m) = Raw Value(dBuV) + Correction Factor(dB/m)
2. Correction Factor(dB/m) = Antenna Factor(dB/m) + Cable Factor(dB) – Pre-Amplifier Factor(dB)
3. The other emission levels were very low against the limit.
4. Margin value = Emission Level – Limit value
5. " * ": Fundamental frequency.

CHANNEL	TX Channel 9	DETECTOR FUNCTION	Peak (PK)
FREQUENCY RANGE	1GHz ~ 25GHz		Average (AV)

ANTENNA POLARITY & TEST DISTANCE: HORIZONTAL AT 3 M

NO.	FREQ. (MHz)	EMISSION LEVEL (dBuV/m)	LIMIT (dBuV/m)	MARGIN (dB)	ANTENNA HEIGHT (m)	TABLE ANGLE (Degree)	RAW VALUE (dBuV)	CORRECTION FACTOR (dB/m)
1	*2452.00	104.8 PK			1.52 H	59	106.3	-1.5
2	*2452.00	94.7 AV			1.52 H	59	96.2	-1.5
3	2483.50	72.3 PK	74.0	-1.7	1.52 H	59	73.7	-1.4
4	2483.50	53.8 AV	54.0	-0.2	1.52 H	59	55.2	-1.4
5	4904.00	37.7 PK	74.0	-36.3	2.30 H	120	34.5	3.2
6	4904.00	25.1 AV	54.0	-28.9	2.30 H	120	21.9	3.2
7	7356.00	43.5 PK	74.0	-30.5	1.92 H	253	34.4	9.1
8	7356.00	29.9 AV	54.0	-24.1	1.92 H	253	20.8	9.1

ANTENNA POLARITY & TEST DISTANCE: VERTICAL AT 3 M

NO.	FREQ. (MHz)	EMISSION LEVEL (dBuV/m)	LIMIT (dBuV/m)	MARGIN (dB)	ANTENNA HEIGHT (m)	TABLE ANGLE (Degree)	RAW VALUE (dBuV)	CORRECTION FACTOR (dB/m)
1	*2452.00	98.1 PK			1.77 V	357	99.6	-1.5
2	*2452.00	86.2 AV			1.77 V	357	87.7	-1.5
3	2483.50	58.0 PK	74.0	-16.0	1.77 V	357	59.4	-1.4
4	2483.50	42.0 AV	54.0	-12.0	1.77 V	357	43.4	-1.4
5	4904.00	37.7 PK	74.0	-36.3	1.75 V	20	34.5	3.2
6	4904.00	24.8 AV	54.0	-29.2	1.75 V	20	21.6	3.2
7	7356.00	43.3 PK	74.0	-30.7	1.68 V	263	34.2	9.1
8	7356.00	29.8 AV	54.0	-24.2	1.68 V	263	20.7	9.1

REMARKS:

1. Emission Level(dBuV/m) = Raw Value(dBuV) + Correction Factor(dB/m)
2. Correction Factor(dB/m) = Antenna Factor(dB/m) + Cable Factor(dB) – Pre-Amplifier Factor(dB)
3. The other emission levels were very low against the limit.
4. Margin value = Emission Level – Limit value
5. " * ": Fundamental frequency.

Below 1GHz Data:

802.11b

CHANNEL	TX Channel 6	DETECTOR FUNCTION	Quasi-Peak (QP)
FREQUENCY RANGE	9kHz ~ 1GHz		

ANTENNA POLARITY & TEST DISTANCE: HORIZONTAL AT 3 M

NO.	FREQ. (MHz)	EMISSION LEVEL (dBuV/m)	LIMIT (dBuV/m)	MARGIN (dB)	ANTENNA HEIGHT (m)	TABLE ANGLE (Degree)	RAW VALUE (dBuV)	CORRECTION FACTOR (dB/m)
1	78.33	28.8 QP	40.0	-11.2	3.00 H	89	41.4	-12.6
2	125.01	33.6 QP	43.5	-9.9	3.00 H	114	43.3	-9.7
3	221.38	37.9 QP	46.0	-8.1	1.00 H	86	49.0	-11.1
4	363.75	39.5 QP	46.0	-6.5	1.00 H	336	45.6	-6.1
5	510.59	29.3 QP	46.0	-16.7	1.00 H	60	32.1	-2.8
6	600.04	30.7 QP	46.0	-15.3	1.00 H	1	31.6	-0.9

ANTENNA POLARITY & TEST DISTANCE: VERTICAL AT 3 M

NO.	FREQ. (MHz)	EMISSION LEVEL (dBuV/m)	LIMIT (dBuV/m)	MARGIN (dB)	ANTENNA HEIGHT (m)	TABLE ANGLE (Degree)	RAW VALUE (dBuV)	CORRECTION FACTOR (dB/m)
1	62.52	35.7 QP	40.0	-4.3	1.00 V	161	45.0	-9.3
2	91.11	34.8 QP	43.5	-8.7	1.00 V	294	48.7	-13.9
3	179.65	32.5 QP	43.5	-11.0	1.00 V	305	42.2	-9.7
4	384.75	41.1 QP	46.0	-4.9	2.00 V	360	46.8	-5.7
5	438.64	41.2 QP	46.0	-4.8	1.00 V	0	45.1	-3.9
6	550.87	34.9 QP	46.0	-11.1	2.00 V	360	37.1	-2.2

REMARKS:

1. Emission Level(dBuV/m) = Raw Value(dBuV) + Correction Factor(dB/m)
2. Correction Factor(dB/m) = Antenna Factor(dB/m) + Cable Factor(dB) – Pre-Amplifier Factor(dB)
3. The other emission levels were very low against the limit.
4. Margin value = Emission Level – Limit value

4.2 Conducted Emission Measurement

4.2.1 Limits of Conducted Emission Measurement

Frequency (MHz)	Conducted Limit (dBuV)	
	Quasi-peak	Average
0.15 - 0.5	66 - 56	56 - 46
0.50 - 5.0	56	46
5.0 - 30.0	60	50

Note: 1. The lower limit shall apply at the transition frequencies.

2. The limit decreases in line with the logarithm of the frequency in the range of 0.15 to 0.50MHz.

4.2.2 Test Instruments

DESCRIPTION & MANUFACTURER	MODEL NO.	SERIAL NO.	CALIBRATED DATE	CALIBRATED UNTIL
Test Receiver R&S	ESCS 30	847124/029	Oct. 24, 2016	Oct. 23, 2017
Line-Impedance Stabilization Network (for EUT) R&S	ESH3-Z5	848773/004	Oct. 26, 2016	Oct. 25, 2017
Line-Impedance Stabilization Network (for Peripheral) R&S	ENV216	100072	June 03, 2017	June 02, 2018
50 ohms Terminator	N/A	EMC-02	Sep. 22, 2017	Sep. 21, 2018
RF Cable	5D-FB	COCCAB-001	Sep. 29, 2017	Sep. 28, 2018
10 dB PAD Mini-Circuits	HAT-10+	CONATT-004	June 18, 2017	June 17, 2018
Software BVADT	BVADT_Cond_ V7.3.7.4	NA	NA	NA

Note:

1. The calibration interval of the above test instruments are 12 months and the calibrations are traceable to NML/ROC and NIST/USA.
2. The test was performed in Shielded Room No. 1.
3. Tested Date: Oct. 04, 2017

4.2.3 Test Procedures

- The EUT was placed 0.4 meters from the conducting wall of the shielded room with EUT being connected to the power mains through a line impedance stabilization network (LISN). Other support units were connected to the power mains through another LISN. The two LISNs provide 50 ohm/ 50uH of coupling impedance for the measuring instrument.
- Both lines of the power mains connected to the EUT were checked for maximum conducted interference.
- The frequency range from 150kHz to 30MHz was searched. Emission levels under (Limit - 20dB) was not recorded.

NOTE: The resolution bandwidth and video bandwidth of test receiver is 9kHz for quasi-peak detection (QP) and average detection (AV) at frequency 0.15MHz-30MHz.

4.2.4 Deviation from Test Standard

No deviation.

4.2.5 Test Setup

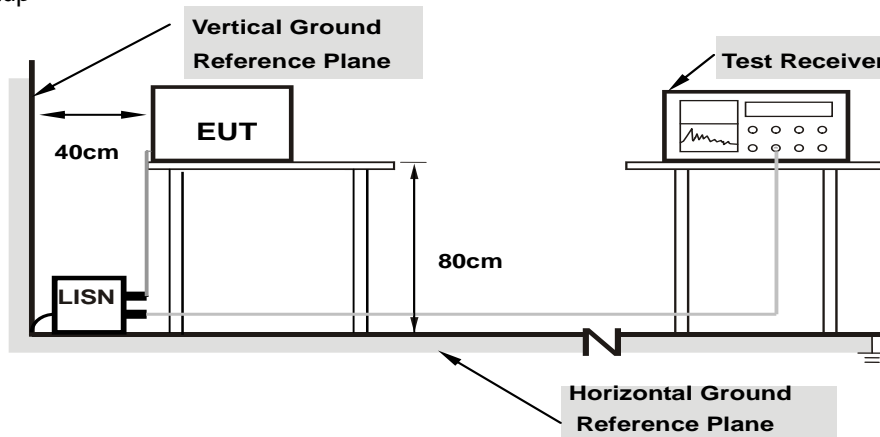

Note: 1.Support units were connected to second LISN.

For the actual test configuration, please refer to the attached file (Test Setup Photo).

4.2.6 EUT Operating Conditions

Same as 4.1.6.

4.2.7 Test Results (Mode 1)

Phase	Line (L)	Detector Function	Quasi-Peak (QP) / Average (AV)
-------	----------	-------------------	--------------------------------

No	Freq. [MHz]	Corr. Factor	Reading Value [dB (uV)]		Emission Level [dB (uV)]		Limit [dB (uV)]		Margin (dB)	
		(dB)	Q.P.	AV.	Q.P.	AV.	Q.P.	AV.	Q.P.	AV.
	1	0.16172	10.07	42.46	31.31	52.53	41.38	65.38	55.38	-12.85
2	0.20469	10.06	36.38	25.93	46.44	35.99	63.42	53.42	-16.98	-17.43
3	0.24375	10.07	30.69	19.94	40.76	30.01	61.97	51.97	-21.21	-21.96
4	0.44297	10.11	28.54	17.39	38.65	27.50	57.01	47.01	-18.36	-19.51
5	6.31250	10.42	23.48	21.37	33.90	31.79	60.00	50.00	-26.10	-18.21
6	18.50391	11.19	22.94	7.08	34.13	18.27	60.00	50.00	-25.87	-31.73

REMARKS:

1. Q.P. and AV. are abbreviations of quasi-peak and average individually.
2. The emission levels of other frequencies were very low against the limit.
3. Margin value = Emission level - Limit value
4. Correction factor = Insertion loss + Cable loss
5. Emission Level = Correction Factor + Reading Value.

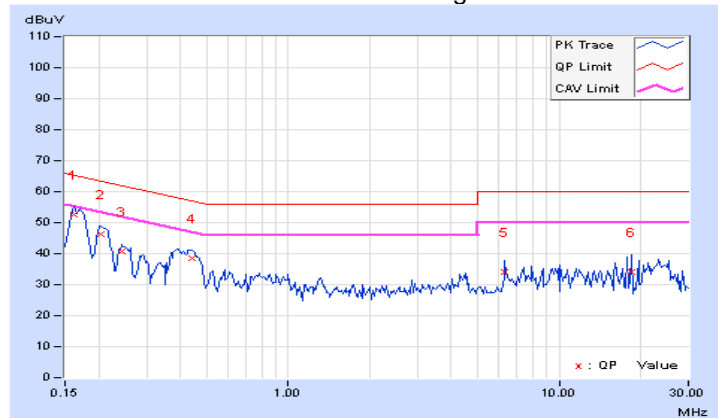

Phase	Neutral (N)	Detector Function	Quasi-Peak (QP) / Average (AV)
-------	-------------	-------------------	--------------------------------

No	Freq. [MHz]	Corr.	Reading Value		Emission Level		Limit		Margin	
		Factor (dB)	[dB (uV)]		[dB (uV)]		[dB (uV)]		(dB)	
			Q.P.	AV.	Q.P.	AV.	Q.P.	AV.	Q.P.	AV.
1	0.16253	10.05	42.62	31.87	52.67	41.92	65.33	55.33	-12.66	-13.41
2	0.20078	10.03	35.22	21.84	45.25	31.87	63.58	53.58	-18.33	-21.71
3	0.24813	10.05	29.97	20.85	40.02	30.90	61.82	51.82	-21.80	-20.92
4	0.43516	10.10	26.99	13.61	37.09	23.71	57.15	47.15	-20.06	-23.44
5	6.32422	10.35	21.41	18.32	31.76	28.67	60.00	50.00	-28.24	-21.33
6	21.19141	11.00	23.41	10.60	34.41	21.60	60.00	50.00	-25.59	-28.40

REMARKS:

1. Q.P. and AV. are abbreviations of quasi-peak and average individually.
2. The emission levels of other frequencies were very low against the limit.
3. Margin value = Emission level - Limit value
4. Correction factor = Insertion loss + Cable loss
5. Emission Level = Correction Factor + Reading Value.

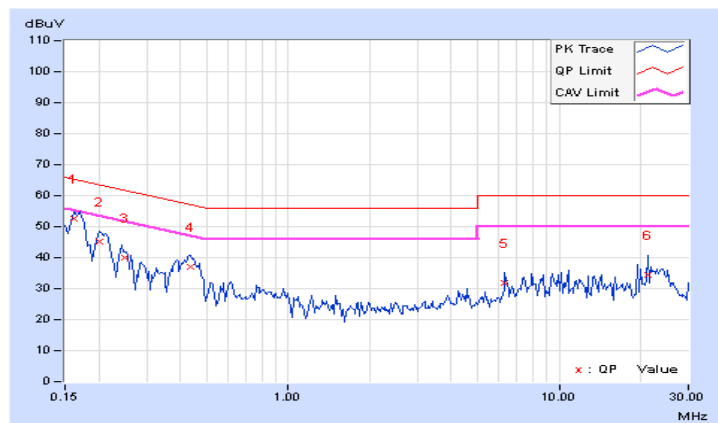

4.3 6dB Bandwidth Measurement

4.3.1 Limits of 6dB Bandwidth Measurement

The minimum of 6dB Bandwidth Measurement is 0.5 MHz.

4.3.2 Test Setup

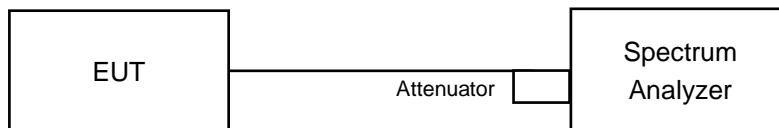

4.3.3 Test Instruments

Refer to section 4.1.2 to get information of above instrument.

4.3.4 Test Procedure

- a. Set resolution bandwidth (RBW) = 100kHz
- b. Set the video bandwidth (VBW) $\geq 3 \times$ RBW, Detector = Peak.
- c. Trace mode = max hold.
- d. Sweep = auto couple.
- e. Measure the maximum width of the emission that is constrained by the frequencies associated with the two amplitude points (upper and lower) that are attenuated by 6 dB relative to the maximum level measured in the fundamental emission

4.3.5 Deviation from Test Standard

No deviation.

4.3.6 EUT Operating Conditions

The software provided by client to enable the EUT under transmission condition continuously at lowest, middle and highest channel frequencies individually.

4.3.7 Test Result (Mode 1)

802.11b

Channel	Frequency (MHz)	6dB Bandwidth (MHz)				Minimum Limit (MHz)	Pass / Fail
		Chain 0	Chain 1	Chain 2	Chain 3		
1	2412	8.09	8.11	8.11	8.06	0.5	PASS
6	2437	8.08	8.09	8.04	8.07	0.5	PASS
11	2462	7.64	7.59	8.11	8.06	0.5	PASS

802.11g

Channel	Frequency (MHz)	6dB Bandwidth (MHz)				Minimum Limit (MHz)	Pass / Fail
		Chain 0	Chain 1	Chain 2	Chain 3		
1	2412	15.18	15.18	15.18	15.17	0.5	PASS
6	2437	15.21	15.18	15.19	15.13	0.5	PASS
11	2462	15.17	15.14	15.17	15.19	0.5	PASS

802.11n (HT20)

Channel	Frequency (MHz)	6dB Bandwidth (MHz)				Minimum Limit (MHz)	Pass / Fail
		Chain 0	Chain 1	Chain 2	Chain 3		
1	2412	15.14	16.35	15.17	15.14	0.5	PASS
6	2437	15.21	15.75	15.19	15.20	0.5	PASS
11	2462	15.18	15.78	15.73	15.40	0.5	PASS

802.11n (HT40)

Channel	Frequency (MHz)	6dB Bandwidth (MHz)				Minimum Limit (MHz)	Pass / Fail
		Chain 0	Chain 1	Chain 2	Chain 3		
3	2422	36.47	36.57	36.48	36.41	0.5	Pass
6	2437	36.50	36.55	36.47	36.45	0.5	Pass
9	2452	36.15	36.55	36.10	36.46	0.5	Pass

Spectrum Plot of Worst Value

802.11b / Chain 1 : CH11

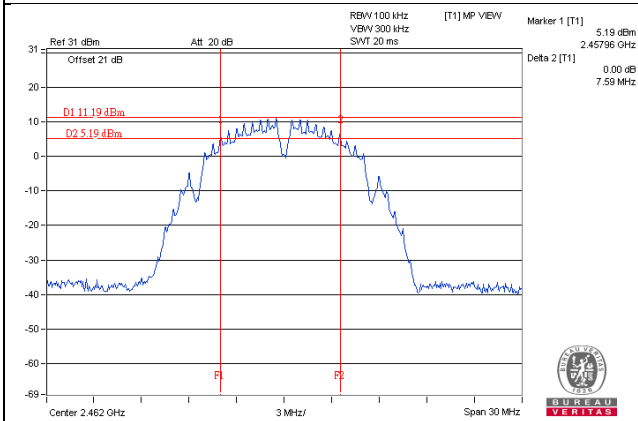

802.11g / Chain 3 : CH6

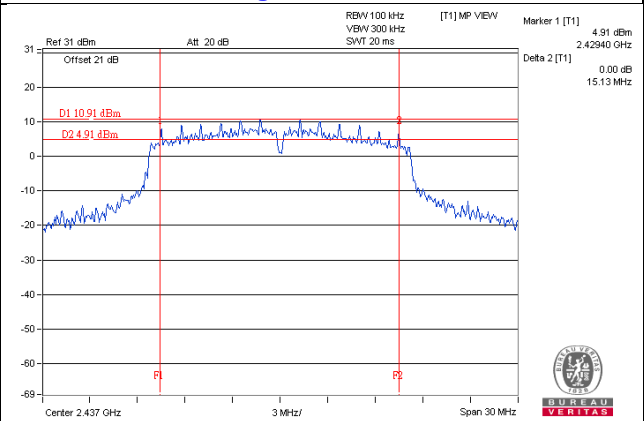

802.11n (HT20) / Chain 0 : CH1

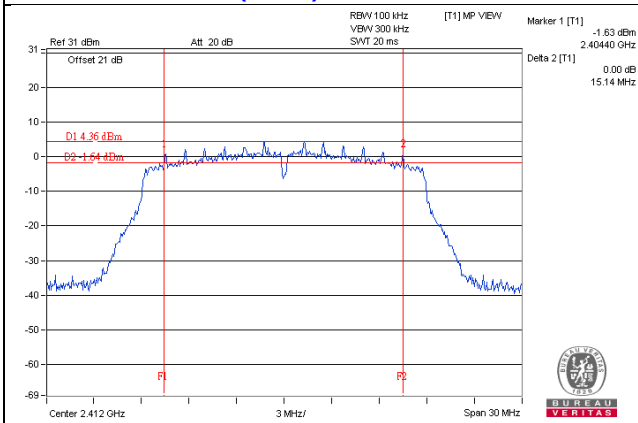

802.11n (HT40) / Chain 2 : CH9

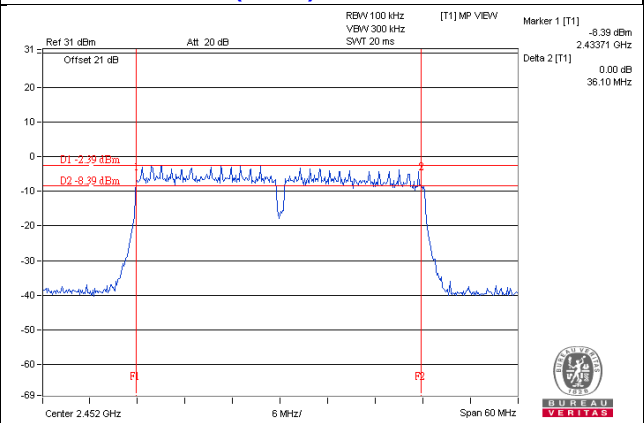

4.3.8 Test Result (Mode 2)

802.11b

Channel	Frequency (MHz)	6dB Bandwidth (MHz)			Minimum Limit (MHz)	Pass / Fail
		Chain 0	Chain 1	Chain 2		
1	2412	7.61	8.10	8.07	0.5	PASS
6	2437	8.08	8.09	8.04	0.5	PASS
11	2462	8.07	8.11	8.08	0.5	PASS

802.11g

Channel	Frequency (MHz)	6dB Bandwidth (MHz)			Minimum Limit (MHz)	Pass / Fail
		Chain 0	Chain 1	Chain 2		
1	2412	15.52	15.18	15.19	0.5	PASS
6	2437	15.21	15.18	15.19	0.5	PASS
11	2462	15.18	15.17	15.17	0.5	PASS

802.11n (HT20)

Channel	Frequency (MHz)	6dB Bandwidth (MHz)			Minimum Limit (MHz)	Pass / Fail
		Chain 0	Chain 1	Chain 2		
1	2412	15.16	16.36	15.75	0.5	Pass
6	2437	15.20	15.22	15.20	0.5	Pass
11	2462	15.52	15.79	15.76	0.5	Pass

802.11n (HT40)

Channel	Frequency (MHz)	6dB Bandwidth (MHz)			Minimum Limit (MHz)	Pass / Fail
		Chain 0	Chain 1	Chain 2		
3	2422	36.50	36.54	36.54	0.5	Pass
6	2437	36.43	36.55	36.52	0.5	Pass
9	2452	36.44	36.46	36.43	0.5	Pass

Spectrum Plot of Worst Value

802.11b / Chain 0 : CH1

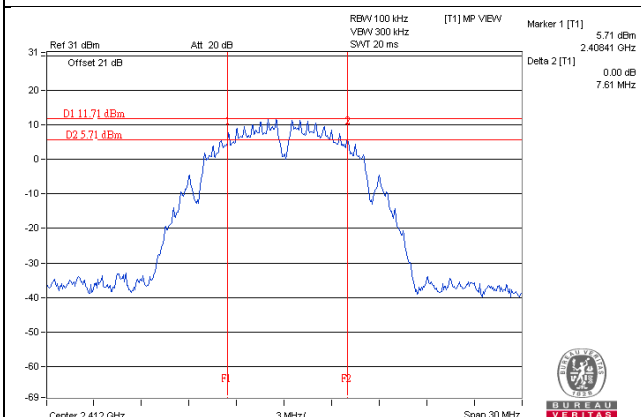

802.11g / Chain 1 : CH1

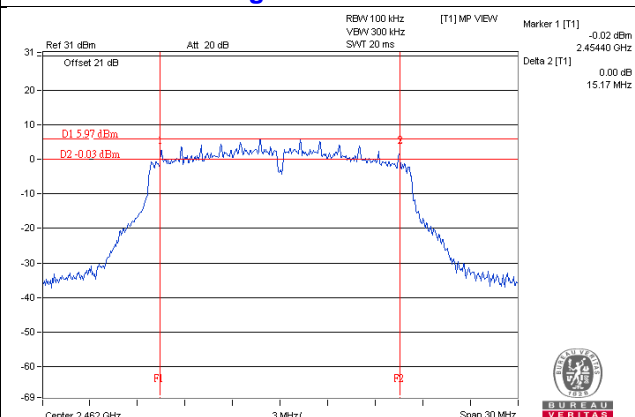

802.11n (HT20) / Chain 0 : CH1

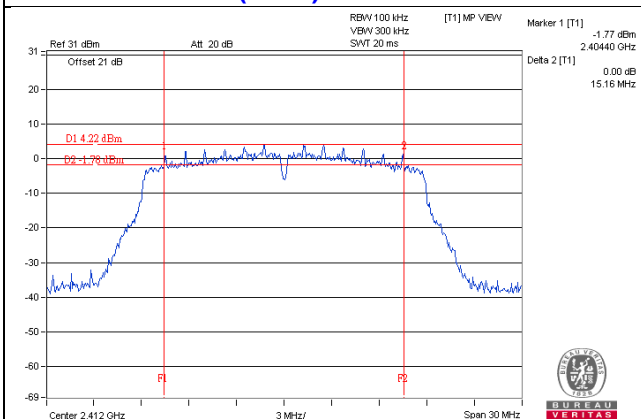

802.11n (HT40) / Chain 0 : CH6

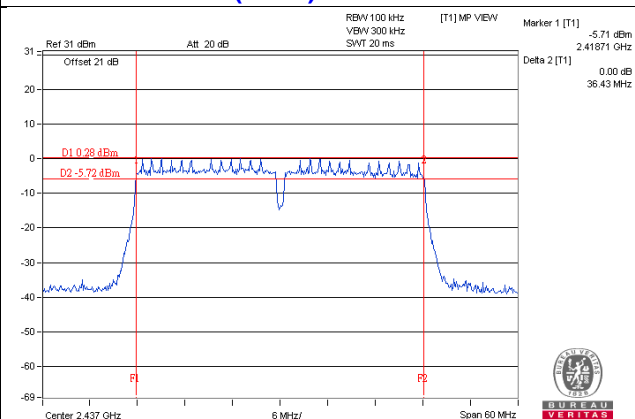

4.3.9 Test Result (Mode 3)

802.11b

Channel	Frequency (MHz)	6dB Bandwidth (MHz)		Minimum Limit (MHz)	Pass / Fail
		Chain 1	Chain 2		
1	2412	8.06	8.08	0.5	PASS
6	2437	8.07	8.08	0.5	PASS
11	2462	7.60	8.07	0.5	PASS

802.11g

Channel	Frequency (MHz)	6dB Bandwidth (MHz)		Minimum Limit (MHz)	Pass / Fail
		Chain 1	Chain 2		
1	2412	15.19	15.18	0.5	PASS
6	2437	15.17	15.17	0.5	PASS
11	2462	15.19	15.17	0.5	PASS

802.11n (HT20)

Channel	Frequency (MHz)	6dB Bandwidth (MHz)		Minimum Limit (MHz)	Pass / Fail
		Chain 1	Chain 2		
1	2412	15.19	15.76	0.5	Pass
6	2437	15.18	15.77	0.5	Pass
11	2462	15.15	15.75	0.5	Pass

802.11n (HT40)

Channel	Frequency (MHz)	6dB Bandwidth (MHz)		Minimum Limit (MHz)	Pass / Fail
		Chain 1	Chain 2		
3	2422	36.50	36.45	0.5	Pass
6	2437	36.52	36.46	0.5	Pass
9	2452	36.21	36.50	0.5	Pass

Spectrum Plot of Worst Value

802.11b / Chain 1 : CH11

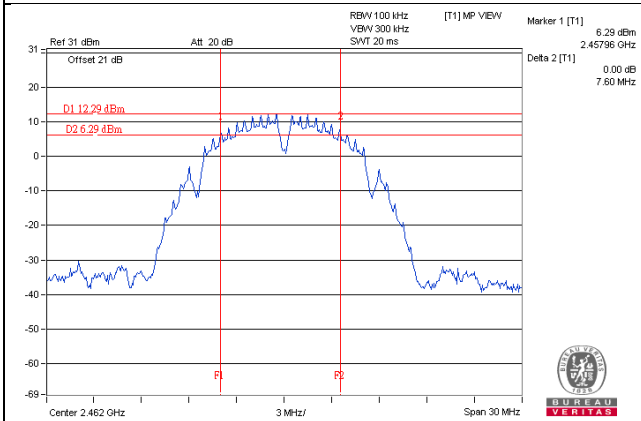

802.11g / Chain 1 : CH6

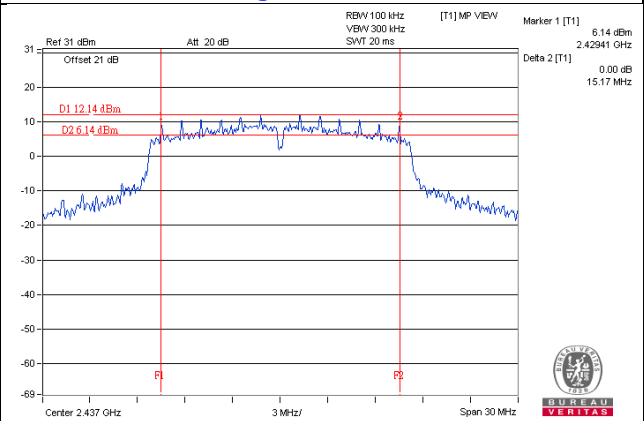

802.11n (HT20) / Chain 1 : CH11

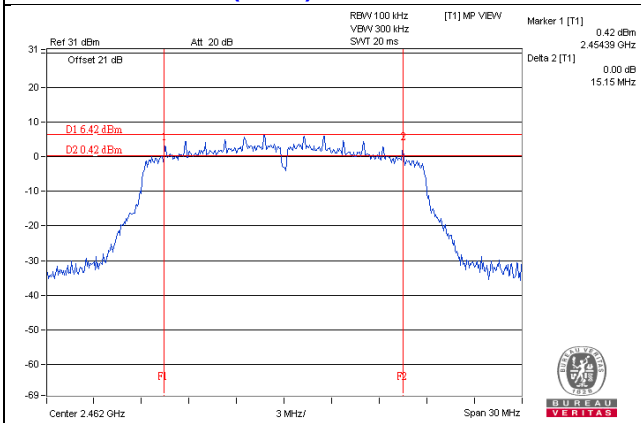

802.11n (HT40) / Chain 1 : CH9

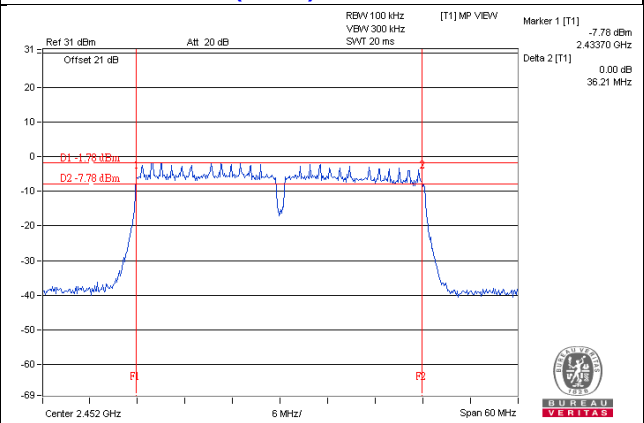

4.3.10 Test Result (Mode 4)

802.11b

Channel	Frequency (MHz)	6dB Bandwidth (MHz)	Minimum Limit (MHz)	Pass / Fail
1	2412	7.58	0.5	PASS
6	2437	8.08	0.5	PASS
11	2462	8.08	0.5	PASS

802.11g

Channel	Frequency (MHz)	6dB Bandwidth (MHz)	Minimum Limit (MHz)	Pass / Fail
1	2412	15.18	0.5	PASS
6	2437	15.17	0.5	PASS
11	2462	15.16	0.5	PASS

802.11n (HT20)

Channel	Frequency (MHz)	6dB Bandwidth (MHz)	Minimum Limit (MHz)	Pass / Fail
1	2412	15.19	0.5	PASS
6	2437	15.18	0.5	PASS
11	2462	15.50	0.5	PASS

802.11n (HT40)

Channel	Frequency (MHz)	6dB Bandwidth (MHz)	Minimum Limit (MHz)	Pass / Fail
3	2422	36.51	0.5	Pass
6	2437	36.51	0.5	Pass
9	2452	36.22	0.5	Pass

Spectrum Plot of Worst Value

802.11b : CH1

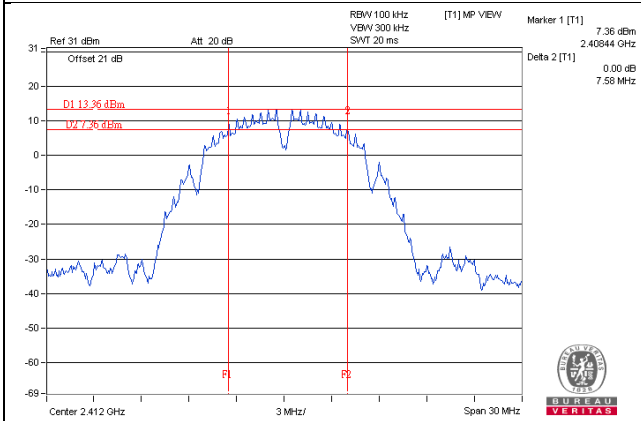

802.11g : CH11

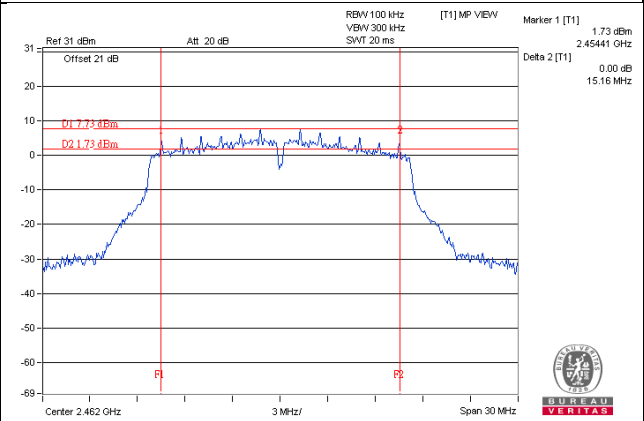

802.11n (HT20) : CH6

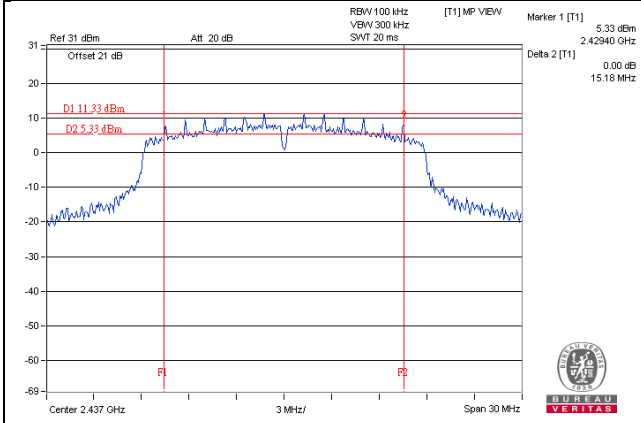

802.11n (HT40) : CH9

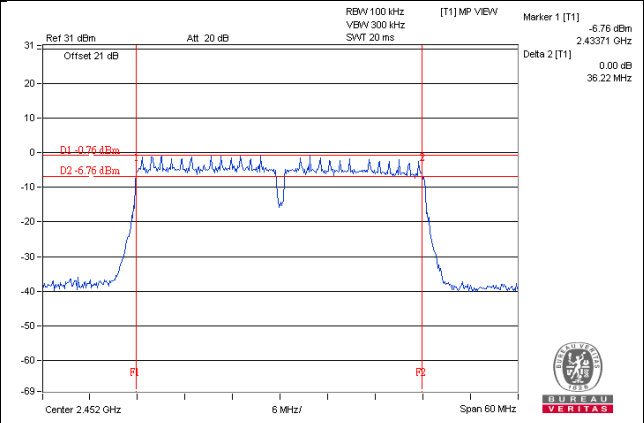

4.4 Conducted Output Power Measurement

4.4.1 Limits of Conducted Output Power Measurement

For systems using digital modulation in the 2400–2483.5 MHz bands: 1 Watt (30dBm)

Per KDB 662911 D01 Multiple Transmitter Output Method of conducted output power measurement on IEEE 802.11 devices,

Array Gain = 0 dB (i.e., no array gain) for $N_{ANT} \leq 4$;

Array Gain = 0 dB (i.e., no array gain) for channel widths ≥ 40 MHz for any N_{ANT} ;

Array Gain = $5 \log(N_{ANT}/N_{SS})$ dB or 3 dB, whichever is less for 20-MHz channel widths with $N_{ANT} \geq 5$.

For power measurements on all other devices: Array Gain = $10 \log(N_{ANT}/N_{SS})$ dB.

4.4.2 Test Setup

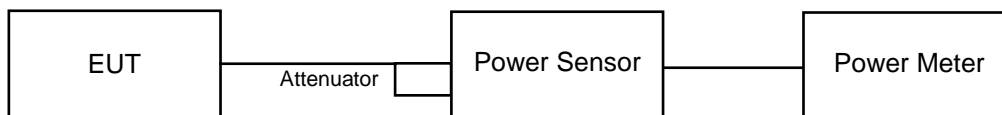

4.4.3 Test Instruments

Refer to section 4.1.2 to get information of above instrument.

4.4.4 Test Procedures

An average power sensor was used on the output port of the EUT. A power meter was used to read the response of the average power sensor. Record the power level.

4.4.5 Deviation from Test Standard

No deviation.

4.4.6 EUT Operating Conditions

Same as Item 4.3.6.

4.4.7 Test Results (Mode 1)

CDD Mode

802.11b

Chan.	Chan. Freq. (MHz)	Average Power (dBm)				Total Power (mW)	Total Power (dBm)	Limit (dBm)	Pass / Fail
		Chain 0	Chain 1	Chain 2	Chain 3				
1	2412	18.79	19.11	19.39	19.46	332.357	25.22	30.00	Pass
6	2437	21.63	21.84	22.49	21.93	631.677	28.00	30.00	Pass
11	2462	18.51	18.94	19.22	18.94	311.204	24.93	30.00	Pass

802.11g

Chan.	Chan. Freq. (MHz)	Average Power (dBm)				Total Power (mW)	Total Power (dBm)	Limit (dBm)	Pass / Fail
		Chain 0	Chain 1	Chain 2	Chain 3				
1	2412	14.73	15.31	15.53	14.83	129.816	21.13	30.00	Pass
6	2437	21.50	22.04	22.44	21.17	607.516	27.84	30.00	Pass
11	2462	15.37	15.92	16.72	15.64	157.152	21.96	30.00	Pass

Beamforming Mode

802.11n (HT20)

Chan.	Chan. Freq. (MHz)	Average Power (dBm)				Total Power (mW)	Total Power (dBm)	Limit (dBm)	Pass / Fail
		Chain 0	Chain 1	Chain 2	Chain 3				
1	2412	14.67	15.16	15.72	14.66	128.686	21.10	26.10	Pass
6	2437	19.42	19.87	20.36	19.78	388.252	25.89	26.10	Pass
11	2462	15.17	15.61	16.06	15.18	142.603	21.54	26.10	Pass

Note: Directional gain = $10 \log[(10^{G0/20} + 10^{G1/20} + 10^{G2/20} + 10^{G3/20})^2 / 4] = 9.9\text{dBi} > 6\text{dBi}$, so the power limit shall be reduced to $30 - (9.9 - 6) = 26.10\text{dBm}$.

802.11n (HT40)

Chan.	Chan. Freq. (MHz)	Average Power (dBm)				Total Power (mW)	Total Power (dBm)	Limit (dBm)	Pass / Fail
		Chain 0	Chain 1	Chain 2	Chain 3				
3	2422	10.63	11.58	11.88	10.72	53.169	17.26	26.10	Pass
6	2437	13.62	14.32	14.79	13.99	105.245	20.22	26.10	Pass
9	2452	10.48	11.29	11.64	10.89	51.49	17.12	26.10	Pass

Note: Directional gain = $10 \log[(10^{G0/20} + 10^{G1/20} + 10^{G2/20} + 10^{G3/20})^2 / 4] = 9.9\text{dBi} > 6\text{dBi}$, so the power limit shall be reduced to $30 - (9.9 - 6) = 26.10\text{dBm}$.

4.4.8 Test Results (Mode 2)

CDD Mode
802.11b

Chan.	Chan. Freq. (MHz)	Average Power (dBm)			Total Power (mW)	Total Power (dBm)	Limit (dBm)	Pass / Fail
		Chain 0	Chain 1	Chain 2				
1	2412	19.29	19.61	19.89	273.828	24.37	30.00	Pass
6	2437	21.63	21.84	22.49	475.722	26.77	30.00	Pass
11	2462	19.01	19.44	19.72	261.274	24.17	30.00	Pass

802.11g

Chan.	Chan. Freq. (MHz)	Average Power (dBm)			Total Power (mW)	Total Power (dBm)	Limit (dBm)	Pass / Fail
		Chain 0	Chain 1	Chain 2				
1	2412	14.98	15.56	15.78	105.296	20.22	30.00	Pass
6	2437	21.50	22.04	22.44	476.598	26.78	30.00	Pass
11	2462	15.62	16.17	16.97	127.649	21.06	30.00	Pass

Beamforming Mode
802.11n (HT20)

Chan.	Chan. Freq. (MHz)	Average Power (dBm)			Total Power (mW)	Total Power (dBm)	Limit (dBm)	Pass / Fail
		Chain 0	Chain 1	Chain 2				
1	2412	14.92	15.41	15.97	105.337	20.23	27.33	Pass
6	2437	21.42	21.87	22.36	464.678	26.67	27.33	Pass
11	2462	15.42	15.86	16.31	116.138	20.65	27.33	Pass

Note: Directional gain = $10 \log[(10^{G0/20} + 10^{G1/20} + 10^{G2/20})^2 / 3]$ = 8.67dBi > 6dBi, so the power limit shall be reduced to 30-(8.67-6) = 27.33dBm.

802.11n (HT40)

Chan.	Chan. Freq. (MHz)	Average Power (dBm)			Total Power (mW)	Total Power (dBm)	Limit (dBm)	Pass / Fail
		Chain 0	Chain 1	Chain 2				
3	2422	11.13	12.08	11.22	42.359	16.27	27.33	Pass
6	2437	14.12	14.82	15.29	89.968	19.54	27.33	Pass
9	2452	10.98	11.79	11.39	41.404	16.17	27.33	Pass

Note: Directional gain = $10 \log[(10^{G0/20} + 10^{G1/20} + 10^{G2/20})^2 / 3]$ = 8.67dBi > 6dBi, so the power limit shall be reduced to 30-(8.67-6) = 27.33dBm.

4.4.9 Test Results (Mode 3)

CDD Mode
802.11b

Chan.	Freq. (MHz)	Average Power (dBm)		Total Power (mW)	Total Power (dBm)	Limit (dBm)	Pass / Fail
		Chain 1	Chain 2				
1	2412	20.39	20.46	220.569	23.44	30.00	Pass
6	2437	22.49	21.93	333.374	25.23	30.00	Pass
11	2462	20.22	19.94	203.824	23.09	30.00	Pass

802.11g

Chan.	Freq. (MHz)	Average Power (dBm)		Total Power (mW)	Total Power (dBm)	Limit (dBm)	Pass / Fail
		Chain 1	Chain 2				
1	2412	16.28	15.58	78.603	18.95	30.00	Pass
6	2437	22.44	21.17	306.306	24.86	30.00	Pass
11	2462	17.47	16.39	99.398	19.97	30.00	Pass

Beamforming Mode
802.11n (HT20)

Chan.	Freq. (MHz)	Average Power (dBm)		Total Power (mW)	Total Power (dBm)	Limit (dBm)	Pass / Fail
		Chain 1	Chain 2				
1	2412	16.47	15.41	79.115	18.98	29.07	Pass
6	2437	22.86	22.28	362.241	25.59	29.07	Pass
11	2462	16.81	15.93	87.147	19.40	29.07	Pass

Note: Directional gain = $10 \log[(10^{G1/20} + 10^{G2/20})^2 / 2]$ = 6.93dBi > 6dBi , so the power limit shall be reduced to $30-(6.93-6) = 29.07$ dBm.

802.11n (HT40)

Chan.	Freq. (MHz)	Average Power (dBm)		Total Power (mW)	Total Power (dBm)	Limit (dBm)	Pass / Fail
		Chain 1	Chain 2				
3	2422	12.63	11.47	32.351	15.10	29.07	Pass
6	2437	16.04	15.24	73.599	18.67	29.07	Pass
9	2452	12.39	11.64	31.926	15.04	29.07	Pass

Note: Directional gain = $10 \log[(10^{G1/20} + 10^{G2/20})^2 / 2]$ = 6.93dBi > 6dBi , so the power limit shall be reduced to $30-(6.93-6) = 29.07$ dBm.

4.4.10 Test Results (Mode 4)

CDD Mode

802.11b

Channel	Frequency (MHz)	Average Power (mW)	Average Power (dBm)	Limit (dBm)	Pass/Fail
1	2412	130.017	21.14	30.00	Pass
6	2437	210.863	23.24	30.00	Pass
11	2462	125.603	20.99	30.00	Pass

802.11g

Channel	Frequency (MHz)	Average Power (mW)	Average Power (dBm)	Limit (dBm)	Pass/Fail
1	2412	50.466	17.03	30.00	Pass
6	2437	175.388	22.44	30.00	Pass
11	2462	62.661	17.97	30.00	Pass

802.11n (HT20)

Channel	Frequency (MHz)	Average Power (mW)	Average Power (dBm)	Limit (dBm)	Pass/Fail
1	2412	52.723	17.22	30.00	Pass
6	2437	153.815	21.87	30.00	Pass
11	2462	57.016	17.56	30.00	Pass

802.11n (HT40)

Channel	Frequency (MHz)	Average Power (mW)	Average Power (dBm)	Limit (dBm)	Pass/Fail
3	2422	23.067	13.63	30.00	Pass
6	2437	50.582	17.04	30.00	Pass
9	2452	21.827	13.39	30.00	Pass

4.5 Power Spectral Density Measurement

4.5.1 Limits of Power Spectral Density Measurement

The Maximum of Power Spectral Density Measurement is 8dBm.

4.5.2 Test Setup

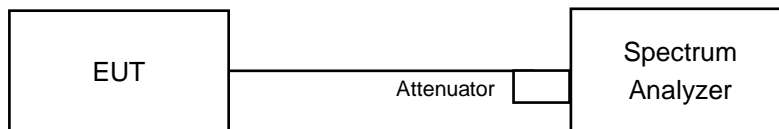

4.5.3 Test Instruments

Refer to section 4.1.2 to get information of above instrument.

4.5.4 Test Procedure

- a) Set instrument center frequency to DTS channel center frequency.
- b) Set span to at least 1.5 times the OBW.
- c) Set RBW to: $3 \text{ kHz} \leq \text{RBW} \leq 100 \text{ kHz}$.
- d) Set VBW $\geq 3 \times \text{RBW}$.
- e) Detector = power averaging (RMS) or sample detector (when RMS not available).
- f) Ensure that the number of measurement points in the sweep $\geq 2 \times \text{span}/\text{RBW}$.
- g) Sweep time = auto couple.
- h) Employ trace averaging (RMS) mode over a minimum of 100 traces.
- i) Use the peak marker function to determine the maximum amplitude level.

4.5.5 Deviation from Test Standard

No deviation.

4.5.6 EUT Operating Condition

Same as Item 4.3.6

4.5.7 Test Results (Mode 1)

802.11b

TX chain	Channel	Freq. (MHz)	PSD (dBm/3kHz)	10 log (N=4) dB	Total PSD (dBm/3kHz)	Limit (dBm/3kHz)	Pass /Fail
0	1	2412	-10.40	6.02	-4.38	4.10	Pass
	6	2437	-8.88	6.02	-2.86	4.10	Pass
	11	2462	-11.80	6.02	-5.78	4.10	Pass
1	1	2412	-10.94	6.02	-4.92	4.10	Pass
	6	2437	-8.33	6.02	-2.31	4.10	Pass
	11	2462	-12.14	6.02	-6.12	4.10	Pass
2	1	2412	-11.71	6.02	-5.69	4.10	Pass
	6	2437	-8.23	6.02	-2.21	4.10	Pass
	11	2462	-11.24	6.02	-5.22	4.10	Pass
3	1	2412	-11.08	6.02	-5.06	4.10	Pass
	6	2437	-9.08	6.02	-3.06	4.10	Pass
	11	2462	-11.75	6.02	-5.73	4.10	Pass

Note: 1. Directional gain = $10 \log[(10^{G0/20} + 10^{G1/20} + 10^{G2/20} + 10^{G3/20})^2 / 4] = 9.9\text{dBi} > 6\text{dBi}$, so the power density limit shall be reduced to $8-(9.9-6) = 4.1\text{dBm}$.

802.11g

TX chain	Channel	Freq. (MHz)	PSD (dBm/3kHz)	10 log (N=4) dB	Total PSD (dBm/3kHz)	Limit (dBm/3kHz)	Pass /Fail
0	1	2412	-15.29	6.02	-9.27	4.10	Pass
	6	2437	-9.01	6.02	-2.99	4.10	Pass
	11	2462	-15.44	6.02	-9.42	4.10	Pass
1	1	2412	-15.72	6.02	-9.70	4.10	Pass
	6	2437	-8.81	6.02	-2.79	4.10	Pass
	11	2462	-14.71	6.02	-8.69	4.10	Pass
2	1	2412	-16.05	6.02	-10.03	4.10	Pass
	6	2437	-7.88	6.02	-1.86	4.10	Pass
	11	2462	-13.65	6.02	-7.63	4.10	Pass
3	1	2412	-16.68	6.02	-10.66	4.10	Pass
	6	2437	-9.75	6.02	-3.73	4.10	Pass
	11	2462	-14.59	6.02	-8.57	4.10	Pass

Note: 1. Directional gain = $10 \log[(10^{G0/20} + 10^{G1/20} + 10^{G2/20} + 10^{G3/20})^2 / 4] = 9.9\text{dBi} > 6\text{dBi}$, so the power density limit shall be reduced to $8-(9.9-6) = 4.1\text{dBm}$.

802.11n (HT20)

TX chain	Channel	Freq. (MHz)	PSD (dBm/3kHz)	10 log (N=4) dB	Total PSD (dBm/3kHz)	Limit (dBm/3kHz)	Pass /Fail
0	1	2412	-16.85	6.02	-10.83	4.10	Pass
	6	2437	-10.16	6.02	-4.14	4.10	Pass
	11	2462	-15.81	6.02	-9.79	4.10	Pass
1	1	2412	-17.24	6.02	-11.22	4.10	Pass
	6	2437	-11.23	6.02	-5.21	4.10	Pass
	11	2462	-16.55	6.02	-10.53	4.10	Pass
2	1	2412	-16.16	6.02	-10.14	4.10	Pass
	6	2437	-10.67	6.02	-4.65	4.10	Pass
	11	2462	-16.20	6.02	-10.18	4.10	Pass
3	1	2412	-16.96	6.02	-10.94	4.10	Pass
	6	2437	-11.08	6.02	-5.06	4.10	Pass
	11	2462	-16.33	6.02	-10.31	4.10	Pass

Note: 1. Directional gain = $10 \log[(10^{G0/20} + 10^{G1/20} + 10^{G2/20} + 10^{G3/20})^2 / 4] = 9.9\text{dBi} > 6\text{dBi}$, so the power density limit shall be reduced to $8-(9.9-6) = 4.1\text{dBm}$.

802.11n (HT40)

TX chain	Channel	Freq. (MHz)	PSD (dBm/3kHz)	10 log (N=4) dB	Total PSD (dBm/3kHz)	Limit (dBm/3kHz)	Pass /Fail
0	3	2422	-25.17	6.02	-19.15	4.10	Pass
	6	2437	-20.46	6.02	-14.44	4.10	Pass
	9	2452	-24.97	6.02	-18.95	4.10	Pass
1	3	2422	-24.08	6.02	-18.06	4.10	Pass
	6	2437	-20.04	6.02	-14.02	4.10	Pass
	9	2452	-23.91	6.02	-17.89	4.10	Pass
2	3	2422	-23.67	6.02	-17.65	4.10	Pass
	6	2437	-20.06	6.02	-14.04	4.10	Pass
	9	2452	-23.68	6.02	-17.66	4.10	Pass
3	3	2422	-24.58	6.02	-18.56	4.10	Pass
	6	2437	-21.41	6.02	-15.39	4.10	Pass
	9	2452	-24.91	6.02	-18.89	4.10	Pass

Note: 1. Directional gain = $10 \log[(10^{G0/20} + 10^{G1/20} + 10^{G2/20} + 10^{G3/20})^2 / 4] = 9.9\text{dBi} > 6\text{dBi}$, so the power density limit shall be reduced to $8-(9.9-6) = 4.1\text{dBm}$.

Spectrum Plot of Worst Value

802.11b / Chain 2 : CH6

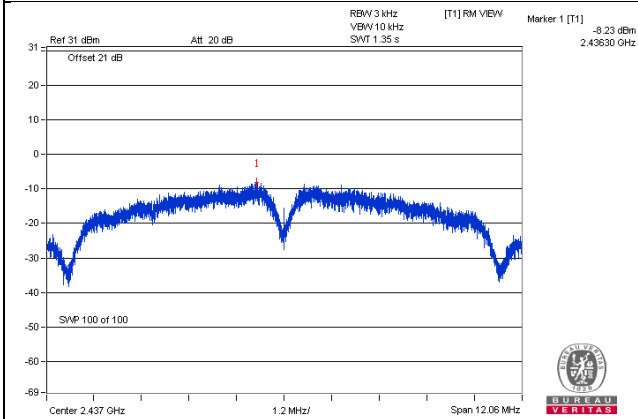

802.11g / Chain 2 : CH6

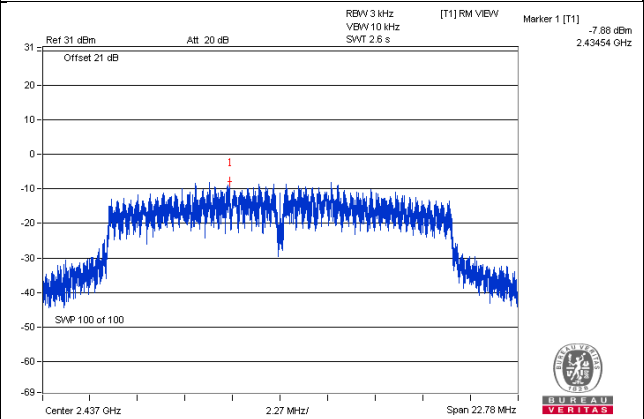

802.11n (HT20) / Chain 0 : CH6

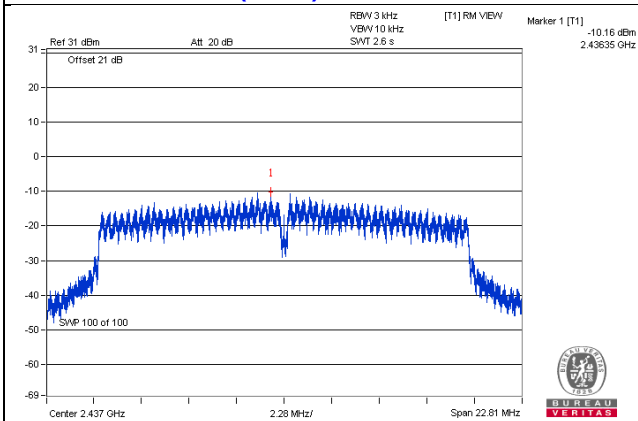

802.11n (HT40) / Chain 1 : CH6

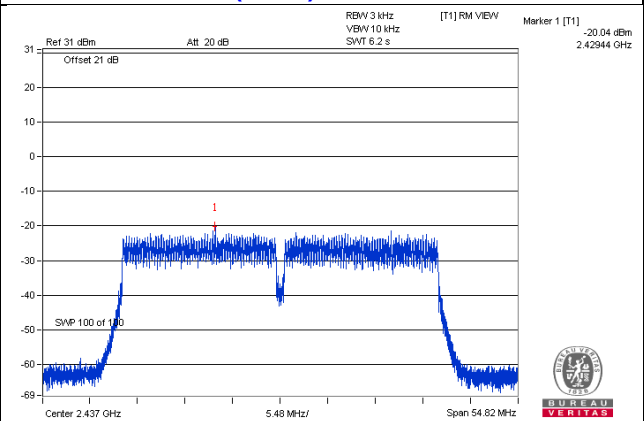

4.5.8 Test Results (Mode 2)

802.11b

TX chain	Channel	Freq. (MHz)	PSD (dBm/3kHz)	10 log (N=3) dB	Total PSD (dBm/3kHz)	Limit (dBm/3kHz)	Pass /Fail
0	1	2412	-10.42	4.77	-5.65	5.33	Pass
	6	2437	-8.88	4.77	-4.11	5.33	Pass
	11	2462	-11.30	4.77	-6.53	5.33	Pass
1	1	2412	-9.80	4.77	-5.03	5.33	Pass
	6	2437	-8.33	4.77	-3.56	5.33	Pass
	11	2462	-11.19	4.77	-6.42	5.33	Pass
2	1	2412	-11.18	4.77	-6.41	5.33	Pass
	6	2437	-8.23	4.77	-3.46	5.33	Pass
	11	2462	-11.13	4.77	-6.36	5.33	Pass

Note: 1. Directional gain = $10 \log[(10^{G0/20} + 10^{G1/20} + 10^{G2/20})^2 / 3]$ = 8.67dBi > 6dBi , so the power density limit shall be reduced to $8-(8.67-6) = 5.33$ dBm.

802.11g

TX chain	Channel	Freq. (MHz)	PSD (dBm/3kHz)	10 log (N=3) dB	Total PSD (dBm/3kHz)	Limit (dBm/3kHz)	Pass /Fail
0	1	2412	-14.67	4.77	-9.90	5.33	Pass
	6	2437	-9.01	4.77	-4.24	5.33	Pass
	11	2462	-14.34	4.77	-9.57	5.33	Pass
1	1	2412	-15.43	4.77	-10.66	5.33	Pass
	6	2437	-8.81	4.77	-4.04	5.33	Pass
	11	2462	-14.87	4.77	-10.10	5.33	Pass
2	1	2412	-13.59	4.77	-8.82	5.33	Pass
	6	2437	-7.88	4.77	-3.11	5.33	Pass
	11	2462	-14.38	4.77	-9.61	5.33	Pass

Note: 1. Directional gain = $10 \log[(10^{G0/20} + 10^{G1/20} + 10^{G2/20})^2 / 3]$ = 8.67dBi > 6dBi , so the power density limit shall be reduced to $8-(8.67-6) = 5.33$ dBm.

802.11n (HT20)

TX chain	Channel	Freq. (MHz)	PSD (dBm/3kHz)	10 log (N=3) dB	Total PSD (dBm/3kHz)	Limit (dBm/3kHz)	Pass /Fail
0	1	2412	-16.59	4.77	-11.82	5.33	Pass
	6	2437	-10.45	4.77	-5.68	5.33	Pass
	11	2462	-16.72	4.77	-11.95	5.33	Pass
1	1	2412	-16.74	4.77	-11.97	5.33	Pass
	6	2437	-10.37	4.77	-5.60	5.33	Pass
	11	2462	-16.20	4.77	-11.43	5.33	Pass
2	1	2412	-16.80	4.77	-12.03	5.33	Pass
	6	2437	-10.26	4.77	-5.49	5.33	Pass
	11	2462	-15.02	4.77	-10.25	5.33	Pass

Note: 1. Directional gain = $10 \log[(10^{G0/20} + 10^{G1/20} + 10^{G2/20})^2 / 3]$ = 8.67dBi > 6dBi , so the power density limit shall be reduced to $8-(8.67-6) = 5.33$ dBm.

802.11n (HT40)

TX chain	Channel	Freq. (MHz)	PSD (dBm/3kHz)	10 log (N=3) dB	Total PSD (dBm/3kHz)	Limit (dBm/3kHz)	Pass /Fail
0	3	2422	-23.67	4.77	-18.90	5.33	Pass
	6	2437	-20.82	4.77	-16.05	5.33	Pass
	9	2452	-24.69	4.77	-19.92	5.33	Pass
1	3	2422	-23.23	4.77	-18.46	5.33	Pass
	6	2437	-20.24	4.77	-15.47	5.33	Pass
	9	2452	-22.84	4.77	-18.07	5.33	Pass
2	3	2422	-23.89	4.77	-19.12	5.33	Pass
	6	2437	-20.58	4.77	-15.81	5.33	Pass
	9	2452	-23.26	4.77	-18.49	5.33	Pass

Note: 1. Directional gain = $10 \log[(10^{G0/20} + 10^{G1/20} + 10^{G2/20})^2 / 3]$ = 8.67dBi > 6dBi , so the power density limit shall be reduced to $8-(8.67-6) = 5.33$ dBm.

Spectrum Plot of Worst Value

802.11b / Chain 2 : CH6

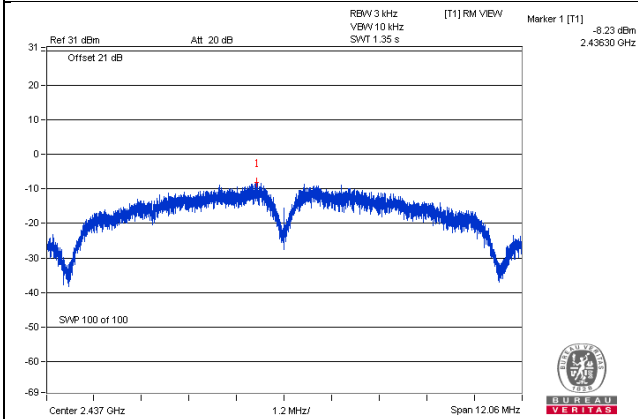

802.11g / Chain 2 : CH6

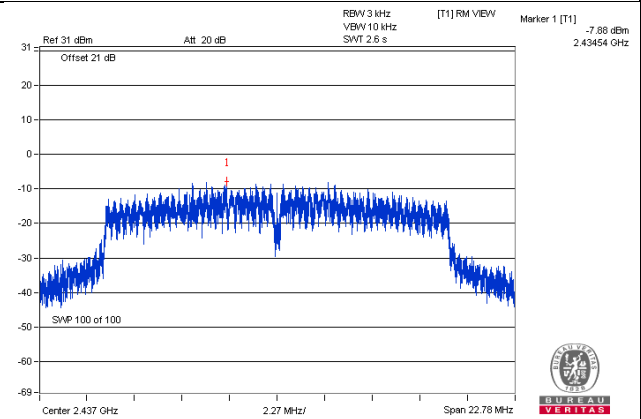

802.11n (HT20) / Chain 2 : CH6

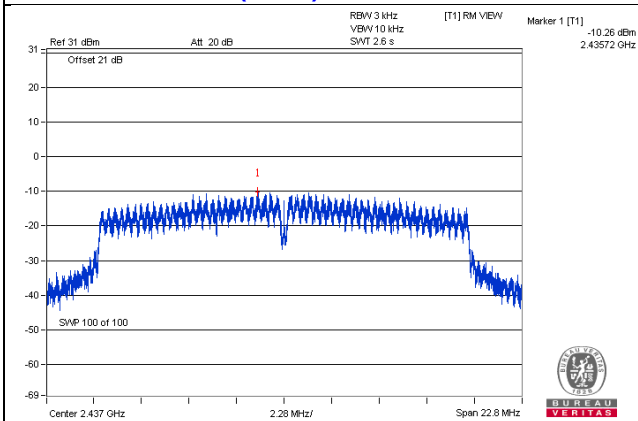

802.11n (HT40) / Chain 1 : CH6

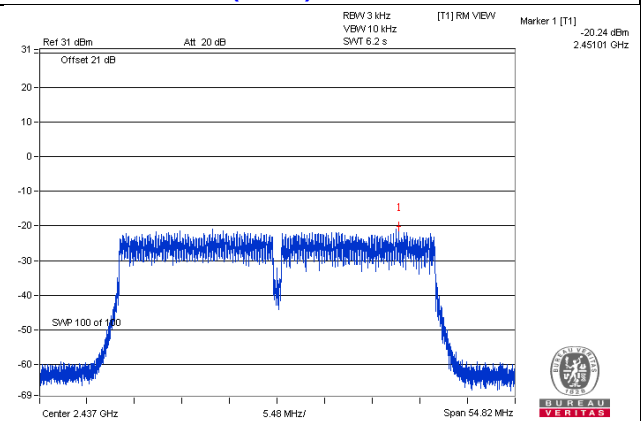

4.5.9 Test Results (Mode 3)

802.11b

TX chain	Channel	Freq. (MHz)	PSD (dBm/3kHz)	10 log (N=2) dB	Total PSD (dBm/3kHz)	Limit (dBm/3kHz)	Pass /Fail
1	1	2412	-10.38	3.01	-7.37	7.07	Pass
	6	2437	-8.11	3.01	-5.10	7.07	Pass
	11	2462	-9.74	3.01	-6.73	7.07	Pass
2	1	2412	-9.20	3.01	-6.19	7.07	Pass
	6	2437	-8.72	3.01	-5.71	7.07	Pass
	11	2462	-10.57	3.01	-7.56	7.07	Pass

Note: 1. Directional gain = $10 \log[(10^{G1/20} + 10^{G2/20})^2 / 2] = 6.93\text{dBi} > 6\text{dBi}$, so the power density limit shall be reduced to $8-(6.93-6) = 7.07\text{dBm}$.

802.11g

TX chain	Channel	Freq. (MHz)	PSD (dBm/3kHz)	10 log (N=2) dB	Total PSD (dBm/3kHz)	Limit (dBm/3kHz)	Pass /Fail
1	1	2412	-13.52	3.01	-10.51	7.07	Pass
	6	2437	-8.03	3.01	-5.02	7.07	Pass
	11	2462	-13.07	3.01	-10.06	7.07	Pass
2	1	2412	-14.26	3.01	-11.25	7.07	Pass
	6	2437	-9.59	3.01	-6.58	7.07	Pass
	11	2462	-13.98	3.01	-10.97	7.07	Pass

Note: 1. Directional gain = $10 \log[(10^{G1/20} + 10^{G2/20})^2 / 2] = 6.93\text{dBi} > 6\text{dBi}$, so the power density limit shall be reduced to $8-(6.93-6) = 7.07\text{dBm}$.

802.11n (HT20)

TX chain	Channel	Freq. (MHz)	PSD (dBm/3kHz)	10 log (N=2) dB	Total PSD (dBm/3kHz)	Limit (dBm/3kHz)	Pass /Fail
1	1	2412	-16.15	3.01	-13.14	7.07	Pass
	6	2437	-9.54	3.01	-6.53	7.07	Pass
	11	2462	-15.18	3.01	-12.17	7.07	Pass
2	1	2412	-17.32	3.01	-14.31	7.07	Pass
	6	2437	-10.21	3.01	-7.20	7.07	Pass
	11	2462	-16.44	3.01	-13.43	7.07	Pass

Note: 1. Directional gain = $10 \log[(10^{G1/20} + 10^{G2/20})^2 / 2] = 6.93\text{dBi} > 6\text{dBi}$, so the power density limit shall be reduced to $8-(6.93-6) = 7.07\text{dBm}$.

802.11n (HT40)

TX chain	Channel	Freq. (MHz)	PSD (dBm/3kHz)	10 log (N=2) dB	Total PSD (dBm/3kHz)	Limit (dBm/3kHz)	Pass /Fail
1	3	2422	-22.42	3.01	-19.41	7.07	Pass
	6	2437	-20.09	3.01	-17.08	7.07	Pass
	9	2452	-22.48	3.01	-19.47	7.07	Pass
2	3	2422	-22.95	3.01	-19.94	7.07	Pass
	6	2437	-20.60	3.01	-17.59	7.07	Pass
	9	2452	-23.66	3.01	-20.65	7.07	Pass

Note: 1. Directional gain = $10 \log[(10^{G1/20} + 10^{G2/20})^2 / 2] = 6.93\text{dBi} > 6\text{dBi}$, so the power density limit shall be reduced to $8-(6.93-6) = 7.07\text{dBm}$.

Spectrum Plot of Worst Value

802.11b / Chain 1 : CH6

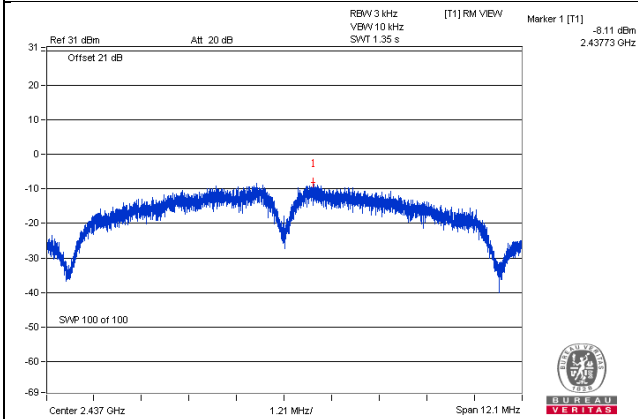

802.11g / Chain 1 : CH6

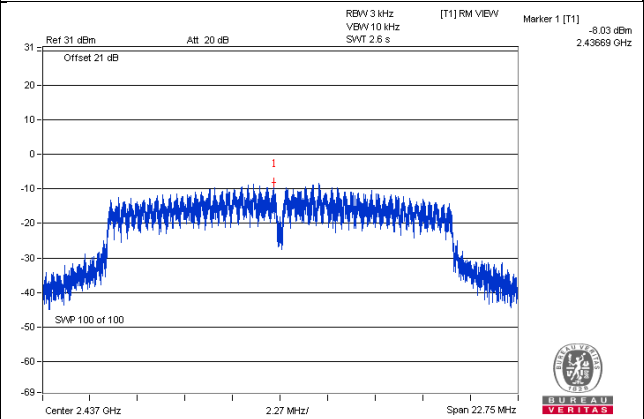

802.11n (HT20) / Chain 1 : CH6

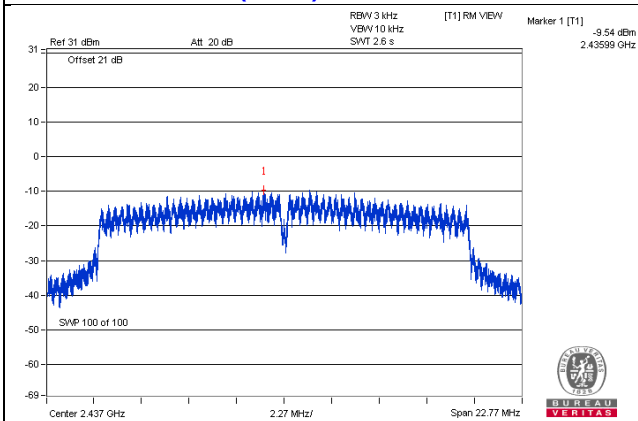

802.11n (HT40) / Chain 1 : CH6

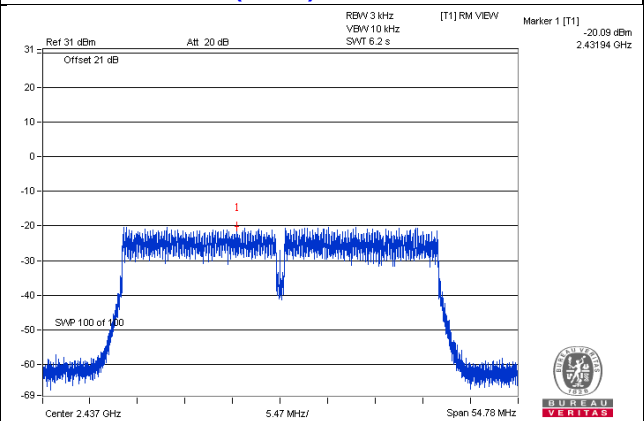

4.5.10 Test Results (Mode 4)

802.11b

Channel	Freq. (MHz)	PSD (dBm/3kHz)	Limit (dBm/3kHz)	Pass /Fail
1	2412	-9.51	8	Pass
6	2437	-7.77	8	Pass
11	2462	-9.39	8	Pass

802.11g

Channel	Freq. (MHz)	PSD (dBm/3kHz)	Limit (dBm/3kHz)	Pass /Fail
1	2412	-12.20	8	Pass
6	2437	-8.69	8	Pass
11	2462	-12.33	8	Pass

802.11n (HT20)

Channel	Freq. (MHz)	PSD (dBm/3kHz)	Limit (dBm/3kHz)	Pass /Fail
1	2412	-15.48	8.00	Pass
6	2437	-10.42	8.00	Pass
11	2462	-14.18	8.00	Pass

802.11n (HT40)

Channel	Freq. (MHz)	PSD (dBm/3kHz)	Limit (dBm/3kHz)	Pass /Fail
3	2422	-21.92	8.00	Pass
6	2437	-18.17	8.00	Pass
9	2452	-22.32	8.00	Pass

Spectrum Plot of Worst Value

802.11b : CH6

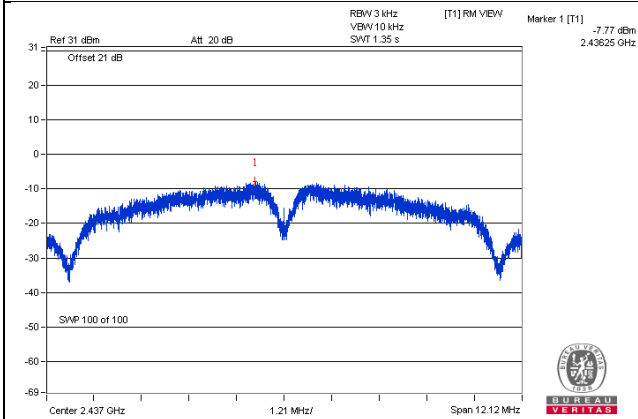

802.11g : CH6

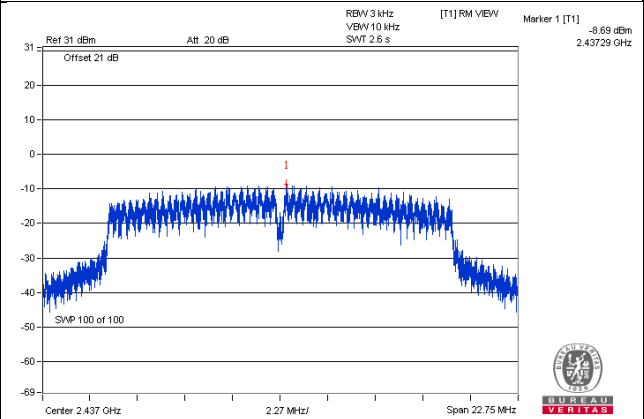

802.11n (HT20) : CH6

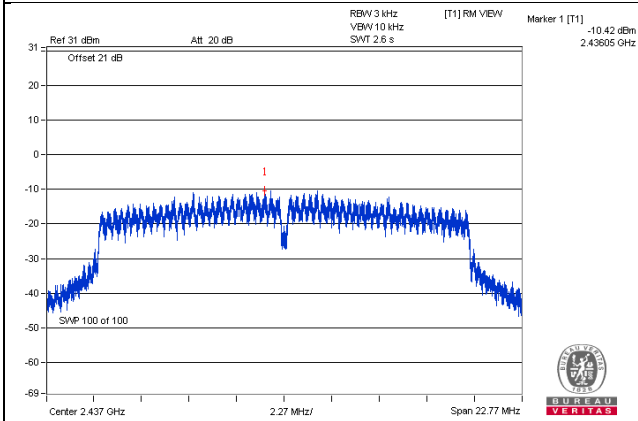

802.11n (HT40) : CH6

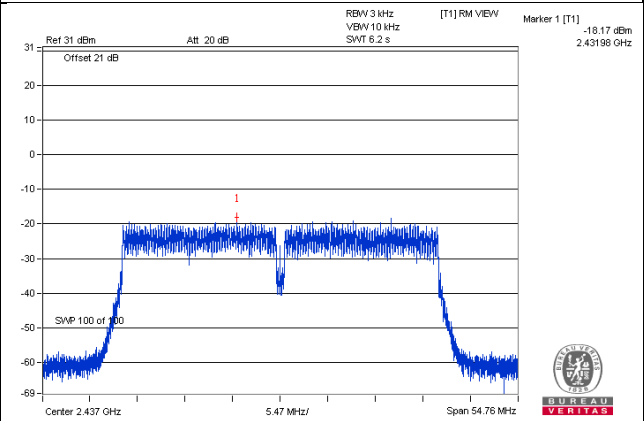

4.6 Conducted Out of Band Emission Measurement

4.6.1 Limits of Conducted Out of Band Emission Measurement

Below 30dB of the highest emission level of operating band (in 100kHz Resolution Bandwidth).

4.6.2 Test Setup

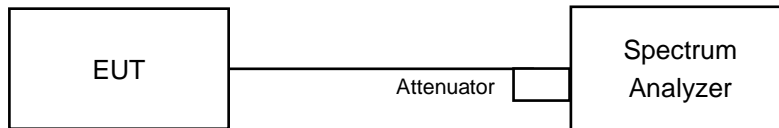

4.6.3 Test Instruments

Refer to section 4.1.2 to get information of above instrument.

4.6.4 Test Procedure

MEASUREMENT PROCEDURE REF

1. Set the RBW = 100 kHz.
2. Set the VBW \geq 300 kHz.
3. Detector = peak.
4. Sweep time = auto couple.
5. Trace mode = max hold.
6. Allow trace to fully stabilize.
7. Use the peak marker function to determine the maximum power level in any 100 kHz band segment within the fundamental EBW.

MEASUREMENT PROCEDURE OOBE

1. Set RBW = 100 kHz.
2. Set VBW \geq 300 kHz.
3. Detector = peak.
4. Sweep = auto couple.
5. Trace Mode = max hold.
6. Allow trace to fully stabilize.
7. Use the peak marker function to determine the maximum amplitude level.

4.6.5 Deviation from Test Standard

No deviation.

4.6.6 EUT Operating Condition

Same as Item 4.3.6

4.6.7 Test Results

The spectrum plots are attached on the following pages. D1 line indicates the highest level, and D2 line indicates the 30dB offset below D1. It shows compliance with the requirement.

4TX Mode
802.11b

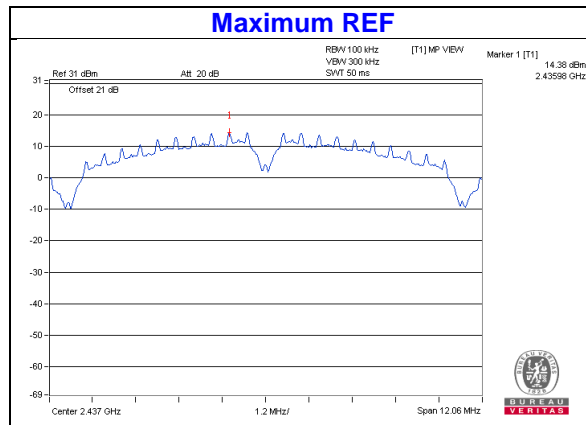

Chain 0

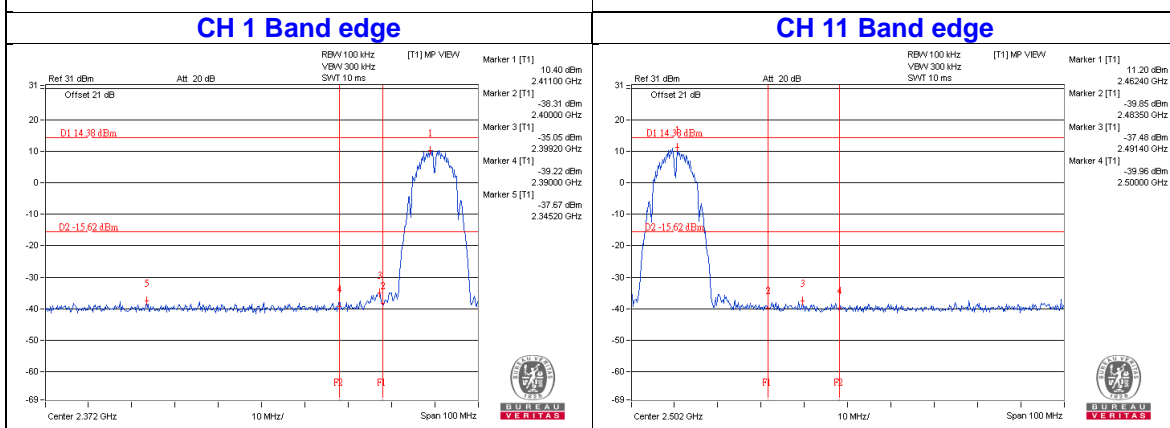
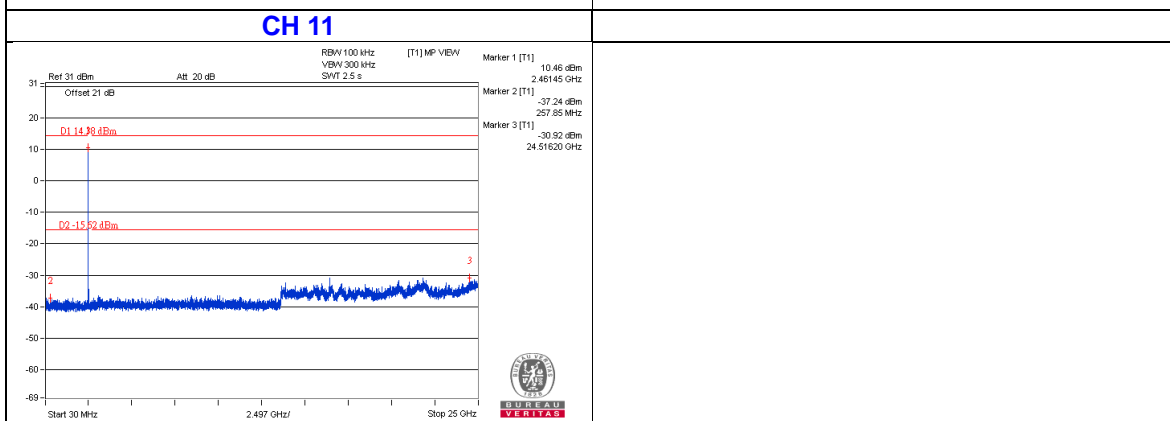
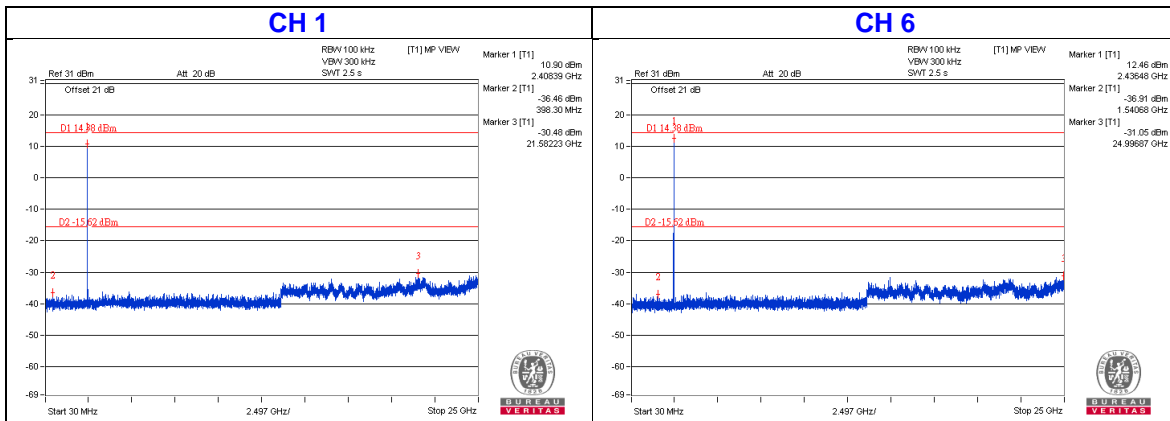

Chain 1

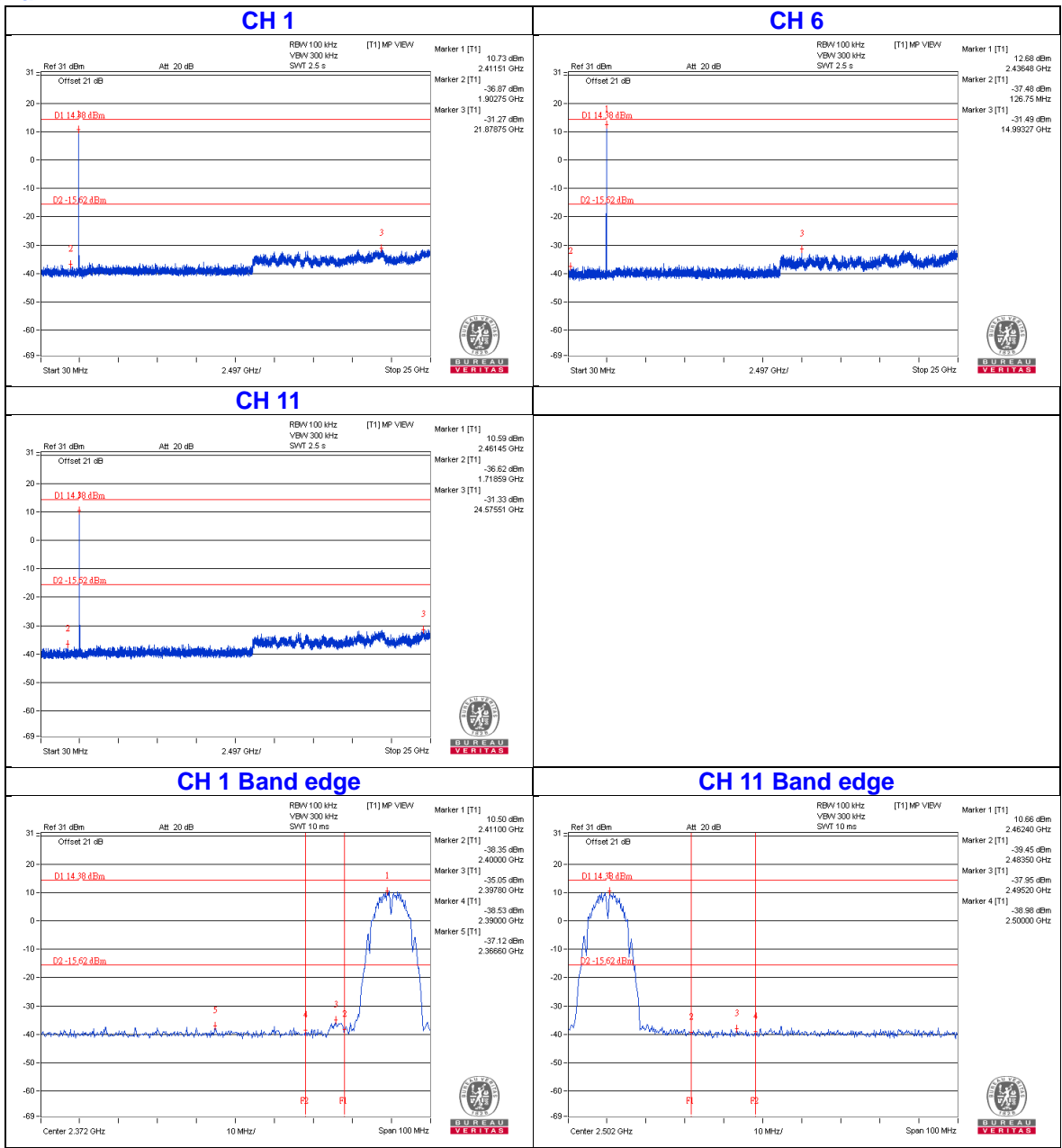

Chain 2

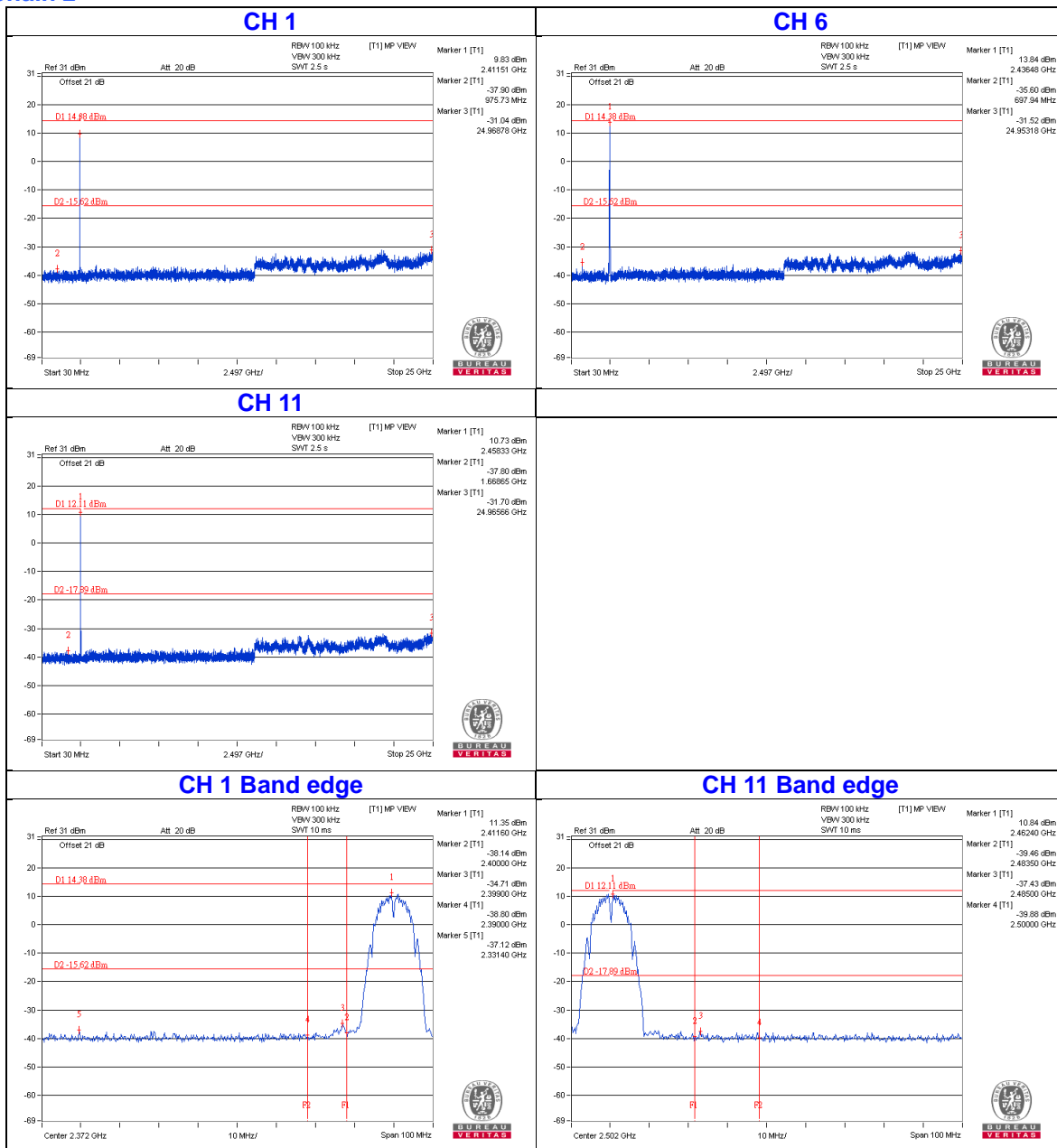

Chain 3

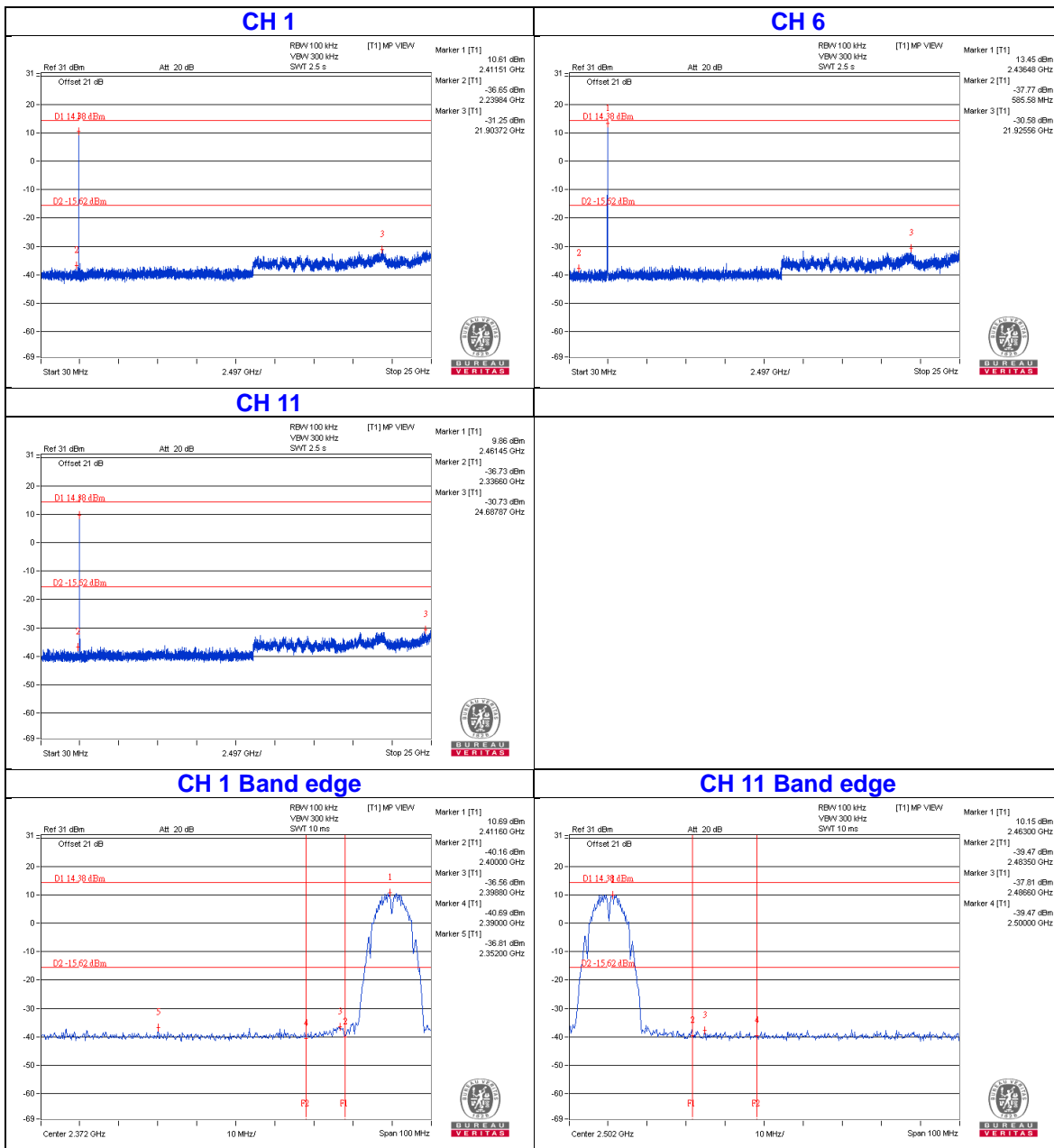

802.11g

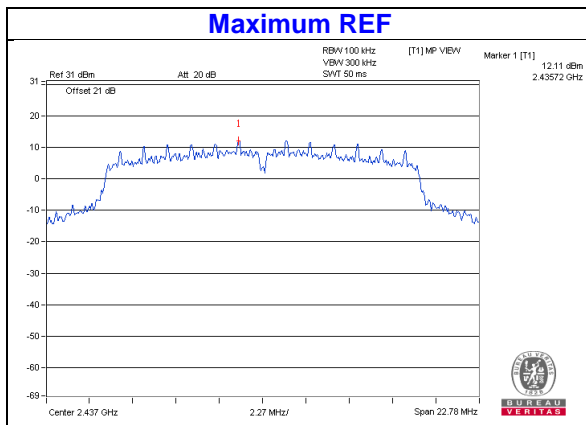

Chain 0

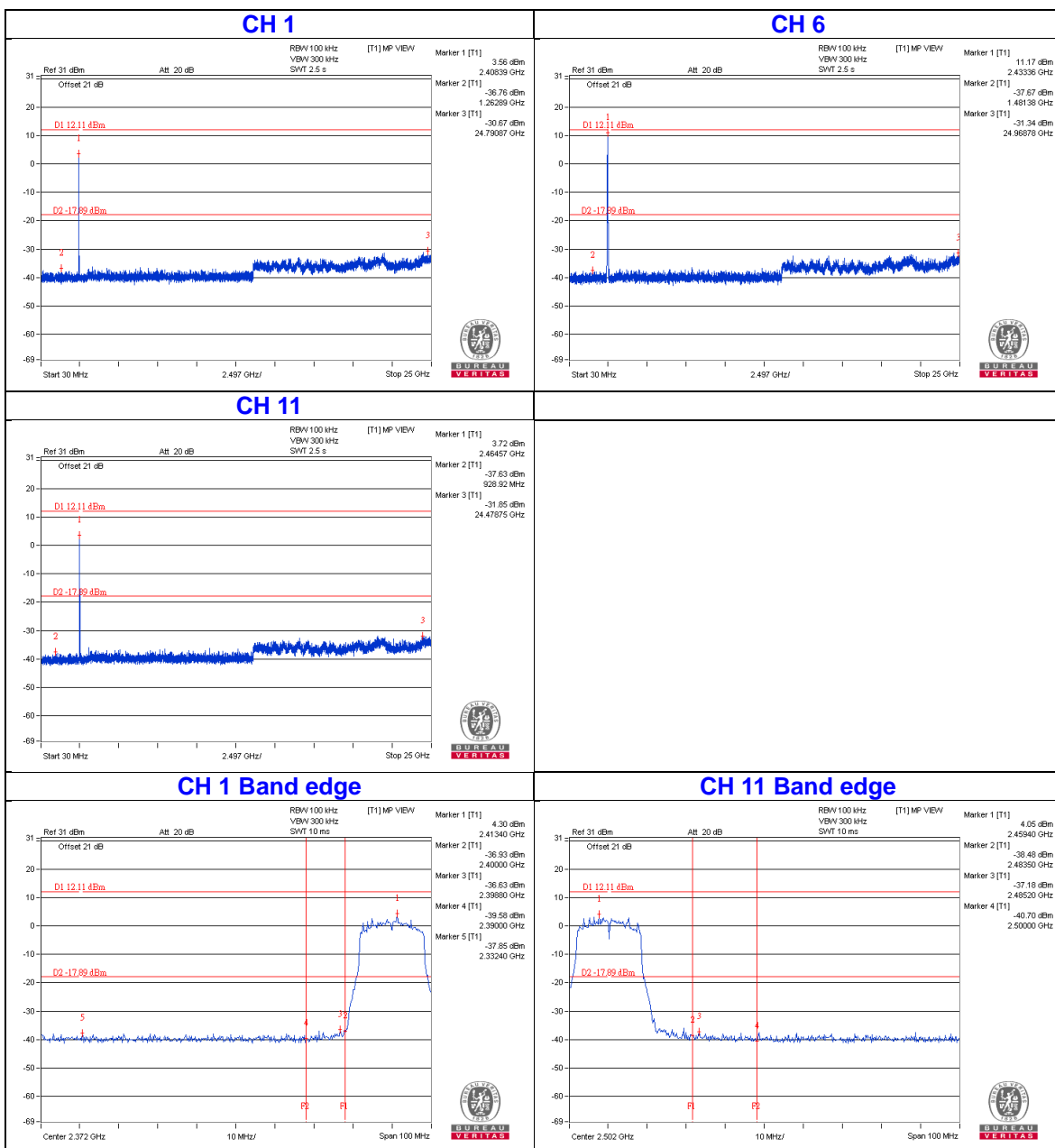

Chain 1

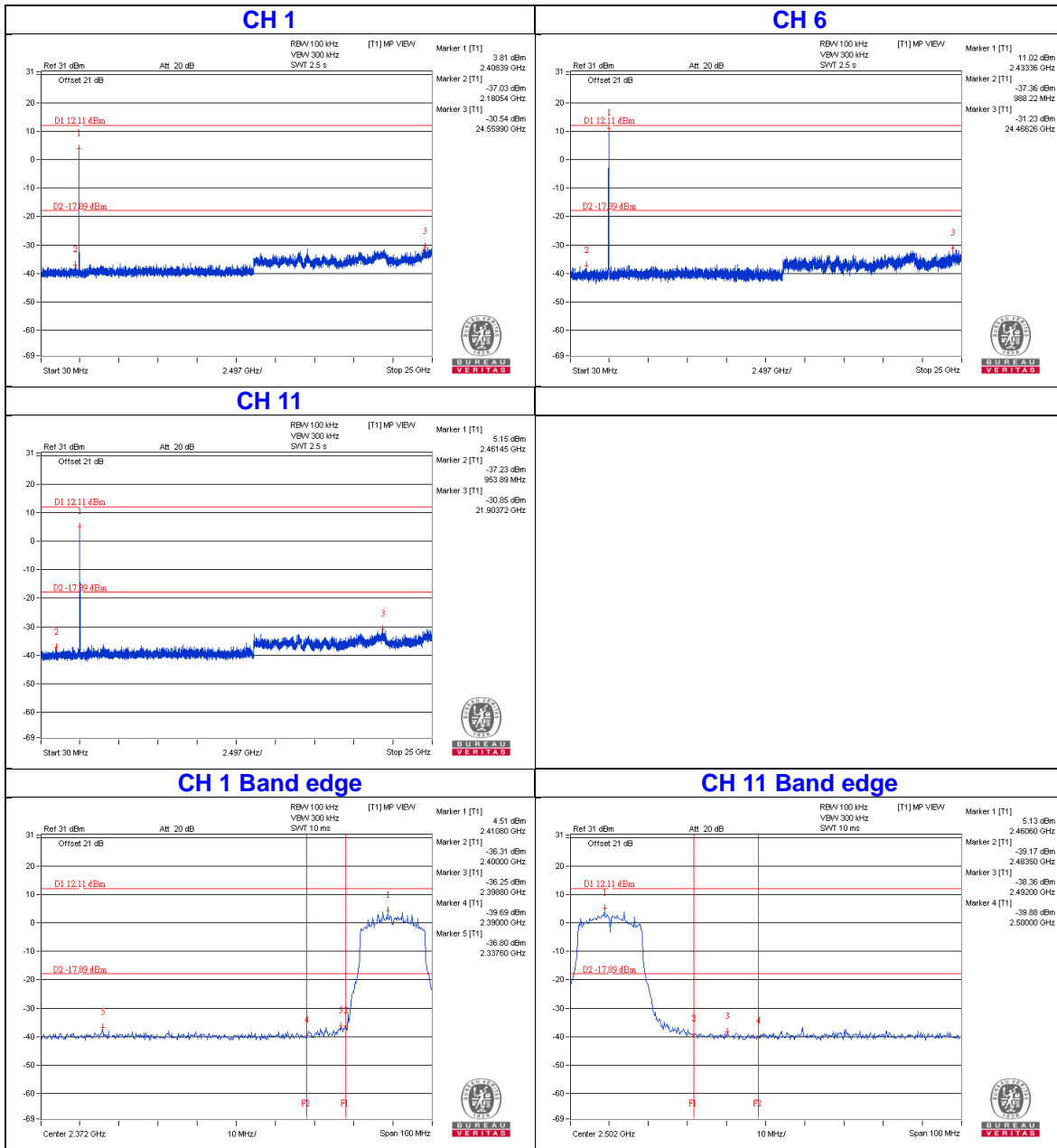

Chain 2

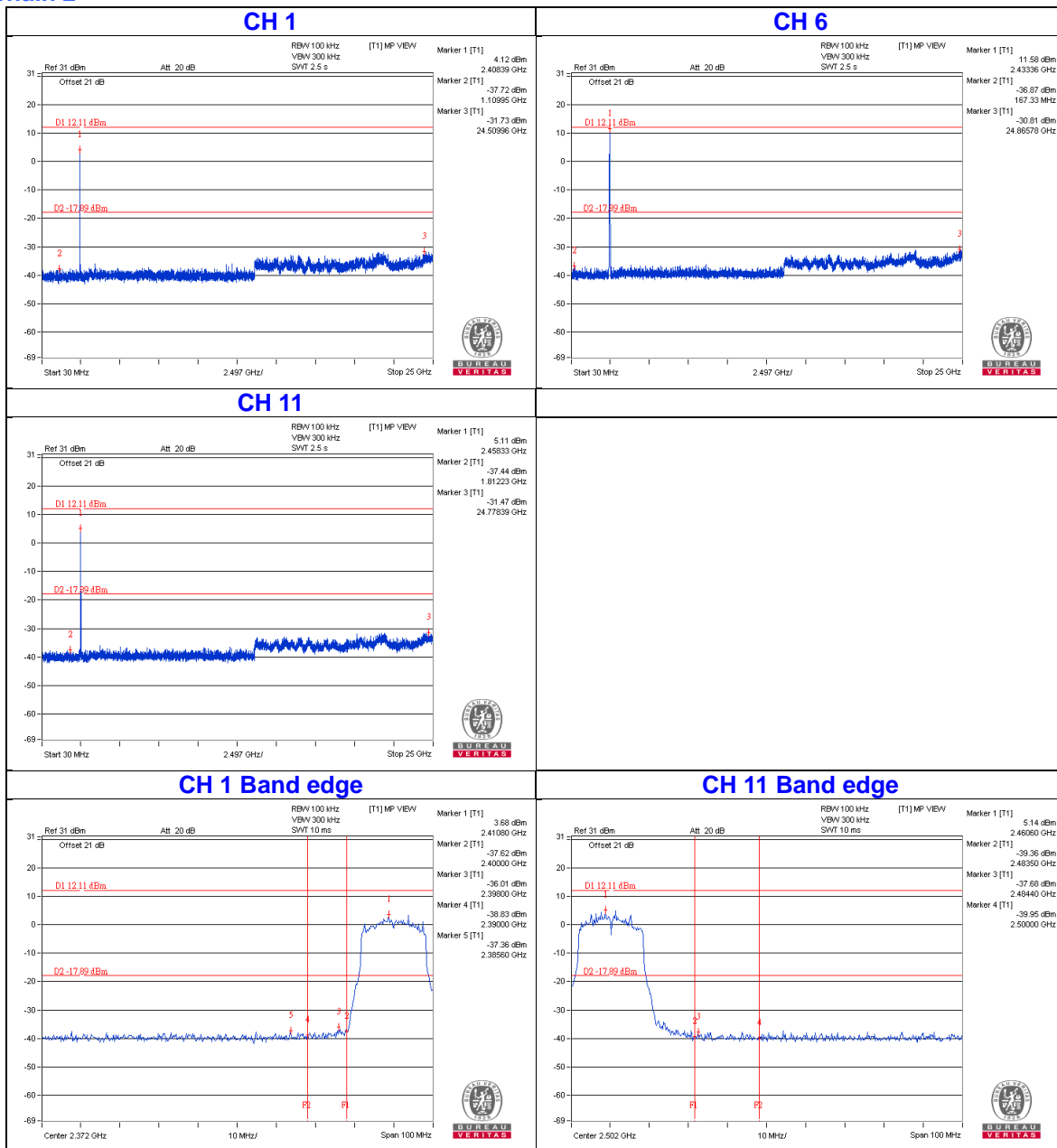

Chain 3

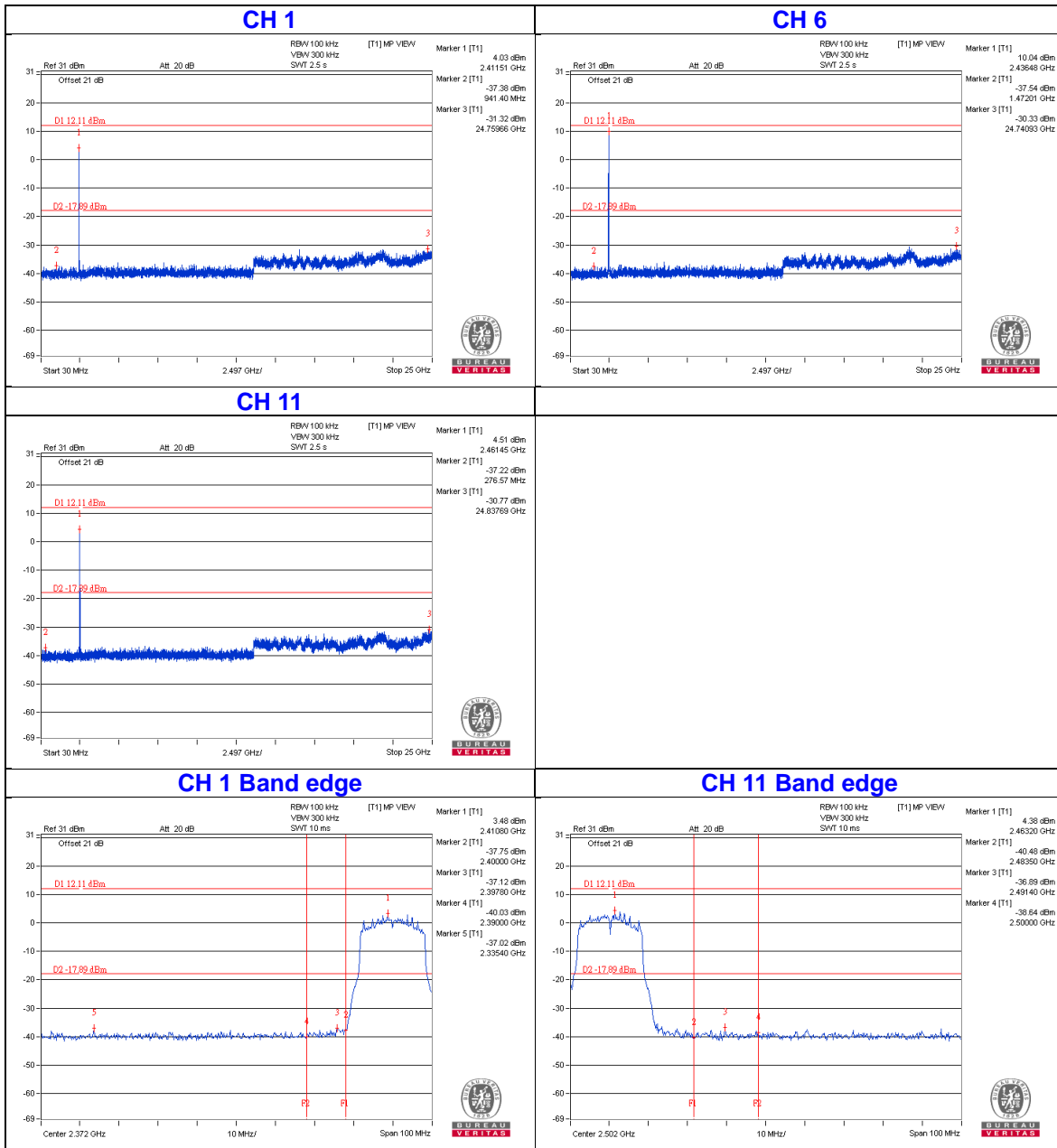

802.11n (HT20)

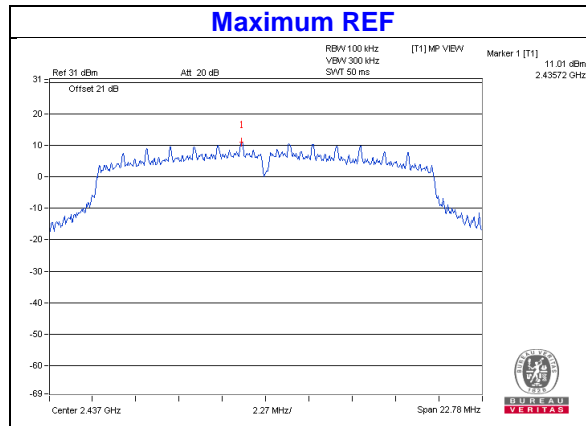

Chain 0

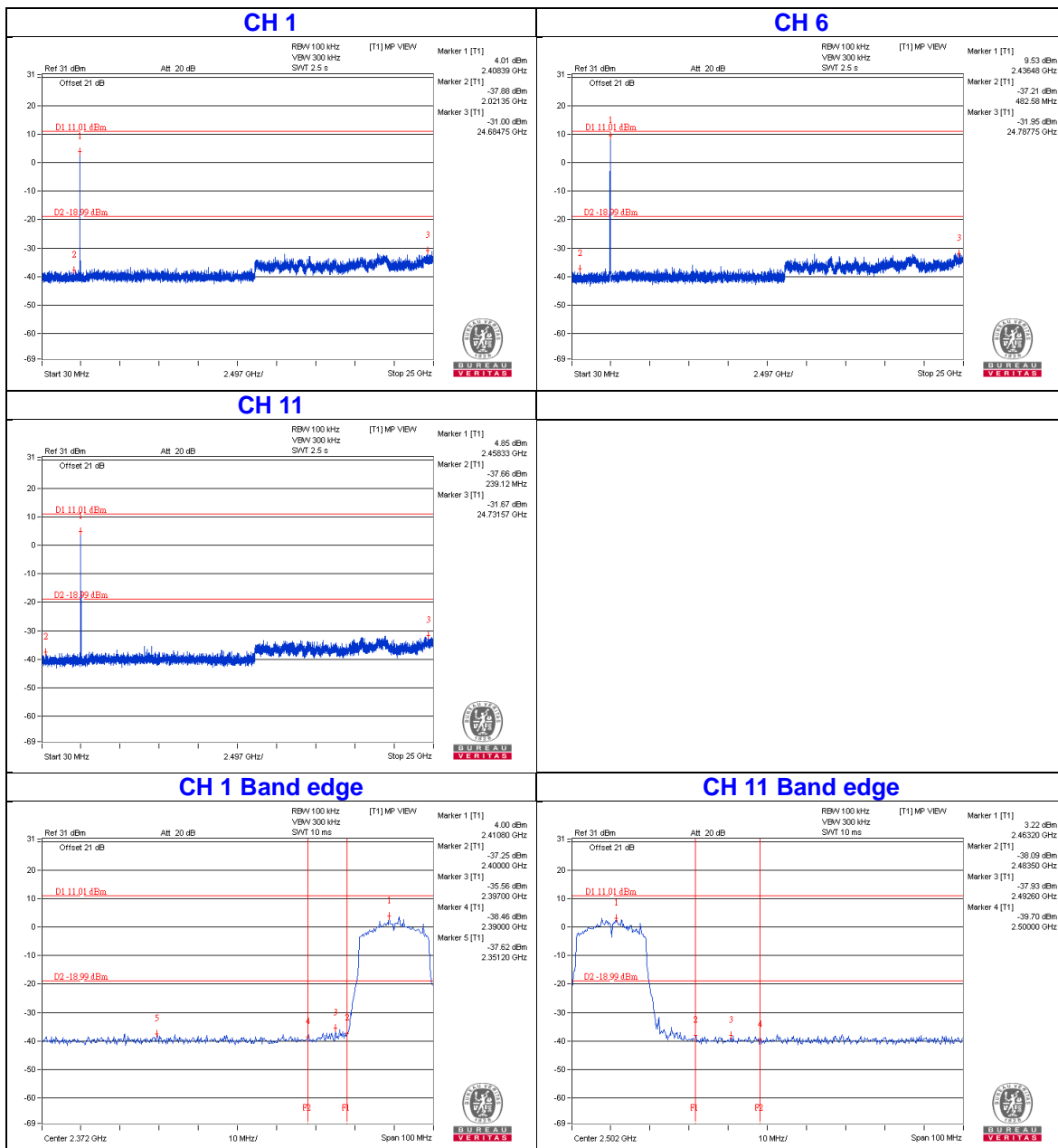

Chain 1

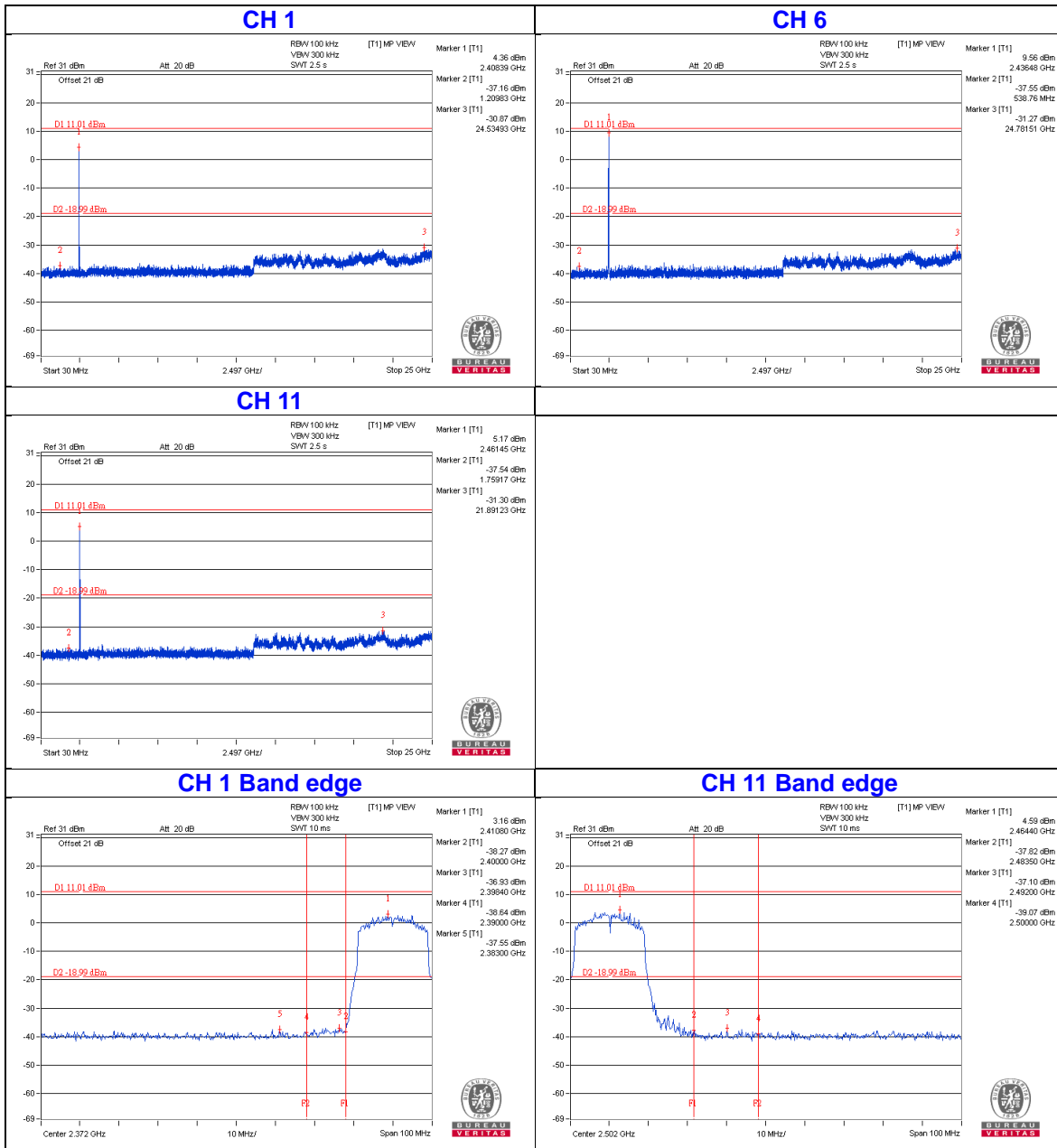

Chain 2

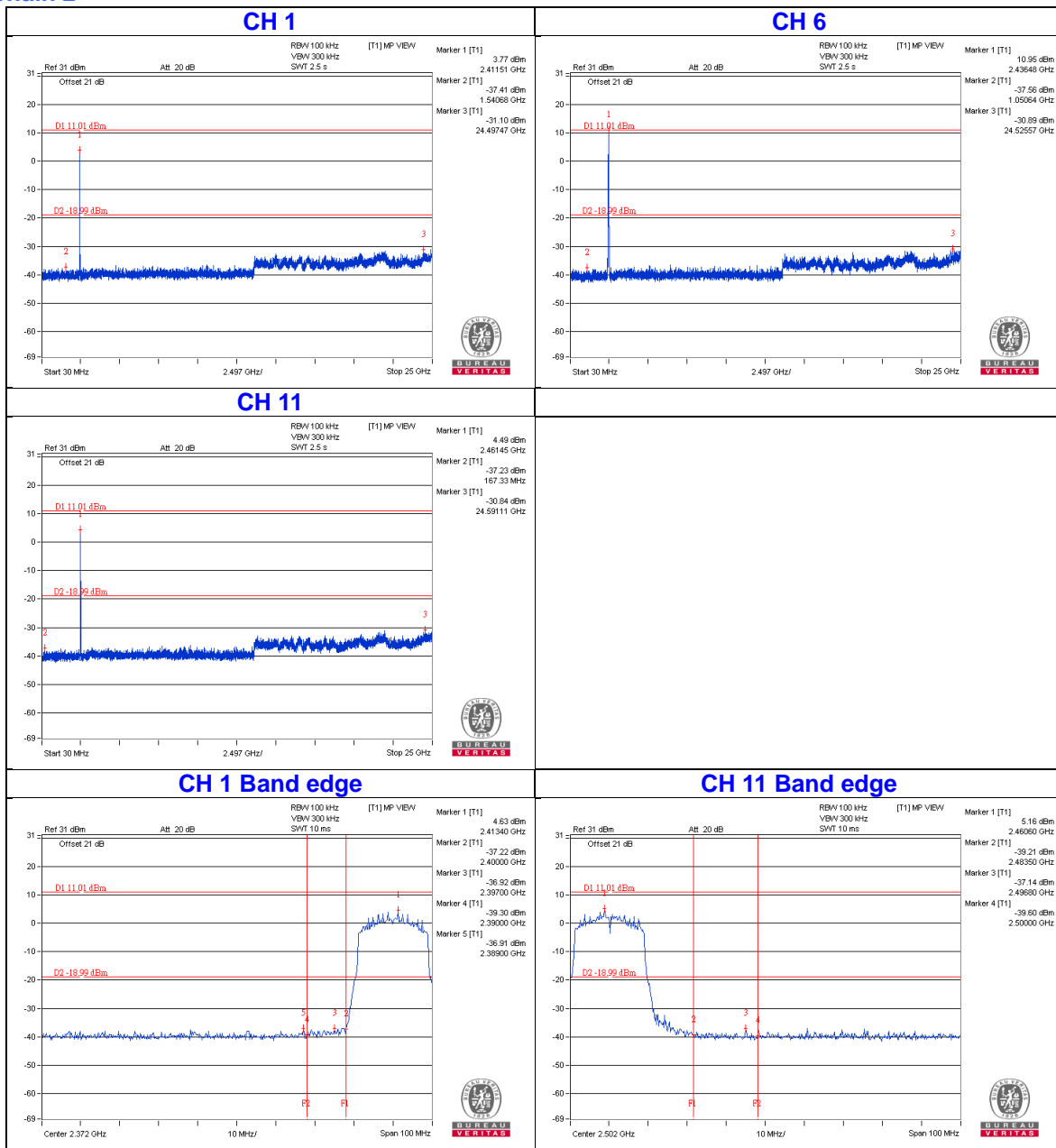

Chain 3

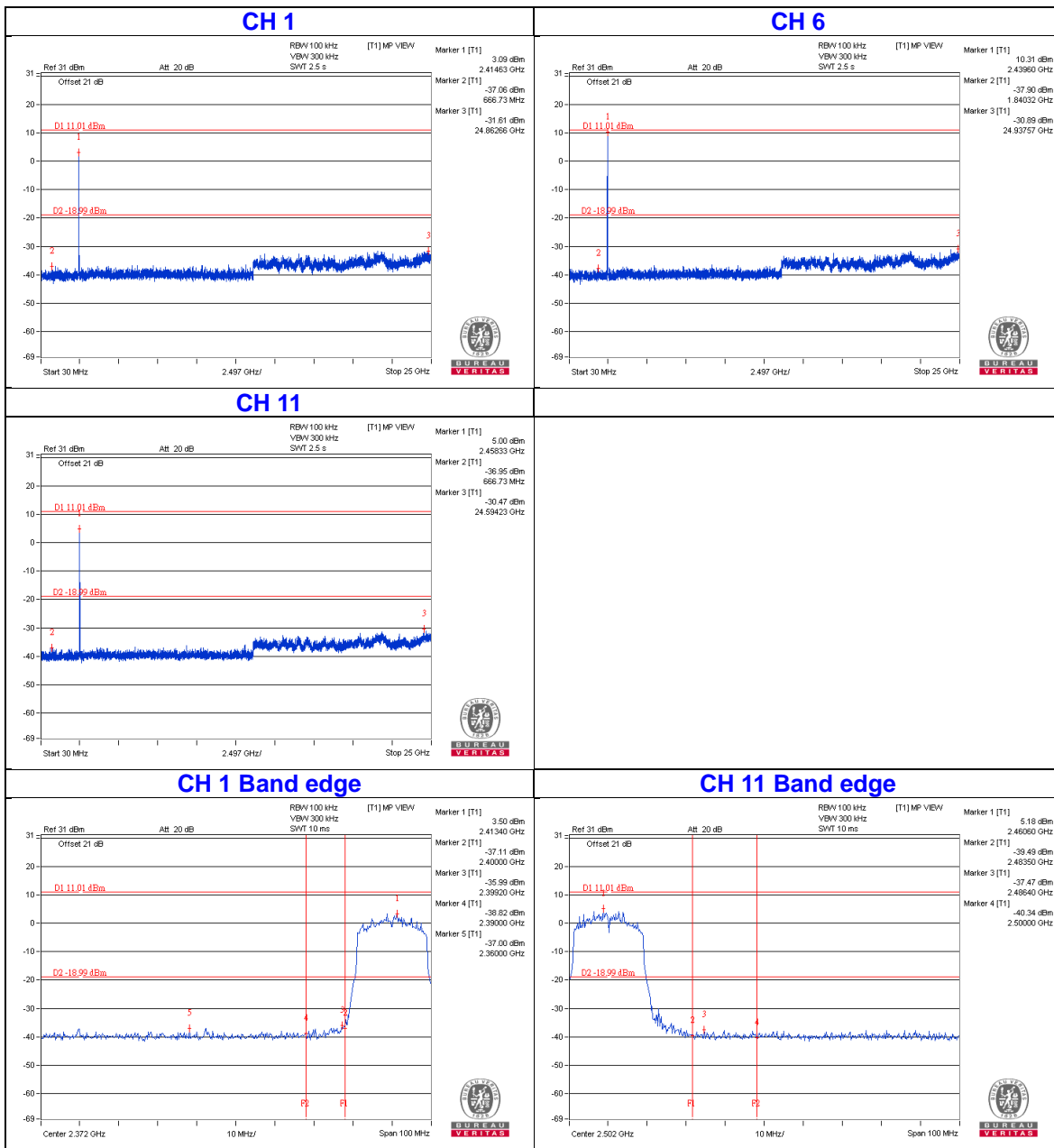

802.11n (HT40)

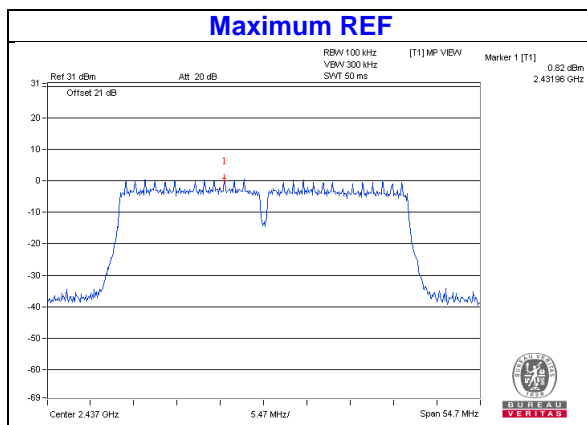

Chain 0

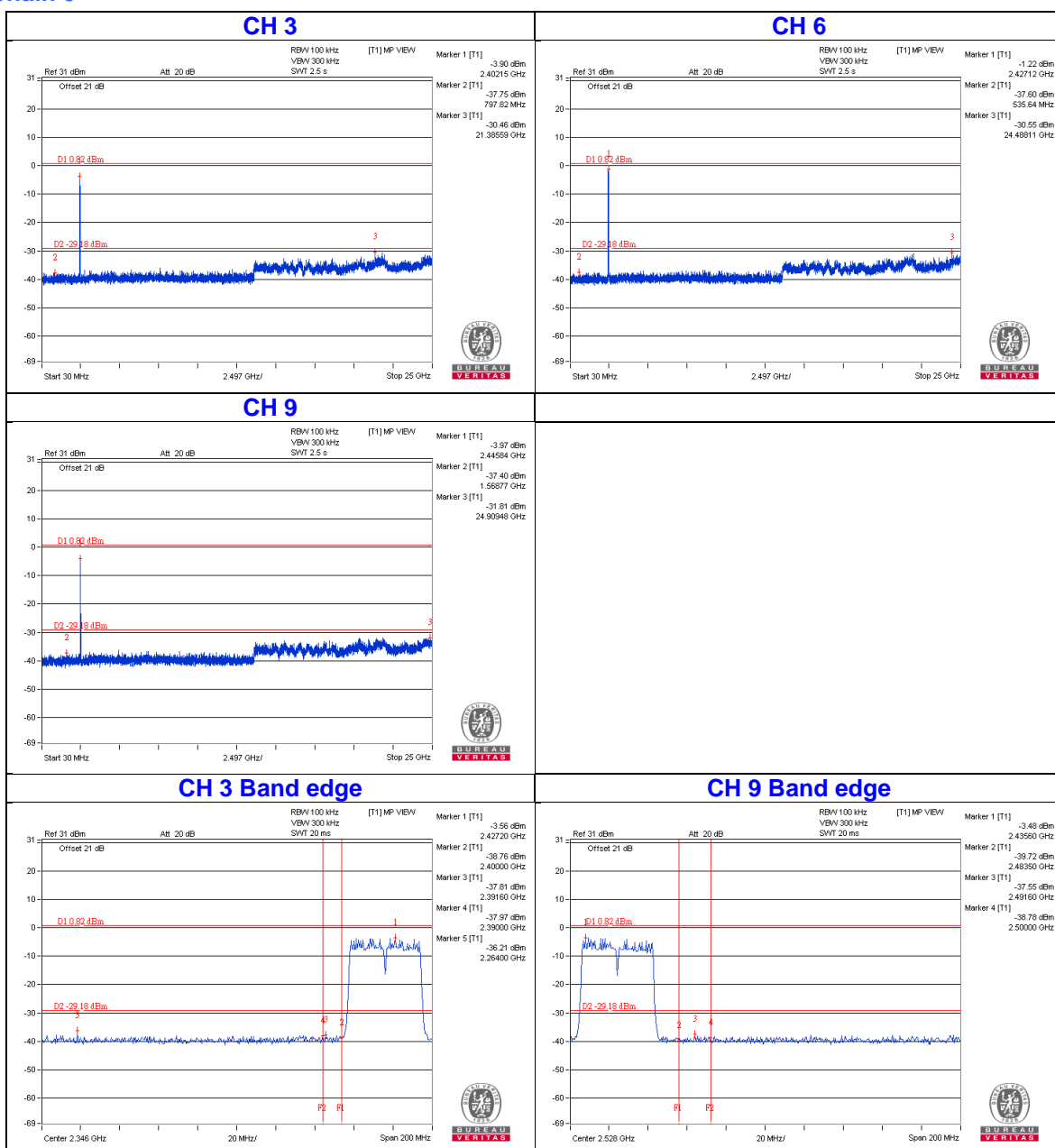

Chain 1

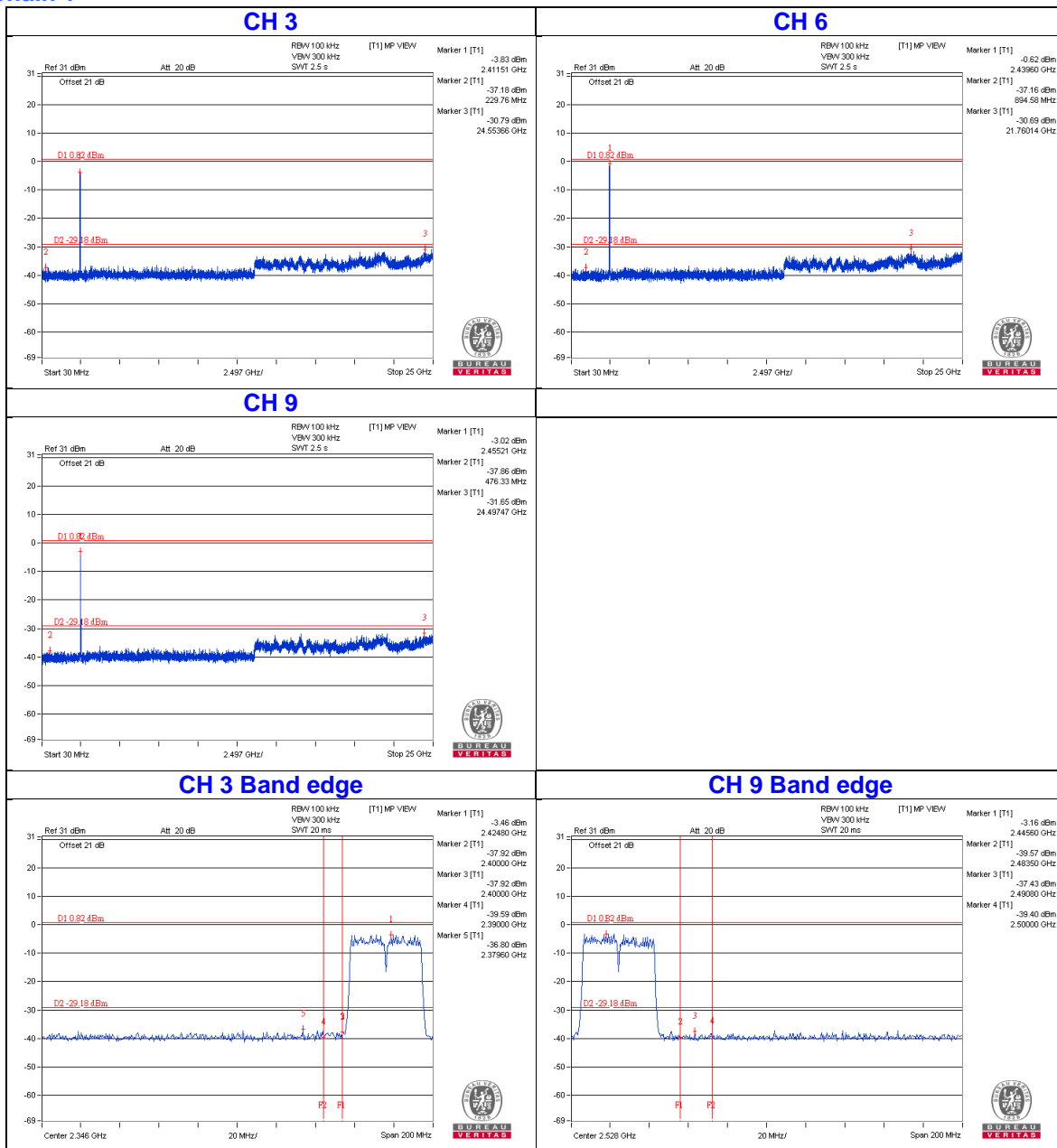

Chain 2

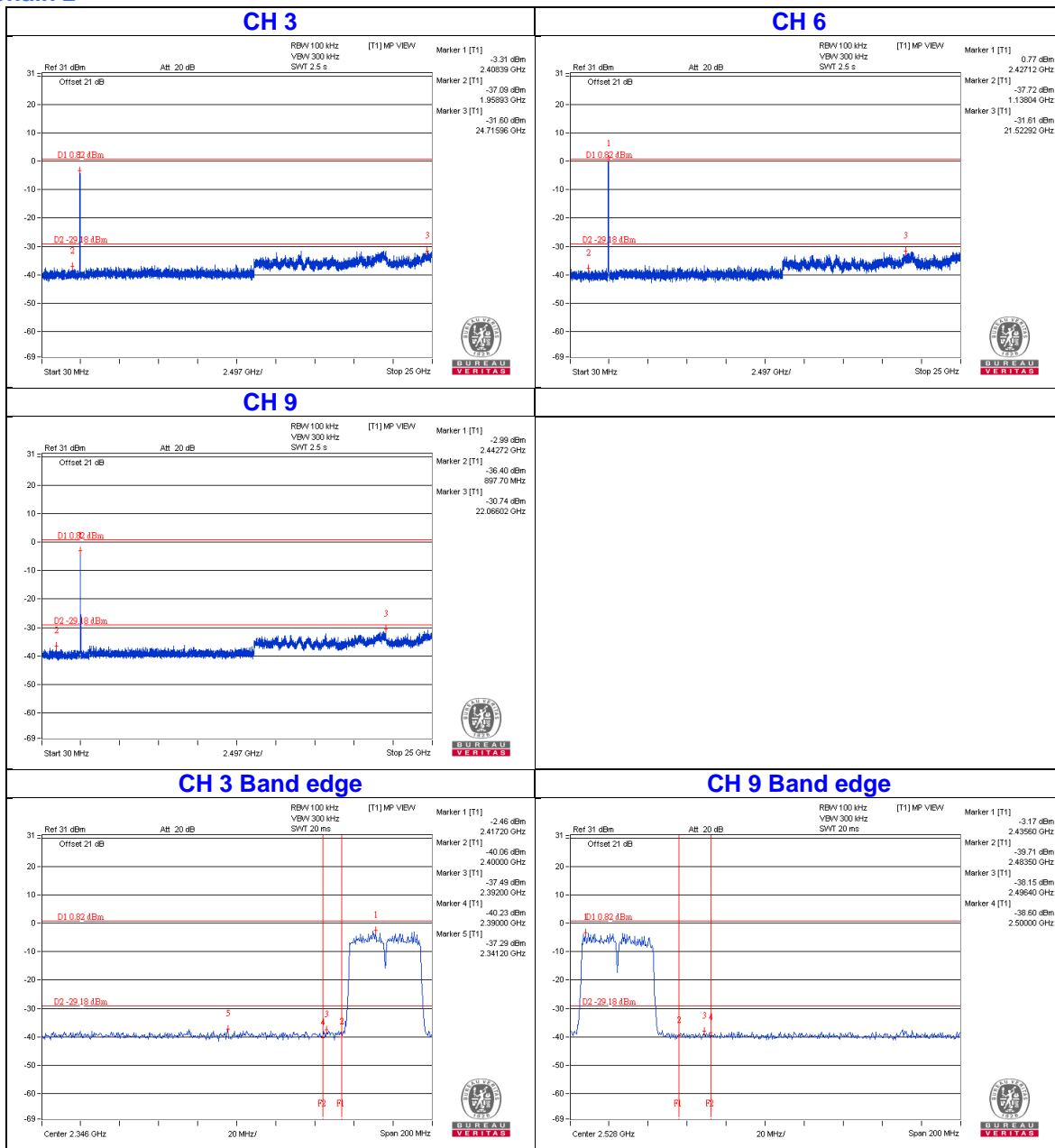

Chain 3

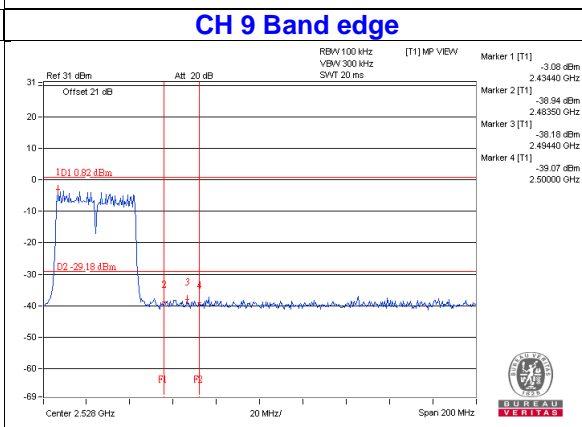
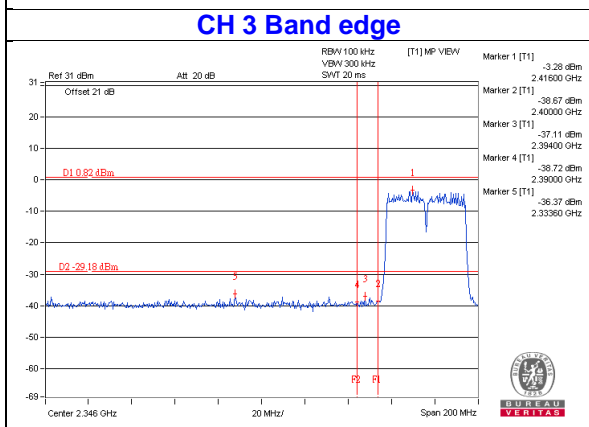
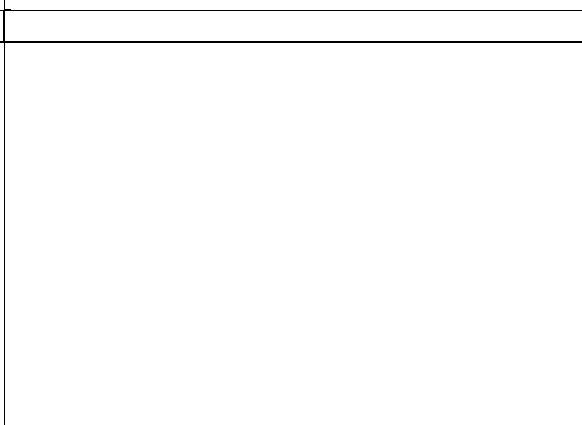
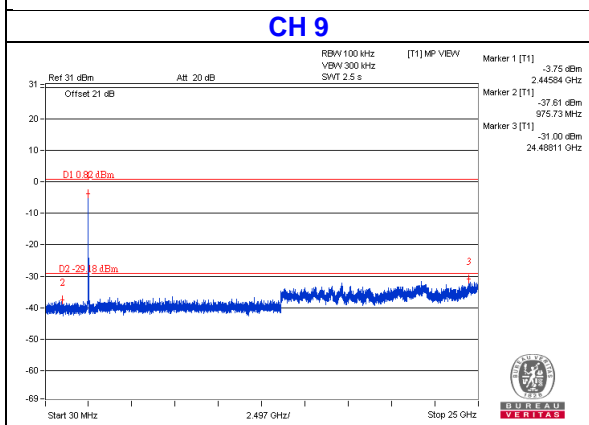
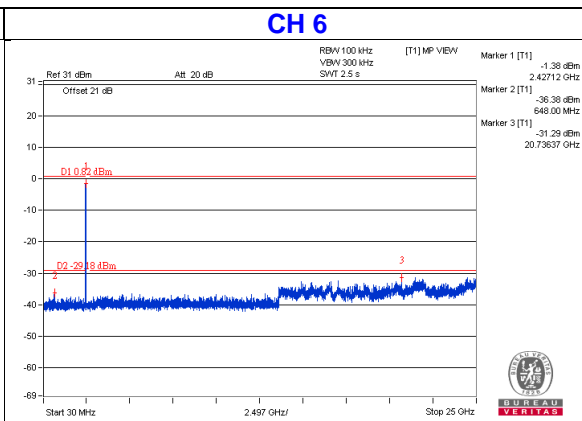
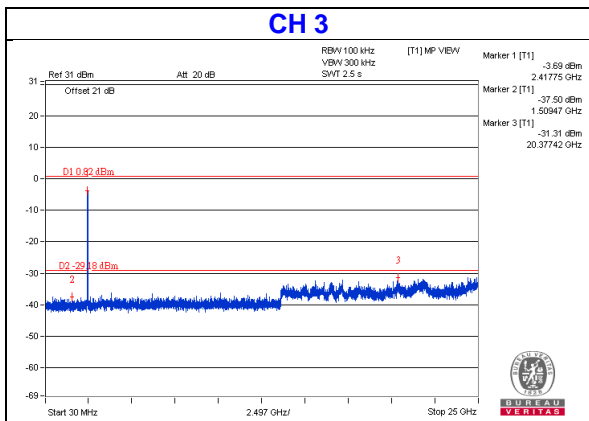

3TX Mode

802.11b

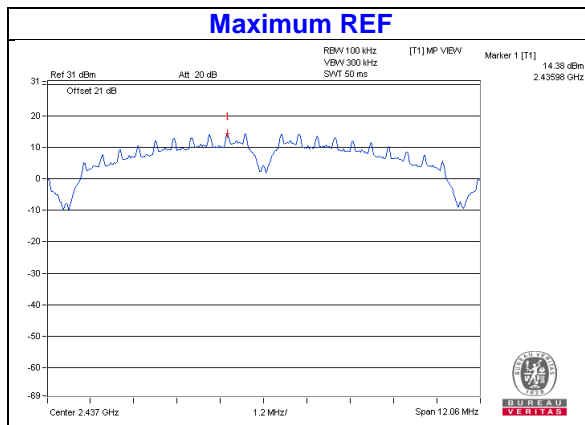

Chain 0

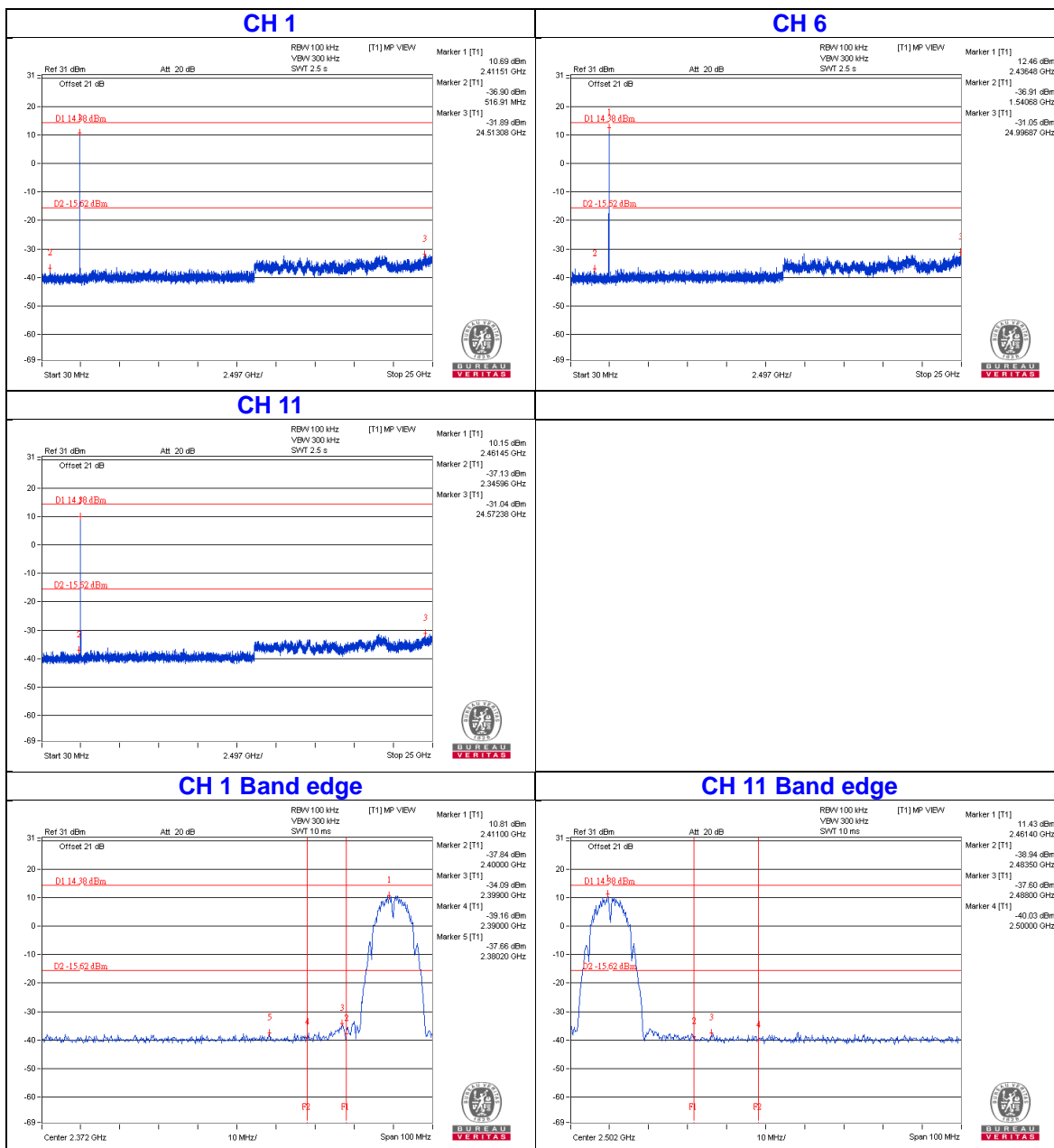

Chain 1

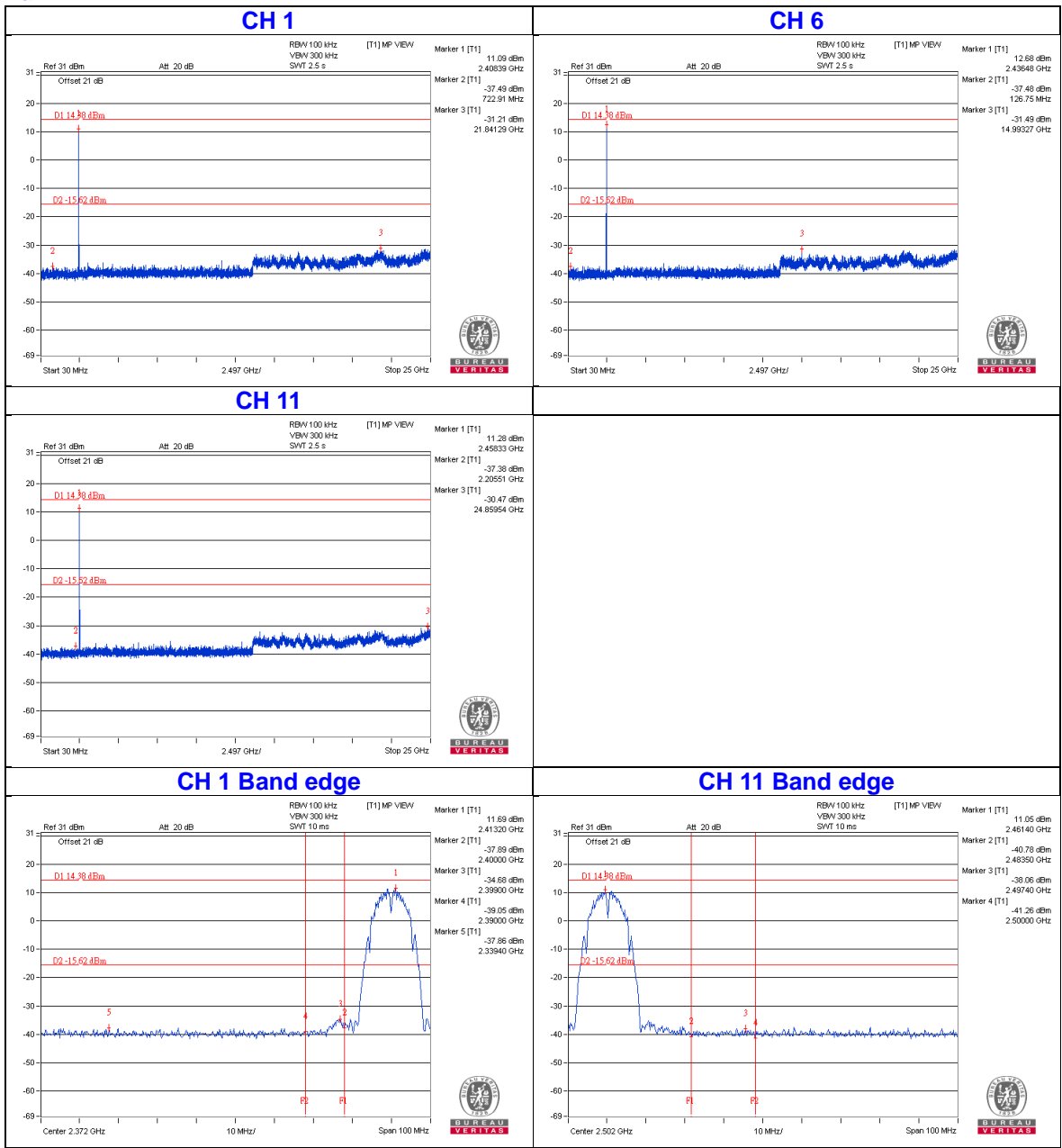

Chain 2

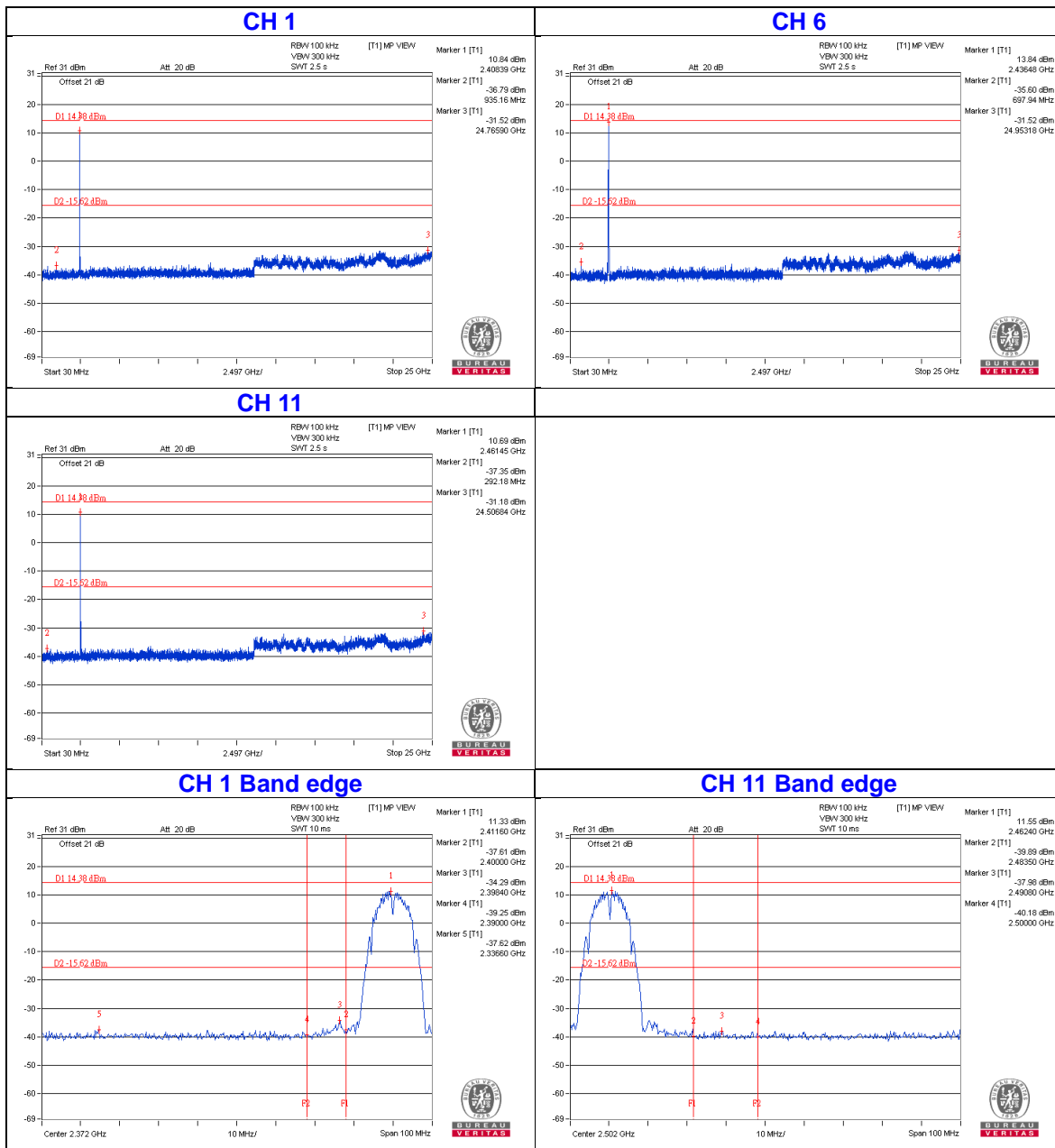

802.11g

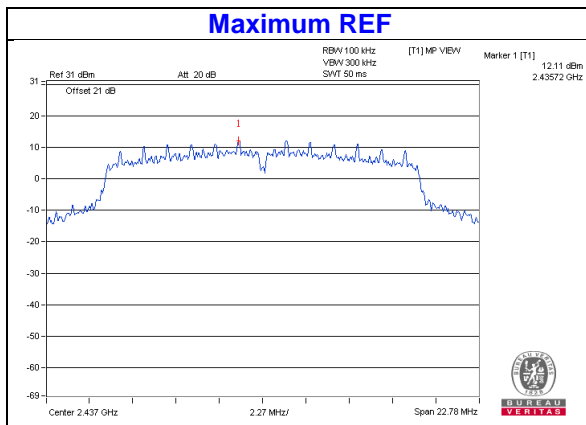

Chain 0

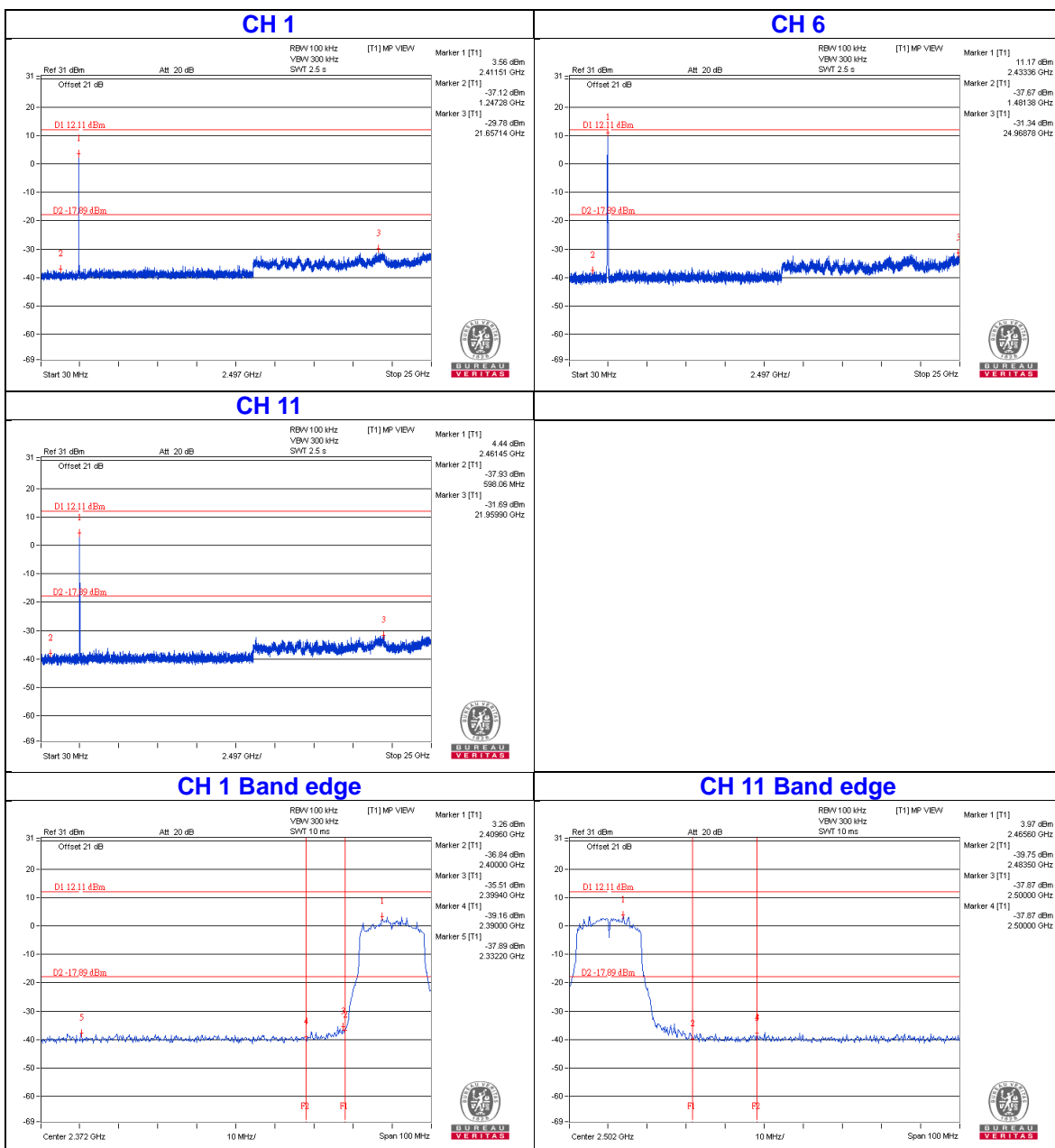

Chain 1

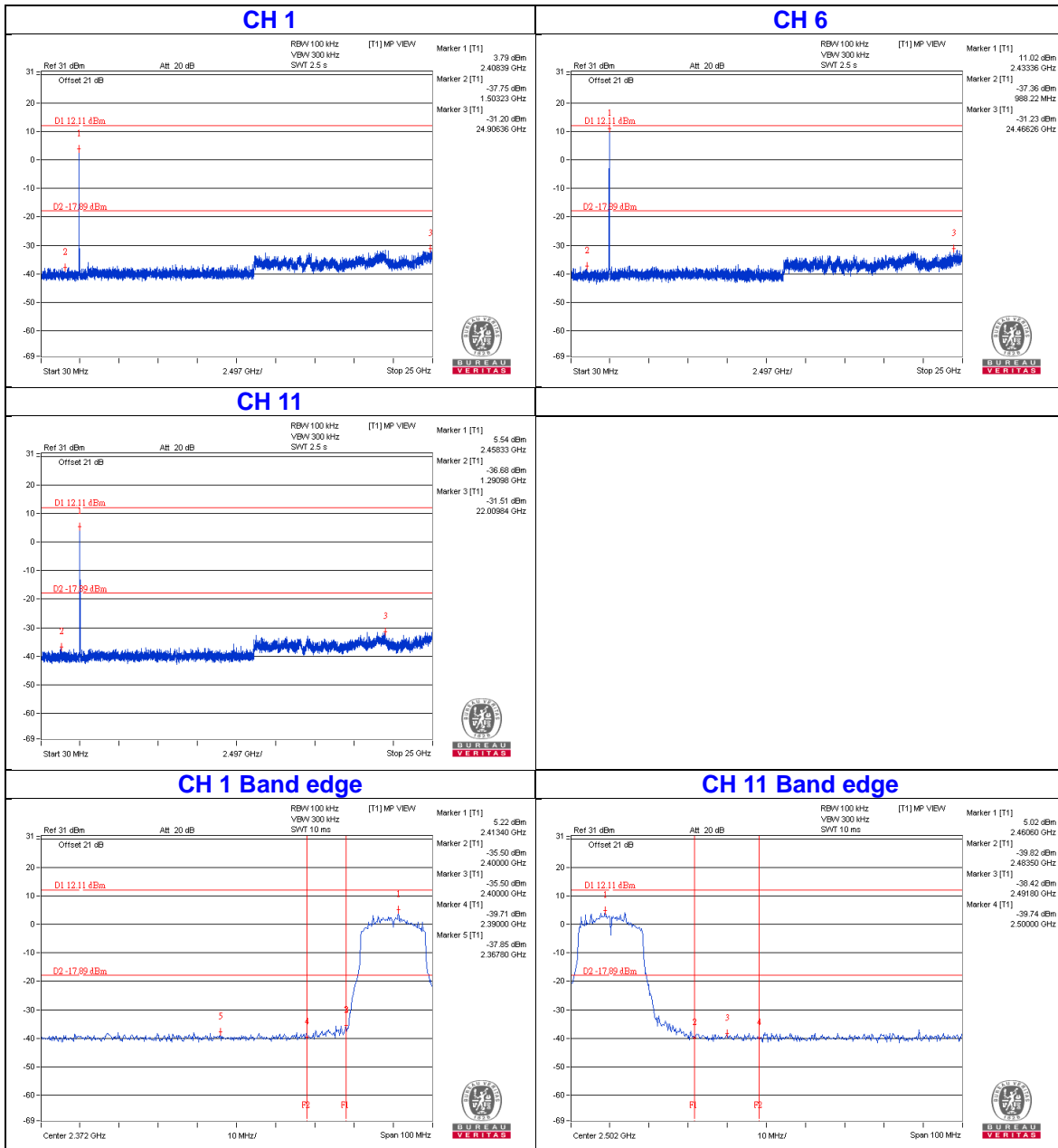

Chain 2

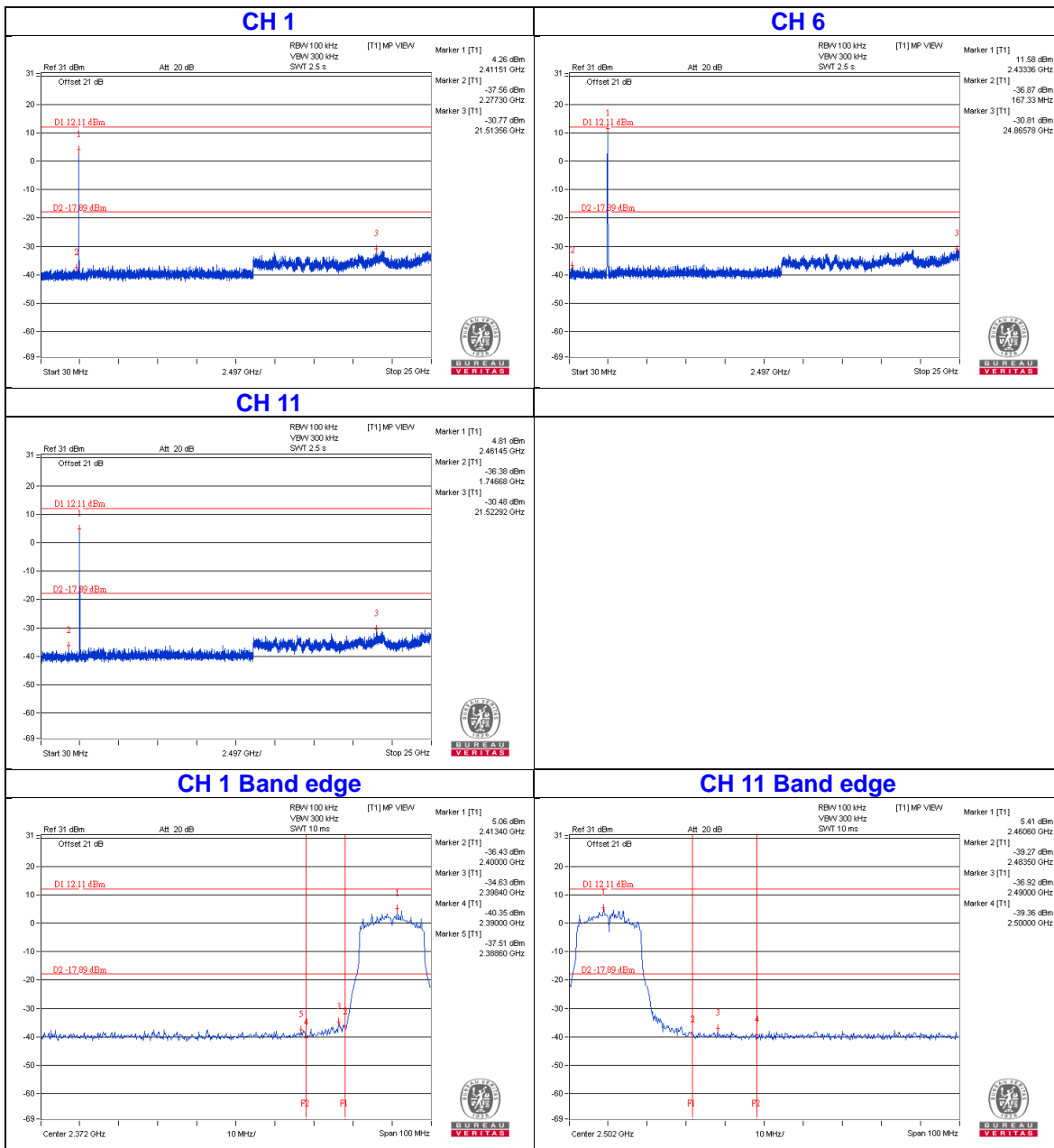

802.11n (HT20)

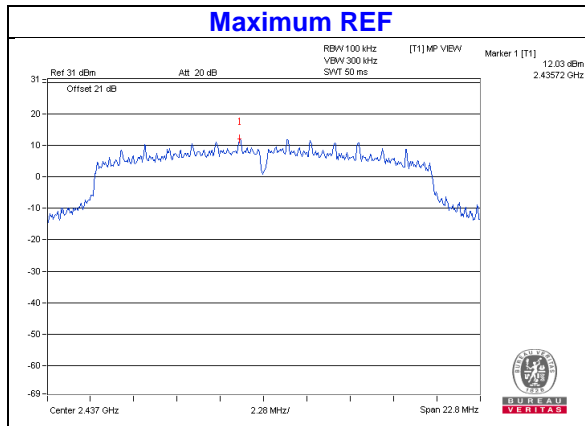

Chain 0

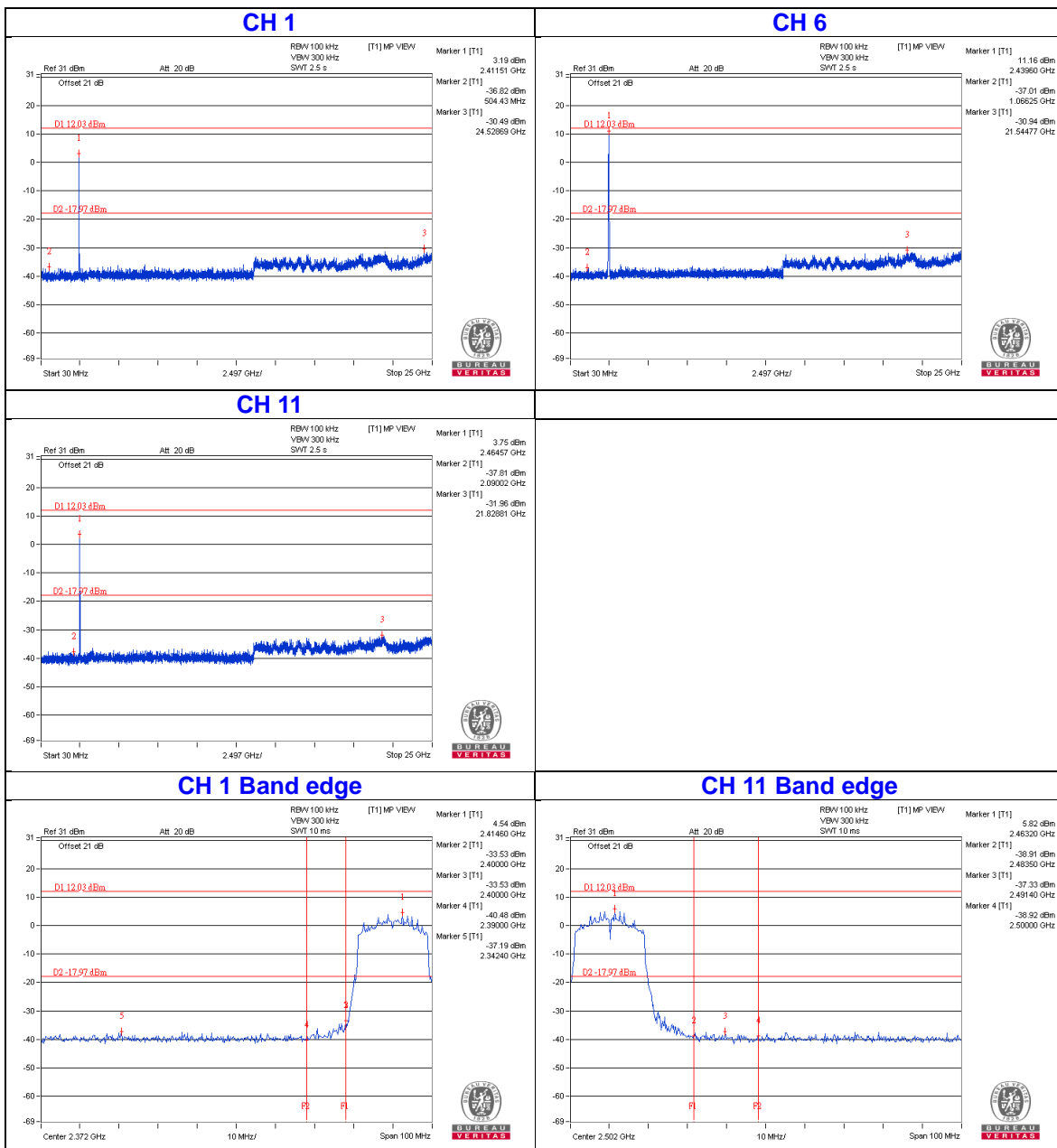

Chain 1

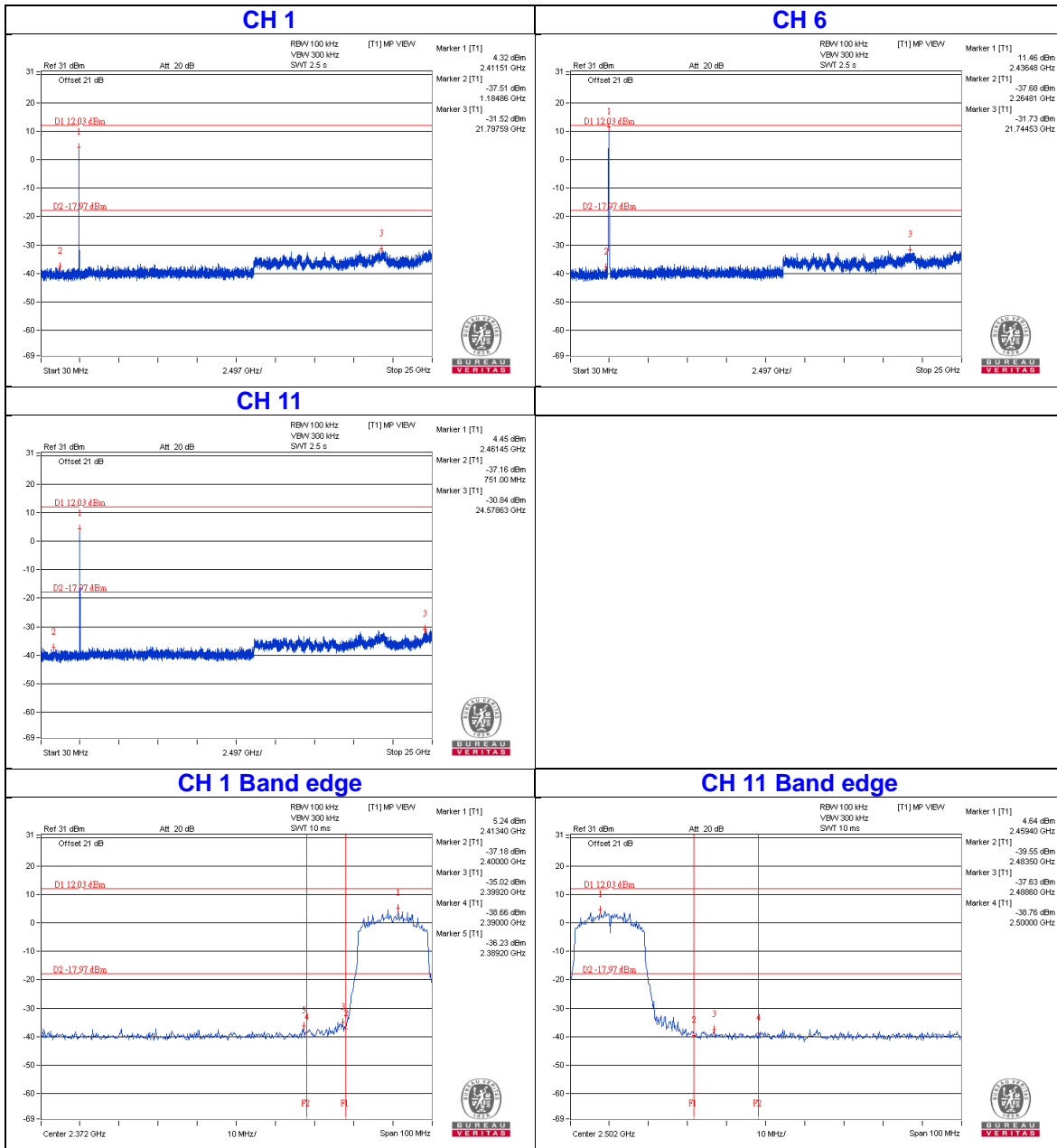

Chain 2

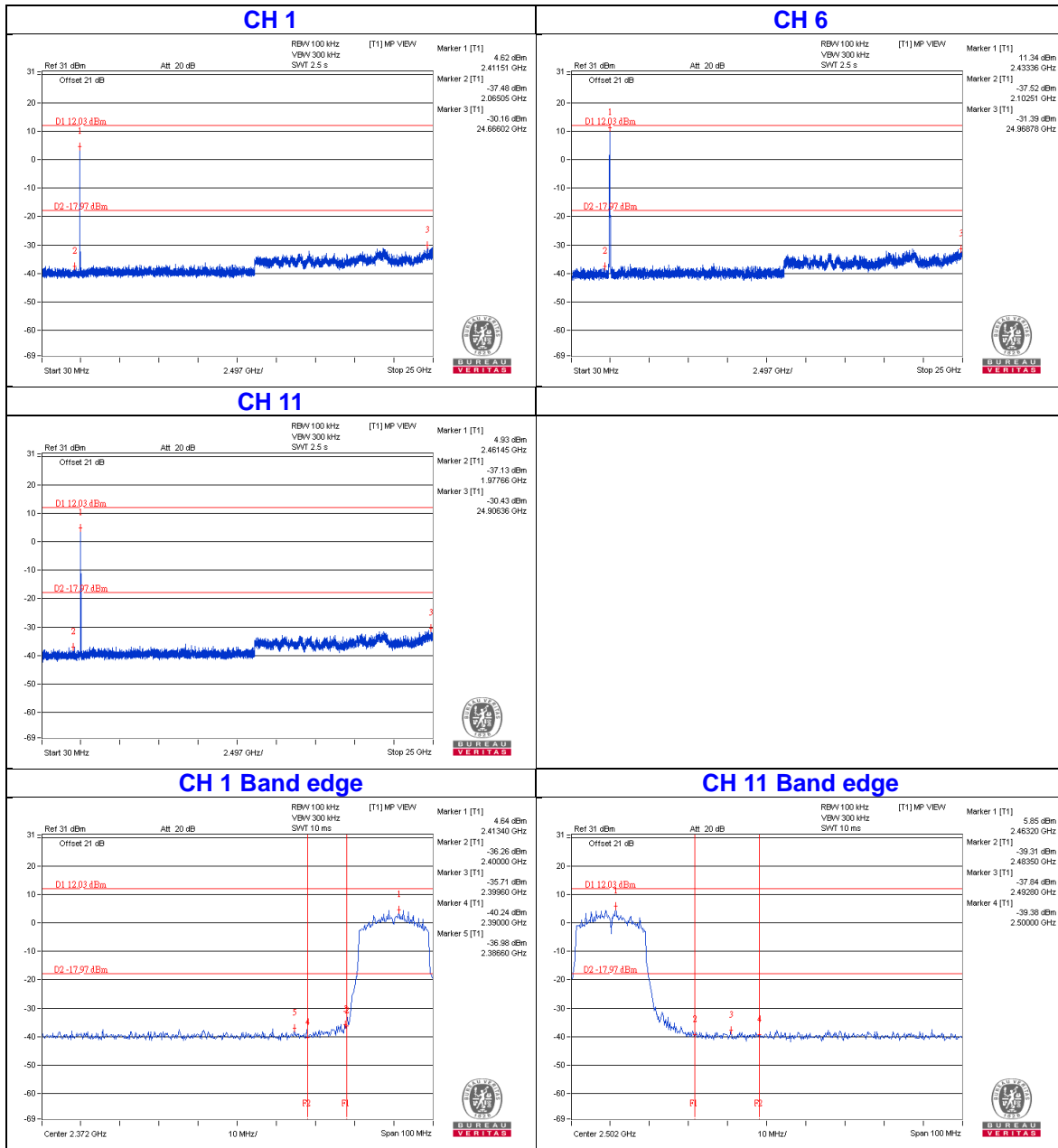

802.11n (HT40)

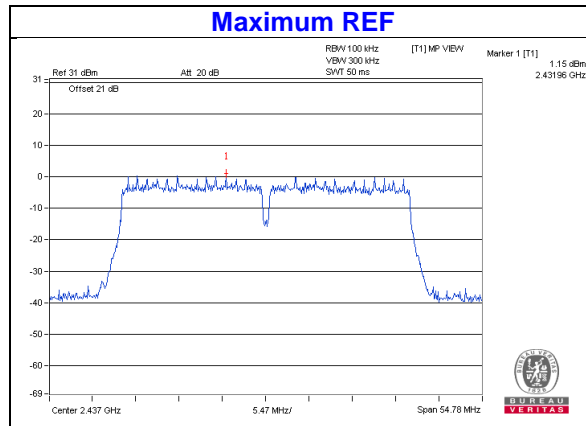

Chain 0

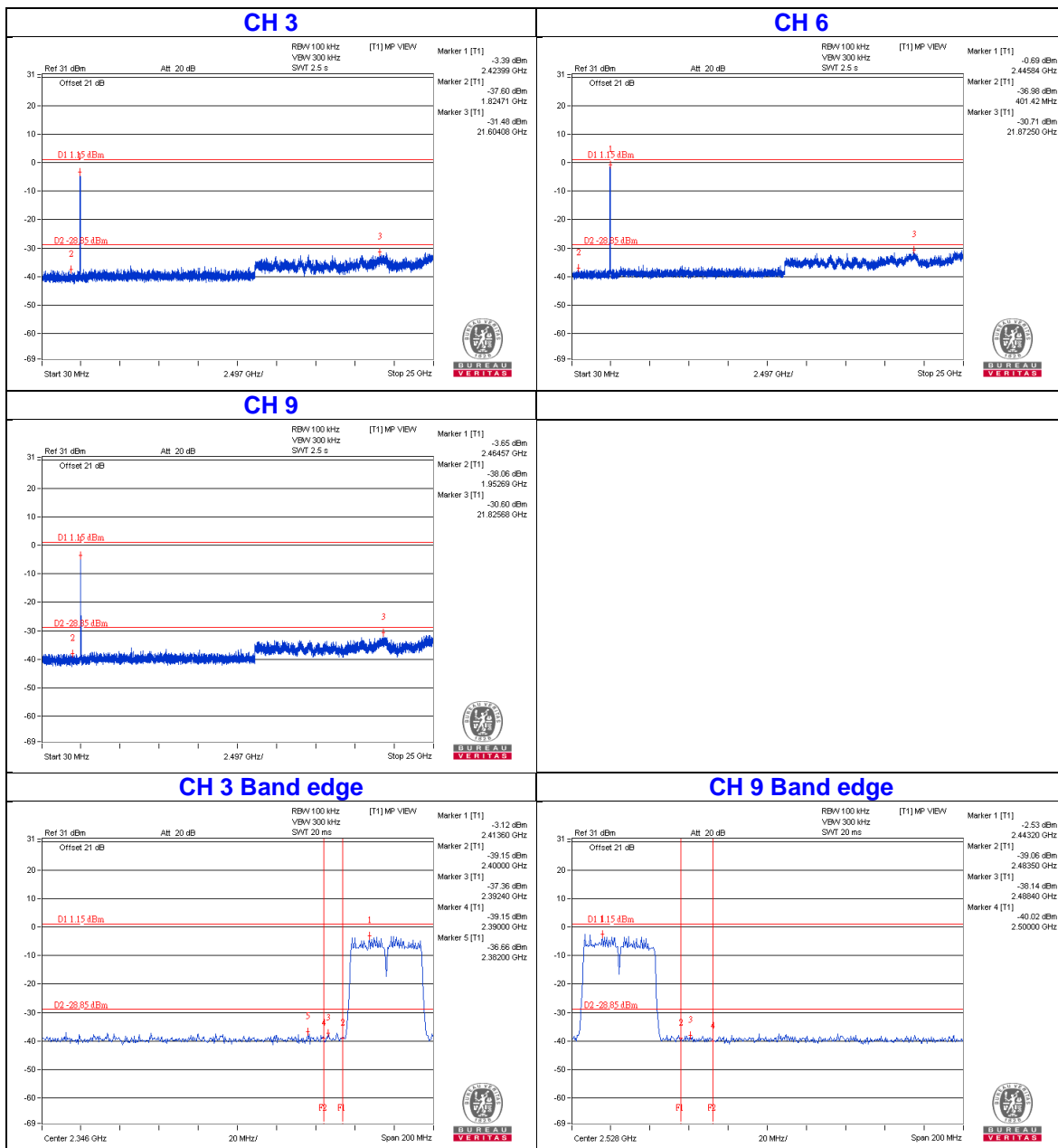

Chain 1

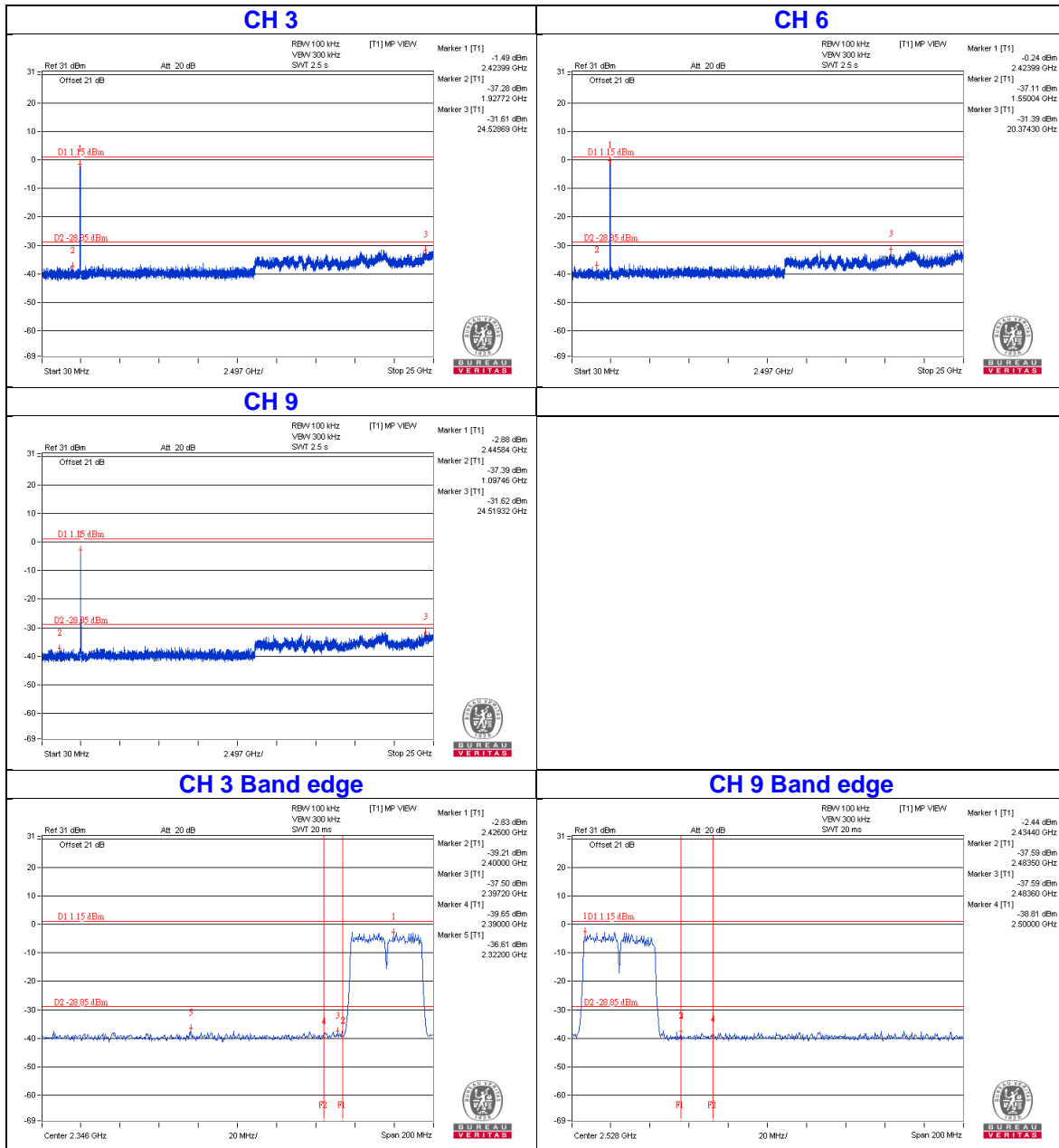

Chain 2

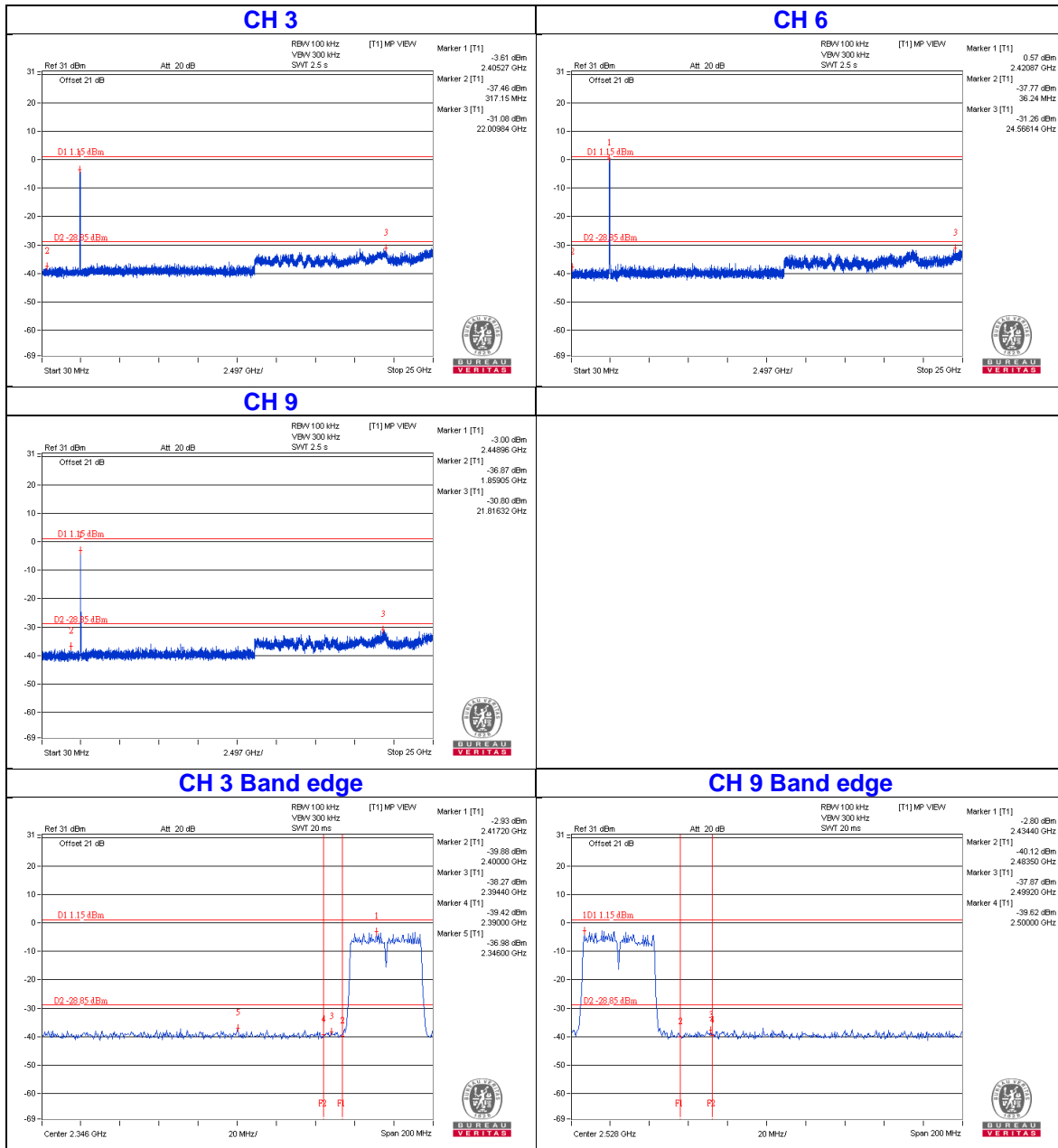

2TX Mode

802.11b

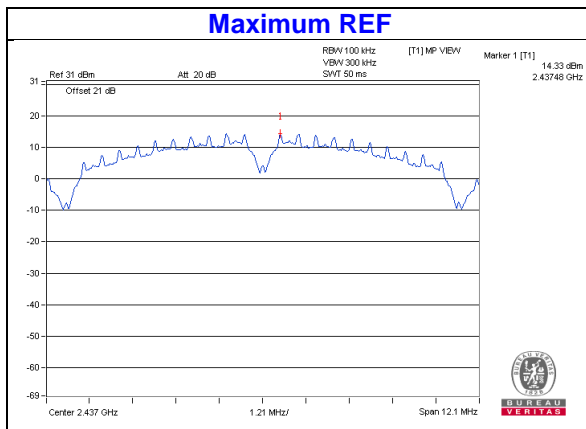

Chain 1

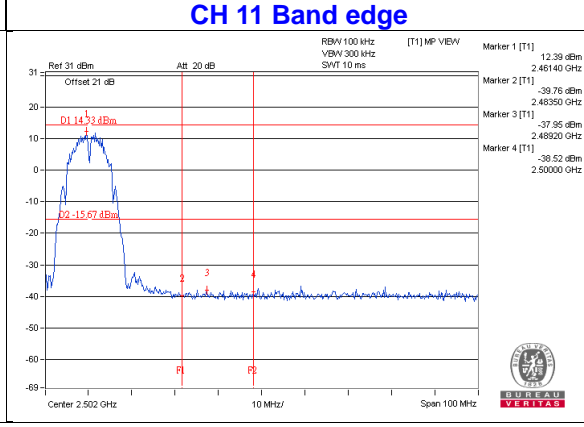
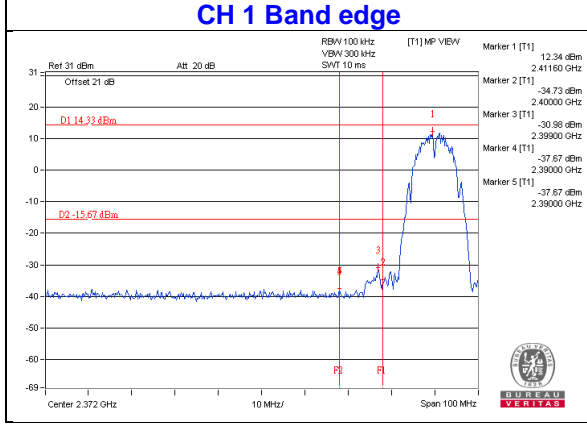
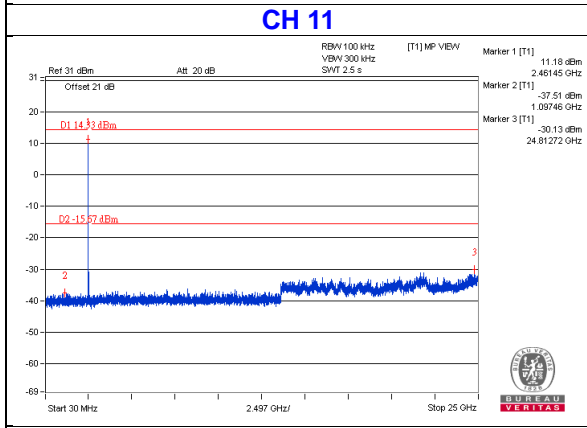
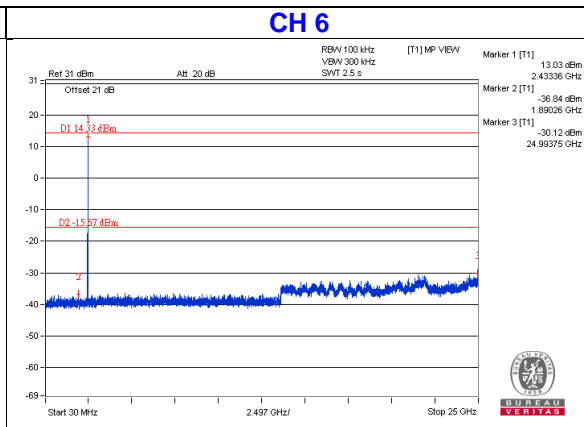
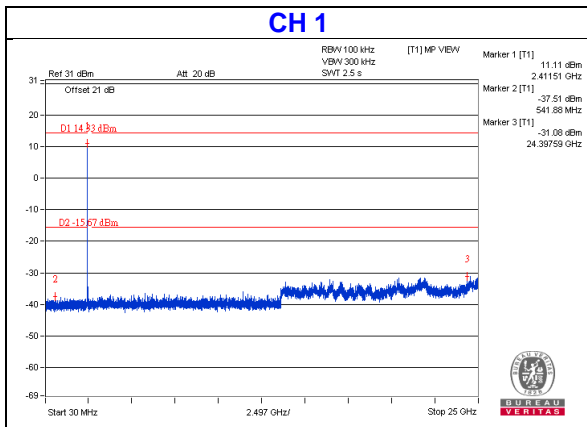

Chain 2

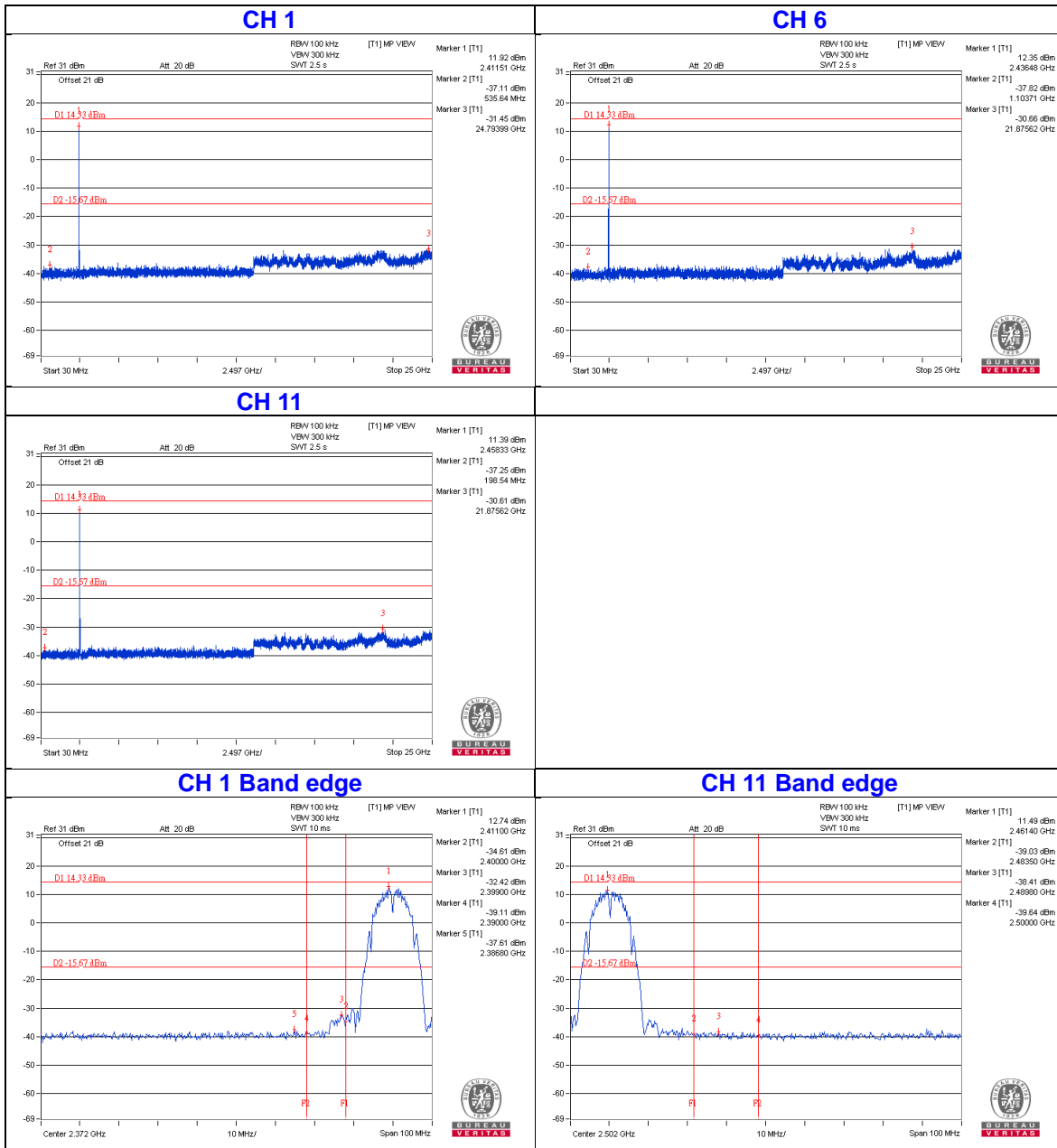

802.11g

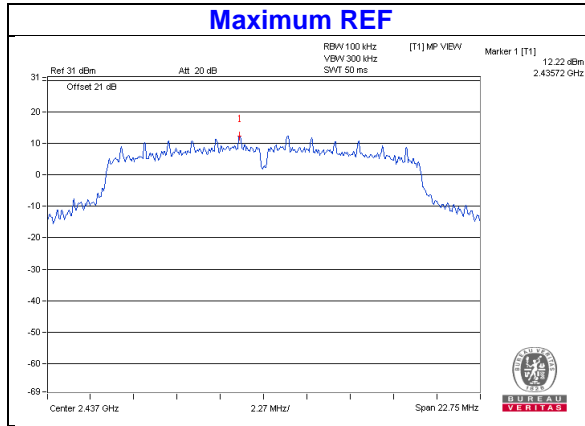

Chain 1

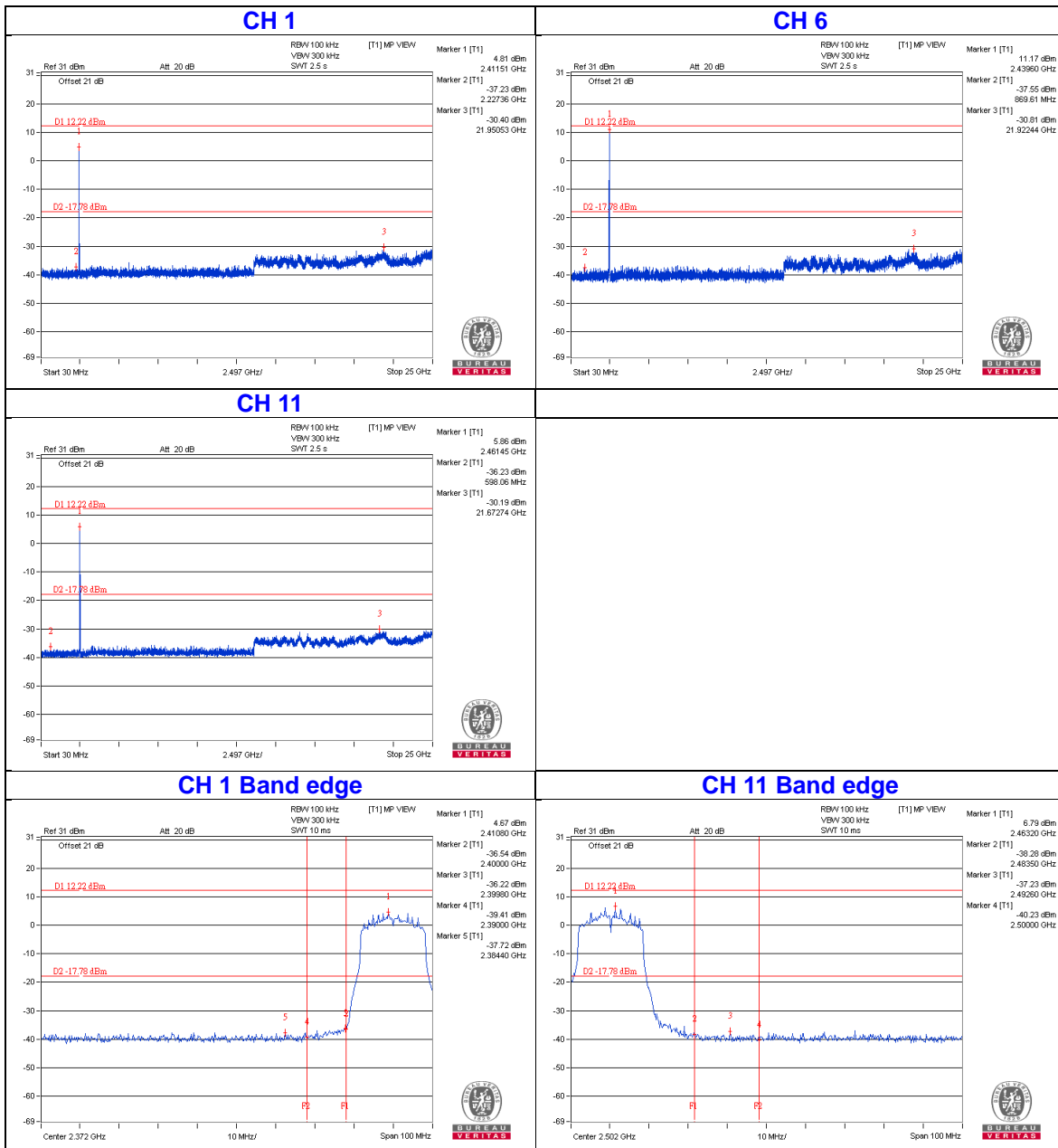

Chain 2

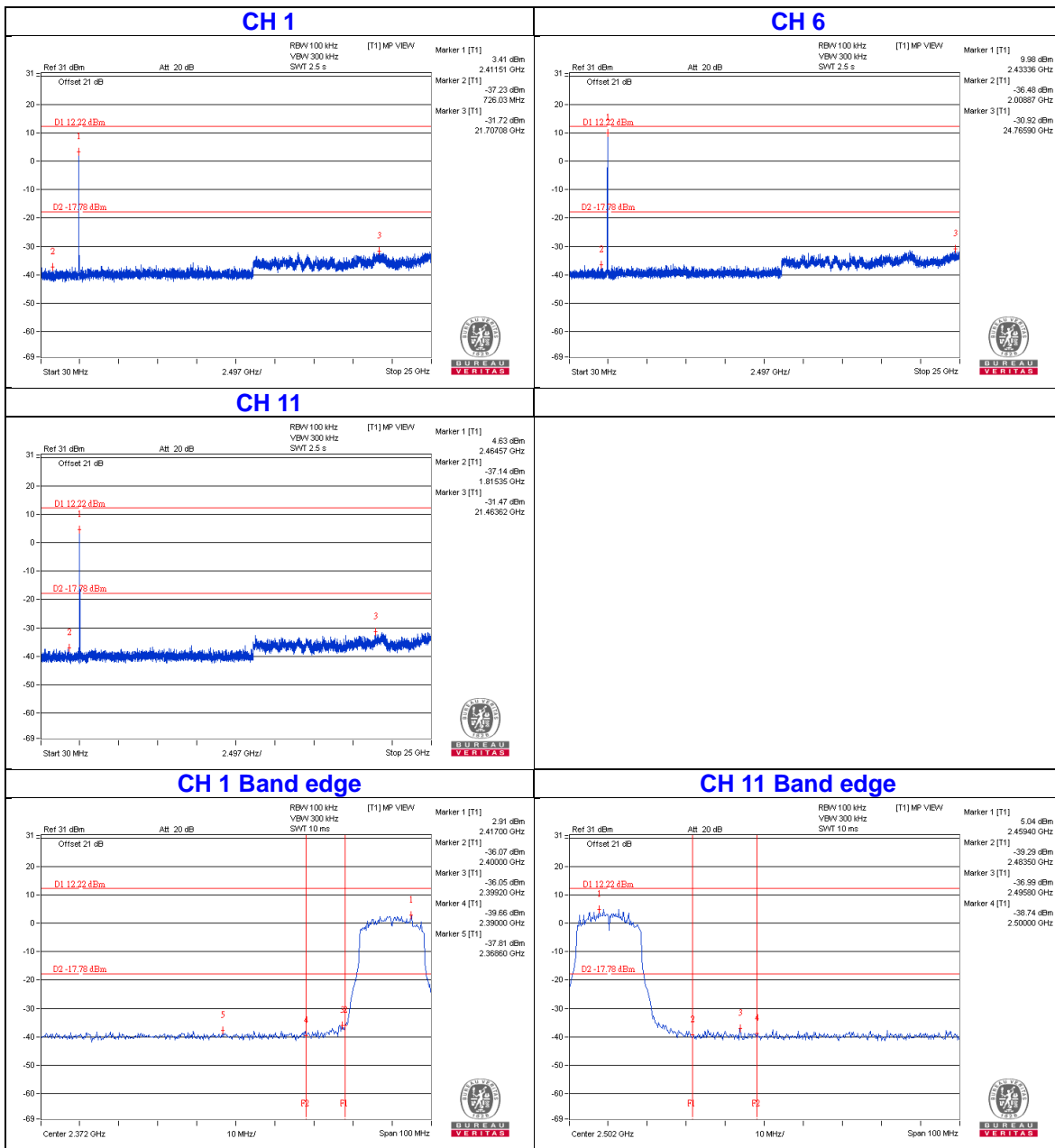

802.11n (HT20)

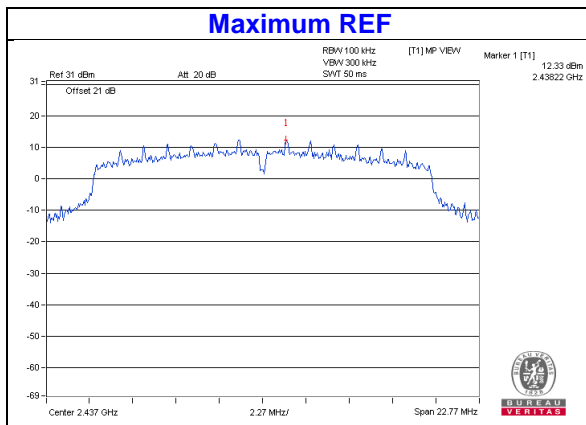

Chain 1

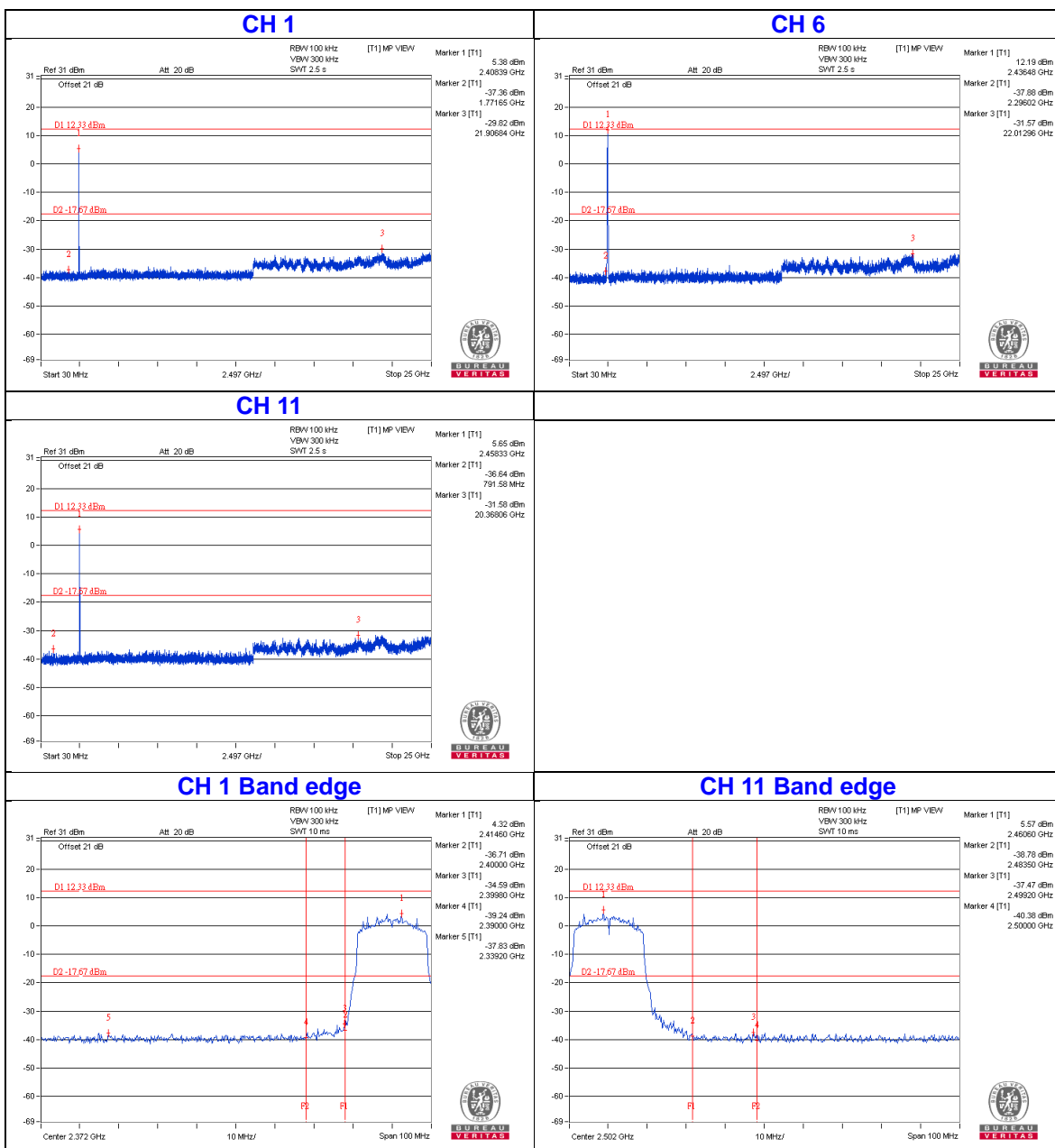

Chain 2

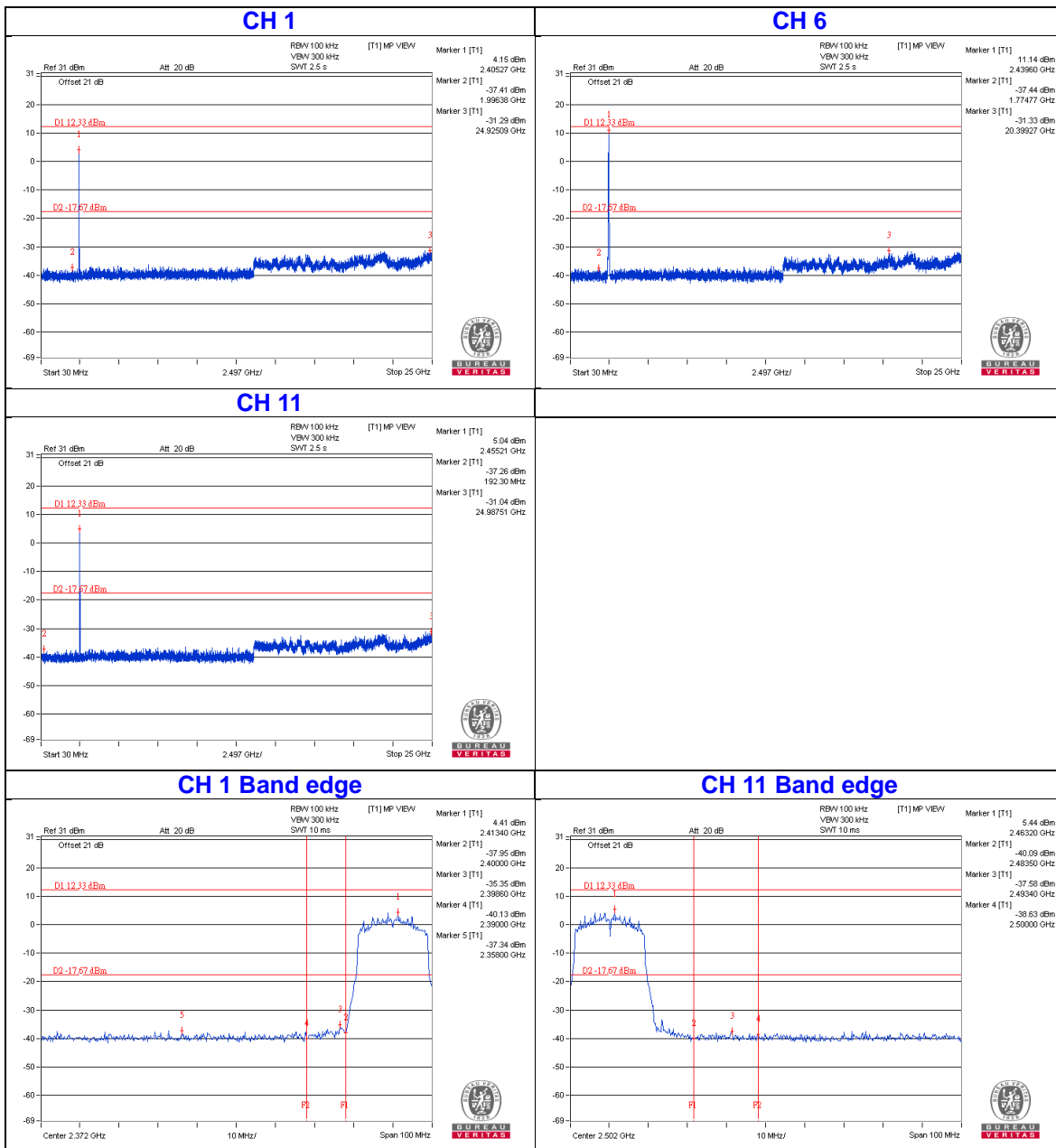

802.11n (HT40)

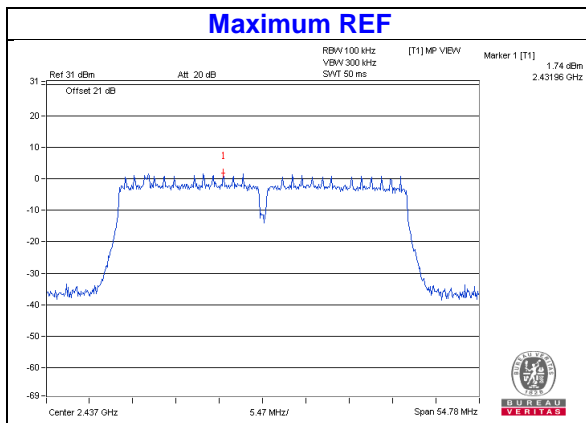

Chain 1

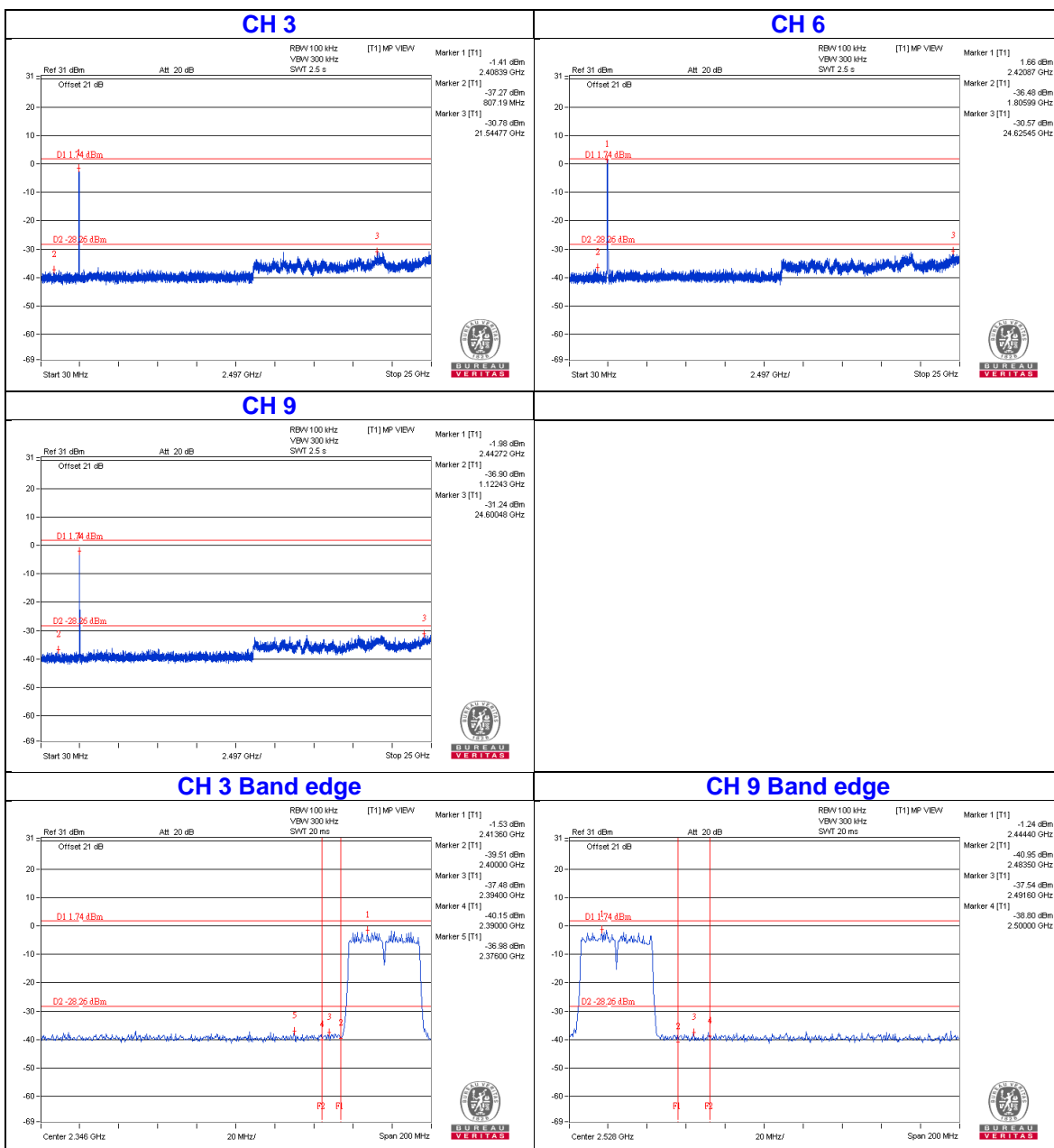

Chain 2

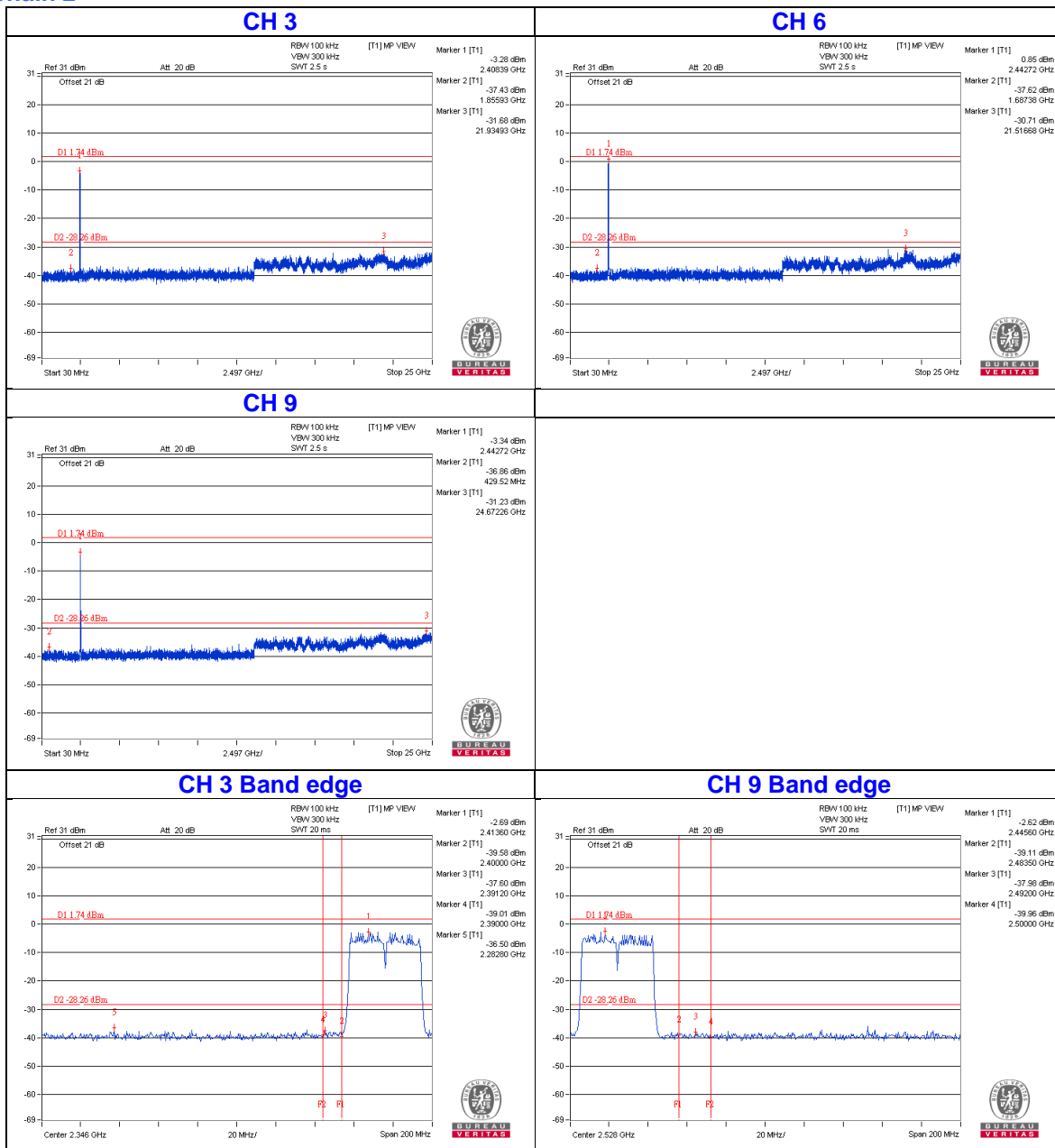

1TX Mode

802.11b

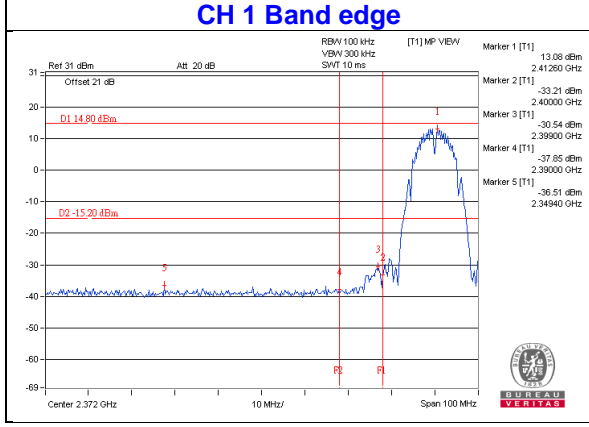
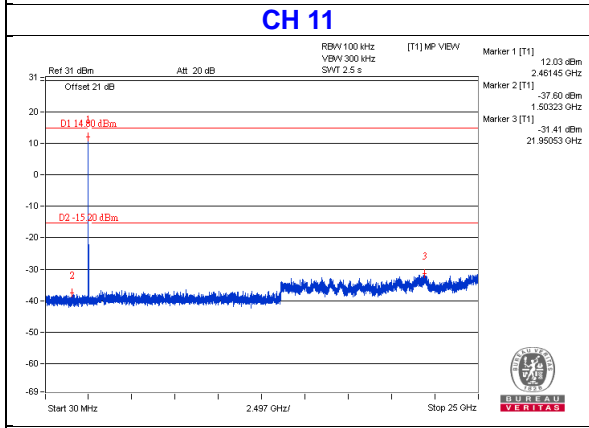
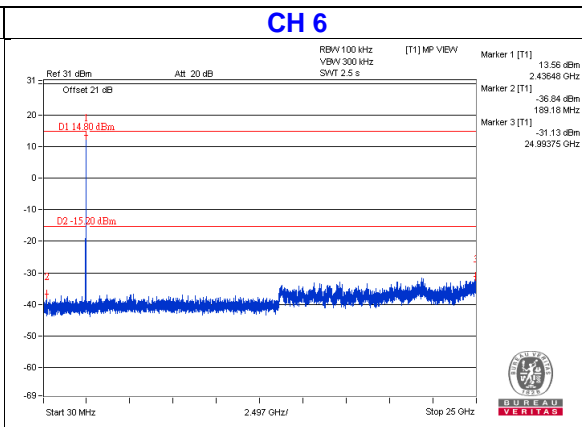
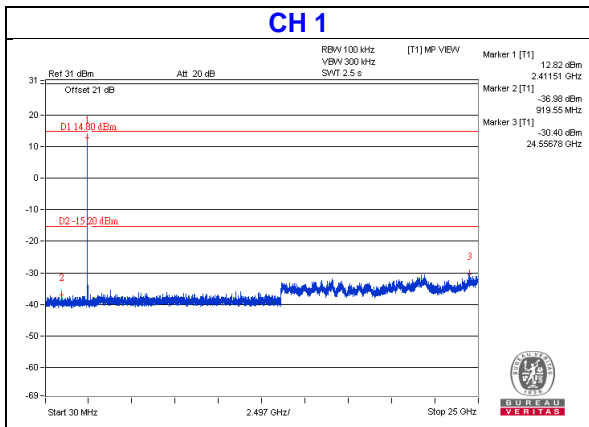
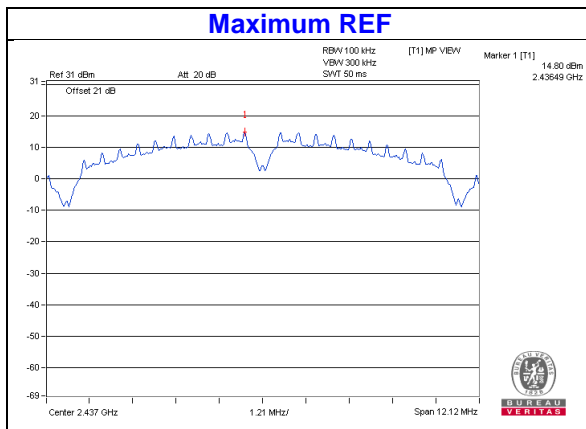

802.11g

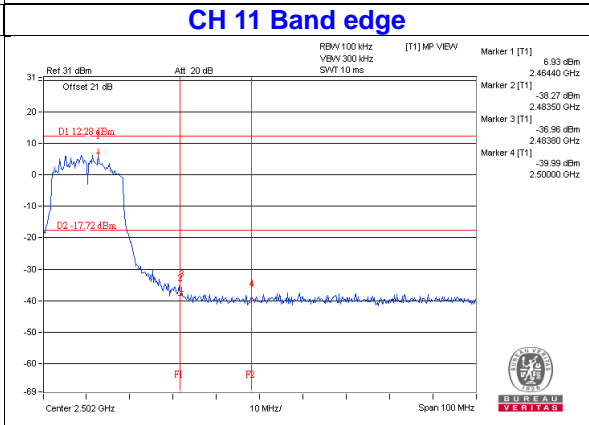
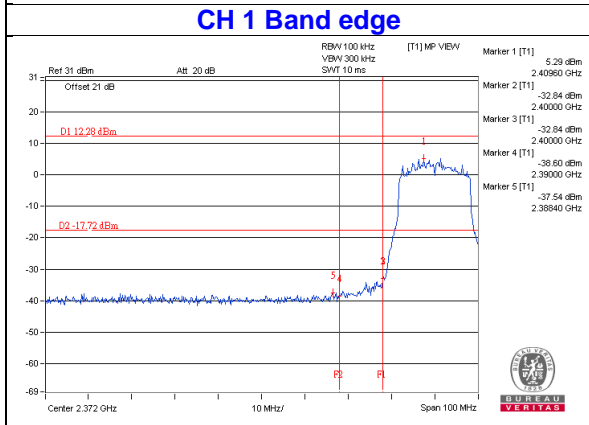
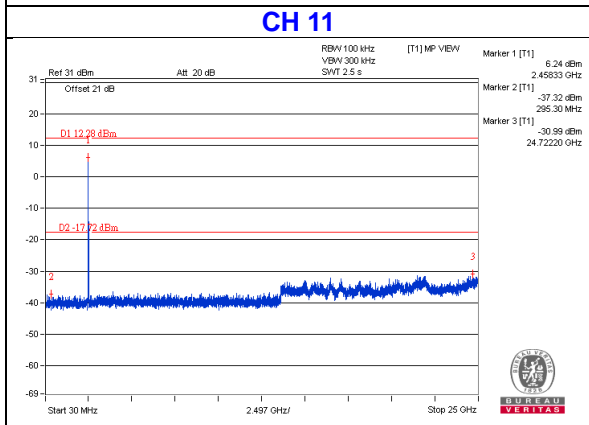
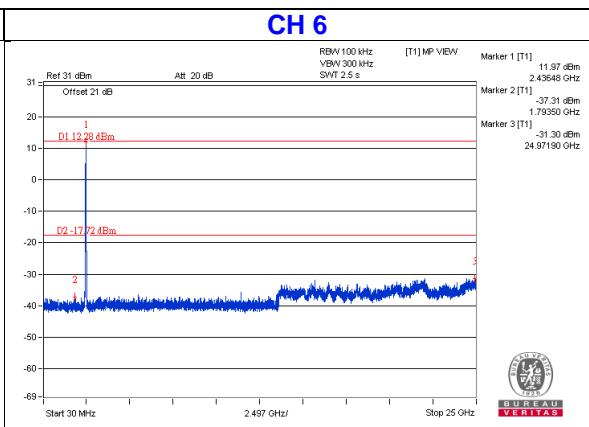
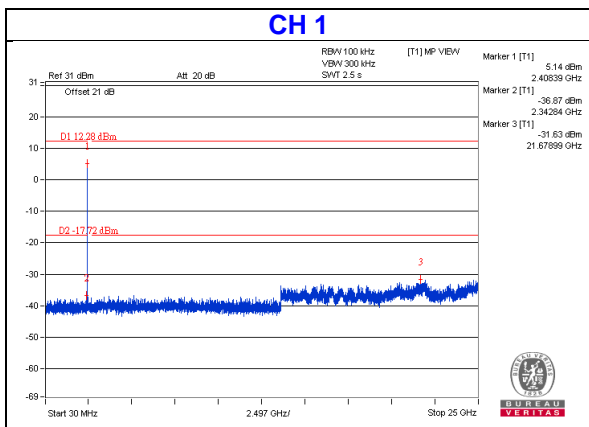
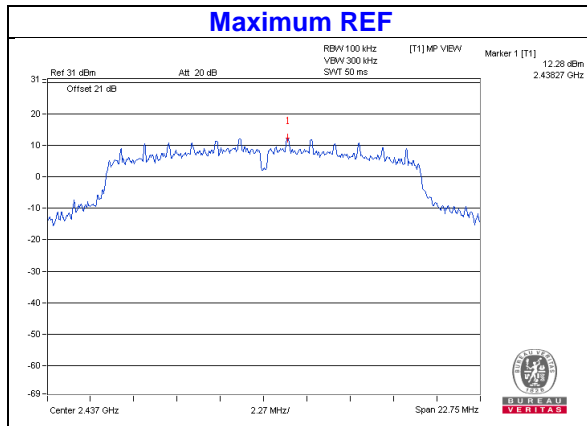

802.11n (HT20)

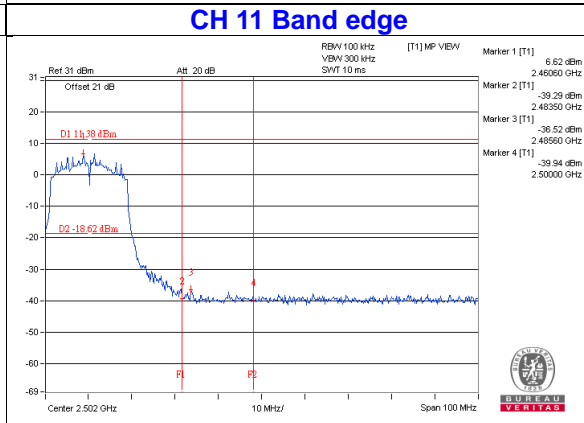
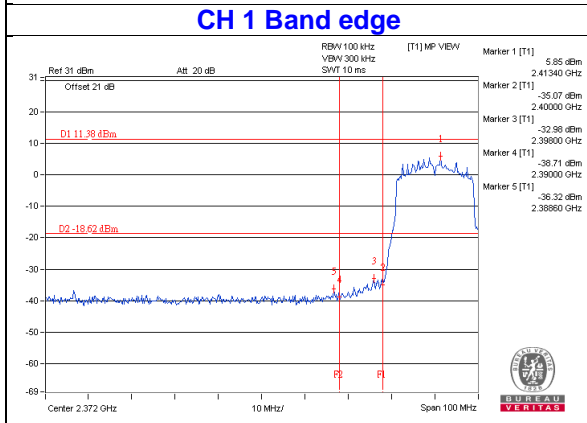
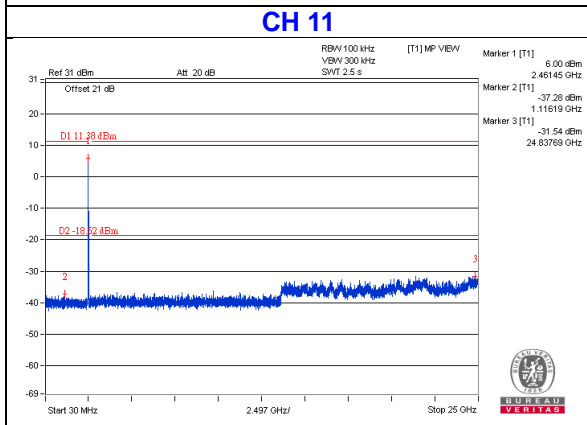
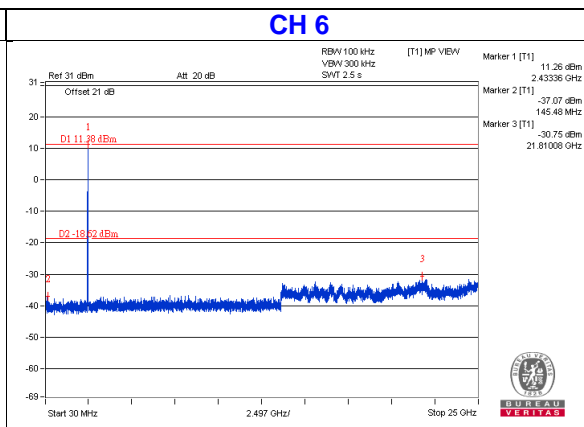
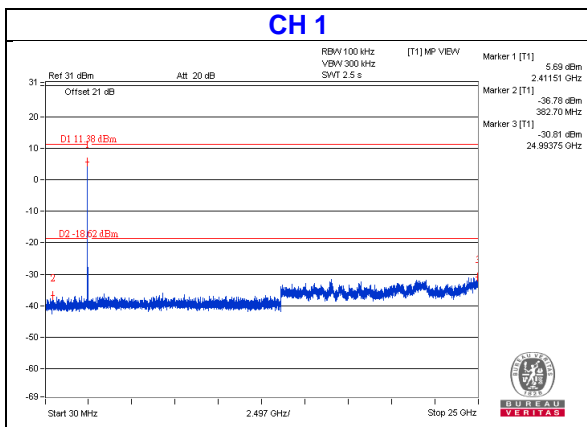
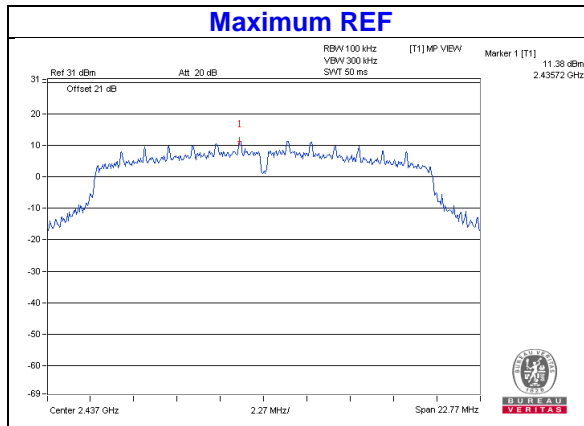

802.11n (HT40)

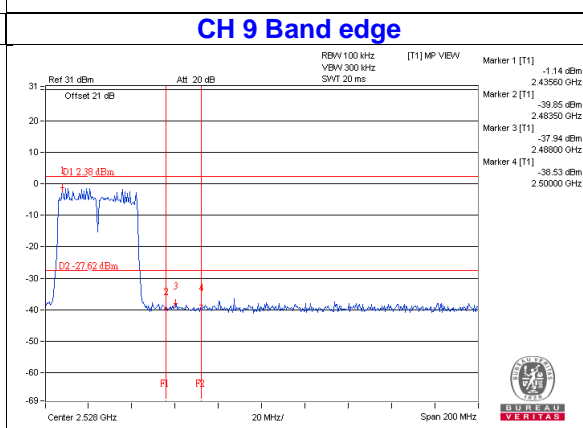
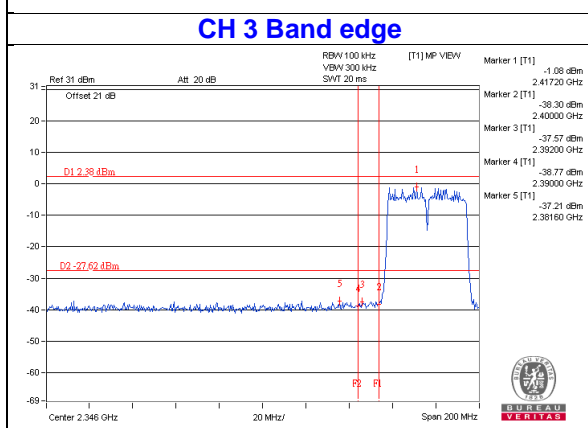
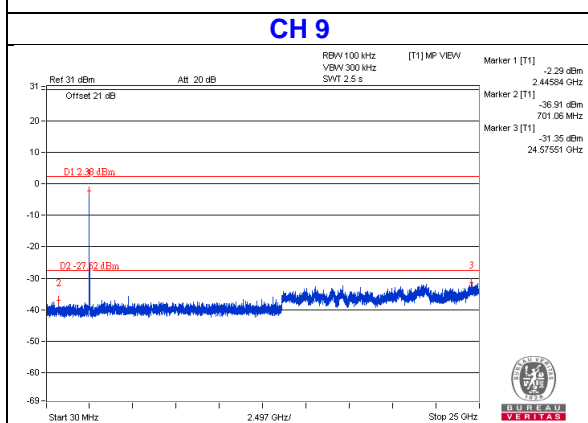
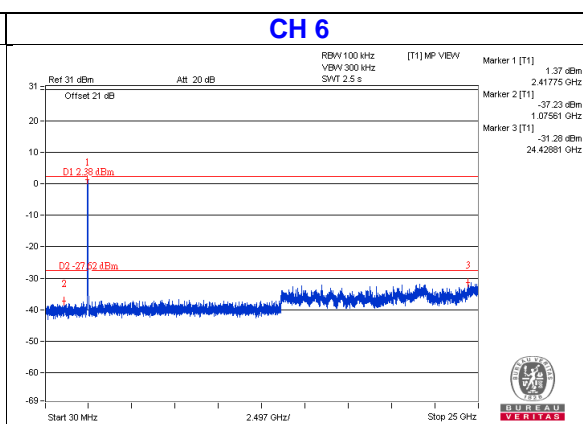
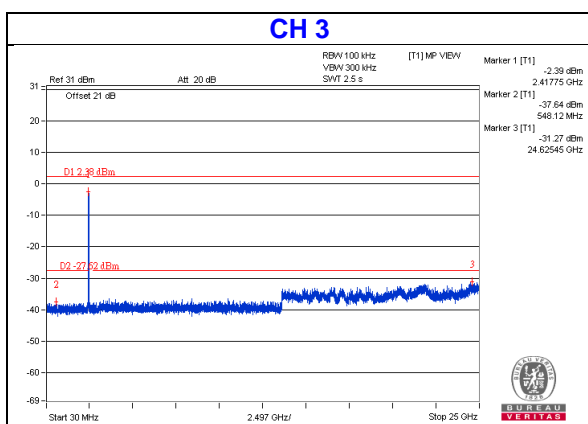
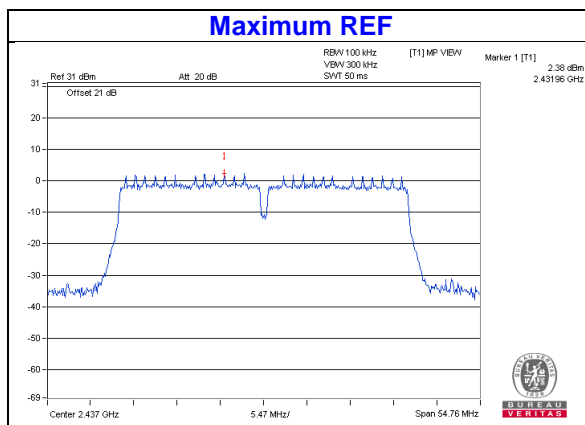

5 Pictures of Test Arrangements

Please refer to the attached file (Test Setup Photo).

Appendix – Information on the Testing Laboratories

We, Bureau Veritas Consumer Products Services (H.K.) Ltd., Taoyuan Branch, were founded in 1988 to provide our best service in EMC, Radio, Telecom and Safety consultation. Our laboratories are FCC recognized accredited test firms and accredited according to ISO/IEC 17025.

If you have any comments, please feel free to contact us at the following:

Linko EMC/RF Lab

Tel: 886-2-26052180

Fax: 886-2-26051924

Hsin Chu EMC/RF/Telecom Lab

Tel: 886-3-6668565

Fax: 886-3-6668323

Hwa Ya EMC/RF/Safety Lab

Tel: 886-3-3183232

Fax: 886-3-3270892

Email: service.adt@tw.bureauveritas.com

Web Site: www.bureauveritas-adt.com

The address and road map of all our labs can be found in our web site also.

--- END ---