

## FCC Test Report

**Report No.:** RF151230E03-4

**FCC ID:** 2AHBN-AP41

**Test Model:** AP41

**Series Model:** AP41E

**Received Date:** Dec. 23, 2015

**Test Date:** Jan. 08, 2016 (For AC Power Conducted Emissions of test mode A, B)  
Mar. 29, 2016 (For AC Power Conducted Emissions of test mode C, D)  
Feb. 25 ~ Jun. 07, 2016 (For all tests except AC Power Conducted Emissions)

**Issued Date:** Jun. 15, 2016

**Applicant:** Mist Systems, Inc.

**Address:** 1601 South De Anza Blvd. Suite 248 Cupertino California United States  
95014

**Issued By:** Bureau Veritas Consumer Products Services (H.K.) Ltd., Taoyuan Branch

**Lab Address:** No. 47-2, 14th Ling, Chia Pau Vil., Lin Kou Dist., New Taipei City, Taiwan,  
R.O.C.

**Test Location:** No. 19, Hwa Ya 2nd Rd., Wen Hwa Vil., Kwei Shan Dist., Taoyuan City  
33383, TAIWAN (R.O.C.)



This report is for your exclusive use. Any copying or replication of this report to or for any other person or entity, or use of our name or trademark, is permitted only with our prior written permission. This report sets forth our findings solely with respect to the test samples identified herein. The results set forth in this report are not indicative or representative of the quality or characteristics of the lot from which a test sample was taken or any similar or identical product unless specifically and expressly noted. Our report includes all of the tests requested by you and the results thereof based upon the information that you provided to us. You have 60 days from date of issuance of this report to notify us of any material error or omission caused by our negligence, provided, however, that such notice shall be in writing and shall specifically address the issue you wish to raise. A failure to raise such issue within the prescribed time shall constitute your unqualified acceptance of the completeness of this report, the tests conducted and the correctness of the report contents. Unless specifically mentioned, the uncertainty of measurement has been explicitly taken into account to declare the compliance or non-compliance to the specification. The report must not be used by the client to claim product certification, approval, or endorsement by TAF or any government agencies.

## Table of Contents

<b>Release Control Record</b> .....	<b>4</b>
<b>1 Certificate of Conformity</b> .....	<b>5</b>
<b>2 Summary of Test Results</b> .....	<b>6</b>
2.1 Measurement Uncertainty.....	6
2.2 Modification Record.....	6
<b>3 General Information</b> .....	<b>7</b>
3.1 General Description of EUT.....	7
3.2 Description of Test Modes.....	10
3.2.1 Test Mode Applicability and Tested Channel Detail.....	11
3.3 Duty Cycle of Test Signal.....	13
3.4 Description of Support Units.....	17
3.4.1 Configuration of System under Test.....	17
3.5 General Description of Applied Standards.....	18
<b>4 Test Types and Results</b> .....	<b>19</b>
4.1 Radiated Emission and Bandedge Measurement.....	19
4.1.1 Limits of Radiated Emission and Bandedge Measurement.....	19
4.1.2 Test Instruments.....	20
4.1.3 Test Procedures.....	21
4.1.4 Deviation from Test Standard.....	21
4.1.5 Test Setup.....	22
4.1.6 EUT Operating Conditions.....	22
4.1.7 Test Results.....	23
4.2 Conducted Emission Measurement.....	179
4.2.1 Limits of Conducted Emission Measurement.....	179
4.2.2 Test Instruments.....	179
4.2.3 Test Procedures.....	180
4.2.4 Deviation from Test Standard.....	180
4.2.5 Test Setup.....	181
4.2.6 EUT Operating Conditions.....	181
4.2.7 Test Results.....	182
4.3 Transmit Power Measurement.....	190
4.3.1 Limits of Transmit Power Measurement.....	190
4.3.2 Test Setup.....	190
4.3.3 Test Instruments.....	190
4.3.4 Test Procedure.....	191
4.3.5 Deviation from Test Standard.....	191
4.3.6 EUT Operating Conditions.....	191
4.3.7 Test Result.....	192
4.4 Peak Power Spectral Density Measurement.....	226
4.4.1 Limits of Peak Power Spectral Density Measurement.....	226
4.4.2 Test Setup.....	226
4.4.3 Test Instruments.....	226
4.4.4 Test Procedures.....	226
4.4.5 Deviation from Test Standard.....	226
4.4.6 EUT Operating Conditions.....	226
4.4.7 Test Results.....	227
4.5 Frequency Stability.....	238
4.5.1 Limits of Frequency Stability Measurement.....	238
4.5.2 Test Setup.....	238
4.5.3 Test Instruments.....	238
4.5.4 Test Procedure.....	238
4.5.5 Deviation from Test Standard.....	238
4.5.6 EUT Operating Condition.....	238

4.5.7 Test Results .....	239
<b>5 Pictures of Test Arrangements.....</b>	<b>243</b>
<b>Appendix – Information on the Testing Laboratories .....</b>	<b>244</b>

### Release Control Record

Issue No.	Description	Date Issued
RF151230E03-4	Original release	Jun. 15, 2016

## 1 Certificate of Conformity

**Product:** Premium Wi-Fi & BLE Array AP

**Brand:** Mist

**Test Model:** AP41

**Series Model:** AP41E

**Sample Status:** Engineering sample

**Applicant:** Mist Systems, Inc.

**Test Date:** Jan. 08, 2016 (For AC Power Conducted Emissions of test mode A, B)  
Mar. 29, 2016 (For AC Power Conducted Emissions of test mode C, D)  
Feb. 25 ~ Jun. 07, 2016 (For all tests except AC Power Conducted Emissions)

**Standards:** 47 CFR FCC Part 15, Subpart E (Section 15.407)  
ANSI C63.10:2013

The above equipment has been tested by **Bureau Veritas Consumer Products Services (H.K.) Ltd., Taoyuan Branch**, and found compliance with the requirement of the above standards. The test record, data evaluation & Equipment Under Test (EUT) configurations represented herein are true and accurate accounts of the measurements of the sample's EMC characteristics under the conditions specified in this report.

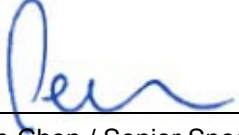
**Prepared by :**  , **Date:** Jun. 15, 2016  
Pettie Chen / Senior Specialist

**Approved by :**  , **Date:** Jun. 15, 2016  
Ken Liu / Senior Manager

## 2 Summary of Test Results

47 CFR FCC Part 15, Subpart E (SECTION 15.407)			
FCC Clause	Test Item	Result	Remarks
15.407(b)(6)	AC Power Conducted Emissions	Pass	Meet the requirement of limit. Minimum passing margin is -3.28dB at 0.38828MHz.
15.407(b) (1/2/3/4/6)	Radiated Emissions & Band Edge Measurement	Pass	Meet the requirement of limit. Minimum passing margin is -0.1dB at 5350.00, 5460.00, 5470.00, 5725.00MHz.
15.407(a)(1/2 /3)	Max Average Transmit Power	Pass	Meet the requirement of limit.
15.407(a)(1/2 /3)	Peak Power Spectral Density	Pass	Meet the requirement of limit.
15.407(g)	Frequency Stability	Pass	Meet the requirement of limit.
15.203	Antenna Requirement	Pass	For internal antenna: Antenna connector is IPEX not a standard connector. For external antenna: Antenna connector is RPSMA not a standard connector.

### 2.1 Measurement Uncertainty

Where relevant, the following measurement uncertainty levels have been estimated for tests performed on the EUT as specified in CISPR 16-4-2:

Measurement	Frequency	Expanded Uncertainty (k=2) ( $\pm$ )
Conducted Emissions at mains ports	150kHz ~ 30MHz	2.44 dB
Radiated Emissions up to 1 GHz	30MHz ~ 200MHz	3.59 dB
	200MHz ~ 1000MHz	3.60 dB
Radiated Emissions above 1 GHz	1GHz ~ 18GHz	2.29 dB
	18GHz ~ 40GHz	2.29 dB

### 2.2 Modification Record

There were no modifications required for compliance.

### 3 General Information

#### 3.1 General Description of EUT

Product	Premium Wi-Fi & BLE Array AP
Brand	Mist
Test Model	AP41
Series Model	AP41E
Model Difference	AP41 for internal antenna AP41E for external antenna
Status of EUT	Engineering sample
Power Supply Rating	12Vdc from adapter 55Vdc from PoE
Modulation Type	256QAM, 64QAM, 16QAM, QPSK, BPSK
Modulation Technology	OFDM
Transfer Rate	802.11a: 54.0/ 48.0/ 36.0/ 24.0/ 18.0/ 12.0/ 9.0/ 6.0Mbps 802.11n: up to 600.0Mbps 802.11ac: up to 1733.3Mbps
Operating Frequency	5260 ~ 5320MHz, 5500 ~ 5700MHz
Number of Channel	5260 ~ 5320MHz: 4 for 802.11a, 802.11n (HT20), 802.11ac (VHT20) 2 for 802.11n (HT40), 802.11ac (VHT40) 1 for 802.11ac (VHT80) 5500 ~ 5700MHz: 11 for 802.11a, 802.11n (HT20), 802.11ac (VHT20) 5 for 802.11n (HT40), 802.11ac (VHT40) 2 for 802.11ac (VHT80)
Output Power	Radio 1: 1TX 5260 ~ 5320MHz: 220.293mW 5500 ~ 5700MHz: 238.232mW 2TX 5260 ~ 5320MHz: 141.447mW 5500 ~ 5700MHz: 147.931mW 3TX 5260 ~ 5320MHz: 80.071mW 5500 ~ 5700MHz: 87.039mW 4TX 5260 ~ 5320MHz: 62.315mW 5500 ~ 5700MHz: 63.202mW
Antenna Type	Refer to Note
Antenna Connector	Refer to Note
Accessory Device	N/A
Data Cable Supplied	N/A

**Note:**

1. This report is prepared for FCC class II permissive change. This report is issued as a supplementary report of the original report no.: RF151230E03B-1. The differences compared with original report are updating firmware to close Radio 2 TX function and adding 5.26GHz to 5.32GHz and 5.50GHz to 5.70GHz by software.

2. There are three radios for the EUT.

Radio	Brand	Model	Function	TX/RX Function
Radio 1	Broadcom	BCM43465	WLAN 2.4G & 5G	TX/RX
Radio 2	Broadcom	BCM43465	WLAN 2.4G & 5G	RX only
Radio 3	Broadcom	BCM20704	BT EDR & BT LE	TX/RX

3. The EUT incorporates a MIMO function. Physically, the EUT provides 4 completed transmitters and 4 receivers.

Modulation Mode	TX Function	Beamforming
<b>Radio 1</b>		
802.11a	1TX/2TX/3TX/4TX	Not Support
802.11n (HT20)	1TX/2TX/3TX/4TX	Support
802.11n (HT40)	1TX/2TX/3TX/4TX	Support
802.11ac (VHT20)	1TX/2TX/3TX/4TX	Support
802.11ac (VHT40)	1TX/2TX/3TX/4TX	Support
802.11ac (VHT80)	1TX/2TX/3TX/4TX	Support

\*The worst case of Radio 1 is beamforming on mode for the final tests.

\*The modulation and bandwidth are similar for 802.11n mode for HT20 / HT40 and 802.11ac mode for VHT20 / VHT40, therefore investigated worst case to representative mode in test report. (Final test mode refer section 3.2.1)

\*The worst configuration is as below.

Mode	Chain
Radio 1 / 1TX	Chain 0
Radio 1 / 2TX	Chain 0 + 1
Radio 1 / 3TX	Chain 0 + 1 + 2
Radio 1 / 4TX	Chain 0 + 1 + 2 + 3

4. The EUT uses following adapter & PoE. (Support unit only)

Adapter	
Brand	Channel Well Technology
Model	2ABN036F US
Input Power	100-240Vac~50/60Hz 1.0A
Output Power	12.0Vdc / 3.0A
Power Line	1.45m DC cable without core attached on adapter

PoE	
Brand	Microsemi
Model	PD-9001GR/AT/AC
Input Power	100-240Vac~50/60Hz 0.67A
Output Power	55Vdc / 0.6A



5. The following antennas were provided to the EUT.

Antenna Type	PIFA				
Antenna Connector	IPEX				
Gain (dBi)	Frequency				
	2.4~2.4835GHz	5.15~5.25GHz	5.25~5.35GHz	5.47~5.725GHz	5.725~5.85GHz
Int. WIFI Ant. 1	3.06	3.85	3.97	4.21	4.18
Int. WIFI Ant. 2	3.64	4.49	4.21	3.27	3.99
Int. WIFI Ant. 3	3.37	3.50	4.04	4.14	4.34
Int. WIFI Ant. 4	3.54	3.87	3.77	4.02	4.17
Scanning Radio Ant.	3.61	3.59	4.21	4.43	4.29

Antenna Type	Patch				
Antenna Connector	RPSMA				
Gain (dBi)	Frequency				
	2.4~2.4835GHz	5.15~5.25GHz	5.25~5.35GHz	5.47~5.725GHz	5.725~5.85GHz
Ext. WIFI Ant.	4	6	6	6	6

\*Int. WIFI Ant. 1~4, Ext. WIFI Ant. were for Radio 1.

\*Scanning Radio Ant. was for Radio 2

\*For Radio 1: The EUT with Patch antenna was chosen for Antenna Port Conducted Measurement test.

### 3.2 Description of Test Modes

#### For 5260 ~ 5320MHz

4 channels are provided for 802.11a, 802.11n (HT20), 802.11ac (VHT20):

Channel	Frequency	Channel	Frequency
52	5260 MHz	60	5300 MHz
56	5280 MHz	64	5320 MHz

2 channels are provided for 802.11n (HT40), 802.11ac (VHT40):

Channel	Frequency	Channel	Frequency
54	5270 MHz	62	5310 MHz

1 channel is provided for 802.11ac (VHT80):

Channel	Frequency
58	5290 MHz

#### For 5500 ~ 5700MHz

11 channels are provided for 802.11a, 802.11n (HT20), 802.11ac (VHT20):

Channel	Frequency	Channel	Frequency
100	5500 MHz	124	5620 MHz
104	5520 MHz	128	5640 MHz
108	5540 MHz	132	5660 MHz
112	5560 MHz	136	5680 MHz
116	5580 MHz	140	5700 MHz
120	5600 MHz		

5 channels are provided for 802.11n (HT40), 802.11ac (VHT40):

Channel	Frequency	Channel	Frequency
102	5510 MHz	126	5630 MHz
110	5550 MHz	134	5670 MHz
118	5590 MHz		

2 channels are provided for 802.11ac (VHT80):

Channel	Frequency	Channel	Frequency
106	5530MHz	122	5610 MHz

### 3.2.1 Test Mode Applicability and Tested Channel Detail

EUT CONFIGURE MODE	APPLICABLE TO				DESCRIPTION	
	RE $\geq$ 1G	RE<1G	PLC	APCM	Antenna	Radio
A	-	√	√	-	EUT with internal antenna	Radio 1 (Power from adapter)
B	√	√	√	-		Radio 1 (Power from PoE)
C	-	√	√	√	EUT with external antenna	Radio 1 (Power from adapter)
D	√	√	√	-		Radio 1 (Power from PoE)

Where **RE $\geq$ 1G**: Radiated Emission above 1GHz & Bandedge Measurement      **RE<1G**: Radiated Emission below 1GHz  
**PLC**: Power Line Conducted Emission      **APCM**: Antenna Port Conducted Measurement

**NOTE:** 1. The EUT could just position on the Z-plane according to manufacturer's requirement.  
2. "-" means no effect.

#### **Radiated Emission Test (Above 1GHz):**

- Pre-Scan has been conducted to determine the worst-case mode from all possible combinations between available modulations, data rates and antenna ports (if EUT with antenna diversity architecture).
- Following channel(s) was (were) selected for the final test as listed below.

EUT CONFIGURE MODE	MODE	FREQ. BAND (MHz)	AVAILABLE CHANNEL	TESTED CHANNEL	MODULATION TECHNOLOGY	MODULATION TYPE	DATA RATE (Mbps)
B, D	802.11a	5260-5320	52 to 64	52, 60, 64	OFDM	BPSK	6.0
B, D	802.11n (HT20)		52 to 64	52, 60, 64	OFDM	BPSK	6.5
B, D	802.11n (HT40)		54 to 62	54, 62	OFDM	BPSK	13.5
B, D	802.11ac (VHT80)		58	58	OFDM	BPSK	29.3
B, D	802.11a	5500-5700	100 to 140	100, 116, 140	OFDM	BPSK	6.0
B, D	802.11n (HT20)		100 to 140	100, 116, 140	OFDM	BPSK	6.5
B, D	802.11n (HT40)		102 to 134	102, 110, 134	OFDM	BPSK	13.5
B, D	802.11ac (VHT80)		106 to 122	106	OFDM	BPSK	29.3

#### **Radiated Emission Test (Below 1GHz):**

- Pre-Scan has been conducted to determine the worst-case mode from all possible combinations between available modulations, data rates and antenna ports (if EUT with antenna diversity architecture).
- Following channel(s) was (were) selected for the final test as listed below.

EUT CONFIGURE MODE	MODE	FREQ. BAND (MHz)	AVAILABLE CHANNEL	TESTED CHANNEL	MODULATION TECHNOLOGY	MODULATION TYPE	DATA RATE (Mbps)
A, B, C, D	802.11a	5260-5320	52 to 64	52	OFDM	BPSK	6.0
	802.11a	5500-5700	100 to 140		OFDM	BPSK	6.0

### Power Line Conducted Emission Test:

- Pre-Scan has been conducted to determine the worst-case mode from all possible combinations between available modulations, data rates and antenna ports (if EUT with antenna diversity architecture).
- Following channel(s) was (were) selected for the final test as listed below.

EUT CONFIGURE MODE	MODE	FREQ. BAND (MHz)	AVAILABLE CHANNEL	TESTED CHANNEL	MODULATION TECHNOLOGY	MODULATION TYPE	DATA RATE (Mbps)
A, B, C, D	802.11a	5260-5320	52 to 64	52	OFDM	BPSK	6.0
	802.11a	5500-5700	100 to 140		OFDM	BPSK	6.0

### Antenna Port Conducted Measurement:

- This item includes all test value of each mode, but only includes spectrum plot of worst value of each mode.
- Pre-Scan has been conducted to determine the worst-case mode from all possible combinations between available modulations, data rates and antenna ports (if EUT with antenna diversity architecture).
- Following channel(s) was (were) selected for the final test as listed below.

EUT CONFIGURE MODE	MODE	FREQ. BAND (MHz)	AVAILABLE CHANNEL	TESTED CHANNEL	MODULATION TECHNOLOGY	MODULATION TYPE	DATA RATE (Mbps)
C	802.11a	5260-5320	52 to 64	52, 60, 64	OFDM	BPSK	6.0
C	802.11n (HT20)		52 to 64	52, 60, 64	OFDM	BPSK	6.5
C	802.11n (HT40)		54 to 62	54, 62	OFDM	BPSK	13.5
C	802.11ac (VHT80)		58	58	OFDM	BPSK	29.3
C	802.11a	5500-5700	100 to 140	100, 116, 140	OFDM	BPSK	6.0
C	802.11n (HT20)		100 to 140	100, 116, 140	OFDM	BPSK	6.5
C	802.11n (HT40)		102 to 134	102, 110, 134	OFDM	BPSK	13.5
C	802.11ac (VHT80)		106 to 122	106	OFDM	BPSK	29.3

### Test Condition:

APPLICABLE TO	ENVIRONMENTAL CONDITIONS	INPUT POWER	TESTED BY
<b>RE<sub>≥</sub>1G</b>	23deg. C, 66%RH 22deg. C, 64%RH 24deg. C, 63%RH 24deg. C, 64%RH 24deg. C, 65%RH	120Vac, 60Hz	Chris Lin Alan Wu
<b>RE&lt;1G</b>	25deg. C, 66%RH 25deg. C, 65%RH	120Vac, 60Hz 55Vdc	Alan Wu Chris Lin
<b>PLC</b>	25deg. C, 65%RH	120Vac, 60Hz 55Vdc	Chris Lin
<b>APCM</b>	25deg. C, 60%RH	120Vac, 60Hz	Leo Tsai Ted Chang

### 3.3 Duty Cycle of Test Signal

#### Radio 1:

#### 1TX

Duty cycle of test signal is > 98%, duty factor is not required

Duty cycle of test signal is < 98%, duty factor is required

**802.11a:** Duty cycle =  $2.063/2.104 = 0.981$

**802.11n (HT20):** Duty cycle =  $1.918/1.939 = 0.989$

**802.11n (HT40):** Duty cycle =  $0.943/0.963 = 0.979$ , Duty factor =  $10 * \log(1/0.979) = 0.09$

**802.11ac (VHT80):** Duty cycle =  $0.459/0.478 = 0.96$ , Duty factor =  $10 * \log(1/0.96) = 0.18$

#### 802.11a

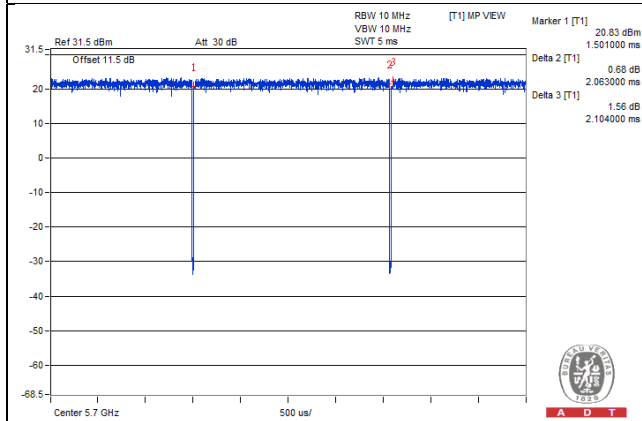

#### 802.11n (HT20)

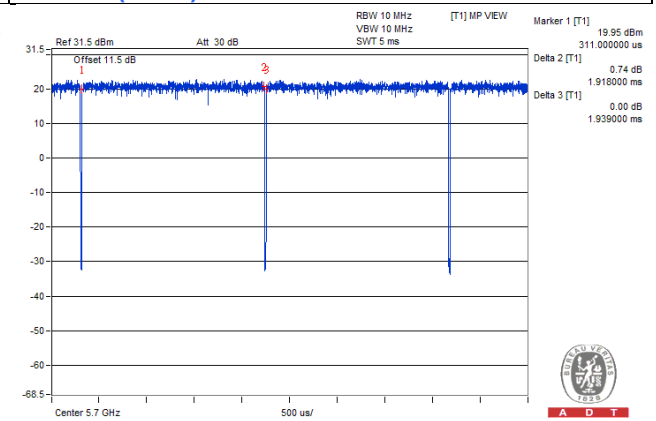

#### 802.11n (HT40)

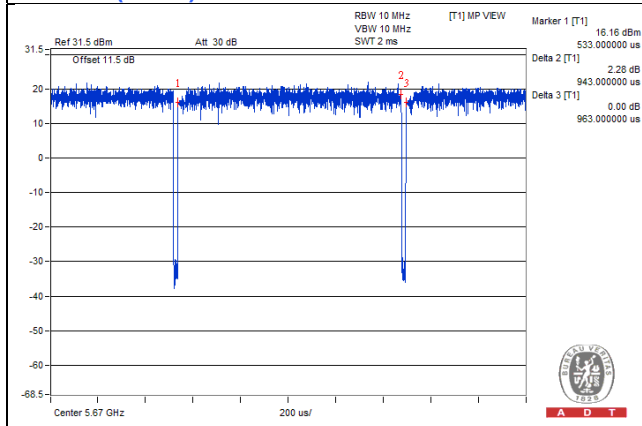

#### 802.11ac (VHT80)

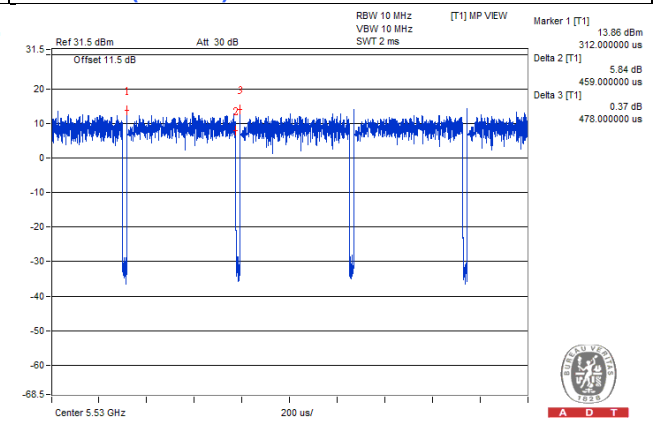

## 2TX

Duty cycle of test signal is > 98%, duty factor is not required

Duty cycle of test signal is < 98%, duty factor is required

**802.11a**: Duty cycle =  $2.061/2.111 = 0.976$ , Duty factor =  $10 * \log(1/0.976) = 0.10$

**802.11n (HT20)**: Duty cycle =  $1.917/1.945 = 0.985$

**802.11n (HT40)**: Duty cycle =  $0.944/0.972 = 0.971$ , Duty factor =  $10 * \log(1/0.971) = 0.13$

**802.11ac (VHT80)**: Duty cycle =  $0.461/0.479 = 0.962$ , Duty factor =  $10 * \log(1/0.962) = 0.17$

### 802.11a

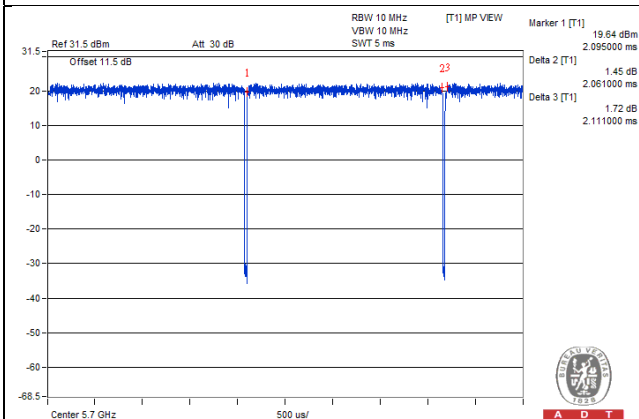

### 802.11n (HT20)

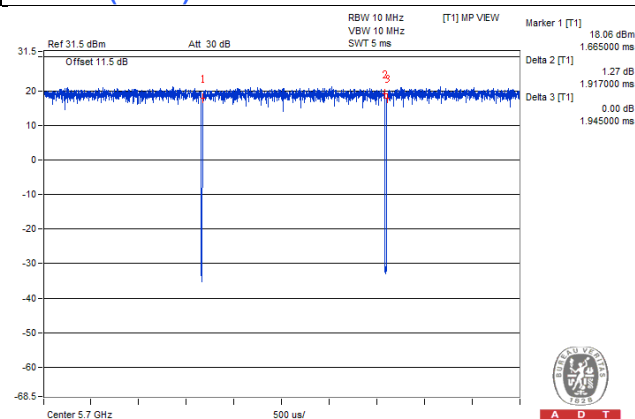

### 802.11n (HT40)

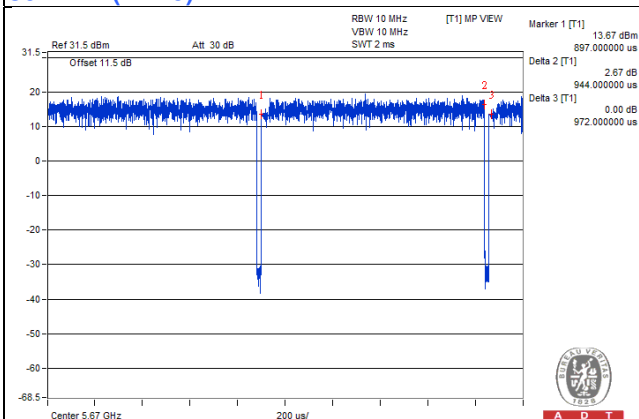

### 802.11ac (VHT80)

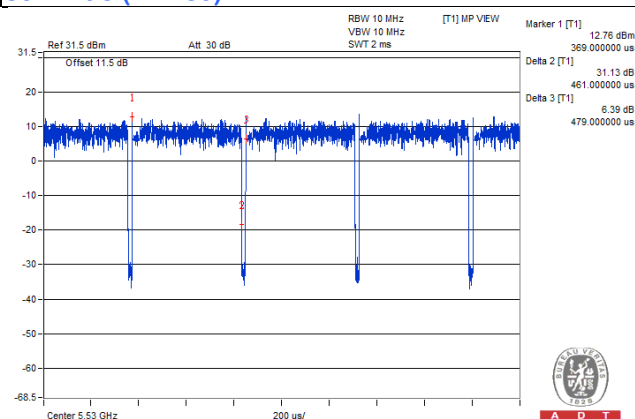

### 3TX

Duty cycle of test signal is > 98%, duty factor is not required

Duty cycle of test signal is < 98%, duty factor is required

**802.11a**: Duty cycle =  $2.062/2.096 = 0.984$

**802.11n (HT20)**: Duty cycle =  $1.919/1.948 = 0.985$

**802.11n (HT40)**: Duty cycle =  $0.943/0.972 = 0.97$ , Duty factor =  $10 * \log(1/0.97) = 0.13$

**802.11ac (VHT80)**: Duty cycle =  $0.459/0.478 = 0.96$ , Duty factor =  $10 * \log(1/0.96) = 0.18$

#### 802.11a

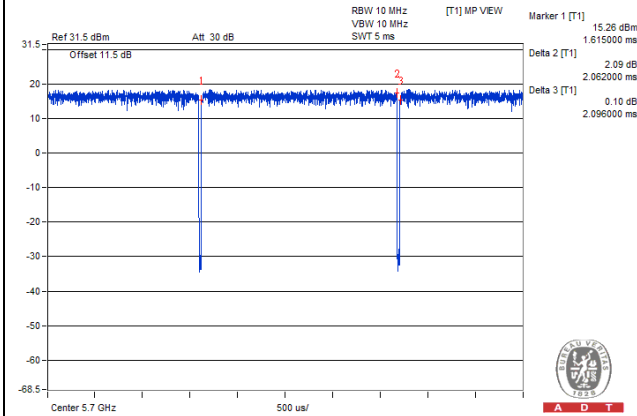

#### 802.11n (HT20)

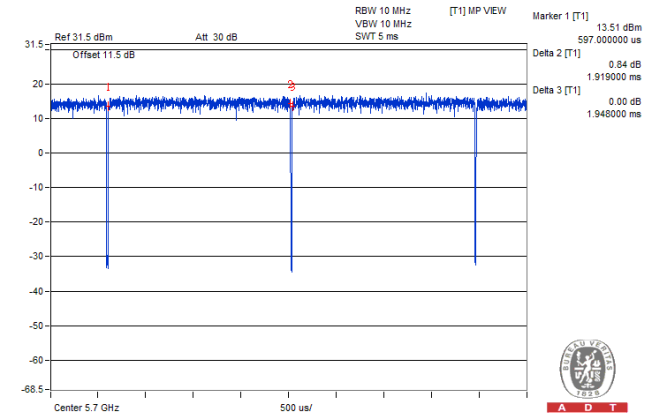

#### 802.11n (HT40)

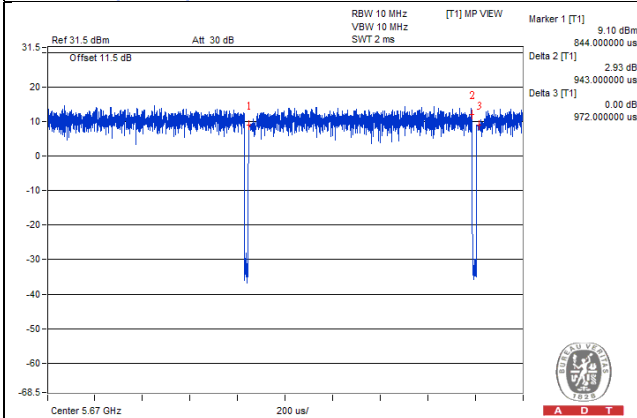

#### 802.11ac (VHT80)

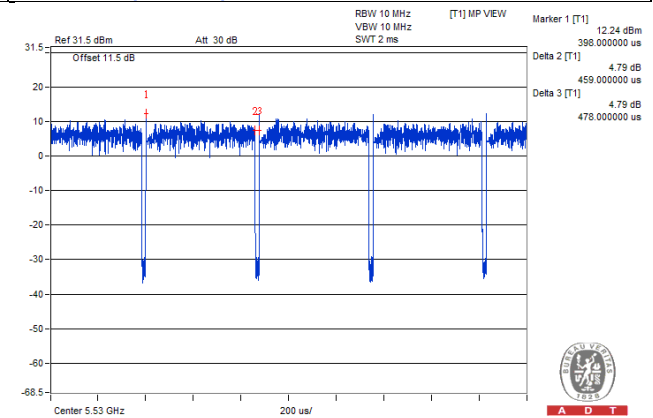

### 4TX

Duty cycle of test signal is > 98%, duty factor is not required

Duty cycle of test signal is < 98%, duty factor is required

**802.11a:** Duty cycle =  $2.06/2.118 = 0.973$ , Duty factor =  $10 * \log(1/0.973) = 0.12$

**802.11n (HT20):** Duty cycle =  $1.912/1.947 = 0.982$

**802.11n (HT40):** Duty cycle =  $0.937/0.992 = 0.945$ , Duty factor =  $10 * \log(1/0.945) = 0.25$

**802.11ac (VHT80):** Duty cycle =  $0.46/0.49 = 0.939$ , Duty factor =  $10 * \log(1/0.939) = 0.27$

#### 802.11a

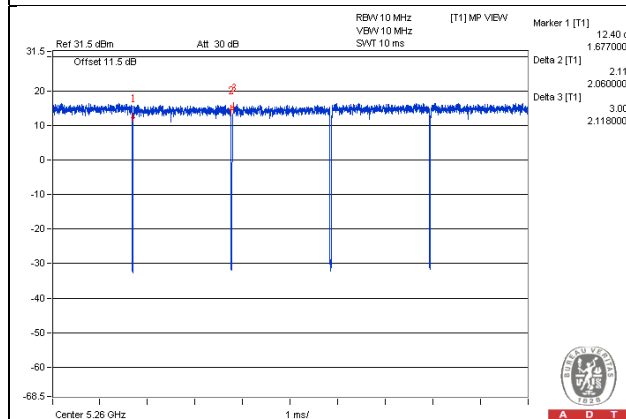

#### 802.11n (HT20)

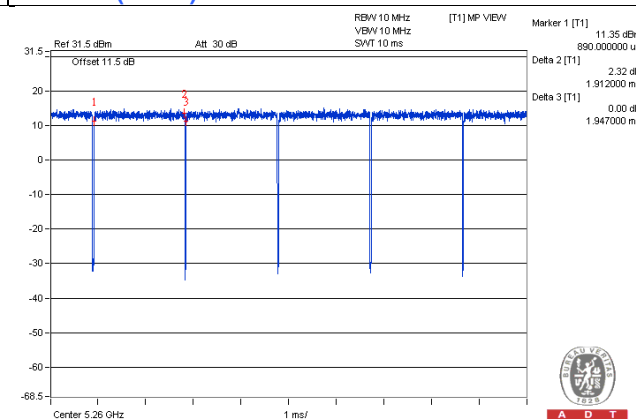

#### 802.11n (HT40)

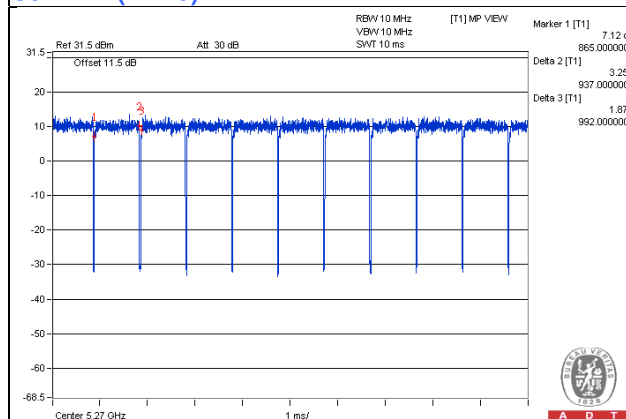

#### 802.11ac (VHT80)

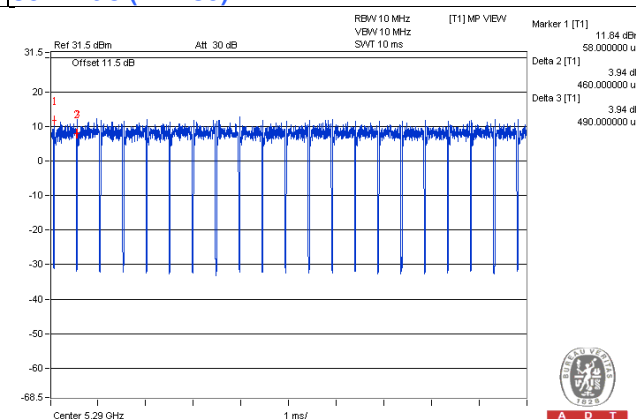



### 3.4 Description of Support Units

The EUT has been tested as an independent unit together with other necessary accessories or support units. The following support units or accessories were used to form a representative test configuration during the tests.

ID	Product	Brand	Model No.	Serial No.	FCC ID	Remarks
A.	Notebook	DELL	E5410	6RP2YM1	FCC DoC Approved	-
B.	USB 3.0 Flash Drive	HP	v250w	N/A	FCC DoC Approved	-
C.	Adapter	Channel Well Technology	2ABN036F US	N/A	N/A	Provided by client
D.	Load	N/A	N/A	N/A	N/A	-
E.	PoE	Microsemi	PD-9001GR/AT/AC	N/A	N/A	Provided by client

Note:

1. All power cords of the above support units are non-shielded (1.8m).
2. Items A acted as communication partners to transfer data.

ID	Descriptions	Qty.	Length (m)	Shielding (Yes/No)	Cores (Qty.)	Remarks
1.	RJ45 cable	1	10	N	0	-
2.	RJ45 cable	2	1.8	N	0	-
3.	DC cable	1	1.45	-	0	attached on adapter
4.	RJ45 cable	1	3	N	0	-

Note: The core(s) is(are) originally attached to the cable(s).

#### 3.4.1 Configuration of System under Test

Test Mode A, C

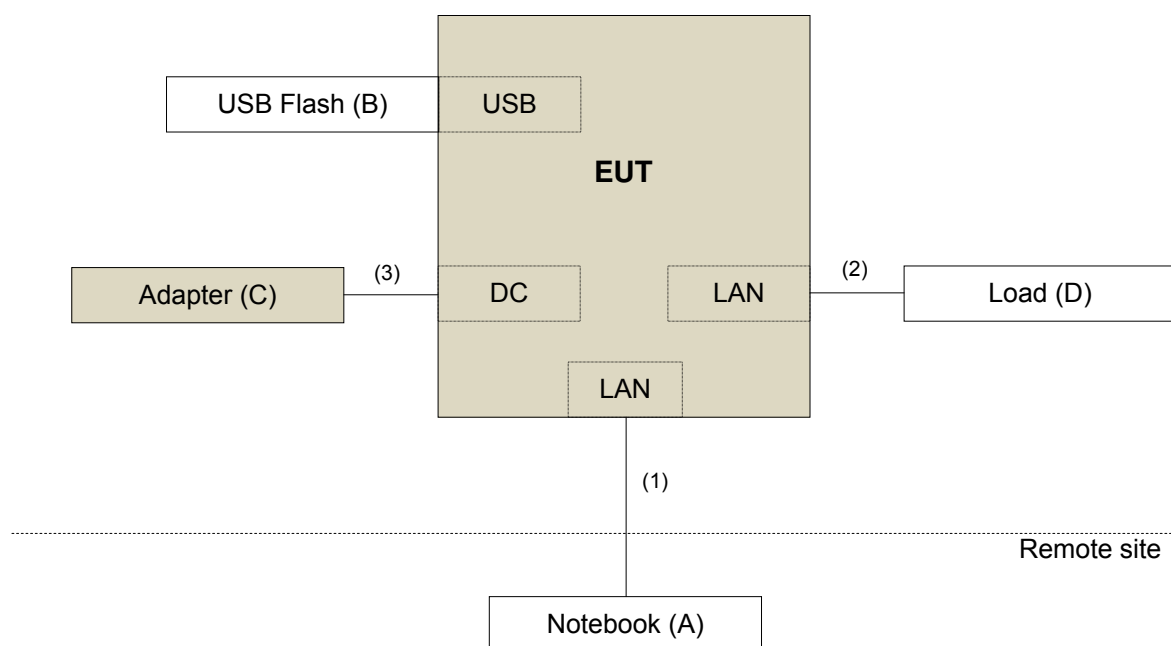

Test Mode B, D

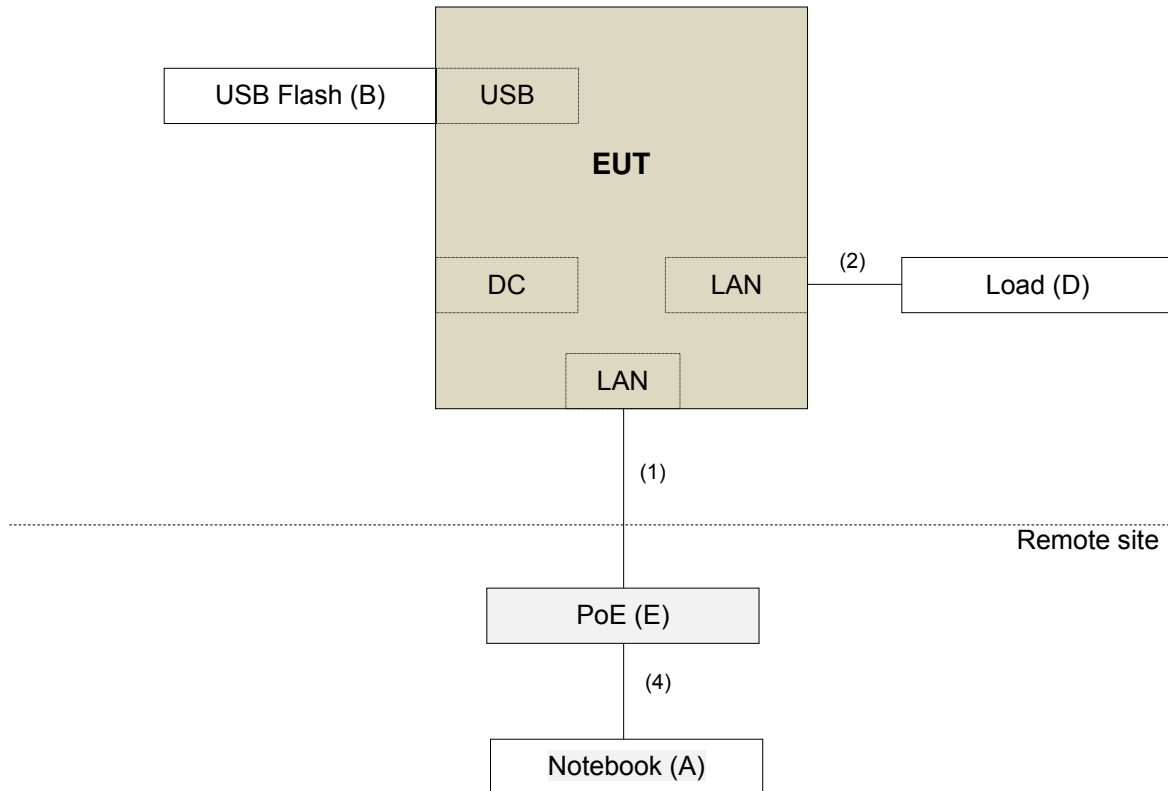

### 3.5 General Description of Applied Standards

The EUT is a RF Product. According to the specifications of the manufacturer, it must comply with the requirements of the following standards:

**FCC Part 15, Subpart E (15.407)**

**KDB 789033 D02 General UNII Test Procedures New Rules v01r02**

**KDB 662911 D01 Multiple Transmitter Output v02r01**

ANSI C63.10-2013

All test items have been performed and recorded as per the above standards.

**NOTE:** The EUT has been verified to comply with the requirements of FCC Part 15, Subpart B, Class B (DoC). The test report has been issued separately.

## 4 Test Types and Results

### 4.1 Radiated Emission and Bandedge Measurement

#### 4.1.1 Limits of Radiated Emission and Bandedge Measurement

Radiated emissions which fall in the restricted bands must comply with the radiated emission limits specified as below table.

Frequencies (MHz)	Field Strength (microvolts/meter)	Measurement Distance (meters)
0.009 ~ 0.490	2400/F(kHz)	300
0.490 ~ 1.705	24000/F(kHz)	30
1.705 ~ 30.0	30	30
30 ~ 88	100	3
88 ~ 216	150	3
216 ~ 960	200	3
Above 960	500	3

#### NOTE:

1. The lower limit shall apply at the transition frequencies.
2. Emission level (dBuV/m) = 20 log Emission level (uV/m).
3. For frequencies above 1000MHz, the field strength limits are based on average detector, however, the peak field strength of any emission shall not exceed the maximum permitted average limits, specified above by more than 20dB under any condition of modulation.

#### LIMITS OF UNWANTED EMISSION OUT OF THE RESTRICTED BANDS

APPLICABLE TO	LIMIT	
789033 D02 General UNII Test Procedures New Rules v01r02	FIELD STRENGTH AT 3m	
	PK:74 (dBuV/m)	AV:54 (dBuV/m)
APPLICABLE TO	EIRP LIMIT	EQUIVALENT FIELD STRENGTH AT 3m
15.407(b)(1)	PK:-27 (dBm/MHz)	PK:68.2 (dBuV/m)
15.407(b)(2)		
15.407(b)(3)		
15.407(b)(4)	PK:-27 (dBm/MHz) <sup>*1</sup> PK:-17 (dBm/MHz) <sup>*2</sup>	PK:68.2 (dBuV/m) <sup>*1</sup> PK:78.2 (dBuV/m) <sup>*2</sup>

**NOTE:** <sup>\*1</sup> beyond 10MHz of the band edge <sup>\*2</sup> within 10 MHz of band edge

The following formula is used to convert the equipment isotropic radiated power (eirp) to field strength:

$$E = \frac{1000000\sqrt{30P}}{3} \mu\text{V/m, where P is the eirp (Watts).}$$

#### 4.1.2 Test Instruments

Description & Manufacturer	Model No.	Serial No.	Date Of Calibration	Due Date Of Calibration
Test Receiver ROHDE & SCHWARZ	ESCI	100424	Oct. 12, 2015	Oct. 11, 2016
Spectrum Analyzer ROHDE & SCHWARZ	FSP40	100040	Jul. 08, 2015	Jul. 07, 2016
BILOG Antenna SCHWARZBECK	VULB9168	9168-155	Jan. 07, 2016	Jan. 06, 2017
HORN Antenna SCHWARZBECK	BBHA 9120D	9120D-1170	Jan. 08, 2016	Jan. 07, 2017
HORN Antenna SCHWARZBECK	BBHA 9170	BBHA9170241	Jan. 18, 2016	Jan. 17, 2017
Preamplifier Agilent	8449B	3008A01960	Aug. 09, 2015	Aug. 08, 2016
Preamplifier Agilent	8447D	2944A10631	Aug. 09, 2015	Aug. 08, 2016
RF signal cable HUBER+SUHNER	SUCOFLEX 104	Cable-CH4-02(295 012+309220)	Aug. 09, 2015	Aug. 08, 2016
RF signal cable HUBER+SUHNER	SUCOFLEX 104	Cable-CH4-03(250 724)	Aug. 09, 2015	Aug. 08, 2016
Software BV ADT	ADT_Radiated_ V7.6.15.9.4	NA	NA	NA
Antenna Tower inn-co GmbH	MA 4000	010303	NA	NA
Antenna Tower Controller BV ADT	AT100	AT93021703	NA	NA
Turn Table BV ADT	TT100	TT93021703	NA	NA
Turn Table Controller BV ADT	SC100.	SC93021703	NA	NA
26GHz ~ 40GHz Amplifier	EM26400	815221	Oct. 18, 2015	Oct. 17, 2016
High Speed Peak Power Meter	ML2495A	0824011	Jul. 09, 2015	Jul. 08, 2016
Power Sensor	MA2411B	0738171	Jul. 09, 2015	Jul. 08, 2016
AC Power Supply Extech	CFW-105	E000603	NA	NA

- Note:
1. The calibration interval of the above test instruments is 12 months and the calibrations are traceable to NML/ROC and NIST/USA.
  2. The test was performed in HwaYa Chamber 4.
  3. The horn antenna and preamplifier (model: 8449B) are used only for the measurement of emission frequency above 1GHz if tested.
  4. The FCC Site Registration No. is 460141.
  5. The IC Site Registration No. is IC7450F-4.

#### 4.1.3 Test Procedures

- a. The EUT was placed on the top of a rotating table 0.8 meters (for below 1GHz) / 1.5 meters (for above 1GHz) above the ground at 3 meter chamber room for test. The table was rotated 360 degrees to determine the position of the highest radiation.
- b. The EUT was set 3 meters away from the interference-receiving antenna, which was mounted on the top of a variable-height antenna tower.
- c. The height of antenna is varied from one meter to four meters above the ground to determine the maximum value of the field strength. Both horizontal and vertical polarizations of the antenna are set to make the measurement.
- d. For each suspected emission, the EUT was arranged to its worst case and then the antenna was tuned to heights from 1 meter to 4 meters and the rotatable table was turned from 0 degrees to 360 degrees to find the maximum reading.
- e. The test-receiver system was set to quasi-peak detect function and specified bandwidth with maximum hold mode when the test frequency is below 1 GHz.
- f. The test-receiver system was set to peak and average detect function and specified bandwidth with maximum hold mode when the test frequency is above 1 GHz. If the peak reading value also meets average limit, measurement with the average detector is unnecessary.

**Note:**

1. The resolution bandwidth and video bandwidth of test receiver/spectrum analyzer is 120kHz for Quasi-peak detection (QP) at frequency below 1GHz.
2. The resolution bandwidth of test receiver/spectrum analyzer is 1 MHz and the video bandwidth is 3 MHz for Peak detection (PK) at frequency above 1GHz.
3. The resolution bandwidth of test receiver/spectrum analyzer is 1MHz and the video bandwidth is 3MHz for RMS Average (Duty cycle < 98%) for Average detection (AV) at frequency above 1GHz, then the measurement results was added to a correction factor ( $10 \log(1/\text{duty cycle})$ ).
4. The resolution bandwidth of test receiver/spectrum analyzer is 1MHz and the video bandwidth is 10Hz (Duty cycle  $\geq 98\%$ ) for Average detection (AV) at frequency above 1GHz.
5. All modes of operation were investigated and the worst-case emissions are reported.

#### 4.1.4 Deviation from Test Standard

No deviation.

#### 4.1.5 Test Setup

<Frequency Range 30MHz ~ 1GHz>

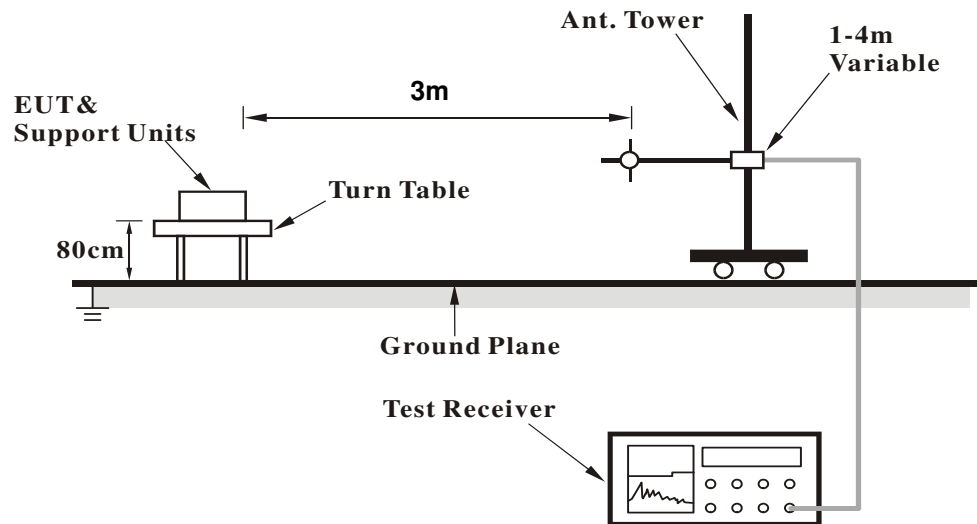

<Frequency Range above 1GHz>

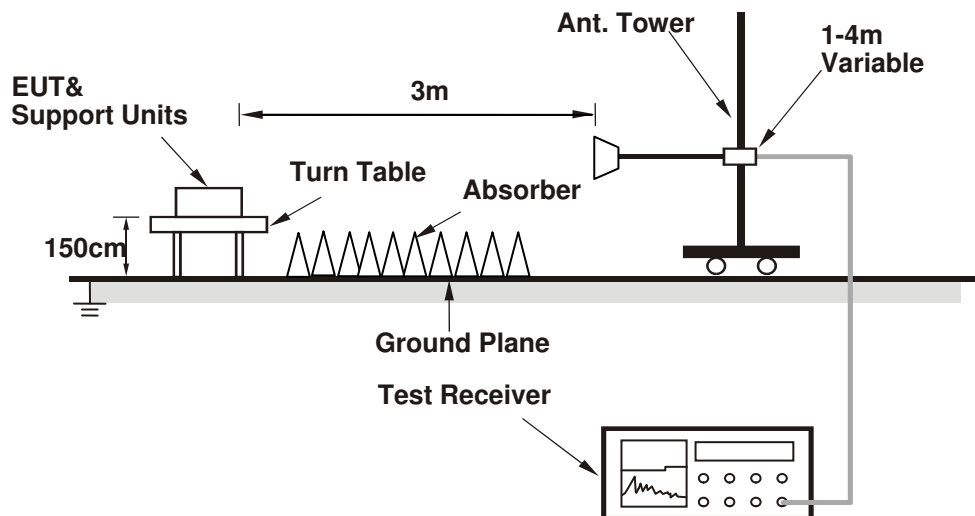

For the actual test configuration, please refer to the attached file (Test Setup Photo)

#### 4.1.6 EUT Operating Conditions

- Placed the EUT on the testing table.
- Prepared notebook to act as communication partner and placed it outside of testing area.
- The communication partner connected with EUT via a RJ45 cable and ran a test program (provided by manufacturer) to enable EUT under transmission condition continuously at specific channel frequency.
- The communication partner sent data to EUT by command "PING".
- The necessary accessories enable the system in full functions.

#### 4.1.7 Test Results

Above 1GHz data:

Test Mode B

1TX

802.11a

CHANNEL	TX Channel 52	DETECTOR FUNCTION	Peak (PK)
FREQUENCY RANGE	1GHz ~ 40GHz		Average (AV)

ANTENNA POLARITY & TEST DISTANCE: HORIZONTAL AT 3 M								
NO.	FREQ. (MHz)	EMISSION LEVEL (dBuV/m)	LIMIT (dBuV/m)	MARGIN (dB)	ANTENNA HEIGHT (m)	TABLE ANGLE (Degree)	RAW VALUE (dBuV)	CORRECTION FACTOR (dB/m)
1	5150.00	55.5 PK	74.0	-18.5	1.15 H	10	50.00	5.50
2	5150.00	44.3 AV	54.0	-9.7	1.15 H	10	38.80	5.50
3	*5260.00	109.7 PK			1.38 H	52	70.10	39.60
4	*5260.00	100.0 AV			1.38 H	52	60.40	39.60
5	#10520.00	58.2 PK	74.0	-15.8	1.47 H	87	40.10	18.10
6	#10520.00	45.6 AV	54.0	-8.4	1.47 H	87	27.50	18.10

ANTENNA POLARITY & TEST DISTANCE: VERTICAL AT 3 M								
NO.	FREQ. (MHz)	EMISSION LEVEL (dBuV/m)	LIMIT (dBuV/m)	MARGIN (dB)	ANTENNA HEIGHT (m)	TABLE ANGLE (Degree)	RAW VALUE (dBuV)	CORRECTION FACTOR (dB/m)
1	5150.00	56.7 PK	74.0	-17.3	1.26 V	50	51.20	5.50
2	5150.00	46.4 AV	54.0	-7.6	1.26 V	50	40.90	5.50
3	*5260.00	113.5 PK			1.19 V	45	73.90	39.60
4	*5260.00	102.9 AV			1.19 V	45	63.30	39.60
5	#10520.00	59.7 PK	74.0	-14.3	1.47 V	87	41.60	18.10
6	#10520.00	46.5 AV	54.0	-7.5	1.47 V	87	28.40	18.10

#### REMARKS:

1. Emission Level(dBuV/m) = Raw Value(dBuV) + Correction Factor(dB/m)
2. Correction Factor(dB/m) = Antenna Factor(dB/m) + Cable Factor(dB) – Pre-Amplifier Factor(dB)
3. The other emission levels were very low against the limit.
4. Margin value = Emission Level – Limit value
5. " \* ": Fundamental frequency.
6. " # ": The radiated frequency is out of the restricted band.

CHANNEL	TX Channel 60	DETECTOR FUNCTION	Peak (PK)
FREQUENCY RANGE	1GHz ~ 40GHz		Average (AV)

**ANTENNA POLARITY & TEST DISTANCE: HORIZONTAL AT 3 M**

NO.	FREQ. (MHz)	EMISSION LEVEL (dBuV/m)	LIMIT (dBuV/m)	MARGIN (dB)	ANTENNA HEIGHT (m)	TABLE ANGLE (Degree)	RAW VALUE (dBuV)	CORRECTION FACTOR (dB/m)
1	*5300.00	110.2 PK			2.04 H	54	70.60	39.60
2	*5300.00	99.7 AV			2.04 H	54	60.10	39.60
3	10600.00	58.4 PK	74.0	-15.6	1.47 H	41	40.00	18.40
4	10600.00	45.8 AV	54.0	-8.2	1.47 H	41	27.40	18.40

**ANTENNA POLARITY & TEST DISTANCE: VERTICAL AT 3 M**

NO.	FREQ. (MHz)	EMISSION LEVEL (dBuV/m)	LIMIT (dBuV/m)	MARGIN (dB)	ANTENNA HEIGHT (m)	TABLE ANGLE (Degree)	RAW VALUE (dBuV)	CORRECTION FACTOR (dB/m)
1	*5300.00	112.9 PK			1.92 V	322	73.30	39.60
2	*5300.00	103.1 AV			1.92 V	322	63.50	39.60
3	10600.00	61.0 PK	74.0	-13.0	1.45 V	87	42.60	18.40
4	10600.00	47.1 AV	54.0	-6.9	1.45 V	87	28.70	18.40

**REMARKS:**

1. Emission Level(dBuV/m) = Raw Value(dBuV) + Correction Factor(dB/m)
2. Correction Factor(dB/m) = Antenna Factor(dB/m) + Cable Factor(dB) – Pre-Amplifier Factor(dB)
3. The other emission levels were very low against the limit.
4. Margin value = Emission Level – Limit value
5. " \* ": Fundamental frequency.



CHANNEL	TX Channel 64	DETECTOR FUNCTION	Peak (PK)
FREQUENCY RANGE	1GHz ~ 40GHz		Average (AV)

**ANTENNA POLARITY & TEST DISTANCE: HORIZONTAL AT 3 M**

NO.	FREQ. (MHz)	EMISSION LEVEL (dBuV/m)	LIMIT (dBuV/m)	MARGIN (dB)	ANTENNA HEIGHT (m)	TABLE ANGLE (Degree)	RAW VALUE (dBuV)	CORRECTION FACTOR (dB/m)
1	*5320.00	107.1 PK			1.00 H	78	67.40	39.70
2	*5320.00	97.6 AV			1.00 H	78	57.90	39.70
3	5350.00	63.5 PK	74.0	-10.5	1.05 H	82	57.80	5.70
4	5350.00	49.7 AV	54.0	-4.3	1.05 H	82	44.00	5.70
5	10640.00	58.4 PK	74.0	-15.6	1.47 H	69	40.00	18.40
6	10640.00	45.8 AV	54.0	-8.2	1.47 H	69	27.40	18.40

**ANTENNA POLARITY & TEST DISTANCE: VERTICAL AT 3 M**

NO.	FREQ. (MHz)	EMISSION LEVEL (dBuV/m)	LIMIT (dBuV/m)	MARGIN (dB)	ANTENNA HEIGHT (m)	TABLE ANGLE (Degree)	RAW VALUE (dBuV)	CORRECTION FACTOR (dB/m)
1	*5320.00	110.2 PK			1.40 V	325	70.50	39.70
2	*5320.00	100.0 AV			1.40 V	325	60.30	39.70
3	5350.00	67.8 PK	74.0	-6.2	1.35 V	322	62.10	5.70
4	5350.00	53.5 AV	54.0	-0.5	1.35 V	322	47.80	5.70
5	10640.00	59.9 PK	74.0	-14.1	1.47 V	87	41.50	18.40
6	10640.00	46.8 AV	54.0	-7.2	1.47 V	87	28.40	18.40

**REMARKS:**

1. Emission Level(dBuV/m) = Raw Value(dBuV) + Correction Factor(dB/m)
2. Correction Factor(dB/m) = Antenna Factor(dB/m) + Cable Factor(dB) – Pre-Amplifier Factor(dB)
3. The other emission levels were very low against the limit.
4. Margin value = Emission Level – Limit value
5. " \* ": Fundamental frequency.

CHANNEL	TX Channel 100	DETECTOR FUNCTION	Peak (PK)
FREQUENCY RANGE	1GHz ~ 40GHz		Average (AV)

**ANTENNA POLARITY & TEST DISTANCE: HORIZONTAL AT 3 M**

NO.	FREQ. (MHz)	EMISSION LEVEL (dBuV/m)	LIMIT (dBuV/m)	MARGIN (dB)	ANTENNA HEIGHT (m)	TABLE ANGLE (Degree)	RAW VALUE (dBuV)	CORRECTION FACTOR (dB/m)
1	5460.00	64.8 PK	74.0	-9.2	1.04 H	54	59.00	5.80
2	5460.00	48.2 AV	54.0	-5.8	1.04 H	54	42.40	5.80
3	#5470.00	66.6 PK	74.0	-7.4	1.04 H	54	60.70	5.90
4	#5470.00	51.9 AV	54.0	-2.1	1.04 H	54	46.00	5.90
5	*5500.00	111.2 PK			1.02 H	50	71.30	39.90
6	*5500.00	101.1 AV			1.02 H	50	61.20	39.90
7	11000.00	58.5 PK	74.0	-15.5	1.00 H	40	39.60	18.90
8	11000.00	45.3 AV	54.0	-8.7	1.00 H	40	26.40	18.90

**ANTENNA POLARITY & TEST DISTANCE: VERTICAL AT 3 M**

NO.	FREQ. (MHz)	EMISSION LEVEL (dBuV/m)	LIMIT (dBuV/m)	MARGIN (dB)	ANTENNA HEIGHT (m)	TABLE ANGLE (Degree)	RAW VALUE (dBuV)	CORRECTION FACTOR (dB/m)
1	5460.00	66.4 PK	74.0	-7.6	2.07 V	316	60.60	5.80
2	5460.00	50.1 AV	54.0	-3.9	2.07 V	316	44.30	5.80
3	#5470.00	69.0 PK	74.0	-5.0	2.07 V	316	63.10	5.90
4	#5470.00	53.6 AV	54.0	-0.4	2.07 V	316	47.70	5.90
5	*5500.00	113.5 PK			2.10 V	320	73.60	39.90
6	*5500.00	103.3 AV			2.10 V	320	63.40	39.90
7	11000.00	61.1 PK	74.0	-12.9	1.01 V	83	42.20	18.90
8	11000.00	47.6 AV	54.0	-6.4	1.01 V	83	28.70	18.90

**REMARKS:**

1. Emission Level(dBuV/m) = Raw Value(dBuV) + Correction Factor(dB/m)
2. Correction Factor(dB/m) = Antenna Factor(dB/m) + Cable Factor(dB) – Pre-Amplifier Factor(dB)
3. The other emission levels were very low against the limit.
4. Margin value = Emission Level – Limit value
5. " \* ": Fundamental frequency.
6. " # ": The radiated frequency is out of the restricted band.

CHANNEL	TX Channel 116	DETECTOR FUNCTION	Peak (PK)
FREQUENCY RANGE	1GHz ~ 40GHz		Average (AV)

**ANTENNA POLARITY & TEST DISTANCE: HORIZONTAL AT 3 M**

NO.	FREQ. (MHz)	EMISSION LEVEL (dBuV/m)	LIMIT (dBuV/m)	MARGIN (dB)	ANTENNA HEIGHT (m)	TABLE ANGLE (Degree)	RAW VALUE (dBuV)	CORRECTION FACTOR (dB/m)
1	*5580.00	112.7 PK			1.09 H	51	72.80	39.90
2	*5580.00	102.5 AV			1.09 H	51	62.60	39.90
3	11160.00	59.0 PK	74.0	-15.0	1.00 H	46	39.80	19.20
4	11160.00	46.1 AV	54.0	-7.9	1.00 H	46	26.90	19.20

**ANTENNA POLARITY & TEST DISTANCE: VERTICAL AT 3 M**

NO.	FREQ. (MHz)	EMISSION LEVEL (dBuV/m)	LIMIT (dBuV/m)	MARGIN (dB)	ANTENNA HEIGHT (m)	TABLE ANGLE (Degree)	RAW VALUE (dBuV)	CORRECTION FACTOR (dB/m)
1	*5580.00	115.3 PK			1.74 V	323	75.40	39.90
2	*5580.00	104.8 AV			1.74 V	323	64.90	39.90
3	11160.00	61.7 PK	74.0	-12.3	1.04 V	80	42.50	19.20
4	11160.00	47.7 AV	54.0	-6.3	1.04 V	80	28.50	19.20

**REMARKS:**

1. Emission Level(dBuV/m) = Raw Value(dBuV) + Correction Factor(dB/m)
2. Correction Factor(dB/m) = Antenna Factor(dB/m) + Cable Factor(dB) – Pre-Amplifier Factor(dB)
3. The other emission levels were very low against the limit.
4. Margin value = Emission Level – Limit value
5. " \* ": Fundamental frequency.

CHANNEL	TX Channel 140	DETECTOR FUNCTION	Peak (PK)
FREQUENCY RANGE	1GHz ~ 40GHz		Average (AV)

**ANTENNA POLARITY & TEST DISTANCE: HORIZONTAL AT 3 M**

NO.	FREQ. (MHz)	EMISSION LEVEL (dBuV/m)	LIMIT (dBuV/m)	MARGIN (dB)	ANTENNA HEIGHT (m)	TABLE ANGLE (Degree)	RAW VALUE (dBuV)	CORRECTION FACTOR (dB/m)
1	*5700.00	109.2 PK			1.00 H	51	68.90	40.30
2	*5700.00	99.6 AV			1.00 H	51	59.30	40.30
3	#5725.00	69.3 PK	74.0	-4.7	1.00 H	54	63.00	6.30
4	#5725.00	52.8 AV	54.0	-1.2	1.00 H	54	46.50	6.30
5	11400.00	58.1 PK	74.0	-15.9	1.00 H	44	38.40	19.70
6	11400.00	45.2 AV	54.0	-8.8	1.00 H	44	25.50	19.70

**ANTENNA POLARITY & TEST DISTANCE: VERTICAL AT 3 M**

NO.	FREQ. (MHz)	EMISSION LEVEL (dBuV/m)	LIMIT (dBuV/m)	MARGIN (dB)	ANTENNA HEIGHT (m)	TABLE ANGLE (Degree)	RAW VALUE (dBuV)	CORRECTION FACTOR (dB/m)
1	*5700.00	111.3 PK			1.97 V	324	71.00	40.30
2	*5700.00	101.1 AV			1.97 V	324	60.80	40.30
3	#5725.00	73.8 PK	74.0	-0.2	1.91 V	321	67.50	6.30
4	#5725.00	53.8 AV	54.0	-0.2	1.91 V	321	47.50	6.30
5	11400.00	60.4 PK	74.0	-13.6	1.02 V	82	40.70	19.70
6	11400.00	47.2 AV	54.0	-6.8	1.02 V	82	27.50	19.70

**REMARKS:**

1. Emission Level(dBuV/m) = Raw Value(dBuV) + Correction Factor(dB/m)
2. Correction Factor(dB/m) = Antenna Factor(dB/m) + Cable Factor(dB) – Pre-Amplifier Factor(dB)
3. The other emission levels were very low against the limit.
4. Margin value = Emission Level – Limit value
5. " \* ": Fundamental frequency.
6. " # ": The radiated frequency is out of the restricted band.

802.11n (HT20)

CHANNEL	TX Channel 52	DETECTOR FUNCTION	Peak (PK)
FREQUENCY RANGE	1GHz ~ 40GHz		Average (AV)

ANTENNA POLARITY & TEST DISTANCE: HORIZONTAL AT 3 M								
NO.	FREQ. (MHz)	EMISSION LEVEL (dBuV/m)	LIMIT (dBuV/m)	MARGIN (dB)	ANTENNA HEIGHT (m)	TABLE ANGLE (Degree)	RAW VALUE (dBuV)	CORRECTION FACTOR (dB/m)
1	5150.00	56.1 PK	74.0	-17.9	1.78 H	60	50.60	5.50
2	5150.00	44.2 AV	54.0	-9.8	1.78 H	60	38.70	5.50
3	*5260.00	110.1 PK			1.88 H	53	70.50	39.60
4	*5260.00	99.7 AV			1.88 H	53	60.10	39.60
5	#10520.00	58.4 PK	74.0	-15.6	1.23 H	65	40.30	18.10
6	#10520.00	45.5 AV	54.0	-8.5	1.23 H	65	27.40	18.10

ANTENNA POLARITY & TEST DISTANCE: VERTICAL AT 3 M								
NO.	FREQ. (MHz)	EMISSION LEVEL (dBuV/m)	LIMIT (dBuV/m)	MARGIN (dB)	ANTENNA HEIGHT (m)	TABLE ANGLE (Degree)	RAW VALUE (dBuV)	CORRECTION FACTOR (dB/m)
1	5150.00	57.1 PK	74.0	-16.9	2.29 V	310	51.60	5.50
2	5150.00	46.0 AV	54.0	-8.0	2.29 V	310	40.50	5.50
3	*5260.00	113.1 PK			2.19 V	302	73.50	39.60
4	*5260.00	103.5 AV			2.19 V	302	63.90	39.60
5	#10520.00	60.7 PK	74.0	-13.3	1.52 V	65	42.60	18.10
6	#10520.00	46.8 AV	54.0	-7.2	1.52 V	65	28.70	18.10

REMARKS:

1. Emission Level(dBuV/m) = Raw Value(dBuV) + Correction Factor(dB/m)
2. Correction Factor(dB/m) = Antenna Factor(dB/m) + Cable Factor(dB) – Pre-Amplifier Factor(dB)
3. The other emission levels were very low against the limit.
4. Margin value = Emission Level – Limit value
5. " \* ": Fundamental frequency.
6. " # ": The radiated frequency is out of the restricted band.

CHANNEL	TX Channel 60	DETECTOR FUNCTION	Peak (PK)
FREQUENCY RANGE	1GHz ~ 40GHz		Average (AV)

**ANTENNA POLARITY & TEST DISTANCE: HORIZONTAL AT 3 M**

NO.	FREQ. (MHz)	EMISSION LEVEL (dBuV/m)	LIMIT (dBuV/m)	MARGIN (dB)	ANTENNA HEIGHT (m)	TABLE ANGLE (Degree)	RAW VALUE (dBuV)	CORRECTION FACTOR (dB/m)
1	*5300.00	109.6 PK			1.51 H	53	70.00	39.60
2	*5300.00	99.7 AV			1.51 H	53	60.10	39.60
3	10600.00	58.7 PK	74.0	-15.3	1.05 H	63	40.30	18.40
4	10600.00	45.9 AV	54.0	-8.1	1.05 H	63	27.50	18.40

**ANTENNA POLARITY & TEST DISTANCE: VERTICAL AT 3 M**

NO.	FREQ. (MHz)	EMISSION LEVEL (dBuV/m)	LIMIT (dBuV/m)	MARGIN (dB)	ANTENNA HEIGHT (m)	TABLE ANGLE (Degree)	RAW VALUE (dBuV)	CORRECTION FACTOR (dB/m)
1	*5300.00	113.3 PK			1.92 V	315	73.70	39.60
2	*5300.00	102.7 AV			1.92 V	315	63.10	39.60
3	10600.00	59.9 PK	74.0	-14.1	1.25 V	63	41.50	18.40
4	10600.00	47.0 AV	54.0	-7.0	1.25 V	63	28.60	18.40

**REMARKS:**

1. Emission Level(dBuV/m) = Raw Value(dBuV) + Correction Factor(dB/m)
2. Correction Factor(dB/m) = Antenna Factor(dB/m) + Cable Factor(dB) – Pre-Amplifier Factor(dB)
3. The other emission levels were very low against the limit.
4. Margin value = Emission Level – Limit value
5. " \* ": Fundamental frequency.

CHANNEL	TX Channel 64	DETECTOR FUNCTION	Peak (PK)
FREQUENCY RANGE	1GHz ~ 40GHz		Average (AV)

**ANTENNA POLARITY & TEST DISTANCE: HORIZONTAL AT 3 M**

NO.	FREQ. (MHz)	EMISSION LEVEL (dBuV/m)	LIMIT (dBuV/m)	MARGIN (dB)	ANTENNA HEIGHT (m)	TABLE ANGLE (Degree)	RAW VALUE (dBuV)	CORRECTION FACTOR (dB/m)
1	*5320.00	107.7 PK			1.00 H	78	68.00	39.70
2	*5320.00	97.4 AV			1.00 H	78	57.70	39.70
3	5350.00	61.3 PK	74.0	-12.7	1.05 H	90	55.60	5.70
4	5350.00	49.3 AV	54.0	-4.7	1.05 H	90	43.60	5.70
5	10640.00	58.4 PK	74.0	-15.6	1.25 H	63	40.00	18.40
6	10640.00	45.5 AV	54.0	-8.5	1.25 H	63	27.10	18.40

**ANTENNA POLARITY & TEST DISTANCE: VERTICAL AT 3 M**

NO.	FREQ. (MHz)	EMISSION LEVEL (dBuV/m)	LIMIT (dBuV/m)	MARGIN (dB)	ANTENNA HEIGHT (m)	TABLE ANGLE (Degree)	RAW VALUE (dBuV)	CORRECTION FACTOR (dB/m)
1	*5320.00	109.9 PK			1.85 V	314	70.20	39.70
2	*5320.00	100.1 AV			1.85 V	314	60.40	39.70
3	5350.00	67.3 PK	74.0	-6.7	1.80 V	322	61.60	5.70
4	5350.00	53.1 AV	54.0	-0.9	1.80 V	322	47.40	5.70
5	10640.00	60.0 PK	74.0	-14.0	1.47 V	87	41.60	18.40
6	10640.00	46.5 AV	54.0	-7.5	1.47 V	87	28.10	18.40

**REMARKS:**

1. Emission Level(dBuV/m) = Raw Value(dBuV) + Correction Factor(dB/m)
2. Correction Factor(dB/m) = Antenna Factor(dB/m) + Cable Factor(dB) – Pre-Amplifier Factor(dB)
3. The other emission levels were very low against the limit.
4. Margin value = Emission Level – Limit value
5. " \* ": Fundamental frequency.

CHANNEL	TX Channel 100	DETECTOR FUNCTION	Peak (PK)
FREQUENCY RANGE	1GHz ~ 40GHz		Average (AV)

**ANTENNA POLARITY & TEST DISTANCE: HORIZONTAL AT 3 M**

NO.	FREQ. (MHz)	EMISSION LEVEL (dBuV/m)	LIMIT (dBuV/m)	MARGIN (dB)	ANTENNA HEIGHT (m)	TABLE ANGLE (Degree)	RAW VALUE (dBuV)	CORRECTION FACTOR (dB/m)
1	5460.00	66.3 PK	74.0	-7.7	1.84 H	57	60.50	5.80
2	5460.00	49.4 AV	54.0	-4.6	1.84 H	57	43.60	5.80
3	#5470.00	66.0 PK	74.0	-8.0	1.86 H	62	60.10	5.90
4	#5470.00	51.0 AV	54.0	-3.0	1.86 H	62	45.10	5.90
5	*5500.00	110.9 PK			2.02 H	59	71.00	39.90
6	*5500.00	100.8 AV			2.02 H	59	60.90	39.90
7	11000.00	58.9 PK	74.0	-15.1	1.26 H	31	40.00	18.90
8	11000.00	46.0 AV	54.0	-8.0	1.26 H	31	27.10	18.90

**ANTENNA POLARITY & TEST DISTANCE: VERTICAL AT 3 M**

NO.	FREQ. (MHz)	EMISSION LEVEL (dBuV/m)	LIMIT (dBuV/m)	MARGIN (dB)	ANTENNA HEIGHT (m)	TABLE ANGLE (Degree)	RAW VALUE (dBuV)	CORRECTION FACTOR (dB/m)
1	5460.00	66.5 PK	74.0	-7.5	1.75 V	10	60.70	5.80
2	5460.00	50.3 AV	54.0	-3.7	1.75 V	10	44.50	5.80
3	#5470.00	68.3 PK	74.0	-5.7	1.80 V	0	62.40	5.90
4	#5470.00	53.5 AV	54.0	-0.5	1.80 V	0	47.60	5.90
5	*5500.00	112.7 PK			1.45 V	81	72.80	39.90
6	*5500.00	101.8 AV			1.45 V	81	61.90	39.90
7	11000.00	60.5 PK	74.0	-13.5	1.24 V	74	41.60	18.90
8	11000.00	47.0 AV	54.0	-7.0	1.24 V	74	28.10	18.90

**REMARKS:**

1. Emission Level(dBuV/m) = Raw Value(dBuV) + Correction Factor(dB/m)
2. Correction Factor(dB/m) = Antenna Factor(dB/m) + Cable Factor(dB) – Pre-Amplifier Factor(dB)
3. The other emission levels were very low against the limit.
4. Margin value = Emission Level – Limit value
5. " \* ": Fundamental frequency.
6. " # ": The radiated frequency is out of the restricted band.



CHANNEL	TX Channel 116	DETECTOR FUNCTION	Peak (PK)
FREQUENCY RANGE	1GHz ~ 40GHz		Average (AV)

**ANTENNA POLARITY & TEST DISTANCE: HORIZONTAL AT 3 M**

NO.	FREQ. (MHz)	EMISSION LEVEL (dBuV/m)	LIMIT (dBuV/m)	MARGIN (dB)	ANTENNA HEIGHT (m)	TABLE ANGLE (Degree)	RAW VALUE (dBuV)	CORRECTION FACTOR (dB/m)
1	*5580.00	111.9 PK			1.90 H	64	72.00	39.90
2	*5580.00	101.5 AV			1.90 H	64	61.60	39.90
3	11160.00	59.2 PK	74.0	-14.8	1.04 H	74	40.00	19.20
4	11160.00	46.4 AV	54.0	-7.6	1.04 H	74	27.20	19.20

**ANTENNA POLARITY & TEST DISTANCE: VERTICAL AT 3 M**

NO.	FREQ. (MHz)	EMISSION LEVEL (dBuV/m)	LIMIT (dBuV/m)	MARGIN (dB)	ANTENNA HEIGHT (m)	TABLE ANGLE (Degree)	RAW VALUE (dBuV)	CORRECTION FACTOR (dB/m)
1	*5580.00	113.4 PK			1.57 V	77	73.50	39.90
2	*5580.00	103.0 AV			1.57 V	77	63.10	39.90
3	11160.00	60.5 PK	74.0	-13.5	1.07 V	41	41.30	19.20
4	11160.00	47.3 AV	54.0	-6.7	1.07 V	41	28.10	19.20

**REMARKS:**

1. Emission Level(dBuV/m) = Raw Value(dBuV) + Correction Factor(dB/m)
2. Correction Factor(dB/m) = Antenna Factor(dB/m) + Cable Factor(dB) – Pre-Amplifier Factor(dB)
3. The other emission levels were very low against the limit.
4. Margin value = Emission Level – Limit value
5. " \* ": Fundamental frequency.

CHANNEL	TX Channel 140	DETECTOR FUNCTION	Peak (PK)
FREQUENCY RANGE	1GHz ~ 40GHz		Average (AV)

**ANTENNA POLARITY & TEST DISTANCE: HORIZONTAL AT 3 M**

NO.	FREQ. (MHz)	EMISSION LEVEL (dBuV/m)	LIMIT (dBuV/m)	MARGIN (dB)	ANTENNA HEIGHT (m)	TABLE ANGLE (Degree)	RAW VALUE (dBuV)	CORRECTION FACTOR (dB/m)
1	*5700.00	107.6 PK			1.00 H	59	67.30	40.30
2	*5700.00	97.1 AV			1.00 H	59	56.80	40.30
3	#5725.00	71.8 PK	74.0	-2.2	1.10 H	65	65.50	6.30
4	#5725.00	50.9 AV	54.0	-3.1	1.10 H	65	44.60	6.30
5	11440.00	60.2 PK	74.0	-13.8	1.23 H	65	40.60	19.60
6	11440.00	46.7 AV	54.0	-7.3	1.23 H	65	27.10	19.60

**ANTENNA POLARITY & TEST DISTANCE: VERTICAL AT 3 M**

NO.	FREQ. (MHz)	EMISSION LEVEL (dBuV/m)	LIMIT (dBuV/m)	MARGIN (dB)	ANTENNA HEIGHT (m)	TABLE ANGLE (Degree)	RAW VALUE (dBuV)	CORRECTION FACTOR (dB/m)
1	*5700.00	111.0 PK			2.21 V	340	70.70	40.30
2	*5700.00	100.8 AV			2.21 V	340	60.50	40.30
<b>3</b>	<b>#5725.00</b>	<b>73.9 PK</b>	<b>74.0</b>	<b>-0.1</b>	<b>2.03 V</b>	<b>335</b>	<b>67.60</b>	<b>6.30</b>
4	#5725.00	52.9 AV	54.0	-1.1	2.03 V	335	46.60	6.30
5	11400.00	61.7 PK	74.0	-12.3	1.15 V	20	42.00	19.70
6	11400.00	47.9 AV	54.0	-6.1	1.15 V	20	28.20	19.70

**REMARKS:**

1. Emission Level(dBuV/m) = Raw Value(dBuV) + Correction Factor(dB/m)
2. Correction Factor(dB/m) = Antenna Factor(dB/m) + Cable Factor(dB) – Pre-Amplifier Factor(dB)
3. The other emission levels were very low against the limit.
4. Margin value = Emission Level – Limit value
5. " \* ": Fundamental frequency.
6. " # ": The radiated frequency is out of the restricted band.

802.11n (HT40)

CHANNEL	TX Channel 54	DETECTOR FUNCTION	Peak (PK)
FREQUENCY RANGE	1GHz ~ 40GHz		Average (AV)

ANTENNA POLARITY & TEST DISTANCE: HORIZONTAL AT 3 M								
NO.	FREQ. (MHz)	EMISSION LEVEL (dBuV/m)	LIMIT (dBuV/m)	MARGIN (dB)	ANTENNA HEIGHT (m)	TABLE ANGLE (Degree)	RAW VALUE (dBuV)	CORRECTION FACTOR (dB/m)
1	5150.00	55.5 PK	74.0	-18.5	1.80 H	55	50.00	5.50
2	5150.00	44.5 AV	54.0	-9.5	1.80 H	55	39.00	5.50
3	*5270.00	106.5 PK			1.76 H	48	66.90	39.60
4	*5270.00	95.6 AV			1.76 H	48	56.00	39.60
5	5350.00	64.4 PK	74.0	-9.6	1.74 H	51	58.70	5.70
6	5350.00	49.7 AV	54.0	-4.3	1.74 H	51	44.00	5.70
7	#10540.00	58.1 PK	74.0	-15.9	1.25 H	64	40.00	18.10
8	#10540.00	45.5 AV	54.0	-8.5	1.25 H	64	27.40	18.10

ANTENNA POLARITY & TEST DISTANCE: VERTICAL AT 3 M								
NO.	FREQ. (MHz)	EMISSION LEVEL (dBuV/m)	LIMIT (dBuV/m)	MARGIN (dB)	ANTENNA HEIGHT (m)	TABLE ANGLE (Degree)	RAW VALUE (dBuV)	CORRECTION FACTOR (dB/m)
1	5150.00	56.7 PK	74.0	-17.3	1.85 V	315	51.20	5.50
2	5150.00	46.1 AV	54.0	-7.9	1.85 V	315	40.60	5.50
3	*5270.00	108.4 PK			1.51 V	307	68.80	39.60
4	*5270.00	98.4 AV			1.51 V	307	58.80	39.60
5	5350.00	66.5 PK	74.0	-7.5	1.90 V	323	60.80	5.70
6	5350.00	53.2 AV	54.0	-0.8	1.90 V	323	47.50	5.70
7	#10540.00	59.6 PK	74.0	-14.4	1.23 V	64	41.50	18.10
8	#10540.00	46.2 AV	54.0	-7.8	1.23 V	64	28.10	18.10

REMARKS:

1. Emission Level(dBuV/m) = Raw Value(dBuV) + Correction Factor(dB/m)
2. Correction Factor(dB/m) = Antenna Factor(dB/m) + Cable Factor(dB) – Pre-Amplifier Factor(dB)
3. The other emission levels were very low against the limit.
4. Margin value = Emission Level – Limit value
5. " \* ": Fundamental frequency.
6. " # ": The radiated frequency is out of the restricted band.

CHANNEL	TX Channel 62	DETECTOR FUNCTION	Peak (PK)
FREQUENCY RANGE	1GHz ~ 40GHz		Average (AV)

**ANTENNA POLARITY & TEST DISTANCE: HORIZONTAL AT 3 M**

NO.	FREQ. (MHz)	EMISSION LEVEL (dBuV/m)	LIMIT (dBuV/m)	MARGIN (dB)	ANTENNA HEIGHT (m)	TABLE ANGLE (Degree)	RAW VALUE (dBuV)	CORRECTION FACTOR (dB/m)
1	*5310.00	102.3 PK			1.00 H	82	62.70	39.60
2	*5310.00	91.9 AV			1.00 H	82	52.30	39.60
3	5350.00	67.6 PK	74.0	-6.4	1.05 H	90	61.90	5.70
4	5350.00	49.5 AV	54.0	-4.5	1.05 H	90	43.80	5.70
5	10620.00	58.3 PK	74.0	-15.7	1.25 H	63	40.00	18.30
6	10620.00	45.4 AV	54.0	-8.6	1.25 H	63	27.10	18.30

**ANTENNA POLARITY & TEST DISTANCE: VERTICAL AT 3 M**

NO.	FREQ. (MHz)	EMISSION LEVEL (dBuV/m)	LIMIT (dBuV/m)	MARGIN (dB)	ANTENNA HEIGHT (m)	TABLE ANGLE (Degree)	RAW VALUE (dBuV)	CORRECTION FACTOR (dB/m)
1	*5310.00	106.6 PK			1.88 V	325	67.00	39.60
2	*5310.00	96.6 AV			1.88 V	325	57.00	39.60
3	5350.00	71.9 PK	74.0	-2.1	1.90 V	323	66.20	5.70
4	5350.00	53.5 AV	54.0	-0.5	1.90 V	323	47.80	5.70
5	10620.00	59.9 PK	74.0	-14.1	1.14 V	54	41.60	18.30
6	10620.00	46.4 AV	54.0	-7.6	1.14 V	54	28.10	18.30

**REMARKS:**

1. Emission Level(dBuV/m) = Raw Value(dBuV) + Correction Factor(dB/m)
2. Correction Factor(dB/m) = Antenna Factor(dB/m) + Cable Factor(dB) – Pre-Amplifier Factor(dB)
3. The other emission levels were very low against the limit.
4. Margin value = Emission Level – Limit value
5. " \* ": Fundamental frequency.

CHANNEL	TX Channel 102	DETECTOR FUNCTION	Peak (PK)
FREQUENCY RANGE	1GHz ~ 40GHz		Average (AV)

**ANTENNA POLARITY & TEST DISTANCE: HORIZONTAL AT 3 M**

NO.	FREQ. (MHz)	EMISSION LEVEL (dBuV/m)	LIMIT (dBuV/m)	MARGIN (dB)	ANTENNA HEIGHT (m)	TABLE ANGLE (Degree)	RAW VALUE (dBuV)	CORRECTION FACTOR (dB/m)
1	5460.00	67.6 PK	74.0	-6.4	1.54 H	66	61.80	5.80
2	5460.00	46.7 AV	54.0	-7.3	1.54 H	66	40.90	5.80
3	#5470.00	69.9 PK	74.0	-4.1	1.52 H	60	64.00	5.90
4	#5470.00	50.5 AV	54.0	-3.5	1.52 H	60	44.60	5.90
5	*5510.00	103.7 PK			1.60 H	53	63.80	39.90
6	*5510.00	93.0 AV			1.60 H	53	53.10	39.90
7	11020.00	59.6 PK	74.0	-14.4	1.47 H	41	40.60	19.00
8	11020.00	46.5 AV	54.0	-7.5	1.47 H	41	27.50	19.00

**ANTENNA POLARITY & TEST DISTANCE: VERTICAL AT 3 M**

NO.	FREQ. (MHz)	EMISSION LEVEL (dBuV/m)	LIMIT (dBuV/m)	MARGIN (dB)	ANTENNA HEIGHT (m)	TABLE ANGLE (Degree)	RAW VALUE (dBuV)	CORRECTION FACTOR (dB/m)
1	5460.00	69.1 PK	74.0	-4.9	1.15 V	18	63.30	5.80
2	5460.00	47.6 AV	54.0	-6.4	1.15 V	18	41.80	5.80
3	#5470.00	73.6 PK	74.0	-0.4	1.12 V	19	67.70	5.90
4	#5470.00	52.4 AV	54.0	-1.6	1.12 V	19	46.50	5.90
5	*5510.00	104.6 PK			1.27 V	40	64.70	39.90
6	*5510.00	95.0 AV			1.27 V	40	55.10	39.90
7	11020.00	60.5 PK	74.0	-13.5	1.45 V	63	41.50	19.00
8	11020.00	47.4 AV	54.0	-6.6	1.45 V	63	28.40	19.00

**REMARKS:**

1. Emission Level(dBuV/m) = Raw Value(dBuV) + Correction Factor(dB/m)
2. Correction Factor(dB/m) = Antenna Factor(dB/m) + Cable Factor(dB) – Pre-Amplifier Factor(dB)
3. The other emission levels were very low against the limit.
4. Margin value = Emission Level – Limit value
5. " \* ": Fundamental frequency.
6. " # ": The radiated frequency is out of the restricted band.

CHANNEL	TX Channel 110	DETECTOR FUNCTION	Peak (PK)
FREQUENCY RANGE	1GHz ~ 40GHz		Average (AV)

**ANTENNA POLARITY & TEST DISTANCE: HORIZONTAL AT 3 M**

NO.	FREQ. (MHz)	EMISSION LEVEL (dBuV/m)	LIMIT (dBuV/m)	MARGIN (dB)	ANTENNA HEIGHT (m)	TABLE ANGLE (Degree)	RAW VALUE (dBuV)	CORRECTION FACTOR (dB/m)
1	*5550.00	108.6 PK			2.01 H	283	68.60	40.00
2	*5550.00	97.4 AV			2.01 H	283	57.40	40.00
3	11100.00	59.6 PK	74.0	-14.4	1.05 H	64	40.00	19.60
4	11100.00	46.8 AV	54.0	-7.2	1.05 H	64	27.20	19.60

**ANTENNA POLARITY & TEST DISTANCE: VERTICAL AT 3 M**

NO.	FREQ. (MHz)	EMISSION LEVEL (dBuV/m)	LIMIT (dBuV/m)	MARGIN (dB)	ANTENNA HEIGHT (m)	TABLE ANGLE (Degree)	RAW VALUE (dBuV)	CORRECTION FACTOR (dB/m)
1	*5550.00	109.5 PK			1.19 V	46	69.50	40.00
2	*5550.00	98.6 AV			1.19 V	46	58.60	40.00
3	11100.00	61.1 PK	74.0	-12.9	1.23 V	64	41.50	19.60
4	11100.00	48.2 AV	54.0	-5.8	1.23 V	64	28.60	19.60

**REMARKS:**

1. Emission Level(dBuV/m) = Raw Value(dBuV) + Correction Factor(dB/m)
2. Correction Factor(dB/m) = Antenna Factor(dB/m) + Cable Factor(dB) – Pre-Amplifier Factor(dB)
3. The other emission levels were very low against the limit.
4. Margin value = Emission Level – Limit value
5. " \* ": Fundamental frequency.

CHANNEL	TX Channel 134	DETECTOR FUNCTION	Peak (PK)
FREQUENCY RANGE	1GHz ~ 40GHz		Average (AV)

**ANTENNA POLARITY & TEST DISTANCE: HORIZONTAL AT 3 M**

NO.	FREQ. (MHz)	EMISSION LEVEL (dBuV/m)	LIMIT (dBuV/m)	MARGIN (dB)	ANTENNA HEIGHT (m)	TABLE ANGLE (Degree)	RAW VALUE (dBuV)	CORRECTION FACTOR (dB/m)
1	*5670.00	105.4 PK			1.51 H	59	65.20	40.20
2	*5670.00	94.9 AV			1.51 H	59	54.70	40.20
3	#5725.00	63.3 PK	74.0	-10.7	1.56 H	61	57.00	6.30
4	#5725.00	49.8 AV	54.0	-4.2	1.56 H	61	43.50	6.30
5	11340.00	59.7 PK	74.0	-14.3	1.05 H	74	40.00	19.70
6	11340.00	46.8 AV	54.0	-7.2	1.05 H	74	27.10	19.70

**ANTENNA POLARITY & TEST DISTANCE: VERTICAL AT 3 M**

NO.	FREQ. (MHz)	EMISSION LEVEL (dBuV/m)	LIMIT (dBuV/m)	MARGIN (dB)	ANTENNA HEIGHT (m)	TABLE ANGLE (Degree)	RAW VALUE (dBuV)	CORRECTION FACTOR (dB/m)
1	*5670.00	108.2 PK			2.20 V	335	68.00	40.20
2	*5670.00	97.5 AV			2.20 V	335	57.30	40.20
3	#5725.00	67.4 PK	74.0	-6.6	2.17 V	331	61.10	6.30
4	#5725.00	53.5 AV	54.0	-0.5	2.17 V	331	47.20	6.30
5	11340.00	62.3 PK	74.0	-11.7	1.47 V	5	42.60	19.70
6	11340.00	48.1 AV	54.0	-5.9	1.47 V	5	28.40	19.70

**REMARKS:**

1. Emission Level(dBuV/m) = Raw Value(dBuV) + Correction Factor(dB/m)
2. Correction Factor(dB/m) = Antenna Factor(dB/m) + Cable Factor(dB) – Pre-Amplifier Factor(dB)
3. The other emission levels were very low against the limit.
4. Margin value = Emission Level – Limit value
5. " \* ": Fundamental frequency.
6. " # ": The radiated frequency is out of the restricted band.

**802.11ac (VHT80)**

CHANNEL	TX Channel 58	DETECTOR FUNCTION	Peak (PK)
FREQUENCY RANGE	1GHz ~ 40GHz		Average (AV)

**ANTENNA POLARITY & TEST DISTANCE: HORIZONTAL AT 3 M**

NO.	FREQ. (MHz)	EMISSION LEVEL (dBuV/m)	LIMIT (dBuV/m)	MARGIN (dB)	ANTENNA HEIGHT (m)	TABLE ANGLE (Degree)	RAW VALUE (dBuV)	CORRECTION FACTOR (dB/m)
1	*5290.00	96.8 PK			1.90 H	59	57.20	39.60
2	*5290.00	85.5 AV			1.90 H	59	45.90	39.60
3	5350.00	72.2 PK	74.0	-1.8	1.84 H	62	66.50	5.70
4	5350.00	45.7 AV	54.0	-8.3	1.84 H	62	40.00	5.70
5	#10580.00	58.3 PK	74.0	-15.7	1.23 H	69	40.00	18.30
6	#10580.00	45.4 AV	54.0	-8.6	1.23 H	69	27.10	18.30

**ANTENNA POLARITY & TEST DISTANCE: VERTICAL AT 3 M**

NO.	FREQ. (MHz)	EMISSION LEVEL (dBuV/m)	LIMIT (dBuV/m)	MARGIN (dB)	ANTENNA HEIGHT (m)	TABLE ANGLE (Degree)	RAW VALUE (dBuV)	CORRECTION FACTOR (dB/m)
1	*5290.00	99.1 PK			1.70 V	350	59.50	39.60
2	*5290.00	87.0 AV			1.70 V	350	47.40	39.60
3	5350.00	73.8 PK	74.0	-0.2	1.67 V	347	68.10	5.70
4	5350.00	45.9 AV	54.0	-8.1	1.67 V	347	40.20	5.70
5	#10580.00	59.3 PK	74.0	-14.7	1.26 V	35	41.00	18.30
6	#10580.00	46.7 AV	54.0	-7.3	1.26 V	35	28.40	18.30

**REMARKS:**

1. Emission Level(dBuV/m) = Raw Value(dBuV) + Correction Factor(dB/m)
2. Correction Factor(dB/m) = Antenna Factor(dB/m) + Cable Factor(dB) – Pre-Amplifier Factor(dB)
3. The other emission levels were very low against the limit.
4. Margin value = Emission Level – Limit value
5. " \* ": Fundamental frequency.
6. " # ": The radiated frequency is out of the restricted band.



CHANNEL	TX Channel 106	DETECTOR FUNCTION	Peak (PK)
FREQUENCY RANGE	1GHz ~ 40GHz		Average (AV)

**ANTENNA POLARITY & TEST DISTANCE: HORIZONTAL AT 3 M**

NO.	FREQ. (MHz)	EMISSION LEVEL (dBuV/m)	LIMIT (dBuV/m)	MARGIN (dB)	ANTENNA HEIGHT (m)	TABLE ANGLE (Degree)	RAW VALUE (dBuV)	CORRECTION FACTOR (dB/m)
1	5460.00	66.6 PK	74.0	-7.4	1.83 H	62	60.80	5.80
2	5460.00	44.8 AV	54.0	-9.2	1.83 H	62	39.00	5.80
3	#5470.00	72.0 PK	74.0	-2.0	1.80 H	63	66.10	5.90
4	#5470.00	46.8 AV	54.0	-7.2	1.80 H	63	40.90	5.90
5	*5530.00	96.7 PK			1.75 H	56	56.80	39.90
6	*5530.00	86.2 AV			1.75 H	56	46.30	39.90
7	11060.00	59.2 PK	74.0	-14.8	1.04 H	12	40.00	19.20
8	11060.00	46.3 AV	54.0	-7.7	1.04 H	12	27.10	19.20

**ANTENNA POLARITY & TEST DISTANCE: VERTICAL AT 3 M**

NO.	FREQ. (MHz)	EMISSION LEVEL (dBuV/m)	LIMIT (dBuV/m)	MARGIN (dB)	ANTENNA HEIGHT (m)	TABLE ANGLE (Degree)	RAW VALUE (dBuV)	CORRECTION FACTOR (dB/m)
1	5460.00	69.2 PK	74.0	-4.8	2.10 V	21	63.40	5.80
2	5460.00	45.7 AV	54.0	-8.3	2.10 V	21	39.90	5.80
3	#5470.00	73.3 PK	74.0	-0.7	2.06 V	19	67.40	5.90
4	#5470.00	46.5 AV	54.0	-7.5	2.06 V	19	40.60	5.90
5	*5530.00	99.2 PK			2.18 V	20	59.30	39.90
6	*5530.00	87.9 AV			2.18 V	20	48.00	39.90
7	11060.00	60.7 PK	74.0	-13.3	1.47 V	4	41.50	19.20
8	11060.00	47.6 AV	54.0	-6.4	1.47 V	4	28.40	19.20

**REMARKS:**

1. Emission Level(dBuV/m) = Raw Value(dBuV) + Correction Factor(dB/m)
2. Correction Factor(dB/m) = Antenna Factor(dB/m) + Cable Factor(dB) – Pre-Amplifier Factor(dB)
3. The other emission levels were very low against the limit.
4. Margin value = Emission Level – Limit value
5. " \* ": Fundamental frequency.
6. " # ": The radiated frequency is out of the restricted band.

Test Mode B

**2TX**

802.11a

CHANNEL	TX Channel 52	DETECTOR FUNCTION	Peak (PK)
FREQUENCY RANGE	1GHz ~ 40GHz		Average (AV)

**ANTENNA POLARITY & TEST DISTANCE: HORIZONTAL AT 3 M**

NO.	FREQ. (MHz)	EMISSION LEVEL (dBuV/m)	LIMIT (dBuV/m)	MARGIN (dB)	ANTENNA HEIGHT (m)	TABLE ANGLE (Degree)	RAW VALUE (dBuV)	CORRECTION FACTOR (dB/m)
1	5150.00	55.5 PK	74.0	-18.5	1.25 H	85	50.00	5.50
2	5150.00	45.2 AV	54.0	-8.8	1.25 H	85	39.70	5.50
3	*5260.00	110.7 PK			1.19 H	74	71.10	39.60
4	*5260.00	101.3 AV			1.19 H	74	61.70	39.60
5	#10520.00	58.3 PK	74.0	-15.7	1.25 H	74	40.20	18.10
6	#10520.00	45.5 AV	54.0	-8.5	1.25 H	74	27.40	18.10

**ANTENNA POLARITY & TEST DISTANCE: VERTICAL AT 3 M**

NO.	FREQ. (MHz)	EMISSION LEVEL (dBuV/m)	LIMIT (dBuV/m)	MARGIN (dB)	ANTENNA HEIGHT (m)	TABLE ANGLE (Degree)	RAW VALUE (dBuV)	CORRECTION FACTOR (dB/m)
1	5150.00	57.5 PK	74.0	-16.5	1.26 V	184	52.00	5.50
2	5150.00	46.1 AV	54.0	-7.9	1.26 V	184	40.60	5.50
3	*5260.00	116.1 PK			1.12 V	194	76.50	39.60
4	*5260.00	106.4 AV			1.12 V	194	66.80	39.60
5	#10520.00	59.7 PK	74.0	-14.3	1.15 V	78	41.60	18.10
6	#10520.00	46.8 AV	54.0	-7.2	1.15 V	78	28.70	18.10

REMARKS:

1. Emission Level(dBuV/m) = Raw Value(dBuV) + Correction Factor(dB/m)
2. Correction Factor(dB/m) = Antenna Factor(dB/m) + Cable Factor(dB) – Pre-Amplifier Factor(dB)
3. The other emission levels were very low against the limit.
4. Margin value = Emission Level – Limit value
5. " \* ": Fundamental frequency.
6. " # ": The radiated frequency is out of the restricted band.

CHANNEL	TX Channel 60	DETECTOR FUNCTION	Peak (PK)
FREQUENCY RANGE	1GHz ~ 40GHz		Average (AV)

**ANTENNA POLARITY & TEST DISTANCE: HORIZONTAL AT 3 M**

NO.	FREQ. (MHz)	EMISSION LEVEL (dBuV/m)	LIMIT (dBuV/m)	MARGIN (dB)	ANTENNA HEIGHT (m)	TABLE ANGLE (Degree)	RAW VALUE (dBuV)	CORRECTION FACTOR (dB/m)
1	*5300.00	111.1 PK			1.00 H	294	71.50	39.60
2	*5300.00	101.0 AV			1.00 H	294	61.40	39.60
3	10600.00	58.4 PK	74.0	-15.6	1.36 H	58	40.00	18.40
4	10600.00	45.6 AV	54.0	-8.4	1.36 H	58	27.20	18.40

**ANTENNA POLARITY & TEST DISTANCE: VERTICAL AT 3 M**

NO.	FREQ. (MHz)	EMISSION LEVEL (dBuV/m)	LIMIT (dBuV/m)	MARGIN (dB)	ANTENNA HEIGHT (m)	TABLE ANGLE (Degree)	RAW VALUE (dBuV)	CORRECTION FACTOR (dB/m)
1	*5300.00	115.0 PK			1.48 V	193	75.40	39.60
2	*5300.00	105.3 AV			1.48 V	193	65.70	39.60
3	10600.00	59.9 PK	74.0	-14.1	1.27 V	88	41.50	18.40
4	10600.00	47.0 AV	54.0	-7.0	1.27 V	88	28.60	18.40

**REMARKS:**

1. Emission Level(dBuV/m) = Raw Value(dBuV) + Correction Factor(dB/m)
2. Correction Factor(dB/m) = Antenna Factor(dB/m) + Cable Factor(dB) – Pre-Amplifier Factor(dB)
3. The other emission levels were very low against the limit.
4. Margin value = Emission Level – Limit value
5. " \* ": Fundamental frequency.

CHANNEL	TX Channel 64	DETECTOR FUNCTION	Peak (PK)
FREQUENCY RANGE	1GHz ~ 40GHz		Average (AV)

**ANTENNA POLARITY & TEST DISTANCE: HORIZONTAL AT 3 M**

NO.	FREQ. (MHz)	EMISSION LEVEL (dBuV/m)	LIMIT (dBuV/m)	MARGIN (dB)	ANTENNA HEIGHT (m)	TABLE ANGLE (Degree)	RAW VALUE (dBuV)	CORRECTION FACTOR (dB/m)
1	*5320.00	111.2 PK			1.00 H	293	71.50	39.70
2	*5320.00	101.2 AV			1.00 H	293	61.50	39.70
3	5350.00	64.4 PK	74.0	-9.6	1.10 H	300	58.70	5.70
4	5350.00	49.3 AV	54.0	-4.7	1.10 H	300	43.60	5.70
5	10640.00	58.4 PK	74.0	-15.6	1.17 H	41	40.00	18.40
6	10640.00	45.5 AV	54.0	-8.5	1.17 H	41	27.10	18.40

**ANTENNA POLARITY & TEST DISTANCE: VERTICAL AT 3 M**

NO.	FREQ. (MHz)	EMISSION LEVEL (dBuV/m)	LIMIT (dBuV/m)	MARGIN (dB)	ANTENNA HEIGHT (m)	TABLE ANGLE (Degree)	RAW VALUE (dBuV)	CORRECTION FACTOR (dB/m)
1	*5320.00	114.5 PK			1.15 V	269	74.80	39.70
2	*5320.00	104.5 AV			1.15 V	269	64.80	39.70
3	5350.00	70.4 PK	74.0	-3.6	1.17 V	201	64.70	5.70
4	5350.00	53.1 AV	54.0	-0.9	1.17 V	201	47.40	5.70
5	10640.00	58.4 PK	74.0	-15.6	1.25 V	64	40.00	18.40
6	10640.00	46.8 AV	54.0	-7.2	1.25 V	64	28.40	18.40

**REMARKS:**

1. Emission Level(dBuV/m) = Raw Value(dBuV) + Correction Factor(dB/m)
2. Correction Factor(dB/m) = Antenna Factor(dB/m) + Cable Factor(dB) – Pre-Amplifier Factor(dB)
3. The other emission levels were very low against the limit.
4. Margin value = Emission Level – Limit value
5. " \* ": Fundamental frequency.

CHANNEL	TX Channel 100	DETECTOR FUNCTION	Peak (PK)
FREQUENCY RANGE	1GHz ~ 40GHz		Average (AV)

**ANTENNA POLARITY & TEST DISTANCE: HORIZONTAL AT 3 M**

NO.	FREQ. (MHz)	EMISSION LEVEL (dBuV/m)	LIMIT (dBuV/m)	MARGIN (dB)	ANTENNA HEIGHT (m)	TABLE ANGLE (Degree)	RAW VALUE (dBuV)	CORRECTION FACTOR (dB/m)
1	5460.00	61.5 PK	74.0	-12.5	1.30 H	15	55.70	5.80
2	5460.00	47.3 AV	54.0	-6.7	1.30 H	15	41.50	5.80
3	#5470.00	67.8 PK	74.0	-6.2	1.27 H	14	61.90	5.90
4	#5470.00	51.8 AV	54.0	-2.2	1.27 H	14	45.90	5.90
5	*5500.00	113.9 PK			1.00 H	39	74.00	39.90
6	*5500.00	103.8 AV			1.00 H	39	63.90	39.90
7	11000.00	60.5 PK	74.0	-13.5	1.47 H	85	41.60	18.90
8	11000.00	47.4 AV	54.0	-6.6	1.47 H	85	28.50	18.90

**ANTENNA POLARITY & TEST DISTANCE: VERTICAL AT 3 M**

NO.	FREQ. (MHz)	EMISSION LEVEL (dBuV/m)	LIMIT (dBuV/m)	MARGIN (dB)	ANTENNA HEIGHT (m)	TABLE ANGLE (Degree)	RAW VALUE (dBuV)	CORRECTION FACTOR (dB/m)
1	5460.00	61.3 PK	74.0	-12.7	2.10 V	19	55.50	5.80
2	5460.00	47.3 AV	54.0	-6.7	2.10 V	19	41.50	5.80
3	#5470.00	67.0 PK	74.0	-7.0	2.06 V	15	61.10	5.90
4	#5470.00	52.2 AV	54.0	-1.8	2.06 V	15	46.30	5.90
5	*5500.00	114.6 PK			1.63 V	21	74.70	39.90
6	*5500.00	104.9 AV			1.63 V	21	65.00	39.90
7	11000.00	61.2 PK	74.0	-12.8	1.26 V	35	42.30	18.90
8	11000.00	47.1 AV	54.0	-6.9	1.26 V	35	28.20	18.90

**REMARKS:**

1. Emission Level(dBuV/m) = Raw Value(dBuV) + Correction Factor(dB/m)
2. Correction Factor(dB/m) = Antenna Factor(dB/m) + Cable Factor(dB) – Pre-Amplifier Factor(dB)
3. The other emission levels were very low against the limit.
4. Margin value = Emission Level – Limit value
5. " \* ": Fundamental frequency.
6. " # ": The radiated frequency is out of the restricted band.

CHANNEL	TX Channel 116	DETECTOR FUNCTION	Peak (PK)
FREQUENCY RANGE	1GHz ~ 40GHz		Average (AV)

**ANTENNA POLARITY & TEST DISTANCE: HORIZONTAL AT 3 M**

NO.	FREQ. (MHz)	EMISSION LEVEL (dBuV/m)	LIMIT (dBuV/m)	MARGIN (dB)	ANTENNA HEIGHT (m)	TABLE ANGLE (Degree)	RAW VALUE (dBuV)	CORRECTION FACTOR (dB/m)
1	*5580.00	114.1 PK			1.91 H	56	74.20	39.90
2	*5580.00	104.2 AV			1.91 H	56	64.30	39.90
3	11160.00	59.8 PK	74.0	-14.2	1.23 H	64	40.60	19.20
4	11160.00	46.6 AV	54.0	-7.4	1.23 H	64	27.40	19.20

**ANTENNA POLARITY & TEST DISTANCE: VERTICAL AT 3 M**

NO.	FREQ. (MHz)	EMISSION LEVEL (dBuV/m)	LIMIT (dBuV/m)	MARGIN (dB)	ANTENNA HEIGHT (m)	TABLE ANGLE (Degree)	RAW VALUE (dBuV)	CORRECTION FACTOR (dB/m)
1	*5580.00	115.5 PK			1.40 V	324	75.60	39.90
2	*5580.00	105.9 AV			1.40 V	324	66.00	39.90
3	11160.00	60.9 PK	74.0	-13.1	1.32 V	69	41.70	19.20
4	11160.00	47.6 AV	54.0	-6.4	1.32 V	69	28.40	19.20

**REMARKS:**

1. Emission Level(dBuV/m) = Raw Value(dBuV) + Correction Factor(dB/m)
2. Correction Factor(dB/m) = Antenna Factor(dB/m) + Cable Factor(dB) – Pre-Amplifier Factor(dB)
3. The other emission levels were very low against the limit.
4. Margin value = Emission Level – Limit value
5. " \* ": Fundamental frequency.

CHANNEL	TX Channel 140	DETECTOR FUNCTION	Peak (PK)
FREQUENCY RANGE	1GHz ~ 40GHz		Average (AV)

**ANTENNA POLARITY & TEST DISTANCE: HORIZONTAL AT 3 M**

NO.	FREQ. (MHz)	EMISSION LEVEL (dBuV/m)	LIMIT (dBuV/m)	MARGIN (dB)	ANTENNA HEIGHT (m)	TABLE ANGLE (Degree)	RAW VALUE (dBuV)	CORRECTION FACTOR (dB/m)
1	*5700.00	113.2 PK			1.75 H	57	72.90	40.30
2	*5700.00	103.4 AV			1.75 H	57	63.10	40.30
3	#5725.00	69.2 PK	74.0	-4.8	1.96 H	64	62.90	6.30
4	#5725.00	52.9 AV	54.0	-1.1	1.96 H	64	46.60	6.30
5	11400.00	61.2 PK	74.0	-12.8	1.26 H	32	41.50	19.70
6	11400.00	46.8 AV	54.0	-7.2	1.26 H	32	27.10	19.70

**ANTENNA POLARITY & TEST DISTANCE: VERTICAL AT 3 M**

NO.	FREQ. (MHz)	EMISSION LEVEL (dBuV/m)	LIMIT (dBuV/m)	MARGIN (dB)	ANTENNA HEIGHT (m)	TABLE ANGLE (Degree)	RAW VALUE (dBuV)	CORRECTION FACTOR (dB/m)
1	*5700.00	114.5 PK			1.72 V	359	74.20	40.30
2	*5700.00	104.2 AV			1.72 V	359	63.90	40.30
3	#5725.00	70.6 PK	74.0	-3.4	1.63 V	0	64.30	6.30
4	#5725.00	53.5 AV	54.0	-0.5	1.63 V	0	47.20	6.30
5	11400.00	61.2 PK	74.0	-12.8	1.32 V	68	41.50	19.70
6	11400.00	47.9 AV	54.0	-6.1	1.32 V	68	28.20	19.70

**REMARKS:**

1. Emission Level(dBuV/m) = Raw Value(dBuV) + Correction Factor(dB/m)
2. Correction Factor(dB/m) = Antenna Factor(dB/m) + Cable Factor(dB) – Pre-Amplifier Factor(dB)
3. The other emission levels were very low against the limit.
4. Margin value = Emission Level – Limit value
5. " \* ": Fundamental frequency.
6. " # ": The radiated frequency is out of the restricted band.

802.11n (HT20)

CHANNEL	TX Channel 52	DETECTOR FUNCTION	Peak (PK)
FREQUENCY RANGE	1GHz ~ 40GHz		Average (AV)

ANTENNA POLARITY & TEST DISTANCE: HORIZONTAL AT 3 M								
NO.	FREQ. (MHz)	EMISSION LEVEL (dBuV/m)	LIMIT (dBuV/m)	MARGIN (dB)	ANTENNA HEIGHT (m)	TABLE ANGLE (Degree)	RAW VALUE (dBuV)	CORRECTION FACTOR (dB/m)
1	5150.00	56.0 PK	74.0	-18.0	1.67 H	54	50.50	5.50
2	5150.00	45.4 AV	54.0	-8.6	1.67 H	54	39.90	5.50
3	*5260.00	113.2 PK			1.54 H	46	73.60	39.60
4	*5260.00	102.8 AV			1.54 H	46	63.20	39.60
5	#10520.00	58.5 PK	74.0	-15.5	1.33 H	206	40.40	18.10
6	#10520.00	45.2 AV	54.0	-8.8	1.33 H	206	27.10	18.10

ANTENNA POLARITY & TEST DISTANCE: VERTICAL AT 3 M								
NO.	FREQ. (MHz)	EMISSION LEVEL (dBuV/m)	LIMIT (dBuV/m)	MARGIN (dB)	ANTENNA HEIGHT (m)	TABLE ANGLE (Degree)	RAW VALUE (dBuV)	CORRECTION FACTOR (dB/m)
1	5150.00	57.5 PK	74.0	-16.5	1.55 V	321	52.00	5.50
2	5150.00	46.0 AV	54.0	-8.0	1.55 V	321	40.50	5.50
3	*5260.00	114.5 PK			1.42 V	316	74.90	39.60
4	*5260.00	104.4 AV			1.42 V	316	64.80	39.60
5	#10520.00	59.7 PK	74.0	-14.3	1.47 V	58	41.60	18.10
6	#10520.00	46.2 AV	54.0	-7.8	1.47 V	58	28.10	18.10

REMARKS:

1. Emission Level(dBuV/m) = Raw Value(dBuV) + Correction Factor(dB/m)
2. Correction Factor(dB/m) = Antenna Factor(dB/m) + Cable Factor(dB) – Pre-Amplifier Factor(dB)
3. The other emission levels were very low against the limit.
4. Margin value = Emission Level – Limit value
5. " \* ": Fundamental frequency.
6. " # ": The radiated frequency is out of the restricted band.



CHANNEL	TX Channel 60	DETECTOR FUNCTION	Peak (PK)
FREQUENCY RANGE	1GHz ~ 40GHz		Average (AV)

**ANTENNA POLARITY & TEST DISTANCE: HORIZONTAL AT 3 M**

NO.	FREQ. (MHz)	EMISSION LEVEL (dBuV/m)	LIMIT (dBuV/m)	MARGIN (dB)	ANTENNA HEIGHT (m)	TABLE ANGLE (Degree)	RAW VALUE (dBuV)	CORRECTION FACTOR (dB/m)
1	*5300.00	112.5 PK			1.01 H	52	72.90	39.60
2	*5300.00	102.6 AV			1.01 H	52	63.00	39.60
3	10600.00	58.5 PK	74.0	-15.5	1.47 H	41	40.10	18.40
4	10600.00	45.5 AV	54.0	-8.5	1.47 H	41	27.10	18.40

**ANTENNA POLARITY & TEST DISTANCE: VERTICAL AT 3 M**

NO.	FREQ. (MHz)	EMISSION LEVEL (dBuV/m)	LIMIT (dBuV/m)	MARGIN (dB)	ANTENNA HEIGHT (m)	TABLE ANGLE (Degree)	RAW VALUE (dBuV)	CORRECTION FACTOR (dB/m)
1	*5300.00	114.3 PK			1.14 V	325	74.70	39.60
2	*5300.00	104.1 AV			1.14 V	325	64.50	39.60
3	10600.00	60.0 PK	74.0	-14.0	1.47 V	85	41.60	18.40
4	10600.00	46.9 AV	54.0	-7.1	1.47 V	85	28.50	18.40

**REMARKS:**

1. Emission Level(dBuV/m) = Raw Value(dBuV) + Correction Factor(dB/m)
2. Correction Factor(dB/m) = Antenna Factor(dB/m) + Cable Factor(dB) – Pre-Amplifier Factor(dB)
3. The other emission levels were very low against the limit.
4. Margin value = Emission Level – Limit value
5. " \* ": Fundamental frequency.

CHANNEL	TX Channel 64	DETECTOR FUNCTION	Peak (PK)
FREQUENCY RANGE	1GHz ~ 40GHz		Average (AV)

**ANTENNA POLARITY & TEST DISTANCE: HORIZONTAL AT 3 M**

NO.	FREQ. (MHz)	EMISSION LEVEL (dBuV/m)	LIMIT (dBuV/m)	MARGIN (dB)	ANTENNA HEIGHT (m)	TABLE ANGLE (Degree)	RAW VALUE (dBuV)	CORRECTION FACTOR (dB/m)
1	*5320.00	112.8 PK			1.24 H	53	73.10	39.70
2	*5320.00	102.7 AV			1.24 H	53	63.00	39.70
3	5350.00	58.1 PK	74.0	-15.9	1.52 H	69	52.40	5.70
4	5350.00	49.3 AV	54.0	-4.7	1.52 H	69	43.60	5.70
5	10640.00	58.4 PK	74.0	-15.6	1.32 H	69	40.00	18.40
6	10640.00	45.6 AV	54.0	-8.4	1.32 H	69	27.20	18.40

**ANTENNA POLARITY & TEST DISTANCE: VERTICAL AT 3 M**

NO.	FREQ. (MHz)	EMISSION LEVEL (dBuV/m)	LIMIT (dBuV/m)	MARGIN (dB)	ANTENNA HEIGHT (m)	TABLE ANGLE (Degree)	RAW VALUE (dBuV)	CORRECTION FACTOR (dB/m)
1	*5320.00	113.8 PK			1.06 V	319	74.10	39.70
2	*5320.00	103.8 AV			1.06 V	319	64.10	39.70
3	5350.00	67.1 PK	74.0	-6.9	2.05 V	352	61.40	5.70
4	5350.00	52.8 AV	54.0	-1.2	2.05 V	352	47.10	5.70
5	10640.00	60.0 PK	74.0	-14.0	1.22 V	36	41.60	18.40
6	10640.00	46.6 AV	54.0	-7.4	1.22 V	36	28.20	18.40

**REMARKS:**

1. Emission Level(dBuV/m) = Raw Value(dBuV) + Correction Factor(dB/m)
2. Correction Factor(dB/m) = Antenna Factor(dB/m) + Cable Factor(dB) – Pre-Amplifier Factor(dB)
3. The other emission levels were very low against the limit.
4. Margin value = Emission Level – Limit value
5. " \* ": Fundamental frequency.

CHANNEL	TX Channel 100	DETECTOR FUNCTION	Peak (PK)
FREQUENCY RANGE	1GHz ~ 40GHz		Average (AV)

**ANTENNA POLARITY & TEST DISTANCE: HORIZONTAL AT 3 M**

NO.	FREQ. (MHz)	EMISSION LEVEL (dBuV/m)	LIMIT (dBuV/m)	MARGIN (dB)	ANTENNA HEIGHT (m)	TABLE ANGLE (Degree)	RAW VALUE (dBuV)	CORRECTION FACTOR (dB/m)
1	5460.00	60.1 PK	74.0	-13.9	1.81 H	86	54.30	5.80
2	5460.00	45.8 AV	54.0	-8.2	1.81 H	86	40.00	5.80
3	#5470.00	62.9 PK	74.0	-11.1	1.70 H	85	57.00	5.90
4	#5470.00	48.9 AV	54.0	-5.1	1.70 H	85	43.00	5.90
5	*5500.00	112.6 PK			1.65 H	62	72.70	39.90
6	*5500.00	102.5 AV			1.65 H	62	62.60	39.90
7	11000.00	59.4 PK	74.0	-14.6	1.26 H	35	40.50	18.90
8	11000.00	46.0 AV	54.0	-8.0	1.26 H	35	27.10	18.90

**ANTENNA POLARITY & TEST DISTANCE: VERTICAL AT 3 M**

NO.	FREQ. (MHz)	EMISSION LEVEL (dBuV/m)	LIMIT (dBuV/m)	MARGIN (dB)	ANTENNA HEIGHT (m)	TABLE ANGLE (Degree)	RAW VALUE (dBuV)	CORRECTION FACTOR (dB/m)
1	5460.00	59.5 PK	74.0	-14.5	1.70 V	25	53.70	5.80
2	5460.00	46.3 AV	54.0	-7.7	1.70 V	25	40.50	5.80
3	#5470.00	67.9 PK	74.0	-6.1	1.63 V	15	62.00	5.90
4	#5470.00	51.8 AV	54.0	-2.2	1.63 V	15	45.90	5.90
5	*5500.00	115.9 PK			1.01 V	68	76.00	39.90
6	*5500.00	106.0 AV			1.01 V	68	66.10	39.90
7	11000.00	60.4 PK	74.0	-13.6	1.47 V	85	41.50	18.90
8	11000.00	47.0 AV	54.0	-7.0	1.47 V	85	28.10	18.90

**REMARKS:**

1. Emission Level(dBuV/m) = Raw Value(dBuV) + Correction Factor(dB/m)
2. Correction Factor(dB/m) = Antenna Factor(dB/m) + Cable Factor(dB) – Pre-Amplifier Factor(dB)
3. The other emission levels were very low against the limit.
4. Margin value = Emission Level – Limit value
5. " \* ": Fundamental frequency.
6. " # ": The radiated frequency is out of the restricted band.

CHANNEL	TX Channel 116	DETECTOR FUNCTION	Peak (PK)
FREQUENCY RANGE	1GHz ~ 40GHz		Average (AV)

**ANTENNA POLARITY & TEST DISTANCE: HORIZONTAL AT 3 M**

NO.	FREQ. (MHz)	EMISSION LEVEL (dBuV/m)	LIMIT (dBuV/m)	MARGIN (dB)	ANTENNA HEIGHT (m)	TABLE ANGLE (Degree)	RAW VALUE (dBuV)	CORRECTION FACTOR (dB/m)
1	*5580.00	111.8 PK			1.36 H	40	71.90	39.90
2	*5580.00	101.5 AV			1.36 H	40	61.60	39.90
3	11160.00	59.4 PK	74.0	-14.6	1.36 H	97	40.20	19.20
4	11160.00	46.4 AV	54.0	-7.6	1.36 H	97	27.20	19.20

**ANTENNA POLARITY & TEST DISTANCE: VERTICAL AT 3 M**

NO.	FREQ. (MHz)	EMISSION LEVEL (dBuV/m)	LIMIT (dBuV/m)	MARGIN (dB)	ANTENNA HEIGHT (m)	TABLE ANGLE (Degree)	RAW VALUE (dBuV)	CORRECTION FACTOR (dB/m)
1	*5580.00	113.8 PK			2.15 V	67	73.90	39.90
2	*5580.00	103.5 AV			2.15 V	67	63.60	39.90
3	11160.00	60.7 PK	74.0	-13.3	1.33 V	225	41.50	19.20
4	11160.00	47.4 AV	54.0	-6.6	1.33 V	225	28.20	19.20

**REMARKS:**

1. Emission Level(dBuV/m) = Raw Value(dBuV) + Correction Factor(dB/m)
2. Correction Factor(dB/m) = Antenna Factor(dB/m) + Cable Factor(dB) – Pre-Amplifier Factor(dB)
3. The other emission levels were very low against the limit.
4. Margin value = Emission Level – Limit value
5. " \* ": Fundamental frequency.

CHANNEL	TX Channel 140	DETECTOR FUNCTION	Peak (PK)
FREQUENCY RANGE	1GHz ~ 40GHz		Average (AV)

**ANTENNA POLARITY & TEST DISTANCE: HORIZONTAL AT 3 M**

NO.	FREQ. (MHz)	EMISSION LEVEL (dBuV/m)	LIMIT (dBuV/m)	MARGIN (dB)	ANTENNA HEIGHT (m)	TABLE ANGLE (Degree)	RAW VALUE (dBuV)	CORRECTION FACTOR (dB/m)
1	*5700.00	110.8 PK			1.34 H	47	70.50	40.30
2	*5700.00	101.2 AV			1.34 H	47	60.90	40.30
3	#5725.00	69.5 PK	74.0	-4.5	1.37 H	53	63.20	6.30
4	#5725.00	52.0 AV	54.0	-2.0	1.37 H	53	45.70	6.30
5	11400.00	59.7 PK	74.0	-14.3	1.35 H	47	40.00	19.70
6	11400.00	46.9 AV	54.0	-7.1	1.35 H	47	27.20	19.70

**ANTENNA POLARITY & TEST DISTANCE: VERTICAL AT 3 M**

NO.	FREQ. (MHz)	EMISSION LEVEL (dBuV/m)	LIMIT (dBuV/m)	MARGIN (dB)	ANTENNA HEIGHT (m)	TABLE ANGLE (Degree)	RAW VALUE (dBuV)	CORRECTION FACTOR (dB/m)
1	*5700.00	112.9 PK			1.13 V	19	72.60	40.30
2	*5700.00	102.7 AV			1.13 V	19	62.40	40.30
<b>3</b>	<b>#5725.00</b>	<b>73.7 PK</b>	<b>74.0</b>	<b>-0.3</b>	<b>1.00 V</b>	<b>30</b>	<b>67.40</b>	<b>6.30</b>
4	#5725.00	51.7 AV	54.0	-2.3	1.00 V	30	45.40	6.30
5	11400.00	61.3 PK	74.0	-12.7	1.05 V	22	41.60	19.70
6	11400.00	47.9 AV	54.0	-6.1	1.05 V	22	28.20	19.70

**REMARKS:**

1. Emission Level(dBuV/m) = Raw Value(dBuV) + Correction Factor(dB/m)
2. Correction Factor(dB/m) = Antenna Factor(dB/m) + Cable Factor(dB) – Pre-Amplifier Factor(dB)
3. The other emission levels were very low against the limit.
4. Margin value = Emission Level – Limit value
5. " \* ": Fundamental frequency.
6. " # ": The radiated frequency is out of the restricted band.

802.11n (HT40)

CHANNEL	TX Channel 54	DETECTOR FUNCTION	Peak (PK)
FREQUENCY RANGE	1GHz ~ 40GHz		Average (AV)

ANTENNA POLARITY & TEST DISTANCE: HORIZONTAL AT 3 M								
NO.	FREQ. (MHz)	EMISSION LEVEL (dBuV/m)	LIMIT (dBuV/m)	MARGIN (dB)	ANTENNA HEIGHT (m)	TABLE ANGLE (Degree)	RAW VALUE (dBuV)	CORRECTION FACTOR (dB/m)
1	5150.00	56.1 PK	74.0	-17.9	1.15 H	63	50.60	5.50
2	5150.00	45.5 AV	54.0	-8.5	1.15 H	63	40.00	5.50
3	*5270.00	107.6 PK			1.01 H	43	68.00	39.60
4	*5270.00	97.0 AV			1.01 H	43	57.40	39.60
5	#10540.00	58.1 PK	74.0	-15.9	1.36 H	98	40.00	18.10
6	#10540.00	45.1 AV	54.0	-8.9	1.36 H	98	27.00	18.10

ANTENNA POLARITY & TEST DISTANCE: VERTICAL AT 3 M								
NO.	FREQ. (MHz)	EMISSION LEVEL (dBuV/m)	LIMIT (dBuV/m)	MARGIN (dB)	ANTENNA HEIGHT (m)	TABLE ANGLE (Degree)	RAW VALUE (dBuV)	CORRECTION FACTOR (dB/m)
1	5150.00	57.5 PK	74.0	-16.5	1.17 V	330	52.00	5.50
2	5150.00	46.1 AV	54.0	-7.9	1.17 V	330	40.60	5.50
3	*5270.00	114.2 PK			1.66 V	309	74.60	39.60
4	*5270.00	103.0 AV			1.66 V	309	63.40	39.60
5	#10540.00	59.4 PK	74.0	-14.6	1.32 V	64	41.30	18.10
6	#10540.00	46.2 AV	54.0	-7.8	1.32 V	64	28.10	18.10

REMARKS:

1. Emission Level(dBuV/m) = Raw Value(dBuV) + Correction Factor(dB/m)
2. Correction Factor(dB/m) = Antenna Factor(dB/m) + Cable Factor(dB) – Pre-Amplifier Factor(dB)
3. The other emission levels were very low against the limit.
4. Margin value = Emission Level – Limit value
5. " \* ": Fundamental frequency.
6. " # ": The radiated frequency is out of the restricted band.

CHANNEL	TX Channel 62	DETECTOR FUNCTION	Peak (PK)
FREQUENCY RANGE	1GHz ~ 40GHz		Average (AV)

**ANTENNA POLARITY & TEST DISTANCE: HORIZONTAL AT 3 M**

NO.	FREQ. (MHz)	EMISSION LEVEL (dBuV/m)	LIMIT (dBuV/m)	MARGIN (dB)	ANTENNA HEIGHT (m)	TABLE ANGLE (Degree)	RAW VALUE (dBuV)	CORRECTION FACTOR (dB/m)
1	*5310.00	106.0 PK			1.46 H	55	66.40	39.60
2	*5310.00	95.7 AV			1.46 H	55	56.10	39.60
3	5350.00	69.3 PK	74.0	-4.7	1.58 H	63	63.60	5.70
4	5350.00	52.8 AV	54.0	-1.2	1.58 H	63	47.10	5.70
5	10620.00	58.4 PK	74.0	-15.6	1.26 H	55	40.10	18.30
6	10620.00	45.6 AV	54.0	-8.4	1.26 H	55	27.30	18.30

**ANTENNA POLARITY & TEST DISTANCE: VERTICAL AT 3 M**

NO.	FREQ. (MHz)	EMISSION LEVEL (dBuV/m)	LIMIT (dBuV/m)	MARGIN (dB)	ANTENNA HEIGHT (m)	TABLE ANGLE (Degree)	RAW VALUE (dBuV)	CORRECTION FACTOR (dB/m)
1	*5310.00	107.1 PK			1.48 V	327	67.50	39.60
2	*5310.00	96.7 AV			1.48 V	327	57.10	39.60
3	5350.00	70.2 PK	74.0	-3.8	2.22 V	315	64.50	5.70
4	5350.00	53.3 AV	54.0	-0.7	2.22 V	315	47.60	5.70
5	10620.00	59.5 PK	74.0	-14.5	1.55 V	226	41.20	18.30
6	10620.00	46.6 AV	54.0	-7.4	1.55 V	226	28.30	18.30

**REMARKS:**

1. Emission Level(dBuV/m) = Raw Value(dBuV) + Correction Factor(dB/m)
2. Correction Factor(dB/m) = Antenna Factor(dB/m) + Cable Factor(dB) – Pre-Amplifier Factor(dB)
3. The other emission levels were very low against the limit.
4. Margin value = Emission Level – Limit value
5. " \* ": Fundamental frequency.

CHANNEL	TX Channel 102	DETECTOR FUNCTION	Peak (PK)
FREQUENCY RANGE	1GHz ~ 40GHz		Average (AV)

**ANTENNA POLARITY & TEST DISTANCE: HORIZONTAL AT 3 M**

NO.	FREQ. (MHz)	EMISSION LEVEL (dBuV/m)	LIMIT (dBuV/m)	MARGIN (dB)	ANTENNA HEIGHT (m)	TABLE ANGLE (Degree)	RAW VALUE (dBuV)	CORRECTION FACTOR (dB/m)
1	5460.00	57.8 PK	74.0	-16.2	1.17 H	41	52.00	5.80
2	5460.00	44.8 AV	54.0	-9.2	1.17 H	41	39.00	5.80
3	#5470.00	58.5 PK	74.0	-15.5	1.63 H	98	52.60	5.90
4	#5470.00	46.5 AV	54.0	-7.5	1.63 H	98	40.60	5.90
5	*5510.00	103.9 PK			1.14 H	18	64.00	39.90
6	*5510.00	92.3 AV			1.14 H	18	52.40	39.90
7	11020.00	61.6 PK	74.0	-12.4	1.33 H	98	42.60	19.00
8	11020.00	48.0 AV	54.0	-6.0	1.33 H	98	29.00	19.00

**ANTENNA POLARITY & TEST DISTANCE: VERTICAL AT 3 M**

NO.	FREQ. (MHz)	EMISSION LEVEL (dBuV/m)	LIMIT (dBuV/m)	MARGIN (dB)	ANTENNA HEIGHT (m)	TABLE ANGLE (Degree)	RAW VALUE (dBuV)	CORRECTION FACTOR (dB/m)
1	5460.00	58.2 PK	74.0	-15.8	1.47 V	74	52.40	5.80
2	5460.00	48.3 AV	54.0	-5.7	1.47 V	74	42.50	5.80
3	#5470.00	63.8 PK	74.0	-10.2	1.68 V	54	57.90	5.90
4	#5470.00	52.1 AV	54.0	-1.9	1.68 V	54	46.20	5.90
5	*5510.00	112.4 PK			1.69 V	10	72.50	39.90
6	*5510.00	100.9 AV			1.69 V	10	61.00	39.90
7	11020.00	62.2 PK	74.0	-11.8	1.05 V	87	43.20	19.00
8	11020.00	49.1 AV	54.0	-4.9	1.05 V	87	30.10	19.00

**REMARKS:**

1. Emission Level(dBuV/m) = Raw Value(dBuV) + Correction Factor(dB/m)
2. Correction Factor(dB/m) = Antenna Factor(dB/m) + Cable Factor(dB) – Pre-Amplifier Factor(dB)
3. The other emission levels were very low against the limit.
4. Margin value = Emission Level – Limit value
5. " \* ": Fundamental frequency.
6. " # ": The radiated frequency is out of the restricted band.



CHANNEL	TX Channel 110	DETECTOR FUNCTION	Peak (PK)
FREQUENCY RANGE	1GHz ~ 40GHz		Average (AV)

**ANTENNA POLARITY & TEST DISTANCE: HORIZONTAL AT 3 M**

NO.	FREQ. (MHz)	EMISSION LEVEL (dBuV/m)	LIMIT (dBuV/m)	MARGIN (dB)	ANTENNA HEIGHT (m)	TABLE ANGLE (Degree)	RAW VALUE (dBuV)	CORRECTION FACTOR (dB/m)
1	*5550.00	102.6 PK			1.07 H	288	62.60	40.00
2	*5550.00	92.5 AV			1.07 H	288	52.50	40.00
3	11100.00	60.0 PK	74.0	-14.0	1.00 H	82	40.40	19.60
4	11100.00	47.4 AV	54.0	-6.6	1.00 H	82	27.80	19.60

**ANTENNA POLARITY & TEST DISTANCE: VERTICAL AT 3 M**

NO.	FREQ. (MHz)	EMISSION LEVEL (dBuV/m)	LIMIT (dBuV/m)	MARGIN (dB)	ANTENNA HEIGHT (m)	TABLE ANGLE (Degree)	RAW VALUE (dBuV)	CORRECTION FACTOR (dB/m)
1	*5550.00	111.5 PK			1.48 V	20	71.50	40.00
2	*5550.00	101.4 AV			1.48 V	20	61.40	40.00
3	11100.00	60.4 PK	74.0	-13.6	1.00 V	33	40.80	19.60
4	11100.00	47.8 AV	54.0	-6.2	1.00 V	33	28.20	19.60

**REMARKS:**

1. Emission Level(dBuV/m) = Raw Value(dBuV) + Correction Factor(dB/m)
2. Correction Factor(dB/m) = Antenna Factor(dB/m) + Cable Factor(dB) – Pre-Amplifier Factor(dB)
3. The other emission levels were very low against the limit.
4. Margin value = Emission Level – Limit value
5. " \* ": Fundamental frequency.

CHANNEL	TX Channel 134	DETECTOR FUNCTION	Peak (PK)
FREQUENCY RANGE	1GHz ~ 40GHz		Average (AV)

**ANTENNA POLARITY & TEST DISTANCE: HORIZONTAL AT 3 M**

NO.	FREQ. (MHz)	EMISSION LEVEL (dBuV/m)	LIMIT (dBuV/m)	MARGIN (dB)	ANTENNA HEIGHT (m)	TABLE ANGLE (Degree)	RAW VALUE (dBuV)	CORRECTION FACTOR (dB/m)
1	*5670.00	101.4 PK			1.00 H	247	61.20	40.20
2	*5670.00	90.8 AV			1.00 H	247	50.60	40.20
3	#5725.00	57.2 PK	74.0	-16.8	1.00 H	124	50.90	6.30
4	#5725.00	44.8 AV	54.0	-9.2	1.00 H	124	38.50	6.30
5	11340.00	58.1 PK	74.0	-15.9	1.00 H	94	38.40	19.70
6	11340.00	46.6 AV	54.0	-7.4	1.00 H	94	26.90	19.70

**ANTENNA POLARITY & TEST DISTANCE: VERTICAL AT 3 M**

NO.	FREQ. (MHz)	EMISSION LEVEL (dBuV/m)	LIMIT (dBuV/m)	MARGIN (dB)	ANTENNA HEIGHT (m)	TABLE ANGLE (Degree)	RAW VALUE (dBuV)	CORRECTION FACTOR (dB/m)
1	*5670.00	109.9 PK			1.54 V	16	69.70	40.20
2	*5670.00	100.0 AV			1.54 V	16	59.80	40.20
3	#5725.00	64.8 PK	74.0	-9.2	1.44 V	22	58.50	6.30
4	#5725.00	48.6 AV	54.0	-5.4	1.44 V	22	42.30	6.30
5	11340.00	59.3 PK	74.0	-14.7	1.00 V	11	39.60	19.70
6	11340.00	47.6 AV	54.0	-6.4	1.00 V	11	27.90	19.70

**REMARKS:**

1. Emission Level(dBuV/m) = Raw Value(dBuV) + Correction Factor(dB/m)
2. Correction Factor(dB/m) = Antenna Factor(dB/m) + Cable Factor(dB) – Pre-Amplifier Factor(dB)
3. The other emission levels were very low against the limit.
4. Margin value = Emission Level – Limit value
5. " \* ": Fundamental frequency.
6. " # ": The radiated frequency is out of the restricted band.

802.11ac (VHT80)

CHANNEL	TX Channel 58	DETECTOR FUNCTION	Peak (PK)
FREQUENCY RANGE	1GHz ~ 40GHz		Average (AV)

ANTENNA POLARITY & TEST DISTANCE: HORIZONTAL AT 3 M								
NO.	FREQ. (MHz)	EMISSION LEVEL (dBuV/m)	LIMIT (dBuV/m)	MARGIN (dB)	ANTENNA HEIGHT (m)	TABLE ANGLE (Degree)	RAW VALUE (dBuV)	CORRECTION FACTOR (dB/m)
1	*5290.00	100.8 PK			1.42 H	59	61.20	39.60
2	*5290.00	90.4 AV			1.42 H	59	50.80	39.60
3	5350.00	73.1 PK	74.0	-0.9	1.50 H	69	67.40	5.70
4	5350.00	45.6 AV	54.0	-8.4	1.50 H	69	39.90	5.70
5	#10580.00	58.3 PK	74.0	-15.7	1.32 H	65	40.00	18.30
6	#10580.00	45.4 AV	54.0	-8.6	1.32 H	65	27.10	18.30

ANTENNA POLARITY & TEST DISTANCE: VERTICAL AT 3 M								
NO.	FREQ. (MHz)	EMISSION LEVEL (dBuV/m)	LIMIT (dBuV/m)	MARGIN (dB)	ANTENNA HEIGHT (m)	TABLE ANGLE (Degree)	RAW VALUE (dBuV)	CORRECTION FACTOR (dB/m)
1	*5290.00	103.9 PK			1.00 V	315	64.30	39.60
2	*5290.00	92.1 AV			1.00 V	315	52.50	39.60
3	5350.00	73.5 PK	74.0	-0.5	1.96 V	327	67.80	5.70
4	5350.00	46.5 AV	54.0	-7.5	1.96 V	327	40.80	5.70
5	#10580.00	59.9 PK	74.0	-14.1	1.47 V	87	41.60	18.30
6	#10580.00	46.4 AV	54.0	-7.6	1.47 V	87	28.10	18.30

REMARKS:

1. Emission Level(dBuV/m) = Raw Value(dBuV) + Correction Factor(dB/m)
2. Correction Factor(dB/m) = Antenna Factor(dB/m) + Cable Factor(dB) – Pre-Amplifier Factor(dB)
3. The other emission levels were very low against the limit.
4. Margin value = Emission Level – Limit value
5. " \* ": Fundamental frequency.
6. " # ": The radiated frequency is out of the restricted band.

CHANNEL	TX Channel 106	DETECTOR FUNCTION	Peak (PK)
FREQUENCY RANGE	1GHz ~ 40GHz		Average (AV)

**ANTENNA POLARITY & TEST DISTANCE: HORIZONTAL AT 3 M**

NO.	FREQ. (MHz)	EMISSION LEVEL (dBuV/m)	LIMIT (dBuV/m)	MARGIN (dB)	ANTENNA HEIGHT (m)	TABLE ANGLE (Degree)	RAW VALUE (dBuV)	CORRECTION FACTOR (dB/m)
1	5460.00	65.2 PK	74.0	-8.8	1.24 H	310	59.40	5.80
2	5460.00	44.0 AV	54.0	-10.0	1.24 H	310	38.20	5.80
3	#5470.00	66.1 PK	74.0	-7.9	1.24 H	299	60.20	5.90
4	#5470.00	44.4 AV	54.0	-9.6	1.24 H	299	38.50	5.90
5	*5530.00	96.3 PK			1.20 H	277	56.40	39.90
6	*5530.00	85.0 AV			1.20 H	277	45.10	39.90
7	11060.00	57.7 PK	74.0	-16.3	1.00 H	84	38.50	19.20
8	11060.00	45.8 AV	54.0	-8.2	1.00 H	84	26.60	19.20

**ANTENNA POLARITY & TEST DISTANCE: VERTICAL AT 3 M**

NO.	FREQ. (MHz)	EMISSION LEVEL (dBuV/m)	LIMIT (dBuV/m)	MARGIN (dB)	ANTENNA HEIGHT (m)	TABLE ANGLE (Degree)	RAW VALUE (dBuV)	CORRECTION FACTOR (dB/m)
1	5460.00	71.4 PK	74.0	-2.6	1.30 V	17	65.60	5.80
2	5460.00	47.2 AV	54.0	-6.8	1.30 V	17	41.40	5.80
3	#5470.00	72.5 PK	74.0	-1.5	1.30 V	19	66.60	5.90
4	#5470.00	47.8 AV	54.0	-6.2	1.30 V	19	41.90	5.90
5	*5530.00	103.4 PK			1.38 V	21	63.50	39.90
6	*5530.00	93.6 AV			1.38 V	21	53.70	39.90
7	11060.00	58.6 PK	74.0	-15.4	1.00 V	4	39.40	19.20
8	11060.00	45.8 AV	54.0	-8.2	1.00 V	4	26.60	19.20

**REMARKS:**

1. Emission Level(dBuV/m) = Raw Value(dBuV) + Correction Factor(dB/m)
2. Correction Factor(dB/m) = Antenna Factor(dB/m) + Cable Factor(dB) – Pre-Amplifier Factor(dB)
3. The other emission levels were very low against the limit.
4. Margin value = Emission Level – Limit value
5. " \* ": Fundamental frequency.
6. " # ": The radiated frequency is out of the restricted band.

Test Mode B

3TX

802.11a

CHANNEL	TX Channel 52	DETECTOR FUNCTION	Peak (PK)
FREQUENCY RANGE	1GHz ~ 40GHz		Average (AV)

ANTENNA POLARITY & TEST DISTANCE: HORIZONTAL AT 3 M

NO.	FREQ. (MHz)	EMISSION LEVEL (dBuV/m)	LIMIT (dBuV/m)	MARGIN (dB)	ANTENNA HEIGHT (m)	TABLE ANGLE (Degree)	RAW VALUE (dBuV)	CORRECTION FACTOR (dB/m)
1	1052.00	32.3 PK	74.0	-41.7	1.03 H	25	40.00	-7.70
2	1052.00	19.4 AV	54.0	-34.6	1.03 H	25	27.10	-7.70
3	*5260.00	112.4 PK			1.86 H	61	72.80	39.60
4	*5260.00	103.2 AV			1.86 H	61	63.60	39.60
5	#10520.00	58.3 PK	74.0	-15.7	1.22 H	36	40.20	18.10
6	#10520.00	45.2 AV	54.0	-8.8	1.22 H	36	27.10	18.10

ANTENNA POLARITY & TEST DISTANCE: VERTICAL AT 3 M

NO.	FREQ. (MHz)	EMISSION LEVEL (dBuV/m)	LIMIT (dBuV/m)	MARGIN (dB)	ANTENNA HEIGHT (m)	TABLE ANGLE (Degree)	RAW VALUE (dBuV)	CORRECTION FACTOR (dB/m)
1	5150.00	56.5 PK	74.0	-17.5	1.75 V	20	51.00	5.50
2	5150.00	46.0 AV	54.0	-8.0	1.75 V	20	40.50	5.50
3	*5260.00	115.9 PK			1.71 V	15	76.30	39.60
4	*5260.00	106.1 AV			1.71 V	15	66.50	39.60
5	#10520.00	59.6 PK	74.0	-14.4	1.49 V	65	41.50	18.10
6	#10520.00	46.5 AV	54.0	-7.5	1.49 V	65	28.40	18.10

REMARKS:

1. Emission Level(dBuV/m) = Raw Value(dBuV) + Correction Factor(dB/m)
2. Correction Factor(dB/m) = Antenna Factor(dB/m) + Cable Factor(dB) – Pre-Amplifier Factor(dB)
3. The other emission levels were very low against the limit.
4. Margin value = Emission Level – Limit value
5. " \* ": Fundamental frequency.
6. " # ": The radiated frequency is out of the restricted band.

CHANNEL	TX Channel 60	DETECTOR FUNCTION	Peak (PK)
FREQUENCY RANGE	1GHz ~ 40GHz		Average (AV)

**ANTENNA POLARITY & TEST DISTANCE: HORIZONTAL AT 3 M**

NO.	FREQ. (MHz)	EMISSION LEVEL (dBuV/m)	LIMIT (dBuV/m)	MARGIN (dB)	ANTENNA HEIGHT (m)	TABLE ANGLE (Degree)	RAW VALUE (dBuV)	CORRECTION FACTOR (dB/m)
1	*5300.00	113.8 PK			1.82 H	59	74.20	39.60
2	*5300.00	104.0 AV			1.82 H	59	64.40	39.60
3	10600.00	58.4 PK	74.0	-15.6	1.26 H	325	40.00	18.40
4	10600.00	45.8 AV	54.0	-8.2	1.26 H	325	27.40	18.40

**ANTENNA POLARITY & TEST DISTANCE: VERTICAL AT 3 M**

NO.	FREQ. (MHz)	EMISSION LEVEL (dBuV/m)	LIMIT (dBuV/m)	MARGIN (dB)	ANTENNA HEIGHT (m)	TABLE ANGLE (Degree)	RAW VALUE (dBuV)	CORRECTION FACTOR (dB/m)
1	*5300.00	115.8 PK			1.94 V	14	76.20	39.60
2	*5300.00	106.1 AV			1.94 V	14	66.50	39.60
3	10600.00	60.3 PK	74.0	-13.7	1.56 V	302	41.90	18.40
4	10600.00	47.4 AV	54.0	-6.6	1.56 V	302	29.00	18.40

**REMARKS:**

1. Emission Level(dBuV/m) = Raw Value(dBuV) + Correction Factor(dB/m)
2. Correction Factor(dB/m) = Antenna Factor(dB/m) + Cable Factor(dB) – Pre-Amplifier Factor(dB)
3. The other emission levels were very low against the limit.
4. Margin value = Emission Level – Limit value
5. " \* ": Fundamental frequency.

CHANNEL	TX Channel 64	DETECTOR FUNCTION	Peak (PK)
FREQUENCY RANGE	1GHz ~ 40GHz		Average (AV)

**ANTENNA POLARITY & TEST DISTANCE: HORIZONTAL AT 3 M**

NO.	FREQ. (MHz)	EMISSION LEVEL (dBuV/m)	LIMIT (dBuV/m)	MARGIN (dB)	ANTENNA HEIGHT (m)	TABLE ANGLE (Degree)	RAW VALUE (dBuV)	CORRECTION FACTOR (dB/m)
1	*5320.00	114.5 PK			1.77 H	51	74.80	39.70
2	*5320.00	104.6 AV			1.77 H	51	64.90	39.70
3	5350.00	61.8 PK	74.0	-12.2	1.80 H	55	56.10	5.70
4	5350.00	48.3 AV	54.0	-5.7	1.80 H	55	42.60	5.70
5	10640.00	58.4 PK	74.0	-15.6	1.27 H	41	40.00	18.40
6	10640.00	45.8 AV	54.0	-8.2	1.27 H	41	27.40	18.40

**ANTENNA POLARITY & TEST DISTANCE: VERTICAL AT 3 M**

NO.	FREQ. (MHz)	EMISSION LEVEL (dBuV/m)	LIMIT (dBuV/m)	MARGIN (dB)	ANTENNA HEIGHT (m)	TABLE ANGLE (Degree)	RAW VALUE (dBuV)	CORRECTION FACTOR (dB/m)
1	*5320.00	116.5 PK			1.63 V	13	76.80	39.70
2	*5320.00	106.4 AV			1.63 V	13	66.70	39.70
3	5350.00	69.5 PK	74.0	-4.5	1.64 V	360	63.80	5.70
4	5350.00	50.0 AV	54.0	-4.0	1.64 V	360	44.30	5.70
5	10640.00	59.9 PK	74.0	-14.1	1.36 V	98	41.50	18.40
6	10640.00	47.0 AV	54.0	-7.0	1.36 V	98	28.60	18.40

**REMARKS:**

1. Emission Level(dBuV/m) = Raw Value(dBuV) + Correction Factor(dB/m)
2. Correction Factor(dB/m) = Antenna Factor(dB/m) + Cable Factor(dB) – Pre-Amplifier Factor(dB)
3. The other emission levels were very low against the limit.
4. Margin value = Emission Level – Limit value
5. " \* ": Fundamental frequency.

CHANNEL	TX Channel 100	DETECTOR FUNCTION	Peak (PK)
FREQUENCY RANGE	1GHz ~ 40GHz		Average (AV)

**ANTENNA POLARITY & TEST DISTANCE: HORIZONTAL AT 3 M**

NO.	FREQ. (MHz)	EMISSION LEVEL (dBuV/m)	LIMIT (dBuV/m)	MARGIN (dB)	ANTENNA HEIGHT (m)	TABLE ANGLE (Degree)	RAW VALUE (dBuV)	CORRECTION FACTOR (dB/m)
1	5460.00	55.8 PK	74.0	-18.2	1.50 H	90	50.00	5.80
2	5460.00	44.6 AV	54.0	-9.4	1.50 H	90	38.80	5.80
3	#5470.00	57.4 PK	74.0	-16.6	1.47 H	85	51.50	5.90
4	#5470.00	45.8 AV	54.0	-8.2	1.47 H	85	39.90	5.90
5	*5500.00	113.9 PK			1.81 H	51	74.00	39.90
6	*5500.00	105.1 AV			1.81 H	51	65.20	39.90
7	11000.00	58.9 PK	74.0	-15.1	1.26 H	35	40.00	18.90
8	11000.00	46.1 AV	54.0	-7.9	1.26 H	35	27.20	18.90

**ANTENNA POLARITY & TEST DISTANCE: VERTICAL AT 3 M**

NO.	FREQ. (MHz)	EMISSION LEVEL (dBuV/m)	LIMIT (dBuV/m)	MARGIN (dB)	ANTENNA HEIGHT (m)	TABLE ANGLE (Degree)	RAW VALUE (dBuV)	CORRECTION FACTOR (dB/m)
1	5460.00	57.3 PK	74.0	-16.7	1.55 V	50	51.50	5.80
2	5460.00	45.5 AV	54.0	-8.5	1.55 V	50	39.70	5.80
3	#5470.00	59.9 PK	74.0	-14.1	1.60 V	44	54.00	5.90
4	#5470.00	46.2 AV	54.0	-7.8	1.60 V	44	40.30	5.90
5	*5500.00	114.2 PK			1.00 V	47	74.30	39.90
6	*5500.00	105.2 AV			1.00 V	47	65.30	39.90
7	11000.00	60.4 PK	74.0	-13.6	1.36 V	97	41.50	18.90
8	11000.00	47.1 AV	54.0	-6.9	1.36 V	97	28.20	18.90

**REMARKS:**

1. Emission Level(dBuV/m) = Raw Value(dBuV) + Correction Factor(dB/m)
2. Correction Factor(dB/m) = Antenna Factor(dB/m) + Cable Factor(dB) – Pre-Amplifier Factor(dB)
3. The other emission levels were very low against the limit.
4. Margin value = Emission Level – Limit value
5. " \* ": Fundamental frequency.
6. " # ": The radiated frequency is out of the restricted band.



CHANNEL	TX Channel 116	DETECTOR FUNCTION	Peak (PK)
FREQUENCY RANGE	1GHz ~ 40GHz		Average (AV)

**ANTENNA POLARITY & TEST DISTANCE: HORIZONTAL AT 3 M**

NO.	FREQ. (MHz)	EMISSION LEVEL (dBuV/m)	LIMIT (dBuV/m)	MARGIN (dB)	ANTENNA HEIGHT (m)	TABLE ANGLE (Degree)	RAW VALUE (dBuV)	CORRECTION FACTOR (dB/m)
1	*5580.00	114.1 PK			1.73 H	52	74.20	39.90
2	*5580.00	104.1 AV			1.73 H	52	64.20	39.90
3	11160.00	59.3 PK	74.0	-14.7	1.36 H	97	40.10	19.20
4	11160.00	46.4 AV	54.0	-7.6	1.36 H	97	27.20	19.20

**ANTENNA POLARITY & TEST DISTANCE: VERTICAL AT 3 M**

NO.	FREQ. (MHz)	EMISSION LEVEL (dBuV/m)	LIMIT (dBuV/m)	MARGIN (dB)	ANTENNA HEIGHT (m)	TABLE ANGLE (Degree)	RAW VALUE (dBuV)	CORRECTION FACTOR (dB/m)
1	*5580.00	115.1 PK			1.79 V	70	75.20	39.90
2	*5580.00	105.6 AV			1.79 V	70	65.70	39.90
3	11160.00	60.7 PK	74.0	-13.3	1.26 V	38	41.50	19.20
4	11160.00	47.8 AV	54.0	-6.2	1.26 V	38	28.60	19.20

**REMARKS:**

1. Emission Level(dBuV/m) = Raw Value(dBuV) + Correction Factor(dB/m)
2. Correction Factor(dB/m) = Antenna Factor(dB/m) + Cable Factor(dB) – Pre-Amplifier Factor(dB)
3. The other emission levels were very low against the limit.
4. Margin value = Emission Level – Limit value
5. " \* ": Fundamental frequency.

CHANNEL	TX Channel 140	DETECTOR FUNCTION	Peak (PK)
FREQUENCY RANGE	1GHz ~ 40GHz		Average (AV)

**ANTENNA POLARITY & TEST DISTANCE: HORIZONTAL AT 3 M**

NO.	FREQ. (MHz)	EMISSION LEVEL (dBuV/m)	LIMIT (dBuV/m)	MARGIN (dB)	ANTENNA HEIGHT (m)	TABLE ANGLE (Degree)	RAW VALUE (dBuV)	CORRECTION FACTOR (dB/m)
1	*5700.00	115.0 PK			1.83 H	45	74.70	40.30
2	*5700.00	105.2 AV			1.83 H	45	64.90	40.30
3	#5725.00	67.3 PK	74.0	-6.7	1.74 H	55	61.00	6.30
4	#5725.00	50.3 AV	54.0	-3.7	1.74 H	55	44.00	6.30
5	11400.00	60.6 PK	74.0	-13.4	1.32 H	69	40.90	19.70
6	11400.00	46.9 AV	54.0	-7.1	1.32 H	69	27.20	19.70

**ANTENNA POLARITY & TEST DISTANCE: VERTICAL AT 3 M**

NO.	FREQ. (MHz)	EMISSION LEVEL (dBuV/m)	LIMIT (dBuV/m)	MARGIN (dB)	ANTENNA HEIGHT (m)	TABLE ANGLE (Degree)	RAW VALUE (dBuV)	CORRECTION FACTOR (dB/m)
1	*5700.00	115.5 PK			2.08 V	328	75.20	40.30
2	*5700.00	105.6 AV			2.08 V	328	65.30	40.30
3	#5725.00	67.2 PK	74.0	-6.8	2.20 V	6	60.90	6.30
4	#5725.00	52.0 AV	54.0	-2.0	2.20 V	6	45.70	6.30
5	11400.00	62.2 PK	74.0	-11.8	1.26 V	97	42.50	19.70
6	11400.00	48.1 AV	54.0	-5.9	1.26 V	97	28.40	19.70

**REMARKS:**

1. Emission Level(dBuV/m) = Raw Value(dBuV) + Correction Factor(dB/m)
2. Correction Factor(dB/m) = Antenna Factor(dB/m) + Cable Factor(dB) – Pre-Amplifier Factor(dB)
3. The other emission levels were very low against the limit.
4. Margin value = Emission Level – Limit value
5. " \* ": Fundamental frequency.
6. " # ": The radiated frequency is out of the restricted band.

802.11n (HT20)

CHANNEL	TX Channel 52	DETECTOR FUNCTION	Peak (PK)
FREQUENCY RANGE	1GHz ~ 40GHz		Average (AV)

ANTENNA POLARITY & TEST DISTANCE: HORIZONTAL AT 3 M								
NO.	FREQ. (MHz)	EMISSION LEVEL (dBuV/m)	LIMIT (dBuV/m)	MARGIN (dB)	ANTENNA HEIGHT (m)	TABLE ANGLE (Degree)	RAW VALUE (dBuV)	CORRECTION FACTOR (dB/m)
1	5150.00	55.7 PK	74.0	-18.3	1.06 H	81	50.20	5.50
2	5150.00	44.9 AV	54.0	-9.1	1.06 H	81	39.40	5.50
3	*5260.00	111.4 PK			1.84 H	32	71.80	39.60
4	*5260.00	102.3 AV			1.84 H	32	62.70	39.60
5	#10520.00	58.2 PK	74.0	-15.8	1.24 H	39	40.10	18.10
6	#10520.00	45.0 AV	54.0	-9.0	1.24 H	39	26.90	18.10

ANTENNA POLARITY & TEST DISTANCE: VERTICAL AT 3 M								
NO.	FREQ. (MHz)	EMISSION LEVEL (dBuV/m)	LIMIT (dBuV/m)	MARGIN (dB)	ANTENNA HEIGHT (m)	TABLE ANGLE (Degree)	RAW VALUE (dBuV)	CORRECTION FACTOR (dB/m)
1	5150.00	56.1 PK	74.0	-17.9	1.72 V	25	50.60	5.50
2	5150.00	45.7 AV	54.0	-8.3	1.72 V	25	40.20	5.50
3	*5260.00	115.1 PK			1.77 V	10	75.50	39.60
4	*5260.00	105.3 AV			1.77 V	10	65.70	39.60
5	#10520.00	59.0 PK	74.0	-15.0	1.44 V	75	40.90	18.10
6	#10520.00	46.2 AV	54.0	-7.8	1.44 V	75	28.10	18.10

REMARKS:

1. Emission Level(dBuV/m) = Raw Value(dBuV) + Correction Factor(dB/m)
2. Correction Factor(dB/m) = Antenna Factor(dB/m) + Cable Factor(dB) – Pre-Amplifier Factor(dB)
3. The other emission levels were very low against the limit.
4. Margin value = Emission Level – Limit value
5. " \* ": Fundamental frequency.
6. " # ": The radiated frequency is out of the restricted band.

CHANNEL	TX Channel 60	DETECTOR FUNCTION	Peak (PK)
FREQUENCY RANGE	1GHz ~ 40GHz		Average (AV)

**ANTENNA POLARITY & TEST DISTANCE: HORIZONTAL AT 3 M**

NO.	FREQ. (MHz)	EMISSION LEVEL (dBuV/m)	LIMIT (dBuV/m)	MARGIN (dB)	ANTENNA HEIGHT (m)	TABLE ANGLE (Degree)	RAW VALUE (dBuV)	CORRECTION FACTOR (dB/m)
1	*5300.00	113.2 PK			1.20 H	94	73.60	39.60
2	*5300.00	103.4 AV			1.20 H	94	63.80	39.60
3	10600.00	57.9 PK	74.0	-16.1	1.68 H	357	39.50	18.40
4	10600.00	45.7 AV	54.0	-8.3	1.68 H	357	27.30	18.40

**ANTENNA POLARITY & TEST DISTANCE: VERTICAL AT 3 M**

NO.	FREQ. (MHz)	EMISSION LEVEL (dBuV/m)	LIMIT (dBuV/m)	MARGIN (dB)	ANTENNA HEIGHT (m)	TABLE ANGLE (Degree)	RAW VALUE (dBuV)	CORRECTION FACTOR (dB/m)
1	*5300.00	115.0 PK			1.43 V	45	75.40	39.60
2	*5300.00	105.1 AV			1.43 V	45	65.50	39.60
3	10600.00	59.9 PK	74.0	-14.1	1.61 V	322	41.50	18.40
4	10600.00	47.0 AV	54.0	-7.0	1.61 V	322	28.60	18.40

**REMARKS:**

1. Emission Level(dBuV/m) = Raw Value(dBuV) + Correction Factor(dB/m)
2. Correction Factor(dB/m) = Antenna Factor(dB/m) + Cable Factor(dB) – Pre-Amplifier Factor(dB)
3. The other emission levels were very low against the limit.
4. Margin value = Emission Level – Limit value
5. " \* ": Fundamental frequency.

CHANNEL	TX Channel 64	DETECTOR FUNCTION	Peak (PK)
FREQUENCY RANGE	1GHz ~ 40GHz		Average (AV)

**ANTENNA POLARITY & TEST DISTANCE: HORIZONTAL AT 3 M**

NO.	FREQ. (MHz)	EMISSION LEVEL (dBuV/m)	LIMIT (dBuV/m)	MARGIN (dB)	ANTENNA HEIGHT (m)	TABLE ANGLE (Degree)	RAW VALUE (dBuV)	CORRECTION FACTOR (dB/m)
1	*5320.00	113.6 PK			1.88 H	50	73.90	39.70
2	*5320.00	103.6 AV			1.88 H	50	63.90	39.70
3	5350.00	61.7 PK	74.0	-12.3	1.74 H	16	56.00	5.70
4	5350.00	47.9 AV	54.0	-6.1	1.74 H	16	42.20	5.70
5	10640.00	58.2 PK	74.0	-15.8	1.79 H	45	39.80	18.40
6	10640.00	45.5 AV	54.0	-8.5	1.79 H	45	27.10	18.40

**ANTENNA POLARITY & TEST DISTANCE: VERTICAL AT 3 M**

NO.	FREQ. (MHz)	EMISSION LEVEL (dBuV/m)	LIMIT (dBuV/m)	MARGIN (dB)	ANTENNA HEIGHT (m)	TABLE ANGLE (Degree)	RAW VALUE (dBuV)	CORRECTION FACTOR (dB/m)
1	*5320.00	115.6 PK			1.39 V	34	75.90	39.70
2	*5320.00	106.0 AV			1.39 V	34	66.30	39.70
3	5350.00	62.0 PK	74.0	-12.0	1.40 V	6	56.30	5.70
4	5350.00	49.2 AV	54.0	-4.8	1.40 V	6	43.50	5.70
5	10640.00	59.5 PK	74.0	-14.5	1.69 V	87	41.10	18.40
6	10640.00	46.9 AV	54.0	-7.1	1.69 V	87	28.50	18.40

**REMARKS:**

1. Emission Level(dBuV/m) = Raw Value(dBuV) + Correction Factor(dB/m)
2. Correction Factor(dB/m) = Antenna Factor(dB/m) + Cable Factor(dB) – Pre-Amplifier Factor(dB)
3. The other emission levels were very low against the limit.
4. Margin value = Emission Level – Limit value
5. " \* ": Fundamental frequency.

CHANNEL	TX Channel 100	DETECTOR FUNCTION	Peak (PK)
FREQUENCY RANGE	1GHz ~ 40GHz		Average (AV)

**ANTENNA POLARITY & TEST DISTANCE: HORIZONTAL AT 3 M**

NO.	FREQ. (MHz)	EMISSION LEVEL (dBuV/m)	LIMIT (dBuV/m)	MARGIN (dB)	ANTENNA HEIGHT (m)	TABLE ANGLE (Degree)	RAW VALUE (dBuV)	CORRECTION FACTOR (dB/m)
1	5460.00	55.3 PK	74.0	-18.7	1.00 H	35	49.50	5.80
2	5460.00	44.0 AV	54.0	-10.0	1.00 H	35	38.20	5.80
3	#5470.00	57.1 PK	74.0	-16.9	1.00 H	35	51.20	5.90
4	#5470.00	44.1 AV	54.0	-9.9	1.00 H	35	38.20	5.90
5	*5500.00	107.5 PK			1.57 H	82	67.60	39.90
6	*5500.00	96.3 AV			1.57 H	82	56.40	39.90
7	11000.00	58.3 PK	74.0	-15.7	1.02 H	19	39.40	18.90
8	11000.00	46.0 AV	54.0	-8.0	1.02 H	19	27.10	18.90

**ANTENNA POLARITY & TEST DISTANCE: VERTICAL AT 3 M**

NO.	FREQ. (MHz)	EMISSION LEVEL (dBuV/m)	LIMIT (dBuV/m)	MARGIN (dB)	ANTENNA HEIGHT (m)	TABLE ANGLE (Degree)	RAW VALUE (dBuV)	CORRECTION FACTOR (dB/m)
1	5460.00	57.0 PK	74.0	-17.0	1.28 V	12	51.20	5.80
2	5460.00	45.4 AV	54.0	-8.6	1.28 V	12	39.60	5.80
3	#5470.00	59.6 PK	74.0	-14.4	1.28 V	12	53.70	5.90
4	#5470.00	45.8 AV	54.0	-8.2	1.28 V	12	39.90	5.90
5	*5500.00	113.7 PK			1.93 V	23	73.80	39.90
6	*5500.00	104.6 AV			1.93 V	23	64.70	39.90
7	11000.00	60.1 PK	74.0	-13.9	1.80 V	50	41.20	18.90
8	11000.00	47.0 AV	54.0	-7.0	1.80 V	50	28.10	18.90

**REMARKS:**

1. Emission Level(dBuV/m) = Raw Value(dBuV) + Correction Factor(dB/m)
2. Correction Factor(dB/m) = Antenna Factor(dB/m) + Cable Factor(dB) – Pre-Amplifier Factor(dB)
3. The other emission levels were very low against the limit.
4. Margin value = Emission Level – Limit value
5. " \* ": Fundamental frequency.
6. " # ": The radiated frequency is out of the restricted band.

CHANNEL	TX Channel 116	DETECTOR FUNCTION	Peak (PK)
FREQUENCY RANGE	1GHz ~ 40GHz		Average (AV)

**ANTENNA POLARITY & TEST DISTANCE: HORIZONTAL AT 3 M**

NO.	FREQ. (MHz)	EMISSION LEVEL (dBuV/m)	LIMIT (dBuV/m)	MARGIN (dB)	ANTENNA HEIGHT (m)	TABLE ANGLE (Degree)	RAW VALUE (dBuV)	CORRECTION FACTOR (dB/m)
1	*5580.00	106.3 PK			1.56 H	70	66.40	39.90
2	*5580.00	96.3 AV			1.56 H	70	56.40	39.90
3	11160.00	58.8 PK	74.0	-15.2	1.00 H	56	39.60	19.20
4	11160.00	45.6 AV	54.0	-8.4	1.00 H	56	26.40	19.20

**ANTENNA POLARITY & TEST DISTANCE: VERTICAL AT 3 M**

NO.	FREQ. (MHz)	EMISSION LEVEL (dBuV/m)	LIMIT (dBuV/m)	MARGIN (dB)	ANTENNA HEIGHT (m)	TABLE ANGLE (Degree)	RAW VALUE (dBuV)	CORRECTION FACTOR (dB/m)
1	*5580.00	113.1 PK			1.38 V	23	73.20	39.90
2	*5580.00	102.9 AV			1.38 V	23	63.00	39.90
3	11160.00	60.5 PK	74.0	-13.5	1.00 V	134	41.30	19.20
4	11160.00	47.3 AV	54.0	-6.7	1.00 V	134	28.10	19.20

**REMARKS:**

1. Emission Level(dBuV/m) = Raw Value(dBuV) + Correction Factor(dB/m)
2. Correction Factor(dB/m) = Antenna Factor(dB/m) + Cable Factor(dB) – Pre-Amplifier Factor(dB)
3. The other emission levels were very low against the limit.
4. Margin value = Emission Level – Limit value
5. " \* ": Fundamental frequency.

CHANNEL	TX Channel 140	DETECTOR FUNCTION	Peak (PK)
FREQUENCY RANGE	1GHz ~ 40GHz		Average (AV)

**ANTENNA POLARITY & TEST DISTANCE: HORIZONTAL AT 3 M**

NO.	FREQ. (MHz)	EMISSION LEVEL (dBuV/m)	LIMIT (dBuV/m)	MARGIN (dB)	ANTENNA HEIGHT (m)	TABLE ANGLE (Degree)	RAW VALUE (dBuV)	CORRECTION FACTOR (dB/m)
1	*5700.00	104.9 PK			1.00 H	9	64.60	40.30
2	*5700.00	95.2 AV			1.00 H	9	54.90	40.30
3	#5725.00	57.3 PK	74.0	-16.7	1.02 H	336	51.00	6.30
4	#5725.00	44.1 AV	54.0	-9.9	1.02 H	336	37.80	6.30
5	11400.00	60.5 PK	74.0	-13.5	1.77 H	232	40.80	19.70
6	11400.00	46.5 AV	54.0	-7.5	1.77 H	232	26.80	19.70

**ANTENNA POLARITY & TEST DISTANCE: VERTICAL AT 3 M**

NO.	FREQ. (MHz)	EMISSION LEVEL (dBuV/m)	LIMIT (dBuV/m)	MARGIN (dB)	ANTENNA HEIGHT (m)	TABLE ANGLE (Degree)	RAW VALUE (dBuV)	CORRECTION FACTOR (dB/m)
1	*5700.00	113.2 PK			1.50 V	78	72.90	40.30
2	*5700.00	102.9 AV			1.50 V	78	62.60	40.30
3	#5725.00	60.6 PK	74.0	-13.4	1.42 V	12	54.30	6.30
4	#5725.00	47.9 AV	54.0	-6.1	1.42 V	12	41.60	6.30
5	11400.00	62.1 PK	74.0	-11.9	1.78 V	325	42.40	19.70
6	11400.00	47.8 AV	54.0	-6.2	1.78 V	325	28.10	19.70

**REMARKS:**

1. Emission Level(dBuV/m) = Raw Value(dBuV) + Correction Factor(dB/m)
2. Correction Factor(dB/m) = Antenna Factor(dB/m) + Cable Factor(dB) – Pre-Amplifier Factor(dB)
3. The other emission levels were very low against the limit.
4. Margin value = Emission Level – Limit value
5. " \* ": Fundamental frequency.
6. " # ": The radiated frequency is out of the restricted band.



802.11n (HT40)

CHANNEL	TX Channel 54	DETECTOR FUNCTION	Peak (PK)
FREQUENCY RANGE	1GHz ~ 40GHz		Average (AV)

ANTENNA POLARITY & TEST DISTANCE: HORIZONTAL AT 3 M								
NO.	FREQ. (MHz)	EMISSION LEVEL (dBuV/m)	LIMIT (dBuV/m)	MARGIN (dB)	ANTENNA HEIGHT (m)	TABLE ANGLE (Degree)	RAW VALUE (dBuV)	CORRECTION FACTOR (dB/m)
1	5150.00	55.9 PK	74.0	-18.1	1.00 H	262	50.40	5.50
2	5150.00	43.0 AV	54.0	-11.0	1.00 H	262	37.50	5.50
3	*5270.00	105.0 PK			1.48 H	336	65.40	39.60
4	*5270.00	95.0 AV			1.48 H	336	55.40	39.60
5	#10540.00	59.4 PK	74.0	-14.6	1.24 H	263	41.30	18.10
6	#10540.00	45.2 AV	54.0	-8.8	1.24 H	263	27.10	18.10

ANTENNA POLARITY & TEST DISTANCE: VERTICAL AT 3 M								
NO.	FREQ. (MHz)	EMISSION LEVEL (dBuV/m)	LIMIT (dBuV/m)	MARGIN (dB)	ANTENNA HEIGHT (m)	TABLE ANGLE (Degree)	RAW VALUE (dBuV)	CORRECTION FACTOR (dB/m)
1	5150.00	56.3 PK	74.0	-17.7	1.00 V	166	50.80	5.50
2	5150.00	43.7 AV	54.0	-10.3	1.00 V	166	38.20	5.50
3	*5270.00	111.0 PK			1.50 V	23	71.40	39.60
4	*5270.00	101.3 AV			1.50 V	23	61.70	39.60
5	#10540.00	60.0 PK	74.0	-14.0	1.36 V	28	41.90	18.10
6	#10540.00	45.7 AV	54.0	-8.3	1.36 V	28	27.60	18.10

REMARKS:

1. Emission Level(dBuV/m) = Raw Value(dBuV) + Correction Factor(dB/m)
2. Correction Factor(dB/m) = Antenna Factor(dB/m) + Cable Factor(dB) – Pre-Amplifier Factor(dB)
3. The other emission levels were very low against the limit.
4. Margin value = Emission Level – Limit value
5. " \* ": Fundamental frequency.
6. " # ": The radiated frequency is out of the restricted band.

CHANNEL	TX Channel 62	DETECTOR FUNCTION	Peak (PK)
FREQUENCY RANGE	1GHz ~ 40GHz		Average (AV)

**ANTENNA POLARITY & TEST DISTANCE: HORIZONTAL AT 3 M**

NO.	FREQ. (MHz)	EMISSION LEVEL (dBuV/m)	LIMIT (dBuV/m)	MARGIN (dB)	ANTENNA HEIGHT (m)	TABLE ANGLE (Degree)	RAW VALUE (dBuV)	CORRECTION FACTOR (dB/m)
1	*5310.00	102.8 PK			1.27 H	70	63.20	39.60
2	*5310.00	93.2 AV			1.27 H	70	53.60	39.60
3	5350.00	58.5 PK	74.0	-15.5	1.00 H	134	52.80	5.70
4	5350.00	44.3 AV	54.0	-9.7	1.00 H	134	38.60	5.70
5	10620.00	59.5 PK	74.0	-14.5	1.70 H	41	41.20	18.30
6	10620.00	47.1 AV	54.0	-6.9	1.70 H	41	28.80	18.30

**ANTENNA POLARITY & TEST DISTANCE: VERTICAL AT 3 M**

NO.	FREQ. (MHz)	EMISSION LEVEL (dBuV/m)	LIMIT (dBuV/m)	MARGIN (dB)	ANTENNA HEIGHT (m)	TABLE ANGLE (Degree)	RAW VALUE (dBuV)	CORRECTION FACTOR (dB/m)
1	*5310.00	112.0 PK			1.17 V	88	72.40	39.60
2	*5310.00	102.3 AV			1.17 V	88	62.70	39.60
3	5350.00	59.2 PK	74.0	-14.8	1.00 V	89	53.50	5.70
4	5350.00	45.8 AV	54.0	-8.2	1.00 V	89	40.10	5.70
5	10620.00	59.8 PK	74.0	-14.2	1.47 V	359	41.50	18.30
6	10620.00	47.2 AV	54.0	-6.8	1.47 V	359	28.90	18.30

**REMARKS:**

1. Emission Level(dBuV/m) = Raw Value(dBuV) + Correction Factor(dB/m)
2. Correction Factor(dB/m) = Antenna Factor(dB/m) + Cable Factor(dB) – Pre-Amplifier Factor(dB)
3. The other emission levels were very low against the limit.
4. Margin value = Emission Level – Limit value
5. " \* ": Fundamental frequency.

CHANNEL	TX Channel 102	DETECTOR FUNCTION	Peak (PK)
FREQUENCY RANGE	1GHz ~ 40GHz		Average (AV)

**ANTENNA POLARITY & TEST DISTANCE: HORIZONTAL AT 3 M**

NO.	FREQ. (MHz)	EMISSION LEVEL (dBuV/m)	LIMIT (dBuV/m)	MARGIN (dB)	ANTENNA HEIGHT (m)	TABLE ANGLE (Degree)	RAW VALUE (dBuV)	CORRECTION FACTOR (dB/m)
1	5460.00	58.2 PK	74.0	-15.8	1.66 H	15	52.40	5.80
2	5460.00	44.6 AV	54.0	-9.4	1.66 H	15	38.80	5.80
3	#5470.00	58.9 PK	74.0	-15.1	1.66 H	15	53.00	5.90
4	#5470.00	46.0 AV	54.0	-8.0	1.66 H	15	40.10	5.90
5	*5510.00	102.7 PK			1.02 H	71	62.80	39.90
6	*5510.00	91.9 AV			1.02 H	71	52.00	39.90
7	11020.00	60.0 PK	74.0	-14.0	1.00 H	192	41.00	19.00
8	11020.00	47.0 AV	54.0	-7.0	1.00 H	192	28.00	19.00

**ANTENNA POLARITY & TEST DISTANCE: VERTICAL AT 3 M**

NO.	FREQ. (MHz)	EMISSION LEVEL (dBuV/m)	LIMIT (dBuV/m)	MARGIN (dB)	ANTENNA HEIGHT (m)	TABLE ANGLE (Degree)	RAW VALUE (dBuV)	CORRECTION FACTOR (dB/m)
1	5460.00	58.9 PK	74.0	-15.1	1.03 V	79	53.10	5.80
2	5460.00	46.7 AV	54.0	-7.3	1.03 V	79	40.90	5.80
3	#5470.00	59.8 PK	74.0	-14.2	1.03 V	79	53.90	5.90
4	#5470.00	47.8 AV	54.0	-6.2	1.03 V	79	41.90	5.90
5	*5510.00	111.8 PK			1.82 V	34	71.90	39.90
6	*5510.00	101.9 AV			1.82 V	34	62.00	39.90
7	11020.00	60.3 PK	74.0	-13.7	1.00 V	246	41.30	19.00
8	11020.00	47.2 AV	54.0	-6.8	1.00 V	246	28.20	19.00

**REMARKS:**

1. Emission Level(dBuV/m) = Raw Value(dBuV) + Correction Factor(dB/m)
2. Correction Factor(dB/m) = Antenna Factor(dB/m) + Cable Factor(dB) – Pre-Amplifier Factor(dB)
3. The other emission levels were very low against the limit.
4. Margin value = Emission Level – Limit value
5. " \* ": Fundamental frequency.
6. " # ": The radiated frequency is out of the restricted band.

CHANNEL	TX Channel 110	DETECTOR FUNCTION	Peak (PK)
FREQUENCY RANGE	1GHz ~ 40GHz		Average (AV)

**ANTENNA POLARITY & TEST DISTANCE: HORIZONTAL AT 3 M**

NO.	FREQ. (MHz)	EMISSION LEVEL (dBuV/m)	LIMIT (dBuV/m)	MARGIN (dB)	ANTENNA HEIGHT (m)	TABLE ANGLE (Degree)	RAW VALUE (dBuV)	CORRECTION FACTOR (dB/m)
1	*5550.00	103.2 PK			1.90 H	93	63.20	40.00
2	*5550.00	92.4 AV			1.90 H	93	52.40	40.00
3	11100.00	60.4 PK	74.0	-13.6	1.00 H	217	40.80	19.60
4	11100.00	48.1 AV	54.0	-5.9	1.00 H	217	28.50	19.60

**ANTENNA POLARITY & TEST DISTANCE: VERTICAL AT 3 M**

NO.	FREQ. (MHz)	EMISSION LEVEL (dBuV/m)	LIMIT (dBuV/m)	MARGIN (dB)	ANTENNA HEIGHT (m)	TABLE ANGLE (Degree)	RAW VALUE (dBuV)	CORRECTION FACTOR (dB/m)
1	*5550.00	110.6 PK			1.44 V	88	70.60	40.00
2	*5550.00	100.5 AV			1.44 V	88	60.50	40.00
3	11100.00	60.6 PK	74.0	-13.4	1.67 V	131	41.00	19.60
4	11100.00	48.4 AV	54.0	-5.6	1.67 V	131	28.80	19.60

**REMARKS:**

1. Emission Level(dBuV/m) = Raw Value(dBuV) + Correction Factor(dB/m)
2. Correction Factor(dB/m) = Antenna Factor(dB/m) + Cable Factor(dB) – Pre-Amplifier Factor(dB)
3. The other emission levels were very low against the limit.
4. Margin value = Emission Level – Limit value
5. " \* ": Fundamental frequency.

CHANNEL	TX Channel 134	DETECTOR FUNCTION	Peak (PK)
FREQUENCY RANGE	1GHz ~ 40GHz		Average (AV)

**ANTENNA POLARITY & TEST DISTANCE: HORIZONTAL AT 3 M**

NO.	FREQ. (MHz)	EMISSION LEVEL (dBuV/m)	LIMIT (dBuV/m)	MARGIN (dB)	ANTENNA HEIGHT (m)	TABLE ANGLE (Degree)	RAW VALUE (dBuV)	CORRECTION FACTOR (dB/m)
1	*5670.00	102.8 PK			1.03 H	347	62.60	40.20
2	*5670.00	92.4 AV			1.03 H	347	52.20	40.20
3	#5725.00	56.2 PK	74.0	-17.8	1.00 H	59	49.90	6.30
4	#5725.00	43.8 AV	54.0	-10.2	1.00 H	59	37.50	6.30
5	11340.00	61.4 PK	74.0	-12.6	1.45 H	187	41.70	19.70
6	11340.00	48.6 AV	54.0	-5.4	1.45 H	187	28.90	19.70

**ANTENNA POLARITY & TEST DISTANCE: VERTICAL AT 3 M**

NO.	FREQ. (MHz)	EMISSION LEVEL (dBuV/m)	LIMIT (dBuV/m)	MARGIN (dB)	ANTENNA HEIGHT (m)	TABLE ANGLE (Degree)	RAW VALUE (dBuV)	CORRECTION FACTOR (dB/m)
1	*5670.00	109.9 PK			1.61 V	23	69.70	40.20
2	*5670.00	99.2 AV			1.61 V	23	59.00	40.20
3	#5725.00	58.2 PK	74.0	-15.8	1.93 V	88	51.90	6.30
4	#5725.00	46.0 AV	54.0	-8.0	1.93 V	88	39.70	6.30
5	11340.00	61.6 PK	74.0	-12.4	1.23 V	313	41.90	19.70
6	11340.00	48.9 AV	54.0	-5.1	1.23 V	313	29.20	19.70

**REMARKS:**

1. Emission Level(dBuV/m) = Raw Value(dBuV) + Correction Factor(dB/m)
2. Correction Factor(dB/m) = Antenna Factor(dB/m) + Cable Factor(dB) – Pre-Amplifier Factor(dB)
3. The other emission levels were very low against the limit.
4. Margin value = Emission Level – Limit value
5. " \* ": Fundamental frequency.
6. " # ": The radiated frequency is out of the restricted band.

802.11ac (VHT80)

CHANNEL	TX Channel 58	DETECTOR FUNCTION	Peak (PK)
FREQUENCY RANGE	1GHz ~ 40GHz		Average (AV)

ANTENNA POLARITY & TEST DISTANCE: HORIZONTAL AT 3 M								
NO.	FREQ. (MHz)	EMISSION LEVEL (dBuV/m)	LIMIT (dBuV/m)	MARGIN (dB)	ANTENNA HEIGHT (m)	TABLE ANGLE (Degree)	RAW VALUE (dBuV)	CORRECTION FACTOR (dB/m)
1	*5290.00	97.4 PK			1.00 H	70	57.80	39.60
2	*5290.00	87.7 AV			1.00 H	70	48.10	39.60
3	5350.00	56.5 PK	74.0	-17.5	1.55 H	149	50.80	5.70
4	5350.00	44.6 AV	54.0	-9.4	1.55 H	149	38.90	5.70
5	#10580.00	58.9 PK	74.0	-15.1	1.02 H	38	40.60	18.30
6	#10580.00	46.9 AV	54.0	-7.1	1.02 H	38	28.60	18.30

ANTENNA POLARITY & TEST DISTANCE: VERTICAL AT 3 M								
NO.	FREQ. (MHz)	EMISSION LEVEL (dBuV/m)	LIMIT (dBuV/m)	MARGIN (dB)	ANTENNA HEIGHT (m)	TABLE ANGLE (Degree)	RAW VALUE (dBuV)	CORRECTION FACTOR (dB/m)
1	*5290.00	108.0 PK			1.49 V	11	68.40	39.60
2	*5290.00	97.6 AV			1.49 V	11	58.00	39.60
3	5350.00	73.1 PK	74.0	-0.9	1.70 V	56	67.40	5.70
4	5350.00	45.9 AV	54.0	-8.1	1.70 V	56	40.20	5.70
5	#10580.00	59.0 PK	74.0	-15.0	1.81 V	25	40.70	18.30
6	#10580.00	47.0 AV	54.0	-7.0	1.81 V	25	28.70	18.30

REMARKS:

1. Emission Level(dBuV/m) = Raw Value(dBuV) + Correction Factor(dB/m)
2. Correction Factor(dB/m) = Antenna Factor(dB/m) + Cable Factor(dB) – Pre-Amplifier Factor(dB)
3. The other emission levels were very low against the limit.
4. Margin value = Emission Level – Limit value
5. " \* ": Fundamental frequency.
6. " # ": The radiated frequency is out of the restricted band.

CHANNEL	TX Channel 106	DETECTOR FUNCTION	Peak (PK)
FREQUENCY RANGE	1GHz ~ 40GHz		Average (AV)

**ANTENNA POLARITY & TEST DISTANCE: HORIZONTAL AT 3 M**

NO.	FREQ. (MHz)	EMISSION LEVEL (dBuV/m)	LIMIT (dBuV/m)	MARGIN (dB)	ANTENNA HEIGHT (m)	TABLE ANGLE (Degree)	RAW VALUE (dBuV)	CORRECTION FACTOR (dB/m)
1	5460.00	64.4 PK	74.0	-9.6	1.88 H	20	58.60	5.80
2	5460.00	44.6 AV	54.0	-9.4	1.88 H	20	38.80	5.80
3	#5470.00	59.0 PK	74.0	-15.0	1.12 H	359	53.10	5.90
4	#5470.00	44.7 AV	54.0	-9.3	1.12 H	359	38.80	5.90
5	*5530.00	99.6 PK			1.57 H	47	59.70	39.90
6	*5530.00	88.7 AV			1.57 H	47	48.80	39.90
7	11060.00	60.6 PK	74.0	-13.4	1.78 H	41	41.40	19.20
8	11060.00	46.6 AV	54.0	-7.4	1.78 H	41	27.40	19.20

**ANTENNA POLARITY & TEST DISTANCE: VERTICAL AT 3 M**

NO.	FREQ. (MHz)	EMISSION LEVEL (dBuV/m)	LIMIT (dBuV/m)	MARGIN (dB)	ANTENNA HEIGHT (m)	TABLE ANGLE (Degree)	RAW VALUE (dBuV)	CORRECTION FACTOR (dB/m)
1	5460.00	72.9 PK	74.0	-1.1	1.55 V	34	67.10	5.80
2	5460.00	47.8 AV	54.0	-6.2	1.55 V	34	42.00	5.80
3	#5470.00	73.0 PK	74.0	-1.0	1.61 V	34	67.10	5.90
4	#5470.00	48.5 AV	54.0	-5.5	1.61 V	34	42.60	5.90
5	*5530.00	107.5 PK			1.50 V	34	67.60	39.90
6	*5530.00	97.3 AV			1.50 V	34	57.40	39.90
7	11060.00	61.2 PK	74.0	-12.8	1.15 V	195	42.00	19.20
8	11060.00	47.4 AV	54.0	-6.6	1.15 V	195	28.20	19.20

**REMARKS:**

1. Emission Level(dBuV/m) = Raw Value(dBuV) + Correction Factor(dB/m)
2. Correction Factor(dB/m) = Antenna Factor(dB/m) + Cable Factor(dB) – Pre-Amplifier Factor(dB)
3. The other emission levels were very low against the limit.
4. Margin value = Emission Level – Limit value
5. " \* ": Fundamental frequency.
6. " # ": The radiated frequency is out of the restricted band.

Test Mode B

4TX

802.11a

CHANNEL	TX Channel 52	DETECTOR FUNCTION	Peak (PK)
FREQUENCY RANGE	1GHz ~ 40GHz		Average (AV)

ANTENNA POLARITY & TEST DISTANCE: HORIZONTAL AT 3 M

NO.	FREQ. (MHz)	EMISSION LEVEL (dBuV/m)	LIMIT (dBuV/m)	MARGIN (dB)	ANTENNA HEIGHT (m)	TABLE ANGLE (Degree)	RAW VALUE (dBuV)	CORRECTION FACTOR (dB/m)
1	5150.00	56.1 PK	74.0	-17.9	2.06 H	74	50.60	5.50
2	5150.00	44.0 AV	54.0	-10.0	2.06 H	74	38.50	5.50
3	*5260.00	112.2 PK			1.98 H	60	72.60	39.60
4	*5260.00	102.9 AV			1.98 H	60	63.30	39.60
5	#10520.00	58.1 PK	74.0	-15.9	1.26 H	38	40.00	18.10
6	#10520.00	45.2 AV	54.0	-8.8	1.26 H	38	27.10	18.10

ANTENNA POLARITY & TEST DISTANCE: VERTICAL AT 3 M

NO.	FREQ. (MHz)	EMISSION LEVEL (dBuV/m)	LIMIT (dBuV/m)	MARGIN (dB)	ANTENNA HEIGHT (m)	TABLE ANGLE (Degree)	RAW VALUE (dBuV)	CORRECTION FACTOR (dB/m)
1	5150.00	56.1 PK	74.0	-17.9	1.76 V	352	50.60	5.50
2	5150.00	46.5 AV	54.0	-7.5	1.76 V	352	41.00	5.50
3	*5260.00	116.7 PK			1.70 V	4	77.10	39.60
4	*5260.00	107.2 AV			1.70 V	4	67.60	39.60
5	#10520.00	59.5 PK	74.0	-14.5	1.26 V	98	41.40	18.10
6	#10520.00	46.2 AV	54.0	-7.8	1.26 V	98	28.10	18.10

REMARKS:

1. Emission Level(dBuV/m) = Raw Value(dBuV) + Correction Factor(dB/m)
2. Correction Factor(dB/m) = Antenna Factor(dB/m) + Cable Factor(dB) – Pre-Amplifier Factor(dB)
3. The other emission levels were very low against the limit.
4. Margin value = Emission Level – Limit value
5. " \* ": Fundamental frequency.
6. " # ": The radiated frequency is out of the restricted band.



CHANNEL	TX Channel 60	DETECTOR FUNCTION	Peak (PK)
FREQUENCY RANGE	1GHz ~ 40GHz		Average (AV)

**ANTENNA POLARITY & TEST DISTANCE: HORIZONTAL AT 3 M**

NO.	FREQ. (MHz)	EMISSION LEVEL (dBuV/m)	LIMIT (dBuV/m)	MARGIN (dB)	ANTENNA HEIGHT (m)	TABLE ANGLE (Degree)	RAW VALUE (dBuV)	CORRECTION FACTOR (dB/m)
1	*5300.00	112.8 PK			1.78 H	315	73.20	39.60
2	*5300.00	103.7 AV			1.78 H	315	64.10	39.60
3	10600.00	58.6 PK	74.0	-15.4	1.25 H	89	40.20	18.40
4	10600.00	45.6 AV	54.0	-8.4	1.25 H	89	27.20	18.40

**ANTENNA POLARITY & TEST DISTANCE: VERTICAL AT 3 M**

NO.	FREQ. (MHz)	EMISSION LEVEL (dBuV/m)	LIMIT (dBuV/m)	MARGIN (dB)	ANTENNA HEIGHT (m)	TABLE ANGLE (Degree)	RAW VALUE (dBuV)	CORRECTION FACTOR (dB/m)
1	*5300.00	116.3 PK			1.29 V	11	76.70	39.60
2	*5300.00	107.0 AV			1.29 V	11	67.40	39.60
3	10600.00	60.2 PK	74.0	-13.8	1.27 V	48	41.80	18.40
4	10600.00	47.0 AV	54.0	-7.0	1.27 V	48	28.60	18.40

**REMARKS:**

1. Emission Level(dBuV/m) = Raw Value(dBuV) + Correction Factor(dB/m)
2. Correction Factor(dB/m) = Antenna Factor(dB/m) + Cable Factor(dB) – Pre-Amplifier Factor(dB)
3. The other emission levels were very low against the limit.
4. Margin value = Emission Level – Limit value
5. " \* ": Fundamental frequency.

CHANNEL	TX Channel 64	DETECTOR FUNCTION	Peak (PK)
FREQUENCY RANGE	1GHz ~ 40GHz		Average (AV)

**ANTENNA POLARITY & TEST DISTANCE: HORIZONTAL AT 3 M**

NO.	FREQ. (MHz)	EMISSION LEVEL (dBuV/m)	LIMIT (dBuV/m)	MARGIN (dB)	ANTENNA HEIGHT (m)	TABLE ANGLE (Degree)	RAW VALUE (dBuV)	CORRECTION FACTOR (dB/m)
1	*5320.00	113.8 PK			1.65 H	316	74.10	39.70
2	*5320.00	104.4 AV			1.65 H	316	64.70	39.70
3	5350.00	66.6 PK	74.0	-7.4	1.71 H	321	60.90	5.70
4	5350.00	47.7 AV	54.0	-6.3	1.71 H	321	42.00	5.70
5	10640.00	58.5 PK	74.0	-15.5	1.26 H	35	40.10	18.40
6	10640.00	46.0 AV	54.0	-8.0	1.26 H	35	27.60	18.40

**ANTENNA POLARITY & TEST DISTANCE: VERTICAL AT 3 M**

NO.	FREQ. (MHz)	EMISSION LEVEL (dBuV/m)	LIMIT (dBuV/m)	MARGIN (dB)	ANTENNA HEIGHT (m)	TABLE ANGLE (Degree)	RAW VALUE (dBuV)	CORRECTION FACTOR (dB/m)
1	*5320.00	117.3 PK			1.43 V	9	77.60	39.70
2	*5320.00	108.0 AV			1.43 V	9	68.30	39.70
3	5350.00	68.7 PK	74.0	-5.3	1.49 V	15	63.00	5.70
4	5350.00	50.2 AV	54.0	-3.8	1.49 V	15	44.50	5.70
5	10640.00	60.0 PK	74.0	-14.0	1.47 V	87	41.60	18.40
6	10640.00	47.1 AV	54.0	-6.9	1.47 V	87	28.70	18.40

**REMARKS:**

1. Emission Level(dBuV/m) = Raw Value(dBuV) + Correction Factor(dB/m)
2. Correction Factor(dB/m) = Antenna Factor(dB/m) + Cable Factor(dB) – Pre-Amplifier Factor(dB)
3. The other emission levels were very low against the limit.
4. Margin value = Emission Level – Limit value
5. " \* ": Fundamental frequency.

CHANNEL	TX Channel 100	DETECTOR FUNCTION	Peak (PK)
FREQUENCY RANGE	1GHz ~ 40GHz		Average (AV)

**ANTENNA POLARITY & TEST DISTANCE: HORIZONTAL AT 3 M**

NO.	FREQ. (MHz)	EMISSION LEVEL (dBuV/m)	LIMIT (dBuV/m)	MARGIN (dB)	ANTENNA HEIGHT (m)	TABLE ANGLE (Degree)	RAW VALUE (dBuV)	CORRECTION FACTOR (dB/m)
1	5460.00	56.0 PK	74.0	-18.0	1.90 H	70	50.20	5.80
2	5460.00	45.5 AV	54.0	-8.5	1.90 H	70	39.70	5.80
3	#5470.00	57.1 PK	74.0	-16.9	1.85 H	63	51.20	5.90
4	#5470.00	47.1 AV	54.0	-6.9	1.85 H	63	41.20	5.90
5	*5500.00	113.6 PK			2.08 H	50	73.70	39.90
6	*5500.00	103.8 AV			2.08 H	50	63.90	39.90
7	11000.00	59.0 PK	74.0	-15.0	1.17 H	14	40.10	18.90
8	11000.00	46.0 AV	54.0	-8.0	1.17 H	14	27.10	18.90

**ANTENNA POLARITY & TEST DISTANCE: VERTICAL AT 3 M**

NO.	FREQ. (MHz)	EMISSION LEVEL (dBuV/m)	LIMIT (dBuV/m)	MARGIN (dB)	ANTENNA HEIGHT (m)	TABLE ANGLE (Degree)	RAW VALUE (dBuV)	CORRECTION FACTOR (dB/m)
1	5460.00	57.2 PK	74.0	-16.8	1.30 V	40	51.40	5.80
2	5460.00	46.6 AV	54.0	-7.4	1.30 V	40	40.80	5.80
3	#5470.00	62.9 PK	74.0	-11.1	1.26 V	33	57.00	5.90
4	#5470.00	48.9 AV	54.0	-5.1	1.26 V	33	43.00	5.90
5	*5500.00	117.7 PK			1.54 V	6	77.80	39.90
6	*5500.00	108.2 AV			1.54 V	6	68.30	39.90
7	11000.00	60.5 PK	74.0	-13.5	1.14 V	74	41.60	18.90
8	11000.00	47.0 AV	54.0	-7.0	1.14 V	74	28.10	18.90

**REMARKS:**

1. Emission Level(dBuV/m) = Raw Value(dBuV) + Correction Factor(dB/m)
2. Correction Factor(dB/m) = Antenna Factor(dB/m) + Cable Factor(dB) – Pre-Amplifier Factor(dB)
3. The other emission levels were very low against the limit.
4. Margin value = Emission Level – Limit value
5. " \* ": Fundamental frequency.
6. " # ": The radiated frequency is out of the restricted band.

CHANNEL	TX Channel 116	DETECTOR FUNCTION	Peak (PK)
FREQUENCY RANGE	1GHz ~ 40GHz		Average (AV)

**ANTENNA POLARITY & TEST DISTANCE: HORIZONTAL AT 3 M**

NO.	FREQ. (MHz)	EMISSION LEVEL (dBuV/m)	LIMIT (dBuV/m)	MARGIN (dB)	ANTENNA HEIGHT (m)	TABLE ANGLE (Degree)	RAW VALUE (dBuV)	CORRECTION FACTOR (dB/m)
1	*5580.00	114.1 PK			1.39 H	303	74.20	39.90
2	*5580.00	104.1 AV			1.39 H	303	64.20	39.90
3	11160.00	59.3 PK	74.0	-14.7	1.07 H	41	40.10	19.20
4	11160.00	46.3 AV	54.0	-7.7	1.07 H	41	27.10	19.20

**ANTENNA POLARITY & TEST DISTANCE: VERTICAL AT 3 M**

NO.	FREQ. (MHz)	EMISSION LEVEL (dBuV/m)	LIMIT (dBuV/m)	MARGIN (dB)	ANTENNA HEIGHT (m)	TABLE ANGLE (Degree)	RAW VALUE (dBuV)	CORRECTION FACTOR (dB/m)
1	*5580.00	117.9 PK			1.72 V	71	78.00	39.90
2	*5580.00	107.8 AV			1.72 V	71	67.90	39.90
3	11160.00	61.2 PK	74.0	-12.8	1.63 V	97	42.00	19.20
4	11160.00	48.2 AV	54.0	-5.8	1.63 V	97	29.00	19.20

**REMARKS:**

1. Emission Level(dBuV/m) = Raw Value(dBuV) + Correction Factor(dB/m)
2. Correction Factor(dB/m) = Antenna Factor(dB/m) + Cable Factor(dB) – Pre-Amplifier Factor(dB)
3. The other emission levels were very low against the limit.
4. Margin value = Emission Level – Limit value
5. " \* ": Fundamental frequency.

CHANNEL	TX Channel 140	DETECTOR FUNCTION	Peak (PK)
FREQUENCY RANGE	1GHz ~ 40GHz		Average (AV)

**ANTENNA POLARITY & TEST DISTANCE: HORIZONTAL AT 3 M**

NO.	FREQ. (MHz)	EMISSION LEVEL (dBuV/m)	LIMIT (dBuV/m)	MARGIN (dB)	ANTENNA HEIGHT (m)	TABLE ANGLE (Degree)	RAW VALUE (dBuV)	CORRECTION FACTOR (dB/m)
1	*5700.00	114.2 PK			1.48 H	53	73.90	40.30
2	*5700.00	104.3 AV			1.48 H	53	64.00	40.30
3	#5725.00	64.6 PK	74.0	-9.4	1.63 H	95	58.30	6.30
4	#5725.00	49.3 AV	54.0	-4.7	1.63 H	95	43.00	6.30
5	11400.00	59.7 PK	74.0	-14.3	1.17 H	105	40.00	19.70
6	11400.00	46.8 AV	54.0	-7.2	1.17 H	105	27.10	19.70

**ANTENNA POLARITY & TEST DISTANCE: VERTICAL AT 3 M**

NO.	FREQ. (MHz)	EMISSION LEVEL (dBuV/m)	LIMIT (dBuV/m)	MARGIN (dB)	ANTENNA HEIGHT (m)	TABLE ANGLE (Degree)	RAW VALUE (dBuV)	CORRECTION FACTOR (dB/m)
1	*5700.00	117.8 PK			2.10 V	4	77.50	40.30
2	*5700.00	107.7 AV			2.10 V	4	67.40	40.30
3	#5725.00	65.0 PK	74.0	-9.0	2.24 V	11	58.70	6.30
4	#5725.00	50.1 AV	54.0	-3.9	2.24 V	11	43.80	6.30
5	11400.00	61.0 PK	74.0	-13.0	1.15 V	23	41.30	19.70
6	11400.00	47.8 AV	54.0	-6.2	1.15 V	23	28.10	19.70

**REMARKS:**

1. Emission Level(dBuV/m) = Raw Value(dBuV) + Correction Factor(dB/m)
2. Correction Factor(dB/m) = Antenna Factor(dB/m) + Cable Factor(dB) – Pre-Amplifier Factor(dB)
3. The other emission levels were very low against the limit.
4. Margin value = Emission Level – Limit value
5. " \* ": Fundamental frequency.
6. " # ": The radiated frequency is out of the restricted band.

**802.11n (HT20)**

CHANNEL	TX Channel 52	DETECTOR FUNCTION	Peak (PK)
FREQUENCY RANGE	1GHz ~ 40GHz		Average (AV)

**ANTENNA POLARITY & TEST DISTANCE: HORIZONTAL AT 3 M**

NO.	FREQ. (MHz)	EMISSION LEVEL (dBuV/m)	LIMIT (dBuV/m)	MARGIN (dB)	ANTENNA HEIGHT (m)	TABLE ANGLE (Degree)	RAW VALUE (dBuV)	CORRECTION FACTOR (dB/m)
1	5150.00	50.0 PK	74.0	-24.0	1.00 H	251	50.40	-0.40
2	5150.00	36.7 AV	54.0	-17.3	1.00 H	251	37.10	-0.40
3	*5260.00	65.1 PK			1.74 H	312	65.50	-0.40
4	*5260.00	54.4 AV			1.74 H	312	54.80	-0.40
5	#10520.00	40.5 PK	74.0	-33.5	1.00 H	274	40.90	-0.40
6	#10520.00	27.1 AV	54.0	-26.9	1.00 H	274	27.50	-0.40

**ANTENNA POLARITY & TEST DISTANCE: VERTICAL AT 3 M**

NO.	FREQ. (MHz)	EMISSION LEVEL (dBuV/m)	LIMIT (dBuV/m)	MARGIN (dB)	ANTENNA HEIGHT (m)	TABLE ANGLE (Degree)	RAW VALUE (dBuV)	CORRECTION FACTOR (dB/m)
1	5150.00	50.4 PK	74.0	-23.6	1.00 V	345	50.80	-0.40
2	5150.00	37.3 AV	54.0	-16.7	1.00 V	345	37.70	-0.40
3	*5260.00	72.1 PK			1.72 V	33	72.50	-0.40
4	*5260.00	61.7 AV			1.72 V	33	62.10	-0.40
5	#10520.00	40.4 PK	74.0	-33.6	1.00 V	197	40.80	-0.40
6	#10520.00	27.2 AV	54.0	-26.8	1.00 V	197	27.60	-0.40

**REMARKS:**

1. Emission Level(dBuV/m) = Raw Value(dBuV) + Correction Factor(dB/m)
2. Correction Factor(dB/m) = Antenna Factor(dB/m) + Cable Factor(dB) – Pre-Amplifier Factor(dB)
3. The other emission levels were very low against the limit.
4. Margin value = Emission Level – Limit value
5. " \* ": Fundamental frequency.
6. " # ": The radiated frequency is out of the restricted band.

CHANNEL	TX Channel 60	DETECTOR FUNCTION	Peak (PK)
FREQUENCY RANGE	1GHz ~ 40GHz		Average (AV)

**ANTENNA POLARITY & TEST DISTANCE: HORIZONTAL AT 3 M**

NO.	FREQ. (MHz)	EMISSION LEVEL (dBuV/m)	LIMIT (dBuV/m)	MARGIN (dB)	ANTENNA HEIGHT (m)	TABLE ANGLE (Degree)	RAW VALUE (dBuV)	CORRECTION FACTOR (dB/m)
1	*5300.00	106.5 PK			1.30 H	313	66.90	39.60
2	*5300.00	95.1 AV			1.30 H	313	55.50	39.60
3	10600.00	59.3 PK	74.0	-14.7	1.00 H	103	40.90	18.40
4	10600.00	45.7 AV	54.0	-8.3	1.00 H	103	27.30	18.40

**ANTENNA POLARITY & TEST DISTANCE: VERTICAL AT 3 M**

NO.	FREQ. (MHz)	EMISSION LEVEL (dBuV/m)	LIMIT (dBuV/m)	MARGIN (dB)	ANTENNA HEIGHT (m)	TABLE ANGLE (Degree)	RAW VALUE (dBuV)	CORRECTION FACTOR (dB/m)
1	*5300.00	113.3 PK			1.69 V	22	73.70	39.60
2	*5300.00	103.0 AV			1.69 V	22	63.40	39.60
3	10600.00	59.9 PK	74.0	-14.1	1.00 V	69	41.50	18.40
4	10600.00	45.7 AV	54.0	-8.3	1.00 V	69	27.30	18.40

**REMARKS:**

1. Emission Level(dBuV/m) = Raw Value(dBuV) + Correction Factor(dB/m)
2. Correction Factor(dB/m) = Antenna Factor(dB/m) + Cable Factor(dB) – Pre-Amplifier Factor(dB)
3. The other emission levels were very low against the limit.
4. Margin value = Emission Level – Limit value
5. " \* ": Fundamental frequency.

CHANNEL	TX Channel 64	DETECTOR FUNCTION	Peak (PK)
FREQUENCY RANGE	1GHz ~ 40GHz		Average (AV)

**ANTENNA POLARITY & TEST DISTANCE: HORIZONTAL AT 3 M**

NO.	FREQ. (MHz)	EMISSION LEVEL (dBuV/m)	LIMIT (dBuV/m)	MARGIN (dB)	ANTENNA HEIGHT (m)	TABLE ANGLE (Degree)	RAW VALUE (dBuV)	CORRECTION FACTOR (dB/m)
1	*5320.00	107.1 PK			1.42 H	310	67.40	39.70
2	*5320.00	96.3 AV			1.42 H	310	56.60	39.70
3	5350.00	56.1 PK	74.0	-17.9	1.28 H	299	50.40	5.70
4	5350.00	43.2 AV	54.0	-10.8	1.28 H	299	37.50	5.70
5	10640.00	58.9 PK	74.0	-15.1	1.00 H	240	40.50	18.40
6	10640.00	45.6 AV	54.0	-8.4	1.00 H	240	27.20	18.40

**ANTENNA POLARITY & TEST DISTANCE: VERTICAL AT 3 M**

NO.	FREQ. (MHz)	EMISSION LEVEL (dBuV/m)	LIMIT (dBuV/m)	MARGIN (dB)	ANTENNA HEIGHT (m)	TABLE ANGLE (Degree)	RAW VALUE (dBuV)	CORRECTION FACTOR (dB/m)
1	*5320.00	113.2 PK			1.77 V	19	73.50	39.70
2	*5320.00	103.5 AV			1.77 V	19	63.80	39.70
3	5350.00	58.8 PK	74.0	-15.2	1.47 V	29	53.10	5.70
4	5350.00	45.2 AV	54.0	-8.8	1.47 V	29	39.50	5.70
5	10640.00	59.6 PK	74.0	-14.4	1.00 V	87	41.20	18.40
6	10640.00	45.8 AV	54.0	-8.2	1.00 V	87	27.40	18.40

**REMARKS:**

1. Emission Level(dBuV/m) = Raw Value(dBuV) + Correction Factor(dB/m)
2. Correction Factor(dB/m) = Antenna Factor(dB/m) + Cable Factor(dB) – Pre-Amplifier Factor(dB)
3. The other emission levels were very low against the limit.
4. Margin value = Emission Level – Limit value
5. " \* ": Fundamental frequency.



CHANNEL	TX Channel 100	DETECTOR FUNCTION	Peak (PK)
FREQUENCY RANGE	1GHz ~ 40GHz		Average (AV)

**ANTENNA POLARITY & TEST DISTANCE: HORIZONTAL AT 3 M**

NO.	FREQ. (MHz)	EMISSION LEVEL (dBuV/m)	LIMIT (dBuV/m)	MARGIN (dB)	ANTENNA HEIGHT (m)	TABLE ANGLE (Degree)	RAW VALUE (dBuV)	CORRECTION FACTOR (dB/m)
1	5460.00	55.8 PK	74.0	-18.2	1.99 H	357	50.00	5.80
2	5460.00	43.8 AV	54.0	-10.2	1.99 H	357	38.00	5.80
3	#5470.00	55.9 PK	74.0	-18.1	1.67 H	326	50.00	5.90
4	#5470.00	44.3 AV	54.0	-9.7	1.67 H	326	38.40	5.90
5	*5500.00	105.3 PK			1.89 H	71	65.40	39.90
6	*5500.00	95.0 AV			1.89 H	71	55.10	39.90
7	11000.00	59.5 PK	74.0	-14.5	1.23 H	71	40.60	18.90
8	11000.00	45.7 AV	54.0	-8.3	1.23 H	71	26.80	18.90

**ANTENNA POLARITY & TEST DISTANCE: VERTICAL AT 3 M**

NO.	FREQ. (MHz)	EMISSION LEVEL (dBuV/m)	LIMIT (dBuV/m)	MARGIN (dB)	ANTENNA HEIGHT (m)	TABLE ANGLE (Degree)	RAW VALUE (dBuV)	CORRECTION FACTOR (dB/m)
1	5460.00	57.0 PK	74.0	-17.0	1.37 V	2	51.20	5.80
2	5460.00	45.7 AV	54.0	-8.3	1.37 V	2	39.90	5.80
3	#5470.00	58.5 PK	74.0	-15.5	1.40 V	14	52.60	5.90
4	#5470.00	46.7 AV	54.0	-7.3	1.40 V	14	40.80	5.90
5	*5500.00	112.6 PK			1.26 V	18	72.70	39.90
6	*5500.00	103.0 AV			1.26 V	18	63.10	39.90
7	11000.00	60.0 PK	74.0	-14.0	1.35 V	49	41.10	18.90
8	11000.00	46.8 AV	54.0	-7.2	1.35 V	49	27.90	18.90

**REMARKS:**

1. Emission Level(dBuV/m) = Raw Value(dBuV) + Correction Factor(dB/m)
2. Correction Factor(dB/m) = Antenna Factor(dB/m) + Cable Factor(dB) – Pre-Amplifier Factor(dB)
3. The other emission levels were very low against the limit.
4. Margin value = Emission Level – Limit value
5. " \* ": Fundamental frequency.
6. " # ": The radiated frequency is out of the restricted band.

CHANNEL	TX Channel 116	DETECTOR FUNCTION	Peak (PK)
FREQUENCY RANGE	1GHz ~ 40GHz		Average (AV)

**ANTENNA POLARITY & TEST DISTANCE: HORIZONTAL AT 3 M**

NO.	FREQ. (MHz)	EMISSION LEVEL (dBuV/m)	LIMIT (dBuV/m)	MARGIN (dB)	ANTENNA HEIGHT (m)	TABLE ANGLE (Degree)	RAW VALUE (dBuV)	CORRECTION FACTOR (dB/m)
1	*5580.00	105.0 PK			1.45 H	81	65.10	39.90
2	*5580.00	94.9 AV			1.45 H	81	55.00	39.90
3	11160.00	59.1 PK	74.0	-14.9	1.00 H	103	39.90	19.20
4	11160.00	46.2 AV	54.0	-7.8	1.00 H	103	27.00	19.20

**ANTENNA POLARITY & TEST DISTANCE: VERTICAL AT 3 M**

NO.	FREQ. (MHz)	EMISSION LEVEL (dBuV/m)	LIMIT (dBuV/m)	MARGIN (dB)	ANTENNA HEIGHT (m)	TABLE ANGLE (Degree)	RAW VALUE (dBuV)	CORRECTION FACTOR (dB/m)
1	*5580.00	112.0 PK			1.66 V	99	72.10	39.90
2	*5580.00	102.3 AV			1.66 V	99	62.40	39.90
3	11160.00	60.8 PK	74.0	-13.2	1.00 V	279	41.60	19.20
4	11160.00	47.3 AV	54.0	-6.7	1.00 V	279	28.10	19.20

**REMARKS:**

1. Emission Level(dBuV/m) = Raw Value(dBuV) + Correction Factor(dB/m)
2. Correction Factor(dB/m) = Antenna Factor(dB/m) + Cable Factor(dB) – Pre-Amplifier Factor(dB)
3. The other emission levels were very low against the limit.
4. Margin value = Emission Level – Limit value
5. " \* ": Fundamental frequency.

CHANNEL	TX Channel 140	DETECTOR FUNCTION	Peak (PK)
FREQUENCY RANGE	1GHz ~ 40GHz		Average (AV)

**ANTENNA POLARITY & TEST DISTANCE: HORIZONTAL AT 3 M**

NO.	FREQ. (MHz)	EMISSION LEVEL (dBuV/m)	LIMIT (dBuV/m)	MARGIN (dB)	ANTENNA HEIGHT (m)	TABLE ANGLE (Degree)	RAW VALUE (dBuV)	CORRECTION FACTOR (dB/m)
1	*5700.00	104.7 PK			1.00 H	358	64.40	40.30
2	*5700.00	94.1 AV			1.00 H	358	53.80	40.30
3	#5725.00	55.7 PK	74.0	-18.3	1.35 H	21	49.40	6.30
4	#5725.00	43.9 AV	54.0	-10.1	1.35 H	21	37.60	6.30
5	11400.00	59.6 PK	74.0	-14.4	1.02 H	273	39.90	19.70
6	11400.00	46.6 AV	54.0	-7.4	1.02 H	273	26.90	19.70

**ANTENNA POLARITY & TEST DISTANCE: VERTICAL AT 3 M**

NO.	FREQ. (MHz)	EMISSION LEVEL (dBuV/m)	LIMIT (dBuV/m)	MARGIN (dB)	ANTENNA HEIGHT (m)	TABLE ANGLE (Degree)	RAW VALUE (dBuV)	CORRECTION FACTOR (dB/m)
1	*5700.00	110.7 PK			1.79 V	85	70.40	40.30
2	*5700.00	100.9 AV			1.79 V	85	60.60	40.30
3	#5725.00	58.7 PK	74.0	-15.3	1.21 V	31	52.40	6.30
4	#5725.00	46.9 AV	54.0	-7.1	1.21 V	31	40.60	6.30
5	11400.00	60.8 PK	74.0	-13.2	1.56 V	150	41.10	19.70
6	11400.00	47.7 AV	54.0	-6.3	1.56 V	150	28.00	19.70

**REMARKS:**

1. Emission Level(dBuV/m) = Raw Value(dBuV) + Correction Factor(dB/m)
2. Correction Factor(dB/m) = Antenna Factor(dB/m) + Cable Factor(dB) – Pre-Amplifier Factor(dB)
3. The other emission levels were very low against the limit.
4. Margin value = Emission Level – Limit value
5. " \* ": Fundamental frequency.
6. " # ": The radiated frequency is out of the restricted band.

802.11n (HT40)

CHANNEL	TX Channel 54	DETECTOR FUNCTION	Peak (PK)
FREQUENCY RANGE	1GHz ~ 40GHz		Average (AV)

ANTENNA POLARITY & TEST DISTANCE: HORIZONTAL AT 3 M								
NO.	FREQ. (MHz)	EMISSION LEVEL (dBuV/m)	LIMIT (dBuV/m)	MARGIN (dB)	ANTENNA HEIGHT (m)	TABLE ANGLE (Degree)	RAW VALUE (dBuV)	CORRECTION FACTOR (dB/m)
1	5150.00	55.8 PK	74.0	-18.2	1.45 H	231	50.30	5.50
2	5150.00	43.0 AV	54.0	-11.0	1.45 H	231	37.50	5.50
3	*5270.00	104.8 PK			1.94 H	314	65.20	39.60
4	*5270.00	94.0 AV			1.94 H	314	54.40	39.60
5	#10540.00	57.9 PK	74.0	-16.1	1.68 H	224	39.80	18.10
6	#10540.00	46.3 AV	54.0	-7.7	1.68 H	224	28.20	18.10

ANTENNA POLARITY & TEST DISTANCE: VERTICAL AT 3 M								
NO.	FREQ. (MHz)	EMISSION LEVEL (dBuV/m)	LIMIT (dBuV/m)	MARGIN (dB)	ANTENNA HEIGHT (m)	TABLE ANGLE (Degree)	RAW VALUE (dBuV)	CORRECTION FACTOR (dB/m)
1	5150.00	55.9 PK	74.0	-18.1	1.02 V	229	50.40	5.50
2	5150.00	43.3 AV	54.0	-10.7	1.02 V	229	37.80	5.50
3	*5270.00	110.8 PK			1.85 V	67	71.20	39.60
4	*5270.00	100.9 AV			1.85 V	67	61.30	39.60
5	#10540.00	58.2 PK	74.0	-15.8	1.26 V	86	40.10	18.10
6	#10540.00	46.5 AV	54.0	-7.5	1.26 V	86	28.40	18.10

REMARKS:

1. Emission Level(dBuV/m) = Raw Value(dBuV) + Correction Factor(dB/m)
2. Correction Factor(dB/m) = Antenna Factor(dB/m) + Cable Factor(dB) – Pre-Amplifier Factor(dB)
3. The other emission levels were very low against the limit.
4. Margin value = Emission Level – Limit value
5. " \* ": Fundamental frequency.
6. " # ": The radiated frequency is out of the restricted band.

CHANNEL	TX Channel 62	DETECTOR FUNCTION	Peak (PK)
FREQUENCY RANGE	1GHz ~ 40GHz		Average (AV)

**ANTENNA POLARITY & TEST DISTANCE: HORIZONTAL AT 3 M**

NO.	FREQ. (MHz)	EMISSION LEVEL (dBuV/m)	LIMIT (dBuV/m)	MARGIN (dB)	ANTENNA HEIGHT (m)	TABLE ANGLE (Degree)	RAW VALUE (dBuV)	CORRECTION FACTOR (dB/m)
1	*5310.00	103.5 PK			1.96 H	314	63.90	39.60
2	*5310.00	93.4 AV			1.96 H	314	53.80	39.60
3	5350.00	58.5 PK	74.0	-15.5	1.91 H	347	52.80	5.70
4	5350.00	45.7 AV	54.0	-8.3	1.91 H	347	40.00	5.70
5	10620.00	59.3 PK	74.0	-14.7	1.70 H	210	41.00	18.30
6	10620.00	46.9 AV	54.0	-7.1	1.70 H	210	28.60	18.30

**ANTENNA POLARITY & TEST DISTANCE: VERTICAL AT 3 M**

NO.	FREQ. (MHz)	EMISSION LEVEL (dBuV/m)	LIMIT (dBuV/m)	MARGIN (dB)	ANTENNA HEIGHT (m)	TABLE ANGLE (Degree)	RAW VALUE (dBuV)	CORRECTION FACTOR (dB/m)
1	*5310.00	109.0 PK			1.31 V	55	69.40	39.60
2	*5310.00	99.2 AV			1.31 V	55	59.60	39.60
3	5350.00	61.5 PK	74.0	-12.5	1.04 V	13	55.80	5.70
4	5350.00	48.9 AV	54.0	-5.1	1.04 V	13	43.20	5.70
5	10620.00	59.8 PK	74.0	-14.2	1.48 V	306	41.50	18.30
6	10620.00	47.2 AV	54.0	-6.8	1.48 V	306	28.90	18.30

**REMARKS:**

1. Emission Level(dBuV/m) = Raw Value(dBuV) + Correction Factor(dB/m)
2. Correction Factor(dB/m) = Antenna Factor(dB/m) + Cable Factor(dB) – Pre-Amplifier Factor(dB)
3. The other emission levels were very low against the limit.
4. Margin value = Emission Level – Limit value
5. " \* ": Fundamental frequency.

CHANNEL	TX Channel 102	DETECTOR FUNCTION	Peak (PK)
FREQUENCY RANGE	1GHz ~ 40GHz		Average (AV)

**ANTENNA POLARITY & TEST DISTANCE: HORIZONTAL AT 3 M**

NO.	FREQ. (MHz)	EMISSION LEVEL (dBuV/m)	LIMIT (dBuV/m)	MARGIN (dB)	ANTENNA HEIGHT (m)	TABLE ANGLE (Degree)	RAW VALUE (dBuV)	CORRECTION FACTOR (dB/m)
1	5460.00	56.2 PK	74.0	-17.8	1.81 H	314	50.40	5.80
2	5460.00	44.4 AV	54.0	-9.6	1.81 H	314	38.60	5.80
3	#5470.00	57.8 PK	74.0	-16.2	1.37 H	335	51.90	5.90
4	#5470.00	44.7 AV	54.0	-9.3	1.37 H	335	38.80	5.90
5	*5510.00	102.5 PK			1.13 H	93	62.60	39.90
6	*5510.00	92.0 AV			1.13 H	93	52.10	39.90
7	11020.00	59.4 PK	74.0	-14.6	1.12 H	98	40.40	19.00
8	11020.00	46.6 AV	54.0	-7.4	1.12 H	98	27.60	19.00

**ANTENNA POLARITY & TEST DISTANCE: VERTICAL AT 3 M**

NO.	FREQ. (MHz)	EMISSION LEVEL (dBuV/m)	LIMIT (dBuV/m)	MARGIN (dB)	ANTENNA HEIGHT (m)	TABLE ANGLE (Degree)	RAW VALUE (dBuV)	CORRECTION FACTOR (dB/m)
1	5460.00	59.2 PK	74.0	-14.8	1.93 V	97	53.40	5.80
2	5460.00	47.4 AV	54.0	-6.6	1.93 V	97	41.60	5.80
3	#5470.00	63.4 PK	74.0	-10.6	1.39 V	21	57.50	5.90
4	#5470.00	49.8 AV	54.0	-4.2	1.39 V	21	43.90	5.90
5	*5510.00	110.1 PK			1.92 V	12	70.20	39.90
6	*5510.00	99.6 AV			1.92 V	12	59.70	39.90
7	11020.00	59.6 PK	74.0	-14.4	1.24 V	145	40.60	19.00
8	11020.00	47.0 AV	54.0	-7.0	1.24 V	145	28.00	19.00

**REMARKS:**

1. Emission Level(dBuV/m) = Raw Value(dBuV) + Correction Factor(dB/m)
2. Correction Factor(dB/m) = Antenna Factor(dB/m) + Cable Factor(dB) – Pre-Amplifier Factor(dB)
3. The other emission levels were very low against the limit.
4. Margin value = Emission Level – Limit value
5. " \* ": Fundamental frequency.
6. " # ": The radiated frequency is out of the restricted band.

CHANNEL	TX Channel 110	DETECTOR FUNCTION	Peak (PK)
FREQUENCY RANGE	1GHz ~ 40GHz		Average (AV)

**ANTENNA POLARITY & TEST DISTANCE: HORIZONTAL AT 3 M**

NO.	FREQ. (MHz)	EMISSION LEVEL (dBuV/m)	LIMIT (dBuV/m)	MARGIN (dB)	ANTENNA HEIGHT (m)	TABLE ANGLE (Degree)	RAW VALUE (dBuV)	CORRECTION FACTOR (dB/m)
1	*5550.00	102.6 PK			1.56 H	347	62.60	40.00
2	*5550.00	92.2 AV			1.56 H	347	52.20	40.00
3	11100.00	60.4 PK	74.0	-13.6	1.00 H	30	40.80	19.60
4	11100.00	47.6 AV	54.0	-6.4	1.00 H	30	28.00	19.60

**ANTENNA POLARITY & TEST DISTANCE: VERTICAL AT 3 M**

NO.	FREQ. (MHz)	EMISSION LEVEL (dBuV/m)	LIMIT (dBuV/m)	MARGIN (dB)	ANTENNA HEIGHT (m)	TABLE ANGLE (Degree)	RAW VALUE (dBuV)	CORRECTION FACTOR (dB/m)
1	*5550.00	109.4 PK			1.68 V	23	69.40	40.00
2	*5550.00	99.2 AV			1.68 V	23	59.20	40.00
3	11100.00	61.2 PK	74.0	-12.8	1.00 V	48	41.60	19.60
4	11100.00	48.0 AV	54.0	-6.0	1.00 V	48	28.40	19.60

**REMARKS:**

1. Emission Level(dBuV/m) = Raw Value(dBuV) + Correction Factor(dB/m)
2. Correction Factor(dB/m) = Antenna Factor(dB/m) + Cable Factor(dB) – Pre-Amplifier Factor(dB)
3. The other emission levels were very low against the limit.
4. Margin value = Emission Level – Limit value
5. " \* ": Fundamental frequency.

CHANNEL	TX Channel 134	DETECTOR FUNCTION	Peak (PK)
FREQUENCY RANGE	1GHz ~ 40GHz		Average (AV)

**ANTENNA POLARITY & TEST DISTANCE: HORIZONTAL AT 3 M**

NO.	FREQ. (MHz)	EMISSION LEVEL (dBuV/m)	LIMIT (dBuV/m)	MARGIN (dB)	ANTENNA HEIGHT (m)	TABLE ANGLE (Degree)	RAW VALUE (dBuV)	CORRECTION FACTOR (dB/m)
1	*5670.00	101.4 PK			1.00 H	9	61.20	40.20
2	*5670.00	91.5 AV			1.00 H	9	51.30	40.20
3	#5725.00	56.3 PK	74.0	-17.7	1.89 H	18	50.00	6.30
4	#5725.00	43.6 AV	54.0	-10.4	1.89 H	18	37.30	6.30
5	11340.00	61.5 PK	74.0	-12.5	1.67 H	274	41.80	19.70
6	11340.00	48.5 AV	54.0	-5.5	1.67 H	274	28.80	19.70

**ANTENNA POLARITY & TEST DISTANCE: VERTICAL AT 3 M**

NO.	FREQ. (MHz)	EMISSION LEVEL (dBuV/m)	LIMIT (dBuV/m)	MARGIN (dB)	ANTENNA HEIGHT (m)	TABLE ANGLE (Degree)	RAW VALUE (dBuV)	CORRECTION FACTOR (dB/m)
1	*5670.00	109.0 PK			1.69 V	23	68.80	40.20
2	*5670.00	99.3 AV			1.69 V	23	59.10	40.20
3	#5725.00	58.4 PK	74.0	-15.6	1.74 V	66	52.10	6.30
4	#5725.00	45.4 AV	54.0	-8.6	1.74 V	66	39.10	6.30
5	11340.00	61.6 PK	74.0	-12.4	1.90 V	6	41.90	19.70
6	11340.00	48.5 AV	54.0	-5.5	1.90 V	6	28.80	19.70

**REMARKS:**

1. Emission Level(dBuV/m) = Raw Value(dBuV) + Correction Factor(dB/m)
2. Correction Factor(dB/m) = Antenna Factor(dB/m) + Cable Factor(dB) – Pre-Amplifier Factor(dB)
3. The other emission levels were very low against the limit.
4. Margin value = Emission Level – Limit value
5. " \* ": Fundamental frequency.
6. " # ": The radiated frequency is out of the restricted band.



802.11ac (VHT80)

CHANNEL	TX Channel 58	DETECTOR FUNCTION	Peak (PK)
FREQUENCY RANGE	1GHz ~ 40GHz		Average (AV)

ANTENNA POLARITY & TEST DISTANCE: HORIZONTAL AT 3 M								
NO.	FREQ. (MHz)	EMISSION LEVEL (dBuV/m)	LIMIT (dBuV/m)	MARGIN (dB)	ANTENNA HEIGHT (m)	TABLE ANGLE (Degree)	RAW VALUE (dBuV)	CORRECTION FACTOR (dB/m)
1	*5290.00	101.4 PK			1.73 H	358	61.80	39.60
2	*5290.00	89.9 AV			1.73 H	358	50.30	39.60
3	5350.00	71.4 PK	74.0	-2.6	1.05 H	20	65.70	5.70
4	5350.00	47.9 AV	54.0	-6.1	1.05 H	20	42.20	5.70
5	#10580.00	60.3 PK	74.0	-13.7	1.58 H	221	42.00	18.30
6	#10580.00	46.6 AV	54.0	-7.4	1.58 H	221	28.30	18.30

ANTENNA POLARITY & TEST DISTANCE: VERTICAL AT 3 M								
NO.	FREQ. (MHz)	EMISSION LEVEL (dBuV/m)	LIMIT (dBuV/m)	MARGIN (dB)	ANTENNA HEIGHT (m)	TABLE ANGLE (Degree)	RAW VALUE (dBuV)	CORRECTION FACTOR (dB/m)
1	*5290.00	108.8 PK			1.18 V	55	69.20	39.60
2	*5290.00	95.8 AV			1.18 V	55	56.20	39.60
3	5350.00	73.1 PK	74.0	-0.9	1.73 V	89	67.40	5.70
4	5350.00	48.6 AV	54.0	-5.4	1.73 V	89	42.90	5.70
5	#10580.00	60.5 PK	74.0	-13.5	1.69 V	32	42.20	18.30
6	#10580.00	46.9 AV	54.0	-7.1	1.69 V	32	28.60	18.30

REMARKS:

1. Emission Level(dBuV/m) = Raw Value(dBuV) + Correction Factor(dB/m)
2. Correction Factor(dB/m) = Antenna Factor(dB/m) + Cable Factor(dB) – Pre-Amplifier Factor(dB)
3. The other emission levels were very low against the limit.
4. Margin value = Emission Level – Limit value
5. " \* ": Fundamental frequency.
6. " # ": The radiated frequency is out of the restricted band.

CHANNEL	TX Channel 106	DETECTOR FUNCTION	Peak (PK)
FREQUENCY RANGE	1GHz ~ 40GHz		Average (AV)

**ANTENNA POLARITY & TEST DISTANCE: HORIZONTAL AT 3 M**

NO.	FREQ. (MHz)	EMISSION LEVEL (dBuV/m)	LIMIT (dBuV/m)	MARGIN (dB)	ANTENNA HEIGHT (m)	TABLE ANGLE (Degree)	RAW VALUE (dBuV)	CORRECTION FACTOR (dB/m)
1	5460.00	65.2 PK	74.0	-8.8	1.80 H	77	59.40	5.80
2	5460.00	44.7 AV	54.0	-9.3	1.80 H	77	38.90	5.80
3	#5470.00	63.4 PK	74.0	-10.6	1.58 H	48	57.50	5.90
4	#5470.00	44.7 AV	54.0	-9.3	1.58 H	48	38.80	5.90
5	*5530.00	99.3 PK			1.24 H	36	59.40	39.90
6	*5530.00	88.7 AV			1.24 H	36	48.80	39.90
7	11060.00	59.9 PK	74.0	-14.1	1.55 H	190	40.70	19.20
8	11060.00	47.5 AV	54.0	-6.5	1.55 H	190	28.30	19.20

**ANTENNA POLARITY & TEST DISTANCE: VERTICAL AT 3 M**

NO.	FREQ. (MHz)	EMISSION LEVEL (dBuV/m)	LIMIT (dBuV/m)	MARGIN (dB)	ANTENNA HEIGHT (m)	TABLE ANGLE (Degree)	RAW VALUE (dBuV)	CORRECTION FACTOR (dB/m)
1	5460.00	72.8 PK	74.0	-1.2	1.40 V	55	67.00	5.80
2	5460.00	49.0 AV	54.0	-5.0	1.40 V	55	43.20	5.80
3	#5470.00	67.9 PK	74.0	-6.1	1.74 V	1	62.00	5.90
4	#5470.00	49.6 AV	54.0	-4.4	1.74 V	1	43.70	5.90
5	*5530.00	106.7 PK			1.71 V	99	66.80	39.90
6	*5530.00	96.2 AV			1.71 V	99	56.30	39.90
7	11060.00	60.4 PK	74.0	-13.6	1.25 V	18	41.20	19.20
8	11060.00	47.6 AV	54.0	-6.4	1.25 V	18	28.40	19.20

**REMARKS:**

1. Emission Level(dBuV/m) = Raw Value(dBuV) + Correction Factor(dB/m)
2. Correction Factor(dB/m) = Antenna Factor(dB/m) + Cable Factor(dB) – Pre-Amplifier Factor(dB)
3. The other emission levels were very low against the limit.
4. Margin value = Emission Level – Limit value
5. " \* ": Fundamental frequency.
6. " # ": The radiated frequency is out of the restricted band.

Test Mode D

**1TX**

802.11a

CHANNEL	TX Channel 52	DETECTOR FUNCTION	Peak (PK)
FREQUENCY RANGE	1GHz ~ 40GHz		Average (AV)

ANTENNA POLARITY & TEST DISTANCE: HORIZONTAL AT 3 M								
NO.	FREQ. (MHz)	EMISSION LEVEL (dBuV/m)	LIMIT (dBuV/m)	MARGIN (dB)	ANTENNA HEIGHT (m)	TABLE ANGLE (Degree)	RAW VALUE (dBuV)	CORRECTION FACTOR (dB/m)
1	5150.00	59.3 PK	74.0	-14.7	1.40 H	42	53.80	5.50
2	5150.00	46.8 AV	54.0	-7.2	1.40 H	42	41.30	5.50
3	*5260.00	108.5 PK			1.49 H	44	68.90	39.60
4	*5260.00	98.4 AV			1.49 H	44	58.80	39.60
5	#10520.00	61.4 PK	74.0	-12.6	1.00 H	52	43.30	18.10
6	#10520.00	48.2 AV	54.0	-5.8	1.00 H	52	30.10	18.10
ANTENNA POLARITY & TEST DISTANCE: VERTICAL AT 3 M								
NO.	FREQ. (MHz)	EMISSION LEVEL (dBuV/m)	LIMIT (dBuV/m)	MARGIN (dB)	ANTENNA HEIGHT (m)	TABLE ANGLE (Degree)	RAW VALUE (dBuV)	CORRECTION FACTOR (dB/m)
1	5150.00	59.9 PK	74.0	-14.1	1.83 V	10	54.40	5.50
2	5150.00	47.1 AV	54.0	-6.9	1.83 V	10	41.60	5.50
3	*5260.00	115.0 PK			1.83 V	6	75.40	39.60
4	*5260.00	105.1 AV			1.83 V	6	65.50	39.60
5	#10520.00	61.9 PK	74.0	-12.1	1.03 V	3	43.80	18.10
6	#10520.00	48.6 AV	54.0	-5.4	1.03 V	3	30.50	18.10

REMARKS:

1. Emission Level(dBuV/m) = Raw Value(dBuV) + Correction Factor(dB/m)
2. Correction Factor(dB/m) = Antenna Factor(dB/m) + Cable Factor(dB) – Pre-Amplifier Factor(dB)
3. The other emission levels were very low against the limit.
4. Margin value = Emission Level – Limit value
5. " \* ": Fundamental frequency.
6. " # ": The radiated frequency is out of the restricted band.

CHANNEL	TX Channel 60	DETECTOR FUNCTION	Peak (PK)
FREQUENCY RANGE	1GHz ~ 40GHz		Average (AV)

**ANTENNA POLARITY & TEST DISTANCE: HORIZONTAL AT 3 M**

NO.	FREQ. (MHz)	EMISSION LEVEL (dBuV/m)	LIMIT (dBuV/m)	MARGIN (dB)	ANTENNA HEIGHT (m)	TABLE ANGLE (Degree)	RAW VALUE (dBuV)	CORRECTION FACTOR (dB/m)
1	*5300.00	108.3 PK			1.40 H	42	68.70	39.60
2	*5300.00	98.7 AV			1.40 H	42	59.10	39.60
3	10600.00	61.5 PK	74.0	-12.5	1.00 H	51	43.10	18.40
4	10600.00	48.8 AV	54.0	-5.2	1.00 H	51	30.40	18.40

**ANTENNA POLARITY & TEST DISTANCE: VERTICAL AT 3 M**

NO.	FREQ. (MHz)	EMISSION LEVEL (dBuV/m)	LIMIT (dBuV/m)	MARGIN (dB)	ANTENNA HEIGHT (m)	TABLE ANGLE (Degree)	RAW VALUE (dBuV)	CORRECTION FACTOR (dB/m)
1	*5300.00	115.6 PK			1.81 V	7	76.00	39.60
2	*5300.00	105.8 AV			1.81 V	7	66.20	39.60
3	10600.00	62.0 PK	74.0	-12.0	1.00 V	9	43.60	18.40
4	10600.00	49.0 AV	54.0	-5.0	1.00 V	9	30.60	18.40

**REMARKS:**

1. Emission Level(dBuV/m) = Raw Value(dBuV) + Correction Factor(dB/m)
2. Correction Factor(dB/m) = Antenna Factor(dB/m) + Cable Factor(dB) – Pre-Amplifier Factor(dB)
3. The other emission levels were very low against the limit.
4. Margin value = Emission Level – Limit value
5. " \* ": Fundamental frequency.

CHANNEL	TX Channel 64	DETECTOR FUNCTION	Peak (PK)
FREQUENCY RANGE	1GHz ~ 40GHz		Average (AV)

**ANTENNA POLARITY & TEST DISTANCE: HORIZONTAL AT 3 M**

NO.	FREQ. (MHz)	EMISSION LEVEL (dBuV/m)	LIMIT (dBuV/m)	MARGIN (dB)	ANTENNA HEIGHT (m)	TABLE ANGLE (Degree)	RAW VALUE (dBuV)	CORRECTION FACTOR (dB/m)
1	*5320.00	107.1 PK			1.37 H	42	67.40	39.70
2	*5320.00	97.3 AV			1.37 H	42	57.60	39.70
3	5350.00	64.0 PK	74.0	-10.0	1.34 H	41	58.30	5.70
4	5350.00	47.5 AV	54.0	-6.5	1.34 H	41	41.80	5.70
5	10640.00	61.1 PK	74.0	-12.9	1.00 H	55	42.70	18.40
6	10640.00	48.0 AV	54.0	-6.0	1.00 H	55	29.60	18.40

**ANTENNA POLARITY & TEST DISTANCE: VERTICAL AT 3 M**

NO.	FREQ. (MHz)	EMISSION LEVEL (dBuV/m)	LIMIT (dBuV/m)	MARGIN (dB)	ANTENNA HEIGHT (m)	TABLE ANGLE (Degree)	RAW VALUE (dBuV)	CORRECTION FACTOR (dB/m)
1	*5320.00	114.5 PK			1.80 V	8	74.80	39.70
2	*5320.00	104.1 AV			1.80 V	8	64.40	39.70
3	5350.00	71.6 PK	74.0	-2.4	1.83 V	9	65.90	5.70
4	5350.00	53.6 AV	54.0	-0.4	1.83 V	9	47.90	5.70
5	10640.00	61.3 PK	74.0	-12.7	1.02 V	6	42.90	18.40
6	10640.00	48.5 AV	54.0	-5.5	1.02 V	6	30.10	18.40

**REMARKS:**

1. Emission Level(dBuV/m) = Raw Value(dBuV) + Correction Factor(dB/m)
2. Correction Factor(dB/m) = Antenna Factor(dB/m) + Cable Factor(dB) – Pre-Amplifier Factor(dB)
3. The other emission levels were very low against the limit.
4. Margin value = Emission Level – Limit value
5. " \* ": Fundamental frequency.

CHANNEL	TX Channel 100	DETECTOR FUNCTION	Peak (PK)
FREQUENCY RANGE	1GHz ~ 40GHz		Average (AV)

**ANTENNA POLARITY & TEST DISTANCE: HORIZONTAL AT 3 M**

NO.	FREQ. (MHz)	EMISSION LEVEL (dBuV/m)	LIMIT (dBuV/m)	MARGIN (dB)	ANTENNA HEIGHT (m)	TABLE ANGLE (Degree)	RAW VALUE (dBuV)	CORRECTION FACTOR (dB/m)
1	5460.00	59.1 PK	74.0	-14.9	1.46 H	31	53.30	5.80
2	5460.00	45.1 AV	54.0	-8.9	1.46 H	31	39.30	5.80
3	#5470.00	60.9 PK	74.0	-13.1	1.46 H	31	55.00	5.90
4	#5470.00	47.2 AV	54.0	-6.8	1.46 H	31	41.30	5.90
5	*5500.00	106.2 PK			1.43 H	38	66.30	39.90
6	*5500.00	96.3 AV			1.43 H	38	56.40	39.90
7	11000.00	60.8 PK	74.0	-13.2	1.00 H	55	41.90	18.90
8	11000.00	48.7 AV	54.0	-5.3	1.00 H	55	29.80	18.90

**ANTENNA POLARITY & TEST DISTANCE: VERTICAL AT 3 M**

NO.	FREQ. (MHz)	EMISSION LEVEL (dBuV/m)	LIMIT (dBuV/m)	MARGIN (dB)	ANTENNA HEIGHT (m)	TABLE ANGLE (Degree)	RAW VALUE (dBuV)	CORRECTION FACTOR (dB/m)
1	5460.00	67.2 PK	74.0	-6.8	1.57 V	9	61.40	5.80
2	5460.00	50.3 AV	54.0	-3.7	1.57 V	9	44.50	5.80
3	#5470.00	68.9 PK	74.0	-5.1	1.57 V	9	63.00	5.90
4	#5470.00	53.8 AV	54.0	-0.2	1.57 V	9	47.90	5.90
5	*5500.00	114.9 PK			1.51 V	10	75.00	39.90
6	*5500.00	104.5 AV			1.51 V	10	64.60	39.90
7	11000.00	61.5 PK	74.0	-12.5	1.02 V	6	42.60	18.90
8	11000.00	49.0 AV	54.0	-5.0	1.02 V	6	30.10	18.90

**REMARKS:**

1. Emission Level(dBuV/m) = Raw Value(dBuV) + Correction Factor(dB/m)
2. Correction Factor(dB/m) = Antenna Factor(dB/m) + Cable Factor(dB) – Pre-Amplifier Factor(dB)
3. The other emission levels were very low against the limit.
4. Margin value = Emission Level – Limit value
5. " \* ": Fundamental frequency.
6. " # ": The radiated frequency is out of the restricted band.

CHANNEL	TX Channel 116	DETECTOR FUNCTION	Peak (PK)
FREQUENCY RANGE	1GHz ~ 40GHz		Average (AV)

**ANTENNA POLARITY & TEST DISTANCE: HORIZONTAL AT 3 M**

NO.	FREQ. (MHz)	EMISSION LEVEL (dBuV/m)	LIMIT (dBuV/m)	MARGIN (dB)	ANTENNA HEIGHT (m)	TABLE ANGLE (Degree)	RAW VALUE (dBuV)	CORRECTION FACTOR (dB/m)
1	*5580.00	108.0 PK			1.41 H	48	68.10	39.90
2	*5580.00	97.5 AV			1.41 H	48	57.60	39.90
3	11160.00	61.1 PK	74.0	-12.9	1.00 H	58	41.90	19.20
4	11160.00	49.1 AV	54.0	-4.9	1.00 H	58	29.90	19.20

**ANTENNA POLARITY & TEST DISTANCE: VERTICAL AT 3 M**

NO.	FREQ. (MHz)	EMISSION LEVEL (dBuV/m)	LIMIT (dBuV/m)	MARGIN (dB)	ANTENNA HEIGHT (m)	TABLE ANGLE (Degree)	RAW VALUE (dBuV)	CORRECTION FACTOR (dB/m)
1	*5580.00	116.1 PK			1.70 V	9	76.20	39.90
2	*5580.00	105.9 AV			1.70 V	9	66.00	39.90
3	11160.00	61.9 PK	74.0	-12.1	1.00 V	10	42.70	19.20
4	11160.00	49.6 AV	54.0	-4.4	1.00 V	10	30.40	19.20

**REMARKS:**

1. Emission Level(dBuV/m) = Raw Value(dBuV) + Correction Factor(dB/m)
2. Correction Factor(dB/m) = Antenna Factor(dB/m) + Cable Factor(dB) – Pre-Amplifier Factor(dB)
3. The other emission levels were very low against the limit.
4. Margin value = Emission Level – Limit value
5. " \* ": Fundamental frequency.

CHANNEL	TX Channel 140	DETECTOR FUNCTION	Peak (PK)
FREQUENCY RANGE	1GHz ~ 40GHz		Average (AV)

**ANTENNA POLARITY & TEST DISTANCE: HORIZONTAL AT 3 M**

NO.	FREQ. (MHz)	EMISSION LEVEL (dBuV/m)	LIMIT (dBuV/m)	MARGIN (dB)	ANTENNA HEIGHT (m)	TABLE ANGLE (Degree)	RAW VALUE (dBuV)	CORRECTION FACTOR (dB/m)
1	*5700.00	105.1 PK			1.25 H	51	64.80	40.30
2	*5700.00	95.4 AV			1.25 H	51	55.10	40.30
3	#5725.00	63.0 PK	74.0	-11.0	1.27 H	50	56.70	6.30
4	#5725.00	48.6 AV	54.0	-5.4	1.27 H	50	42.30	6.30
5	11400.00	60.9 PK	74.0	-13.1	1.00 H	57	41.20	19.70
6	11400.00	48.9 AV	54.0	-5.1	1.00 H	57	29.20	19.70

**ANTENNA POLARITY & TEST DISTANCE: VERTICAL AT 3 M**

NO.	FREQ. (MHz)	EMISSION LEVEL (dBuV/m)	LIMIT (dBuV/m)	MARGIN (dB)	ANTENNA HEIGHT (m)	TABLE ANGLE (Degree)	RAW VALUE (dBuV)	CORRECTION FACTOR (dB/m)
1	*5700.00	112.0 PK			1.74 V	10	71.70	40.30
2	*5700.00	101.7 AV			1.74 V	10	61.40	40.30
3	#5725.00	70.1 PK	74.0	-3.9	1.79 V	10	63.80	6.30
4	#5725.00	53.6 AV	54.0	-0.4	1.79 V	10	47.30	6.30
5	11400.00	61.7 PK	74.0	-12.3	1.09 V	9	42.00	19.70
6	11400.00	49.1 AV	54.0	-4.9	1.09 V	9	29.40	19.70

**REMARKS:**

1. Emission Level(dBuV/m) = Raw Value(dBuV) + Correction Factor(dB/m)
2. Correction Factor(dB/m) = Antenna Factor(dB/m) + Cable Factor(dB) – Pre-Amplifier Factor(dB)
3. The other emission levels were very low against the limit.
4. Margin value = Emission Level – Limit value
5. " \* ": Fundamental frequency.
6. " # ": The radiated frequency is out of the restricted band.



**802.11n (HT20)**

CHANNEL	TX Channel 52	DETECTOR FUNCTION	Peak (PK)
FREQUENCY RANGE	1GHz ~ 40GHz		Average (AV)

ANTENNA POLARITY & TEST DISTANCE: HORIZONTAL AT 3 M								
NO.	FREQ. (MHz)	EMISSION LEVEL (dBuV/m)	LIMIT (dBuV/m)	MARGIN (dB)	ANTENNA HEIGHT (m)	TABLE ANGLE (Degree)	RAW VALUE (dBuV)	CORRECTION FACTOR (dB/m)
1	5150.00	59.2 PK	74.0	-14.8	1.43 H	46	53.70	5.50
2	5150.00	46.4 AV	54.0	-7.6	1.43 H	46	40.90	5.50
3	*5260.00	108.7 PK			1.48 H	46	69.10	39.60
4	*5260.00	98.1 AV			1.48 H	46	58.50	39.60
5	#10520.00	61.0 PK	74.0	-13.0	1.00 H	59	42.90	18.10
6	#10520.00	47.9 AV	54.0	-6.1	1.00 H	59	29.80	18.10

ANTENNA POLARITY & TEST DISTANCE: VERTICAL AT 3 M								
NO.	FREQ. (MHz)	EMISSION LEVEL (dBuV/m)	LIMIT (dBuV/m)	MARGIN (dB)	ANTENNA HEIGHT (m)	TABLE ANGLE (Degree)	RAW VALUE (dBuV)	CORRECTION FACTOR (dB/m)
1	5150.00	59.8 PK	74.0	-14.2	1.80 V	10	54.30	5.50
2	5150.00	46.7 AV	54.0	-7.3	1.80 V	10	41.20	5.50
3	*5260.00	115.4 PK			1.82 V	10	75.80	39.60
4	*5260.00	105.0 AV			1.82 V	10	65.40	39.60
5	#10520.00	61.3 PK	74.0	-12.7	1.00 V	1	43.20	18.10
6	#10520.00	48.5 AV	54.0	-5.5	1.00 V	1	30.40	18.10

**REMARKS:**

1. Emission Level(dBuV/m) = Raw Value(dBuV) + Correction Factor(dB/m)
2. Correction Factor(dB/m) = Antenna Factor(dB/m) + Cable Factor(dB) – Pre-Amplifier Factor(dB)
3. The other emission levels were very low against the limit.
4. Margin value = Emission Level – Limit value
5. " \* ": Fundamental frequency.
6. " # ": The radiated frequency is out of the restricted band.

CHANNEL	TX Channel 60	DETECTOR FUNCTION	Peak (PK)
FREQUENCY RANGE	1GHz ~ 40GHz		Average (AV)

**ANTENNA POLARITY & TEST DISTANCE: HORIZONTAL AT 3 M**

NO.	FREQ. (MHz)	EMISSION LEVEL (dBuV/m)	LIMIT (dBuV/m)	MARGIN (dB)	ANTENNA HEIGHT (m)	TABLE ANGLE (Degree)	RAW VALUE (dBuV)	CORRECTION FACTOR (dB/m)
1	*5300.00	109.1 PK			1.41 H	41	69.50	39.60
2	*5300.00	98.9 AV			1.41 H	41	59.30	39.60
3	10600.00	61.4 PK	74.0	-12.6	1.00 H	55	43.00	18.40
4	10600.00	48.2 AV	54.0	-5.8	1.00 H	55	29.80	18.40

**ANTENNA POLARITY & TEST DISTANCE: VERTICAL AT 3 M**

NO.	FREQ. (MHz)	EMISSION LEVEL (dBuV/m)	LIMIT (dBuV/m)	MARGIN (dB)	ANTENNA HEIGHT (m)	TABLE ANGLE (Degree)	RAW VALUE (dBuV)	CORRECTION FACTOR (dB/m)
1	*5300.00	116.3 PK			1.72 V	5	76.70	39.60
2	*5300.00	105.1 AV			1.72 V	5	65.50	39.60
3	10600.00	61.9 PK	74.0	-12.1	1.02 V	10	43.50	18.40
4	10600.00	48.6 AV	54.0	-5.4	1.02 V	10	30.20	18.40

**REMARKS:**

1. Emission Level(dBuV/m) = Raw Value(dBuV) + Correction Factor(dB/m)
2. Correction Factor(dB/m) = Antenna Factor(dB/m) + Cable Factor(dB) – Pre-Amplifier Factor(dB)
3. The other emission levels were very low against the limit.
4. Margin value = Emission Level – Limit value
5. " \* ": Fundamental frequency.

CHANNEL	TX Channel 64	DETECTOR FUNCTION	Peak (PK)
FREQUENCY RANGE	1GHz ~ 40GHz		Average (AV)

**ANTENNA POLARITY & TEST DISTANCE: HORIZONTAL AT 3 M**

NO.	FREQ. (MHz)	EMISSION LEVEL (dBuV/m)	LIMIT (dBuV/m)	MARGIN (dB)	ANTENNA HEIGHT (m)	TABLE ANGLE (Degree)	RAW VALUE (dBuV)	CORRECTION FACTOR (dB/m)
1	*5320.00	107.2 PK			1.39 H	42	67.50	39.70
2	*5320.00	96.5 AV			1.39 H	42	56.80	39.70
3	5350.00	63.4 PK	74.0	-10.6	1.35 H	40	57.70	5.70
4	5350.00	47.5 AV	54.0	-6.5	1.35 H	40	41.80	5.70
5	10640.00	60.9 PK	74.0	-13.1	1.00 H	50	42.50	18.40
6	10640.00	47.4 AV	54.0	-6.6	1.00 H	50	29.00	18.40

**ANTENNA POLARITY & TEST DISTANCE: VERTICAL AT 3 M**

NO.	FREQ. (MHz)	EMISSION LEVEL (dBuV/m)	LIMIT (dBuV/m)	MARGIN (dB)	ANTENNA HEIGHT (m)	TABLE ANGLE (Degree)	RAW VALUE (dBuV)	CORRECTION FACTOR (dB/m)
1	*5320.00	114.6 PK			1.80 V	6	74.90	39.70
2	*5320.00	103.7 AV			1.80 V	6	64.00	39.70
3	5350.00	72.3 PK	74.0	-1.7	1.80 V	4	66.60	5.70
<b>4</b>	<b>5350.00</b>	<b>53.9 AV</b>	<b>54.0</b>	<b>-0.1</b>	<b>1.80 V</b>	<b>4</b>	<b>48.20</b>	<b>5.70</b>
5	10640.00	61.0 PK	74.0	-13.0	1.04 V	14	42.60	18.40
6	10640.00	48.4 AV	54.0	-5.6	1.04 V	14	30.00	18.40

**REMARKS:**

1. Emission Level(dBuV/m) = Raw Value(dBuV) + Correction Factor(dB/m)
2. Correction Factor(dB/m) = Antenna Factor(dB/m) + Cable Factor(dB) – Pre-Amplifier Factor(dB)
3. The other emission levels were very low against the limit.
4. Margin value = Emission Level – Limit value
5. " \* ": Fundamental frequency.

CHANNEL	TX Channel 100	DETECTOR FUNCTION	Peak (PK)
FREQUENCY RANGE	1GHz ~ 40GHz		Average (AV)

**ANTENNA POLARITY & TEST DISTANCE: HORIZONTAL AT 3 M**

NO.	FREQ. (MHz)	EMISSION LEVEL (dBuV/m)	LIMIT (dBuV/m)	MARGIN (dB)	ANTENNA HEIGHT (m)	TABLE ANGLE (Degree)	RAW VALUE (dBuV)	CORRECTION FACTOR (dB/m)
1	5460.00	58.7 PK	74.0	-15.3	1.42 H	32	52.90	5.80
2	5460.00	45.1 AV	54.0	-8.9	1.42 H	32	39.30	5.80
3	#5470.00	61.3 PK	74.0	-12.7	1.42 H	32	55.40	5.90
4	#5470.00	47.1 AV	54.0	-6.9	1.42 H	32	41.20	5.90
5	*5500.00	107.0 PK			1.42 H	34	67.10	39.90
6	*5500.00	96.2 AV			1.42 H	34	56.30	39.90
7	11000.00	60.1 PK	74.0	-13.9	1.00 H	54	41.20	18.90
8	11000.00	47.9 AV	54.0	-6.1	1.00 H	54	29.00	18.90

**ANTENNA POLARITY & TEST DISTANCE: VERTICAL AT 3 M**

NO.	FREQ. (MHz)	EMISSION LEVEL (dBuV/m)	LIMIT (dBuV/m)	MARGIN (dB)	ANTENNA HEIGHT (m)	TABLE ANGLE (Degree)	RAW VALUE (dBuV)	CORRECTION FACTOR (dB/m)
1	5460.00	65.2 PK	74.0	-8.8	1.56 V	1	59.40	5.80
2	5460.00	49.7 AV	54.0	-4.3	1.56 V	1	43.90	5.80
3	#5470.00	70.1 PK	74.0	-3.9	1.56 V	1	64.20	5.90
4	#5470.00	<b>53.9 AV</b>	<b>54.0</b>	<b>-0.1</b>	<b>1.56 V</b>	<b>1</b>	<b>48.00</b>	<b>5.90</b>
5	*5500.00	115.1 PK			1.53 V	8	75.20	39.90
6	*5500.00	104.3 AV			1.53 V	8	64.40	39.90
7	11000.00	61.3 PK	74.0	-12.7	1.05 V	7	42.40	18.90
8	11000.00	48.7 AV	54.0	-5.3	1.05 V	7	29.80	18.90

**REMARKS:**

1. Emission Level(dBuV/m) = Raw Value(dBuV) + Correction Factor(dB/m)
2. Correction Factor(dB/m) = Antenna Factor(dB/m) + Cable Factor(dB) – Pre-Amplifier Factor(dB)
3. The other emission levels were very low against the limit.
4. Margin value = Emission Level – Limit value
5. " \* ": Fundamental frequency.
6. " # ": The radiated frequency is out of the restricted band.

CHANNEL	TX Channel 116	DETECTOR FUNCTION	Peak (PK)
FREQUENCY RANGE	1GHz ~ 40GHz		Average (AV)

**ANTENNA POLARITY & TEST DISTANCE: HORIZONTAL AT 3 M**

NO.	FREQ. (MHz)	EMISSION LEVEL (dBuV/m)	LIMIT (dBuV/m)	MARGIN (dB)	ANTENNA HEIGHT (m)	TABLE ANGLE (Degree)	RAW VALUE (dBuV)	CORRECTION FACTOR (dB/m)
1	*5580.00	108.3 PK			1.40 H	47	68.40	39.90
2	*5580.00	97.2 AV			1.40 H	47	57.30	39.90
3	11160.00	60.7 PK	74.0	-13.3	1.00 H	51	41.50	19.20
4	11160.00	48.5 AV	54.0	-5.5	1.00 H	51	29.30	19.20

**ANTENNA POLARITY & TEST DISTANCE: VERTICAL AT 3 M**

NO.	FREQ. (MHz)	EMISSION LEVEL (dBuV/m)	LIMIT (dBuV/m)	MARGIN (dB)	ANTENNA HEIGHT (m)	TABLE ANGLE (Degree)	RAW VALUE (dBuV)	CORRECTION FACTOR (dB/m)
1	*5580.00	116.1 PK			1.72 V	8	76.20	39.90
2	*5580.00	105.3 AV			1.72 V	8	65.40	39.90
3	11160.00	61.8 PK	74.0	-12.2	1.00 V	4	42.60	19.20
4	11160.00	48.9 AV	54.0	-5.1	1.00 V	4	29.70	19.20

**REMARKS:**

1. Emission Level(dBuV/m) = Raw Value(dBuV) + Correction Factor(dB/m)
2. Correction Factor(dB/m) = Antenna Factor(dB/m) + Cable Factor(dB) – Pre-Amplifier Factor(dB)
3. The other emission levels were very low against the limit.
4. Margin value = Emission Level – Limit value
5. " \* ": Fundamental frequency.

CHANNEL	TX Channel 140	DETECTOR FUNCTION	Peak (PK)
FREQUENCY RANGE	1GHz ~ 40GHz		Average (AV)

**ANTENNA POLARITY & TEST DISTANCE: HORIZONTAL AT 3 M**

NO.	FREQ. (MHz)	EMISSION LEVEL (dBuV/m)	LIMIT (dBuV/m)	MARGIN (dB)	ANTENNA HEIGHT (m)	TABLE ANGLE (Degree)	RAW VALUE (dBuV)	CORRECTION FACTOR (dB/m)
1	*5700.00	104.0 PK			1.44 H	48	63.70	40.30
2	*5700.00	93.3 AV			1.44 H	48	53.00	40.30
3	#5725.00	64.0 PK	74.0	-10.0	1.46 H	48	57.70	6.30
4	#5725.00	48.7 AV	54.0	-5.3	1.46 H	48	42.40	6.30
5	11400.00	60.0 PK	74.0	-14.0	1.00 H	52	40.30	19.70
6	11400.00	47.6 AV	54.0	-6.4	1.00 H	52	27.90	19.70

**ANTENNA POLARITY & TEST DISTANCE: VERTICAL AT 3 M**

NO.	FREQ. (MHz)	EMISSION LEVEL (dBuV/m)	LIMIT (dBuV/m)	MARGIN (dB)	ANTENNA HEIGHT (m)	TABLE ANGLE (Degree)	RAW VALUE (dBuV)	CORRECTION FACTOR (dB/m)
1	*5700.00	111.8 PK			1.89 V	10	71.50	40.30
2	*5700.00	101.0 AV			1.89 V	10	60.70	40.30
3	#5725.00	72.7 PK	74.0	-1.3	1.89 V	12	66.40	6.30
4	#5725.00	53.5 AV	54.0	-0.5	1.89 V	12	47.20	6.30
5	11400.00	60.9 PK	74.0	-13.1	1.01 V	17	41.20	19.70
6	11400.00	48.1 AV	54.0	-5.9	1.01 V	17	28.40	19.70

**REMARKS:**

1. Emission Level(dBuV/m) = Raw Value(dBuV) + Correction Factor(dB/m)
2. Correction Factor(dB/m) = Antenna Factor(dB/m) + Cable Factor(dB) – Pre-Amplifier Factor(dB)
3. The other emission levels were very low against the limit.
4. Margin value = Emission Level – Limit value
5. " \* ": Fundamental frequency.
6. " # ": The radiated frequency is out of the restricted band.

802.11n (HT40)

CHANNEL	TX Channel 54	DETECTOR FUNCTION	Peak (PK)
FREQUENCY RANGE	1GHz ~ 40GHz		Average (AV)

ANTENNA POLARITY & TEST DISTANCE: HORIZONTAL AT 3 M								
NO.	FREQ. (MHz)	EMISSION LEVEL (dBuV/m)	LIMIT (dBuV/m)	MARGIN (dB)	ANTENNA HEIGHT (m)	TABLE ANGLE (Degree)	RAW VALUE (dBuV)	CORRECTION FACTOR (dB/m)
1	*5270.00	105.4 PK			1.46 H	44	65.80	39.60
2	*5270.00	95.2 AV			1.46 H	44	55.60	39.60
3	5350.00	62.2 PK	74.0	-11.8	1.46 H	41	56.50	5.70
4	5350.00	48.7 AV	54.0	-5.3	1.46 H	41	43.00	5.70
5	#10540.00	60.3 PK	74.0	-13.7	1.00 H	57	42.20	18.10
6	#10540.00	47.7 AV	54.0	-6.3	1.00 H	57	29.60	18.10

ANTENNA POLARITY & TEST DISTANCE: VERTICAL AT 3 M								
NO.	FREQ. (MHz)	EMISSION LEVEL (dBuV/m)	LIMIT (dBuV/m)	MARGIN (dB)	ANTENNA HEIGHT (m)	TABLE ANGLE (Degree)	RAW VALUE (dBuV)	CORRECTION FACTOR (dB/m)
1	*5270.00	112.9 PK			1.82 V	7	73.30	39.60
2	*5270.00	102.7 AV			1.82 V	7	63.10	39.60
3	5350.00	69.7 PK	74.0	-4.3	1.86 V	10	64.00	5.70
4	5350.00	53.7 AV	54.0	-0.3	1.86 V	10	48.00	5.70
5	#10540.00	61.1 PK	74.0	-12.9	1.06 V	6	43.00	18.10
6	#10540.00	47.9 AV	54.0	-6.1	1.06 V	6	29.80	18.10

REMARKS:

1. Emission Level(dBuV/m) = Raw Value(dBuV) + Correction Factor(dB/m)
2. Correction Factor(dB/m) = Antenna Factor(dB/m) + Cable Factor(dB) – Pre-Amplifier Factor(dB)
3. The other emission levels were very low against the limit.
4. Margin value = Emission Level – Limit value
5. " \* ": Fundamental frequency.
6. " # ": The radiated frequency is out of the restricted band.

CHANNEL	TX Channel 62	DETECTOR FUNCTION	Peak (PK)
FREQUENCY RANGE	1GHz ~ 40GHz		Average (AV)

**ANTENNA POLARITY & TEST DISTANCE: HORIZONTAL AT 3 M**

NO.	FREQ. (MHz)	EMISSION LEVEL (dBuV/m)	LIMIT (dBuV/m)	MARGIN (dB)	ANTENNA HEIGHT (m)	TABLE ANGLE (Degree)	RAW VALUE (dBuV)	CORRECTION FACTOR (dB/m)
1	*5310.00	101.7 PK			1.46 H	41	62.10	39.60
2	*5310.00	90.9 AV			1.46 H	41	51.30	39.60
3	5350.00	62.2 PK	74.0	-11.8	1.48 H	49	56.50	5.70
4	5350.00	48.0 AV	54.0	-6.0	1.48 H	49	42.30	5.70
5	10620.00	59.8 PK	74.0	-14.2	1.00 H	51	41.50	18.30
6	10620.00	47.2 AV	54.0	-6.8	1.00 H	51	28.90	18.30

**ANTENNA POLARITY & TEST DISTANCE: VERTICAL AT 3 M**

NO.	FREQ. (MHz)	EMISSION LEVEL (dBuV/m)	LIMIT (dBuV/m)	MARGIN (dB)	ANTENNA HEIGHT (m)	TABLE ANGLE (Degree)	RAW VALUE (dBuV)	CORRECTION FACTOR (dB/m)
1	*5310.00	108.6 PK			1.73 V	5	69.00	39.60
2	*5310.00	98.1 AV			1.73 V	5	58.50	39.60
3	5350.00	69.5 PK	74.0	-4.5	1.77 V	5	63.80	5.70
4	5350.00	53.7 AV	54.0	-0.3	1.77 V	5	48.00	5.70
5	10620.00	60.6 PK	74.0	-13.4	1.02 V	12	42.30	18.30
6	10620.00	47.6 AV	54.0	-6.4	1.02 V	12	29.30	18.30

**REMARKS:**

1. Emission Level(dBuV/m) = Raw Value(dBuV) + Correction Factor(dB/m)
2. Correction Factor(dB/m) = Antenna Factor(dB/m) + Cable Factor(dB) – Pre-Amplifier Factor(dB)
3. The other emission levels were very low against the limit.
4. Margin value = Emission Level – Limit value
5. " \* ": Fundamental frequency.



CHANNEL	TX Channel 102	DETECTOR FUNCTION	Peak (PK)
FREQUENCY RANGE	1GHz ~ 40GHz		Average (AV)

**ANTENNA POLARITY & TEST DISTANCE: HORIZONTAL AT 3 M**

NO.	FREQ. (MHz)	EMISSION LEVEL (dBuV/m)	LIMIT (dBuV/m)	MARGIN (dB)	ANTENNA HEIGHT (m)	TABLE ANGLE (Degree)	RAW VALUE (dBuV)	CORRECTION FACTOR (dB/m)
1	5460.00	61.1 PK	74.0	-12.9	1.45 H	30	55.30	5.80
2	5460.00	45.0 AV	54.0	-9.0	1.45 H	30	39.20	5.80
3	#5470.00	65.8 PK	74.0	-8.2	1.45 H	30	59.90	5.90
4	#5470.00	47.2 AV	54.0	-6.8	1.45 H	30	41.30	5.90
5	*5510.00	100.6 PK			1.42 H	36	60.70	39.90
6	*5510.00	90.1 AV			1.42 H	36	50.20	39.90
7	11020.00	59.7 PK	74.0	-14.3	1.00 H	55	40.70	19.00
8	11020.00	47.3 AV	54.0	-6.7	1.00 H	55	28.30	19.00

**ANTENNA POLARITY & TEST DISTANCE: VERTICAL AT 3 M**

NO.	FREQ. (MHz)	EMISSION LEVEL (dBuV/m)	LIMIT (dBuV/m)	MARGIN (dB)	ANTENNA HEIGHT (m)	TABLE ANGLE (Degree)	RAW VALUE (dBuV)	CORRECTION FACTOR (dB/m)
1	5460.00	68.8 PK	74.0	-5.2	1.59 V	6	63.00	5.80
2	5460.00	48.8 AV	54.0	-5.2	1.59 V	6	43.00	5.80
3	#5470.00	72.0 PK	74.0	-2.0	1.59 V	6	66.10	5.90
4	#5470.00	53.8 AV	54.0	-0.2	1.59 V	6	47.90	5.90
5	*5510.00	109.5 PK			1.51 V	10	69.60	39.90
6	*5510.00	98.7 AV			1.51 V	10	58.80	39.90
7	11020.00	61.1 PK	74.0	-12.9	1.03 V	15	42.10	19.00
8	11020.00	48.5 AV	54.0	-5.5	1.03 V	15	29.50	19.00

**REMARKS:**

1. Emission Level(dBuV/m) = Raw Value(dBuV) + Correction Factor(dB/m)
2. Correction Factor(dB/m) = Antenna Factor(dB/m) + Cable Factor(dB) – Pre-Amplifier Factor(dB)
3. The other emission levels were very low against the limit.
4. Margin value = Emission Level – Limit value
5. " \* ": Fundamental frequency.
6. " # ": The radiated frequency is out of the restricted band.

CHANNEL	TX Channel 110	DETECTOR FUNCTION	Peak (PK)
FREQUENCY RANGE	1GHz ~ 40GHz		Average (AV)

**ANTENNA POLARITY & TEST DISTANCE: HORIZONTAL AT 3 M**

NO.	FREQ. (MHz)	EMISSION LEVEL (dBuV/m)	LIMIT (dBuV/m)	MARGIN (dB)	ANTENNA HEIGHT (m)	TABLE ANGLE (Degree)	RAW VALUE (dBuV)	CORRECTION FACTOR (dB/m)
1	#5470.00	64.6 PK	74.0	-9.4	1.46 H	45	58.70	5.90
2	#5470.00	46.7 AV	54.0	-7.3	1.46 H	45	40.80	5.90
3	*5550.00	105.5 PK			1.44 H	47	65.50	40.00
4	*5550.00	95.2 AV			1.44 H	47	55.20	40.00
5	11100.00	60.0 PK	74.0	-14.0	1.00 H	56	40.40	19.60
6	11100.00	48.4 AV	54.0	-5.6	1.00 H	56	28.80	19.60

**ANTENNA POLARITY & TEST DISTANCE: VERTICAL AT 3 M**

NO.	FREQ. (MHz)	EMISSION LEVEL (dBuV/m)	LIMIT (dBuV/m)	MARGIN (dB)	ANTENNA HEIGHT (m)	TABLE ANGLE (Degree)	RAW VALUE (dBuV)	CORRECTION FACTOR (dB/m)
1	#5470.00	71.9 PK	74.0	-2.1	1.57 V	2	66.00	5.90
2	#5470.00	53.7 AV	54.0	-0.3	1.57 V	2	47.80	5.90
3	*5550.00	114.3 PK			1.51 V	7	74.30	40.00
4	*5550.00	103.8 AV			1.51 V	7	63.80	40.00
5	11100.00	61.6 PK	74.0	-12.4	1.05 V	19	42.00	19.60
6	11100.00	48.6 AV	54.0	-5.4	1.05 V	19	29.00	19.60

**REMARKS:**

1. Emission Level(dBuV/m) = Raw Value(dBuV) + Correction Factor(dB/m)
2. Correction Factor(dB/m) = Antenna Factor(dB/m) + Cable Factor(dB) – Pre-Amplifier Factor(dB)
3. The other emission levels were very low against the limit.
4. Margin value = Emission Level – Limit value
5. " \* ": Fundamental frequency.
6. " # ": The radiated frequency is out of the restricted band.

CHANNEL	TX Channel 134	DETECTOR FUNCTION	Peak (PK)
FREQUENCY RANGE	1GHz ~ 40GHz		Average (AV)

**ANTENNA POLARITY & TEST DISTANCE: HORIZONTAL AT 3 M**

NO.	FREQ. (MHz)	EMISSION LEVEL (dBuV/m)	LIMIT (dBuV/m)	MARGIN (dB)	ANTENNA HEIGHT (m)	TABLE ANGLE (Degree)	RAW VALUE (dBuV)	CORRECTION FACTOR (dB/m)
1	*5670.00	103.0 PK			1.47 H	50	62.80	40.20
2	*5670.00	92.7 AV			1.47 H	50	52.50	40.20
3	#5725.00	61.6 PK	74.0	-12.4	1.40 H	48	55.30	6.30
4	#5725.00	47.7 AV	54.0	-6.3	1.40 H	48	41.40	6.30
5	11340.00	59.8 PK	74.0	-14.2	1.00 H	58	40.10	19.70
6	11340.00	47.7 AV	54.0	-6.3	1.00 H	58	28.00	19.70

**ANTENNA POLARITY & TEST DISTANCE: VERTICAL AT 3 M**

NO.	FREQ. (MHz)	EMISSION LEVEL (dBuV/m)	LIMIT (dBuV/m)	MARGIN (dB)	ANTENNA HEIGHT (m)	TABLE ANGLE (Degree)	RAW VALUE (dBuV)	CORRECTION FACTOR (dB/m)
1	*5670.00	110.4 PK			1.69 V	9	70.20	40.20
2	*5670.00	99.7 AV			1.69 V	9	59.50	40.20
3	#5725.00	68.0 PK	74.0	-6.0	1.66 V	7	61.70	6.30
4	#5725.00	53.6 AV	54.0	-0.4	1.66 V	7	47.30	6.30
5	11340.00	60.6 PK	74.0	-13.4	1.01 V	13	40.90	19.70
6	11340.00	48.4 AV	54.0	-5.6	1.01 V	13	28.70	19.70

**REMARKS:**

1. Emission Level(dBuV/m) = Raw Value(dBuV) + Correction Factor(dB/m)
2. Correction Factor(dB/m) = Antenna Factor(dB/m) + Cable Factor(dB) – Pre-Amplifier Factor(dB)
3. The other emission levels were very low against the limit.
4. Margin value = Emission Level – Limit value
5. " \* ": Fundamental frequency.
6. " # ": The radiated frequency is out of the restricted band.

802.11ac (VHT80)

CHANNEL	TX Channel 58	DETECTOR FUNCTION	Peak (PK)
FREQUENCY RANGE	1GHz ~ 40GHz		Average (AV)

ANTENNA POLARITY & TEST DISTANCE: HORIZONTAL AT 3 M								
NO.	FREQ. (MHz)	EMISSION LEVEL (dBuV/m)	LIMIT (dBuV/m)	MARGIN (dB)	ANTENNA HEIGHT (m)	TABLE ANGLE (Degree)	RAW VALUE (dBuV)	CORRECTION FACTOR (dB/m)
1	*5290.00	94.0 PK			1.42 H	43	54.40	39.60
2	*5290.00	81.6 AV			1.42 H	43	42.00	39.60
3	5350.00	66.6 PK	74.0	-7.4	1.40 H	43	60.90	5.70
4	5350.00	44.3 AV	54.0	-9.7	1.40 H	43	38.60	5.70
5	#10580.00	59.4 PK	74.0	-14.6	1.00 H	53	41.10	18.30
6	#10580.00	46.7 AV	54.0	-7.3	1.00 H	53	28.40	18.30

ANTENNA POLARITY & TEST DISTANCE: VERTICAL AT 3 M								
NO.	FREQ. (MHz)	EMISSION LEVEL (dBuV/m)	LIMIT (dBuV/m)	MARGIN (dB)	ANTENNA HEIGHT (m)	TABLE ANGLE (Degree)	RAW VALUE (dBuV)	CORRECTION FACTOR (dB/m)
1	*5290.00	101.8 PK			1.81 V	9	62.20	39.60
2	*5290.00	89.5 AV			1.81 V	9	49.90	39.60
3	5350.00	73.6 PK	74.0	-0.4	1.89 V	10	67.90	5.70
4	5350.00	47.5 AV	54.0	-6.5	1.89 V	10	41.80	5.70
5	#10580.00	60.4 PK	74.0	-13.6	1.09 V	19	42.10	18.30
6	#10580.00	47.4 AV	54.0	-6.6	1.09 V	19	29.10	18.30

REMARKS:

1. Emission Level(dBuV/m) = Raw Value(dBuV) + Correction Factor(dB/m)
2. Correction Factor(dB/m) = Antenna Factor(dB/m) + Cable Factor(dB) – Pre-Amplifier Factor(dB)
3. The other emission levels were very low against the limit.
4. Margin value = Emission Level – Limit value
5. " \* ": Fundamental frequency.
6. " # ": The radiated frequency is out of the restricted band.

CHANNEL	TX Channel 106	DETECTOR FUNCTION	Peak (PK)
FREQUENCY RANGE	1GHz ~ 40GHz		Average (AV)

**ANTENNA POLARITY & TEST DISTANCE: HORIZONTAL AT 3 M**

NO.	FREQ. (MHz)	EMISSION LEVEL (dBuV/m)	LIMIT (dBuV/m)	MARGIN (dB)	ANTENNA HEIGHT (m)	TABLE ANGLE (Degree)	RAW VALUE (dBuV)	CORRECTION FACTOR (dB/m)
1	5460.00	65.1 PK	74.0	-8.9	1.48 H	36	59.30	5.80
2	5460.00	44.2 AV	54.0	-9.8	1.48 H	36	38.40	5.80
3	#5470.00	67.0 PK	74.0	-7.0	1.48 H	36	61.10	5.90
4	#5470.00	45.4 AV	54.0	-8.6	1.48 H	36	39.50	5.90
5	*5530.00	93.7 PK			1.43 H	38	53.80	39.90
6	*5530.00	83.1 AV			1.43 H	38	43.20	39.90
7	11060.00	59.5 PK	74.0	-14.5	1.00 H	52	40.30	19.20
8	11060.00	46.5 AV	54.0	-7.5	1.00 H	52	27.30	19.20

**ANTENNA POLARITY & TEST DISTANCE: VERTICAL AT 3 M**

NO.	FREQ. (MHz)	EMISSION LEVEL (dBuV/m)	LIMIT (dBuV/m)	MARGIN (dB)	ANTENNA HEIGHT (m)	TABLE ANGLE (Degree)	RAW VALUE (dBuV)	CORRECTION FACTOR (dB/m)
1	5460.00	73.2 PK	74.0	-0.8	1.73 V	3	67.40	5.80
2	5460.00	46.4 AV	54.0	-7.6	1.73 V	3	40.60	5.80
<b>3</b>	<b>#5470.00</b>	<b>73.9 PK</b>	<b>74.0</b>	<b>-0.1</b>	<b>1.73 V</b>	<b>3</b>	<b>68.00</b>	<b>5.90</b>
4	#5470.00	47.2 AV	54.0	-6.8	1.73 V	3	41.30	5.90
5	*5530.00	102.8 PK			1.72 V	9	62.90	39.90
6	*5530.00	91.4 AV			1.72 V	9	51.50	39.90
7	11060.00	60.7 PK	74.0	-13.3	1.06 V	10	41.50	19.20
8	11060.00	47.9 AV	54.0	-6.1	1.06 V	10	28.70	19.20

**REMARKS:**

1. Emission Level(dBuV/m) = Raw Value(dBuV) + Correction Factor(dB/m)
2. Correction Factor(dB/m) = Antenna Factor(dB/m) + Cable Factor(dB) – Pre-Amplifier Factor(dB)
3. The other emission levels were very low against the limit.
4. Margin value = Emission Level – Limit value
5. " \* ": Fundamental frequency.
6. " # ": The radiated frequency is out of the restricted band.

Test Mode D

2TX

802.11a

CHANNEL	TX Channel 52	DETECTOR FUNCTION	Peak (PK)
FREQUENCY RANGE	1GHz ~ 40GHz		Average (AV)

ANTENNA POLARITY & TEST DISTANCE: HORIZONTAL AT 3 M

NO.	FREQ. (MHz)	EMISSION LEVEL (dBuV/m)	LIMIT (dBuV/m)	MARGIN (dB)	ANTENNA HEIGHT (m)	TABLE ANGLE (Degree)	RAW VALUE (dBuV)	CORRECTION FACTOR (dB/m)
1	5150.00	59.4 PK	74.0	-14.6	1.33 H	335	53.90	5.50
2	5150.00	47.1 AV	54.0	-6.9	1.33 H	335	41.60	5.50
3	*5260.00	112.7 PK			1.37 H	333	73.10	39.60
4	*5260.00	102.9 AV			1.37 H	333	63.30	39.60
5	#10520.00	60.9 PK	74.0	-13.1	1.00 H	58	42.80	18.10
6	#10520.00	48.1 AV	54.0	-5.9	1.00 H	58	30.00	18.10

ANTENNA POLARITY & TEST DISTANCE: VERTICAL AT 3 M

NO.	FREQ. (MHz)	EMISSION LEVEL (dBuV/m)	LIMIT (dBuV/m)	MARGIN (dB)	ANTENNA HEIGHT (m)	TABLE ANGLE (Degree)	RAW VALUE (dBuV)	CORRECTION FACTOR (dB/m)
1	5150.00	60.4 PK	74.0	-13.6	1.77 V	1	54.90	5.50
2	5150.00	47.3 AV	54.0	-6.7	1.77 V	1	41.80	5.50
3	*5260.00	118.6 PK			1.71 V	5	79.00	39.60
4	*5260.00	108.7 AV			1.71 V	5	69.10	39.60
5	#10520.00	61.6 PK	74.0	-12.4	1.09 V	16	43.50	18.10
6	#10520.00	48.5 AV	54.0	-5.5	1.09 V	16	30.40	18.10

REMARKS:

1. Emission Level(dBuV/m) = Raw Value(dBuV) + Correction Factor(dB/m)
2. Correction Factor(dB/m) = Antenna Factor(dB/m) + Cable Factor(dB) – Pre-Amplifier Factor(dB)
3. The other emission levels were very low against the limit.
4. Margin value = Emission Level – Limit value
5. " \* ": Fundamental frequency.
6. " # ": The radiated frequency is out of the restricted band.

CHANNEL	TX Channel 60	DETECTOR FUNCTION	Peak (PK)
FREQUENCY RANGE	1GHz ~ 40GHz		Average (AV)

**ANTENNA POLARITY & TEST DISTANCE: HORIZONTAL AT 3 M**

NO.	FREQ. (MHz)	EMISSION LEVEL (dBuV/m)	LIMIT (dBuV/m)	MARGIN (dB)	ANTENNA HEIGHT (m)	TABLE ANGLE (Degree)	RAW VALUE (dBuV)	CORRECTION FACTOR (dB/m)
1	*5300.00	112.3 PK			1.37 H	332	72.70	39.60
2	*5300.00	102.4 AV			1.37 H	332	62.80	39.60
3	10600.00	61.0 PK	74.0	-13.0	1.00 H	50	42.60	18.40
4	10600.00	48.2 AV	54.0	-5.8	1.00 H	50	29.80	18.40

**ANTENNA POLARITY & TEST DISTANCE: VERTICAL AT 3 M**

NO.	FREQ. (MHz)	EMISSION LEVEL (dBuV/m)	LIMIT (dBuV/m)	MARGIN (dB)	ANTENNA HEIGHT (m)	TABLE ANGLE (Degree)	RAW VALUE (dBuV)	CORRECTION FACTOR (dB/m)
1	*5300.00	118.0 PK			1.75 V	2	78.40	39.60
2	*5300.00	108.4 AV			1.75 V	2	68.80	39.60
3	10600.00	61.8 PK	74.0	-12.2	1.03 V	15	43.40	18.40
4	10600.00	48.6 AV	54.0	-5.4	1.03 V	15	30.20	18.40

**REMARKS:**

1. Emission Level(dBuV/m) = Raw Value(dBuV) + Correction Factor(dB/m)
2. Correction Factor(dB/m) = Antenna Factor(dB/m) + Cable Factor(dB) – Pre-Amplifier Factor(dB)
3. The other emission levels were very low against the limit.
4. Margin value = Emission Level – Limit value
5. " \* ": Fundamental frequency.

CHANNEL	TX Channel 64	DETECTOR FUNCTION	Peak (PK)
FREQUENCY RANGE	1GHz ~ 40GHz		Average (AV)

**ANTENNA POLARITY & TEST DISTANCE: HORIZONTAL AT 3 M**

NO.	FREQ. (MHz)	EMISSION LEVEL (dBuV/m)	LIMIT (dBuV/m)	MARGIN (dB)	ANTENNA HEIGHT (m)	TABLE ANGLE (Degree)	RAW VALUE (dBuV)	CORRECTION FACTOR (dB/m)
1	*5320.00	111.4 PK			1.35 H	331	71.70	39.70
2	*5320.00	101.6 AV			1.35 H	331	61.90	39.70
3	5350.00	67.2 PK	74.0	-6.8	1.30 H	333	61.50	5.70
4	5350.00	48.6 AV	54.0	-5.4	1.30 H	333	42.90	5.70
5	10640.00	60.8 PK	74.0	-13.2	1.00 H	53	42.40	18.40
6	10640.00	47.7 AV	54.0	-6.3	1.00 H	53	29.30	18.40

**ANTENNA POLARITY & TEST DISTANCE: VERTICAL AT 3 M**

NO.	FREQ. (MHz)	EMISSION LEVEL (dBuV/m)	LIMIT (dBuV/m)	MARGIN (dB)	ANTENNA HEIGHT (m)	TABLE ANGLE (Degree)	RAW VALUE (dBuV)	CORRECTION FACTOR (dB/m)
1	*5320.00	117.0 PK			1.62 V	8	77.30	39.70
2	*5320.00	106.9 AV			1.62 V	8	67.20	39.70
3	5350.00	71.8 PK	74.0	-2.2	1.74 V	6	66.10	5.70
4	5350.00	53.5 AV	54.0	-0.5	1.74 V	6	47.80	5.70
5	10640.00	61.3 PK	74.0	-12.7	1.07 V	19	42.90	18.40
6	10640.00	48.1 AV	54.0	-5.9	1.07 V	19	29.70	18.40

**REMARKS:**

1. Emission Level(dBuV/m) = Raw Value(dBuV) + Correction Factor(dB/m)
2. Correction Factor(dB/m) = Antenna Factor(dB/m) + Cable Factor(dB) – Pre-Amplifier Factor(dB)
3. The other emission levels were very low against the limit.
4. Margin value = Emission Level – Limit value
5. " \* ": Fundamental frequency.



CHANNEL	TX Channel 100	DETECTOR FUNCTION	Peak (PK)
FREQUENCY RANGE	1GHz ~ 40GHz		Average (AV)

**ANTENNA POLARITY & TEST DISTANCE: HORIZONTAL AT 3 M**

NO.	FREQ. (MHz)	EMISSION LEVEL (dBuV/m)	LIMIT (dBuV/m)	MARGIN (dB)	ANTENNA HEIGHT (m)	TABLE ANGLE (Degree)	RAW VALUE (dBuV)	CORRECTION FACTOR (dB/m)
1	5460.00	61.7 PK	74.0	-12.3	1.25 H	333	55.90	5.80
2	5460.00	45.7 AV	54.0	-8.3	1.25 H	333	39.90	5.80
3	#5470.00	63.6 PK	74.0	-10.4	1.25 H	333	57.70	5.90
4	#5470.00	48.4 AV	54.0	-5.6	1.25 H	333	42.50	5.90
5	*5500.00	111.5 PK			1.25 H	330	71.60	39.90
6	*5500.00	101.7 AV			1.25 H	330	61.80	39.90
7	11000.00	60.6 PK	74.0	-13.4	1.00 H	58	41.70	18.90
8	11000.00	48.5 AV	54.0	-5.5	1.00 H	58	29.60	18.90

**ANTENNA POLARITY & TEST DISTANCE: VERTICAL AT 3 M**

NO.	FREQ. (MHz)	EMISSION LEVEL (dBuV/m)	LIMIT (dBuV/m)	MARGIN (dB)	ANTENNA HEIGHT (m)	TABLE ANGLE (Degree)	RAW VALUE (dBuV)	CORRECTION FACTOR (dB/m)
1	5460.00	66.4 PK	74.0	-7.6	1.69 V	8	60.60	5.80
2	5460.00	50.1 AV	54.0	-3.9	1.69 V	8	44.30	5.80
3	#5470.00	71.1 PK	74.0	-2.9	1.69 V	8	65.20	5.90
4	#5470.00	53.6 AV	54.0	-0.4	1.69 V	8	47.70	5.90
5	*5500.00	118.0 PK			1.61 V	9	78.10	39.90
6	*5500.00	107.9 AV			1.61 V	9	68.00	39.90
7	11000.00	61.1 PK	74.0	-12.9	1.04 V	14	42.20	18.90
8	11000.00	48.9 AV	54.0	-5.1	1.04 V	14	30.00	18.90

**REMARKS:**

1. Emission Level(dBuV/m) = Raw Value(dBuV) + Correction Factor(dB/m)
2. Correction Factor(dB/m) = Antenna Factor(dB/m) + Cable Factor(dB) – Pre-Amplifier Factor(dB)
3. The other emission levels were very low against the limit.
4. Margin value = Emission Level – Limit value
5. " \* ": Fundamental frequency.
6. " # ": The radiated frequency is out of the restricted band.

CHANNEL	TX Channel 116	DETECTOR FUNCTION	Peak (PK)
FREQUENCY RANGE	1GHz ~ 40GHz		Average (AV)

**ANTENNA POLARITY & TEST DISTANCE: HORIZONTAL AT 3 M**

NO.	FREQ. (MHz)	EMISSION LEVEL (dBuV/m)	LIMIT (dBuV/m)	MARGIN (dB)	ANTENNA HEIGHT (m)	TABLE ANGLE (Degree)	RAW VALUE (dBuV)	CORRECTION FACTOR (dB/m)
1	*5580.00	110.6 PK			1.22 H	330	70.70	39.90
2	*5580.00	100.9 AV			1.22 H	330	61.00	39.90
3	11160.00	60.7 PK	74.0	-13.3	1.00 H	55	41.50	19.20
4	11160.00	49.1 AV	54.0	-4.9	1.00 H	55	29.90	19.20

**ANTENNA POLARITY & TEST DISTANCE: VERTICAL AT 3 M**

NO.	FREQ. (MHz)	EMISSION LEVEL (dBuV/m)	LIMIT (dBuV/m)	MARGIN (dB)	ANTENNA HEIGHT (m)	TABLE ANGLE (Degree)	RAW VALUE (dBuV)	CORRECTION FACTOR (dB/m)
1	*5580.00	117.9 PK			1.58 V	7	78.00	39.90
2	*5580.00	108.2 AV			1.58 V	7	68.30	39.90
3	11160.00	61.8 PK	74.0	-12.2	1.03 V	13	42.60	19.20
4	11160.00	49.5 AV	54.0	-4.5	1.03 V	13	30.30	19.20

**REMARKS:**

1. Emission Level(dBuV/m) = Raw Value(dBuV) + Correction Factor(dB/m)
2. Correction Factor(dB/m) = Antenna Factor(dB/m) + Cable Factor(dB) – Pre-Amplifier Factor(dB)
3. The other emission levels were very low against the limit.
4. Margin value = Emission Level – Limit value
5. " \* ": Fundamental frequency.

CHANNEL	TX Channel 140	DETECTOR FUNCTION	Peak (PK)
FREQUENCY RANGE	1GHz ~ 40GHz		Average (AV)

**ANTENNA POLARITY & TEST DISTANCE: HORIZONTAL AT 3 M**

NO.	FREQ. (MHz)	EMISSION LEVEL (dBuV/m)	LIMIT (dBuV/m)	MARGIN (dB)	ANTENNA HEIGHT (m)	TABLE ANGLE (Degree)	RAW VALUE (dBuV)	CORRECTION FACTOR (dB/m)
1	*5700.00	107.7 PK			1.25 H	331	67.40	40.30
2	*5700.00	98.0 AV			1.25 H	331	57.70	40.30
3	#5725.00	63.4 PK	74.0	-10.6	1.21 H	336	57.10	6.30
4	#5725.00	47.6 AV	54.0	-6.4	1.21 H	336	41.30	6.30
5	11400.00	60.4 PK	74.0	-13.6	1.00 H	57	40.70	19.70
6	11400.00	47.8 AV	54.0	-6.2	1.00 H	57	28.10	19.70

**ANTENNA POLARITY & TEST DISTANCE: VERTICAL AT 3 M**

NO.	FREQ. (MHz)	EMISSION LEVEL (dBuV/m)	LIMIT (dBuV/m)	MARGIN (dB)	ANTENNA HEIGHT (m)	TABLE ANGLE (Degree)	RAW VALUE (dBuV)	CORRECTION FACTOR (dB/m)
1	*5700.00	115.6 PK			1.55 V	8	75.30	40.30
2	*5700.00	105.8 AV			1.55 V	8	65.50	40.30
3	#5725.00	72.7 PK	74.0	-1.3	1.55 V	8	66.40	6.30
<b>4</b>	<b>#5725.00</b>	<b>53.9 AV</b>	<b>54.0</b>	<b>-0.1</b>	<b>1.55 V</b>	<b>8</b>	<b>47.60</b>	<b>6.30</b>
5	11400.00	60.9 PK	74.0	-13.1	1.05 V	19	41.20	19.70
6	11400.00	48.3 AV	54.0	-5.7	1.05 V	19	28.60	19.70

**REMARKS:**

1. Emission Level(dBuV/m) = Raw Value(dBuV) + Correction Factor(dB/m)
2. Correction Factor(dB/m) = Antenna Factor(dB/m) + Cable Factor(dB) – Pre-Amplifier Factor(dB)
3. The other emission levels were very low against the limit.
4. Margin value = Emission Level – Limit value
5. " \* ": Fundamental frequency.
6. " # ": The radiated frequency is out of the restricted band.

**802.11n (HT20)**

CHANNEL	TX Channel 52	DETECTOR FUNCTION	Peak (PK)
FREQUENCY RANGE	1GHz ~ 40GHz		Average (AV)

ANTENNA POLARITY & TEST DISTANCE: HORIZONTAL AT 3 M								
NO.	FREQ. (MHz)	EMISSION LEVEL (dBuV/m)	LIMIT (dBuV/m)	MARGIN (dB)	ANTENNA HEIGHT (m)	TABLE ANGLE (Degree)	RAW VALUE (dBuV)	CORRECTION FACTOR (dB/m)
1	5150.00	59.1 PK	74.0	-14.9	1.28 H	338	53.60	5.50
2	5150.00	45.7 AV	54.0	-8.3	1.28 H	338	40.20	5.50
3	*5260.00	108.8 PK			1.22 H	332	69.20	39.60
4	*5260.00	98.0 AV			1.22 H	332	58.40	39.60
5	#10520.00	60.6 PK	74.0	-13.4	1.00 H	56	42.50	18.10
6	#10520.00	47.8 AV	54.0	-6.2	1.00 H	56	29.70	18.10

ANTENNA POLARITY & TEST DISTANCE: VERTICAL AT 3 M								
NO.	FREQ. (MHz)	EMISSION LEVEL (dBuV/m)	LIMIT (dBuV/m)	MARGIN (dB)	ANTENNA HEIGHT (m)	TABLE ANGLE (Degree)	RAW VALUE (dBuV)	CORRECTION FACTOR (dB/m)
1	5150.00	59.4 PK	74.0	-14.6	1.34 V	6	53.90	5.50
2	5150.00	46.1 AV	54.0	-7.9	1.34 V	6	40.60	5.50
3	*5260.00	113.5 PK			1.39 V	1	73.90	39.60
4	*5260.00	102.6 AV			1.39 V	1	63.00	39.60
5	#10520.00	61.4 PK	74.0	-12.6	1.00 V	12	43.30	18.10
6	#10520.00	48.3 AV	54.0	-5.7	1.00 V	12	30.20	18.10

**REMARKS:**

1. Emission Level(dBuV/m) = Raw Value(dBuV) + Correction Factor(dB/m)
2. Correction Factor(dB/m) = Antenna Factor(dB/m) + Cable Factor(dB) – Pre-Amplifier Factor(dB)
3. The other emission levels were very low against the limit.
4. Margin value = Emission Level – Limit value
5. " \* ": Fundamental frequency.
6. " # ": The radiated frequency is out of the restricted band.

CHANNEL	TX Channel 60	DETECTOR FUNCTION	Peak (PK)
FREQUENCY RANGE	1GHz ~ 40GHz		Average (AV)

**ANTENNA POLARITY & TEST DISTANCE: HORIZONTAL AT 3 M**

NO.	FREQ. (MHz)	EMISSION LEVEL (dBuV/m)	LIMIT (dBuV/m)	MARGIN (dB)	ANTENNA HEIGHT (m)	TABLE ANGLE (Degree)	RAW VALUE (dBuV)	CORRECTION FACTOR (dB/m)
1	*5300.00	109.2 PK			1.28 H	328	69.60	39.60
2	*5300.00	97.9 AV			1.28 H	328	58.30	39.60
3	10600.00	60.8 PK	74.0	-13.2	1.00 H	54	42.40	18.40
4	10600.00	48.1 AV	54.0	-5.9	1.00 H	54	29.70	18.40

**ANTENNA POLARITY & TEST DISTANCE: VERTICAL AT 3 M**

NO.	FREQ. (MHz)	EMISSION LEVEL (dBuV/m)	LIMIT (dBuV/m)	MARGIN (dB)	ANTENNA HEIGHT (m)	TABLE ANGLE (Degree)	RAW VALUE (dBuV)	CORRECTION FACTOR (dB/m)
1	*5300.00	113.4 PK			1.21 V	3	73.80	39.60
2	*5300.00	102.7 AV			1.21 V	3	63.10	39.60
3	10600.00	61.7 PK	74.0	-12.3	1.04 V	10	43.30	18.40
4	10600.00	48.4 AV	54.0	-5.6	1.04 V	10	30.00	18.40

**REMARKS:**

1. Emission Level(dBuV/m) = Raw Value(dBuV) + Correction Factor(dB/m)
2. Correction Factor(dB/m) = Antenna Factor(dB/m) + Cable Factor(dB) – Pre-Amplifier Factor(dB)
3. The other emission levels were very low against the limit.
4. Margin value = Emission Level – Limit value
5. " \* ": Fundamental frequency.

CHANNEL	TX Channel 64	DETECTOR FUNCTION	Peak (PK)
FREQUENCY RANGE	1GHz ~ 40GHz		Average (AV)

**ANTENNA POLARITY & TEST DISTANCE: HORIZONTAL AT 3 M**

NO.	FREQ. (MHz)	EMISSION LEVEL (dBuV/m)	LIMIT (dBuV/m)	MARGIN (dB)	ANTENNA HEIGHT (m)	TABLE ANGLE (Degree)	RAW VALUE (dBuV)	CORRECTION FACTOR (dB/m)
1	*5320.00	109.5 PK			1.14 H	330	69.80	39.70
2	*5320.00	98.6 AV			1.14 H	330	58.90	39.70
3	5350.00	57.6 PK	74.0	-16.4	1.14 H	333	51.90	5.70
4	5350.00	45.2 AV	54.0	-8.8	1.14 H	333	39.50	5.70
5	10640.00	60.4 PK	74.0	-13.6	1.00 H	51	42.00	18.40
6	10640.00	47.7 AV	54.0	-6.3	1.00 H	51	29.30	18.40

**ANTENNA POLARITY & TEST DISTANCE: VERTICAL AT 3 M**

NO.	FREQ. (MHz)	EMISSION LEVEL (dBuV/m)	LIMIT (dBuV/m)	MARGIN (dB)	ANTENNA HEIGHT (m)	TABLE ANGLE (Degree)	RAW VALUE (dBuV)	CORRECTION FACTOR (dB/m)
1	*5320.00	115.5 PK			1.74 V	5	75.80	39.70
2	*5320.00	105.0 AV			1.74 V	5	65.30	39.70
3	5350.00	68.5 PK	74.0	-5.5	1.79 V	5	62.80	5.70
4	5350.00	49.7 AV	54.0	-4.3	1.79 V	5	44.00	5.70
5	10640.00	61.3 PK	74.0	-12.7	1.04 V	14	42.90	18.40
6	10640.00	48.3 AV	54.0	-5.7	1.04 V	14	29.90	18.40

**REMARKS:**

1. Emission Level(dBuV/m) = Raw Value(dBuV) + Correction Factor(dB/m)
2. Correction Factor(dB/m) = Antenna Factor(dB/m) + Cable Factor(dB) – Pre-Amplifier Factor(dB)
3. The other emission levels were very low against the limit.
4. Margin value = Emission Level – Limit value
5. " \* ": Fundamental frequency.

CHANNEL	TX Channel 100	DETECTOR FUNCTION	Peak (PK)
FREQUENCY RANGE	1GHz ~ 40GHz		Average (AV)

**ANTENNA POLARITY & TEST DISTANCE: HORIZONTAL AT 3 M**

NO.	FREQ. (MHz)	EMISSION LEVEL (dBuV/m)	LIMIT (dBuV/m)	MARGIN (dB)	ANTENNA HEIGHT (m)	TABLE ANGLE (Degree)	RAW VALUE (dBuV)	CORRECTION FACTOR (dB/m)
1	5460.00	57.8 PK	74.0	-16.2	1.04 H	332	52.00	5.80
2	5460.00	45.2 AV	54.0	-8.8	1.04 H	332	39.40	5.80
3	#5470.00	58.1 PK	74.0	-15.9	1.04 H	332	52.20	5.90
4	#5470.00	45.9 AV	54.0	-8.1	1.04 H	332	40.00	5.90
5	*5500.00	108.6 PK			1.04 H	332	68.70	39.90
6	*5500.00	97.7 AV			1.04 H	332	57.80	39.90
7	11000.00	60.3 PK	74.0	-13.7	1.00 H	56	41.40	18.90
8	11000.00	48.4 AV	54.0	-5.6	1.00 H	56	29.50	18.90

**ANTENNA POLARITY & TEST DISTANCE: VERTICAL AT 3 M**

NO.	FREQ. (MHz)	EMISSION LEVEL (dBuV/m)	LIMIT (dBuV/m)	MARGIN (dB)	ANTENNA HEIGHT (m)	TABLE ANGLE (Degree)	RAW VALUE (dBuV)	CORRECTION FACTOR (dB/m)
1	5460.00	62.3 PK	74.0	-11.7	1.56 V	1	56.50	5.80
2	5460.00	49.6 AV	54.0	-4.4	1.56 V	1	43.80	5.80
3	#5470.00	64.4 PK	74.0	-9.6	1.56 V	1	58.50	5.90
4	#5470.00	51.1 AV	54.0	-2.9	1.56 V	1	45.20	5.90
5	*5500.00	115.7 PK			1.52 V	9	75.80	39.90
6	*5500.00	106.0 AV			1.52 V	9	66.10	39.90
7	11000.00	60.5 PK	74.0	-13.5	1.05 V	17	41.60	18.90
8	11000.00	48.7 AV	54.0	-5.3	1.05 V	17	29.80	18.90

**REMARKS:**

1. Emission Level(dBuV/m) = Raw Value(dBuV) + Correction Factor(dB/m)
2. Correction Factor(dB/m) = Antenna Factor(dB/m) + Cable Factor(dB) – Pre-Amplifier Factor(dB)
3. The other emission levels were very low against the limit.
4. Margin value = Emission Level – Limit value
5. " \* ": Fundamental frequency.
6. " # ": The radiated frequency is out of the restricted band.

CHANNEL	TX Channel 116	DETECTOR FUNCTION	Peak (PK)
FREQUENCY RANGE	1GHz ~ 40GHz		Average (AV)

**ANTENNA POLARITY & TEST DISTANCE: HORIZONTAL AT 3 M**

NO.	FREQ. (MHz)	EMISSION LEVEL (dBuV/m)	LIMIT (dBuV/m)	MARGIN (dB)	ANTENNA HEIGHT (m)	TABLE ANGLE (Degree)	RAW VALUE (dBuV)	CORRECTION FACTOR (dB/m)
1	*5580.00	107.1 PK			1.03 H	333	67.20	39.90
2	*5580.00	96.7 AV			1.03 H	333	56.80	39.90
3	11160.00	60.3 PK	74.0	-13.7	1.00 H	51	41.10	19.20
4	11160.00	48.5 AV	54.0	-5.5	1.00 H	51	29.30	19.20

**ANTENNA POLARITY & TEST DISTANCE: VERTICAL AT 3 M**

NO.	FREQ. (MHz)	EMISSION LEVEL (dBuV/m)	LIMIT (dBuV/m)	MARGIN (dB)	ANTENNA HEIGHT (m)	TABLE ANGLE (Degree)	RAW VALUE (dBuV)	CORRECTION FACTOR (dB/m)
1	*5580.00	115.3 PK			1.50 V	7	75.40	39.90
2	*5580.00	105.5 AV			1.50 V	7	65.60	39.90
3	11160.00	61.7 PK	74.0	-12.3	1.01 V	15	42.50	19.20
4	11160.00	49.1 AV	54.0	-4.9	1.01 V	15	29.90	19.20

**REMARKS:**

1. Emission Level(dBuV/m) = Raw Value(dBuV) + Correction Factor(dB/m)
2. Correction Factor(dB/m) = Antenna Factor(dB/m) + Cable Factor(dB) – Pre-Amplifier Factor(dB)
3. The other emission levels were very low against the limit.
4. Margin value = Emission Level – Limit value
5. " \* ": Fundamental frequency.



CHANNEL	TX Channel 140	DETECTOR FUNCTION	Peak (PK)
FREQUENCY RANGE	1GHz ~ 40GHz		Average (AV)

**ANTENNA POLARITY & TEST DISTANCE: HORIZONTAL AT 3 M**

NO.	FREQ. (MHz)	EMISSION LEVEL (dBuV/m)	LIMIT (dBuV/m)	MARGIN (dB)	ANTENNA HEIGHT (m)	TABLE ANGLE (Degree)	RAW VALUE (dBuV)	CORRECTION FACTOR (dB/m)
1	*5700.00	106.2 PK			1.00 H	330	65.90	40.30
2	*5700.00	95.6 AV			1.00 H	330	55.30	40.30
3	#5725.00	61.1 PK	74.0	-12.9	1.00 H	325	54.80	6.30
4	#5725.00	46.4 AV	54.0	-7.6	1.00 H	325	40.10	6.30
5	11400.00	60.1 PK	74.0	-13.9	1.00 H	54	40.40	19.70
6	11400.00	47.8 AV	54.0	-6.2	1.00 H	54	28.10	19.70

**ANTENNA POLARITY & TEST DISTANCE: VERTICAL AT 3 M**

NO.	FREQ. (MHz)	EMISSION LEVEL (dBuV/m)	LIMIT (dBuV/m)	MARGIN (dB)	ANTENNA HEIGHT (m)	TABLE ANGLE (Degree)	RAW VALUE (dBuV)	CORRECTION FACTOR (dB/m)
1	*5700.00	113.8 PK			1.54 V	7	73.50	40.30
2	*5700.00	103.9 AV			1.54 V	7	63.60	40.30
3	#5725.00	70.9 PK	74.0	-3.1	1.67 V	5	64.60	6.30
4	#5725.00	52.7 AV	54.0	-1.3	1.67 V	5	46.40	6.30
5	11400.00	60.3 PK	74.0	-13.7	1.03 V	15	40.60	19.70
6	11400.00	48.2 AV	54.0	-5.8	1.03 V	15	28.50	19.70

**REMARKS:**

1. Emission Level(dBuV/m) = Raw Value(dBuV) + Correction Factor(dB/m)
2. Correction Factor(dB/m) = Antenna Factor(dB/m) + Cable Factor(dB) – Pre-Amplifier Factor(dB)
3. The other emission levels were very low against the limit.
4. Margin value = Emission Level – Limit value
5. " \* ": Fundamental frequency.
6. " # ": The radiated frequency is out of the restricted band.

**802.11n (HT40)**

CHANNEL	TX Channel 54	DETECTOR FUNCTION	Peak (PK)
FREQUENCY RANGE	1GHz ~ 40GHz		Average (AV)

ANTENNA POLARITY & TEST DISTANCE: HORIZONTAL AT 3 M								
NO.	FREQ. (MHz)	EMISSION LEVEL (dBuV/m)	LIMIT (dBuV/m)	MARGIN (dB)	ANTENNA HEIGHT (m)	TABLE ANGLE (Degree)	RAW VALUE (dBuV)	CORRECTION FACTOR (dB/m)
1	5150.00	60.9 PK	74.0	-13.1	1.48 H	330	55.40	5.50
2	5150.00	46.5 AV	54.0	-7.5	1.48 H	330	41.00	5.50
3	*5270.00	106.2 PK			1.43 H	333	66.60	39.60
4	*5270.00	95.9 AV			1.43 H	333	56.30	39.60
5	#10540.00	60.2 PK	74.0	-13.8	1.00 H	58	42.10	18.10
6	#10540.00	47.4 AV	54.0	-6.6	1.00 H	58	29.30	18.10

ANTENNA POLARITY & TEST DISTANCE: VERTICAL AT 3 M								
NO.	FREQ. (MHz)	EMISSION LEVEL (dBuV/m)	LIMIT (dBuV/m)	MARGIN (dB)	ANTENNA HEIGHT (m)	TABLE ANGLE (Degree)	RAW VALUE (dBuV)	CORRECTION FACTOR (dB/m)
1	5150.00	61.2 PK	74.0	-12.8	1.56 V	6	55.70	5.50
2	5150.00	47.0 AV	54.0	-7.0	1.56 V	6	41.50	5.50
3	*5270.00	111.6 PK			1.54 V	8	72.00	39.60
4	*5270.00	102.0 AV			1.54 V	8	62.40	39.60
5	#10540.00	61.2 PK	74.0	-12.8	1.02 V	10	43.10	18.10
6	#10540.00	48.2 AV	54.0	-5.8	1.02 V	10	30.10	18.10

**REMARKS:**

1. Emission Level(dBuV/m) = Raw Value(dBuV) + Correction Factor(dB/m)
2. Correction Factor(dB/m) = Antenna Factor(dB/m) + Cable Factor(dB) – Pre-Amplifier Factor(dB)
3. The other emission levels were very low against the limit.
4. Margin value = Emission Level – Limit value
5. " \* ": Fundamental frequency.
6. " # ": The radiated frequency is out of the restricted band.

CHANNEL	TX Channel 62	DETECTOR FUNCTION	Peak (PK)
FREQUENCY RANGE	1GHz ~ 40GHz		Average (AV)

**ANTENNA POLARITY & TEST DISTANCE: HORIZONTAL AT 3 M**

NO.	FREQ. (MHz)	EMISSION LEVEL (dBuV/m)	LIMIT (dBuV/m)	MARGIN (dB)	ANTENNA HEIGHT (m)	TABLE ANGLE (Degree)	RAW VALUE (dBuV)	CORRECTION FACTOR (dB/m)
1	*5310.00	103.5 PK			1.36 H	331	63.90	39.60
2	*5310.00	93.4 AV			1.36 H	331	53.80	39.60
3	5350.00	61.3 PK	74.0	-12.7	1.34 H	339	55.60	5.70
4	5350.00	46.7 AV	54.0	-7.3	1.34 H	339	41.00	5.70
5	10620.00	59.8 PK	74.0	-14.2	1.00 H	53	41.50	18.30
6	10620.00	47.2 AV	54.0	-6.8	1.00 H	53	28.90	18.30

**ANTENNA POLARITY & TEST DISTANCE: VERTICAL AT 3 M**

NO.	FREQ. (MHz)	EMISSION LEVEL (dBuV/m)	LIMIT (dBuV/m)	MARGIN (dB)	ANTENNA HEIGHT (m)	TABLE ANGLE (Degree)	RAW VALUE (dBuV)	CORRECTION FACTOR (dB/m)
1	*5310.00	110.0 PK			1.75 V	5	70.40	39.60
2	*5310.00	100.6 AV			1.75 V	5	61.00	39.60
3	5350.00	68.2 PK	74.0	-5.8	1.73 V	2	62.50	5.70
4	5350.00	53.7 AV	54.0	-0.3	1.73 V	2	48.00	5.70
5	10620.00	61.0 PK	74.0	-13.0	1.00 V	16	42.70	18.30
6	10620.00	48.1 AV	54.0	-5.9	1.00 V	16	29.80	18.30

**REMARKS:**

1. Emission Level(dBuV/m) = Raw Value(dBuV) + Correction Factor(dB/m)
2. Correction Factor(dB/m) = Antenna Factor(dB/m) + Cable Factor(dB) – Pre-Amplifier Factor(dB)
3. The other emission levels were very low against the limit.
4. Margin value = Emission Level – Limit value
5. " \* ": Fundamental frequency.

CHANNEL	TX Channel 102	DETECTOR FUNCTION	Peak (PK)
FREQUENCY RANGE	1GHz ~ 40GHz		Average (AV)

**ANTENNA POLARITY & TEST DISTANCE: HORIZONTAL AT 3 M**

NO.	FREQ. (MHz)	EMISSION LEVEL (dBuV/m)	LIMIT (dBuV/m)	MARGIN (dB)	ANTENNA HEIGHT (m)	TABLE ANGLE (Degree)	RAW VALUE (dBuV)	CORRECTION FACTOR (dB/m)
1	5460.00	57.7 PK	74.0	-16.3	1.09 H	338	51.90	5.80
2	5460.00	45.0 AV	54.0	-9.0	1.09 H	338	39.20	5.80
3	#5470.00	60.6 PK	74.0	-13.4	1.09 H	338	54.70	5.90
4	#5470.00	47.3 AV	54.0	-6.7	1.09 H	338	41.40	5.90
5	*5510.00	104.3 PK			1.05 H	332	64.40	39.90
6	*5510.00	93.5 AV			1.05 H	332	53.60	39.90
7	11020.00	58.8 PK	74.0	-15.2	1.00 H	51	39.80	19.00
8	11020.00	47.1 AV	54.0	-6.9	1.00 H	51	28.10	19.00

**ANTENNA POLARITY & TEST DISTANCE: VERTICAL AT 3 M**

NO.	FREQ. (MHz)	EMISSION LEVEL (dBuV/m)	LIMIT (dBuV/m)	MARGIN (dB)	ANTENNA HEIGHT (m)	TABLE ANGLE (Degree)	RAW VALUE (dBuV)	CORRECTION FACTOR (dB/m)
1	5460.00	69.0 PK	74.0	-5.0	1.59 V	8	63.20	5.80
2	5460.00	49.0 AV	54.0	-5.0	1.59 V	8	43.20	5.80
3	#5470.00	70.9 PK	74.0	-3.1	1.59 V	8	65.00	5.90
4	#5470.00	53.6 AV	54.0	-0.4	1.59 V	8	47.70	5.90
5	*5510.00	112.3 PK			1.60 V	4	72.40	39.90
6	*5510.00	102.0 AV			1.60 V	4	62.10	39.90
7	11020.00	59.7 PK	74.0	-14.3	1.01 V	19	40.70	19.00
8	11020.00	47.3 AV	54.0	-6.7	1.01 V	19	28.30	19.00

**REMARKS:**

1. Emission Level(dBuV/m) = Raw Value(dBuV) + Correction Factor(dB/m)
2. Correction Factor(dB/m) = Antenna Factor(dB/m) + Cable Factor(dB) – Pre-Amplifier Factor(dB)
3. The other emission levels were very low against the limit.
4. Margin value = Emission Level – Limit value
5. " \* ": Fundamental frequency.
6. " # ": The radiated frequency is out of the restricted band.

CHANNEL	TX Channel 110	DETECTOR FUNCTION	Peak (PK)
FREQUENCY RANGE	1GHz ~ 40GHz		Average (AV)

**ANTENNA POLARITY & TEST DISTANCE: HORIZONTAL AT 3 M**

NO.	FREQ. (MHz)	EMISSION LEVEL (dBuV/m)	LIMIT (dBuV/m)	MARGIN (dB)	ANTENNA HEIGHT (m)	TABLE ANGLE (Degree)	RAW VALUE (dBuV)	CORRECTION FACTOR (dB/m)
1	*5550.00	104.1 PK			1.03 H	332	64.10	40.00
2	*5550.00	93.3 AV			1.03 H	332	53.30	40.00
3	11100.00	60.2 PK	74.0	-13.8	1.00 H	53	40.60	19.60
4	11100.00	47.6 AV	54.0	-6.4	1.00 H	53	28.00	19.60

**ANTENNA POLARITY & TEST DISTANCE: VERTICAL AT 3 M**

NO.	FREQ. (MHz)	EMISSION LEVEL (dBuV/m)	LIMIT (dBuV/m)	MARGIN (dB)	ANTENNA HEIGHT (m)	TABLE ANGLE (Degree)	RAW VALUE (dBuV)	CORRECTION FACTOR (dB/m)
1	*5550.00	112.2 PK			1.50 V	7	72.20	40.00
2	*5550.00	102.4 AV			1.50 V	7	62.40	40.00
3	11100.00	61.4 PK	74.0	-12.6	1.01 V	13	41.80	19.60
4	11100.00	48.8 AV	54.0	-5.2	1.01 V	13	29.20	19.60

**REMARKS:**

1. Emission Level(dBuV/m) = Raw Value(dBuV) + Correction Factor(dB/m)
2. Correction Factor(dB/m) = Antenna Factor(dB/m) + Cable Factor(dB) – Pre-Amplifier Factor(dB)
3. The other emission levels were very low against the limit.
4. Margin value = Emission Level – Limit value
5. " \* ": Fundamental frequency.

CHANNEL	TX Channel 134	DETECTOR FUNCTION	Peak (PK)
FREQUENCY RANGE	1GHz ~ 40GHz		Average (AV)

**ANTENNA POLARITY & TEST DISTANCE: HORIZONTAL AT 3 M**

NO.	FREQ. (MHz)	EMISSION LEVEL (dBuV/m)	LIMIT (dBuV/m)	MARGIN (dB)	ANTENNA HEIGHT (m)	TABLE ANGLE (Degree)	RAW VALUE (dBuV)	CORRECTION FACTOR (dB/m)
1	*5670.00	102.3 PK			1.00 H	329	62.10	40.20
2	*5670.00	92.0 AV			1.00 H	329	51.80	40.20
3	#5725.00	57.9 PK	74.0	-16.1	1.00 H	322	51.60	6.30
4	#5725.00	45.7 AV	54.0	-8.3	1.00 H	322	39.40	6.30
5	11340.00	59.5 PK	74.0	-14.5	1.00 H	57	39.80	19.70
6	11340.00	47.2 AV	54.0	-6.8	1.00 H	57	27.50	19.70

**ANTENNA POLARITY & TEST DISTANCE: VERTICAL AT 3 M**

NO.	FREQ. (MHz)	EMISSION LEVEL (dBuV/m)	LIMIT (dBuV/m)	MARGIN (dB)	ANTENNA HEIGHT (m)	TABLE ANGLE (Degree)	RAW VALUE (dBuV)	CORRECTION FACTOR (dB/m)
1	*5670.00	110.7 PK			1.68 V	7	70.50	40.20
2	*5670.00	100.9 AV			1.68 V	7	60.70	40.20
3	#5725.00	65.3 PK	74.0	-8.7	1.66 V	5	59.00	6.30
4	#5725.00	50.2 AV	54.0	-3.8	1.66 V	5	43.90	6.30
5	11340.00	60.2 PK	74.0	-13.8	1.04 V	18	40.50	19.70
6	11340.00	47.9 AV	54.0	-6.1	1.04 V	18	28.20	19.70

**REMARKS:**

1. Emission Level(dBuV/m) = Raw Value(dBuV) + Correction Factor(dB/m)
2. Correction Factor(dB/m) = Antenna Factor(dB/m) + Cable Factor(dB) – Pre-Amplifier Factor(dB)
3. The other emission levels were very low against the limit.
4. Margin value = Emission Level – Limit value
5. " \* ": Fundamental frequency.
6. " # ": The radiated frequency is out of the restricted band.

802.11ac (VHT80)

CHANNEL	TX Channel 58	DETECTOR FUNCTION	Peak (PK)
FREQUENCY RANGE	1GHz ~ 40GHz		Average (AV)

ANTENNA POLARITY & TEST DISTANCE: HORIZONTAL AT 3 M								
NO.	FREQ. (MHz)	EMISSION LEVEL (dBuV/m)	LIMIT (dBuV/m)	MARGIN (dB)	ANTENNA HEIGHT (m)	TABLE ANGLE (Degree)	RAW VALUE (dBuV)	CORRECTION FACTOR (dB/m)
1	*5290.00	95.9 PK			1.41 H	333	56.30	39.60
2	*5290.00	85.6 AV			1.41 H	333	46.00	39.60
3	5350.00	69.0 PK	74.0	-5.0	1.41 H	330	63.30	5.70
4	5350.00	45.5 AV	54.0	-8.5	1.41 H	330	39.80	5.70
5	#10580.00	59.4 PK	74.0	-14.6	1.00 H	51	41.10	18.30
6	#10580.00	47.1 AV	54.0	-6.9	1.00 H	51	28.80	18.30

ANTENNA POLARITY & TEST DISTANCE: VERTICAL AT 3 M								
NO.	FREQ. (MHz)	EMISSION LEVEL (dBuV/m)	LIMIT (dBuV/m)	MARGIN (dB)	ANTENNA HEIGHT (m)	TABLE ANGLE (Degree)	RAW VALUE (dBuV)	CORRECTION FACTOR (dB/m)
1	*5290.00	102.5 PK			1.73 V	3	62.90	39.60
2	*5290.00	92.6 AV			1.73 V	3	53.00	39.60
3	5350.00	73.7 PK	74.0	-0.3	1.74 V	5	68.00	5.70
4	5350.00	48.9 AV	54.0	-5.1	1.74 V	5	43.20	5.70
5	#10580.00	60.7 PK	74.0	-13.3	1.01 V	17	42.40	18.30
6	#10580.00	47.8 AV	54.0	-6.2	1.01 V	17	29.50	18.30

REMARKS:

1. Emission Level(dBuV/m) = Raw Value(dBuV) + Correction Factor(dB/m)
2. Correction Factor(dB/m) = Antenna Factor(dB/m) + Cable Factor(dB) – Pre-Amplifier Factor(dB)
3. The other emission levels were very low against the limit.
4. Margin value = Emission Level – Limit value
5. " \* ": Fundamental frequency.
6. " # ": The radiated frequency is out of the restricted band.

CHANNEL	TX Channel 106	DETECTOR FUNCTION	Peak (PK)
FREQUENCY RANGE	1GHz ~ 40GHz		Average (AV)

**ANTENNA POLARITY & TEST DISTANCE: HORIZONTAL AT 3 M**

NO.	FREQ. (MHz)	EMISSION LEVEL (dBuV/m)	LIMIT (dBuV/m)	MARGIN (dB)	ANTENNA HEIGHT (m)	TABLE ANGLE (Degree)	RAW VALUE (dBuV)	CORRECTION FACTOR (dB/m)
1	5460.00	66.4 PK	74.0	-7.6	1.28 H	336	60.60	5.80
2	5460.00	44.8 AV	54.0	-9.2	1.28 H	336	39.00	5.80
3	#5470.00	67.3 PK	74.0	-6.7	1.28 H	336	61.40	5.90
4	#5470.00	45.2 AV	54.0	-8.8	1.28 H	336	39.30	5.90
5	*5530.00	97.1 PK			1.29 H	332	57.20	39.90
6	*5530.00	86.1 AV			1.29 H	332	46.20	39.90
7	11060.00	58.3 PK	74.0	-15.7	1.00 H	54	39.10	19.20
8	11060.00	46.8 AV	54.0	-7.2	1.00 H	54	27.60	19.20

**ANTENNA POLARITY & TEST DISTANCE: VERTICAL AT 3 M**

NO.	FREQ. (MHz)	EMISSION LEVEL (dBuV/m)	LIMIT (dBuV/m)	MARGIN (dB)	ANTENNA HEIGHT (m)	TABLE ANGLE (Degree)	RAW VALUE (dBuV)	CORRECTION FACTOR (dB/m)
1	5460.00	72.5 PK	74.0	-1.5	1.31 V	9	66.70	5.80
2	5460.00	48.0 AV	54.0	-6.0	1.31 V	9	42.20	5.80
3	#5470.00	73.8 PK	74.0	-0.2	1.31 V	9	67.90	5.90
4	#5470.00	48.6 AV	54.0	-5.4	1.31 V	9	42.70	5.90
5	*5530.00	104.6 PK			1.37 V	8	64.70	39.90
6	*5530.00	94.5 AV			1.37 V	8	54.60	39.90
7	11060.00	59.3 PK	74.0	-14.7	1.00 V	18	40.10	19.20
8	11060.00	47.1 AV	54.0	-6.9	1.00 V	18	27.90	19.20

**REMARKS:**

1. Emission Level(dBuV/m) = Raw Value(dBuV) + Correction Factor(dB/m)
2. Correction Factor(dB/m) = Antenna Factor(dB/m) + Cable Factor(dB) – Pre-Amplifier Factor(dB)
3. The other emission levels were very low against the limit.
4. Margin value = Emission Level – Limit value
5. " \* ": Fundamental frequency.
6. " # ": The radiated frequency is out of the restricted band.



Test Mode D

3TX

802.11a

CHANNEL	TX Channel 52	DETECTOR FUNCTION	Peak (PK)
FREQUENCY RANGE	1GHz ~ 40GHz		Average (AV)

ANTENNA POLARITY & TEST DISTANCE: HORIZONTAL AT 3 M

NO.	FREQ. (MHz)	EMISSION LEVEL (dBuV/m)	LIMIT (dBuV/m)	MARGIN (dB)	ANTENNA HEIGHT (m)	TABLE ANGLE (Degree)	RAW VALUE (dBuV)	CORRECTION FACTOR (dB/m)
1	5150.00	60.5 PK	74.0	-13.5	1.74 H	336	55.00	5.50
2	5150.00	47.0 AV	54.0	-7.0	1.74 H	336	41.50	5.50
3	*5260.00	113.1 PK			1.72 H	331	73.50	39.60
4	*5260.00	103.6 AV			1.72 H	331	64.00	39.60
5	#10520.00	60.8 PK	74.0	-13.2	1.00 H	52	42.70	18.10
6	#10520.00	47.9 AV	54.0	-6.1	1.00 H	52	29.80	18.10

ANTENNA POLARITY & TEST DISTANCE: VERTICAL AT 3 M

NO.	FREQ. (MHz)	EMISSION LEVEL (dBuV/m)	LIMIT (dBuV/m)	MARGIN (dB)	ANTENNA HEIGHT (m)	TABLE ANGLE (Degree)	RAW VALUE (dBuV)	CORRECTION FACTOR (dB/m)
1	5150.00	61.4 PK	74.0	-12.6	1.79 V	3	55.90	5.50
2	5150.00	47.4 AV	54.0	-6.6	1.79 V	3	41.90	5.50
3	*5260.00	119.4 PK			1.78 V	9	79.80	39.60
4	*5260.00	109.8 AV			1.78 V	9	70.20	39.60
5	#10520.00	61.3 PK	74.0	-12.7	1.09 V	19	43.20	18.10
6	#10520.00	48.2 AV	54.0	-5.8	1.09 V	19	30.10	18.10

REMARKS:

1. Emission Level(dBuV/m) = Raw Value(dBuV) + Correction Factor(dB/m)
2. Correction Factor(dB/m) = Antenna Factor(dB/m) + Cable Factor(dB) – Pre-Amplifier Factor(dB)
3. The other emission levels were very low against the limit.
4. Margin value = Emission Level – Limit value
5. " \* ": Fundamental frequency.
6. " # ": The radiated frequency is out of the restricted band.

CHANNEL	TX Channel 60	DETECTOR FUNCTION	Peak (PK)
FREQUENCY RANGE	1GHz ~ 40GHz		Average (AV)

**ANTENNA POLARITY & TEST DISTANCE: HORIZONTAL AT 3 M**

NO.	FREQ. (MHz)	EMISSION LEVEL (dBuV/m)	LIMIT (dBuV/m)	MARGIN (dB)	ANTENNA HEIGHT (m)	TABLE ANGLE (Degree)	RAW VALUE (dBuV)	CORRECTION FACTOR (dB/m)
1	*5300.00	113.1 PK			1.75 H	330	73.50	39.60
2	*5300.00	103.4 AV			1.75 H	330	63.80	39.60
3	10600.00	60.8 PK	74.0	-13.2	1.00 H	59	42.40	18.40
4	10600.00	48.1 AV	54.0	-5.9	1.00 H	59	29.70	18.40

**ANTENNA POLARITY & TEST DISTANCE: VERTICAL AT 3 M**

NO.	FREQ. (MHz)	EMISSION LEVEL (dBuV/m)	LIMIT (dBuV/m)	MARGIN (dB)	ANTENNA HEIGHT (m)	TABLE ANGLE (Degree)	RAW VALUE (dBuV)	CORRECTION FACTOR (dB/m)
1	*5300.00	119.2 PK			1.76 V	10	79.60	39.60
2	*5300.00	109.7 AV			1.76 V	10	70.10	39.60
3	10600.00	61.5 PK	74.0	-12.5	1.01 V	15	43.10	18.40
4	10600.00	48.6 AV	54.0	-5.4	1.01 V	15	30.20	18.40

**REMARKS:**

1. Emission Level(dBuV/m) = Raw Value(dBuV) + Correction Factor(dB/m)
2. Correction Factor(dB/m) = Antenna Factor(dB/m) + Cable Factor(dB) – Pre-Amplifier Factor(dB)
3. The other emission levels were very low against the limit.
4. Margin value = Emission Level – Limit value
5. " \* ": Fundamental frequency.

CHANNEL	TX Channel 64	DETECTOR FUNCTION	Peak (PK)
FREQUENCY RANGE	1GHz ~ 40GHz		Average (AV)

**ANTENNA POLARITY & TEST DISTANCE: HORIZONTAL AT 3 M**

NO.	FREQ. (MHz)	EMISSION LEVEL (dBuV/m)	LIMIT (dBuV/m)	MARGIN (dB)	ANTENNA HEIGHT (m)	TABLE ANGLE (Degree)	RAW VALUE (dBuV)	CORRECTION FACTOR (dB/m)
1	*5320.00	112.2 PK			1.78 H	333	72.50	39.70
2	*5320.00	102.7 AV			1.78 H	333	63.00	39.70
3	5350.00	59.4 PK	74.0	-14.6	1.76 H	337	53.70	5.70
4	5350.00	46.0 AV	54.0	-8.0	1.76 H	337	40.30	5.70
5	10640.00	60.7 PK	74.0	-13.3	1.00 H	51	42.30	18.40
6	10640.00	47.3 AV	54.0	-6.7	1.00 H	51	28.90	18.40

**ANTENNA POLARITY & TEST DISTANCE: VERTICAL AT 3 M**

NO.	FREQ. (MHz)	EMISSION LEVEL (dBuV/m)	LIMIT (dBuV/m)	MARGIN (dB)	ANTENNA HEIGHT (m)	TABLE ANGLE (Degree)	RAW VALUE (dBuV)	CORRECTION FACTOR (dB/m)
1	*5320.00	119.1 PK			1.76 V	1	79.40	39.70
2	*5320.00	109.5 AV			1.76 V	1	69.80	39.70
3	5350.00	68.8 PK	74.0	-5.2	1.52 V	16	63.10	5.70
4	5350.00	53.5 AV	54.0	-0.5	1.52 V	16	47.80	5.70
5	10640.00	61.0 PK	74.0	-13.0	1.00 V	4	42.60	18.40
6	10640.00	47.7 AV	54.0	-6.3	1.00 V	4	29.30	18.40

**REMARKS:**

1. Emission Level(dBuV/m) = Raw Value(dBuV) + Correction Factor(dB/m)
2. Correction Factor(dB/m) = Antenna Factor(dB/m) + Cable Factor(dB) – Pre-Amplifier Factor(dB)
3. The other emission levels were very low against the limit.
4. Margin value = Emission Level – Limit value
5. " \* ": Fundamental frequency.

CHANNEL	TX Channel 100	DETECTOR FUNCTION	Peak (PK)
FREQUENCY RANGE	1GHz ~ 40GHz		Average (AV)

**ANTENNA POLARITY & TEST DISTANCE: HORIZONTAL AT 3 M**

NO.	FREQ. (MHz)	EMISSION LEVEL (dBuV/m)	LIMIT (dBuV/m)	MARGIN (dB)	ANTENNA HEIGHT (m)	TABLE ANGLE (Degree)	RAW VALUE (dBuV)	CORRECTION FACTOR (dB/m)
1	5460.00	59.8 PK	74.0	-14.2	1.34 H	334	54.00	5.80
2	5460.00	45.2 AV	54.0	-8.8	1.34 H	334	39.40	5.80
3	#5470.00	61.8 PK	74.0	-12.2	1.34 H	334	55.90	5.90
4	#5470.00	46.9 AV	54.0	-7.1	1.34 H	334	41.00	5.90
5	*5500.00	112.2 PK			1.36 H	330	72.30	39.90
6	*5500.00	102.5 AV			1.36 H	330	62.60	39.90
7	11000.00	59.5 PK	74.0	-14.5	1.00 H	58	40.60	18.90
8	11000.00	48.1 AV	54.0	-5.9	1.00 H	58	29.20	18.90

**ANTENNA POLARITY & TEST DISTANCE: VERTICAL AT 3 M**

NO.	FREQ. (MHz)	EMISSION LEVEL (dBuV/m)	LIMIT (dBuV/m)	MARGIN (dB)	ANTENNA HEIGHT (m)	TABLE ANGLE (Degree)	RAW VALUE (dBuV)	CORRECTION FACTOR (dB/m)
1	5460.00	65.7 PK	74.0	-8.3	1.68 V	17	59.90	5.80
2	5460.00	50.0 AV	54.0	-4.0	1.68 V	17	44.20	5.80
3	#5470.00	70.7 PK	74.0	-3.3	1.70 V	15	64.80	5.90
4	#5470.00	53.4 AV	54.0	-0.6	1.70 V	15	47.50	5.90
5	*5500.00	120.3 PK			1.61 V	4	80.40	39.90
6	*5500.00	110.5 AV			1.61 V	4	70.60	39.90
7	11000.00	61.7 PK	74.0	-12.3	1.01 V	15	42.80	18.90
8	11000.00	49.1 AV	54.0	-4.9	1.01 V	15	30.20	18.90

**REMARKS:**

1. Emission Level(dBuV/m) = Raw Value(dBuV) + Correction Factor(dB/m)
2. Correction Factor(dB/m) = Antenna Factor(dB/m) + Cable Factor(dB) – Pre-Amplifier Factor(dB)
3. The other emission levels were very low against the limit.
4. Margin value = Emission Level – Limit value
5. " \* ": Fundamental frequency.
6. " # ": The radiated frequency is out of the restricted band.

CHANNEL	TX Channel 116	DETECTOR FUNCTION	Peak (PK)
FREQUENCY RANGE	1GHz ~ 40GHz		Average (AV)

**ANTENNA POLARITY & TEST DISTANCE: HORIZONTAL AT 3 M**

NO.	FREQ. (MHz)	EMISSION LEVEL (dBuV/m)	LIMIT (dBuV/m)	MARGIN (dB)	ANTENNA HEIGHT (m)	TABLE ANGLE (Degree)	RAW VALUE (dBuV)	CORRECTION FACTOR (dB/m)
1	*5580.00	111.1 PK			1.67 H	343	71.20	39.90
2	*5580.00	101.5 AV			1.67 H	343	61.60	39.90
3	11160.00	60.3 PK	74.0	-13.7	1.00 H	56	41.10	19.20
4	11160.00	48.7 AV	54.0	-5.3	1.00 H	56	29.50	19.20

**ANTENNA POLARITY & TEST DISTANCE: VERTICAL AT 3 M**

NO.	FREQ. (MHz)	EMISSION LEVEL (dBuV/m)	LIMIT (dBuV/m)	MARGIN (dB)	ANTENNA HEIGHT (m)	TABLE ANGLE (Degree)	RAW VALUE (dBuV)	CORRECTION FACTOR (dB/m)
1	*5580.00	119.9 PK			1.66 V	1	80.00	39.90
2	*5580.00	110.1 AV			1.66 V	1	70.20	39.90
3	11160.00	61.8 PK	74.0	-12.2	1.04 V	18	42.60	19.20
4	11160.00	49.3 AV	54.0	-4.7	1.04 V	18	30.10	19.20

**REMARKS:**

1. Emission Level(dBuV/m) = Raw Value(dBuV) + Correction Factor(dB/m)
2. Correction Factor(dB/m) = Antenna Factor(dB/m) + Cable Factor(dB) – Pre-Amplifier Factor(dB)
3. The other emission levels were very low against the limit.
4. Margin value = Emission Level – Limit value
5. " \* ": Fundamental frequency.

CHANNEL	TX Channel 140	DETECTOR FUNCTION	Peak (PK)
FREQUENCY RANGE	1GHz ~ 40GHz		Average (AV)

**ANTENNA POLARITY & TEST DISTANCE: HORIZONTAL AT 3 M**

NO.	FREQ. (MHz)	EMISSION LEVEL (dBuV/m)	LIMIT (dBuV/m)	MARGIN (dB)	ANTENNA HEIGHT (m)	TABLE ANGLE (Degree)	RAW VALUE (dBuV)	CORRECTION FACTOR (dB/m)
1	*5700.00	109.3 PK			1.24 H	330	69.00	40.30
2	*5700.00	99.4 AV			1.24 H	330	59.10	40.30
3	#5725.00	63.1 PK	74.0	-10.9	1.26 H	327	56.80	6.30
4	#5725.00	48.3 AV	54.0	-5.7	1.26 H	327	42.00	6.30
5	11400.00	59.3 PK	74.0	-14.7	1.00 H	51	39.60	19.70
6	11400.00	48.0 AV	54.0	-6.0	1.00 H	51	28.30	19.70

**ANTENNA POLARITY & TEST DISTANCE: VERTICAL AT 3 M**

NO.	FREQ. (MHz)	EMISSION LEVEL (dBuV/m)	LIMIT (dBuV/m)	MARGIN (dB)	ANTENNA HEIGHT (m)	TABLE ANGLE (Degree)	RAW VALUE (dBuV)	CORRECTION FACTOR (dB/m)
1	*5700.00	117.7 PK			1.59 V	7	77.40	40.30
2	*5700.00	107.7 AV			1.59 V	7	67.40	40.30
3	#5725.00	69.1 PK	74.0	-4.9	1.53 V	16	62.80	6.30
<b>4</b>	<b>#5725.00</b>	<b>53.9 AV</b>	<b>54.0</b>	<b>-0.1</b>	<b>1.53 V</b>	<b>16</b>	<b>47.60</b>	<b>6.30</b>
5	11400.00	61.4 PK	74.0	-12.6	1.02 V	14	41.70	19.70
6	11400.00	48.4 AV	54.0	-5.6	1.02 V	14	28.70	19.70

**REMARKS:**

1. Emission Level(dBuV/m) = Raw Value(dBuV) + Correction Factor(dB/m)
2. Correction Factor(dB/m) = Antenna Factor(dB/m) + Cable Factor(dB) – Pre-Amplifier Factor(dB)
3. The other emission levels were very low against the limit.
4. Margin value = Emission Level – Limit value
5. " \* ": Fundamental frequency.
6. " # ": The radiated frequency is out of the restricted band.

802.11n (HT20)

CHANNEL	TX Channel 52	DETECTOR FUNCTION	Peak (PK)
FREQUENCY RANGE	1GHz ~ 40GHz		Average (AV)

ANTENNA POLARITY & TEST DISTANCE: HORIZONTAL AT 3 M								
NO.	FREQ. (MHz)	EMISSION LEVEL (dBuV/m)	LIMIT (dBuV/m)	MARGIN (dB)	ANTENNA HEIGHT (m)	TABLE ANGLE (Degree)	RAW VALUE (dBuV)	CORRECTION FACTOR (dB/m)
1	5150.00	58.9 PK	74.0	-15.1	1.66 H	338	53.40	5.50
2	5150.00	46.2 AV	54.0	-7.8	1.66 H	338	40.70	5.50
3	*5260.00	108.6 PK			1.64 H	332	69.00	39.60
4	*5260.00	98.1 AV			1.64 H	332	58.50	39.60
5	#10520.00	60.4 PK	74.0	-13.6	1.00 H	54	42.30	18.10
6	#10520.00	47.6 AV	54.0	-6.4	1.00 H	54	29.50	18.10

ANTENNA POLARITY & TEST DISTANCE: VERTICAL AT 3 M								
NO.	FREQ. (MHz)	EMISSION LEVEL (dBuV/m)	LIMIT (dBuV/m)	MARGIN (dB)	ANTENNA HEIGHT (m)	TABLE ANGLE (Degree)	RAW VALUE (dBuV)	CORRECTION FACTOR (dB/m)
1	5150.00	59.2 PK	74.0	-14.8	1.42 V	2	53.70	5.50
2	5150.00	46.6 AV	54.0	-7.4	1.42 V	2	41.10	5.50
3	*5260.00	116.1 PK			1.47 V	5	76.50	39.60
4	*5260.00	105.8 AV			1.47 V	5	66.20	39.60
5	#10520.00	60.7 PK	74.0	-13.3	1.04 V	10	42.60	18.10
6	#10520.00	48.0 AV	54.0	-6.0	1.04 V	10	29.90	18.10

REMARKS:

1. Emission Level(dBuV/m) = Raw Value(dBuV) + Correction Factor(dB/m)
2. Correction Factor(dB/m) = Antenna Factor(dB/m) + Cable Factor(dB) – Pre-Amplifier Factor(dB)
3. The other emission levels were very low against the limit.
4. Margin value = Emission Level – Limit value
5. " \* ": Fundamental frequency.
6. " # ": The radiated frequency is out of the restricted band.

CHANNEL	TX Channel 60	DETECTOR FUNCTION	Peak (PK)
FREQUENCY RANGE	1GHz ~ 40GHz		Average (AV)

**ANTENNA POLARITY & TEST DISTANCE: HORIZONTAL AT 3 M**

NO.	FREQ. (MHz)	EMISSION LEVEL (dBuV/m)	LIMIT (dBuV/m)	MARGIN (dB)	ANTENNA HEIGHT (m)	TABLE ANGLE (Degree)	RAW VALUE (dBuV)	CORRECTION FACTOR (dB/m)
1	*5300.00	108.9 PK			1.41 H	329	69.30	39.60
2	*5300.00	98.6 AV			1.41 H	329	59.00	39.60
3	10600.00	60.7 PK	74.0	-13.3	1.00 H	58	42.30	18.40
4	10600.00	47.9 AV	54.0	-6.1	1.00 H	58	29.50	18.40

**ANTENNA POLARITY & TEST DISTANCE: VERTICAL AT 3 M**

NO.	FREQ. (MHz)	EMISSION LEVEL (dBuV/m)	LIMIT (dBuV/m)	MARGIN (dB)	ANTENNA HEIGHT (m)	TABLE ANGLE (Degree)	RAW VALUE (dBuV)	CORRECTION FACTOR (dB/m)
1	*5300.00	115.1 PK			1.60 V	10	75.50	39.60
2	*5300.00	105.2 AV			1.60 V	10	65.60	39.60
3	10600.00	61.0 PK	74.0	-13.0	1.04 V	18	42.60	18.40
4	10600.00	48.1 AV	54.0	-5.9	1.04 V	18	29.70	18.40

**REMARKS:**

1. Emission Level(dBuV/m) = Raw Value(dBuV) + Correction Factor(dB/m)
2. Correction Factor(dB/m) = Antenna Factor(dB/m) + Cable Factor(dB) – Pre-Amplifier Factor(dB)
3. The other emission levels were very low against the limit.
4. Margin value = Emission Level – Limit value
5. " \* ": Fundamental frequency.



CHANNEL	TX Channel 64	DETECTOR FUNCTION	Peak (PK)
FREQUENCY RANGE	1GHz ~ 40GHz		Average (AV)

**ANTENNA POLARITY & TEST DISTANCE: HORIZONTAL AT 3 M**

NO.	FREQ. (MHz)	EMISSION LEVEL (dBuV/m)	LIMIT (dBuV/m)	MARGIN (dB)	ANTENNA HEIGHT (m)	TABLE ANGLE (Degree)	RAW VALUE (dBuV)	CORRECTION FACTOR (dB/m)
1	*5320.00	108.5 PK			1.47 H	330	68.80	39.70
2	*5320.00	97.9 AV			1.47 H	330	58.20	39.70
3	5350.00	57.3 PK	74.0	-16.7	1.44 H	330	51.60	5.70
4	5350.00	45.3 AV	54.0	-8.7	1.44 H	330	39.60	5.70
5	10640.00	60.3 PK	74.0	-13.7	1.00 H	50	41.90	18.40
6	10640.00	47.1 AV	54.0	-6.9	1.00 H	50	28.70	18.40

**ANTENNA POLARITY & TEST DISTANCE: VERTICAL AT 3 M**

NO.	FREQ. (MHz)	EMISSION LEVEL (dBuV/m)	LIMIT (dBuV/m)	MARGIN (dB)	ANTENNA HEIGHT (m)	TABLE ANGLE (Degree)	RAW VALUE (dBuV)	CORRECTION FACTOR (dB/m)
1	*5320.00	115.7 PK			1.37 V	7	76.00	39.70
2	*5320.00	105.5 AV			1.37 V	7	65.80	39.70
3	5350.00	63.5 PK	74.0	-10.5	1.30 V	6	57.80	5.70
4	5350.00	49.3 AV	54.0	-4.7	1.30 V	6	43.60	5.70
5	10640.00	60.6 PK	74.0	-13.4	1.00 V	16	42.20	18.40
6	10640.00	47.3 AV	54.0	-6.7	1.00 V	16	28.90	18.40

**REMARKS:**

1. Emission Level(dBuV/m) = Raw Value(dBuV) + Correction Factor(dB/m)
2. Correction Factor(dB/m) = Antenna Factor(dB/m) + Cable Factor(dB) – Pre-Amplifier Factor(dB)
3. The other emission levels were very low against the limit.
4. Margin value = Emission Level – Limit value
5. " \* ": Fundamental frequency.

CHANNEL	TX Channel 100	DETECTOR FUNCTION	Peak (PK)
FREQUENCY RANGE	1GHz ~ 40GHz		Average (AV)

**ANTENNA POLARITY & TEST DISTANCE: HORIZONTAL AT 3 M**

NO.	FREQ. (MHz)	EMISSION LEVEL (dBuV/m)	LIMIT (dBuV/m)	MARGIN (dB)	ANTENNA HEIGHT (m)	TABLE ANGLE (Degree)	RAW VALUE (dBuV)	CORRECTION FACTOR (dB/m)
1	5460.00	57.0 PK	74.0	-17.0	1.00 H	23	51.20	5.80
2	5460.00	44.4 AV	54.0	-9.6	1.00 H	23	38.60	5.80
3	#5470.00	57.4 PK	74.0	-16.6	1.00 H	29	51.50	5.90
4	#5470.00	44.0 AV	54.0	-10.0	1.00 H	29	38.10	5.90
5	*5500.00	107.7 PK			1.25 H	48	67.80	39.90
6	*5500.00	96.6 AV			1.25 H	48	56.70	39.90
7	11000.00	60.3 PK	74.0	-13.7	1.10 H	81	41.40	18.90
8	11000.00	47.1 AV	54.0	-6.9	1.10 H	81	28.20	18.90

**ANTENNA POLARITY & TEST DISTANCE: VERTICAL AT 3 M**

NO.	FREQ. (MHz)	EMISSION LEVEL (dBuV/m)	LIMIT (dBuV/m)	MARGIN (dB)	ANTENNA HEIGHT (m)	TABLE ANGLE (Degree)	RAW VALUE (dBuV)	CORRECTION FACTOR (dB/m)
1	5460.00	59.1 PK	74.0	-14.9	1.62 V	11	53.30	5.80
2	5460.00	46.6 AV	54.0	-7.4	1.62 V	11	40.80	5.80
3	#5470.00	59.7 PK	74.0	-14.3	1.62 V	11	53.80	5.90
4	#5470.00	47.1 AV	54.0	-6.9	1.62 V	11	41.20	5.90
5	*5500.00	115.1 PK			1.49 V	12	75.20	39.90
6	*5500.00	105.1 AV			1.49 V	12	65.20	39.90
7	11000.00	60.4 PK	74.0	-13.6	1.28 V	55	41.50	18.90
8	11000.00	47.1 AV	54.0	-6.9	1.28 V	55	28.20	18.90

**REMARKS:**

1. Emission Level(dBuV/m) = Raw Value(dBuV) + Correction Factor(dB/m)
2. Correction Factor(dB/m) = Antenna Factor(dB/m) + Cable Factor(dB) – Pre-Amplifier Factor(dB)
3. The other emission levels were very low against the limit.
4. Margin value = Emission Level – Limit value
5. " \* ": Fundamental frequency.
6. " # ": The radiated frequency is out of the restricted band.

CHANNEL	TX Channel 116	DETECTOR FUNCTION	Peak (PK)
FREQUENCY RANGE	1GHz ~ 40GHz		Average (AV)

**ANTENNA POLARITY & TEST DISTANCE: HORIZONTAL AT 3 M**

NO.	FREQ. (MHz)	EMISSION LEVEL (dBuV/m)	LIMIT (dBuV/m)	MARGIN (dB)	ANTENNA HEIGHT (m)	TABLE ANGLE (Degree)	RAW VALUE (dBuV)	CORRECTION FACTOR (dB/m)
1	*5580.00	107.1 PK			1.15 H	37	67.20	39.90
2	*5580.00	96.7 AV			1.15 H	37	56.80	39.90
3	11160.00	60.8 PK	74.0	-13.2	1.00 H	15	41.60	19.20
4	11160.00	47.9 AV	54.0	-6.1	1.00 H	15	28.70	19.20

**ANTENNA POLARITY & TEST DISTANCE: VERTICAL AT 3 M**

NO.	FREQ. (MHz)	EMISSION LEVEL (dBuV/m)	LIMIT (dBuV/m)	MARGIN (dB)	ANTENNA HEIGHT (m)	TABLE ANGLE (Degree)	RAW VALUE (dBuV)	CORRECTION FACTOR (dB/m)
1	*5580.00	113.8 PK			1.53 V	12	73.90	39.90
2	*5580.00	103.9 AV			1.53 V	12	64.00	39.90
3	11160.00	61.5 PK	74.0	-12.5	1.00 V	311	42.30	19.20
4	11160.00	47.6 AV	54.0	-6.4	1.00 V	311	28.40	19.20

**REMARKS:**

1. Emission Level(dBuV/m) = Raw Value(dBuV) + Correction Factor(dB/m)
2. Correction Factor(dB/m) = Antenna Factor(dB/m) + Cable Factor(dB) – Pre-Amplifier Factor(dB)
3. The other emission levels were very low against the limit.
4. Margin value = Emission Level – Limit value
5. " \* ": Fundamental frequency.

CHANNEL	TX Channel 140	DETECTOR FUNCTION	Peak (PK)
FREQUENCY RANGE	1GHz ~ 40GHz		Average (AV)

**ANTENNA POLARITY & TEST DISTANCE: HORIZONTAL AT 3 M**

NO.	FREQ. (MHz)	EMISSION LEVEL (dBuV/m)	LIMIT (dBuV/m)	MARGIN (dB)	ANTENNA HEIGHT (m)	TABLE ANGLE (Degree)	RAW VALUE (dBuV)	CORRECTION FACTOR (dB/m)
1	*5700.00	105.7 PK			1.00 H	336	65.40	40.30
2	*5700.00	96.0 AV			1.00 H	336	55.70	40.30
3	#5725.00	57.5 PK	74.0	-16.5	1.10 H	333	51.20	6.30
4	#5725.00	44.6 AV	54.0	-9.4	1.10 H	333	38.30	6.30
5	11400.00	62.7 PK	74.0	-11.3	1.07 H	293	43.00	19.70
6	11400.00	48.7 AV	54.0	-5.3	1.07 H	293	29.00	19.70

**ANTENNA POLARITY & TEST DISTANCE: VERTICAL AT 3 M**

NO.	FREQ. (MHz)	EMISSION LEVEL (dBuV/m)	LIMIT (dBuV/m)	MARGIN (dB)	ANTENNA HEIGHT (m)	TABLE ANGLE (Degree)	RAW VALUE (dBuV)	CORRECTION FACTOR (dB/m)
1	*5700.00	113.9 PK			1.55 V	17	73.60	40.30
2	*5700.00	103.6 AV			1.55 V	17	63.30	40.30
3	#5725.00	61.4 PK	74.0	-12.6	1.84 V	11	55.10	6.30
4	#5725.00	48.1 AV	54.0	-5.9	1.84 V	11	41.80	6.30
5	11400.00	62.5 PK	74.0	-11.5	1.17 V	332	42.80	19.70
6	11400.00	49.3 AV	54.0	-4.7	1.17 V	332	29.60	19.70

**REMARKS:**

1. Emission Level(dBuV/m) = Raw Value(dBuV) + Correction Factor(dB/m)
2. Correction Factor(dB/m) = Antenna Factor(dB/m) + Cable Factor(dB) – Pre-Amplifier Factor(dB)
3. The other emission levels were very low against the limit.
4. Margin value = Emission Level – Limit value
5. " \* ": Fundamental frequency.
6. " # ": The radiated frequency is out of the restricted band.

**802.11n (HT40)**

CHANNEL	TX Channel 54	DETECTOR FUNCTION	Peak (PK)
FREQUENCY RANGE	1GHz ~ 40GHz		Average (AV)

ANTENNA POLARITY & TEST DISTANCE: HORIZONTAL AT 3 M								
NO.	FREQ. (MHz)	EMISSION LEVEL (dBuV/m)	LIMIT (dBuV/m)	MARGIN (dB)	ANTENNA HEIGHT (m)	TABLE ANGLE (Degree)	RAW VALUE (dBuV)	CORRECTION FACTOR (dB/m)
1	5150.00	56.2 PK	74.0	-17.8	1.00 H	266	50.70	5.50
2	5150.00	43.7 AV	54.0	-10.3	1.00 H	266	38.20	5.50
3	*5270.00	106.0 PK			1.44 H	333	66.40	39.60
4	*5270.00	95.5 AV			1.44 H	333	55.90	39.60
5	#10540.00	59.5 PK	74.0	-14.5	1.22 H	276	41.40	18.10
6	#10540.00	47.4 AV	54.0	-6.6	1.22 H	276	29.30	18.10

ANTENNA POLARITY & TEST DISTANCE: VERTICAL AT 3 M								
NO.	FREQ. (MHz)	EMISSION LEVEL (dBuV/m)	LIMIT (dBuV/m)	MARGIN (dB)	ANTENNA HEIGHT (m)	TABLE ANGLE (Degree)	RAW VALUE (dBuV)	CORRECTION FACTOR (dB/m)
1	5150.00	56.9 PK	74.0	-17.1	1.00 V	106	51.40	5.50
2	5150.00	44.4 AV	54.0	-9.6	1.00 V	106	38.90	5.50
3	*5270.00	111.9 PK			1.55 V	12	72.30	39.60
4	*5270.00	102.1 AV			1.55 V	12	62.50	39.60
5	#10540.00	60.9 PK	74.0	-13.1	1.33 V	62	42.80	18.10
6	#10540.00	46.4 AV	54.0	-7.6	1.33 V	62	28.30	18.10

**REMARKS:**

1. Emission Level(dBuV/m) = Raw Value(dBuV) + Correction Factor(dB/m)
2. Correction Factor(dB/m) = Antenna Factor(dB/m) + Cable Factor(dB) – Pre-Amplifier Factor(dB)
3. The other emission levels were very low against the limit.
4. Margin value = Emission Level – Limit value
5. " \* ": Fundamental frequency.
6. " # ": The radiated frequency is out of the restricted band.

CHANNEL	TX Channel 62	DETECTOR FUNCTION	Peak (PK)
FREQUENCY RANGE	1GHz ~ 40GHz		Average (AV)

**ANTENNA POLARITY & TEST DISTANCE: HORIZONTAL AT 3 M**

NO.	FREQ. (MHz)	EMISSION LEVEL (dBuV/m)	LIMIT (dBuV/m)	MARGIN (dB)	ANTENNA HEIGHT (m)	TABLE ANGLE (Degree)	RAW VALUE (dBuV)	CORRECTION FACTOR (dB/m)
1	*5310.00	103.7 PK			1.52 H	37	64.10	39.60
2	*5310.00	93.9 AV			1.52 H	37	54.30	39.60
3	5350.00	58.6 PK	74.0	-15.4	1.00 H	113	52.90	5.70
4	5350.00	44.5 AV	54.0	-9.5	1.00 H	113	38.80	5.70
5	10620.00	60.4 PK	74.0	-13.6	1.37 H	74	42.10	18.30
6	10620.00	47.5 AV	54.0	-6.5	1.37 H	74	29.20	18.30

**ANTENNA POLARITY & TEST DISTANCE: VERTICAL AT 3 M**

NO.	FREQ. (MHz)	EMISSION LEVEL (dBuV/m)	LIMIT (dBuV/m)	MARGIN (dB)	ANTENNA HEIGHT (m)	TABLE ANGLE (Degree)	RAW VALUE (dBuV)	CORRECTION FACTOR (dB/m)
1	*5310.00	112.8 PK			1.61 V	8	73.20	39.60
2	*5310.00	103.0 AV			1.61 V	8	63.40	39.60
3	5350.00	59.6 PK	74.0	-14.4	1.00 V	18	53.90	5.70
4	5350.00	46.2 AV	54.0	-7.8	1.00 V	18	40.50	5.70
5	10620.00	60.0 PK	74.0	-14.0	1.34 V	345	41.70	18.30
6	10620.00	47.5 AV	54.0	-6.5	1.34 V	345	29.20	18.30

**REMARKS:**

1. Emission Level(dBuV/m) = Raw Value(dBuV) + Correction Factor(dB/m)
2. Correction Factor(dB/m) = Antenna Factor(dB/m) + Cable Factor(dB) – Pre-Amplifier Factor(dB)
3. The other emission levels were very low against the limit.
4. Margin value = Emission Level – Limit value
5. " \* ": Fundamental frequency.

CHANNEL	TX Channel 102	DETECTOR FUNCTION	Peak (PK)
FREQUENCY RANGE	1GHz ~ 40GHz		Average (AV)

**ANTENNA POLARITY & TEST DISTANCE: HORIZONTAL AT 3 M**

NO.	FREQ. (MHz)	EMISSION LEVEL (dBuV/m)	LIMIT (dBuV/m)	MARGIN (dB)	ANTENNA HEIGHT (m)	TABLE ANGLE (Degree)	RAW VALUE (dBuV)	CORRECTION FACTOR (dB/m)
1	5460.00	58.4 PK	74.0	-15.6	1.06 H	41	52.60	5.80
2	5460.00	45.1 AV	54.0	-8.9	1.06 H	41	39.30	5.80
3	#5470.00	59.0 PK	74.0	-15.0	1.10 H	40	53.10	5.90
4	#5470.00	46.4 AV	54.0	-7.6	1.10 H	40	40.50	5.90
5	*5510.00	103.4 PK			1.01 H	47	63.50	39.90
6	*5510.00	92.9 AV			1.01 H	47	53.00	39.90
7	11020.00	60.5 PK	74.0	-13.5	1.00 H	139	41.50	19.00
8	11020.00	47.2 AV	54.0	-6.8	1.00 H	139	28.20	19.00

**ANTENNA POLARITY & TEST DISTANCE: VERTICAL AT 3 M**

NO.	FREQ. (MHz)	EMISSION LEVEL (dBuV/m)	LIMIT (dBuV/m)	MARGIN (dB)	ANTENNA HEIGHT (m)	TABLE ANGLE (Degree)	RAW VALUE (dBuV)	CORRECTION FACTOR (dB/m)
1	5460.00	59.0 PK	74.0	-15.0	1.20 V	27	53.20	5.80
2	5460.00	47.0 AV	54.0	-7.0	1.20 V	27	41.20	5.80
3	#5470.00	60.3 PK	74.0	-13.7	1.49 V	20	54.40	5.90
4	#5470.00	48.0 AV	54.0	-6.0	1.49 V	20	42.10	5.90
5	*5510.00	112.6 PK			1.48 V	13	72.70	39.90
6	*5510.00	102.6 AV			1.48 V	13	62.70	39.90
7	11020.00	61.1 PK	74.0	-12.9	1.00 V	224	42.10	19.00
8	11020.00	47.5 AV	54.0	-6.5	1.00 V	224	28.50	19.00

**REMARKS:**

1. Emission Level(dBuV/m) = Raw Value(dBuV) + Correction Factor(dB/m)
2. Correction Factor(dB/m) = Antenna Factor(dB/m) + Cable Factor(dB) – Pre-Amplifier Factor(dB)
3. The other emission levels were very low against the limit.
4. Margin value = Emission Level – Limit value
5. " \* ": Fundamental frequency.
6. " # ": The radiated frequency is out of the restricted band.

CHANNEL	TX Channel 110	DETECTOR FUNCTION	Peak (PK)
FREQUENCY RANGE	1GHz ~ 40GHz		Average (AV)

**ANTENNA POLARITY & TEST DISTANCE: HORIZONTAL AT 3 M**

NO.	FREQ. (MHz)	EMISSION LEVEL (dBuV/m)	LIMIT (dBuV/m)	MARGIN (dB)	ANTENNA HEIGHT (m)	TABLE ANGLE (Degree)	RAW VALUE (dBuV)	CORRECTION FACTOR (dB/m)
1	*5550.00	104.1 PK			1.19 H	49	64.10	40.00
2	*5550.00	93.2 AV			1.19 H	49	53.20	40.00
3	11100.00	61.5 PK	74.0	-12.5	1.00 H	261	41.90	19.60
4	11100.00	48.3 AV	54.0	-5.7	1.00 H	261	28.70	19.60

**ANTENNA POLARITY & TEST DISTANCE: VERTICAL AT 3 M**

NO.	FREQ. (MHz)	EMISSION LEVEL (dBuV/m)	LIMIT (dBuV/m)	MARGIN (dB)	ANTENNA HEIGHT (m)	TABLE ANGLE (Degree)	RAW VALUE (dBuV)	CORRECTION FACTOR (dB/m)
1	*5550.00	111.5 PK			1.40 V	8	71.50	40.00
2	*5550.00	101.4 AV			1.40 V	8	61.40	40.00
3	11100.00	61.1 PK	74.0	-12.9	1.16 V	183	41.50	19.60
4	11100.00	48.6 AV	54.0	-5.4	1.16 V	183	29.00	19.60

**REMARKS:**

1. Emission Level(dBuV/m) = Raw Value(dBuV) + Correction Factor(dB/m)
2. Correction Factor(dB/m) = Antenna Factor(dB/m) + Cable Factor(dB) – Pre-Amplifier Factor(dB)
3. The other emission levels were very low against the limit.
4. Margin value = Emission Level – Limit value
5. " \* ": Fundamental frequency.



CHANNEL	TX Channel 134	DETECTOR FUNCTION	Peak (PK)
FREQUENCY RANGE	1GHz ~ 40GHz		Average (AV)

**ANTENNA POLARITY & TEST DISTANCE: HORIZONTAL AT 3 M**

NO.	FREQ. (MHz)	EMISSION LEVEL (dBuV/m)	LIMIT (dBuV/m)	MARGIN (dB)	ANTENNA HEIGHT (m)	TABLE ANGLE (Degree)	RAW VALUE (dBuV)	CORRECTION FACTOR (dB/m)
1	*5670.00	103.7 PK			1.20 H	334	63.50	40.20
2	*5670.00	93.3 AV			1.20 H	334	53.10	40.20
3	#5725.00	56.5 PK	74.0	-17.5	1.00 H	45	50.20	6.30
4	#5725.00	44.3 AV	54.0	-9.7	1.00 H	45	38.00	6.30
5	11340.00	61.9 PK	74.0	-12.1	1.14 H	198	42.20	19.70
6	11340.00	48.9 AV	54.0	-5.1	1.14 H	198	29.20	19.70

**ANTENNA POLARITY & TEST DISTANCE: VERTICAL AT 3 M**

NO.	FREQ. (MHz)	EMISSION LEVEL (dBuV/m)	LIMIT (dBuV/m)	MARGIN (dB)	ANTENNA HEIGHT (m)	TABLE ANGLE (Degree)	RAW VALUE (dBuV)	CORRECTION FACTOR (dB/m)
1	*5670.00	110.9 PK			1.56 V	12	70.70	40.20
2	*5670.00	100.2 AV			1.56 V	12	60.00	40.20
3	#5725.00	58.3 PK	74.0	-15.7	1.49 V	8	52.00	6.30
4	#5725.00	46.3 AV	54.0	-7.7	1.49 V	8	40.00	6.30
5	11340.00	62.1 PK	74.0	-11.9	1.12 V	321	42.40	19.70
6	11340.00	49.0 AV	54.0	-5.0	1.12 V	321	29.30	19.70

**REMARKS:**

1. Emission Level(dBuV/m) = Raw Value(dBuV) + Correction Factor(dB/m)
2. Correction Factor(dB/m) = Antenna Factor(dB/m) + Cable Factor(dB) – Pre-Amplifier Factor(dB)
3. The other emission levels were very low against the limit.
4. Margin value = Emission Level – Limit value
5. " \* ": Fundamental frequency.
6. " # ": The radiated frequency is out of the restricted band.

802.11ac (VHT80)

CHANNEL	TX Channel 58	DETECTOR FUNCTION	Peak (PK)
FREQUENCY RANGE	1GHz ~ 40GHz		Average (AV)

ANTENNA POLARITY & TEST DISTANCE: HORIZONTAL AT 3 M								
NO.	FREQ. (MHz)	EMISSION LEVEL (dBuV/m)	LIMIT (dBuV/m)	MARGIN (dB)	ANTENNA HEIGHT (m)	TABLE ANGLE (Degree)	RAW VALUE (dBuV)	CORRECTION FACTOR (dB/m)
1	*5290.00	98.2 PK			1.00 H	37	58.60	39.60
2	*5290.00	88.5 AV			1.00 H	37	48.90	39.60
3	5350.00	56.9 PK	74.0	-17.1	1.05 H	154	51.20	5.70
4	5350.00	45.1 AV	54.0	-8.9	1.05 H	154	39.40	5.70
5	#10580.00	61.0 PK	74.0	-13.0	1.10 H	53	42.70	18.30
6	#10580.00	47.3 AV	54.0	-6.7	1.10 H	53	29.00	18.30

ANTENNA POLARITY & TEST DISTANCE: VERTICAL AT 3 M								
NO.	FREQ. (MHz)	EMISSION LEVEL (dBuV/m)	LIMIT (dBuV/m)	MARGIN (dB)	ANTENNA HEIGHT (m)	TABLE ANGLE (Degree)	RAW VALUE (dBuV)	CORRECTION FACTOR (dB/m)
1	*5290.00	108.8 PK			1.54 V	10	69.20	39.60
2	*5290.00	98.6 AV			1.54 V	10	59.00	39.60
3	5350.00	73.8 PK	74.0	-0.2	1.37 V	15	68.10	5.70
4	5350.00	46.3 AV	54.0	-7.7	1.37 V	15	40.60	5.70
5	#10580.00	60.0 PK	74.0	-14.0	1.38 V	32	41.70	18.30
6	#10580.00	47.3 AV	54.0	-6.7	1.38 V	32	29.00	18.30

REMARKS:

1. Emission Level(dBuV/m) = Raw Value(dBuV) + Correction Factor(dB/m)
2. Correction Factor(dB/m) = Antenna Factor(dB/m) + Cable Factor(dB) – Pre-Amplifier Factor(dB)
3. The other emission levels were very low against the limit.
4. Margin value = Emission Level – Limit value
5. " \* ": Fundamental frequency.
6. " # ": The radiated frequency is out of the restricted band.

CHANNEL	TX Channel 106	DETECTOR FUNCTION	Peak (PK)
FREQUENCY RANGE	1GHz ~ 40GHz		Average (AV)

**ANTENNA POLARITY & TEST DISTANCE: HORIZONTAL AT 3 M**

NO.	FREQ. (MHz)	EMISSION LEVEL (dBuV/m)	LIMIT (dBuV/m)	MARGIN (dB)	ANTENNA HEIGHT (m)	TABLE ANGLE (Degree)	RAW VALUE (dBuV)	CORRECTION FACTOR (dB/m)
1	5460.00	64.6 PK	74.0	-9.4	1.08 H	328	58.80	5.80
2	5460.00	44.7 AV	54.0	-9.3	1.08 H	328	38.90	5.80
3	#5470.00	59.1 PK	74.0	-14.9	1.11 H	346	53.20	5.90
4	#5470.00	45.2 AV	54.0	-8.8	1.11 H	346	39.30	5.90
5	*5530.00	100.5 PK			1.25 H	34	60.60	39.90
6	*5530.00	89.7 AV			1.25 H	34	49.80	39.90
7	11060.00	60.7 PK	74.0	-13.3	1.17 H	74	41.50	19.20
8	11060.00	48.0 AV	54.0	-6.0	1.17 H	74	28.80	19.20

**ANTENNA POLARITY & TEST DISTANCE: VERTICAL AT 3 M**

NO.	FREQ. (MHz)	EMISSION LEVEL (dBuV/m)	LIMIT (dBuV/m)	MARGIN (dB)	ANTENNA HEIGHT (m)	TABLE ANGLE (Degree)	RAW VALUE (dBuV)	CORRECTION FACTOR (dB/m)
<b>1</b>	<b>5460.00</b>	<b>73.9 PK</b>	<b>74.0</b>	<b>-0.1</b>	<b>1.50 V</b>	<b>359</b>	<b>68.10</b>	<b>5.80</b>
2	5460.00	48.0 AV	54.0	-6.0	1.50 V	359	42.20	5.80
3	#5470.00	73.2 PK	74.0	-0.8	1.56 V	18	67.30	5.90
4	#5470.00	49.1 AV	54.0	-4.9	1.56 V	18	43.20	5.90
5	*5530.00	108.2 PK			1.55 V	13	68.30	39.90
6	*5530.00	97.6 AV			1.55 V	13	57.70	39.90
7	11060.00	61.7 PK	74.0	-12.3	1.41 V	169	42.50	19.20
8	11060.00	47.7 AV	54.0	-6.3	1.41 V	169	28.50	19.20

**REMARKS:**

1. Emission Level(dBuV/m) = Raw Value(dBuV) + Correction Factor(dB/m)
2. Correction Factor(dB/m) = Antenna Factor(dB/m) + Cable Factor(dB) – Pre-Amplifier Factor(dB)
3. The other emission levels were very low against the limit.
4. Margin value = Emission Level – Limit value
5. " \* ": Fundamental frequency.
6. " # ": The radiated frequency is out of the restricted band.

Test Mode D

4TX

802.11a

CHANNEL	TX Channel 52	DETECTOR FUNCTION	Peak (PK)
FREQUENCY RANGE	1GHz ~ 40GHz		Average (AV)

ANTENNA POLARITY & TEST DISTANCE: HORIZONTAL AT 3 M								
NO.	FREQ. (MHz)	EMISSION LEVEL (dBuV/m)	LIMIT (dBuV/m)	MARGIN (dB)	ANTENNA HEIGHT (m)	TABLE ANGLE (Degree)	RAW VALUE (dBuV)	CORRECTION FACTOR (dB/m)
1	5150.00	59.1 PK	74.0	-14.9	1.66 H	322	53.60	5.50
2	5150.00	45.6 AV	54.0	-8.4	1.66 H	322	40.10	5.50
3	*5260.00	114.0 PK			1.66 H	329	74.40	39.60
4	*5260.00	104.4 AV			1.66 H	329	64.80	39.60
5	#10520.00	60.8 PK	74.0	-13.2	1.00 H	54	42.70	18.10
6	#10520.00	48.2 AV	54.0	-5.8	1.00 H	54	30.10	18.10

ANTENNA POLARITY & TEST DISTANCE: VERTICAL AT 3 M								
NO.	FREQ. (MHz)	EMISSION LEVEL (dBuV/m)	LIMIT (dBuV/m)	MARGIN (dB)	ANTENNA HEIGHT (m)	TABLE ANGLE (Degree)	RAW VALUE (dBuV)	CORRECTION FACTOR (dB/m)
1	5150.00	59.2 PK	74.0	-14.8	1.83 V	7	53.70	5.50
2	5150.00	46.0 AV	54.0	-8.0	1.83 V	7	40.50	5.50
3	*5260.00	119.9 PK			1.84 V	9	80.30	39.60
4	*5260.00	110.4 AV			1.84 V	9	70.80	39.60
5	#10520.00	61.3 PK	74.0	-12.7	1.00 V	18	43.20	18.10
6	#10520.00	48.4 AV	54.0	-5.6	1.00 V	18	30.30	18.10

REMARKS:

1. Emission Level(dBuV/m) = Raw Value(dBuV) + Correction Factor(dB/m)
2. Correction Factor(dB/m) = Antenna Factor(dB/m) + Cable Factor(dB) – Pre-Amplifier Factor(dB)
3. The other emission levels were very low against the limit.
4. Margin value = Emission Level – Limit value
5. " \* ": Fundamental frequency.
6. " # ": The radiated frequency is out of the restricted band.

CHANNEL	TX Channel 60	DETECTOR FUNCTION	Peak (PK)
FREQUENCY RANGE	1GHz ~ 40GHz		Average (AV)

**ANTENNA POLARITY & TEST DISTANCE: HORIZONTAL AT 3 M**

NO.	FREQ. (MHz)	EMISSION LEVEL (dBuV/m)	LIMIT (dBuV/m)	MARGIN (dB)	ANTENNA HEIGHT (m)	TABLE ANGLE (Degree)	RAW VALUE (dBuV)	CORRECTION FACTOR (dB/m)
1	*5300.00	113.2 PK			1.72 H	332	73.60	39.60
2	*5300.00	103.6 AV			1.72 H	332	64.00	39.60
3	10600.00	60.9 PK	74.0	-13.1	1.00 H	51	42.50	18.40
4	10600.00	48.4 AV	54.0	-5.6	1.00 H	51	30.00	18.40

**ANTENNA POLARITY & TEST DISTANCE: VERTICAL AT 3 M**

NO.	FREQ. (MHz)	EMISSION LEVEL (dBuV/m)	LIMIT (dBuV/m)	MARGIN (dB)	ANTENNA HEIGHT (m)	TABLE ANGLE (Degree)	RAW VALUE (dBuV)	CORRECTION FACTOR (dB/m)
1	*5300.00	120.1 PK			1.82 V	9	80.50	39.60
2	*5300.00	110.6 AV			1.82 V	9	71.00	39.60
3	10600.00	61.6 PK	74.0	-12.4	1.01 V	19	43.20	18.40
4	10600.00	48.6 AV	54.0	-5.4	1.01 V	19	30.20	18.40

**REMARKS:**

1. Emission Level(dBuV/m) = Raw Value(dBuV) + Correction Factor(dB/m)
2. Correction Factor(dB/m) = Antenna Factor(dB/m) + Cable Factor(dB) – Pre-Amplifier Factor(dB)
3. The other emission levels were very low against the limit.
4. Margin value = Emission Level – Limit value
5. " \* ": Fundamental frequency.

CHANNEL	TX Channel 64	DETECTOR FUNCTION	Peak (PK)
FREQUENCY RANGE	1GHz ~ 40GHz		Average (AV)

**ANTENNA POLARITY & TEST DISTANCE: HORIZONTAL AT 3 M**

NO.	FREQ. (MHz)	EMISSION LEVEL (dBuV/m)	LIMIT (dBuV/m)	MARGIN (dB)	ANTENNA HEIGHT (m)	TABLE ANGLE (Degree)	RAW VALUE (dBuV)	CORRECTION FACTOR (dB/m)
1	*5320.00	112.6 PK			1.78 H	332	72.90	39.70
2	*5320.00	103.0 AV			1.78 H	332	63.30	39.70
3	5350.00	63.1 PK	74.0	-10.9	1.70 H	331	57.40	5.70
4	5350.00	46.9 AV	54.0	-7.1	1.70 H	331	41.20	5.70
5	10640.00	60.5 PK	74.0	-13.5	1.00 H	50	42.10	18.40
6	10640.00	47.6 AV	54.0	-6.4	1.00 H	50	29.20	18.40

**ANTENNA POLARITY & TEST DISTANCE: VERTICAL AT 3 M**

NO.	FREQ. (MHz)	EMISSION LEVEL (dBuV/m)	LIMIT (dBuV/m)	MARGIN (dB)	ANTENNA HEIGHT (m)	TABLE ANGLE (Degree)	RAW VALUE (dBuV)	CORRECTION FACTOR (dB/m)
1	*5320.00	119.4 PK			1.75 V	10	79.70	39.70
2	*5320.00	109.9 AV			1.75 V	10	70.20	39.70
3	5350.00	70.5 PK	74.0	-3.5	1.81 V	2	64.80	5.70
4	5350.00	52.3 AV	54.0	-1.7	1.81 V	2	46.60	5.70
5	10640.00	61.1 PK	74.0	-12.9	1.00 V	18	42.70	18.40
6	10640.00	48.2 AV	54.0	-5.8	1.00 V	18	29.80	18.40

**REMARKS:**

1. Emission Level(dBuV/m) = Raw Value(dBuV) + Correction Factor(dB/m)
2. Correction Factor(dB/m) = Antenna Factor(dB/m) + Cable Factor(dB) – Pre-Amplifier Factor(dB)
3. The other emission levels were very low against the limit.
4. Margin value = Emission Level – Limit value
5. " \* ": Fundamental frequency.

CHANNEL	TX Channel 100	DETECTOR FUNCTION	Peak (PK)
FREQUENCY RANGE	1GHz ~ 40GHz		Average (AV)

**ANTENNA POLARITY & TEST DISTANCE: HORIZONTAL AT 3 M**

NO.	FREQ. (MHz)	EMISSION LEVEL (dBuV/m)	LIMIT (dBuV/m)	MARGIN (dB)	ANTENNA HEIGHT (m)	TABLE ANGLE (Degree)	RAW VALUE (dBuV)	CORRECTION FACTOR (dB/m)
1	5460.00	59.4 PK	74.0	-14.6	1.24 H	327	53.60	5.80
2	5460.00	46.6 AV	54.0	-7.4	1.24 H	327	40.80	5.80
3	#5470.00	64.0 PK	74.0	-10.0	1.24 H	327	58.10	5.90
4	#5470.00	49.0 AV	54.0	-5.0	1.24 H	327	43.10	5.90
5	*5500.00	112.8 PK			1.20 H	328	72.90	39.90
6	*5500.00	102.5 AV			1.20 H	328	62.60	39.90
7	11000.00	60.1 PK	74.0	-13.9	1.00 H	51	41.20	18.90
8	11000.00	48.1 AV	54.0	-5.9	1.00 H	51	29.20	18.90

**ANTENNA POLARITY & TEST DISTANCE: VERTICAL AT 3 M**

NO.	FREQ. (MHz)	EMISSION LEVEL (dBuV/m)	LIMIT (dBuV/m)	MARGIN (dB)	ANTENNA HEIGHT (m)	TABLE ANGLE (Degree)	RAW VALUE (dBuV)	CORRECTION FACTOR (dB/m)
1	5460.00	62.8 PK	74.0	-11.2	1.83 V	1	57.00	5.80
2	5460.00	50.6 AV	54.0	-3.4	1.83 V	1	44.80	5.80
3	#5470.00	66.9 PK	74.0	-7.1	1.83 V	1	61.00	5.90
4	#5470.00	51.9 AV	54.0	-2.1	1.83 V	1	46.00	5.90
5	*5500.00	120.5 PK			1.74 V	2	80.60	39.90
6	*5500.00	111.4 AV			1.74 V	2	71.50	39.90
7	11000.00	60.6 PK	74.0	-13.4	1.03 V	15	41.70	18.90
8	11000.00	48.6 AV	54.0	-5.4	1.03 V	15	29.70	18.90

**REMARKS:**

1. Emission Level(dBuV/m) = Raw Value(dBuV) + Correction Factor(dB/m)
2. Correction Factor(dB/m) = Antenna Factor(dB/m) + Cable Factor(dB) – Pre-Amplifier Factor(dB)
3. The other emission levels were very low against the limit.
4. Margin value = Emission Level – Limit value
5. " \* ": Fundamental frequency.
6. " # ": The radiated frequency is out of the restricted band.

CHANNEL	TX Channel 116	DETECTOR FUNCTION	Peak (PK)
FREQUENCY RANGE	1GHz ~ 40GHz		Average (AV)

**ANTENNA POLARITY & TEST DISTANCE: HORIZONTAL AT 3 M**

NO.	FREQ. (MHz)	EMISSION LEVEL (dBuV/m)	LIMIT (dBuV/m)	MARGIN (dB)	ANTENNA HEIGHT (m)	TABLE ANGLE (Degree)	RAW VALUE (dBuV)	CORRECTION FACTOR (dB/m)
1	*5580.00	111.9 PK			1.67 H	337	72.00	39.90
2	*5580.00	102.2 AV			1.67 H	337	62.30	39.90
3	11160.00	60.2 PK	74.0	-13.8	1.00 H	52	41.00	19.20
4	11160.00	48.4 AV	54.0	-5.6	1.00 H	52	29.20	19.20

**ANTENNA POLARITY & TEST DISTANCE: VERTICAL AT 3 M**

NO.	FREQ. (MHz)	EMISSION LEVEL (dBuV/m)	LIMIT (dBuV/m)	MARGIN (dB)	ANTENNA HEIGHT (m)	TABLE ANGLE (Degree)	RAW VALUE (dBuV)	CORRECTION FACTOR (dB/m)
1	*5580.00	119.9 PK			1.49 V	9	80.00	39.90
2	*5580.00	110.3 AV			1.49 V	9	70.40	39.90
3	11160.00	61.0 PK	74.0	-13.0	1.02 V	18	41.80	19.20
4	11160.00	48.7 AV	54.0	-5.3	1.02 V	18	29.50	19.20

**REMARKS:**

1. Emission Level(dBuV/m) = Raw Value(dBuV) + Correction Factor(dB/m)
2. Correction Factor(dB/m) = Antenna Factor(dB/m) + Cable Factor(dB) – Pre-Amplifier Factor(dB)
3. The other emission levels were very low against the limit.
4. Margin value = Emission Level – Limit value
5. " \* ": Fundamental frequency.



CHANNEL	TX Channel 140	DETECTOR FUNCTION	Peak (PK)
FREQUENCY RANGE	1GHz ~ 40GHz		Average (AV)

**ANTENNA POLARITY & TEST DISTANCE: HORIZONTAL AT 3 M**

NO.	FREQ. (MHz)	EMISSION LEVEL (dBuV/m)	LIMIT (dBuV/m)	MARGIN (dB)	ANTENNA HEIGHT (m)	TABLE ANGLE (Degree)	RAW VALUE (dBuV)	CORRECTION FACTOR (dB/m)
1	*5700.00	110.9 PK			1.05 H	327	70.60	40.30
2	*5700.00	101.3 AV			1.05 H	327	61.00	40.30
3	#5725.00	62.9 PK	74.0	-11.1	1.02 H	321	56.60	6.30
4	#5725.00	47.7 AV	54.0	-6.3	1.02 H	321	41.40	6.30
5	11400.00	59.9 PK	74.0	-14.1	1.00 H	53	40.20	19.70
6	11400.00	47.4 AV	54.0	-6.6	1.00 H	53	27.70	19.70

**ANTENNA POLARITY & TEST DISTANCE: VERTICAL AT 3 M**

NO.	FREQ. (MHz)	EMISSION LEVEL (dBuV/m)	LIMIT (dBuV/m)	MARGIN (dB)	ANTENNA HEIGHT (m)	TABLE ANGLE (Degree)	RAW VALUE (dBuV)	CORRECTION FACTOR (dB/m)
1	*5700.00	117.3 PK			1.52 V	8	77.00	40.30
2	*5700.00	107.6 AV			1.52 V	8	67.30	40.30
3	#5725.00	69.4 PK	74.0	-4.6	1.52 V	7	63.10	6.30
4	#5725.00	53.5 AV	54.0	-0.5	1.52 V	7	47.20	6.30
5	11400.00	60.3 PK	74.0	-13.7	1.04 V	14	40.60	19.70
6	11400.00	48.3 AV	54.0	-5.7	1.04 V	14	28.60	19.70

**REMARKS:**

1. Emission Level(dBuV/m) = Raw Value(dBuV) + Correction Factor(dB/m)
2. Correction Factor(dB/m) = Antenna Factor(dB/m) + Cable Factor(dB) – Pre-Amplifier Factor(dB)
3. The other emission levels were very low against the limit.
4. Margin value = Emission Level – Limit value
5. " \* ": Fundamental frequency.
6. " # ": The radiated frequency is out of the restricted band.

802.11n (HT20)

CHANNEL	TX Channel 52	DETECTOR FUNCTION	Peak (PK)
FREQUENCY RANGE	1GHz ~ 40GHz		Average (AV)

ANTENNA POLARITY & TEST DISTANCE: HORIZONTAL AT 3 M								
NO.	FREQ. (MHz)	EMISSION LEVEL (dBuV/m)	LIMIT (dBuV/m)	MARGIN (dB)	ANTENNA HEIGHT (m)	TABLE ANGLE (Degree)	RAW VALUE (dBuV)	CORRECTION FACTOR (dB/m)
1	5150.00	57.1 PK	74.0	-16.9	1.00 H	297	51.60	5.50
2	5150.00	43.6 AV	54.0	-10.4	1.00 H	297	38.10	5.50
3	*5260.00	106.3 PK			1.83 H	340	66.70	39.60
4	*5260.00	95.5 AV			1.83 H	340	55.90	39.60
5	#10520.00	59.8 PK	74.0	-14.2	1.00 H	287	41.70	18.10
6	#10520.00	46.3 AV	54.0	-7.7	1.00 H	287	28.20	18.10

ANTENNA POLARITY & TEST DISTANCE: VERTICAL AT 3 M								
NO.	FREQ. (MHz)	EMISSION LEVEL (dBuV/m)	LIMIT (dBuV/m)	MARGIN (dB)	ANTENNA HEIGHT (m)	TABLE ANGLE (Degree)	RAW VALUE (dBuV)	CORRECTION FACTOR (dB/m)
1	5150.00	57.0 PK	74.0	-17.0	1.00 V	341	51.50	5.50
2	5150.00	43.7 AV	54.0	-10.3	1.00 V	341	38.20	5.50
3	*5260.00	113.4 PK			1.87 V	7	73.80	39.60
4	*5260.00	102.7 AV			1.87 V	7	63.10	39.60
5	#10520.00	59.6 PK	74.0	-14.4	1.00 V	205	41.50	18.10
6	#10520.00	46.4 AV	54.0	-7.6	1.00 V	205	28.30	18.10

REMARKS:

1. Emission Level(dBuV/m) = Raw Value(dBuV) + Correction Factor(dB/m)
2. Correction Factor(dB/m) = Antenna Factor(dB/m) + Cable Factor(dB) – Pre-Amplifier Factor(dB)
3. The other emission levels were very low against the limit.
4. Margin value = Emission Level – Limit value
5. " \* ": Fundamental frequency.
6. " # ": The radiated frequency is out of the restricted band.

CHANNEL	TX Channel 60	DETECTOR FUNCTION	Peak (PK)
FREQUENCY RANGE	1GHz ~ 40GHz		Average (AV)

**ANTENNA POLARITY & TEST DISTANCE: HORIZONTAL AT 3 M**

NO.	FREQ. (MHz)	EMISSION LEVEL (dBuV/m)	LIMIT (dBuV/m)	MARGIN (dB)	ANTENNA HEIGHT (m)	TABLE ANGLE (Degree)	RAW VALUE (dBuV)	CORRECTION FACTOR (dB/m)
1	*5300.00	107.1 PK			1.35 H	333	67.50	39.60
2	*5300.00	96.3 AV			1.35 H	333	56.70	39.60
3	10600.00	60.1 PK	74.0	-13.9	1.00 H	121	41.70	18.40
4	10600.00	46.9 AV	54.0	-7.1	1.00 H	121	28.50	18.40

**ANTENNA POLARITY & TEST DISTANCE: VERTICAL AT 3 M**

NO.	FREQ. (MHz)	EMISSION LEVEL (dBuV/m)	LIMIT (dBuV/m)	MARGIN (dB)	ANTENNA HEIGHT (m)	TABLE ANGLE (Degree)	RAW VALUE (dBuV)	CORRECTION FACTOR (dB/m)
1	*5300.00	113.9 PK			1.79 V	14	74.30	39.60
2	*5300.00	103.7 AV			1.79 V	14	64.10	39.60
3	10600.00	60.8 PK	74.0	-13.2	1.00 V	77	42.40	18.40
4	10600.00	46.7 AV	54.0	-7.3	1.00 V	77	28.30	18.40

**REMARKS:**

1. Emission Level(dBuV/m) = Raw Value(dBuV) + Correction Factor(dB/m)
2. Correction Factor(dB/m) = Antenna Factor(dB/m) + Cable Factor(dB) – Pre-Amplifier Factor(dB)
3. The other emission levels were very low against the limit.
4. Margin value = Emission Level – Limit value
5. " \* ": Fundamental frequency.

CHANNEL	TX Channel 64	DETECTOR FUNCTION	Peak (PK)
FREQUENCY RANGE	1GHz ~ 40GHz		Average (AV)

**ANTENNA POLARITY & TEST DISTANCE: HORIZONTAL AT 3 M**

NO.	FREQ. (MHz)	EMISSION LEVEL (dBuV/m)	LIMIT (dBuV/m)	MARGIN (dB)	ANTENNA HEIGHT (m)	TABLE ANGLE (Degree)	RAW VALUE (dBuV)	CORRECTION FACTOR (dB/m)
1	*5320.00	107.8 PK			1.50 H	335	68.10	39.70
2	*5320.00	97.3 AV			1.50 H	335	57.60	39.70
3	5350.00	57.5 PK	74.0	-16.5	1.31 H	324	51.80	5.70
4	5350.00	44.4 AV	54.0	-9.6	1.31 H	324	38.70	5.70
5	10640.00	60.2 PK	74.0	-13.8	1.00 H	252	41.80	18.40
6	10640.00	46.5 AV	54.0	-7.5	1.00 H	252	28.10	18.40

**ANTENNA POLARITY & TEST DISTANCE: VERTICAL AT 3 M**

NO.	FREQ. (MHz)	EMISSION LEVEL (dBuV/m)	LIMIT (dBuV/m)	MARGIN (dB)	ANTENNA HEIGHT (m)	TABLE ANGLE (Degree)	RAW VALUE (dBuV)	CORRECTION FACTOR (dB/m)
1	*5320.00	113.9 PK			1.78 V	13	74.20	39.70
2	*5320.00	103.9 AV			1.78 V	13	64.20	39.70
3	5350.00	59.7 PK	74.0	-14.3	1.45 V	9	54.00	5.70
4	5350.00	46.0 AV	54.0	-8.0	1.45 V	9	40.30	5.70
5	10640.00	61.0 PK	74.0	-13.0	1.00 V	69	42.60	18.40
6	10640.00	47.0 AV	54.0	-7.0	1.00 V	69	28.60	18.40

**REMARKS:**

1. Emission Level(dBuV/m) = Raw Value(dBuV) + Correction Factor(dB/m)
2. Correction Factor(dB/m) = Antenna Factor(dB/m) + Cable Factor(dB) – Pre-Amplifier Factor(dB)
3. The other emission levels were very low against the limit.
4. Margin value = Emission Level – Limit value
5. " \* ": Fundamental frequency.

CHANNEL	TX Channel 100	DETECTOR FUNCTION	Peak (PK)
FREQUENCY RANGE	1GHz ~ 40GHz		Average (AV)

**ANTENNA POLARITY & TEST DISTANCE: HORIZONTAL AT 3 M**

NO.	FREQ. (MHz)	EMISSION LEVEL (dBuV/m)	LIMIT (dBuV/m)	MARGIN (dB)	ANTENNA HEIGHT (m)	TABLE ANGLE (Degree)	RAW VALUE (dBuV)	CORRECTION FACTOR (dB/m)
1	5460.00	56.6 PK	74.0	-17.4	1.09 H	325	50.80	5.80
2	5460.00	44.3 AV	54.0	-9.7	1.09 H	325	38.50	5.80
3	#5470.00	55.9 PK	74.0	-18.1	1.16 H	342	50.00	5.90
4	#5470.00	44.4 AV	54.0	-9.6	1.16 H	342	38.50	5.90
5	*5500.00	105.8 PK			1.18 H	47	65.90	39.90
6	*5500.00	95.5 AV			1.18 H	47	55.60	39.90
7	11000.00	59.6 PK	74.0	-14.4	1.12 H	74	40.70	18.90
8	11000.00	46.8 AV	54.0	-7.2	1.12 H	74	27.90	18.90

**ANTENNA POLARITY & TEST DISTANCE: VERTICAL AT 3 M**

NO.	FREQ. (MHz)	EMISSION LEVEL (dBuV/m)	LIMIT (dBuV/m)	MARGIN (dB)	ANTENNA HEIGHT (m)	TABLE ANGLE (Degree)	RAW VALUE (dBuV)	CORRECTION FACTOR (dB/m)
1	5460.00	58.6 PK	74.0	-15.4	1.43 V	6	52.80	5.80
2	5460.00	46.1 AV	54.0	-7.9	1.43 V	6	40.30	5.80
3	#5470.00	58.7 PK	74.0	-15.3	1.64 V	8	52.80	5.90
4	#5470.00	46.8 AV	54.0	-7.2	1.64 V	8	40.90	5.90
5	*5500.00	113.2 PK			1.42 V	10	73.30	39.90
6	*5500.00	103.7 AV			1.42 V	10	63.80	39.90
7	11000.00	60.8 PK	74.0	-13.2	1.23 V	54	41.90	18.90
8	11000.00	46.9 AV	54.0	-7.1	1.23 V	54	28.00	18.90

**REMARKS:**

1. Emission Level(dBuV/m) = Raw Value(dBuV) + Correction Factor(dB/m)
2. Correction Factor(dB/m) = Antenna Factor(dB/m) + Cable Factor(dB) – Pre-Amplifier Factor(dB)
3. The other emission levels were very low against the limit.
4. Margin value = Emission Level – Limit value
5. " \* ": Fundamental frequency.
6. " # ": The radiated frequency is out of the restricted band.

CHANNEL	TX Channel 116	DETECTOR FUNCTION	Peak (PK)
FREQUENCY RANGE	1GHz ~ 40GHz		Average (AV)

**ANTENNA POLARITY & TEST DISTANCE: HORIZONTAL AT 3 M**

NO.	FREQ. (MHz)	EMISSION LEVEL (dBuV/m)	LIMIT (dBuV/m)	MARGIN (dB)	ANTENNA HEIGHT (m)	TABLE ANGLE (Degree)	RAW VALUE (dBuV)	CORRECTION FACTOR (dB/m)
1	*5580.00	105.5 PK			1.14 H	38	65.60	39.90
2	*5580.00	95.4 AV			1.14 H	38	55.50	39.90
3	11160.00	61.0 PK	74.0	-13.0	1.00 H	201	41.80	19.20
4	11160.00	47.5 AV	54.0	-6.5	1.00 H	201	28.30	19.20

**ANTENNA POLARITY & TEST DISTANCE: VERTICAL AT 3 M**

NO.	FREQ. (MHz)	EMISSION LEVEL (dBuV/m)	LIMIT (dBuV/m)	MARGIN (dB)	ANTENNA HEIGHT (m)	TABLE ANGLE (Degree)	RAW VALUE (dBuV)	CORRECTION FACTOR (dB/m)
1	*5580.00	112.8 PK			1.06 V	9	72.90	39.90
2	*5580.00	103.1 AV			1.06 V	9	63.20	39.90
3	11160.00	60.9 PK	74.0	-13.1	1.00 V	227	41.70	19.20
4	11160.00	47.6 AV	54.0	-6.4	1.00 V	227	28.40	19.20

**REMARKS:**

1. Emission Level(dBuV/m) = Raw Value(dBuV) + Correction Factor(dB/m)
2. Correction Factor(dB/m) = Antenna Factor(dB/m) + Cable Factor(dB) – Pre-Amplifier Factor(dB)
3. The other emission levels were very low against the limit.
4. Margin value = Emission Level – Limit value
5. " \* ": Fundamental frequency.

CHANNEL	TX Channel 140	DETECTOR FUNCTION	Peak (PK)
FREQUENCY RANGE	1GHz ~ 40GHz		Average (AV)

**ANTENNA POLARITY & TEST DISTANCE: HORIZONTAL AT 3 M**

NO.	FREQ. (MHz)	EMISSION LEVEL (dBuV/m)	LIMIT (dBuV/m)	MARGIN (dB)	ANTENNA HEIGHT (m)	TABLE ANGLE (Degree)	RAW VALUE (dBuV)	CORRECTION FACTOR (dB/m)
1	*5700.00	105.2 PK			1.00 H	335	64.90	40.30
2	*5700.00	94.7 AV			1.00 H	335	54.40	40.30
3	#5725.00	56.0 PK	74.0	-18.0	1.23 H	338	49.70	6.30
4	#5725.00	44.1 AV	54.0	-9.9	1.23 H	338	37.80	6.30
5	11400.00	61.5 PK	74.0	-12.5	1.10 H	267	41.80	19.70
6	11400.00	48.8 AV	54.0	-5.2	1.10 H	267	29.10	19.70

**ANTENNA POLARITY & TEST DISTANCE: VERTICAL AT 3 M**

NO.	FREQ. (MHz)	EMISSION LEVEL (dBuV/m)	LIMIT (dBuV/m)	MARGIN (dB)	ANTENNA HEIGHT (m)	TABLE ANGLE (Degree)	RAW VALUE (dBuV)	CORRECTION FACTOR (dB/m)
1	*5700.00	111.6 PK			1.27 V	8	71.30	40.30
2	*5700.00	101.6 AV			1.27 V	8	61.30	40.30
3	#5725.00	59.0 PK	74.0	-15.0	1.92 V	3	52.70	6.30
4	#5725.00	47.1 AV	54.0	-6.9	1.92 V	3	40.80	6.30
5	11400.00	62.6 PK	74.0	-11.4	1.00 V	155	42.90	19.70
6	11400.00	48.9 AV	54.0	-5.1	1.00 V	155	29.20	19.70

**REMARKS:**

1. Emission Level(dBuV/m) = Raw Value(dBuV) + Correction Factor(dB/m)
2. Correction Factor(dB/m) = Antenna Factor(dB/m) + Cable Factor(dB) – Pre-Amplifier Factor(dB)
3. The other emission levels were very low against the limit.
4. Margin value = Emission Level – Limit value
5. " \* ": Fundamental frequency.
6. " # ": The radiated frequency is out of the restricted band.

**802.11n (HT40)**

CHANNEL	TX Channel 54	DETECTOR FUNCTION	Peak (PK)
FREQUENCY RANGE	1GHz ~ 40GHz		Average (AV)

ANTENNA POLARITY & TEST DISTANCE: HORIZONTAL AT 3 M								
NO.	FREQ. (MHz)	EMISSION LEVEL (dBuV/m)	LIMIT (dBuV/m)	MARGIN (dB)	ANTENNA HEIGHT (m)	TABLE ANGLE (Degree)	RAW VALUE (dBuV)	CORRECTION FACTOR (dB/m)
1	5150.00	56.2 PK	74.0	-17.8	1.14 H	283	50.70	5.50
2	5150.00	43.7 AV	54.0	-10.3	1.14 H	283	38.20	5.50
3	*5270.00	105.3 PK			1.59 H	331	65.70	39.60
4	*5270.00	94.8 AV			1.59 H	331	55.20	39.60
5	#10540.00	59.9 PK	74.0	-14.1	1.26 H	222	41.80	18.10
6	#10540.00	46.7 AV	54.0	-7.3	1.26 H	222	28.60	18.10

ANTENNA POLARITY & TEST DISTANCE: VERTICAL AT 3 M								
NO.	FREQ. (MHz)	EMISSION LEVEL (dBuV/m)	LIMIT (dBuV/m)	MARGIN (dB)	ANTENNA HEIGHT (m)	TABLE ANGLE (Degree)	RAW VALUE (dBuV)	CORRECTION FACTOR (dB/m)
1	5150.00	56.2 PK	74.0	-17.8	1.10 V	272	50.70	5.50
2	5150.00	43.9 AV	54.0	-10.1	1.10 V	272	38.40	5.50
3	*5270.00	111.3 PK			1.78 V	16	71.70	39.60
4	*5270.00	101.4 AV			1.78 V	16	61.80	39.60
5	#10540.00	60.1 PK	74.0	-13.9	1.42 V	88	42.00	18.10
6	#10540.00	46.8 AV	54.0	-7.2	1.42 V	88	28.70	18.10

**REMARKS:**

1. Emission Level(dBuV/m) = Raw Value(dBuV) + Correction Factor(dB/m)
2. Correction Factor(dB/m) = Antenna Factor(dB/m) + Cable Factor(dB) – Pre-Amplifier Factor(dB)
3. The other emission levels were very low against the limit.
4. Margin value = Emission Level – Limit value
5. " \* ": Fundamental frequency.
6. " # ": The radiated frequency is out of the restricted band.



CHANNEL	TX Channel 62	DETECTOR FUNCTION	Peak (PK)
FREQUENCY RANGE	1GHz ~ 40GHz		Average (AV)

**ANTENNA POLARITY & TEST DISTANCE: HORIZONTAL AT 3 M**

NO.	FREQ. (MHz)	EMISSION LEVEL (dBuV/m)	LIMIT (dBuV/m)	MARGIN (dB)	ANTENNA HEIGHT (m)	TABLE ANGLE (Degree)	RAW VALUE (dBuV)	CORRECTION FACTOR (dB/m)
1	*5310.00	104.1 PK			1.79 H	331	64.50	39.60
2	*5310.00	94.0 AV			1.79 H	331	54.40	39.60
3	5350.00	58.6 PK	74.0	-15.4	1.29 H	334	52.90	5.70
4	5350.00	46.1 AV	54.0	-7.9	1.29 H	334	40.40	5.70
5	10620.00	60.3 PK	74.0	-13.7	1.37 H	291	42.00	18.30
6	10620.00	47.1 AV	54.0	-6.9	1.37 H	291	28.80	18.30

**ANTENNA POLARITY & TEST DISTANCE: VERTICAL AT 3 M**

NO.	FREQ. (MHz)	EMISSION LEVEL (dBuV/m)	LIMIT (dBuV/m)	MARGIN (dB)	ANTENNA HEIGHT (m)	TABLE ANGLE (Degree)	RAW VALUE (dBuV)	CORRECTION FACTOR (dB/m)
1	*5310.00	109.8 PK			1.83 V	5	70.20	39.60
2	*5310.00	99.9 AV			1.83 V	5	60.30	39.60
3	5350.00	61.6 PK	74.0	-12.4	1.30 V	21	55.90	5.70
4	5350.00	49.0 AV	54.0	-5.0	1.30 V	21	43.30	5.70
5	10620.00	59.9 PK	74.0	-14.1	1.44 V	346	41.60	18.30
6	10620.00	47.5 AV	54.0	-6.5	1.44 V	346	29.20	18.30

**REMARKS:**

1. Emission Level(dBuV/m) = Raw Value(dBuV) + Correction Factor(dB/m)
2. Correction Factor(dB/m) = Antenna Factor(dB/m) + Cable Factor(dB) – Pre-Amplifier Factor(dB)
3. The other emission levels were very low against the limit.
4. Margin value = Emission Level – Limit value
5. " \* ": Fundamental frequency.

CHANNEL	TX Channel 102	DETECTOR FUNCTION	Peak (PK)
FREQUENCY RANGE	1GHz ~ 40GHz		Average (AV)

**ANTENNA POLARITY & TEST DISTANCE: HORIZONTAL AT 3 M**

NO.	FREQ. (MHz)	EMISSION LEVEL (dBuV/m)	LIMIT (dBuV/m)	MARGIN (dB)	ANTENNA HEIGHT (m)	TABLE ANGLE (Degree)	RAW VALUE (dBuV)	CORRECTION FACTOR (dB/m)
1	5460.00	56.5 PK	74.0	-17.5	1.38 H	311	50.70	5.80
2	5460.00	44.6 AV	54.0	-9.4	1.38 H	311	38.80	5.80
3	#5470.00	58.0 PK	74.0	-16.0	1.43 H	323	52.10	5.90
4	#5470.00	45.2 AV	54.0	-8.8	1.43 H	323	39.30	5.90
5	*5510.00	103.2 PK			1.21 H	49	63.30	39.90
6	*5510.00	92.8 AV			1.21 H	49	52.90	39.90
7	11020.00	60.2 PK	74.0	-13.8	1.11 H	99	41.20	19.00
8	11020.00	47.3 AV	54.0	-6.7	1.11 H	99	28.30	19.00

**ANTENNA POLARITY & TEST DISTANCE: VERTICAL AT 3 M**

NO.	FREQ. (MHz)	EMISSION LEVEL (dBuV/m)	LIMIT (dBuV/m)	MARGIN (dB)	ANTENNA HEIGHT (m)	TABLE ANGLE (Degree)	RAW VALUE (dBuV)	CORRECTION FACTOR (dB/m)
1	5460.00	59.5 PK	74.0	-14.5	1.49 V	9	53.70	5.80
2	5460.00	47.6 AV	54.0	-6.4	1.49 V	9	41.80	5.80
3	#5470.00	63.6 PK	74.0	-10.4	1.63 V	2	57.70	5.90
4	#5470.00	50.3 AV	54.0	-3.7	1.63 V	2	44.40	5.90
5	*5510.00	110.5 PK			1.39 V	11	70.60	39.90
6	*5510.00	100.5 AV			1.39 V	11	60.60	39.90
7	11020.00	60.3 PK	74.0	-13.7	1.22 V	104	41.30	19.00
8	11020.00	47.2 AV	54.0	-6.8	1.22 V	104	28.20	19.00

**REMARKS:**

1. Emission Level(dBuV/m) = Raw Value(dBuV) + Correction Factor(dB/m)
2. Correction Factor(dB/m) = Antenna Factor(dB/m) + Cable Factor(dB) – Pre-Amplifier Factor(dB)
3. The other emission levels were very low against the limit.
4. Margin value = Emission Level – Limit value
5. " \* ": Fundamental frequency.
6. " # ": The radiated frequency is out of the restricted band.

CHANNEL	TX Channel 110	DETECTOR FUNCTION	Peak (PK)
FREQUENCY RANGE	1GHz ~ 40GHz		Average (AV)

**ANTENNA POLARITY & TEST DISTANCE: HORIZONTAL AT 3 M**

NO.	FREQ. (MHz)	EMISSION LEVEL (dBuV/m)	LIMIT (dBuV/m)	MARGIN (dB)	ANTENNA HEIGHT (m)	TABLE ANGLE (Degree)	RAW VALUE (dBuV)	CORRECTION FACTOR (dB/m)
1	*5550.00	103.3 PK			1.15 H	334	63.30	40.00
2	*5550.00	92.6 AV			1.15 H	334	52.60	40.00
3	11100.00	60.9 PK	74.0	-13.1	1.00 H	319	41.30	19.60
4	11100.00	48.1 AV	54.0	-5.9	1.00 H	319	28.50	19.60

**ANTENNA POLARITY & TEST DISTANCE: VERTICAL AT 3 M**

NO.	FREQ. (MHz)	EMISSION LEVEL (dBuV/m)	LIMIT (dBuV/m)	MARGIN (dB)	ANTENNA HEIGHT (m)	TABLE ANGLE (Degree)	RAW VALUE (dBuV)	CORRECTION FACTOR (dB/m)
1	*5550.00	110.2 PK			1.26 V	12	70.20	40.00
2	*5550.00	100.1 AV			1.26 V	12	60.10	40.00
3	11100.00	61.6 PK	74.0	-12.4	1.00 V	44	42.00	19.60
4	11100.00	48.2 AV	54.0	-5.8	1.00 V	44	28.60	19.60

**REMARKS:**

1. Emission Level(dBuV/m) = Raw Value(dBuV) + Correction Factor(dB/m)
2. Correction Factor(dB/m) = Antenna Factor(dB/m) + Cable Factor(dB) – Pre-Amplifier Factor(dB)
3. The other emission levels were very low against the limit.
4. Margin value = Emission Level – Limit value
5. " \* ": Fundamental frequency.

CHANNEL	TX Channel 134	DETECTOR FUNCTION	Peak (PK)
FREQUENCY RANGE	1GHz ~ 40GHz		Average (AV)

**ANTENNA POLARITY & TEST DISTANCE: HORIZONTAL AT 3 M**

NO.	FREQ. (MHz)	EMISSION LEVEL (dBuV/m)	LIMIT (dBuV/m)	MARGIN (dB)	ANTENNA HEIGHT (m)	TABLE ANGLE (Degree)	RAW VALUE (dBuV)	CORRECTION FACTOR (dB/m)
1	*5670.00	102.2 PK			1.00 H	336	62.00	40.20
2	*5670.00	92.3 AV			1.00 H	336	52.10	40.20
3	#5725.00	56.6 PK	74.0	-17.4	1.08 H	317	50.30	6.30
4	#5725.00	44.2 AV	54.0	-9.8	1.08 H	317	37.90	6.30
5	11340.00	61.6 PK	74.0	-12.4	1.16 H	277	41.90	19.70
6	11340.00	48.7 AV	54.0	-5.3	1.16 H	277	29.00	19.70

**ANTENNA POLARITY & TEST DISTANCE: VERTICAL AT 3 M**

NO.	FREQ. (MHz)	EMISSION LEVEL (dBuV/m)	LIMIT (dBuV/m)	MARGIN (dB)	ANTENNA HEIGHT (m)	TABLE ANGLE (Degree)	RAW VALUE (dBuV)	CORRECTION FACTOR (dB/m)
1	*5670.00	109.6 PK			1.36 V	12	69.40	40.20
2	*5670.00	99.6 AV			1.36 V	12	59.40	40.20
3	#5725.00	58.6 PK	74.0	-15.4	1.77 V	6	52.30	6.30
4	#5725.00	45.8 AV	54.0	-8.2	1.77 V	6	39.50	6.30
5	11340.00	62.1 PK	74.0	-11.9	1.19 V	60	42.40	19.70
6	11340.00	48.7 AV	54.0	-5.3	1.19 V	60	29.00	19.70

**REMARKS:**

1. Emission Level(dBuV/m) = Raw Value(dBuV) + Correction Factor(dB/m)
2. Correction Factor(dB/m) = Antenna Factor(dB/m) + Cable Factor(dB) – Pre-Amplifier Factor(dB)
3. The other emission levels were very low against the limit.
4. Margin value = Emission Level – Limit value
5. " \* ": Fundamental frequency.
6. " # ": The radiated frequency is out of the restricted band.

**802.11ac (VHT80)**

CHANNEL	TX Channel 58	DETECTOR FUNCTION	Peak (PK)
FREQUENCY RANGE	1GHz ~ 40GHz		Average (AV)

ANTENNA POLARITY & TEST DISTANCE: HORIZONTAL AT 3 M								
NO.	FREQ. (MHz)	EMISSION LEVEL (dBuV/m)	LIMIT (dBuV/m)	MARGIN (dB)	ANTENNA HEIGHT (m)	TABLE ANGLE (Degree)	RAW VALUE (dBuV)	CORRECTION FACTOR (dB/m)
1	*5290.00	102.2 PK			1.67 H	335	62.60	39.60
2	*5290.00	90.5 AV			1.67 H	335	50.90	39.60
3	5350.00	71.6 PK	74.0	-2.4	1.40 H	328	65.90	5.70
4	5350.00	48.1 AV	54.0	-5.9	1.40 H	328	42.40	5.70
5	#10580.00	60.4 PK	74.0	-13.6	1.35 H	292	42.10	18.30
6	#10580.00	47.1 AV	54.0	-6.9	1.35 H	292	28.80	18.30

ANTENNA POLARITY & TEST DISTANCE: VERTICAL AT 3 M								
NO.	FREQ. (MHz)	EMISSION LEVEL (dBuV/m)	LIMIT (dBuV/m)	MARGIN (dB)	ANTENNA HEIGHT (m)	TABLE ANGLE (Degree)	RAW VALUE (dBuV)	CORRECTION FACTOR (dB/m)
1	*5290.00	109.5 PK			1.71 V	5	69.90	39.60
2	*5290.00	96.2 AV			1.71 V	5	56.60	39.60
3	5350.00	73.8 PK	74.0	-0.2	1.67 V	18	68.10	5.70
4	5350.00	49.0 AV	54.0	-5.0	1.67 V	18	43.30	5.70
5	#10580.00	60.6 PK	74.0	-13.4	1.36 V	93	42.30	18.30
6	#10580.00	47.1 AV	54.0	-6.9	1.36 V	93	28.80	18.30

**REMARKS:**

1. Emission Level(dBuV/m) = Raw Value(dBuV) + Correction Factor(dB/m)
2. Correction Factor(dB/m) = Antenna Factor(dB/m) + Cable Factor(dB) – Pre-Amplifier Factor(dB)
3. The other emission levels were very low against the limit.
4. Margin value = Emission Level – Limit value
5. " \* ": Fundamental frequency.
6. " # ": The radiated frequency is out of the restricted band.

CHANNEL	TX Channel 106	DETECTOR FUNCTION	Peak (PK)
FREQUENCY RANGE	1GHz ~ 40GHz		Average (AV)

**ANTENNA POLARITY & TEST DISTANCE: HORIZONTAL AT 3 M**

NO.	FREQ. (MHz)	EMISSION LEVEL (dBuV/m)	LIMIT (dBuV/m)	MARGIN (dB)	ANTENNA HEIGHT (m)	TABLE ANGLE (Degree)	RAW VALUE (dBuV)	CORRECTION FACTOR (dB/m)
1	5460.00	65.5 PK	74.0	-8.5	1.28 H	70	59.70	5.80
2	5460.00	45.2 AV	54.0	-8.8	1.28 H	70	39.40	5.80
3	#5470.00	64.0 PK	74.0	-10.0	1.35 H	44	58.10	5.90
4	#5470.00	45.2 AV	54.0	-8.8	1.35 H	44	39.30	5.90
5	*5530.00	100.1 PK			1.22 H	33	60.20	39.90
6	*5530.00	89.3 AV			1.22 H	33	49.40	39.90
7	11060.00	60.9 PK	74.0	-13.1	1.05 H	109	41.70	19.20
8	11060.00	47.9 AV	54.0	-6.1	1.05 H	109	28.70	19.20

**ANTENNA POLARITY & TEST DISTANCE: VERTICAL AT 3 M**

NO.	FREQ. (MHz)	EMISSION LEVEL (dBuV/m)	LIMIT (dBuV/m)	MARGIN (dB)	ANTENNA HEIGHT (m)	TABLE ANGLE (Degree)	RAW VALUE (dBuV)	CORRECTION FACTOR (dB/m)
1	5460.00	73.5 PK	74.0	-0.5	1.64 V	5	67.70	5.80
2	5460.00	49.4 AV	54.0	-4.6	1.64 V	5	43.60	5.80
3	#5470.00	68.1 PK	74.0	-5.9	1.77 V	10	62.20	5.90
4	#5470.00	50.1 AV	54.0	-3.9	1.77 V	10	44.20	5.90
5	*5530.00	107.3 PK			1.47 V	9	67.40	39.90
6	*5530.00	96.6 AV			1.47 V	9	56.70	39.90
7	11060.00	60.8 PK	74.0	-13.2	1.32 V	71	41.60	19.20
8	11060.00	47.9 AV	54.0	-6.1	1.32 V	71	28.70	19.20

**REMARKS:**

1. Emission Level(dBuV/m) = Raw Value(dBuV) + Correction Factor(dB/m)
2. Correction Factor(dB/m) = Antenna Factor(dB/m) + Cable Factor(dB) – Pre-Amplifier Factor(dB)
3. The other emission levels were very low against the limit.
4. Margin value = Emission Level – Limit value
5. " \* ": Fundamental frequency.
6. " # ": The radiated frequency is out of the restricted band.

Below 1GHz worst-case data:

Test Mode A

802.11a

CHANNEL	TX Channel 52	DETECTOR FUNCTION	Quasi-Peak (QP)
FREQUENCY RANGE	9kHz ~ 1GHz		

ANTENNA POLARITY & TEST DISTANCE: HORIZONTAL AT 3 M								
NO.	FREQ. (MHz)	EMISSION LEVEL (dBuV/m)	LIMIT (dBuV/m)	MARGIN (dB)	ANTENNA HEIGHT (m)	TABLE ANGLE (Degree)	RAW VALUE (dBuV)	CORRECTION FACTOR (dB/m)
1	99.85	36.0 QP	43.5	-7.5	1.25 H	10	54.60	-18.60
2	165.08	34.8 QP	43.5	-8.7	1.50 H	160	48.80	-14.00
3	390.41	34.1 QP	46.0	-11.9	1.00 H	220	45.40	-11.30
4	587.15	30.5 QP	46.0	-15.5	1.50 H	165	38.20	-7.70
5	795.62	30.8 QP	46.0	-15.2	1.51 H	350	34.00	-3.20
6	936.15	37.4 QP	46.0	-8.6	1.25 H	226	38.40	-1.00
ANTENNA POLARITY & TEST DISTANCE: VERTICAL AT 3 M								
NO.	FREQ. (MHz)	EMISSION LEVEL (dBuV/m)	LIMIT (dBuV/m)	MARGIN (dB)	ANTENNA HEIGHT (m)	TABLE ANGLE (Degree)	RAW VALUE (dBuV)	CORRECTION FACTOR (dB/m)
1	52.45	33.7 QP	40.0	-6.3	1.00 V	168	47.60	-13.90
2	165.74	35.3 QP	43.5	-8.2	1.00 V	169	49.40	-14.10
3	390.42	34.9 QP	46.0	-11.1	1.00 V	145	46.20	-11.30
4	586.54	32.4 QP	46.0	-13.6	1.25 V	170	40.10	-7.70
5	795.61	34.0 QP	46.0	-12.0	1.00 V	147	37.20	-3.20
6	936.04	38.5 QP	46.0	-7.5	1.00 V	168	39.50	-1.00

REMARKS:

1. Emission Level(dBuV/m) = Raw Value(dBuV) + Correction Factor(dB/m)
2. Correction Factor(dB/m) = Antenna Factor(dB/m) + Cable Factor(dB)
3. The other emission levels were very low against the limit.
4. Margin value = Emission Level – Limit value

Test Mode B

802.11a

CHANNEL	TX Channel 52	DETECTOR FUNCTION	Quasi-Peak (QP)
FREQUENCY RANGE	9kHz ~ 1GHz		

ANTENNA POLARITY & TEST DISTANCE: HORIZONTAL AT 3 M

NO.	FREQ. (MHz)	EMISSION LEVEL (dBuV/m)	LIMIT (dBuV/m)	MARGIN (dB)	ANTENNA HEIGHT (m)	TABLE ANGLE (Degree)	RAW VALUE (dBuV)	CORRECTION FACTOR (dB/m)
1	99.40	34.1 QP	43.5	-9.4	2.00 H	115	52.70	-18.60
2	165.34	35.3 QP	43.5	-8.2	1.25 H	136	49.30	-14.00
3	298.54	29.0 QP	46.0	-17.0	1.50 H	155	41.80	-12.80
4	500.07	26.5 QP	46.0	-19.5	2.00 H	240	35.90	-9.40
5	795.63	35.4 QP	46.0	-10.6	1.50 H	140	38.60	-3.20
6	936.51	36.8 QP	46.0	-9.2	2.00 H	140	37.80	-1.00

ANTENNA POLARITY & TEST DISTANCE: VERTICAL AT 3 M

NO.	FREQ. (MHz)	EMISSION LEVEL (dBuV/m)	LIMIT (dBuV/m)	MARGIN (dB)	ANTENNA HEIGHT (m)	TABLE ANGLE (Degree)	RAW VALUE (dBuV)	CORRECTION FACTOR (dB/m)
1	63.54	32.8 QP	40.0	-7.2	1.00 V	310	47.40	-14.60
2	105.54	31.5 QP	43.5	-12.0	1.50 V	260	49.10	-17.60
3	199.85	25.4 QP	43.5	-18.1	1.25 V	210	42.00	-16.60
4	395.41	22.8 QP	46.0	-23.2	1.50 V	144	34.00	-11.20
5	795.52	34.5 QP	46.0	-11.5	1.50 V	177	37.70	-3.20
6	937.54	37.5 QP	46.0	-8.5	1.50 V	124	38.50	-1.00

REMARKS:

1. Emission Level(dBuV/m) = Raw Value(dBuV) + Correction Factor(dB/m)
2. Correction Factor(dB/m) = Antenna Factor(dB/m) + Cable Factor(dB)
3. The other emission levels were very low against the limit.
4. Margin value = Emission Level – Limit value



Test Mode C

802.11a

CHANNEL	TX Channel 52	DETECTOR FUNCTION	Quasi-Peak (QP)
FREQUENCY RANGE	9kHz ~ 1GHz		

ANTENNA POLARITY & TEST DISTANCE: HORIZONTAL AT 3 M								
NO.	FREQ. (MHz)	EMISSION LEVEL (dBuV/m)	LIMIT (dBuV/m)	MARGIN (dB)	ANTENNA HEIGHT (m)	TABLE ANGLE (Degree)	RAW VALUE (dBuV)	CORRECTION FACTOR (dB/m)
1	51.24	14.6 QP	40.0	-25.4	1.99 H	201	28.50	-13.90
2	148.26	15.2 QP	43.5	-28.3	1.49 H	231	28.90	-13.70
3	425.74	18.9 QP	46.0	-27.1	1.99 H	126	29.50	-10.60
4	629.48	22.5 QP	46.0	-23.5	1.49 H	161	28.90	-6.40
5	745.91	24.4 QP	46.0	-21.6	1.00 H	327	28.30	-3.90
6	901.14	26.9 QP	46.0	-19.1	1.49 H	48	28.50	-1.60
ANTENNA POLARITY & TEST DISTANCE: VERTICAL AT 3 M								
NO.	FREQ. (MHz)	EMISSION LEVEL (dBuV/m)	LIMIT (dBuV/m)	MARGIN (dB)	ANTENNA HEIGHT (m)	TABLE ANGLE (Degree)	RAW VALUE (dBuV)	CORRECTION FACTOR (dB/m)
1	53.18	14.7 QP	40.0	-25.3	1.00 V	36	28.50	-13.80
2	148.26	14.8 QP	43.5	-28.7	1.99 V	208	28.50	-13.70
3	450.97	19.9 QP	46.0	-26.1	1.24 V	13	30.10	-10.20
4	518.88	21.2 QP	46.0	-24.8	1.00 V	181	30.30	-9.10
5	751.73	25.0 QP	46.0	-21.0	1.50 V	323	28.80	-3.80
6	901.14	26.9 QP	46.0	-19.1	1.00 V	7	28.50	-1.60

REMARKS:

1. Emission Level(dBuV/m) = Raw Value(dBuV) + Correction Factor(dB/m)
2. Correction Factor(dB/m) = Antenna Factor(dB/m) + Cable Factor(dB)
3. The other emission levels were very low against the limit.
4. Margin value = Emission Level – Limit value

Test Mode D

802.11a

CHANNEL	TX Channel 52	DETECTOR FUNCTION	Quasi-Peak (QP)
FREQUENCY RANGE	9kHz ~ 1GHz		

ANTENNA POLARITY & TEST DISTANCE: HORIZONTAL AT 3 M

NO.	FREQ. (MHz)	EMISSION LEVEL (dBuV/m)	LIMIT (dBuV/m)	MARGIN (dB)	ANTENNA HEIGHT (m)	TABLE ANGLE (Degree)	RAW VALUE (dBuV)	CORRECTION FACTOR (dB/m)
1	55.13	14.7 QP	40.0	-25.3	1.24 H	324	28.70	-14.00
2	154.09	15.6 QP	43.5	-27.9	1.49 H	75	29.20	-13.60
3	518.88	21.0 QP	46.0	-25.0	1.49 H	315	30.10	-9.10
4	720.68	23.9 QP	46.0	-22.1	1.49 H	63	28.80	-4.90
5	837.11	27.6 QP	46.0	-18.4	1.49 H	6	30.30	-2.70
6	897.26	43.7 QP	46.0	-2.3	1.99 H	193	45.40	-1.70

ANTENNA POLARITY & TEST DISTANCE: VERTICAL AT 3 M

NO.	FREQ. (MHz)	EMISSION LEVEL (dBuV/m)	LIMIT (dBuV/m)	MARGIN (dB)	ANTENNA HEIGHT (m)	TABLE ANGLE (Degree)	RAW VALUE (dBuV)	CORRECTION FACTOR (dB/m)
1	57.07	14.6 QP	40.0	-25.4	1.99 V	271	28.80	-14.20
2	148.26	14.5 QP	43.5	-29.0	1.50 V	242	28.20	-13.70
3	320.96	16.4 QP	46.0	-29.6	1.00 V	7	28.60	-12.20
4	408.28	18.5 QP	46.0	-27.5	1.50 V	80	29.50	-11.00
5	823.52	34.0 QP	46.0	-12.0	1.50 V	196	36.80	-2.80
6	897.26	31.9 QP	46.0	-14.1	1.25 V	351	33.60	-1.70

REMARKS:

1. Emission Level(dBuV/m) = Raw Value(dBuV) + Correction Factor(dB/m)
2. Correction Factor(dB/m) = Antenna Factor(dB/m) + Cable Factor(dB)
3. The other emission levels were very low against the limit.
4. Margin value = Emission Level – Limit value

## 4.2 Conducted Emission Measurement

### 4.2.1 Limits of Conducted Emission Measurement

Frequency (MHz)	Conducted Limit (dBuV)	
	Quasi-peak	Average
0.15 - 0.5	66 - 56	56 - 46
0.50 - 5.0	56	46
5.0 - 30.0	60	50

- Note:** 1. The lower limit shall apply at the transition frequencies.  
 2. The limit decreases in line with the logarithm of the frequency in the range of 0.15 to 0.50MHz.

### 4.2.2 Test Instruments

For Test Mode A, B

Description & Manufacturer	Model No.	Serial No.	Date Of Calibration	Due Date Of Calibration
Test Receiver ROHDE & SCHWARZ	ESCS 30	100288	Apr. 27, 2015	Apr. 26, 2016
RF signal cable (with 10dB PAD) Woken	5D-FB	Cable-cond2-01	Dec. 26, 2015	Dec. 25, 2016
LISN ROHDE & SCHWARZ (EUT)	ESH3-Z5	835239/001	Feb. 26, 2015	Feb. 25, 2016
LISN ROHDE & SCHWARZ (Peripheral)	ESH3-Z5	100312	Jul. 21, 2015	Jul. 20, 2016
Software ADT	BV ADT_Cond_ V7.3.7.3	NA	NA	NA

- Note:** 1. The calibration interval of the above test instruments is 12 months and the calibrations are traceable to NML/ROC and NIST/USA.  
 2. The test was performed in HwaYa Shielded Room 2.  
 3. The VCCI Site Registration No. is C-2047.

For Test Mode C, D

Description & Manufacturer	Model No.	Serial No.	Cal. Date	Cal. Due
Test Receiver ROHDE & SCHWARZ	ESCI	100613	Nov. 16, 2015	Nov. 15, 2016
RF signal cable (with 10dB PAD) Woken	5D-FB	Cable-cond1-01	Dec. 26, 2015	Dec. 25, 2016
LISN ROHDE & SCHWARZ (EUT)	ESH3-Z5	835239/001	Feb. 26, 2016	Feb. 25, 2017
LISN ROHDE & SCHWARZ (Peripheral)	ESH3-Z5	100311	Jul. 24, 2015	Jul. 23, 2016
Software ADT	BV ADT_Cond_ V7.3.7.3	NA	NA	NA

- Note: 1. The calibration interval of the above test instruments is 12 months and the calibrations are traceable to NML/ROC and NIST/USA.  
 2. The test was performed in HwaYa Shielded Room 1.  
 3. The VCCI Site Registration No. is C-2040.

#### 4.2.3 Test Procedures

- The EUT was placed 0.4 meters from the conducting wall of the shielded room with EUT being connected to the power mains through a line impedance stabilization network (LISN). Other support units were connected to the power mains through another LISN. The two LISNs provide 50 ohm/ 50uH of coupling impedance for the measuring instrument.
- Both lines of the power mains connected to the EUT were checked for maximum conducted interference.
- The frequency range from 150kHz to 30MHz was searched. Emission levels under (Limit - 20dB) was not recorded.

**NOTE:** The resolution bandwidth and video bandwidth of test receiver is 9kHz for quasi-peak detection (QP) and average detection (AV) at frequency 0.15MHz-30MHz.

#### 4.2.4 Deviation from Test Standard

No deviation.

#### 4.2.5 Test Setup

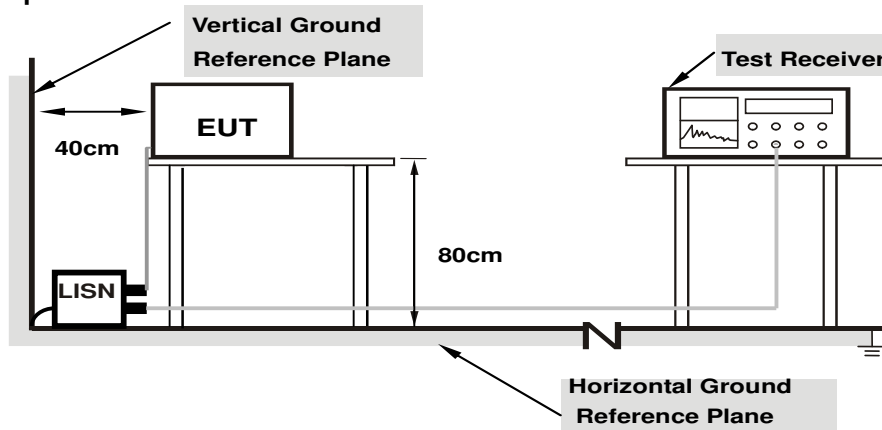

**Note: 1.Support units were connected to second LISN.**

For the actual test configuration, please refer to the attached file (Test Setup Photo).

#### 4.2.6 EUT Operating Conditions

Same as 4.1.6.

#### 4.2.7 Test Results

Phase	Line (L)	Detector Function	Quasi-Peak (QP) / Average (AV)
Test Mode	A		

No	Freq. [MHz]	Corr. Factor (dB)	Reading Value [dB (uV)]		Emission Level [dB (uV)]		Limit [dB (uV)]		Margin (dB)	
			Q.P.	AV.	Q.P.	AV.	Q.P.	AV.	Q.P.	AV.
			1	0.15000	10.10	39.67	30.74	49.77	40.84	66.00
<b>2</b>	<b>0.38828</b>	<b>10.15</b>	<b>38.87</b>	<b>34.67</b>	<b>49.02</b>	<b>44.82</b>	<b>58.10</b>	<b>48.10</b>	<b>-9.08</b>	<b>-3.28</b>
3	0.68906	10.17	23.07	14.60	33.24	24.77	56.00	46.00	-22.76	-21.23
4	1.53125	10.22	18.85	11.83	29.07	22.05	56.00	46.00	-26.93	-23.95
5	5.08984	10.35	14.97	8.17	25.32	18.52	60.00	50.00	-34.68	-31.48
6	11.85547	10.47	6.33	0.68	16.80	11.15	60.00	50.00	-43.20	-38.85

#### REMARKS:

1. Q.P. and AV. are abbreviations of quasi-peak and average individually.
2. The emission levels of other frequencies were very low against the limit.
3. Margin value = Emission level - Limit value
4. Correction factor = Insertion loss + Cable loss
5. Emission Level = Correction Factor + Reading Value.

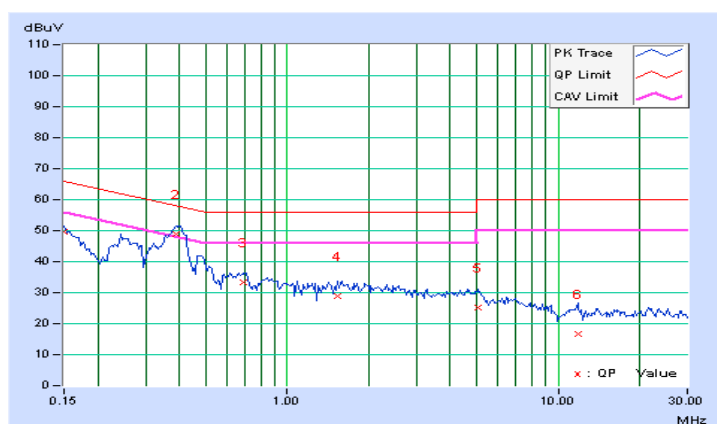

Phase	Neutral (N)	Detector Function	Quasi-Peak (QP) / Average (AV)
Test Mode	A		

No	Freq. [MHz]	Corr. Factor (dB)	Reading Value		Emission Level		Limit		Margin	
			[dB (uV)]		[dB (uV)]		[dB (uV)]		(dB)	
			Q.P.	AV.	Q.P.	AV.	Q.P.	AV.	Q.P.	AV.
1	0.15000	10.11	40.88	31.28	50.99	41.39	66.00	56.00	-15.01	-14.61
2	0.40000	10.17	39.40	30.12	49.57	40.29	57.85	47.85	-8.28	-7.56
3	0.70859	10.19	22.55	10.85	32.74	21.04	56.00	46.00	-23.26	-24.96
4	1.80859	10.26	18.12	11.62	28.38	21.88	56.00	46.00	-27.62	-24.12
5	4.71484	10.37	16.48	10.37	26.85	20.74	56.00	46.00	-29.15	-25.26
6	10.83984	10.55	11.05	6.13	21.60	16.68	60.00	50.00	-38.40	-33.32

**REMARKS:**

1. Q.P. and AV. are abbreviations of quasi-peak and average individually.
2. The emission levels of other frequencies were very low against the limit.
3. Margin value = Emission level - Limit value
4. Correction factor = Insertion loss + Cable loss
5. Emission Level = Correction Factor + Reading Value.

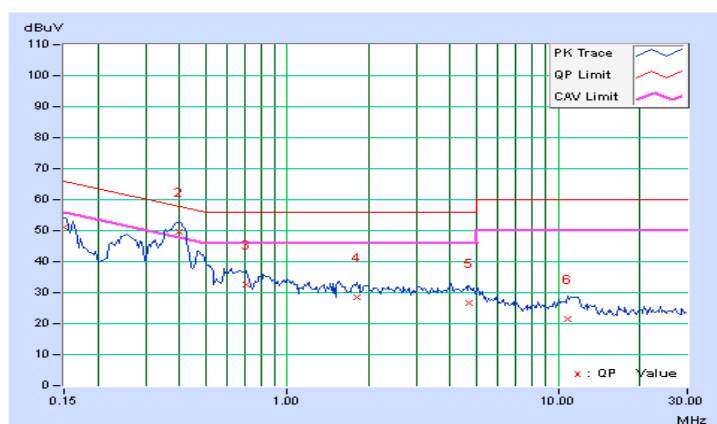

Phase	Line (L)	Detector Function	Quasi-Peak (QP) / Average (AV)
Test Mode	B		

No	Freq. [MHz]	Corr. Factor (dB)	Reading Value		Emission Level		Limit		Margin	
			[dB (uV)]		[dB (uV)]		[dB (uV)]		(dB)	
			Q.P.	AV.	Q.P.	AV.	Q.P.	AV.	Q.P.	AV.
1	0.15781	10.10	39.50	26.92	49.60	37.02	65.58	55.58	-15.98	-18.56
2	0.20078	10.11	34.20	26.07	44.31	36.18	63.58	53.58	-19.27	-17.40
3	0.40391	10.15	30.28	25.20	40.43	35.35	57.77	47.77	-17.34	-12.42
4	1.16016	10.20	18.39	11.57	28.59	21.77	56.00	46.00	-27.41	-24.23
5	9.64453	10.45	16.28	10.69	26.73	21.14	60.00	50.00	-33.27	-28.86
6	23.93750	10.49	21.87	16.44	32.36	26.93	60.00	50.00	-27.64	-23.07

**REMARKS:**

1. Q.P. and AV. are abbreviations of quasi-peak and average individually.
2. The emission levels of other frequencies were very low against the limit.
3. Margin value = Emission level - Limit value
4. Correction factor = Insertion loss + Cable loss
5. Emission Level = Correction Factor + Reading Value.

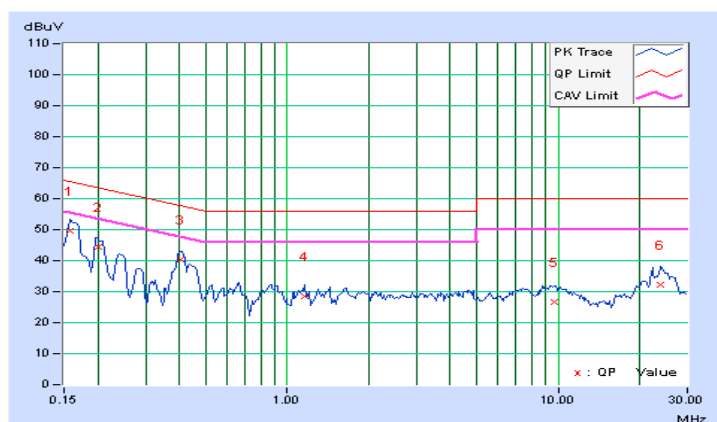



Phase	Neutral (N)	Detector Function	Quasi-Peak (QP) / Average (AV)
Test Mode	B		

No	Freq. [MHz]	Corr. Factor (dB)	Reading Value		Emission Level		Limit		Margin	
			[dB (uV)]		[dB (uV)]		[dB (uV)]		(dB)	
			Q.P.	AV.	Q.P.	AV.	Q.P.	AV.	Q.P.	AV.
1	0.15781	10.11	39.75	26.68	49.86	36.79	65.58	55.58	-15.72	-18.79
2	0.19687	10.12	33.53	20.75	43.65	30.87	63.74	53.74	-20.09	-22.87
3	0.40781	10.17	28.91	23.94	39.08	34.11	57.69	47.69	-18.61	-13.58
4	0.85703	10.19	16.11	8.93	26.30	19.12	56.00	46.00	-29.70	-26.88
5	8.19922	10.48	13.29	7.84	23.77	18.32	60.00	50.00	-36.23	-31.68
6	24.41406	10.63	21.32	16.10	31.95	26.73	60.00	50.00	-28.05	-23.27

**REMARKS:**

1. Q.P. and AV. are abbreviations of quasi-peak and average individually.
2. The emission levels of other frequencies were very low against the limit.
3. Margin value = Emission level - Limit value
4. Correction factor = Insertion loss + Cable loss
5. Emission Level = Correction Factor + Reading Value.

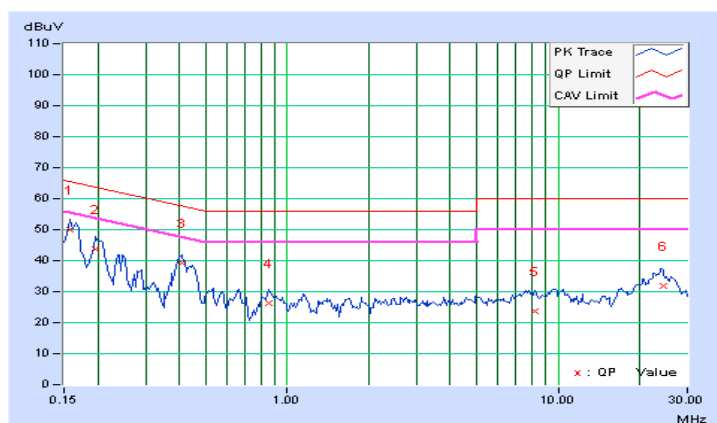

Phase	Line (L)	Detector Function	Quasi-Peak (QP) / Average (AV)
Test Mode	C		

No	Freq. [MHz]	Corr. Factor (dB)	Reading Value [dB (uV)]		Emission Level [dB (uV)]		Limit [dB (uV)]		Margin (dB)	
			Q.P.	AV.	Q.P.	AV.	Q.P.	AV.	Q.P.	AV.
			1	0.15604	10.08	39.23	24.52	49.31	34.60	65.67
2	0.24614	10.10	31.50	23.04	41.60	33.14	61.89	51.89	-20.29	-18.75
3	0.39342	10.17	37.08	28.70	47.25	38.87	57.99	47.99	-10.74	-9.12
4	0.67400	10.22	23.94	15.60	34.16	25.82	56.00	46.00	-21.84	-20.18
5	2.02550	10.37	17.11	11.05	27.48	21.42	56.00	46.00	-28.52	-24.58
6	4.71000	10.51	16.25	10.47	26.76	20.98	56.00	46.00	-29.24	-25.02

**REMARKS:**

1. Q.P. and AV. are abbreviations of quasi-peak and average individually.
2. The emission levels of other frequencies were very low against the limit.
3. Margin value = Emission level - Limit value
4. Correction factor = Insertion loss + Cable loss
5. Emission Level = Correction Factor + Reading Value.

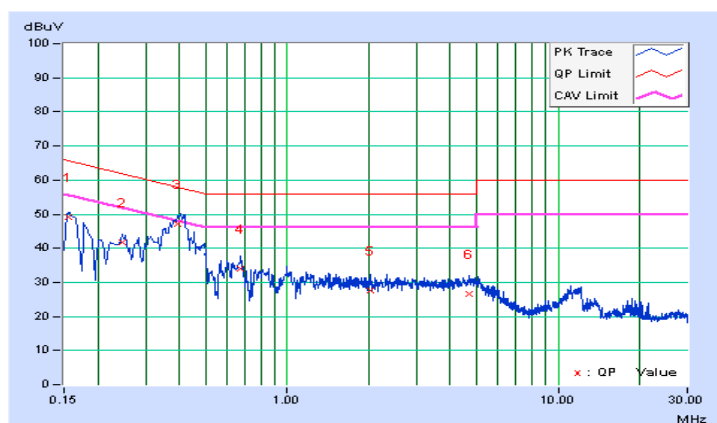

Phase	Neutral (N)	Detector Function	Quasi-Peak (QP) / Average (AV)
Test Mode	C		

No	Freq. [MHz]	Corr. Factor (dB)	Reading Value [dB (uV)]		Emission Level [dB (uV)]		Limit [dB (uV)]		Margin (dB)	
			Q.P.	AV.	Q.P.	AV.	Q.P.	AV.	Q.P.	AV.
			1	0.17384	10.08	35.72	18.07	45.80	28.15	64.77
2	0.39800	10.24	35.79	27.52	46.03	37.76	57.90	47.90	-11.87	-10.14
3	0.62550	10.26	22.70	16.18	32.96	26.44	56.00	46.00	-23.04	-19.56
4	1.20200	10.31	17.41	12.53	27.72	22.84	56.00	46.00	-28.28	-23.16
5	4.81000	10.63	14.89	7.88	25.52	18.51	56.00	46.00	-30.48	-27.49
6	11.88600	10.98	7.70	1.95	18.68	12.93	60.00	50.00	-41.32	-37.07

**REMARKS:**

1. Q.P. and AV. are abbreviations of quasi-peak and average individually.
2. The emission levels of other frequencies were very low against the limit.
3. Margin value = Emission level - Limit value
4. Correction factor = Insertion loss + Cable loss
5. Emission Level = Correction Factor + Reading Value.

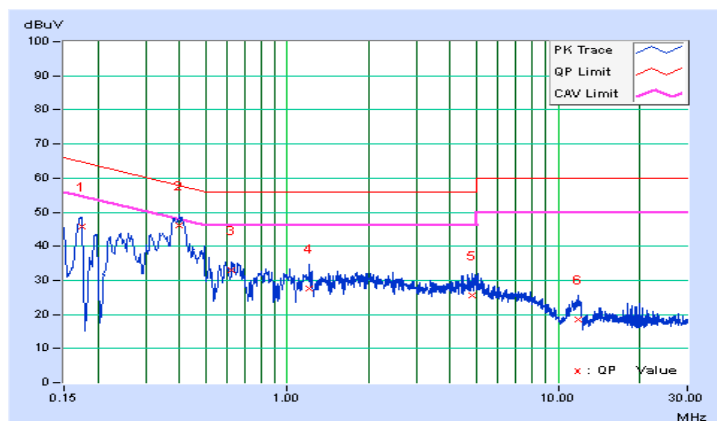

Phase	Line (L)	Detector Function	Quasi-Peak (QP) / Average (AV)
Test Mode	D		

No	Freq. [MHz]	Corr. Factor (dB)	Reading Value [dB (uV)]		Emission Level [dB (uV)]		Limit [dB (uV)]		Margin (dB)	
			Q.P.	AV.	Q.P.	AV.	Q.P.	AV.	Q.P.	AV.
			1	0.17400	10.02	37.58	22.82	47.60	32.84	64.77
2	0.22211	10.04	34.73	23.93	44.77	33.97	62.74	52.74	-17.97	-18.77
3	0.39032	10.12	25.44	11.74	35.56	21.86	58.06	48.06	-22.50	-26.20
4	0.64600	10.15	22.86	14.37	33.01	24.52	56.00	46.00	-22.99	-21.48
5	1.14600	10.21	19.74	11.75	29.95	21.96	56.00	46.00	-26.05	-24.04
6	21.62200	11.46	26.20	21.21	37.66	32.67	60.00	50.00	-22.34	-17.33

**REMARKS:**

1. Q.P. and AV. are abbreviations of quasi-peak and average individually.
2. The emission levels of other frequencies were very low against the limit.
3. Margin value = Emission level - Limit value
4. Correction factor = Insertion loss + Cable loss
5. Emission Level = Correction Factor + Reading Value.

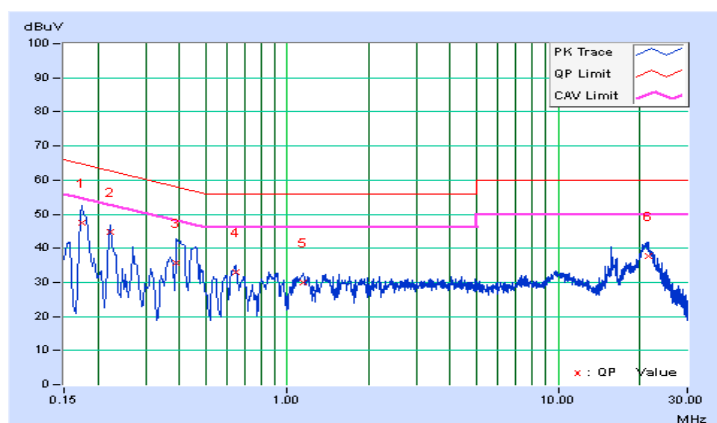

Phase	Neutral (N)	Detector Function	Quasi-Peak (QP) / Average (AV)
Test Mode	D		

No	Freq. [MHz]	Corr. Factor (dB)	Reading Value		Emission Level		Limit		Margin	
			[dB (uV)]		[dB (uV)]		[dB (uV)]		(dB)	
			Q.P.	AV.	Q.P.	AV.	Q.P.	AV.	Q.P.	AV.
1	0.17801	10.03	40.24	28.84	50.27	38.87	64.58	54.58	-14.30	-15.70
2	0.22211	10.05	34.03	22.78	44.08	32.83	62.74	52.74	-18.66	-19.91
3	0.40712	10.13	29.73	23.93	39.86	34.06	57.71	47.71	-17.85	-13.65
4	0.63800	10.16	20.78	13.69	30.94	23.85	56.00	46.00	-25.06	-22.15
5	0.92200	10.20	18.05	9.51	28.25	19.71	56.00	46.00	-27.75	-26.29
6	21.34200	11.57	25.61	20.25	37.18	31.82	60.00	50.00	-22.82	-18.18

**REMARKS:**

1. Q.P. and AV. are abbreviations of quasi-peak and average individually.
2. The emission levels of other frequencies were very low against the limit.
3. Margin value = Emission level - Limit value
4. Correction factor = Insertion loss + Cable loss
5. Emission Level = Correction Factor + Reading Value.

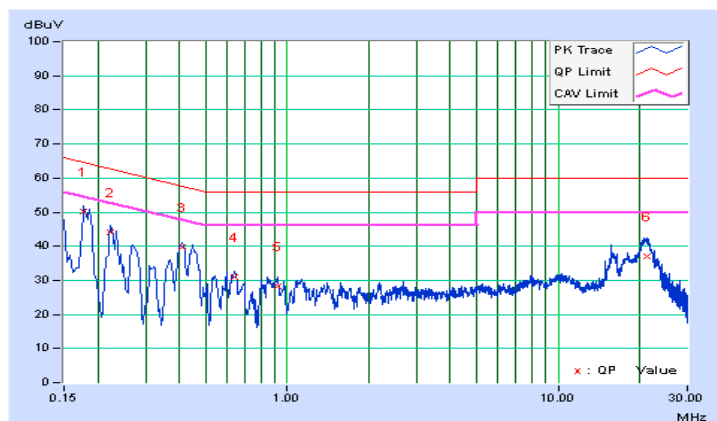

### 4.3 Transmit Power Measurement

#### 4.3.1 Limits of Transmit Power Measurement

Operation Band	EUT Category		LIMIT
U-NII-1	-	Outdoor Access Point	1 Watt (30 dBm) (Max. e.i.r.p $\leq$ 125mW(21 dBm) at any elevation angle above 30 degrees as measured from the horizon)
	-	Fixed point-to-point Access Point	1 Watt (30 dBm)
	-	Indoor Access Point	1 Watt (30 dBm)
	-	Mobile and Portable client device	250mW (24 dBm)
U-NII-2A	√		250mW (24 dBm) or 11 dBm+10 log B*
U-NII-2C	√		250mW (24 dBm) or 11 dBm+10 log B*
U-NII-3	-		1 Watt (30 dBm)

\*B is the 26 dB emission bandwidth in megahertz

Per KDB 662911 Method of conducted output power measurement on IEEE 802.11 devices,

Array Gain = 0 dB (i.e., no array gain) for  $N_{ANT} \leq 4$ ;

Array Gain = 0 dB (i.e., no array gain) for channel widths  $\geq 40$  MHz for any  $N_{ANT}$ ;

Array Gain =  $5 \log(N_{ANT}/N_{SS})$  dB or 3 dB, whichever is less for 20-MHz channel widths with  $N_{ANT} \geq 5$ .

For power measurements on all other devices: Array Gain =  $10 \log(N_{ANT}/N_{SS})$  dB.

#### 4.3.2 Test Setup

For Power Output Measurement

For 802.11a, 802.11n (HT20), 802.11n (HT40)

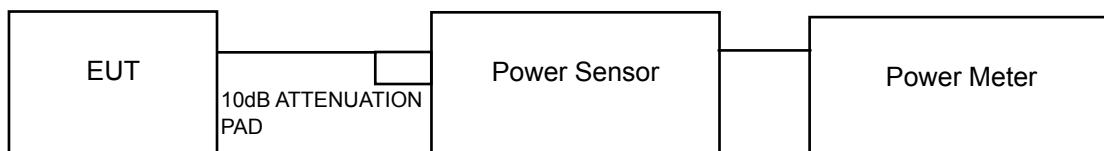

For 802.11ac (VHT80)

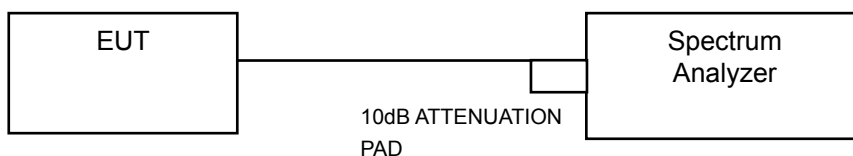

For 26dB and Occupied Bandwidth

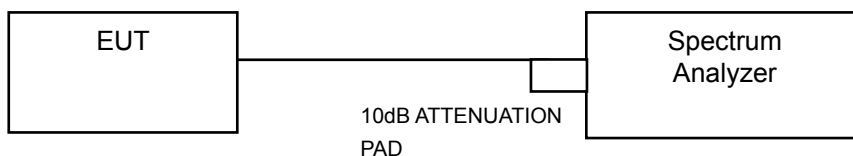

#### 4.3.3 Test Instruments

Refer to section 4.1.2 to get information of above instrument.

#### 4.3.4 Test Procedure

##### FOR AVERAGE POWER MEASUREMENT

###### For 802.11a, 802.11n (HT20), 802.11n (HT40)

Method PM is used to perform output power measurement, trigger and gating function of wide band power meter is enabled to measure max output power of TX on burst. Duty factor is not added to measured value.

###### For 802.11ac (VHT80)

- 1) Set span to encompass the entire 26 dB EBW (or, alternatively, the entire 99% occupied bandwidth) of the signal.
- 2) Set sweep trigger to "free run".
- 3) Set RBW = 1 MHz.
- 4) Set VBW  $\geq$  3 MHz
- 5) Number of points in sweep  $\geq$  2 Span / RBW.
- 6) Sweep time  $\leq$  (number of points in sweep) \* T
- 7) Using emission bandwidth to determine the frequency span for integration the channel bandwidth.
- 8) Detector = RMS.
- 9) Trace mode = max hold.
- 10) Allow max hold to run for at least 60 seconds, or longer as needed to allow the trace to stabilize.

#### 4.3.5 Deviation from Test Standard

No deviation.

#### 4.3.6 EUT Operating Conditions

The software provided by client to enable the EUT under transmission condition continuously at lowest, middle and highest channel frequencies individually.

#### 4.3.7 Test Result

#### POWER OUTPUT:

#### Test Mode C

#### 1TX

#### 802.11a

Chan.	Freq. (MHz)	Maximum Conducted Power (mW)	Maximum Conducted Power (dBm)	Power Limit (dBm)	Pass / Fail
52	5260	217.771	23.38	24.00	Pass
60	5300	216.272	23.35	24.00	Pass
64	5320	156.315	21.94	24.00	Pass
100	5500	189.234	22.77	24.00	Pass
116	5580	222.331	23.47	24.00	Pass
140	5700	115.345	20.62	24.00	Pass

#### Note:

1.  $11\text{dBm} + 10\log ( 40.84 ) = 27.11 > 24\text{dBm}$
2.  $11\text{dBm} + 10\log ( 39.96 ) = 27.02 > 24\text{dBm}$
3.  $11\text{dBm} + 10\log ( 27.18 ) = 25.34 > 24\text{dBm}$
4.  $11\text{dBm} + 10\log ( 34.57 ) = 26.39 > 24\text{dBm}$
5.  $11\text{dBm} + 10\log ( 42.86 ) = 27.32 > 24\text{dBm}$
6.  $11\text{dBm} + 10\log ( 33.42 ) = 26.24 > 24\text{dBm}$

#### 802.11n (HT20)

Chan.	Freq. (MHz)	Maximum Conducted Power (mW)	Maximum Conducted Power (dBm)	Power Limit (dBm)	Pass / Fail
52	5260	219.786	23.42	24.00	Pass
60	5300	<b>220.293</b>	23.43	24.00	Pass
64	5320	137.404	21.38	24.00	Pass
100	5500	144.212	21.59	24.00	Pass
116	5580	221.309	23.45	24.00	Pass
140	5700	91.833	19.63	24.00	Pass

#### Note:

1.  $11\text{dBm} + 10\log ( 46.46 ) = 27.67 > 24\text{dBm}$
2.  $11\text{dBm} + 10\log ( 45.82 ) = 27.61 > 24\text{dBm}$
3.  $11\text{dBm} + 10\log ( 22.21 ) = 24.47 > 24\text{dBm}$
4.  $11\text{dBm} + 10\log ( 42.13 ) = 27.25 > 24\text{dBm}$
5.  $11\text{dBm} + 10\log ( 46.93 ) = 27.71 > 24\text{dBm}$
6.  $11\text{dBm} + 10\log ( 25.87 ) = 25.13 > 24\text{dBm}$



### 802.11n (HT40)

Chan.	Freq. (MHz)	Maximum Conducted Power (mW)	Maximum Conducted Power (dBm)	Power Limit (dBm)	Pass / Fail
54	5270	214.783	23.32	24.00	Pass
62	5310	77.804	18.91	24.00	Pass
102	5510	77.446	18.89	24.00	Pass
110	5550	<b>238.232</b>	23.77	24.00	Pass
134	5670	121.899	20.86	24.00	Pass

Note:

1.  $11\text{dBm} + 10\log ( 97.33 ) = 30.88 > 24\text{dBm}$
2.  $11\text{dBm} + 10\log ( 41.52 ) = 27.18 > 24\text{dBm}$
3.  $11\text{dBm} + 10\log ( 41.59 ) = 27.19 > 24\text{dBm}$
4.  $11\text{dBm} + 10\log ( 102.31 ) = 31.10 > 24\text{dBm}$
5.  $11\text{dBm} + 10\log ( 97.18 ) = 30.88 > 24\text{dBm}$

### 802.11ac (VHT80)

Chan.	Freq. (MHz)	Maximum Conducted Power (mW)	Maximum Conducted Power (dBm)	Power Limit (dBm)	Pass / Fail
58	5290	21.184	13.26	24.00	Pass
106	5530	30.974	14.91	24.00	Pass

Note:

1.  $11\text{dBm} + 10\log ( 122.36 ) = 31.88 > 24\text{dBm}$
2.  $11\text{dBm} + 10\log ( 142.78 ) = 32.55 > 24\text{dBm}$

## Test Mode C

### 2TX

#### 802.11a

Chan.	Freq. (MHz)	Maximum Conducted Power (dBm)		Total Power (mW)	Total Power (dBm)	Power Limit (dBm)	Pass / Fail
		Chain 0	Chain 1				
52	5260	18.28	18.26	134.286	21.28	24.00	Pass
60	5300	18.39	18.27	136.167	21.34	24.00	Pass
64	5320	18.42	18.57	<b>141.447</b>	21.51	24.00	Pass
100	5500	18.53	18.37	139.992	21.46	24.00	Pass
116	5580	18.64	18.74	<b>147.931</b>	21.70	24.00	Pass
140	5700	18.71	18.43	143.965	21.58	24.00	Pass

Note:

Chain 0

1.  $11\text{dBm} + 10\log ( 22.01 ) = 24.43 > 24\text{dBm}$
2.  $11\text{dBm} + 10\log ( 21.94 ) = 24.41 > 24\text{dBm}$
3.  $11\text{dBm} + 10\log ( 21.88 ) = 24.40 > 24\text{dBm}$
4.  $11\text{dBm} + 10\log ( 21.89 ) = 24.40 > 24\text{dBm}$
5.  $11\text{dBm} + 10\log ( 21.81 ) = 24.39 > 24\text{dBm}$
6.  $11\text{dBm} + 10\log ( 22.00 ) = 24.42 > 24\text{dBm}$

Chain 1

1.  $11\text{dBm} + 10\log ( 21.76 ) = 24.38 > 24\text{dBm}$
2.  $11\text{dBm} + 10\log ( 21.75 ) = 24.37 > 24\text{dBm}$
3.  $11\text{dBm} + 10\log ( 21.74 ) = 24.37 > 24\text{dBm}$
4.  $11\text{dBm} + 10\log ( 21.71 ) = 24.37 > 24\text{dBm}$
5.  $11\text{dBm} + 10\log ( 21.93 ) = 24.41 > 24\text{dBm}$
6.  $11\text{dBm} + 10\log ( 22.05 ) = 24.43 > 24\text{dBm}$

### 802.11n (HT20)

Chan.	Freq. (MHz)	Maximum Conducted Power (dBm)		Total Power (mW)	Total Power (dBm)	Power Limit (dBm)	Pass / Fail
		Chain 0	Chain 1				
52	5260	17.41	17.35	109.406	20.39	20.99	Pass
60	5300	17.38	17.23	107.547	20.32	20.99	Pass
64	5320	17.37	17.45	110.166	20.42	20.99	Pass
100	5500	17.53	17.43	111.959	20.49	20.99	Pass
116	5580	17.46	17.41	110.800	20.45	20.99	Pass
140	5700	17.38	17.31	108.529	20.36	20.99	Pass

\* Directional gain =  $6\text{dBi} + 10 \log(2) = 9.01\text{dBi} > 6\text{dBi}$ , so the power limit shall be reduced to  $24 - (9.01 - 6) = 20.99\text{dBm}$ .

Note:

Chain 0

1.  $11\text{dBm} + 10\log ( 22.09 ) = 24.44 > 20.99\text{dBm}$
2.  $11\text{dBm} + 10\log ( 22.14 ) = 24.45 > 20.99\text{dBm}$
3.  $11\text{dBm} + 10\log ( 22.07 ) = 24.44 > 20.99\text{dBm}$
4.  $11\text{dBm} + 10\log ( 22.00 ) = 24.42 > 20.99\text{dBm}$
5.  $11\text{dBm} + 10\log ( 22.21 ) = 24.47 > 20.99\text{dBm}$
6.  $11\text{dBm} + 10\log ( 22.30 ) = 24.48 > 20.99\text{dBm}$

Chain 1

1.  $11\text{dBm} + 10\log ( 21.94 ) = 24.41 > 20.99\text{dBm}$
2.  $11\text{dBm} + 10\log ( 21.81 ) = 24.39 > 20.99\text{dBm}$
3.  $11\text{dBm} + 10\log ( 21.91 ) = 24.41 > 20.99\text{dBm}$
4.  $11\text{dBm} + 10\log ( 21.80 ) = 24.38 > 20.99\text{dBm}$
5.  $11\text{dBm} + 10\log ( 22.00 ) = 24.42 > 20.99\text{dBm}$
6.  $11\text{dBm} + 10\log ( 21.92 ) = 24.41 > 20.99\text{dBm}$

**802.11n (HT40)**

Chan.	Freq. (MHz)	Maximum Conducted Power (dBm)		Total Power (mW)	Total Power (dBm)	Power Limit (dBm)	Pass / Fail
		Chain 0	Chain 1				
54	5270	17.31	17.49	109.932	20.41	20.99	Pass
62	5310	15.69	15.66	73.881	18.69	20.99	Pass
102	5510	17.64	17.50	114.310	20.58	20.99	Pass
110	5550	17.65	17.55	115.095	20.61	20.99	Pass
134	5670	17.83	17.69	119.423	20.77	20.99	Pass

\* Directional gain = 6dBi + 10 log(2) = 9.01dBi > 6dBi, so the power limit shall be reduced to 24-(9.01-6) = 20.99dBm.

Note:

Chain 0

1. 11dBm + 10log ( 41.61 ) = 27.19 > 20.99dBm
2. 11dBm + 10log ( 41.37 ) = 27.17 > 20.99dBm
3. 11dBm + 10log ( 41.68 ) = 27.20 > 20.99dBm
4. 11dBm + 10log ( 41.60 ) = 27.19 > 20.99dBm
5. 11dBm + 10log ( 41.80 ) = 27.21 > 20.99dBm

Chain 1

1. 11dBm + 10log ( 41.19 ) = 27.15 > 20.99dBm
2. 11dBm + 10log ( 41.31 ) = 27.16 > 20.99dBm
3. 11dBm + 10log ( 41.18 ) = 27.15 > 20.99dBm
4. 11dBm + 10log ( 41.30 ) = 27.16 > 20.99dBm
5. 11dBm + 10log ( 41.28 ) = 27.16 > 20.99dBm

### 802.11ac (VHT80)

Chan.	Freq. (MHz)	Maximum Conducted Power (dBm)		Total Power (mW)	Total Power (dBm)	Power Limit (dBm)	Pass / Fail
		Chain 0	Chain 1				
58	5290	13.04	12.31	37.159	15.70	20.99	Pass
106	5530	14.17	14.28	52.914	17.24	20.99	Pass

\* Directional gain = 6dBi + 10 log(2) = 9.01dBi > 6dBi, so the power limit shall be reduced to 24-(9.01-6) = 20.99dBm.

Note:

Chain 0

1. 11dBm + 10log ( 122.93 ) = 31.90 > 20.99dBm

2. 11dBm + 10log ( 97.13 ) = 30.87 > 20.99dBm

Chain 1

1. 11dBm + 10log ( 123.53 ) = 31.92 > 20.99dBm

2. 11dBm + 10log ( 110.19 ) = 31.42 > 20.99dBm

### Test Mode C

### 3TX

### 802.11a

Chan.	Freq. (MHz)	Maximum Conducted Power (dBm)			Total Power (mW)	Total Power (dBm)	Power Limit (dBm)	Pass / Fail
		Chain 0	Chain 1	Chain 2				
52	5260	14.03	13.42	14.77	77.264	18.88	24.00	Pass
60	5300	13.92	13.53	14.78	77.263	18.88	24.00	Pass
64	5320	14.02	13.63	15.02	<b>80.071</b>	19.03	24.00	Pass
100	5500	14.52	13.85	14.57	81.222	19.10	24.00	Pass
116	5580	14.45	14.26	15.12	<b>87.039</b>	19.40	24.00	Pass
140	5700	14.49	13.92	15.09	85.064	19.30	24.00	Pass

Note:

Chain 0

1. 11dBm + 10log ( 21.85 ) = 24.39 > 24dBm
2. 11dBm + 10log ( 21.81 ) = 24.39 > 24dBm
3. 11dBm + 10log ( 21.84 ) = 24.39 > 24dBm
4. 11dBm + 10log ( 21.76 ) = 24.38 > 24dBm
5. 11dBm + 10log ( 21.76 ) = 24.38 > 24dBm
6. 11dBm + 10log ( 21.73 ) = 24.37 > 24dBm

Chain 1

1. 11dBm + 10log ( 21.58 ) = 24.34 > 24dBm
2. 11dBm + 10log ( 21.86 ) = 24.40 > 24dBm
3. 11dBm + 10log ( 21.80 ) = 24.38 > 24dBm
4. 11dBm + 10log ( 21.65 ) = 24.35 > 24dBm
5. 11dBm + 10log ( 21.59 ) = 24.34 > 24dBm
6. 11dBm + 10log ( 21.60 ) = 24.34 > 24dBm

Chain 2

1. 11dBm + 10log ( 21.74 ) = 24.37 > 24dBm
2. 11dBm + 10log ( 21.80 ) = 24.38 > 24dBm
3. 11dBm + 10log ( 21.74 ) = 24.37 > 24dBm
4. 11dBm + 10log ( 21.71 ) = 24.37 > 24dBm
5. 11dBm + 10log ( 21.68 ) = 24.36 > 24dBm
6. 11dBm + 10log ( 21.64 ) = 24.35 > 24dBm

### 802.11n (HT20)

Chan.	Freq. (MHz)	Maximum Conducted Power (dBm)			Total Power (mW)	Total Power (dBm)	Power Limit (dBm)	Pass / Fail
		Chain 0	Chain 1	Chain 2				
52	5260	14.38	13.31	13.21	69.786	18.44	19.23	Pass
60	5300	14.65	13.38	13.39	72.778	18.62	19.23	Pass
64	5320	14.51	13.62	13.74	74.922	18.75	19.23	Pass
100	5500	14.03	14.08	13.82	74.978	18.75	19.23	Pass
116	5580	13.91	14.02	13.98	74.842	18.74	19.23	Pass
140	5700	14.02	13.89	13.96	74.615	18.73	19.23	Pass

\* Directional gain =  $6\text{dBi} + 10 \log(3) = 10.77\text{dBi} > 6\text{dBi}$ , so the power limit shall be reduced to  $24 - (10.77 - 6) = 19.23\text{dBm}$ .

Note:

Chain 0

1.  $11\text{dBm} + 10\log ( 22.19 ) = 24.46 > 19.23\text{dBm}$
2.  $11\text{dBm} + 10\log ( 22.12 ) = 24.45 > 19.23\text{dBm}$
3.  $11\text{dBm} + 10\log ( 22.11 ) = 24.45 > 19.23\text{dBm}$
4.  $11\text{dBm} + 10\log ( 22.11 ) = 24.45 > 19.23\text{dBm}$
5.  $11\text{dBm} + 10\log ( 22.21 ) = 24.47 > 19.23\text{dBm}$
6.  $11\text{dBm} + 10\log ( 22.17 ) = 24.46 > 19.23\text{dBm}$

Chain 1

1.  $11\text{dBm} + 10\log ( 21.78 ) = 24.38 > 19.23\text{dBm}$
2.  $11\text{dBm} + 10\log ( 21.83 ) = 24.39 > 19.23\text{dBm}$
3.  $11\text{dBm} + 10\log ( 21.87 ) = 24.40 > 19.23\text{dBm}$
4.  $11\text{dBm} + 10\log ( 21.78 ) = 24.38 > 19.23\text{dBm}$
5.  $11\text{dBm} + 10\log ( 21.81 ) = 24.39 > 19.23\text{dBm}$
6.  $11\text{dBm} + 10\log ( 22.05 ) = 24.43 > 19.23\text{dBm}$

Chain 2

1.  $11\text{dBm} + 10\log ( 21.86 ) = 24.40 > 19.23\text{dBm}$
2.  $11\text{dBm} + 10\log ( 21.91 ) = 24.41 > 19.23\text{dBm}$
3.  $11\text{dBm} + 10\log ( 21.90 ) = 24.40 > 19.23\text{dBm}$
4.  $11\text{dBm} + 10\log ( 21.85 ) = 24.39 > 19.23\text{dBm}$
5.  $11\text{dBm} + 10\log ( 21.78 ) = 24.38 > 19.23\text{dBm}$
6.  $11\text{dBm} + 10\log ( 21.84 ) = 24.39 > 19.23\text{dBm}$

### 802.11n (HT40)

Chan.	Freq. (MHz)	Maximum Conducted Power (dBm)			Total Power (mW)	Total Power (dBm)	Power Limit (dBm)	Pass / Fail
		Chain 0	Chain 1	Chain 2				
54	5270	14.36	13.85	13.77	75.379	18.77	19.23	Pass
62	5310	14.41	13.92	13.75	75.980	18.81	19.23	Pass
102	5510	14.24	14.19	14.11	78.551	18.95	19.23	Pass
110	5550	14.35	14.22	14.31	80.628	19.06	19.23	Pass
134	5670	14.42	14.11	14.16	79.494	19.00	19.23	Pass

\* Directional gain = 6dBi + 10 log(3) = 10.77dBi > 6dBi, so the power limit shall be reduced to 24-(10.77-6) = 19.23dBm.

Note:

Chain 0

1. 11dBm + 10log ( 41.81 ) = 27.21 > 19.23dBm
2. 11dBm + 10log ( 41.42 ) = 27.17 > 19.23dBm
3. 11dBm + 10log ( 41.63 ) = 27.19 > 19.23dBm
4. 11dBm + 10log ( 41.54 ) = 27.18 > 19.23dBm
5. 11dBm + 10log ( 41.59 ) = 27.19 > 19.23dBm

Chain 1

1. 11dBm + 10log ( 41.27 ) = 27.16 > 19.23dBm
2. 11dBm + 10log ( 41.22 ) = 27.15 > 19.23dBm
3. 11dBm + 10log ( 41.06 ) = 27.13 > 19.23dBm
4. 11dBm + 10log ( 41.24 ) = 27.15 > 19.23dBm
5. 11dBm + 10log ( 41.42 ) = 27.17 > 19.23dBm

Chain 2

1. 11dBm + 10log ( 41.03 ) = 27.13 > 19.23dBm
2. 11dBm + 10log ( 41.05 ) = 27.13 > 19.23dBm
3. 11dBm + 10log ( 41.03 ) = 27.13 > 19.23dBm
4. 11dBm + 10log ( 41.02 ) = 27.13 > 19.23dBm
5. 11dBm + 10log ( 41.11 ) = 27.14 > 19.23dBm



### 802.11ac (VHT80)

Chan.	Freq. (MHz)	Maximum Conducted Power (dBm)			Total Power (mW)	Total Power (dBm)	Power Limit (dBm)	Pass / Fail
		Chain 0	Chain 1	Chain 2				
58	5290	13.35	12.14	13.57	60.746	17.84	19.23	Pass
106	5530	12.80	13.14	14.12	65.484	18.16	19.23	Pass

\* Directional gain = 6dBi + 10 log(3) = 10.77dBi > 6dBi, so the power limit shall be reduced to 24-(10.77-6) = 19.23dBm.

Note:

Chain 0

1. 11dBm + 10log ( 123.01 ) = 31.90 > 19.23dBm
2. 11dBm + 10log ( 94.84 ) = 30.77 > 19.23dBm

Chain 1

1. 11dBm + 10log ( 121.03 ) = 31.83 > 19.23dBm
2. 11dBm + 10log ( 102.77 ) = 31.12 > 19.23dBm

Chain 2

1. 11dBm + 10log ( 125.97 ) = 32.00 > 19.23dBm
2. 11dBm + 10log ( 94.45 ) = 30.75 > 19.23dBm

## Test Mode C

### 4TX

#### 802.11a

Chan.	Freq. (MHz)	Maximum Conducted Power (dBm)				Total Power (mW)	Total Power (dBm)	Power Limit (dBm)	Pass / Fail
		Chain 0	Chain 1	Chain 2	Chain 3				
52	5260	11.93	11.32	12.44	11.42	60.555	17.82	24.00	Pass
60	5300	11.43	11.42	12.83	11.55	61.244	17.87	24.00	Pass
64	5320	11.47	11.32	12.93	11.79	<b>62.315</b>	17.95	24.00	Pass
100	5500	11.76	11.36	12.20	12.19	61.828	17.91	24.00	Pass
116	5580	11.53	11.72	12.43	12.06	62.649	17.97	24.00	Pass
140	5700	11.77	11.32	12.54	12.22	<b>63.202</b>	18.01	24.00	Pass

#### Note:

##### Chain 0

1. 11dBm + 10log ( 21.85 ) = 24.39 > 24dBm
2. 11dBm + 10log ( 21.85 ) = 24.39 > 24dBm
3. 11dBm + 10log ( 21.85 ) = 24.39 > 24dBm
4. 11dBm + 10log ( 21.82 ) = 24.39 > 24dBm
5. 11dBm + 10log ( 21.73 ) = 24.37 > 24dBm
6. 11dBm + 10log ( 21.77 ) = 24.38 > 24dBm

##### Chain 1

1. 11dBm + 10log ( 21.79 ) = 24.38 > 24dBm
2. 11dBm + 10log ( 21.82 ) = 24.39 > 24dBm
3. 11dBm + 10log ( 21.90 ) = 24.40 > 24dBm
4. 11dBm + 10log ( 21.83 ) = 24.39 > 24dBm
5. 11dBm + 10log ( 21.91 ) = 24.41 > 24dBm
6. 11dBm + 10log ( 21.77 ) = 24.38 > 24dBm

##### Chain 2

1. 11dBm + 10log ( 21.71 ) = 24.37 > 24dBm
2. 11dBm + 10log ( 21.71 ) = 24.37 > 24dBm
3. 11dBm + 10log ( 21.70 ) = 24.36 > 24dBm
4. 11dBm + 10log ( 21.66 ) = 24.36 > 24dBm
5. 11dBm + 10log ( 21.66 ) = 24.36 > 24dBm
6. 11dBm + 10log ( 21.68 ) = 24.36 > 24dBm

##### Chain 3

1. 11dBm + 10log ( 21.65 ) = 24.35 > 24dBm
2. 11dBm + 10log ( 21.66 ) = 24.36 > 24dBm
3. 11dBm + 10log ( 21.63 ) = 24.35 > 24dBm
4. 11dBm + 10log ( 21.57 ) = 24.34 > 24dBm
5. 11dBm + 10log ( 21.61 ) = 24.35 > 24dBm
6. 11dBm + 10log ( 21.60 ) = 24.34 > 24dBm

### 802.11n (HT20)

Chan.	Freq. (MHz)	Maximum Conducted Power (dBm)				Total Power (mW)	Total Power (dBm)	Power Limit (dBm)	Pass / Fail
		Chain 0	Chain 1	Chain 2	Chain 3				
52	5260	11.51	11.23	11.25	11.46	54.763	17.38	17.98	Pass
60	5300	11.53	11.46	11.17	11.32	54.863	17.39	17.98	Pass
64	5320	11.91	11.42	11.39	11.25	56.499	17.52	17.98	Pass
100	5500	11.71	11.36	11.24	11.21	55.020	17.41	17.98	Pass
116	5580	11.79	11.38	11.26	11.37	55.916	17.48	17.98	Pass
140	5700	11.81	11.23	11.19	11.27	54.994	17.40	17.98	Pass

\* Directional gain = 6 dBi + 10 log(4) = 12.02dBi > 6dBi, so the power limit shall be reduced to 24-(12.02-6) = 17.98dBm.

**Note:**

**Chain 0**

1. 11dBm + 10log ( 22.13 ) = 24.45 > 17.98dBm
2. 11dBm + 10log ( 22.12 ) = 24.45 > 17.98dBm
3. 11dBm + 10log ( 22.09 ) = 24.44 > 17.98dBm
4. 11dBm + 10log ( 22.17 ) = 24.46 > 17.98dBm
5. 11dBm + 10log ( 22.16 ) = 24.46 > 17.98dBm
6. 11dBm + 10log ( 21.98 ) = 24.42 > 17.98dBm

**Chain 1**

1. 11dBm + 10log ( 21.86 ) = 24.40 > 17.98dBm
2. 11dBm + 10log ( 21.79 ) = 24.38 > 17.98dBm
3. 11dBm + 10log ( 21.74 ) = 24.37 > 17.98dBm
4. 11dBm + 10log ( 21.90 ) = 24.40 > 17.98dBm
5. 11dBm + 10log ( 21.94 ) = 24.41 > 17.98dBm
6. 11dBm + 10log ( 21.75 ) = 24.37 > 17.98dBm

**Chain 2**

1. 11dBm + 10log ( 21.95 ) = 24.41 > 17.98dBm
2. 11dBm + 10log ( 21.89 ) = 24.40 > 17.98dBm
3. 11dBm + 10log ( 22.02 ) = 24.43 > 17.98dBm
4. 11dBm + 10log ( 21.81 ) = 24.39 > 17.98dBm
5. 11dBm + 10log ( 21.81 ) = 24.39 > 17.98dBm
6. 11dBm + 10log ( 21.82 ) = 24.39 > 17.98dBm

**Chain 3**

1. 11dBm + 10log ( 21.91 ) = 24.41 > 17.98dBm
2. 11dBm + 10log ( 22.13 ) = 24.45 > 17.98dBm
3. 11dBm + 10log ( 21.85 ) = 24.39 > 17.98dBm
4. 11dBm + 10log ( 21.81 ) = 24.39 > 17.98dBm
5. 11dBm + 10log ( 21.92 ) = 24.41 > 17.98dBm
6. 11dBm + 10log ( 21.98 ) = 24.42 > 17.98dBm

### 802.11n (HT40)

Chan.	Freq. (MHz)	Maximum Conducted Power (dBm)				Total Power (mW)	Total Power (dBm)	Power Limit (dBm)	Pass / Fail
		Chain 0	Chain 1	Chain 2	Chain 3				
54	5270	11.78	11.58	11.42	11.35	56.968	17.56	17.98	Pass
62	5310	11.61	11.45	11.32	11.55	56.293	17.50	17.98	Pass
102	5510	11.87	11.62	11.51	11.49	58.154	17.65	17.98	Pass
110	5550	11.93	11.82	11.49	11.56	59.216	17.72	17.98	Pass
134	5670	11.85	11.73	11.55	11.49	58.587	17.68	17.98	Pass

\* Directional gain = 6 dBi + 10 log(4) = 12.02dBi > 6dBi, so the power limit shall be reduced to 24-(12.02-6) = 17.98dBm.

Note:

Chain 0

1. 11dBm + 10log ( 41.53 ) = 27.18 > 17.98dBm
2. 11dBm + 10log ( 41.54 ) = 27.18 > 17.98dBm
3. 11dBm + 10log ( 41.35 ) = 27.16 > 17.98dBm
4. 11dBm + 10log ( 41.64 ) = 27.20 > 17.98dBm
5. 11dBm + 10log ( 41.36 ) = 27.17 > 17.98dBm

Chain 1

1. 11dBm + 10log ( 41.04 ) = 27.13 > 17.98dBm
2. 11dBm + 10log ( 41.37 ) = 27.17 > 17.98dBm
3. 11dBm + 10log ( 41.11 ) = 27.14 > 17.98dBm
4. 11dBm + 10log ( 41.10 ) = 27.14 > 17.98dBm
5. 11dBm + 10log ( 41.09 ) = 27.14 > 17.98dBm

Chain 2

1. 11dBm + 10log ( 41.01 ) = 27.13 > 17.98dBm
2. 11dBm + 10log ( 40.95 ) = 27.12 > 17.98dBm
3. 11dBm + 10log ( 41.17 ) = 27.15 > 17.98dBm
4. 11dBm + 10log ( 40.99 ) = 27.13 > 17.98dBm
5. 11dBm + 10log ( 41.04 ) = 27.13 > 17.98dBm

Chain 3

1. 11dBm + 10log ( 40.93 ) = 27.12 > 17.98dBm
2. 11dBm + 10log ( 40.99 ) = 27.13 > 17.98dBm
3. 11dBm + 10log ( 41.04 ) = 27.13 > 17.98dBm
4. 11dBm + 10log ( 41.05 ) = 27.13 > 17.98dBm
5. 11dBm + 10log ( 41.07 ) = 27.14 > 17.98dBm

**802.11ac (VHT80)**

Chan.	Freq. (MHz)	Maximum Conducted Power (dBm)				Total Power (mW)	Total Power (dBm)	Power Limit (dBm)	Pass / Fail
		Chain 0	Chain 1	Chain 2	Chain 3				
58	5290	11.75	11.45	11.62	11.43	57.347	17.59	17.98	Pass
106	5530	11.91	11.88	11.55	11.42	59.098	17.72	17.98	Pass

\* Directional gain = 6 dBi + 10 log(4) = 12.02dBi > 6dBi, so the power limit shall be reduced to 24-(12.02-6) = 17.98dBm.

Note:

Chain 0

1. 11dBm + 10log ( 121.51 ) = 31.85 > 17.98dBm
2. 11dBm + 10log ( 94.53 ) = 30.76 > 17.98dBm

Chain 1

1. 11dBm + 10log ( 95.01 ) = 30.78 > 17.98dBm
2. 11dBm + 10log ( 91.67 ) = 30.62 > 17.98dBm

Chain 2

1. 11dBm + 10log ( 124.69 ) = 31.96 > 17.98dBm
2. 11dBm + 10log ( 92.13 ) = 30.64 > 17.98dBm

Chain 3

1. 11dBm + 10log ( 103.60 ) = 31.15 > 17.98dBm
2. 11dBm + 10log ( 95.74 ) = 30.81 > 17.98dBm

**26dB BANDWIDTH:**
**Test Mode C**
**1TX**
**802.11a**

Chan.	Freq. (MHz)	26dBc Bandwidth (MHz)	Pass / Fail
52	5260	40.84	Pass
60	5300	39.95	Pass
64	5320	27.17	Pass
100	5500	34.56	Pass
116	5580	42.85	Pass
140	5700	33.41	Pass

**802.11n (HT20)**

Chan.	Freq. (MHz)	26dBc Bandwidth (MHz)	Pass / Fail
52	5260	46.45	Pass
60	5300	45.81	Pass
64	5320	22.21	Pass
100	5500	42.12	Pass
116	5580	46.93	Pass
140	5700	25.86	Pass

**802.11n (HT40)**

Chan.	Freq. (MHz)	26dBc Bandwidth (MHz)	Pass / Fail
54	5270	97.33	Pass
62	5310	41.52	Pass
102	5510	41.59	Pass
110	5550	102.31	Pass
134	5670	97.18	Pass

**802.11ac (VHT80)**

Chan.	Freq. (MHz)	26dBc Bandwidth (MHz)	Pass / Fail
58	5290	122.35	Pass
106	5530	142.78	Pass

### Spectrum Plot of Worst Value

802.11a

802.11n (HT20)

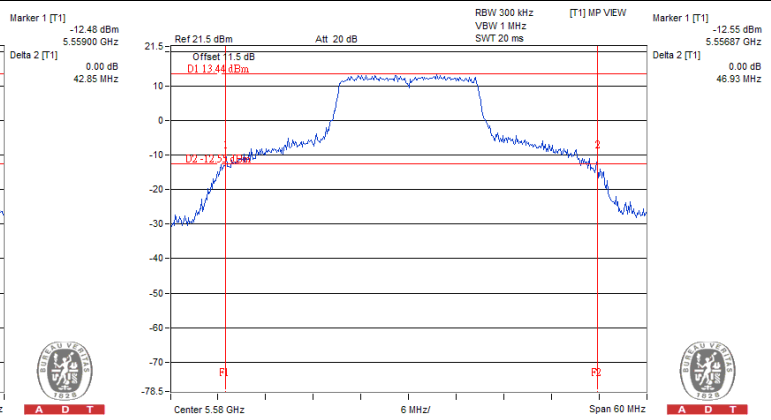
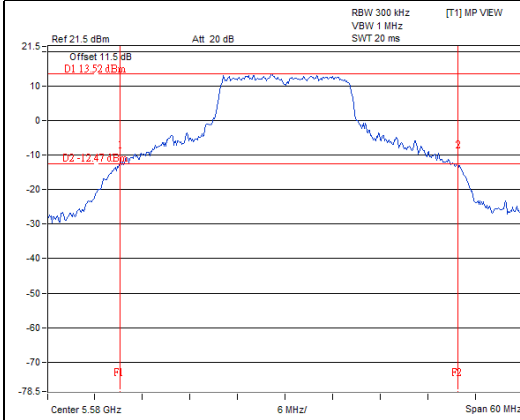

802.11n (HT40)

802.11ac (VHT80)

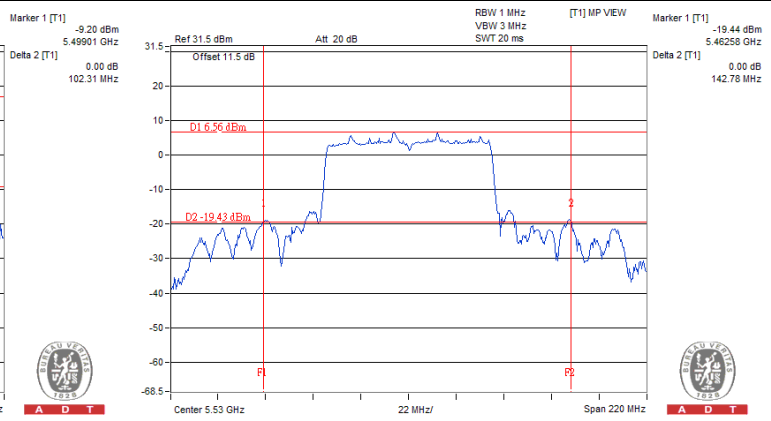
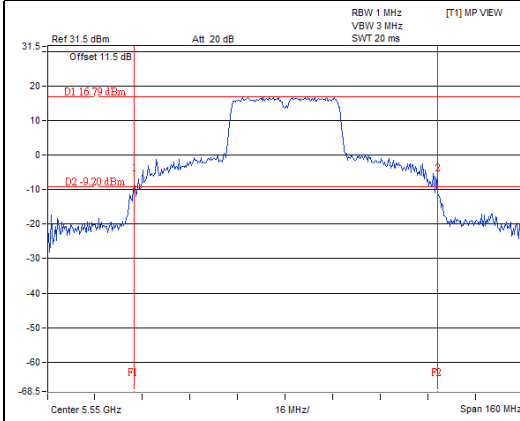

**Test Mode C**
**2TX**
**802.11a**

Chan.	Freq. (MHz)	26dBc Bandwidth (MHz)		Pass / Fail
		Chain 0	Chain 1	
52	5260	22.01	21.76	Pass
60	5300	21.94	21.74	Pass
64	5320	21.88	21.73	Pass
100	5500	21.88	21.71	Pass
116	5580	21.81	21.93	Pass
140	5700	21.99	22.05	Pass

**802.11n (HT20)**

Chan.	Freq. (MHz)	26dBc Bandwidth (MHz)		Pass / Fail
		Chain 0	Chain 1	
52	5260	22.09	21.94	Pass
60	5300	22.14	21.81	Pass
64	5320	22.07	21.91	Pass
100	5500	22.00	21.80	Pass
116	5580	22.21	22.00	Pass
140	5700	22.30	21.92	Pass

**802.11n (HT40)**

Chan.	Freq. (MHz)	26dBc Bandwidth (MHz)		Pass / Fail
		Chain 0	Chain 1	
54	5270	41.61	41.19	Pass
62	5310	41.37	41.31	Pass
102	5510	41.68	41.18	Pass
110	5550	41.60	41.30	Pass
134	5670	41.80	41.28	Pass

**802.11ac (VHT80)**

Chan.	Freq. (MHz)	26dBc Bandwidth (MHz)		Pass / Fail
		Chain 0	Chain 1	
58	5290	122.93	123.53	Pass
106	5530	97.13	110.19	Pass



### Spectrum Plot of Worst Value

802.11a

802.11n (HT20)

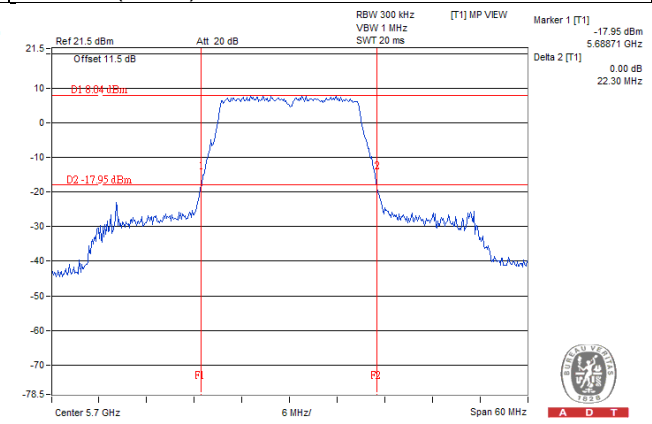
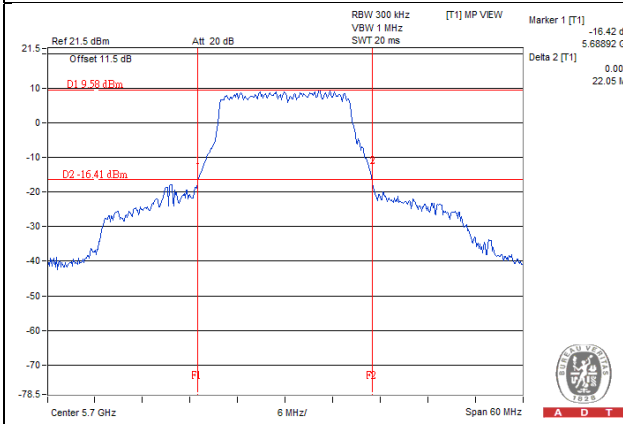

802.11n (HT40)

802.11ac (VHT80)

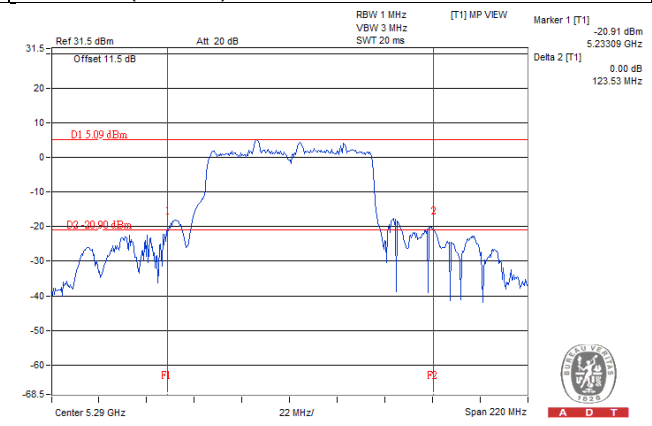
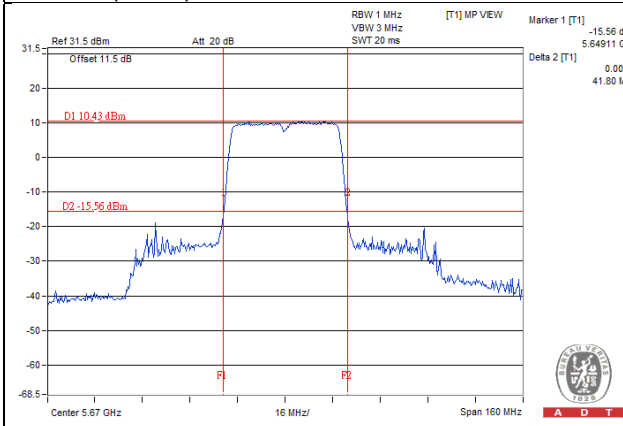

**Test Mode C**
**3TX**
**802.11a**

Chan.	Freq. (MHz)	26dBc Bandwidth (MHz)			Pass / Fail
		Chain 0	Chain 1	Chain 2	
52	5260	21.85	21.58	21.74	Pass
60	5300	21.81	21.86	21.80	Pass
64	5320	21.84	21.80	21.74	Pass
100	5500	21.76	21.65	21.71	Pass
116	5580	21.76	21.59	21.68	Pass
140	5700	21.73	21.60	21.64	Pass

**802.11n (HT20)**

Chan.	Freq. (MHz)	26dBc Bandwidth (MHz)			Pass / Fail
		Chain 0	Chain 1	Chain 2	
52	5260	22.19	21.78	21.86	Pass
60	5300	22.12	21.83	21.91	Pass
64	5320	22.11	21.87	21.90	Pass
100	5500	22.11	21.78	21.85	Pass
116	5580	22.21	21.81	21.78	Pass
140	5700	22.17	22.05	21.84	Pass

**802.11n (HT40)**

Chan.	Freq. (MHz)	26dBc Bandwidth (MHz)			Pass / Fail
		Chain 0	Chain 1	Chain 2	
54	5270	41.81	41.27	41.03	Pass
62	5310	41.42	41.22	41.05	Pass
102	5510	41.63	41.06	41.03	Pass
110	5550	41.54	41.24	41.02	Pass
134	5670	41.59	41.42	41.11	Pass

**802.11ac (VHT80)**

Chan.	Freq. (MHz)	26dBc Bandwidth (MHz)			Pass / Fail
		Chain 0	Chain 1	Chain 2	
58	5290	123.01	121.03	125.97	Pass
106	5530	94.84	102.77	94.45	Pass

### Spectrum Plot of Worst Value

802.11a

802.11n (HT20)

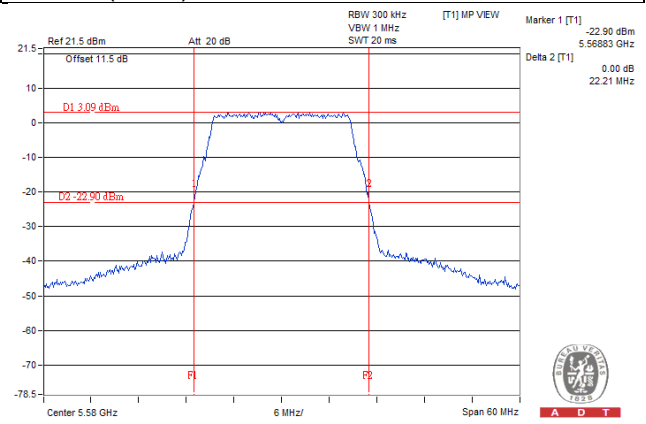
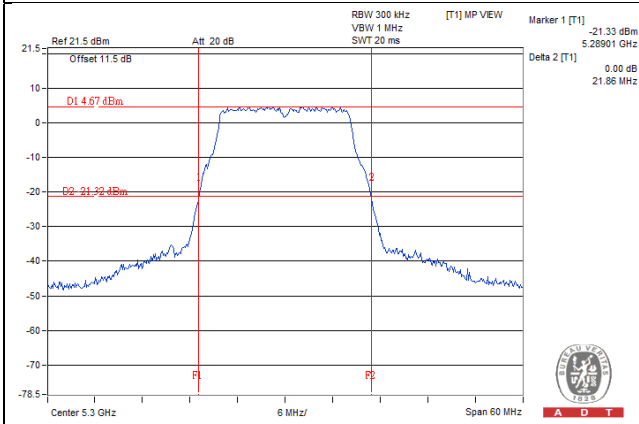

802.11n (HT40)

802.11ac (VHT80)

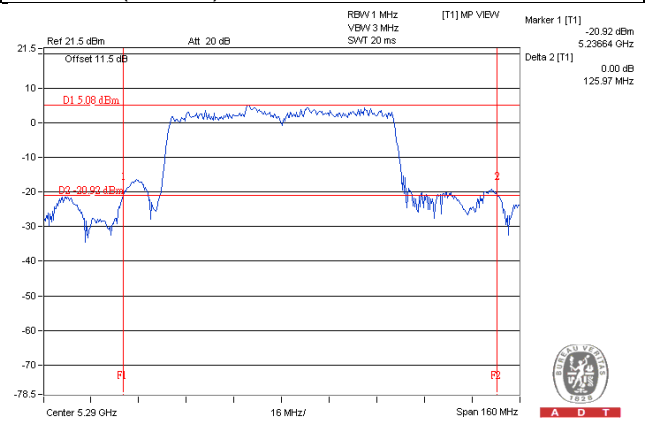
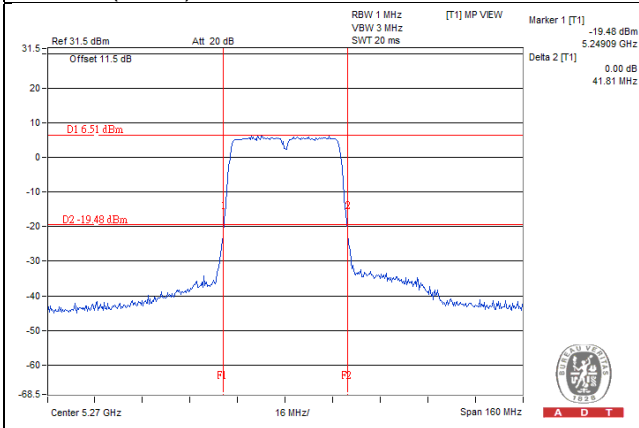

**Test Mode C**
**4TX**
**802.11a**

Chan.	Freq. (MHz)	26dBc Bandwidth (MHz)				Pass / Fail
		Chain 0	Chain 1	Chain 2	Chain 3	
52	5260	21.85	21.79	21.71	21.65	Pass
60	5300	21.85	21.82	21.71	21.66	Pass
64	5320	21.85	21.90	21.70	21.63	Pass
100	5500	21.82	21.83	21.66	21.57	Pass
116	5580	21.73	21.91	21.66	21.61	Pass
140	5700	21.77	21.77	21.68	21.60	Pass

**802.11n (HT20)**

Chan.	Freq. (MHz)	26dBc Bandwidth (MHz)				Pass / Fail
		Chain 0	Chain 1	Chain 2	Chain 3	
52	5260	22.13	21.86	21.95	21.91	Pass
60	5300	22.12	21.79	21.89	22.13	Pass
64	5320	22.09	21.74	22.02	21.85	Pass
100	5500	22.17	21.90	21.81	21.81	Pass
116	5580	22.16	21.94	21.81	21.92	Pass
140	5700	21.98	21.75	21.82	21.98	Pass

**802.11n (HT40)**

Chan.	Freq. (MHz)	26dBc Bandwidth (MHz)				Pass / Fail
		Chain 0	Chain 1	Chain 2	Chain 3	
54	5270	41.53	41.04	41.01	40.93	Pass
62	5310	41.54	41.37	40.95	40.99	Pass
102	5510	41.35	41.11	41.17	41.04	Pass
110	5550	41.64	41.10	40.99	41.05	Pass
134	5670	41.36	41.09	41.04	41.07	Pass

**802.11ac (VHT80)**

Chan.	Freq. (MHz)	26dBc Bandwidth (MHz)				Pass / Fail
		Chain 0	Chain 1	Chain 2	Chain 3	
58	5290	121.51	95.01	124.69	103.60	Pass
106	5530	94.53	91.67	92.13	95.74	Pass

### Spectrum Plot of Worst Value

802.11a

802.11n (HT20)

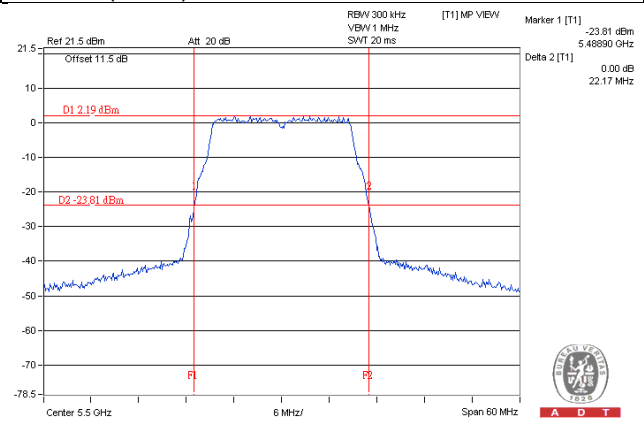
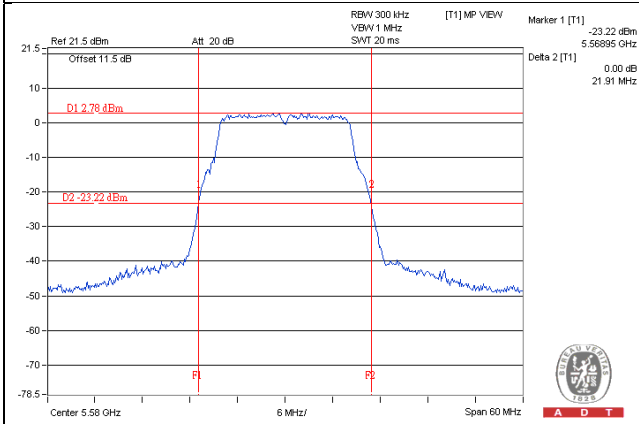

802.11n (HT40)

802.11ac (VHT80)

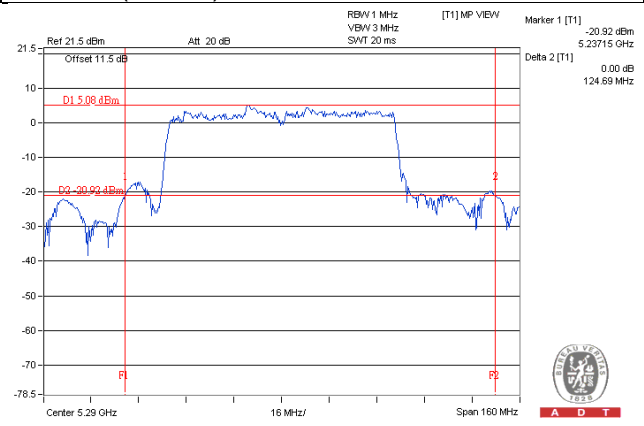
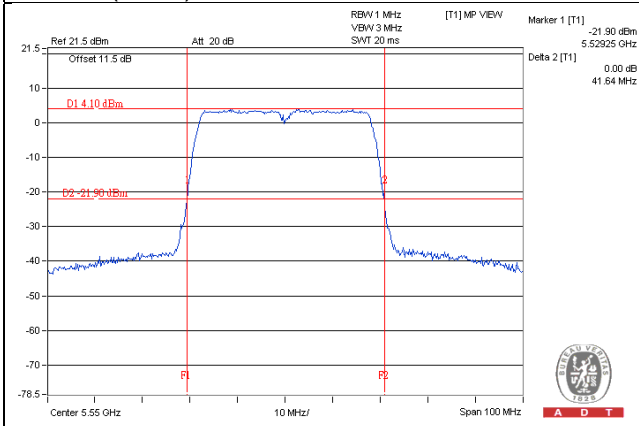

**OCCUPIED BANDWIDTH:**
**Test Mode C**
**1TX**
**802.11a**

Chan.	Freq. (MHz)	Occupied Bandwidth (MHz)
52	5260	20.40
60	5300	20.04
64	5320	17.52
100	5500	18.60
116	5580	24.96
140	5700	18.12

**802.11n (HT20)**

Chan.	Freq. (MHz)	Occupied Bandwidth (MHz)
52	5260	20.76
60	5300	20.52
64	5320	18.36
100	5500	18.60
116	5580	25.44
140	5700	18.48

**802.11n (HT40)**

Chan.	Freq. (MHz)	Occupied Bandwidth (MHz)
54	5270	37.56
62	5310	36.84
102	5510	36.84
110	5550	40.32
134	5670	37.20

**802.11ac (VHT80)**

Chan.	Freq. (MHz)	Occupied Bandwidth (MHz)
58	5290	76.32
106	5530	76.32



### Spectrum Plot of Worst Value

802.11a

802.11n (HT20)

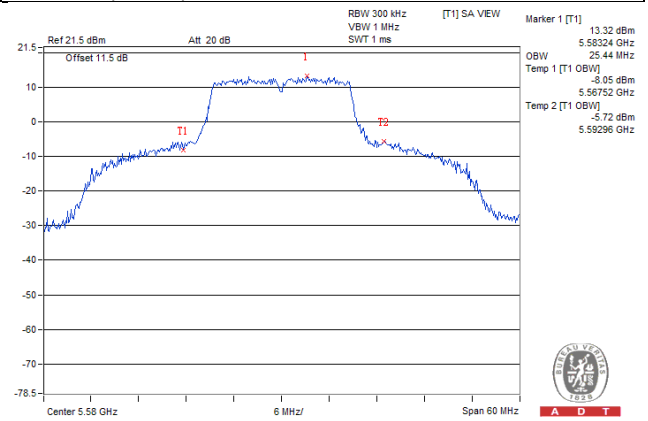
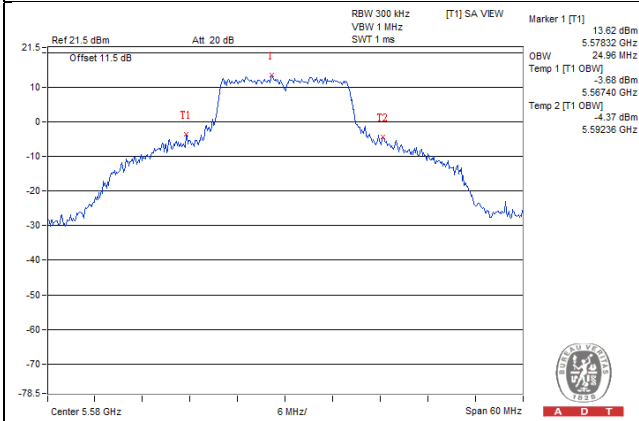

802.11n (HT40)

802.11ac (VHT80)

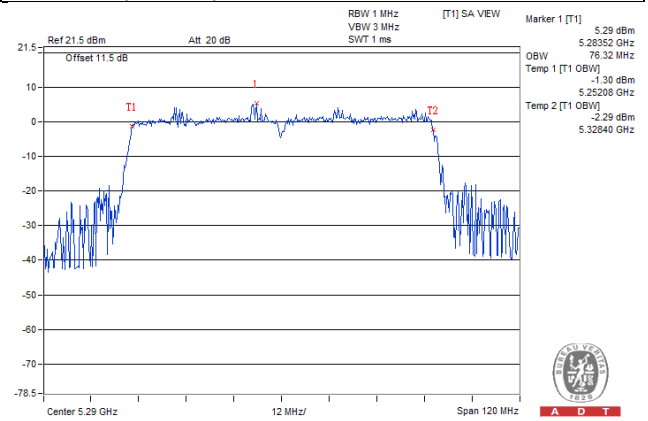
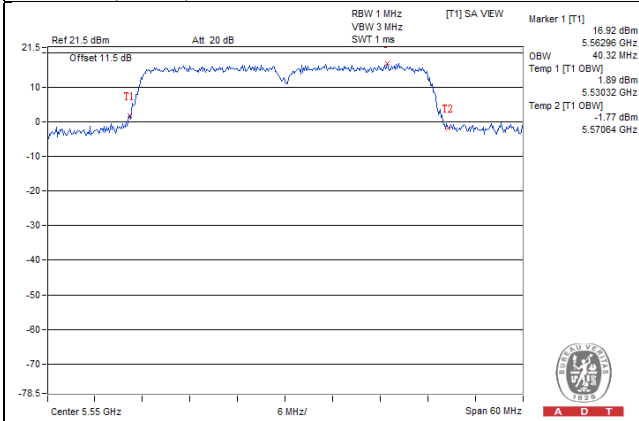

**Test Mode C**
**2TX**
**802.11a**

Chan.	Freq. (MHz)	Occupied Bandwidth (MHz)	
		Chain 0	Chain 1
52	5260	17.16	17.04
60	5300	17.16	17.04
64	5320	17.16	17.16
100	5500	17.16	17.04
116	5580	17.16	17.04
140	5700	17.28	17.04

**802.11n (HT20)**

Chan.	Freq. (MHz)	Occupied Bandwidth (MHz)	
		Chain 0	Chain 1
52	5260	18.36	18.00
60	5300	18.24	18.12
64	5320	18.12	18.12
100	5500	18.12	17.88
116	5580	18.12	18.12
140	5700	18.36	18.00

**802.11n (HT40)**

Chan.	Freq. (MHz)	Occupied Bandwidth (MHz)	
		Chain 0	Chain 1
54	5270	36.84	36.72
62	5310	36.84	36.72
102	5510	36.84	36.72
110	5550	36.84	36.84
134	5670	36.96	36.72

**802.11ac (VHT80)**

Chan.	Freq. (MHz)	Occupied Bandwidth (MHz)	
		Chain 0	Chain 1
58	5290	76.56	76.08
106	5530	76.32	76.32



### Spectrum Plot of Worst Value

802.11a

802.11n (HT20)

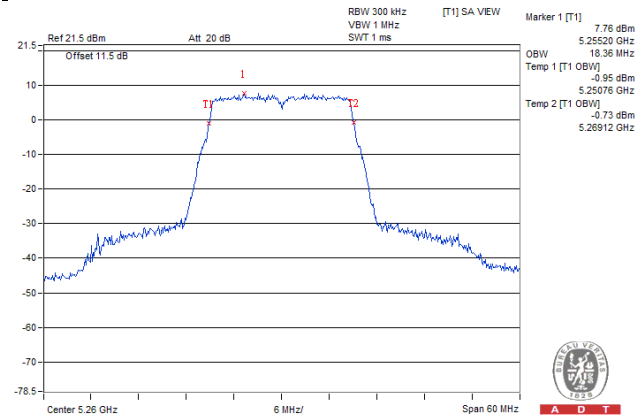
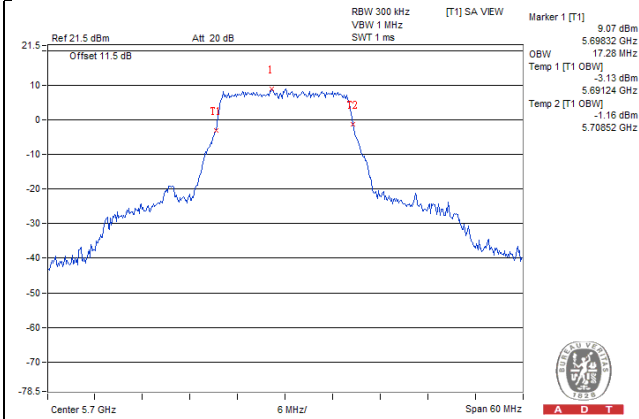

802.11n (HT40)

802.11ac (VHT80)

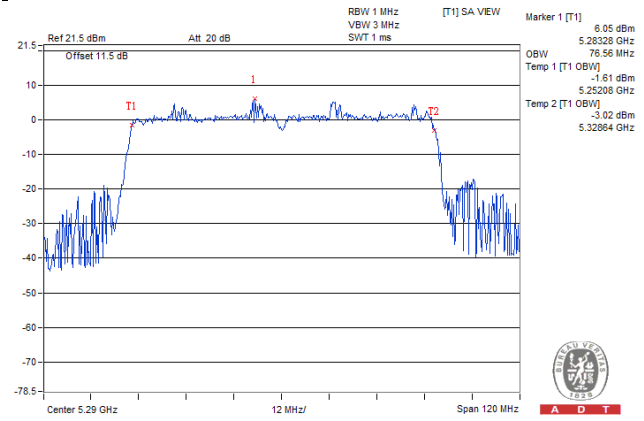
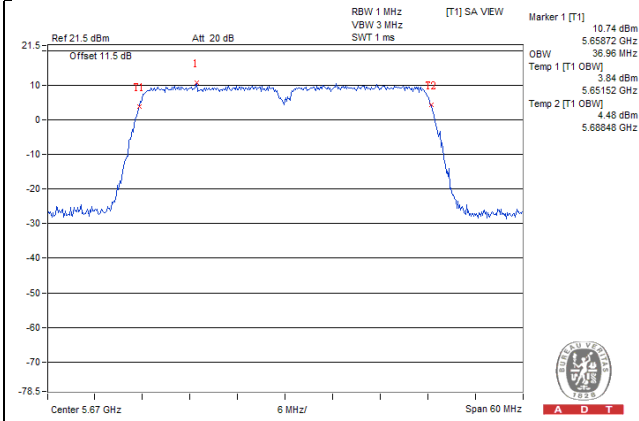

**Test Mode C**
**3TX**
**802.11a**

Chan.	Freq. (MHz)	Occupied Bandwidth (MHz)		
		Chain 0	Chain 1	Chain 2
52	5260	17.16	16.92	16.92
60	5300	17.16	17.16	17.04
64	5320	17.16	17.28	17.04
100	5500	17.16	17.04	17.04
116	5580	17.16	16.92	17.04
140	5700	17.04	16.92	16.92

**802.11n (HT20)**

Chan.	Freq. (MHz)	Occupied Bandwidth (MHz)		
		Chain 0	Chain 1	Chain 2
52	5260	18.36	18.00	18.12
60	5300	18.24	18.12	18.12
64	5320	18.24	18.12	18.12
100	5500	18.12	18.12	18.00
116	5580	18.24	18.00	18.12
140	5700	18.24	18.00	18.00

**802.11n (HT40)**

Chan.	Freq. (MHz)	Occupied Bandwidth (MHz)		
		Chain 0	Chain 1	Chain 2
54	5270	36.84	36.72	36.84
62	5310	36.96	36.84	36.72
102	5510	36.84	36.72	36.84
110	5550	36.84	36.84	36.84
134	5670	36.84	36.72	36.72

**802.11ac (VHT80)**

Chan.	Freq. (MHz)	Occupied Bandwidth (MHz)		
		Chain 0	Chain 1	Chain 2
58	5290	76.32	76.08	76.16
106	5530	76.32	76.32	76.16



BUREAU  
VERITAS

### Spectrum Plot of Worst Value

802.11a

802.11n (HT20)

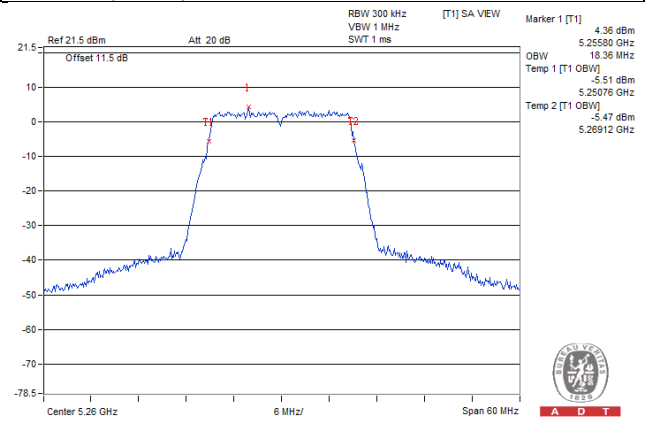
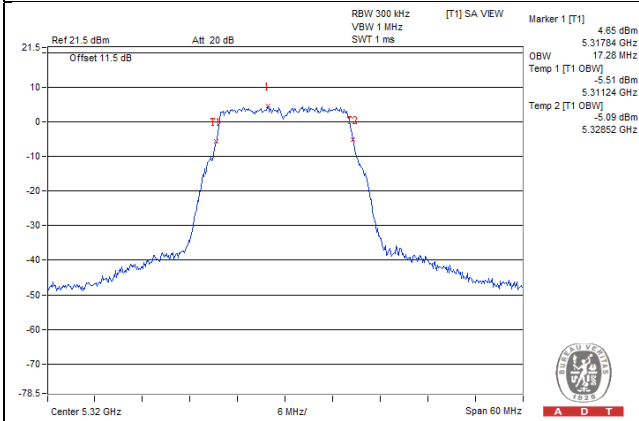

802.11n (HT40)

802.11ac (VHT80)

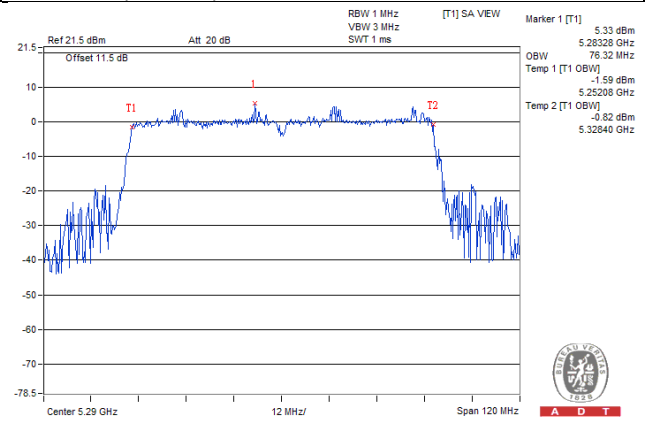
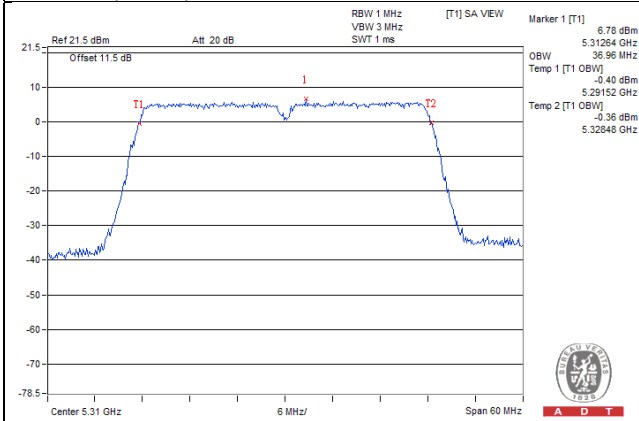

**Test Mode C**

**4TX**

**802.11a**

Chan.	Freq. (MHz)	Occupied Bandwidth (MHz)			
		Chain 0	Chain 1	Chain 2	Chain 3
52	5260	17.16	17.16	16.92	16.92
60	5300	17.16	17.16	16.92	16.92
64	5320	17.16	17.16	17.04	17.04
100	5500	17.16	17.16	17.04	16.92
116	5580	17.04	17.16	17.04	16.92
140	5700	17.16	17.04	17.04	16.92

**802.11n (HT20)**

Chan.	Freq. (MHz)	Occupied Bandwidth (MHz)			
		Chain 0	Chain 1	Chain 2	Chain 3
52	5260	18.24	17.88	18.12	18.12
60	5300	18.36	18.12	18.12	18.12
64	5320	18.12	18.12	18.12	18.12
100	5500	18.24	18.12	18.12	18.00
116	5580	18.12	18.12	18.12	18.12
140	5700	18.12	18.12	18.12	18.12

**802.11n (HT40)**

Chan.	Freq. (MHz)	Occupied Bandwidth (MHz)			
		Chain 0	Chain 1	Chain 2	Chain 3
54	5270	36.84	36.72	36.72	36.84
62	5310	36.84	36.84	36.84	36.84
102	5510	37.08	36.84	36.84	36.84
110	5550	36.84	36.84	36.84	36.96
134	5670	36.72	36.84	36.96	36.84

**802.11ac (VHT80)**

Chan.	Freq. (MHz)	Occupied Bandwidth (MHz)			
		Chain 0	Chain 1	Chain 2	Chain 3
58	5290	76.72	76.44	76.16	76.16
106	5530	76.16	76.16	76.16	76.16

### Spectrum Plot of Worst Value

802.11a

802.11n (HT20)

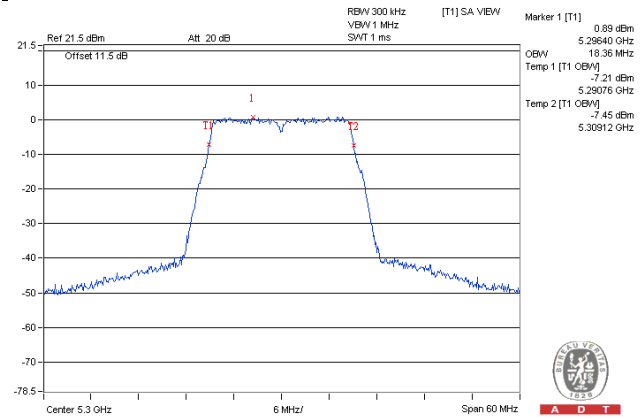
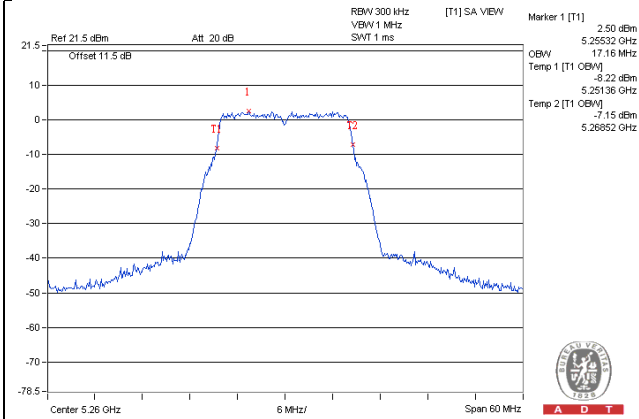

802.11n (HT40)

802.11ac (VHT80)

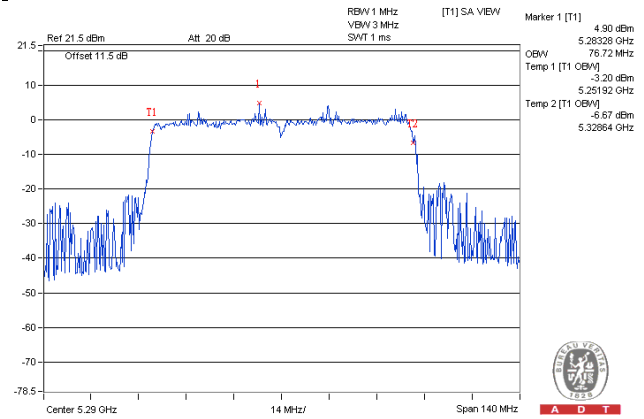
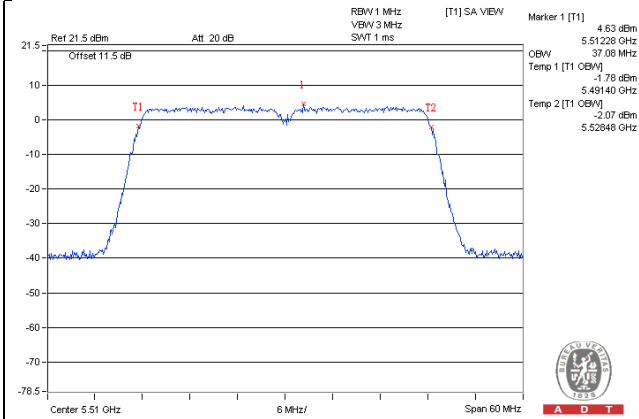

## EUT MAXIMUM CONDUCTED POWER

### Test Mode C

#### 1TX

##### 802.11a

Frequency Band (MHz)	Max. Power	
	Output Power (mW)	Output Power (dBm)
5250~5350	217.771	23.38
5470~5725	222.331	23.47

Note: Manufacturer provides Transmit Power Control description to meet this requirement.

##### 802.11n (HT20)

Frequency Band (MHz)	Max. Power	
	Output Power (mW)	Output Power (dBm)
5250~5350	220.293	23.43
5470~5725	221.309	23.45

Note: Manufacturer provides Transmit Power Control description to meet this requirement.

##### 802.11n (HT40)

Frequency Band (MHz)	Max. Power	
	Output Power (mW)	Output Power (dBm)
5250~5350	214.783	23.32
5470~5725	238.232	23.77

Note: Manufacturer provides Transmit Power Control description to meet this requirement.

##### 802.11ac (VHT80)

Frequency Band (MHz)	Max. Power	
	Output Power (mW)	Output Power (dBm)
5250~5350	21.184	13.26
5470~5725	30.974	14.91

Note: Manufacturer provides Transmit Power Control description to meet this requirement.

## Test Mode C

### 2TX

#### 802.11a

Frequency Band (MHz)	Max. Power	
	Output Power (mW)	Output Power (dBm)
5250~5350	141.447	21.51
5470~5725	147.931	21.70

Note: Manufacturer provides Transmit Power Control description to meet this requirement.

#### 802.11n (HT20)

Frequency Band (MHz)	Max. Power	
	Output Power (mW)	Output Power (dBm)
5250~5350	110.166	20.42
5470~5725	111.959	20.49

Note: Manufacturer provides Transmit Power Control description to meet this requirement.

#### 802.11n (HT40)

Frequency Band (MHz)	Max. Power	
	Output Power (mW)	Output Power (dBm)
5250~5350	109.932	20.41
5470~5725	119.423	20.77

Note: Manufacturer provides Transmit Power Control description to meet this requirement.

#### 802.11ac (VHT80)

Frequency Band (MHz)	Max. Power	
	Output Power (mW)	Output Power (dBm)
5250~5350	37.159	15.70
5470~5725	52.914	17.24

Note: Manufacturer provides Transmit Power Control description to meet this requirement.

### Test Mode C

#### 3TX

##### 802.11a

Frequency Band (MHz)	Max. Power	
	Output Power (mW)	Output Power (dBm)
5250~5350	80.071	19.03
5470~5725	87.039	19.40

Note: Manufacturer provides Transmit Power Control description to meet this requirement.

##### 802.11n (HT20)

Frequency Band (MHz)	Max. Power	
	Output Power (mW)	Output Power (dBm)
5250~5350	74.922	18.75
5470~5725	74.978	18.75

Note: Manufacturer provides Transmit Power Control description to meet this requirement.

##### 802.11n (HT40)

Frequency Band (MHz)	Max. Power	
	Output Power (mW)	Output Power (dBm)
5250~5350	75.980	18.81
5470~5725	80.628	19.06

Note: Manufacturer provides Transmit Power Control description to meet this requirement.

##### 802.11ac (VHT80)

Frequency Band (MHz)	Max. Power	
	Output Power (mW)	Output Power (dBm)
5250~5350	60.746	17.84
5470~5725	65.484	18.16

Note: Manufacturer provides Transmit Power Control description to meet this requirement.



## Test Mode C

### 4TX

#### 802.11a

Frequency Band (MHz)	Max. Power	
	Output Power (mW)	Output Power (dBm)
5250~5350	62.315	17.95
5470~5725	63.202	18.01

Note: Manufacturer provides Transmit Power Control description to meet this requirement.

#### 802.11n (HT20)

Frequency Band (MHz)	Max. Power	
	Output Power (mW)	Output Power (dBm)
5250~5350	56.499	17.52
5470~5725	55.916	17.48

Note: Manufacturer provides Transmit Power Control description to meet this requirement.

#### 802.11n (HT40)

Frequency Band (MHz)	Max. Power	
	Output Power (mW)	Output Power (dBm)
5250~5350	56.968	17.56
5470~5725	59.216	17.72

Note: Manufacturer provides Transmit Power Control description to meet this requirement.

#### 802.11ac (VHT80)

Frequency Band (MHz)	Max. Power	
	Output Power (mW)	Output Power (dBm)
5250~5350	57.347	17.59
5470~5725	59.098	17.72

Note: Manufacturer provides Transmit Power Control description to meet this requirement.

## 4.4 Peak Power Spectral Density Measurement

### 4.4.1 Limits of Peak Power Spectral Density Measurement

Operation Band	EUT Category		LIMIT
U-NII-1	-	Outdoor Access Point	17dBm/ MHz
	-	Fixed point-to-point Access Point	
	-	Indoor Access Point	
	-	Mobile and Portable client device	11dBm/ MHz
U-NII-2A	√		11dBm/ MHz
U-NII-2C	√		11dBm/ MHz
U-NII-3	-		30dBm/ 500kHz

### 4.4.2 Test Setup

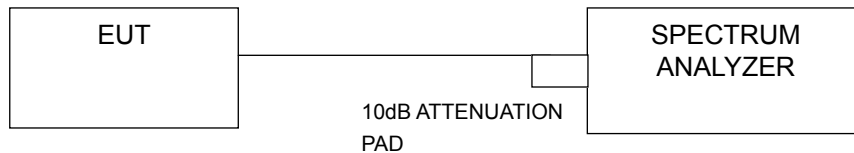

### 4.4.3 Test Instruments

Refer to section 4.1.2 to get information of above instrument.

### 4.4.4 Test Procedures

Using method SA-2

- Set span to encompass the entire emission bandwidth (EBW) of the signal.
- Set RBW = 1 MHz, Set VBW  $\geq$  3 MHz, Detector = RMS
- Sweep time = auto, trigger set to "free run".
- Trace average at least 100 traces in power averaging mode.
- Record the max value and add 10 log (1/duty cycle)

### 4.4.5 Deviation from Test Standard

No deviation.

### 4.4.6 EUT Operating Conditions

Same as Item 4.3.6.

#### 4.4.7 Test Results

##### Test Mode C

##### 1TX

##### 802.11a

Chan.	Freq. (MHz)	PSD (dBm)	Max. Limit (dBm)	Pass / Fail
52	5260	9.06	11.00	Pass
60	5300	9.12	11.00	Pass
64	5320	7.44	11.00	Pass
100	5500	7.98	11.00	Pass
116	5580	8.90	11.00	Pass
140	5700	6.28	11.00	Pass

##### 802.11n (HT20)

Chan.	Freq. (MHz)	PSD (dBm)	Max. Limit (dBm)	Pass / Fail
52	5260	8.64	11.00	Pass
60	5300	8.70	11.00	Pass
64	5320	6.44	11.00	Pass
100	5500	7.07	11.00	Pass
116	5580	8.47	11.00	Pass
140	5700	5.14	11.00	Pass

##### 802.11n (HT40)

Chan.	Freq. (MHz)	PSD w/o duty factor (dBm)	Duty factor	PSD with duty factor (dBm)	Max. Limit (dBm)	Pass / Fail
54	5270	5.53	0.09	5.62	11.00	Pass
62	5310	1.27	0.09	1.36	11.00	Pass
102	5510	1.19	0.09	1.28	11.00	Pass
110	5550	6.17	0.09	6.26	11.00	Pass
134	5670	3.03	0.09	3.12	11.00	Pass

##### 802.11ac (VHT80)

Chan.	Freq. (MHz)	PSD w/o duty factor (dBm)	Duty factor	PSD with duty factor (dBm)	Max. Limit (dBm)	Pass / Fail
58	5290	-7.83	0.18	-7.65	11.00	Pass
106	5530	-5.83	0.18	-5.65	11.00	Pass

### Spectrum Plot of Worst Value

802.11a / Ch 60

802.11n (HT20) / Ch 60

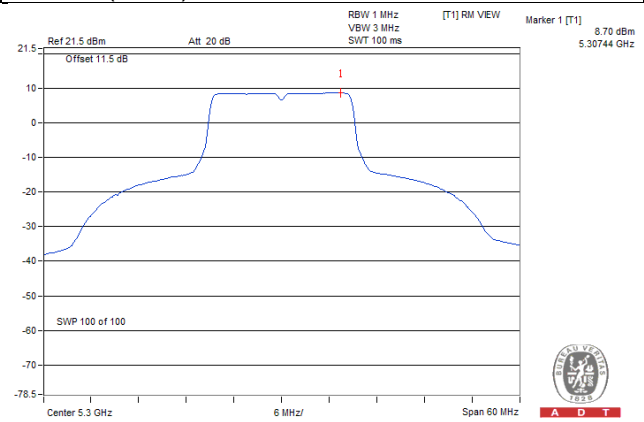
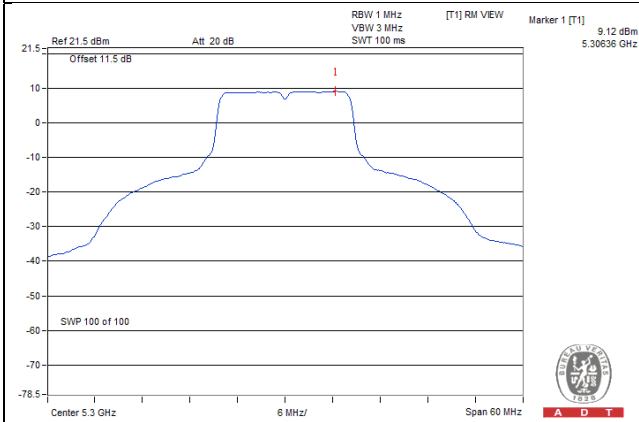

802.11n (HT40) / Ch 110

802.11ac (VHT80) / Ch 106

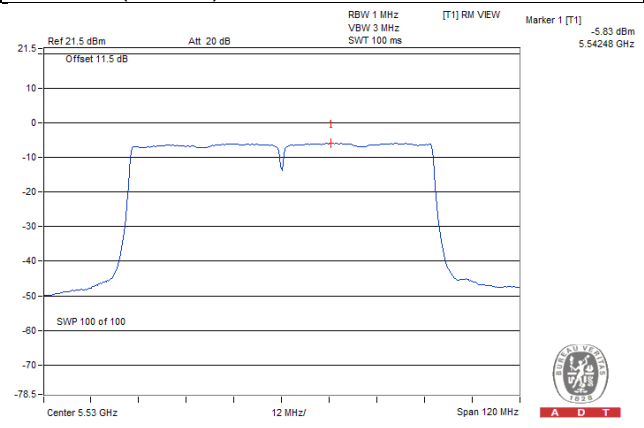
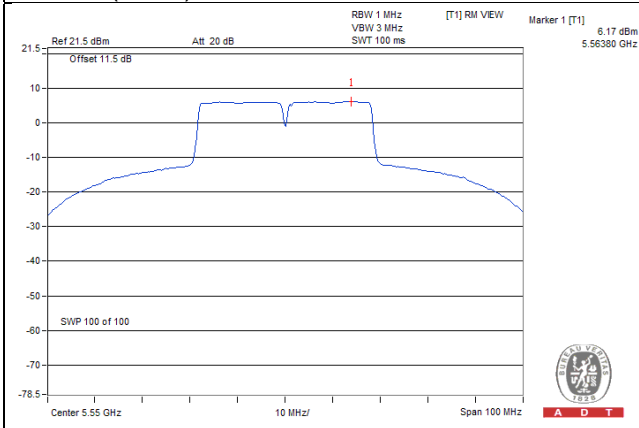

## Test Mode C

### 2TX

#### 802.11a

Chan.	Freq. (MHz)	PSD (dBm)		Total PSD w/o duty factor (dBm)	Duty factor	Total PSD with duty factor (dBm)	Max. Limit (dBm)	Pass / Fail
		Chain 0	Chain 1					
52	5260	4.72	4.58	7.67	0.10	7.77	7.99	Pass
60	5300	5.04	4.69	7.88	0.10	7.98	7.99	Pass
64	5320	4.97	4.63	7.82	0.10	7.92	7.99	Pass
100	5500	4.94	4.50	7.74	0.10	7.84	7.99	Pass
116	5580	4.73	4.91	7.84	0.10	7.94	7.99	Pass
140	5700	4.40	4.23	7.33	0.10	7.43	7.99	Pass

**Note:**

- Method 1 of power density measurement of KDB 662911 is using for calculating total power density. Total power density is summing entire spectra across corresponding frequency bins on the various outputs by computer.
- Directional gain =  $6\text{dBi} + 10 \log(2) = 9.01\text{dBi} > 6\text{dBi}$ , so the power density limit shall be reduced to  $11 - (9.01 - 6) = 7.99\text{dBm}$ .
- Refer to section 3.3 for duty cycle spectrum plot.

#### 802.11n (HT20)

Chan.	Freq. (MHz)	PSD (dBm)		Total PSD (dBm)	Max. Limit (dBm)	Pass / Fail
		Chain 0	Chain 1			
52	5260	3.28	2.87	6.10	7.99	Pass
60	5300	3.23	2.78	6.03	7.99	Pass
64	5320	3.30	2.59	5.98	7.99	Pass
100	5500	3.59	3.36	6.49	7.99	Pass
116	5580	3.01	2.95	6.00	7.99	Pass
140	5700	3.16	3.03	6.11	7.99	Pass

**Note:**

- Method 1 of power density measurement of KDB 662911 is using for calculating total power density. Total power density is summing entire spectra across corresponding frequency bins on the various outputs by computer.
- Directional gain =  $6\text{dBi} + 10 \log(2) = 9.01\text{dBi} > 6\text{dBi}$ , so the power density limit shall be reduced to  $11 - (9.01 - 6) = 7.99\text{dBm}$ .

### 802.11n (HT40)

Chan.	Freq. (MHz)	PSD (dBm)		Total PSD w/o duty factor (dBm)	Duty factor	Total PSD with duty factor (dBm)	Max. Limit (dBm)	Pass / Fail
		Chain 0	Chain 1					
54	5270	0.39	-0.01	3.20	0.13	3.33	7.99	Pass
62	5310	-1.91	-2.09	1.01	0.13	1.14	7.99	Pass
102	5510	0.07	-0.12	2.98	0.13	3.11	7.99	Pass
110	5550	0.22	0.17	3.20	0.13	3.33	7.99	Pass
134	5670	0.24	0.03	3.14	0.13	3.27	7.99	Pass

Note:

1. Method 1 of power density measurement of KDB 662911 is using for calculating total power density. Total power density is summing entire spectra across corresponding frequency bins on the various outputs by computer.
2. Directional gain = 6dBi+ 10 log(2) = 9.01dBi > 6dBi, so the power density limit shall be reduced to 11-(9.01-6) = 7.99dBm.
3. Refer to section 3.3 for duty cycle spectrum plot.

### 802.11ac (VHT80)

Chan.	Freq. (MHz)	PSD (dBm)		Total PSD w/o duty factor (dBm)	Duty factor	Total PSD with duty factor (dBm)	Max. Limit (dBm)	Pass / Fail
		Chain 0	Chain 1					
58	5290	-7.74	-8.41	-5.05	0.17	-4.88	7.99	Pass
106	5530	-6.57	-6.54	-3.55	0.17	-3.38	7.99	Pass

Note:

1. Method 1 of power density measurement of KDB 662911 is using for calculating total power density. Total power density is summing entire spectra across corresponding frequency bins on the various outputs by computer.
2. Directional gain = 6dBi+ 10 log(2) = 9.01dBi > 6dBi, so the power density limit shall be reduced to 11-(9.01-6) = 7.99dBm.
3. Refer to section 3.3 for duty cycle spectrum plot.

### Spectrum Plot of Worst Value

802.11a / Ch 60 / Chain 0

802.11n (HT20) / Ch 100 / Chain 0

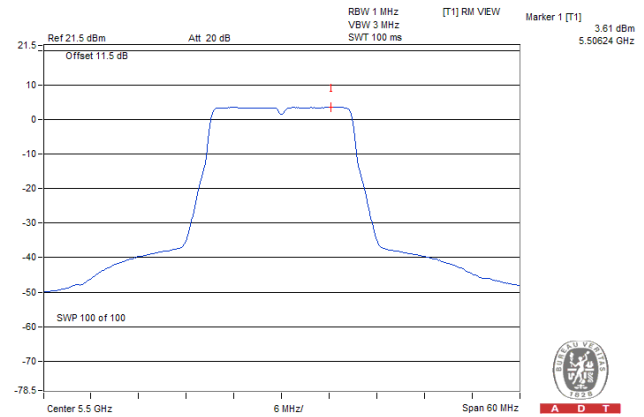
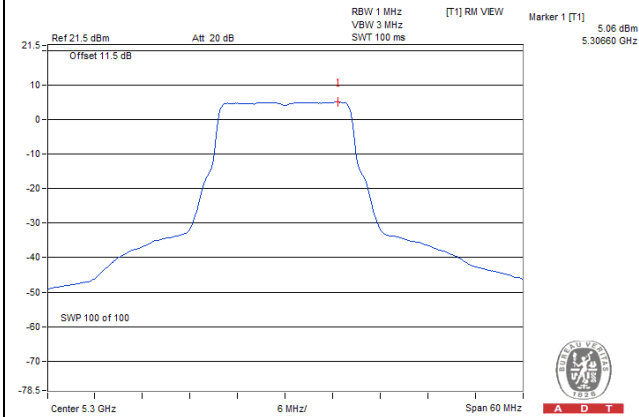

802.11n (HT40) / Ch 54 / Chain 0

802.11ac (VHT80) / Ch 106 / Chain 1

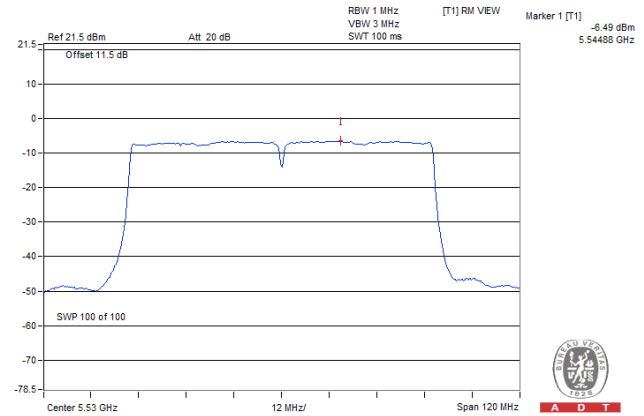
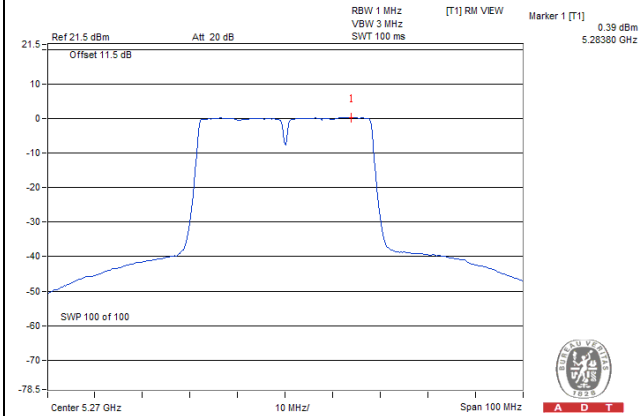

### Test Mode C

### 3TX

#### 802.11a

Chan.	Freq. (MHz)	PSD (dBm)			Total PSD (dBm)	Max. Limit (dBm)	Pass / Fail
		Chain 0	Chain 1	Chain 2			
52	5260	0.76	0.57	1.30	5.66	6.23	Pass
60	5300	0.75	0.55	1.48	5.72	6.23	Pass
64	5320	0.93	0.49	1.33	5.70	6.23	Pass
100	5500	0.91	0.94	1.13	5.77	6.23	Pass
116	5580	1.15	1.20	1.75	6.15	6.23	Pass
140	5700	1.04	1.19	1.62	6.06	6.23	Pass

Note:

- Method 1 of power density measurement of KDB 662911 is using for calculating total power density. Total power density is summing entire spectra across corresponding frequency bins on the various outputs by computer.
- Directional gain = 6dBi+ 10 log(3) = 10.77dBi > 6dBi, so the power density limit shall be reduced to 11-(10.77-6) = 6.23dBm.
- Refer to section 3.3 for duty cycle spectrum plot.

#### 802.11n (HT20)

Chan.	Freq. (MHz)	PSD (dBm)			Total PSD (dBm)	Max. Limit (dBm)	Pass / Fail
		Chain 0	Chain 1	Chain 2			
52	5260	-0.76	-1.09	-0.08	4.15	6.23	Pass
60	5300	-0.86	-0.88	0.02	4.22	6.23	Pass
64	5320	-0.95	-0.90	0.06	4.20	6.23	Pass
100	5500	-0.59	-0.53	-0.33	4.29	6.23	Pass
116	5580	-1.40	-0.86	-0.35	3.92	6.23	Pass
140	5700	-1.29	-0.84	-0.59	3.87	6.23	Pass

Note:

- Method 1 of power density measurement of KDB 662911 is using for calculating total power density. Total power density is summing entire spectra across corresponding frequency bins on the various outputs by computer.
- Directional gain = 6dBi+ 10 log(3) = 10.77dBi > 6dBi, so the power density limit shall be reduced to 11-(10.77-6) = 6.23dBm.
- Refer to section 3.3 for duty cycle spectrum plot.



### 802.11n (HT40)

Chan.	Freq. (MHz)	PSD (dBm)			Total PSD w/o duty factor (dBm)	Duty factor	Total PSD with duty factor (dBm)	Max. Limit (dBm)	Pass / Fail
		Chain 0	Chain 1	Chain 2					
54	5270	-4.08	-3.92	-2.75	1.23	0.13	1.36	6.23	Pass
62	5310	-4.02	-3.94	-2.81	1.22	0.13	1.35	6.23	Pass
102	5510	-3.68	-3.54	-2.72	1.48	0.13	1.61	6.23	Pass
110	5550	-4.08	-3.62	-2.79	1.31	0.13	1.44	6.23	Pass
134	5670	-4.23	-3.69	-2.85	1.22	0.13	1.35	6.23	Pass

Note:

1. Method 1 of power density measurement of KDB 662911 is using for calculating total power density. Total power density is summing entire spectra across corresponding frequency bins on the various outputs by computer.
2. Directional gain =  $6\text{dBi} + 10 \log(3) = 10.77\text{dBi} > 6\text{dBi}$ , so the power density limit shall be reduced to  $11 - (10.77 - 6) = 6.23\text{dBm}$ .
3. Refer to section 3.3 for duty cycle spectrum plot.

### 802.11ac (VHT80)

Chan.	Freq. (MHz)	PSD (dBm)			Total PSD w/o duty factor (dBm)	Duty factor	Total PSD with duty factor (dBm)	Max. Limit (dBm)	Pass / Fail
		Chain 0	Chain 1	Chain 2					
58	5290	-8.40	-8.73	-7.57	-3.44	0.18	-3.26	6.23	Pass
106	5530	-8.65	-7.90	-7.61	-3.26	0.18	-3.08	6.23	Pass

Note:

1. Method 1 of power density measurement of KDB 662911 is using for calculating total power density. Total power density is summing entire spectra across corresponding frequency bins on the various outputs by computer.
2. Directional gain =  $6\text{dBi} + 10 \log(3) = 10.77\text{dBi} > 6\text{dBi}$ , so the power density limit shall be reduced to  $11 - (10.77 - 6) = 6.23\text{dBm}$ .
3. Refer to section 3.3 for duty cycle spectrum plot.

### Spectrum Plot of Worst Value

802.11a / Ch 116 / Chain 2

802.11n (HT20) / Ch 64 / Chain 2

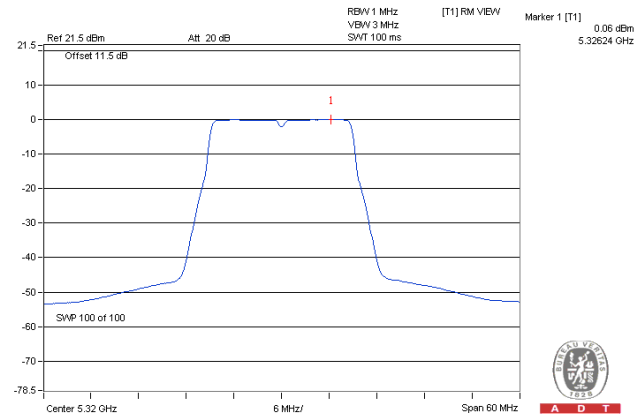
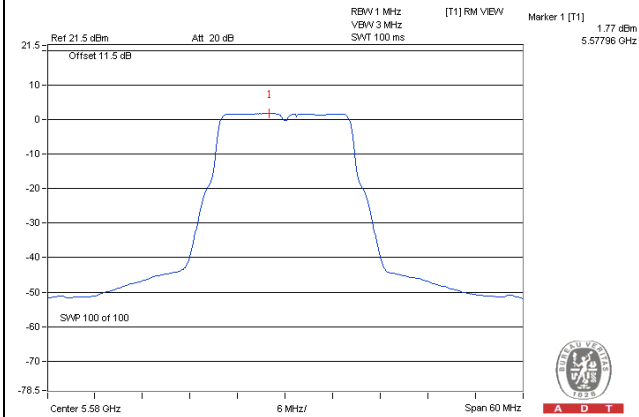

802.11n (HT40) / Ch 102 / Chain 2

802.11ac (VHT80) / Ch 58 / Chain 2

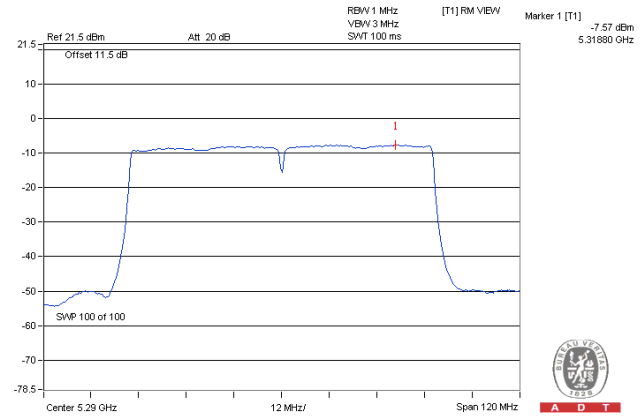
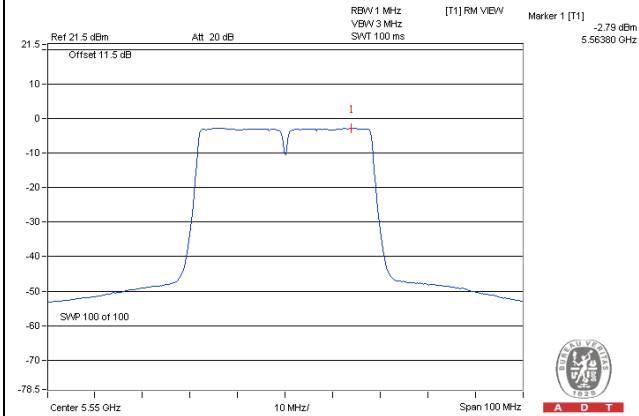

## Test Mode C

### 4TX

#### 802.11a

Chan.	Freq. (MHz)	PSD (dBm)				Total PSD w/o duty factor (dBm)	Duty factor	Total PSD with duty factor (dBm)	Max. Limit (dBm)	Pass / Fail
		Chain 0	Chain 1	Chain 2	Chain 3					
52	5260	-1.52	-1.88	-0.82	-2.15	4.46	0.12	4.58	4.98	Pass
60	5300	-1.43	-1.84	-0.84	-1.98	4.52	0.12	4.64	4.98	Pass
64	5320	-1.69	-1.72	-0.85	-1.91	4.50	0.12	4.62	4.98	Pass
100	5500	-1.04	-1.78	-1.43	-1.00	4.72	0.12	4.84	4.98	Pass
116	5580	-1.78	-1.44	-0.73	-1.45	4.69	0.12	4.81	4.98	Pass
140	5700	-1.47	-2.08	-0.79	-1.28	4.64	0.12	4.76	4.98	Pass

Note:

- Method 1 of power density measurement of KDB 662911 is using for calculating total power density. Total power density is summing entire spectra across corresponding frequency bins on the various outputs by computer.
- Directional gain =  $6\text{dBi} + 10 \log(4) = 12.02\text{dBi} > 6\text{dBi}$ , so the power density limit shall be reduced to  $11 - (12.02 - 6) = 4.98\text{dBm}$ .
- Refer to section 3.3 for duty cycle spectrum plot.

#### 802.11n (HT20)

Chan.	Freq. (MHz)	PSD (dBm)				Total PSD (dBm)	Max. Limit (dBm)	Pass / Fail
		Chain 0	Chain 1	Chain 2	Chain 3			
52	5260	-3.30	-3.68	-2.19	-3.36	2.93	4.98	Pass
60	5300	-3.28	-3.63	-2.32	-3.40	2.89	4.98	Pass
64	5320	-3.36	-3.52	-2.21	-3.03	3.02	4.98	Pass
100	5500	-2.94	-3.22	-2.59	-2.34	3.26	4.98	Pass
116	5580	-3.75	-3.36	-2.56	-2.61	2.98	4.98	Pass
140	5700	-3.46	-4.28	-2.80	-3.02	2.67	4.98	Pass

Note:

- Method 1 of power density measurement of KDB 662911 is using for calculating total power density. Total power density is summing entire spectra across corresponding frequency bins on the various outputs by computer.
- Directional gain =  $6\text{dBi} + 10 \log(4) = 12.02\text{dBi} > 6\text{dBi}$ , so the power density limit shall be reduced to  $11 - (12.02 - 6) = 4.98\text{dBm}$ .

### 802.11n (HT40)

Chan.	Freq. (MHz)	PSD (dBm)				Total PSD w/o duty factor (dBm)	Duty factor	Total PSD with duty factor (dBm)	Max. Limit (dBm)	Pass / Fail
		Chain 0	Chain 1	Chain 2	Chain 3					
54	5270	-6.31	-6.56	-5.32	-6.27	-0.07	0.25	0.18	4.98	Pass
62	5310	-6.27	-6.49	-5.20	-6.25	-0.01	0.25	0.24	4.98	Pass
102	5510	-5.96	-6.23	-4.92	-5.96	0.28	0.25	0.53	4.98	Pass
110	5550	-6.42	-6.53	-5.03	-6.29	-0.01	0.25	0.24	4.98	Pass
134	5670	-6.35	-7.14	-5.23	-6.42	-0.21	0.25	0.04	4.98	Pass

Note:

1. Method 1 of power density measurement of KDB 662911 is using for calculating total power density. Total power density is summing entire spectra across corresponding frequency bins on the various outputs by computer.
2. Directional gain =  $6\text{dBi} + 10 \log(4) = 12.02\text{dBi} > 6\text{dBi}$ , so the power density limit shall be reduced to  $11 - (12.02 - 6) = 4.98\text{dBm}$ .
3. Refer to section 3.3 for duty cycle spectrum plot.

### 802.11ac (VHT80)

Chan.	Freq. (MHz)	PSD (dBm)				Total PSD w/o duty factor (dBm)	Duty factor	Total PSD with duty factor (dBm)	Max. Limit (dBm)	Pass / Fail
		Chain 0	Chain 1	Chain 2	Chain 3					
58	5290	-8.95	-9.57	-7.78	-8.94	-2.74	0.27	-2.47	4.98	Pass
106	5530	-9.75	-9.44	-8.43	-8.98	-3.10	0.27	-2.83	4.98	Pass

Note:

1. Method 1 of power density measurement of KDB 662911 is using for calculating total power density. Total power density is summing entire spectra across corresponding frequency bins on the various outputs by computer.
2. Directional gain =  $6\text{dBi} + 10 \log(4) = 12.02\text{dBi} > 6\text{dBi}$ , so the power density limit shall be reduced to  $11 - (12.02 - 6) = 4.98\text{dBm}$ .
3. Refer to section 3.3 for duty cycle spectrum plot.

**Spectrum Plot of Worst Value**

**802.11a / Ch 116 / Chain 2**

**802.11n (HT20) / Ch 52 / Chain 2**

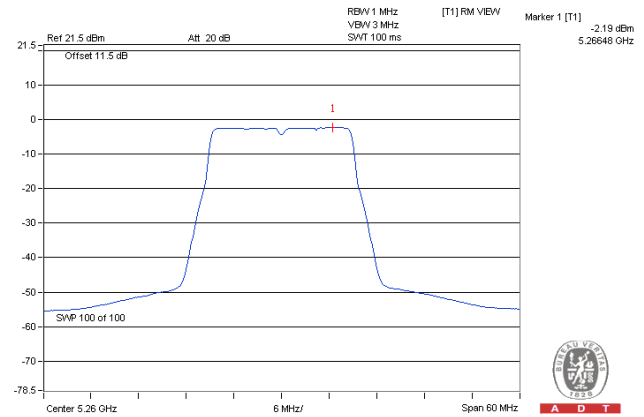
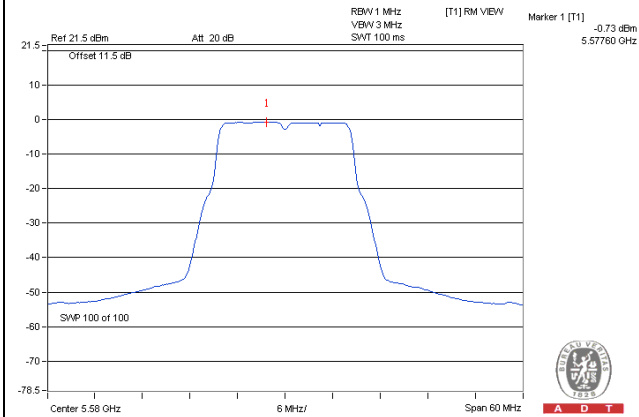

**802.11n (HT40) / Ch 102 / Chain 2**

**802.11ac (VHT80) / Ch 58 / Chain 2**

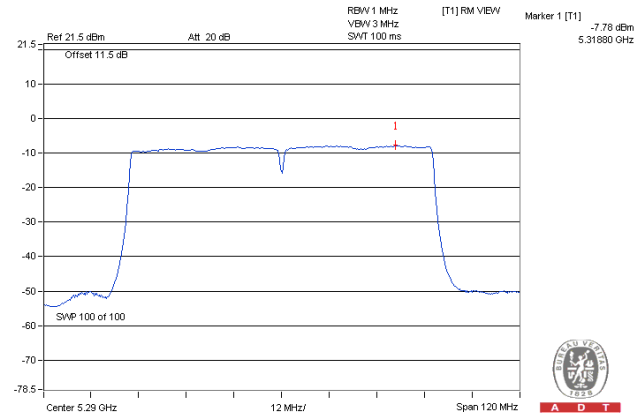
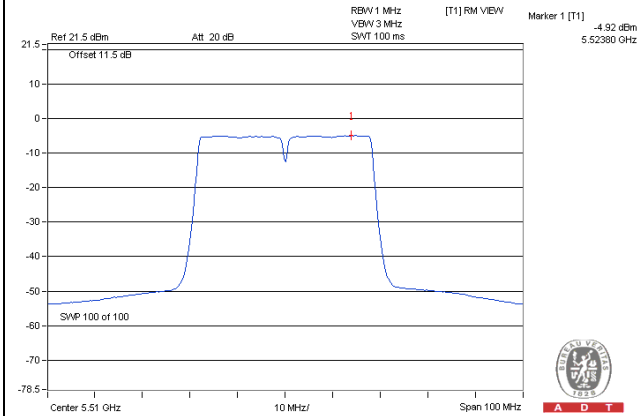

## 4.5 Frequency Stability

### 4.5.1 Limits of Frequency Stability Measurement

The frequency of the carrier signal shall be maintained within band of operation

### 4.5.2 Test Setup

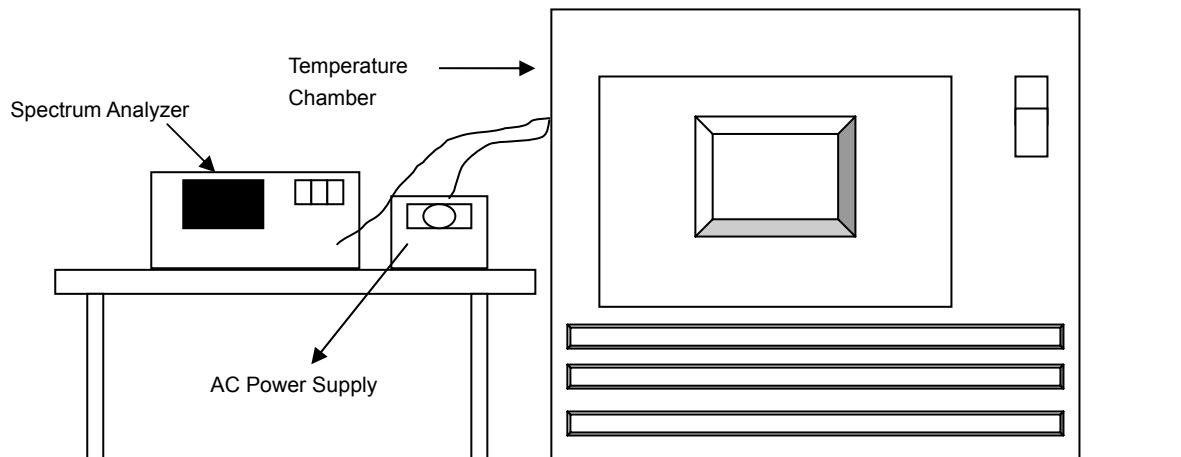

### 4.5.3 Test Instruments

Refer to section 4.1.2 to get information of above instrument.

### 4.5.4 Test Procedure

- a. The EUT was placed inside the environmental test chamber and powered by nominal AC voltage.
- b. Turn the EUT on and couple its output to a spectrum analyzer.
- c. Turn the EUT off and set the chamber to the highest temperature specified.
- d. Allow sufficient time (approximately 30 min) for the temperature of the chamber to stabilize, turn the EUT on and measure the operating frequency after 2, 5, and 10 minutes.
- e. Repeat step 2 and 3 with the temperature chamber set to the lowest temperature.
- f. The test chamber was allowed to stabilize at +20 degree C for a minimum of 30 minutes. The supply voltage was then adjusted on the EUT from 85% to 115% and the frequency record.

### 4.5.5 Deviation from Test Standard

No deviation.

### 4.5.6 EUT Operating Condition

Set the EUT transmit at un-modulation mode to test frequency stability.

## 4.5.7 Test Results

### Test Mode C

#### 1TX

Frequency Stability Versus Temp.									
Operating Frequency: 5260MHz									
Temp. (°C)	Power Supply (Vac)	0 Minute		2 Minute		5 Minute		10 Minute	
		Measured Frequency (MHz)	Frequency Drift (%)	Measured Frequency (MHz)	Frequency Drift (%)	Measured Frequency (MHz)	Frequency Drift (%)	Measured Frequency (MHz)	Frequency Drift (%)
50	120	5259.9977	-0.00004	5259.9965	-0.00007	5259.9962	-0.00007	5259.9977	-0.00004
40	120	5260.0015	0.00003	5259.9971	-0.00006	5259.9993	-0.00001	5260.0003	0.00001
30	120	5259.9880	-0.00023	5259.9869	-0.00025	5259.9894	-0.00020	5259.9869	-0.00025
20	120	5260.0128	0.00024	5260.0114	0.00022	5260.0121	0.00023	5260.0139	0.00026
10	120	5259.9944	-0.00011	5259.9896	-0.00020	5259.9922	-0.00015	5259.9936	-0.00012
0	120	5260.0221	0.00042	5260.0253	0.00048	5260.0217	0.00041	5260.0259	0.00049
-10	120	5260.0163	0.00031	5260.0158	0.00030	5260.0176	0.00033	5260.0186	0.00035
-20	120	5259.9839	-0.00031	5259.9842	-0.00030	5259.9865	-0.00026	5259.9842	-0.00030
-30	120	5259.9783	-0.00041	5259.9815	-0.00035	5259.9806	-0.00037	5259.9775	-0.00043

Frequency Stability Versus Voltage									
Operating Frequency: 5260MHz									
Temp. (°C)	Power Supply (Vac)	0 Minute		2 Minute		5 Minute		10 Minute	
		Measured Frequency (MHz)	Frequency Drift (%)	Measured Frequency (MHz)	Frequency Drift (%)	Measured Frequency (MHz)	Frequency Drift (%)	Measured Frequency (MHz)	Frequency Drift (%)
20	138	5260.0124	0.00024	5260.0111	0.00021	5260.0117	0.00022	5260.0136	0.00026
	120	5260.0128	0.00024	5260.0114	0.00022	5260.0121	0.00023	5260.0139	0.00026
	102	5260.0135	0.00026	5260.0113	0.00021	5260.0126	0.00024	5260.0146	0.00028

**Test Mode C**
**2TX**

Frequency Stability Versus Temp.									
Operating Frequency: 5260MHz									
Temp. (°C)	Power Supply (Vac)	0 Minute		2 Minute		5 Minute		10 Minute	
		Measured Frequency (MHz)	Frequency Drift (%)	Measured Frequency (MHz)	Frequency Drift (%)	Measured Frequency (MHz)	Frequency Drift (%)	Measured Frequency (MHz)	Frequency Drift (%)
50	120	5259.9903	-0.00018	5259.9915	-0.00016	5259.9905	-0.00018	5259.9904	-0.00018
40	120	5259.9993	-0.00001	5260.0002	0.00000	5259.9985	-0.00003	5259.9966	-0.00006
30	120	5260.0043	0.00008	5260.0039	0.00007	5260.0055	0.00010	5260.0017	0.00003
20	120	5259.9981	-0.00004	5259.9980	-0.00004	5259.9959	-0.00008	5259.9968	-0.00006
10	120	5260.0124	0.00024	5260.0129	0.00025	5260.0165	0.00031	5260.0161	0.00031
0	120	5259.9906	-0.00018	5259.9893	-0.00020	5259.9898	-0.00019	5259.9883	-0.00022
-10	120	5260.0183	0.00035	5260.0190	0.00036	5260.0186	0.00035	5260.0223	0.00042
-20	120	5259.9724	-0.00052	5259.9744	-0.00049	5259.9729	-0.00052	5259.9727	-0.00052
-30	120	5260.0215	0.00041	5260.0241	0.00046	5260.0212	0.00040	5260.0255	0.00048

Frequency Stability Versus Voltage									
Operating Frequency: 5260MHz									
Temp. (°C)	Power Supply (Vac)	0 Minute		2 Minute		5 Minute		10 Minute	
		Measured Frequency (MHz)	Frequency Drift (%)	Measured Frequency (MHz)	Frequency Drift (%)	Measured Frequency (MHz)	Frequency Drift (%)	Measured Frequency (MHz)	Frequency Drift (%)
20	138	5259.9974	-0.00005	5259.9988	-0.00002	5259.9966	-0.00006	5259.9960	-0.00008
	120	5259.9981	-0.00004	5259.998	-0.00004	5259.9959	-0.00008	5259.9968	-0.00006
	102	5259.9991	-0.00002	5259.9972	-0.00005	5259.9965	-0.00007	5259.9972	-0.00005



**Test Mode C**
**3TX**

Frequency Stability Versus Temp.									
Operating Frequency: 5260MHz									
Temp. (°C)	Power Supply (Vac)	0 Minute		2 Minute		5 Minute		10 Minute	
		Measured Frequency (MHz)	Frequency Drift (%)	Measured Frequency (MHz)	Frequency Drift (%)	Measured Frequency (MHz)	Frequency Drift (%)	Measured Frequency (MHz)	Frequency Drift (%)
50	120	5259.9758	-0.00046	5259.9736	-0.00050	5259.9728	-0.00052	5259.9763	-0.00045
40	120	5259.9939	-0.00012	5259.9932	-0.00013	5259.9951	-0.00009	5259.9962	-0.00007
30	120	5260.0158	0.00030	5260.0162	0.00031	5260.0183	0.00035	5260.0149	0.00028
20	120	5259.9776	-0.00043	5259.9791	-0.00040	5259.9794	-0.00039	5259.9787	-0.00040
10	120	5260.0251	0.00048	5260.0254	0.00048	5260.0248	0.00047	5260.0256	0.00049
0	120	5259.9809	-0.00036	5259.9823	-0.00034	5259.9792	-0.00040	5259.9810	-0.00036
-10	120	5259.9963	-0.00007	5259.9976	-0.00005	5259.9982	-0.00003	5259.9956	-0.00008
-20	120	5259.9814	-0.00035	5259.9816	-0.00035	5259.9821	-0.00034	5259.9814	-0.00035
-30	120	5259.9793	-0.00039	5259.9784	-0.00041	5259.981	-0.00036	5259.9784	-0.00041

Frequency Stability Versus Voltage									
Operating Frequency: 5260MHz									
Temp. (°C)	Power Supply (Vac)	0 Minute		2 Minute		5 Minute		10 Minute	
		Measured Frequency (MHz)	Frequency Drift (%)	Measured Frequency (MHz)	Frequency Drift (%)	Measured Frequency (MHz)	Frequency Drift (%)	Measured Frequency (MHz)	Frequency Drift (%)
20	138	5259.9769	-0.00044	5259.9782	-0.00041	5259.9793	-0.00039	5259.9795	-0.00039
	120	5259.9776	-0.00043	5259.9791	-0.00040	5259.9794	-0.00039	5259.9787	-0.00040
	102	5259.9785	-0.00041	5259.9789	-0.00040	5259.9800	-0.00038	5259.9797	-0.00039

**Test Mode C**
**4TX**

Frequency Stability Versus Temp.									
Operating Frequency: 5260MHz									
Temp. (°C)	Power Supply (Vac)	0 Minute		2 Minute		5 Minute		10 Minute	
		Measured Frequency (MHz)	Frequency Drift (%)	Measured Frequency (MHz)	Frequency Drift (%)	Measured Frequency (MHz)	Frequency Drift (%)	Measured Frequency (MHz)	Frequency Drift (%)
50	120	5260.0026	0.00005	5260.0014	0.00003	5260.0040	0.00008	5260.0039	0.00007
40	120	5260.0160	0.00030	5260.0130	0.00025	5260.0128	0.00024	5260.0160	0.00030
30	120	5259.9767	-0.00044	5259.9785	-0.00041	5259.9779	-0.00042	5259.9785	-0.00041
20	120	5260.0167	0.00032	5260.0165	0.00031	5260.0179	0.00034	5260.0151	0.00029
10	120	5260.0177	0.00034	5260.0154	0.00029	5260.0187	0.00036	5260.0196	0.00037
0	120	5259.9945	-0.00010	5259.9930	-0.00013	5259.9946	-0.00010	5259.9942	-0.00011
-10	120	5260.0124	0.00024	5260.0142	0.00027	5260.0095	0.00018	5260.0134	0.00025
-20	120	5259.9788	-0.00040	5259.9763	-0.00045	5259.9756	-0.00046	5259.9799	-0.00038
-30	120	5259.9852	-0.00028	5259.9850	-0.00029	5259.9818	-0.00035	5259.9820	-0.00034

Frequency Stability Versus Voltage									
Operating Frequency: 5260MHz									
Temp. (°C)	Power Supply (Vac)	0 Minute		2 Minute		5 Minute		10 Minute	
		Measured Frequency (MHz)	Frequency Drift (%)	Measured Frequency (MHz)	Frequency Drift (%)	Measured Frequency (MHz)	Frequency Drift (%)	Measured Frequency (MHz)	Frequency Drift (%)
20	138	5260.0168	0.00032	5260.0157	0.00030	5260.0185	0.00035	5260.0141	0.00027
	120	5260.0167	0.00032	5260.0165	0.00031	5260.0179	0.00034	5260.0151	0.00029
	102	5260.0168	0.00032	5260.0163	0.00031	5260.0177	0.00034	5260.0157	0.00030

## 5 Pictures of Test Arrangements

Please refer to the attached file (Test Setup Photo).

## Appendix – Information on the Testing Laboratories

We, Bureau Veritas Consumer Products Services (H.K.) Ltd., Taoyuan Branch, were founded in 1988 to provide our best service in EMC, Radio, Telecom and Safety consultation. Our laboratories are accredited and approved according to ISO/IEC 17025.

If you have any comments, please feel free to contact us at the following:

**Linko EMC/RF Lab**

Tel: 886-2-26052180

Fax: 886-2-26051924

**Hsin Chu EMC/RF/Telecom Lab**

Tel: 886-3-6668565

Fax: 886-3-6668323

**Hwa Ya EMC/RF/Safety**

Tel: 886-3-3183232

Fax: 886-3-3270892

**Email:** [service.adt@tw.bureauveritas.com](mailto:service.adt@tw.bureauveritas.com)

**Web Site:** [www.bureauveritas-adt.com](http://www.bureauveritas-adt.com)

The address and road map of all our labs can be found in our web site also.

--- END ---