

FCC Test Report

Report No.: RF151230E03B-2

FCC ID: 2AHBN-AP41

Test Model: AP41

Series Model: AP41E

Received Date: Dec. 23, 2015

Test Date: Jan. 08 ~ Jan. 26, 2016

Issued Date: May 11, 2016

Applicant: Mist Systems, Inc.

Address: 1601 South De Anza Blvd. Suite 248 Cupertino California United States
95014

Issued By: Bureau Veritas Consumer Products Services (H.K.) Ltd., Taoyuan Branch

Lab Address: No. 47-2, 14th Ling, Chia Pau Vil., Lin Kou Dist., New Taipei City, Taiwan,
R.O.C.

Test Location: No.19, Hwa Ya 2nd Rd., Wen Hwa Vil., Kwei Shan Dist., Taoyuan City
33383, TAIWAN (R.O.C.)



This report is for your exclusive use. Any copying or replication of this report to or for any other person or entity, or use of our name or trademark, is permitted only with our prior written permission. This report sets forth our findings solely with respect to the test samples identified herein. The results set forth in this report are not indicative or representative of the quality or characteristics of the lot from which a test sample was taken or any similar or identical product unless specifically and expressly noted. Our report includes all of the tests requested by you and the results thereof based upon the information that you provided to us. You have 60 days from date of issuance of this report to notify us of any material error or omission caused by our negligence, provided, however, that such notice shall be in writing and shall specifically address the issue you wish to raise. A failure to raise such issue within the prescribed time shall constitute your unqualified acceptance of the completeness of this report, the tests conducted and the correctness of the report contents. Unless specific mention, the uncertainty of measurement has been explicitly taken into account to declare the compliance or non-compliance to the specification.

This report should not be used by the client to claim product certification, approval, or endorsement by TAF or any government agencies.

Table of Contents

Release Control Record	4
1 Certificate of Conformity	5
2 Summary of Test Results	6
2.1 Measurement Uncertainty.....	6
2.2 Modification Record.....	6
3 General Information	7
3.1 General Description of EUT.....	7
3.2 Description of Test Modes.....	9
3.2.1 Test Mode Applicability and Tested Channel Detail.....	10
3.3 Description of Support Units.....	12
3.3.1 Configuration of System under Test.....	12
3.4 General Description of Applied Standards.....	13
4 Test Types and Results	14
4.1 Radiated Emission and Bandedge Measurement.....	14
4.1.1 Limits of Radiated Emission and Bandedge Measurement.....	14
4.1.2 Test Instruments.....	15
4.1.3 Test Procedures.....	16
4.1.4 Deviation from Test Standard.....	16
4.1.5 Test Set Up.....	17
4.1.6 EUT Operating Conditions.....	17
4.1.7 Test Results.....	18
4.2 Conducted Emission Measurement.....	32
4.2.1 Limits of Conducted Emission Measurement.....	32
4.2.2 Test Instruments.....	32
4.2.3 Test Procedures.....	33
4.2.4 Deviation from Test Standard.....	33
4.2.5 Test Setup.....	33
4.2.6 EUT Operating Conditions.....	33
4.2.7 Test Results.....	34
4.3 Number of Hopping Frequency Used.....	38
4.3.1 Limits of Hopping Frequency Used Measurement.....	38
4.3.2 Test Setup.....	38
4.3.3 Test Instruments.....	38
4.3.4 Test Procedure.....	38
4.3.5 Deviation from Test Standard.....	38
4.3.6 Test Results.....	39
4.4 Dwell Time on Each Channel.....	40
4.4.1 Limits of Dwell Time on Each Channel Measurement.....	40
4.4.2 Test Setup.....	40
4.4.3 Test Instruments.....	40
4.4.4 Test Procedures.....	40
4.4.5 Deviation from Test Standard.....	40
4.4.6 Test Results.....	41
4.5 Channel Bandwidth.....	43
4.5.1 Limits of Channel Bandwidth Measurement.....	43
4.5.2 Test Setup.....	43
4.5.3 Test Instruments.....	43
4.5.4 Test Procedure.....	43
4.5.5 Deviation from Test Standard.....	43
4.5.6 EUT Operating Condition.....	43
4.5.7 Test Results.....	44
4.6 Hopping Channel Separation.....	45
4.6.1 Limits of Hopping Channel Separation Measurement.....	45

4.6.2	Test Setup.....	45
4.6.3	Test Instruments	45
4.6.4	Test Procedure	45
4.6.5	Deviation from Test Standard	45
4.6.6	Test Results	46
4.7	Maximum Output Power.....	47
4.7.1	Limits of Maximum Output Power Measurement	47
4.7.2	Test Setup.....	47
4.7.3	Test Instruments	47
4.7.4	Test Procedure	47
4.7.5	Deviation from Test Standard	47
4.7.6	EUT Operating Condition	47
4.7.7	Test Results	48
4.8	Conducted Out of Band Emission Measurement.....	49
4.8.1	Limits of Conducted Out of Band Emission Measurement	49
4.8.2	Test Instruments	49
4.8.3	Test Procedure	49
4.8.4	Deviation from Test Standard	49
4.8.5	EUT Operating Condition	49
4.8.6	Test Results	49
5	Pictures of Test Arrangements.....	52
	Appendix – Information on the Testing Laboratories	53



Release Control Record

Issue No.	Description	Date Issued
RF151230E03B-2	Original release	May 11, 2016

1 Certificate of Conformity

Product: Premium Wi-Fi & BLE Array AP
Brand: Mist
Test Model: AP41
Series Model: AP41E
Sample Status: Engineering Sample
Applicant: Mist Systems, Inc.
Test Date: Jan. 08 ~ Jan. 26, 2016
Standards: 47 CFR FCC Part 15, Subpart C (Section 15.247)
ANSI C63.10:2013

The above equipment has been tested by **Bureau Veritas Consumer Products Services (H.K.) Ltd., Taoyuan Branch**, and found compliance with the requirement of the above standards. The test record, data evaluation & Equipment Under Test (EUT) configurations represented herein are true and accurate accounts of the measurements of the sample's EMC characteristics under the conditions specified in this report.

Prepared by :  , **Date:** May 11, 2016
Polly Chien / Specialist

Approved by :  , **Date:** May 11, 2016
Ken Liu / Senior Manager

2 Summary of Test Results

47 CFR FCC Part 15, Subpart C (Section 15.247)			
FCC Clause	Test Item	Result	Remarks
15.207	AC Power Conducted Emission	Pass	Meet the requirement of limit. Minimum passing margin is -2.40dB at 0.39219MHz.
15.247(a)(1)(iii)	Number of Hopping Frequency Used	Pass	Meet the requirement of limit.
15.247(a)(1)(iii)	Dwell Time on Each Channel	Pass	Meet the requirement of limit.
15.247(a)(1)	1. Hopping Channel Separation 2. Spectrum Bandwidth of a Frequency Hopping Sequence Spread Spectrum System	Pass	Meet the requirement of limit.
15.247(b)	Maximum Peak Output Power	Pass	Meet the requirement of limit.
15.205 / 15.209 / 15.247(d)	Radiated Emissions and Band Edge Measurement	Pass	Meet the requirement of limit. Minimum passing margin is -3.6dB at 198.71MHz.
15.247(d)	Antenna Port Emission	Pass	Meet the requirement of limit.
15.203	Antenna Requirement	Pass	Antenna connector is IPEX not a standard connector.

Note: If The Frequency Hopping System operating in 2400-2483.5MHz band and the output power less than 125mW. The hopping channel carrier frequencies separated by a minimum of 25kHz or two-thirds of the 20dB bandwidth of hopping channel whichever is greater.

2.1 Measurement Uncertainty

Where relevant, the following measurement uncertainty levels have been estimated for tests performed on the EUT as specified in CISPR 16-4-2:

Measurement	Frequency	Expanded Uncertainty (k=2) (±)
Conducted Emissions at mains ports	150kHz ~ 30MHz	2.44 dB
Radiated Emissions up to 1 GHz	30MHz ~ 200MHz	3.59 dB
	200MHz ~ 1000MHz	3.60 dB
Radiated Emissions above 1 GHz	1GHz ~ 18GHz	2.29 dB
	18GHz ~ 40GHz	2.29 dB

2.2 Modification Record

There were no modifications required for compliance.

3 General Information

3.1 General Description of EUT

Product	Premium Wi-Fi & BLE Array AP
Brand	Mist
Test Model	AP41
Series Model	AP41E
Model Difference	AP41 for internal antenna AP41E for external antenna
Sample Status	Engineering Sample
Power Supply Rating	12Vdc from adapter 55Vdc from PoE
Modulation Type	GFSK, $\pi/4$ -DQPSK, 8DPSK
Modulation Technology	FHSS
Transfer Rate	1/2/3Mbps
Operating Frequency	2402 ~ 2480MHz
Number of Channel	79
Output Power	12.303mW
Antenna Type	Refer to Note
Antenna Connector	IPEX
Accessory Device	NA
Data Cable Supplied	NA

Note:

1. This report is prepared for FCC class II permissive change. This report is issued as a duplicate report of BV ADT report No.: RF151230E03-2. The differences compared with original report are adding a new model name for the EUT with external WIFI antenna and revising the beam 2 composition & antenna location photo on page 8. The EUT had been confirmed that the radiated emission orientation would be the same as the original one and the EUT with external WIFI antenna has no effect on any BT function, therefore we didn't re-test it.
2. The EUT used internal antenna for BT function only and recorded in this report.
3. There are three radios for the EUT.

Radio	Brand	Model	Function
Radio 1	Broadcom	BCM43465	WLAN 2.4G & 5G
Radio 2	Broadcom	BCM43465	WLAN 2.4G & 5G
Radio 3	Broadcom	BCM20704	BT EDR & BT LE

4. The EUT uses following adapter & PoE. (Support unit only)

Adapter	
Brand	Channel Well Technology
Model	2ABN036F US
Input Power	100-240Vac~50/60Hz 1.0A
Output Power	12.0Vdc / 3.0A
Power Line	1.45m DC cable without core attached on adapter

PoE	
Brand	Microsemi
Model	PD-9001GR/AT/AC
Input Power	100-240Vac~50/60Hz 0.67A
Output Power	55Vdc / 0.6A

5. The following antennas were provided to the EUT.

Antenna Type	Omni & directional		
Antenna Connector	IPEX		
Gain (dBi)	Frequency		
	2.4 GHz	2.45GHz	2.5GHz
BT-Omni Ant.	2.78	3.37	2.90
BT-Directional Ant.	4.43	5.03	4.39

**The device is composition of 8 directional antenna. 0~7 are the driven elements. 8~15 are acting as the reflectors. 1x driven element + 2x adjacent reflector will be a directional antenna. At each time, the central control circuit will create one beam by triggering 4 driven elements. It will further enhance the directivity. Based on the pretest result, beam 1 (composition of ant 0, 1, 2, 3) & beam 2 (composition of ant 1, 2, 3, 4)...etc and beam 2 was the worst case. Thus, this case was chosen for the final test.

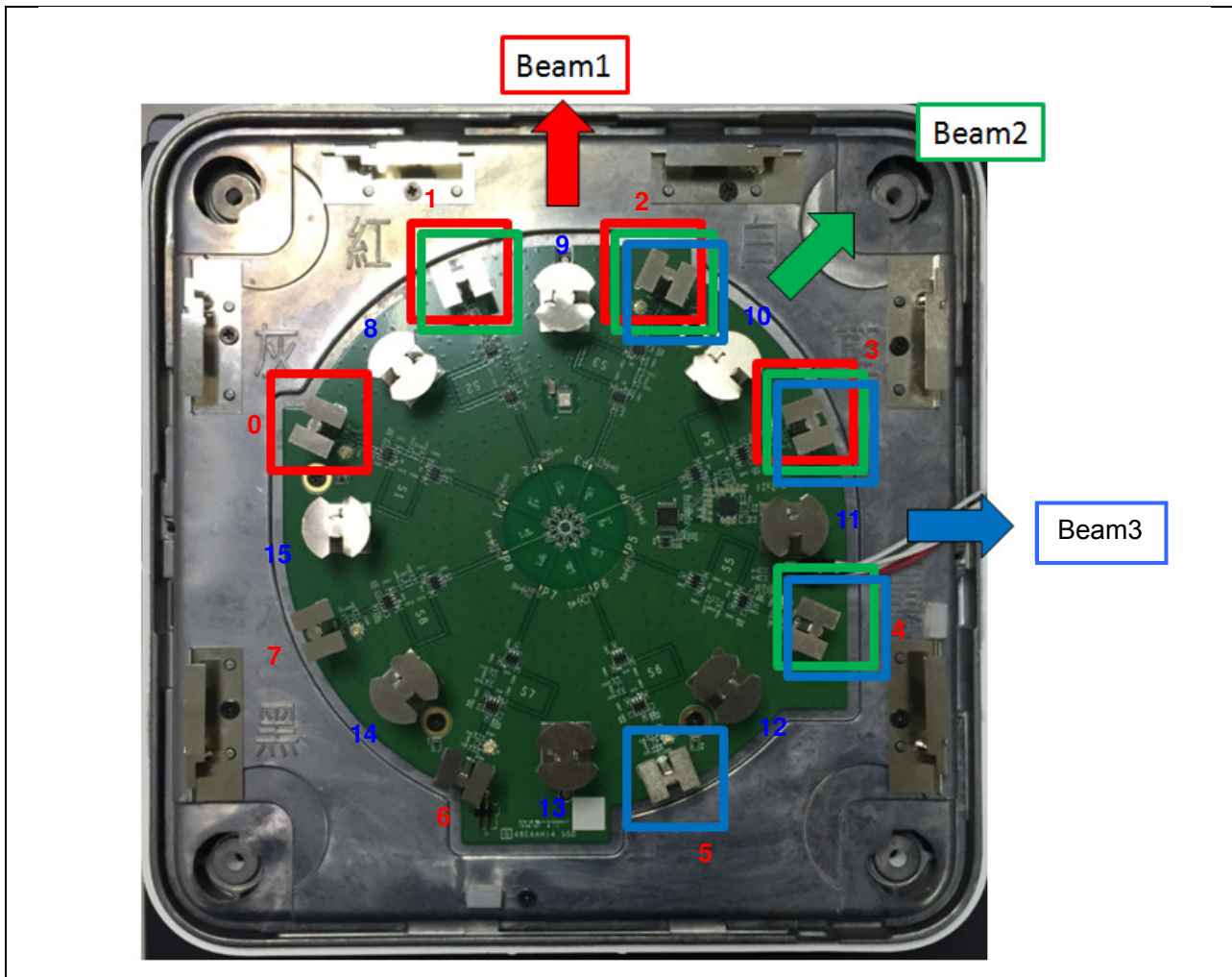

3.2 Description of Test Modes

79 channels are provided to this EUT:

Channel	Freq. (MHz)	Channel	Freq. (MHz)	Channel	Freq. (MHz)	Channel	Freq. (MHz)
0	2402	20	2422	40	2442	60	2462
1	2403	21	2423	41	2443	61	2463
2	2404	22	2424	42	2444	62	2464
3	2405	23	2425	43	2445	63	2465
4	2406	24	2426	44	2446	64	2466
5	2407	25	2427	45	2447	65	2467
6	2408	26	2428	46	2448	66	2468
7	2409	27	2429	47	2449	67	2469
8	2410	28	2430	48	2450	68	2470
9	2411	29	2431	49	2451	69	2471
10	2412	30	2432	50	2452	70	2472
11	2413	31	2433	51	2453	71	2473
12	2414	32	2434	52	2454	72	2474
13	2415	33	2435	53	2455	73	2475
14	2416	34	2436	54	2456	74	2476
15	2417	35	2437	55	2457	75	2477
16	2418	36	2438	56	2458	76	2478
17	2419	37	2439	57	2459	77	2479
18	2420	38	2440	58	2460	78	2480
19	2421	39	2441	59	2461		

3.2.1 Test Mode Applicability and Tested Channel Detail

EUT CONFIGURE MODE	APPLICABLE TO				DESCRIPTION
	RE \geq 1G	RE $<$ 1G	PLC	APCM	
A	-	√	√	-	Power from adapter + BT-Directional Ant.
B	√	√	√	√	Power from PoE+ BT-Directional Ant.
C	√	-	-	-	Power from PoE+ BT-Omni Ant.

Where **RE \geq 1G**: Radiated Emission above 1GHz & Bandedge Measurement
RE $<$ 1G: Radiated Emission below 1GHz
PLC: Power Line Conducted Emission
APCM: Antenna Port Conducted Measurement

Note:

1. The EUT could just position on the Z-plane according to manufacturer's requirement.
2. "-" means no effect.

Radiated Emission Test (Above 1GHz):

- Pre-Scan has been conducted to determine the worst-case mode from all possible combinations between available modulations, data rates and antenna ports (if EUT with antenna diversity architecture).
- Following channel(s) was (were) selected for the final test as listed below.

EUT CONFIGURE MODE	AVAILABLE CHANNEL	TESTED CHANNEL	MODULATION TECHNOLOGY	MODULATION TYPE	PACKET TYPE
B, C	0 to 78	0, 39, 78	FHSS	GFSK	DH5
B, C	0 to 78	0, 39, 78	FHSS	8DPSK	DH5

Radiated Emission Test (Below 1GHz):

- Pre-Scan has been conducted to determine the worst-case mode from all possible combinations between available modulations, data rates and antenna ports (if EUT with antenna diversity architecture).
- Following channel(s) was (were) selected for the final test as listed below.

EUT CONFIGURE MODE	AVAILABLE CHANNEL	TESTED CHANNEL	MODULATION TECHNOLOGY	MODULATION TYPE	PACKET TYPE
A, B	0 to 78	39	FHSS	GFSK	DH5

Power Line Conducted Emission Test:

- Pre-Scan has been conducted to determine the worst-case mode from all possible combinations between available modulations, data rates and antenna ports (if EUT with antenna diversity architecture).
- Following channel(s) was (were) selected for the final test as listed below.

EUT CONFIGURE MODE	AVAILABLE CHANNEL	TESTED CHANNEL	MODULATION TECHNOLOGY	MODULATION TYPE	PACKET TYPE
A, B	0 to 78	39	FHSS	GFSK	DH5

Antenna Port Conducted Measurement:

- This item includes all test value of each mode, but only includes spectrum plot of worst value of each mode.
- Pre-Scan has been conducted to determine the worst-case mode from all possible combinations between available modulations, data rates and antenna ports (if EUT with antenna diversity architecture).
- Following channel(s) was (were) selected for the final test as listed below.

EUT CONFIGURE MODE	AVAILABLE CHANNEL	TESTED CHANNEL	MODULATION TECHNOLOGY	MODULATION TYPE	PACKET TYPE
B	0 to 78	0, 39, 78	FHSS	GFSK	DH5
B	0 to 78	0, 39, 78	FHSS	8DPSK	DH5

Test Condition:

APPLICABLE TO	ENVIRONMENTAL CONDITIONS	INPUT POWER	TESTED BY
RE\geq1G	23deg. C, 66%RH	55Vdc (PoE)	Alan Wu
	20deg. C, 63%RH	55Vdc (PoE)	Alan Wu
RE$<$1G	23deg. C, 66%RH	120Vac, 60Hz (Adapter) 55Vdc (PoE)	Alan Wu
PLC	25deg. C, 65%RH	20Vac, 60Hz (Adapter) 55Vdc (PoE)	Chris Lin
APCM	25deg. C, 60%RH	55Vdc (PoE)	Ted Chang

3.3 Description of Support Units

The EUT has been tested as an independent unit together with other necessary accessories or support units. The following support units or accessories were used to form a representative test configuration during the tests.

ID	Product	Brand	Model No.	Serial No.	FCC ID	Remarks
A.	Notebook	DELL	E5410	6RP2YM1	FCC DoC Approved	-
B.	USB 3.0 Flash Drive	HP	v250w	N/A	FCC DoC Approved	-
C.	Adapter	Channel Well Technology	2ABN036F US	N/A	N/A	Provided by client
D.	Load	N/A	N/A	N/A	N/A	-
E.	PoE	Microsemi	PD-9001GR/AT/AC	N/A	N/A	Provided by client

Note:

1. All power cords of the above support units are non-shielded (1.8m).
2. Items A acted as communication partners to transfer data.

ID	Descriptions	Qty.	Length (m)	Shielding (Yes/No)	Cores (Qty.)	Remarks
1.	RJ45 cable	1	10	N	0	-
2.	RJ45 cable	2	1.8	N	0	-
3.	DC cable	1	1.45	-	0	attached on adapter
4.	RJ45 cable	1	3	N	0	-

Note: The core(s) is(are) originally attached to the cable(s).

3.3.1 Configuration of System under Test

Test Mode A

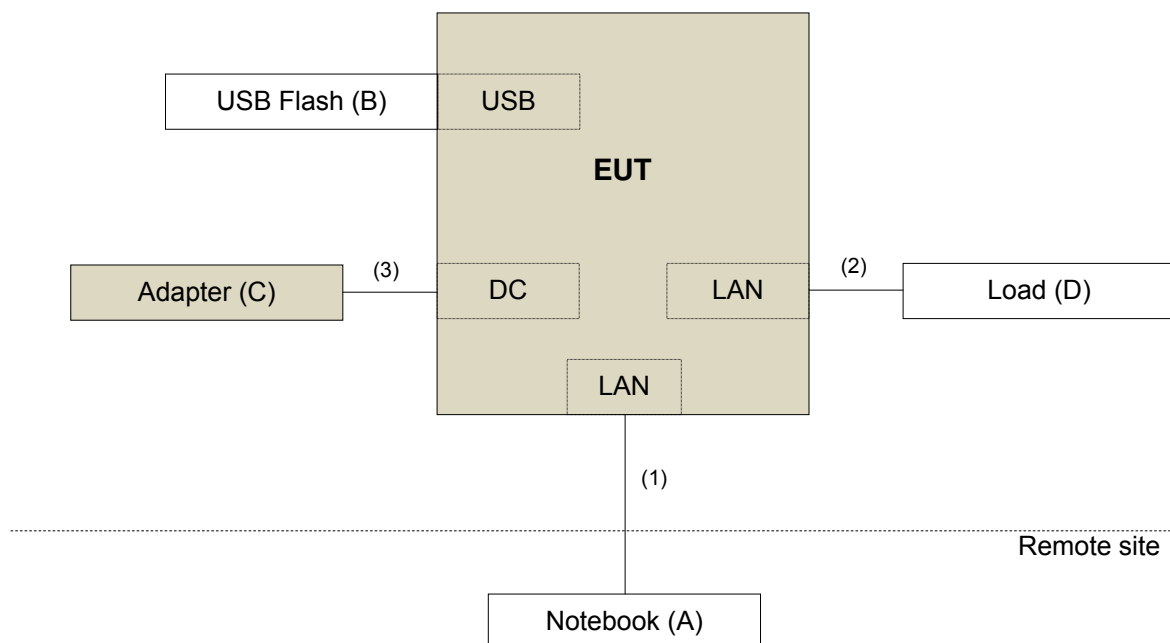

Test Mode B

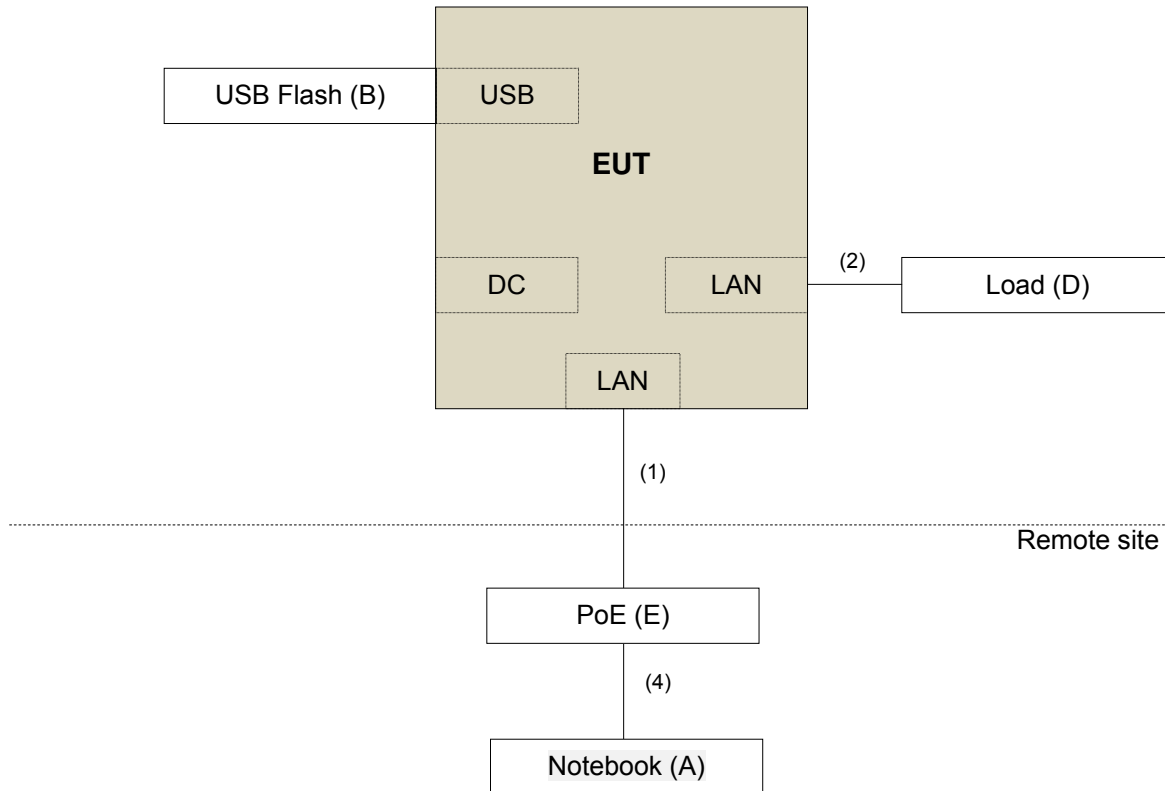

3.4 General Description of Applied Standards

The EUT is a RF Product. According to the specifications of the manufacturer, it must comply with the requirements of the following standards:

FCC Part 15, Subpart C (15.247)

FCC Public Notice DA 00-705

ANSI C63.10-2013

All test items have been performed and recorded as per the above standards.

Note: The EUT has been verified to comply with the requirements of FCC Part 15, Subpart B, Class B (DoC). The test report has been issued separately.

4 Test Types and Results

4.1 Radiated Emission and Bandedge Measurement

4.1.1 Limits of Radiated Emission and Bandedge Measurement

Radiated emissions which fall in the restricted bands must comply with the radiated emission limits specified as below table. Other emissions shall be at least 20dB below the highest level of the desired power:

Frequencies (MHz)	Field Strength (microvolts/meter)	Measurement Distance (meters)
0.009 ~ 0.490	2400/F(kHz)	300
0.490 ~ 1.705	24000/F(kHz)	30
1.705 ~ 30.0	30	30
30 ~ 88	100	3
88 ~ 216	150	3
216 ~ 960	200	3
Above 960	500	3

Note:

1. The lower limit shall apply at the transition frequencies.
2. Emission level (dBuV/m) = 20 log Emission level (uV/m).
3. For frequencies above 1000MHz, the field strength limits are based on average detector, however, the peak field strength of any emission shall not exceed the maximum permitted average limits, specified above by more than 20dB under any condition of modulation.



4.1.2 Test Instruments

Description & Manufacturer	Model No.	Serial No.	Date Of Calibration	Due Date Of Calibration
Test Receiver ROHDE & SCHWARZ	ESCI	100424	Oct. 12, 2015	Oct. 11, 2016
Spectrum Analyzer ROHDE & SCHWARZ	FSP40	100040	Jul. 08, 2015	Jul. 07, 2016
BILOG Antenna SCHWARZBECK	VULB9168	9168-155	Feb. 06, 2015	Feb. 05, 2016
HORN Antenna SCHWARZBECK	BBHA 9120D	9120D-1170	Feb. 05, 2015	Feb. 04, 2016
HORN Antenna SCHWARZBECK	BBHA 9170	BBHA9170241	Feb. 09, 2015	Feb. 08, 2016
Preamplifier Agilent	8449B	3008A01960	Aug. 09, 2015	Aug. 08, 2016
Preamplifier Agilent	8447D	2944A10631	Aug. 09, 2015	Aug. 08, 2016
RF signal cable HUBER+SUHNER	SUCOFLEX 104	Cable-CH4-02(295 012+309220)	Aug. 09, 2015	Aug. 08, 2016
RF signal cable HUBER+SUHNER	SUCOFLEX 104	Cable-CH4-03(250 724)	Aug. 09, 2015	Aug. 08, 2016
Software BV ADT	ADT_Radiated_ V7.6.15.9.4	NA	NA	NA
Antenna Tower inn-co GmbH	MA 4000	010303	NA	NA
Antenna Tower Controller BV ADT	AT100	AT93021703	NA	NA
Turn Table BV ADT	TT100	TT93021703	NA	NA
Turn Table Controller BV ADT	SC100.	SC93021703	NA	NA
High Speed Peak Power Meter	ML2495A	0824011	Jul. 09, 2015	Jul. 08, 2016
Power Sensor	MA2411B	0738171	Jul. 09, 2015	Jul. 08, 2016

- Note: 1. The calibration interval of the above test instruments is 12 months and the calibrations are traceable to NML/ROC and NIST/USA.
2. The test was performed in HwaYa Chamber 4.
3. The horn antenna and preamplifier (model: 8449B) are used only for the measurement of emission frequency above 1GHz if tested.
4. The FCC Site Registration No. is 460141.
5. The IC Site Registration No. is IC7450F-4.

4.1.3 Test Procedures

- a. The EUT was placed on the top of a rotating table 0.8 meters (for below 1GHz) / 1.5 meters (for above 1GHz) above the ground at 3 meter chamber room for test. The table was rotated 360 degrees to determine the position of the highest radiation.
- b. The EUT was set 3 meters away from the interference-receiving antenna, which was mounted on the top of a variable-height antenna tower.
- c. The height of antenna is varied from one meter to four meters above the ground to determine the maximum value of the field strength. Both horizontal and vertical polarizations of the antenna are set to make the measurement.
- d. For each suspected emission, the EUT was arranged to its worst case and then the antenna was tuned to heights from 1 meter to 4 meters and the rotatable table was turned from 0 degrees to 360 degrees to find the maximum reading.
- e. The test-receiver system was set to quasi-peak detect function and specified bandwidth with maximum hold mode when the test frequency is below 1 GHz.
- f. The test-receiver system was set to peak and average detect function and specified bandwidth with maximum hold mode when the test frequency is above 1 GHz. If the peak reading value also meets average limit, measurement with the average detector is unnecessary.

Note:

1. The resolution bandwidth and video bandwidth of test receiver/spectrum analyzer is 120kHz for Quasi-peak detection (QP) at frequency below 1GHz.
2. The resolution bandwidth of test receiver/spectrum analyzer is 1 MHz and the video bandwidth is 3 MHz for Peak detection (PK) at frequency above 1GHz.
3. For Average measurement, due to the DH5 packet was the worse case duty cycle for a transmit dwell time on a channel, based upon bluetooth theory the transmitter is on $0.625 * 5$ per 296.25 ms per channel. Therefore, the duty cycle correlation factor be equal to: $20\log(3.125 / 100) = -30.1$ dB, therefore Average value = peak reading + $20\log(\text{duty cycle})$.
4. All modes of operation were investigated and the worst-case emissions are reported.

4.1.4 Deviation from Test Standard

No deviation.

4.1.5 Test Set Up

<Frequency Range below 1GHz>

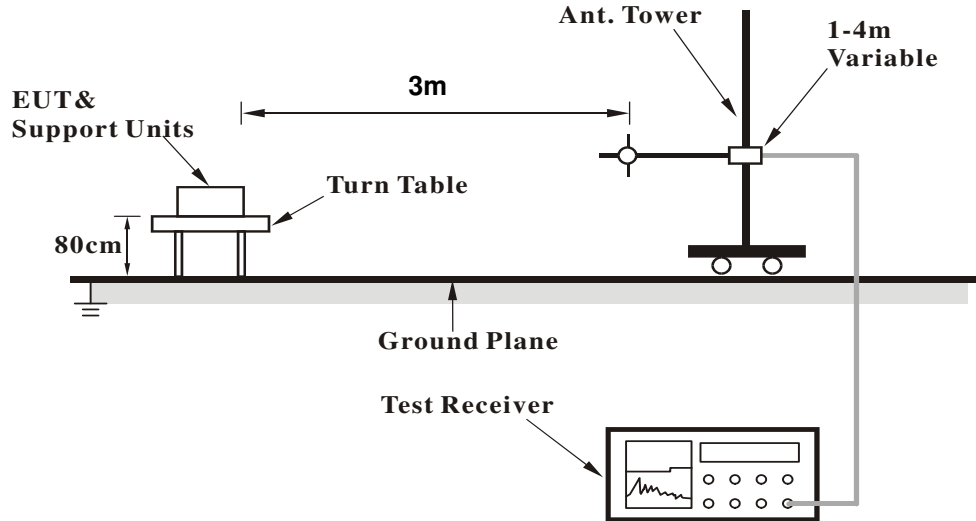

<Frequency Range above 1GHz>

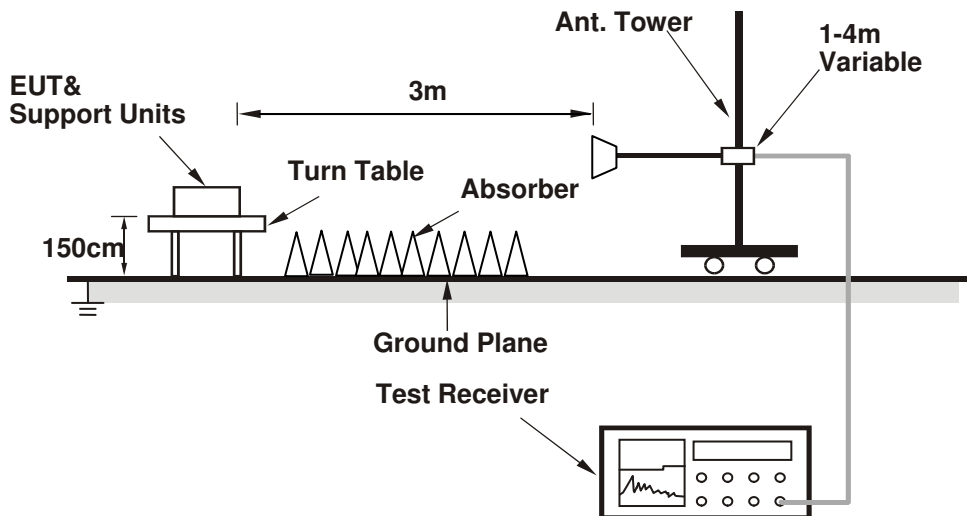

For the actual test configuration, please refer to the attached file (Test Setup Photo).

4.1.6 EUT Operating Conditions

- Placed the EUT on the testing table.
- Prepared notebook to act as communication partner and placed it outside of testing area.
- The communication partner connected with EUT via a RJ45 cable and ran a test program (provided by manufacturer) to enable EUT under transmission condition continuously at specific channel frequency.
- The communication partner sent data to EUT by command "PING".
- The necessary accessories enable the system in full functions.

4.1.7 Test Results

Above 1GHz Worst-case Data:

Test Mode B

GFSK

CHANNEL	TX Channel 0	DETECTOR FUNCTION	Peak (PK)
FREQUENCY RANGE	1GHz ~ 25GHz		Average (AV)

ANTENNA POLARITY & TEST DISTANCE: HORIZONTAL AT 3 M

NO.	FREQ. (MHz)	EMISSION LEVEL (dBuV/m)	LIMIT (dBuV/m)	MARGIN (dB)	ANTENNA HEIGHT (m)	TABLE ANGLE (Degree)	RAW VALUE (dBuV)	CORRECTION FACTOR (dB/m)
1	2390.00	48.5 PK	74.0	-25.5	1.26 H	315	51.20	-2.70
2	2390.00	38.5 AV	54.0	-15.5	1.26 H	315	41.20	-2.70
3	#2400.00	58.2 PK	74.0	-15.8	1.22 H	317	60.70	-2.50
4	#2400.00	28.1 AV	54.0	-25.9	1.22 H	317	30.60	-2.50
5	*2402.00	103.2 PK			1.24 H	313	71.40	31.80
6	*2402.00	73.1 AV			1.24 H	313	41.30	31.80
7	4804.00	45.6 PK	74.0	-28.4	1.23 H	65	40.60	5.00
8	4804.00	15.5 AV	54.0	-38.5	1.23 H	65	10.50	5.00

ANTENNA POLARITY & TEST DISTANCE: VERTICAL AT 3 M

NO.	FREQ. (MHz)	EMISSION LEVEL (dBuV/m)	LIMIT (dBuV/m)	MARGIN (dB)	ANTENNA HEIGHT (m)	TABLE ANGLE (Degree)	RAW VALUE (dBuV)	CORRECTION FACTOR (dB/m)
1	2390.00	48.3 PK	74.0	-25.7	1.31 V	226	51.00	-2.70
2	2390.00	35.7 AV	54.0	-18.3	1.31 V	226	38.40	-2.70
3	#2400.00	45.9 PK	74.0	-28.1	1.32 V	228	48.40	-2.50
4	#2400.00	15.8 AV	54.0	-38.2	1.32 V	228	18.30	-2.50
5	*2402.00	95.9 PK			1.29 V	225	64.10	31.80
6	*2402.00	65.8 AV			1.29 V	225	34.00	31.80
7	4804.00	45.5 PK	74.0	-28.5	1.18 V	56	40.50	5.00
8	4804.00	15.4 AV	54.0	-38.6	1.18 V	56	10.40	5.00

Remarks:

1. Emission Level(dBuV/m) = Raw Value(dBuV) + Correction Factor(dB/m)
2. Correction Factor(dB/m) = Antenna Factor(dB/m) + Cable Factor(dB)
3. The other emission levels were very low against the limit.
4. Margin value = Emission Level – Limit value
5. " * ": Fundamental frequency.
6. " # ": The radiated frequency is out of the restricted band.

CHANNEL	TX Channel 39	DETECTOR FUNCTION	Peak (PK)
FREQUENCY RANGE	1GHz ~ 25GHz		Average (AV)

ANTENNA POLARITY & TEST DISTANCE: HORIZONTAL AT 3 M

NO.	FREQ. (MHz)	EMISSION LEVEL (dBuV/m)	LIMIT (dBuV/m)	MARGIN (dB)	ANTENNA HEIGHT (m)	TABLE ANGLE (Degree)	RAW VALUE (dBuV)	CORRECTION FACTOR (dB/m)
1	*2441.00	104.1 PK			1.38 H	312	72.20	31.90
2	*2441.00	74.0 AV			1.38 H	312	42.10	31.90
3	4882.00	47.6 PK	74.0	-26.4	1.32 H	64	42.60	5.00
4	4882.00	17.5 AV	54.0	-36.5	1.32 H	64	12.50	5.00

ANTENNA POLARITY & TEST DISTANCE: VERTICAL AT 3 M

NO.	FREQ. (MHz)	EMISSION LEVEL (dBuV/m)	LIMIT (dBuV/m)	MARGIN (dB)	ANTENNA HEIGHT (m)	TABLE ANGLE (Degree)	RAW VALUE (dBuV)	CORRECTION FACTOR (dB/m)
1	*2441.00	96.9 PK			1.27 V	197	65.00	31.90
2	*2441.00	66.8 AV			1.27 V	197	34.90	31.90
3	4882.00	45.2 PK	74.0	-28.8	1.17 V	45	40.20	5.00
4	4882.00	15.1 AV	54.0	-38.9	1.17 V	45	10.10	5.00

Remarks:

1. Emission Level(dBuV/m) = Raw Value(dBuV) + Correction Factor(dB/m)
2. Correction Factor(dB/m) = Antenna Factor(dB/m) + Cable Factor(dB)
3. The other emission levels were very low against the limit.
4. Margin value = Emission Level – Limit value
5. " * ": Fundamental frequency.

CHANNEL	TX Channel 78	DETECTOR FUNCTION	Peak (PK)
FREQUENCY RANGE	1GHz ~ 25GHz		Average (AV)

ANTENNA POLARITY & TEST DISTANCE: HORIZONTAL AT 3 M

NO.	FREQ. (MHz)	EMISSION LEVEL (dBuV/m)	LIMIT (dBuV/m)	MARGIN (dB)	ANTENNA HEIGHT (m)	TABLE ANGLE (Degree)	RAW VALUE (dBuV)	CORRECTION FACTOR (dB/m)
1	*2480.00	104.4 PK			1.83 H	321	72.40	32.00
2	*2480.00	74.3 AV			1.83 H	321	42.30	32.00
3	2483.50	59.4 PK	74.0	-14.6	1.85 H	325	61.80	-2.40
4	2483.50	29.3 AV	54.0	-24.7	1.85 H	325	31.70	-2.40
5	4960.00	47.9 PK	74.0	-26.1	1.33 H	65	42.60	5.30
6	4960.00	17.8 AV	54.0	-36.2	1.33 H	65	12.50	5.30

ANTENNA POLARITY & TEST DISTANCE: VERTICAL AT 3 M

NO.	FREQ. (MHz)	EMISSION LEVEL (dBuV/m)	LIMIT (dBuV/m)	MARGIN (dB)	ANTENNA HEIGHT (m)	TABLE ANGLE (Degree)	RAW VALUE (dBuV)	CORRECTION FACTOR (dB/m)
1	*2480.00	96.9 PK			2.63 V	193	64.90	32.00
2	*2480.00	66.8 AV			2.63 V	193	34.80	32.00
3	2483.50	46.9 PK	74.0	-27.1	2.70 V	195	49.30	-2.40
4	2483.50	16.8 AV	54.0	-37.2	2.70 V	195	19.20	-2.40
5	4960.00	47.6 PK	74.0	-26.4	2.51 V	196	42.30	5.30
6	4960.00	17.5 AV	54.0	-36.5	2.51 V	196	12.20	5.30

Remarks:

1. Emission Level(dBuV/m) = Raw Value(dBuV) + Correction Factor(dB/m)
2. Correction Factor(dB/m) = Antenna Factor(dB/m) + Cable Factor(dB)
3. The other emission levels were very low against the limit.
4. Margin value = Emission Level – Limit value
5. " * ": Fundamental frequency.

8DPSK

CHANNEL	TX Channel 0	DETECTOR FUNCTION	Peak (PK)
FREQUENCY RANGE	1GHz ~ 25GHz		Average (AV)

ANTENNA POLARITY & TEST DISTANCE: HORIZONTAL AT 3 M

NO.	FREQ. (MHz)	EMISSION LEVEL (dBuV/m)	LIMIT (dBuV/m)	MARGIN (dB)	ANTENNA HEIGHT (m)	TABLE ANGLE (Degree)	RAW VALUE (dBuV)	CORRECTION FACTOR (dB/m)
1	2390.00	47.9 PK	74.0	-26.1	1.26 H	320	50.30	-2.40
2	2390.00	37.4 AV	54.0	-16.6	1.26 H	320	39.80	-2.40
3	#2400.00	53.2 PK	74.0	-20.8	1.27 H	320	55.40	-2.20
4	#2400.00	23.1 AV	54.0	-30.9	1.27 H	320	25.30	-2.20
5	*2402.00	101.2 PK			1.25 H	318	69.10	32.10
6	*2402.00	71.2 AV			1.25 H	318	39.10	32.10
7	4804.00	48.1 PK	74.0	-25.9	1.62 H	38	41.60	6.50
8	4804.00	18.0 AV	54.0	-36.0	1.62 H	38	11.50	6.50

ANTENNA POLARITY & TEST DISTANCE: VERTICAL AT 3 M

NO.	FREQ. (MHz)	EMISSION LEVEL (dBuV/m)	LIMIT (dBuV/m)	MARGIN (dB)	ANTENNA HEIGHT (m)	TABLE ANGLE (Degree)	RAW VALUE (dBuV)	CORRECTION FACTOR (dB/m)
1	2390.00	46.3 PK	74.0	-27.7	1.20 V	210	49.00	-2.70
2	2390.00	35.7 AV	54.0	-18.3	1.20 V	210	38.40	-2.70
3	#2400.00	45.1 PK	74.0	-28.9	1.21 V	206	47.60	-2.50
4	#2400.00	15.0 AV	54.0	-39.0	1.21 V	206	17.50	-2.50
5	*2402.00	95.1 PK			1.18 V	203	63.30	31.80
6	*2402.00	65.0 AV			1.18 V	203	33.20	31.80
7	4804.00	45.6 PK	74.0	-28.4	1.21 V	210	40.60	5.00
8	4804.00	15.5 AV	54.0	-38.5	1.21 V	210	10.50	5.00

Remarks:

1. Emission Level(dBuV/m) = Raw Value(dBuV) + Correction Factor(dB/m)
2. Correction Factor(dB/m) = Antenna Factor(dB/m) + Cable Factor(dB)
3. The other emission levels were very low against the limit.
4. Margin value = Emission Level – Limit value
5. " * ": Fundamental frequency.
6. " # ": The radiated frequency is out of the restricted band.

CHANNEL	TX Channel 39	DETECTOR FUNCTION	Peak (PK)
FREQUENCY RANGE	1GHz ~ 25GHz		Average (AV)

ANTENNA POLARITY & TEST DISTANCE: HORIZONTAL AT 3 M

NO.	FREQ. (MHz)	EMISSION LEVEL (dBuV/m)	LIMIT (dBuV/m)	MARGIN (dB)	ANTENNA HEIGHT (m)	TABLE ANGLE (Degree)	RAW VALUE (dBuV)	CORRECTION FACTOR (dB/m)
1	*2441.00	101.0 PK			1.86 H	314	69.10	31.90
2	*2441.00	70.9 AV			1.86 H	314	39.00	31.90
3	4882.00	47.3 PK	74.0	-26.7	1.28 H	96	42.30	5.00
4	4882.00	17.2 AV	54.0	-36.8	1.28 H	96	12.20	5.00

ANTENNA POLARITY & TEST DISTANCE: VERTICAL AT 3 M

NO.	FREQ. (MHz)	EMISSION LEVEL (dBuV/m)	LIMIT (dBuV/m)	MARGIN (dB)	ANTENNA HEIGHT (m)	TABLE ANGLE (Degree)	RAW VALUE (dBuV)	CORRECTION FACTOR (dB/m)
1	*2441.00	95.0 PK			1.00 V	196	63.10	31.90
2	*2441.00	64.9 AV			1.00 V	196	33.00	31.90
3	4882.00	45.5 PK	74.0	-28.5	1.36 V	98	40.50	5.00
4	4882.00	15.4 AV	54.0	-38.6	1.36 V	98	10.40	5.00

Remarks:

1. Emission Level(dBuV/m) = Raw Value(dBuV) + Correction Factor(dB/m)
2. Correction Factor(dB/m) = Antenna Factor(dB/m) + Cable Factor(dB)
3. The other emission levels were very low against the limit.
4. Margin value = Emission Level – Limit value
5. " * ": Fundamental frequency.

CHANNEL	TX Channel 78	DETECTOR FUNCTION	Peak (PK)
FREQUENCY RANGE	1GHz ~ 25GHz		Average (AV)

ANTENNA POLARITY & TEST DISTANCE: HORIZONTAL AT 3 M

NO.	FREQ. (MHz)	EMISSION LEVEL (dBuV/m)	LIMIT (dBuV/m)	MARGIN (dB)	ANTENNA HEIGHT (m)	TABLE ANGLE (Degree)	RAW VALUE (dBuV)	CORRECTION FACTOR (dB/m)
1	*2480.00	101.8 PK			1.48 H	308	69.80	32.00
2	*2480.00	71.7 AV			1.48 H	308	39.70	32.00
3	2483.50	56.8 PK	74.0	-17.2	1.51 H	310	59.20	-2.40
4	2483.50	26.7 AV	54.0	-27.3	1.51 H	310	29.10	-2.40
5	4960.00	47.9 PK	74.0	-26.1	1.25 H	87	42.60	5.30
6	4960.00	17.8 AV	54.0	-36.2	1.25 H	87	12.50	5.30

ANTENNA POLARITY & TEST DISTANCE: VERTICAL AT 3 M

NO.	FREQ. (MHz)	EMISSION LEVEL (dBuV/m)	LIMIT (dBuV/m)	MARGIN (dB)	ANTENNA HEIGHT (m)	TABLE ANGLE (Degree)	RAW VALUE (dBuV)	CORRECTION FACTOR (dB/m)
1	*2480.00	95.6 PK			1.26 V	192	63.60	32.00
2	*2480.00	65.5 AV			1.26 V	192	33.50	32.00
3	2483.50	45.6 PK	74.0	-28.4	1.30 V	195	48.00	-2.40
4	2483.50	15.5 AV	54.0	-38.5	1.30 V	195	17.90	-2.40
5	4960.00	45.9 PK	74.0	-28.1	1.33 V	206	40.60	5.30
6	4960.00	15.8 AV	54.0	-38.2	1.33 V	206	10.50	5.30

Remarks:

1. Emission Level(dBuV/m) = Raw Value(dBuV) + Correction Factor(dB/m)
2. Correction Factor(dB/m) = Antenna Factor(dB/m) + Cable Factor(dB)
3. The other emission levels were very low against the limit.
4. Margin value = Emission Level – Limit value
5. " * ": Fundamental frequency.

Test Mode C

GFSK

CHANNEL	TX Channel 0	DETECTOR FUNCTION	Peak (PK)
FREQUENCY RANGE	1GHz ~ 25GHz		Average (AV)

ANTENNA POLARITY & TEST DISTANCE: HORIZONTAL AT 3 M

NO.	FREQ. (MHz)	EMISSION LEVEL (dBuV/m)	LIMIT (dBuV/m)	MARGIN (dB)	ANTENNA HEIGHT (m)	TABLE ANGLE (Degree)	RAW VALUE (dBuV)	CORRECTION FACTOR (dB/m)
1	2390.00	39.3 PK	74.0	-34.7	1.00 H	312	41.70	-2.40
2	2390.00	29.2 AV	54.0	-24.8	1.00 H	312	31.60	-2.40
3	#2400.00	37.9 PK	74.0	-36.1	1.00 H	312	40.10	-2.20
4	#2400.00	7.8 AV	54.0	-46.2	1.00 H	312	10.00	-2.20
5	*2402.00	99.2 PK			1.00 H	312	67.10	32.10
6	*2402.00	69.1 AV			1.00 H	312	37.00	32.10
7	4804.00	48.0 PK	74.0	-26.0	1.00 H	334	41.50	6.50
8	4804.00	17.9 AV	54.0	-36.1	1.00 H	334	11.40	6.50

ANTENNA POLARITY & TEST DISTANCE: VERTICAL AT 3 M

NO.	FREQ. (MHz)	EMISSION LEVEL (dBuV/m)	LIMIT (dBuV/m)	MARGIN (dB)	ANTENNA HEIGHT (m)	TABLE ANGLE (Degree)	RAW VALUE (dBuV)	CORRECTION FACTOR (dB/m)
1	2390.00	38.8 PK	74.0	-35.2	1.22 V	14	41.20	-2.40
2	2390.00	28.7 AV	54.0	-25.3	1.22 V	14	31.10	-2.40
3	#2400.00	31.6 PK	74.0	-42.4	1.22 V	14	33.80	-2.20
4	#2400.00	1.5 AV	54.0	-52.5	1.22 V	14	3.70	-2.20
5	*2402.00	92.9 PK			1.22 V	14	60.80	32.10
6	*2402.00	62.8 AV			1.22 V	14	30.70	32.10
7	4804.00	47.5 PK	74.0	-26.5	1.00 V	54	41.00	6.50
8	4804.00	17.4 AV	54.0	-36.6	1.00 V	54	10.90	6.50

Remarks:

1. Emission Level(dBuV/m) = Raw Value(dBuV) + Correction Factor(dB/m)
2. Correction Factor(dB/m) = Antenna Factor(dB/m) + Cable Factor(dB)
3. The other emission levels were very low against the limit.
4. Margin value = Emission Level – Limit value
5. " * ": Fundamental frequency.
6. " # ": The radiated frequency is out of the restricted band.

CHANNEL	TX Channel 39	DETECTOR FUNCTION	Peak (PK)
FREQUENCY RANGE	1GHz ~ 25GHz		Average (AV)

ANTENNA POLARITY & TEST DISTANCE: HORIZONTAL AT 3 M

NO.	FREQ. (MHz)	EMISSION LEVEL (dBuV/m)	LIMIT (dBuV/m)	MARGIN (dB)	ANTENNA HEIGHT (m)	TABLE ANGLE (Degree)	RAW VALUE (dBuV)	CORRECTION FACTOR (dB/m)
1	*2441.00	99.3 PK			1.00 H	311	67.10	32.20
2	*2441.00	69.2 AV			1.00 H	311	37.00	32.20
3	4882.00	48.8 PK	74.0	-25.2	1.00 H	335	42.20	6.60
4	4882.00	18.7 AV	54.0	-35.3	1.00 H	335	12.10	6.60

ANTENNA POLARITY & TEST DISTANCE: VERTICAL AT 3 M

NO.	FREQ. (MHz)	EMISSION LEVEL (dBuV/m)	LIMIT (dBuV/m)	MARGIN (dB)	ANTENNA HEIGHT (m)	TABLE ANGLE (Degree)	RAW VALUE (dBuV)	CORRECTION FACTOR (dB/m)
1	*2441.00	92.7 PK			1.18 V	6	60.50	32.20
2	*2441.00	62.6 AV			1.18 V	6	30.40	32.20
3	4882.00	48.2 PK	74.0	-25.8	1.00 V	53	41.60	6.60
4	4882.00	18.1 AV	54.0	-35.9	1.00 V	53	11.50	6.60

Remarks:

1. Emission Level(dBuV/m) = Raw Value(dBuV) + Correction Factor(dB/m)
2. Correction Factor(dB/m) = Antenna Factor(dB/m) + Cable Factor(dB)
3. The other emission levels were very low against the limit.
4. Margin value = Emission Level – Limit value
5. " * ": Fundamental frequency.

CHANNEL	TX Channel 78	DETECTOR FUNCTION	Peak (PK)
FREQUENCY RANGE	1GHz ~ 25GHz		Average (AV)

ANTENNA POLARITY & TEST DISTANCE: HORIZONTAL AT 3 M

NO.	FREQ. (MHz)	EMISSION LEVEL (dBuV/m)	LIMIT (dBuV/m)	MARGIN (dB)	ANTENNA HEIGHT (m)	TABLE ANGLE (Degree)	RAW VALUE (dBuV)	CORRECTION FACTOR (dB/m)
1	*2480.00	99.6 PK			1.00 H	316	67.20	32.40
2	*2480.00	69.5 AV			1.00 H	316	37.10	32.40
3	2483.50	41.7 PK	74.0	-32.3	1.00 H	316	43.70	-2.00
4	2483.50	11.8 AV	54.0	-42.2	1.00 H	316	13.80	-2.00
5	4960.00	48.5 PK	74.0	-25.5	1.00 H	330	41.70	6.80
6	4960.00	18.4 AV	54.0	-35.6	1.00 H	330	11.60	6.80

ANTENNA POLARITY & TEST DISTANCE: VERTICAL AT 3 M

NO.	FREQ. (MHz)	EMISSION LEVEL (dBuV/m)	LIMIT (dBuV/m)	MARGIN (dB)	ANTENNA HEIGHT (m)	TABLE ANGLE (Degree)	RAW VALUE (dBuV)	CORRECTION FACTOR (dB/m)
1	*2480.00	92.6 PK			1.34 V	11	60.20	32.40
2	*2480.00	62.5 AV			1.34 V	11	30.10	32.40
3	2483.50	34.7 PK	74.0	-39.3	1.34 V	11	36.70	-2.00
4	2483.50	4.6 AV	54.0	-49.4	1.34 V	11	6.60	-2.00
5	4960.00	47.8 PK	74.0	-26.2	1.00 V	57	41.00	6.80
6	4960.00	17.7 AV	54.0	-36.3	1.00 V	57	10.90	6.80

Remarks:

1. Emission Level(dBuV/m) = Raw Value(dBuV) + Correction Factor(dB/m)
2. Correction Factor(dB/m) = Antenna Factor(dB/m) + Cable Factor(dB)
3. The other emission levels were very low against the limit.
4. Margin value = Emission Level – Limit value
5. " * ": Fundamental frequency.

8DPSK

CHANNEL	TX Channel 0	DETECTOR FUNCTION	Peak (PK)
FREQUENCY RANGE	1GHz ~ 25GHz		Average (AV)

ANTENNA POLARITY & TEST DISTANCE: HORIZONTAL AT 3 M

NO.	FREQ. (MHz)	EMISSION LEVEL (dBuV/m)	LIMIT (dBuV/m)	MARGIN (dB)	ANTENNA HEIGHT (m)	TABLE ANGLE (Degree)	RAW VALUE (dBuV)	CORRECTION FACTOR (dB/m)
1	2390.00	38.4 PK	74.0	-35.6	1.00 H	315	40.80	-2.40
2	2390.00	28.1 AV	54.0	-25.9	1.00 H	315	30.50	-2.40
3	#2400.00	40.8 PK	74.0	-33.2	1.00 H	315	43.00	-2.20
4	#2400.00	10.7 AV	54.0	-43.3	1.00 H	315	12.90	-2.20
5	*2402.00	95.9 PK			1.00 H	315	63.80	32.10
6	*2402.00	65.8 AV			1.00 H	315	33.70	32.10
7	4804.00	47.7 PK	74.0	-26.3	1.00 H	330	41.20	6.50
8	4804.00	17.6 AV	54.0	-36.4	1.00 H	330	11.10	6.50

ANTENNA POLARITY & TEST DISTANCE: VERTICAL AT 3 M

NO.	FREQ. (MHz)	EMISSION LEVEL (dBuV/m)	LIMIT (dBuV/m)	MARGIN (dB)	ANTENNA HEIGHT (m)	TABLE ANGLE (Degree)	RAW VALUE (dBuV)	CORRECTION FACTOR (dB/m)
1	2390.00	38.2 PK	74.0	-35.8	1.05 V	12	40.60	-2.40
2	2390.00	27.6 AV	54.0	-26.4	1.05 V	12	30.00	-2.40
3	#2400.00	34.1 PK	74.0	-39.9	1.05 V	12	36.30	-2.20
4	#2400.00	4.0 AV	54.0	-50.0	1.05 V	12	6.20	-2.20
5	*2402.00	89.2 PK			1.05 V	12	57.10	32.10
6	*2402.00	59.1 AV			1.05 V	12	27.00	32.10
7	4804.00	47.3 PK	74.0	-26.7	1.00 V	57	40.80	6.50
8	4804.00	17.2 AV	54.0	-36.8	1.00 V	57	10.70	6.50

Remarks:

1. Emission Level(dBuV/m) = Raw Value(dBuV) + Correction Factor(dB/m)
2. Correction Factor(dB/m) = Antenna Factor(dB/m) + Cable Factor(dB)
3. The other emission levels were very low against the limit.
4. Margin value = Emission Level – Limit value
5. " * ": Fundamental frequency.
6. " # ": The radiated frequency is out of the restricted band.

CHANNEL	TX Channel 39	DETECTOR FUNCTION	Peak (PK)
FREQUENCY RANGE	1GHz ~ 25GHz		Average (AV)

ANTENNA POLARITY & TEST DISTANCE: HORIZONTAL AT 3 M

NO.	FREQ. (MHz)	EMISSION LEVEL (dBuV/m)	LIMIT (dBuV/m)	MARGIN (dB)	ANTENNA HEIGHT (m)	TABLE ANGLE (Degree)	RAW VALUE (dBuV)	CORRECTION FACTOR (dB/m)
1	*2441.00	96.7 PK			1.00 H	313	64.50	32.20
2	*2441.00	66.6 AV			1.00 H	313	34.40	32.20
3	4882.00	48.3 PK	74.0	-25.7	1.00 H	333	41.70	6.60
4	4882.00	18.2 AV	54.0	-35.8	1.00 H	333	11.60	6.60

ANTENNA POLARITY & TEST DISTANCE: VERTICAL AT 3 M

NO.	FREQ. (MHz)	EMISSION LEVEL (dBuV/m)	LIMIT (dBuV/m)	MARGIN (dB)	ANTENNA HEIGHT (m)	TABLE ANGLE (Degree)	RAW VALUE (dBuV)	CORRECTION FACTOR (dB/m)
1	*2441.00	89.7 PK			1.19 V	8	57.50	32.20
2	*2441.00	59.6 AV			1.19 V	8	27.40	32.20
3	4882.00	47.2 PK	74.0	-26.8	1.00 V	55	40.60	6.60
4	4882.00	17.1 AV	54.0	-36.9	1.00 V	55	10.50	6.60

Remarks:

1. Emission Level(dBuV/m) = Raw Value(dBuV) + Correction Factor(dB/m)
2. Correction Factor(dB/m) = Antenna Factor(dB/m) + Cable Factor(dB)
3. The other emission levels were very low against the limit.
4. Margin value = Emission Level – Limit value
5. " * " : Fundamental frequency.

CHANNEL	TX Channel 78	DETECTOR FUNCTION	Peak (PK)
FREQUENCY RANGE	1GHz ~ 25GHz		Average (AV)

ANTENNA POLARITY & TEST DISTANCE: HORIZONTAL AT 3 M

NO.	FREQ. (MHz)	EMISSION LEVEL (dBuV/m)	LIMIT (dBuV/m)	MARGIN (dB)	ANTENNA HEIGHT (m)	TABLE ANGLE (Degree)	RAW VALUE (dBuV)	CORRECTION FACTOR (dB/m)
1	*2480.00	97.2 PK			1.00 H	312	64.80	32.40
2	*2480.00	67.1 AV			1.00 H	312	34.70	32.40
3	2483.50	35.4 PK	74.0	-38.6	1.00 H	312	37.40	-2.00
4	2483.50	5.3 AV	54.0	-48.7	1.00 H	312	7.30	-2.00
5	4960.00	48.2 PK	74.0	-25.8	1.00 H	336	41.40	6.80
6	4960.00	18.1 AV	54.0	-35.9	1.00 H	336	11.30	6.80

ANTENNA POLARITY & TEST DISTANCE: VERTICAL AT 3 M

NO.	FREQ. (MHz)	EMISSION LEVEL (dBuV/m)	LIMIT (dBuV/m)	MARGIN (dB)	ANTENNA HEIGHT (m)	TABLE ANGLE (Degree)	RAW VALUE (dBuV)	CORRECTION FACTOR (dB/m)
1	*2480.00	89.7 PK			1.33 V	10	57.30	32.40
2	*2480.00	59.6 AV			1.33 V	10	27.20	32.40
3	2483.50	31.1 PK	74.0	-42.9	1.33 V	10	33.10	-2.00
4	2483.50	1.0 AV	54.0	-53.0	1.33 V	10	3.00	-2.00
5	4960.00	47.6 PK	74.0	-26.4	1.00 V	51	40.80	6.80
6	4960.00	17.5 AV	54.0	-36.5	1.00 V	51	10.70	6.80

Remarks:

1. Emission Level(dBuV/m) = Raw Value(dBuV) + Correction Factor(dB/m)
2. Correction Factor(dB/m) = Antenna Factor(dB/m) + Cable Factor(dB)
3. The other emission levels were very low against the limit.
4. Margin value = Emission Level – Limit value
5. " * ": Fundamental frequency.

Below 1GHz worst-case data:

GFSK

Test Mode A

CHANNEL	TX Channel 39	DETECTOR FUNCTION	Quasi-Peak (QP)
FREQUENCY RANGE	30MHz ~ 1GHz		

ANTENNA POLARITY & TEST DISTANCE: HORIZONTAL AT 3 M

NO.	FREQ. (MHz)	EMISSION LEVEL (dBuV/m)	LIMIT (dBuV/m)	MARGIN (dB)	ANTENNA HEIGHT (m)	TABLE ANGLE (Degree)	RAW VALUE (dBuV)	CORRECTION FACTOR (dB/m)
1	37.66	34.4 QP	40.0	-5.6	1.24 H	185	49.10	-14.70
2	154.09	30.4 QP	43.5	-13.1	3.00 H	279	44.00	-13.60
3	187.07	35.9 QP	43.5	-7.6	1.24 H	102	51.90	-16.00
4	198.71	39.1 QP	43.5	-4.4	1.00 H	249	55.70	-16.60
5	427.68	30.4 QP	46.0	-15.6	1.00 H	273	40.90	-10.50
6	780.83	27.0 QP	46.0	-19.0	1.24 H	142	30.30	-3.30

ANTENNA POLARITY & TEST DISTANCE: VERTICAL AT 3 M

NO.	FREQ. (MHz)	EMISSION LEVEL (dBuV/m)	LIMIT (dBuV/m)	MARGIN (dB)	ANTENNA HEIGHT (m)	TABLE ANGLE (Degree)	RAW VALUE (dBuV)	CORRECTION FACTOR (dB/m)
1	33.78	34.6 QP	40.0	-5.4	1.00 V	145	49.60	-15.00
2	62.89	33.5 QP	40.0	-6.5	1.00 V	188	48.20	-14.70
3	185.13	29.3 QP	43.5	-14.2	1.00 V	216	45.10	-15.80
4	212.30	31.4 QP	43.5	-12.1	1.00 V	177	47.90	-16.50
5	425.74	32.1 QP	46.0	-13.9	1.00 V	187	42.70	-10.60
6	546.05	28.8 QP	46.0	-17.2	2.00 V	338	37.60	-8.80

Remarks:

1. Emission Level(dBuV/m) = Raw Value(dBuV) + Correction Factor(dB/m)
2. Correction Factor(dB/m) = Antenna Factor(dB/m) + Cable Factor(dB)
3. The other emission levels were very low against the limit.
4. Margin value = Emission Level – Limit value

Test Mode B

CHANNEL	TX Channel 39	DETECTOR FUNCTION	Quasi-Peak (QP)
FREQUENCY RANGE	30MHz ~ 1GHz		

ANTENNA POLARITY & TEST DISTANCE: HORIZONTAL AT 3 M

NO.	FREQ. (MHz)	EMISSION LEVEL (dBuV/m)	LIMIT (dBuV/m)	MARGIN (dB)	ANTENNA HEIGHT (m)	TABLE ANGLE (Degree)	RAW VALUE (dBuV)	CORRECTION FACTOR (dB/m)
1	37.66	32.4 QP	40.0	-7.6	1.50 H	32	47.10	-14.70
2	97.81	27.1 QP	43.5	-16.4	1.75 H	325	45.90	-18.80
3	142.44	28.3 QP	43.5	-15.2	1.00 H	118	42.40	-14.10
4	198.71	39.9 QP	43.5	-3.6	1.50 H	285	56.50	-16.60
5	301.56	30.5 QP	46.0	-15.5	1.00 H	152	43.20	-12.70
6	792.48	27.7 QP	46.0	-18.3	1.00 H	63	31.00	-3.30

ANTENNA POLARITY & TEST DISTANCE: VERTICAL AT 3 M

NO.	FREQ. (MHz)	EMISSION LEVEL (dBuV/m)	LIMIT (dBuV/m)	MARGIN (dB)	ANTENNA HEIGHT (m)	TABLE ANGLE (Degree)	RAW VALUE (dBuV)	CORRECTION FACTOR (dB/m)
1	33.78	34.8 QP	40.0	-5.2	1.00 V	292	49.80	-15.00
2	64.83	35.6 QP	40.0	-4.4	1.00 V	13	50.40	-14.80
3	136.62	29.0 QP	43.5	-14.5	1.00 V	146	43.70	-14.70
4	198.71	39.6 QP	43.5	-3.9	1.00 V	339	56.20	-16.60
5	600.38	29.1 QP	46.0	-16.9	2.00 V	341	36.20	-7.10
6	786.66	26.9 QP	46.0	-19.1	1.49 V	7	30.20	-3.30

Remarks:

1. Emission Level(dBuV/m) = Raw Value(dBuV) + Correction Factor(dB/m)
2. Correction Factor(dB/m) = Antenna Factor(dB/m) + Cable Factor(dB)
3. The other emission levels were very low against the limit.
4. Margin value = Emission Level – Limit value

4.2 Conducted Emission Measurement

4.2.1 Limits of Conducted Emission Measurement

Frequency (MHz)	Conducted Limit (dBuV)	
	Quasi-peak	Average
0.15 - 0.5	66 - 56	56 - 46
0.50 - 5.0	56	46
5.0 - 30.0	60	50

- Note:** 1. The lower limit shall apply at the transition frequencies.
 2. The limit decreases in line with the logarithm of the frequency in the range of 0.15 to 0.50MHz.

4.2.2 Test Instruments

Description & Manufacturer	Model No.	Serial No.	Date Of Calibration	Due Date Of Calibration
Test Receiver ROHDE & SCHWARZ	ESCS 30	100288	Apr. 27, 2015	Apr. 26, 2016
RF signal cable (with 10dB PAD) Woken	5D-FB	Cable-cond2-01	Dec. 26, 2015	Dec. 25, 2016
LISN ROHDE & SCHWARZ (EUT)	ESH3-Z5	835239/001	Feb. 26, 2015	Feb. 25, 2016
LISN ROHDE & SCHWARZ (Peripheral)	ESH3-Z5	100312	Jul. 21, 2015	Jul. 20, 2016
Software ADT	BV ADT_Cond_ V7.3.7.3	NA	NA	NA

- Note:** 1. The calibration interval of the above test instruments is 12 months and the calibrations are traceable to NML/ROC and NIST/USA.
 2. The test was performed in HwaYa Shielded Room 2.
 3. The VCCI Site Registration No. is C-2047.

4.2.3 Test Procedures

- The EUT was placed 0.4 meters from the conducting wall of the shielded room with EUT being connected to the power mains through a line impedance stabilization network (LISN). Other support units were connected to the power mains through another LISN. The two LISNs provide 50 ohm/ 50uH of coupling impedance for the measuring instrument.
- Both lines of the power mains connected to the EUT were checked for maximum conducted interference.
- The frequency range from 150kHz to 30MHz was searched. Emission levels under (Limit - 20dB) was not recorded.

Note: The resolution bandwidth and video bandwidth of test receiver is 9kHz for quasi-peak detection (QP) and average detection (AV) at frequency 0.15MHz-30MHz.

4.2.4 Deviation from Test Standard

No deviation.

4.2.5 Test Setup

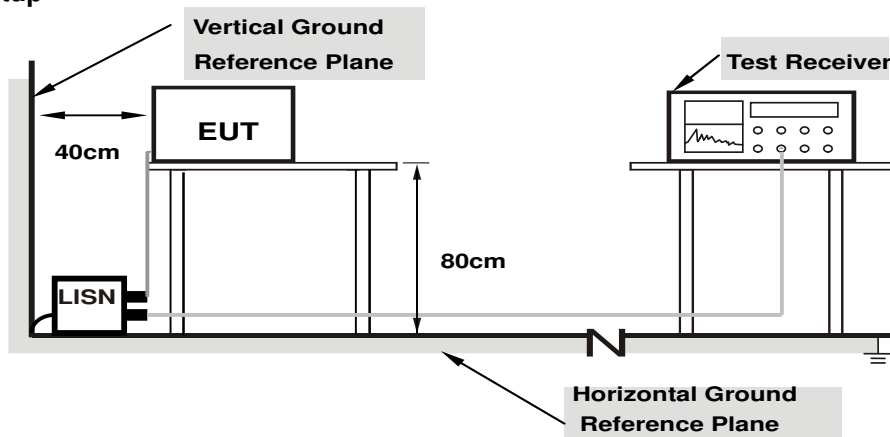

Note: 1.Support units were connected to second LISN.

For the actual test configuration, please refer to the attached file (Test Setup Photo).

4.2.6 EUT Operating Conditions

Same as 4.1.6.

4.2.7 Test Results

Phase	Line (L)	Detector Function	Quasi-Peak (QP) / Average (AV)
Test Mode	A		

No	Freq. [MHz]	Corr. Factor (dB)	Reading Value		Emission Level		Limit		Margin	
			[dB (uV)]		[dB (uV)]		[dB (uV)]		(dB)	
			Q.P.	AV.	Q.P.	AV.	Q.P.	AV.	Q.P.	AV.
1	0.16172	10.10	37.62	24.84	47.72	34.94	65.38	55.38	-17.65	-20.43
2	0.39219	10.15	38.81	34.26	48.96	44.41	58.02	48.02	-9.06	-3.61
3	0.69297	10.17	22.70	14.34	32.87	24.51	56.00	46.00	-23.13	-21.49
4	1.85938	10.24	17.95	11.03	28.19	21.27	56.00	46.00	-27.81	-24.73
5	4.92578	10.34	15.18	8.22	25.52	18.56	56.00	46.00	-30.48	-27.44
6	7.46875	10.40	10.38	5.03	20.78	15.43	60.00	50.00	-39.22	-34.57

REMARKS:

1. Q.P. and AV. are abbreviations of quasi-peak and average individually.
2. The emission levels of other frequencies were very low against the limit.
3. Margin value = Emission level - Limit value
4. Correction factor = Insertion loss + Cable loss
5. Emission Level = Correction Factor + Reading Value.

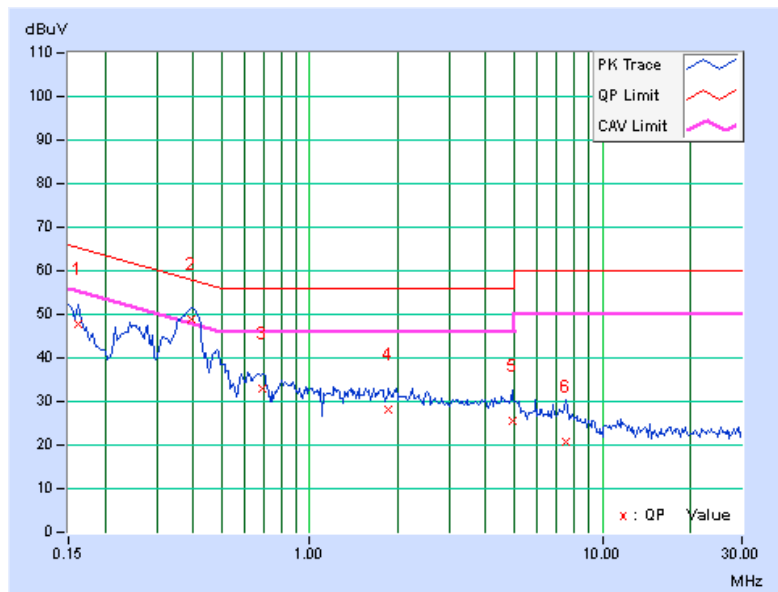

Phase	Neutral (N)	Detector Function	Quasi-Peak (QP) / Average (AV)
Test Mode	A		

No	Freq. [MHz]	Corr. Factor (dB)	Reading Value [dB (uV)]		Emission Level [dB (uV)]		Limit [dB (uV)]		Margin (dB)	
			Q.P.	AV.	Q.P.	AV.	Q.P.	AV.	Q.P.	AV.
	1	0.15781	10.11	38.03	25.61	48.14	35.72	65.58	55.58	-17.44
2	0.39219	10.17	40.23	35.45	50.40	45.62	58.02	48.02	-7.62	-2.40
3	0.61875	10.18	24.87	17.13	35.05	27.31	56.00	46.00	-20.95	-18.69
4	1.08203	10.21	18.93	10.77	29.14	20.98	56.00	46.00	-26.86	-25.02
5	3.29688	10.32	16.28	10.29	26.60	20.61	56.00	46.00	-29.40	-25.39
6	11.66406	10.56	11.92	6.87	22.48	17.43	60.00	50.00	-37.52	-32.57

REMARKS:

1. Q.P. and AV. are abbreviations of quasi-peak and average individually.
2. The emission levels of other frequencies were very low against the limit.
3. Margin value = Emission level - Limit value
4. Correction factor = Insertion loss + Cable loss
5. Emission Level = Correction Factor + Reading Value.

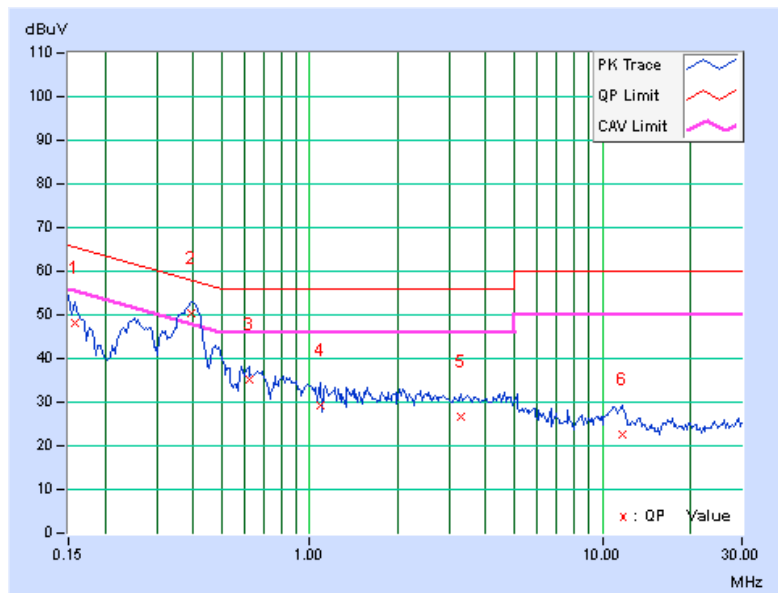

Phase	Line (L)	Detector Function	Quasi-Peak (QP) / Average (AV)
Test Mode	B		

No	Freq. [MHz]	Corr. Factor (dB)	Reading Value [dB (uV)]		Emission Level [dB (uV)]		Limit [dB (uV)]		Margin (dB)	
			Q.P.	AV.	Q.P.	AV.	Q.P.	AV.	Q.P.	AV.
			1	0.16172	10.10	38.81	29.52	48.91	39.62	65.38
2	0.20469	10.11	32.77	25.50	42.88	35.61	63.42	53.42	-20.54	-17.81
3	0.40781	10.15	29.52	24.91	39.67	35.06	57.69	47.69	-18.02	-12.63
4	1.14453	10.20	15.79	8.83	25.99	19.03	56.00	46.00	-30.01	-26.97
5	7.26172	10.40	13.94	8.46	24.34	18.86	60.00	50.00	-35.66	-31.14
6	24.30859	10.48	20.80	15.57	31.28	26.05	60.00	50.00	-28.72	-23.95

REMARKS:

1. Q.P. and AV. are abbreviations of quasi-peak and average individually.
2. The emission levels of other frequencies were very low against the limit.
3. Margin value = Emission level - Limit value
4. Correction factor = Insertion loss + Cable loss
5. Emission Level = Correction Factor + Reading Value.

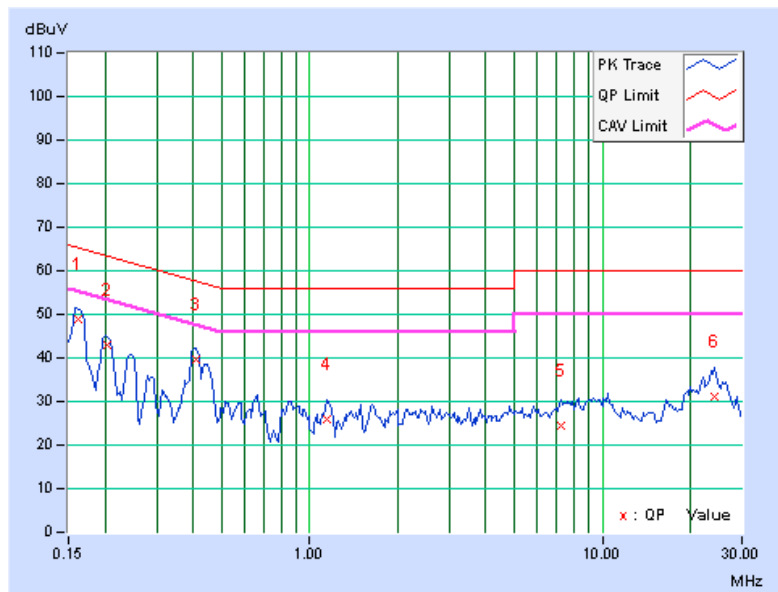

Phase	Neutral (N)	Detector Function	Quasi-Peak (QP) / Average (AV)
Test Mode	B		

No	Freq. [MHz]	Corr. Factor (dB)	Reading Value [dB (uV)]		Emission Level [dB (uV)]		Limit [dB (uV)]		Margin (dB)	
			Q.P.	AV.	Q.P.	AV.	Q.P.	AV.	Q.P.	AV.
			1	0.15781	10.11	38.90	25.91	49.01	36.02	65.58
2	0.19687	10.12	33.23	19.79	43.35	29.91	63.74	53.74	-20.39	-23.83
3	0.40781	10.17	29.33	24.20	39.50	34.37	57.69	47.69	-18.19	-13.32
4	1.45703	10.23	13.71	5.53	23.94	15.76	56.00	46.00	-32.06	-30.24
5	7.52344	10.46	14.21	8.79	24.67	19.25	60.00	50.00	-35.33	-30.75
6	23.88281	10.64	21.65	16.37	32.29	27.01	60.00	50.00	-27.71	-22.99

REMARKS:

1. Q.P. and AV. are abbreviations of quasi-peak and average individually.
2. The emission levels of other frequencies were very low against the limit.
3. Margin value = Emission level - Limit value
4. Correction factor = Insertion loss + Cable loss
5. Emission Level = Correction Factor + Reading Value.

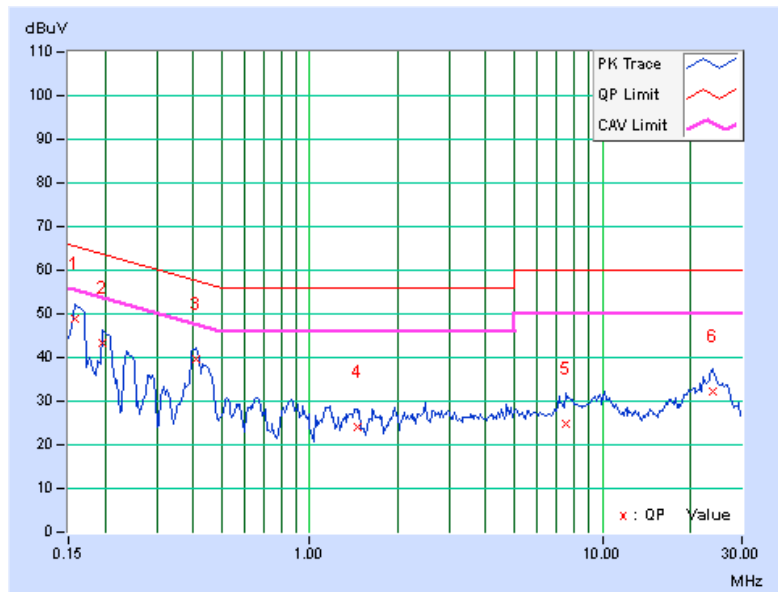

4.3 Number of Hopping Frequency Used

4.3.1 Limits of Hopping Frequency Used Measurement

At least 15 channels frequencies, and should be equally spaced.

4.3.2 Test Setup

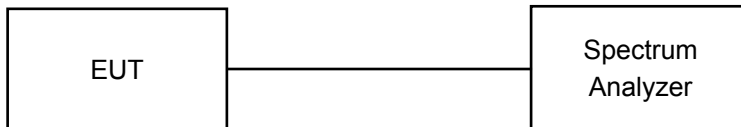

4.3.3 Test Instruments

Refer to section 4.1.2 to get information of above instrument.

4.3.4 Test Procedure

- a. Check the calibration of the measuring instrument (SA) using either an internal calibrator or a known signal from an external generator.
- b. Turn on the EUT and connect its antenna terminal to measurement via a low loss cable. Then set it to any one measured frequency within its operating range and make sure the instrument is operated in its linear range.
- c. Set the SA on MaxHold Mode, and then keep the EUT in hopping mode. Record all the signals from each channel until each one has been recorded.
- d. Set the SA on View mode and then plot the result on SA screen.
- e. Repeat above procedures until all frequencies measured were complete.

4.3.5 Deviation from Test Standard

No deviation.

4.3.6 Test Results

There are 79 hopping frequencies in the hopping mode. Please see as below for the test result. On the plots, it shows that the hopping frequencies are equally spaced.

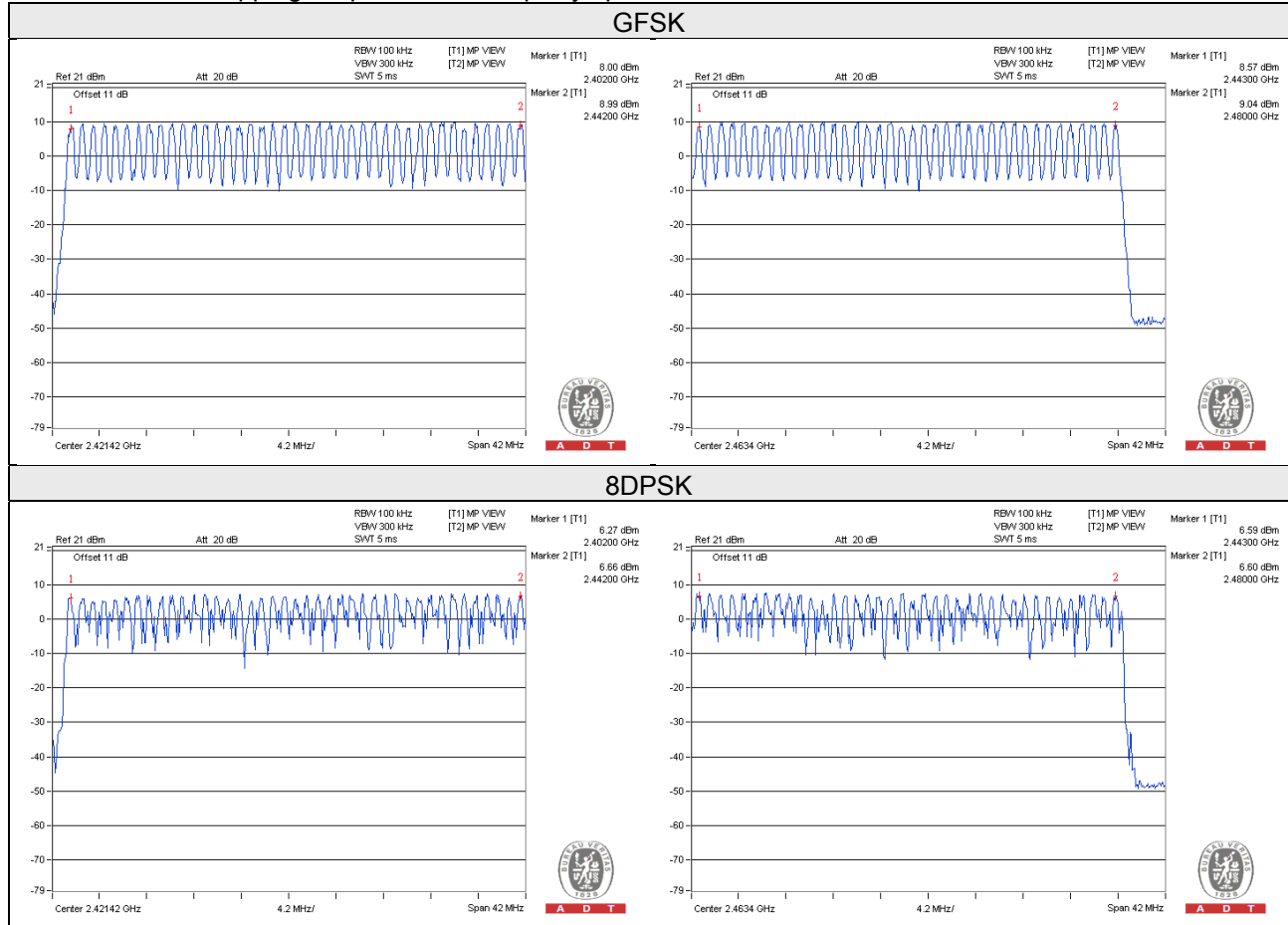

4.4 Dwell Time on Each Channel

4.4.1 Limits of Dwell Time on Each Channel Measurement

The average time of occupancy on any channel shall not be greater than 0.4 seconds within a period of 0.4 seconds multiplied by the number of hopping channels employed.

4.4.2 Test Setup

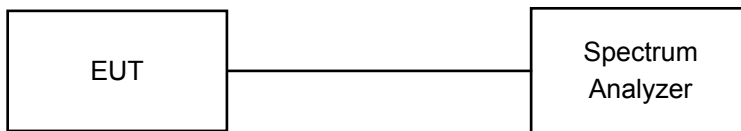

4.4.3 Test Instruments

Refer to section 4.1.2 to get information of above instrument.

4.4.4 Test Procedures

- a. Check the calibration of the measuring instrument (SA) using either an internal calibrator or a known signal from an external generator.
- b. Turn on the EUT and connect its antenna terminal to measurement via a low loss cable. Then set it to any one measured frequency within its operating range and make sure the instrument is operated in its linear range.
- c. Adjust the center frequency of SA on any frequency be measured and set SA to zero span mode. And then, set RBW and VBW of spectrum analyzer to proper value.
- d. Measure the time duration of one transmission on the measured frequency. And then plot the result with time difference of this time duration.
- e. Repeat above procedures until all different time-slot modes have been completed.

4.4.5 Deviation from Test Standard

No deviation.

4.4.6 Test Results

GFSK

Mode	Number of transmission in a 31.6 (79Hopping*0.4)	Length of transmission time (msec)	Result (msec)	Limit (msec)
DH1	48 (times / 5 sec) * 6.32 = 303.36 times	0.426	129.23	400
DH3	27 (times / 5 sec) * 6.32 = 170.64 times	1.739	296.74	400
DH5	17 (times / 5 sec) * 6.32 = 107.44 times	2.964	318.45	400

Note: Test plots of the transmitting time slot are shown as below.

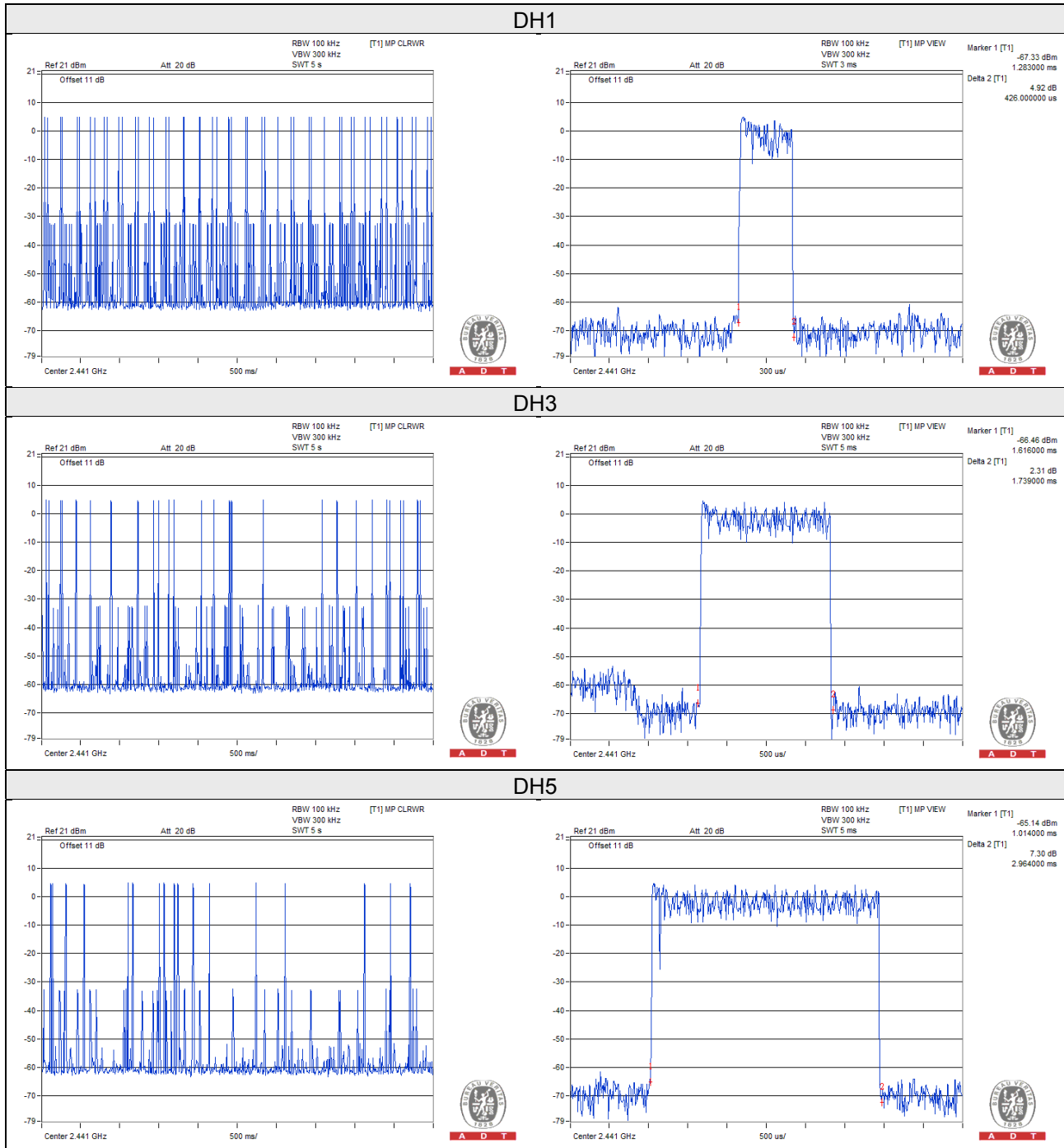

8DPSK

Mode	Number of transmission in a 31.6 (79Hopping*0.4)	Length of transmission time (msec)	Result (msec)	Limit (msec)
DH1	50 (times / 5 sec) * 6.32 = 316.00 times	0.450	142.20	400
DH3	25 (times / 5 sec) * 6.32 = 158.00 times	1.690	267.02	400
DH5	17 (times / 5 sec) * 6.32 = 107.44 times	2.935	315.34	400

Note: Test plots of the transmitting time slot are shown as below.

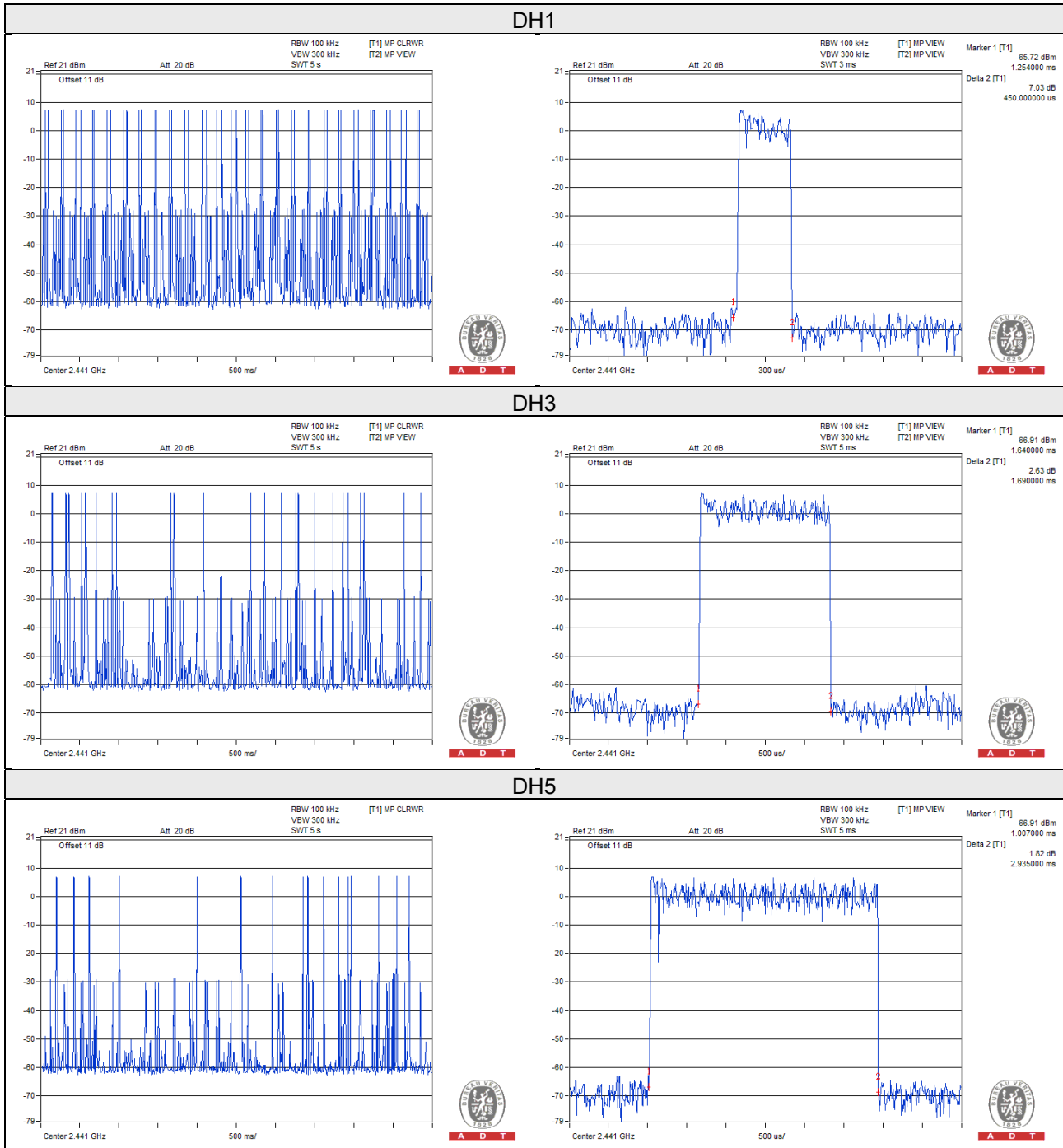

4.5 Channel Bandwidth

4.5.1 Limits of Channel Bandwidth Measurement

For frequency hopping system operating in the 2400-2483.5MHz, If the 20dB bandwidth of hopping channel is greater than 25kHz, two-thirds 20dB bandwidth of hopping channel shall be a minimum limit for the hopping channel separation.

4.5.2 Test Setup

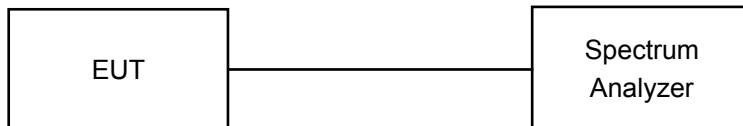

4.5.3 Test Instruments

Refer to section 4.1.2 to get information of above instrument.

4.5.4 Test Procedure

- a. Check the calibration of the measuring instrument using either an internal calibrator or a known signal from an external generator.
- b. Turn on the EUT and connect it to measurement instrument. Then set it to any one convenient frequency within its operating range. Set a reference level on the measuring instrument equal to the highest peak value.
- c. Measure the frequency difference of two frequencies that were attenuated 20dB from the reference level. Record the frequency difference as the emission bandwidth.
- d. Repeat above procedures until all frequencies measured were complete.

4.5.5 Deviation from Test Standard

No deviation.

4.5.6 EUT Operating Condition

The software provided by client enabled the EUT to transmit and receive data at lowest, middle and highest channel frequencies individually.

4.5.7 Test Results

Channel	Frequency (MHz)	20dB Bandwidth (MHz)	
		GFSK	8DPSK
0	2402	1.05	1.17
39	2441	1.04	1.17
78	2480	1.05	1.16

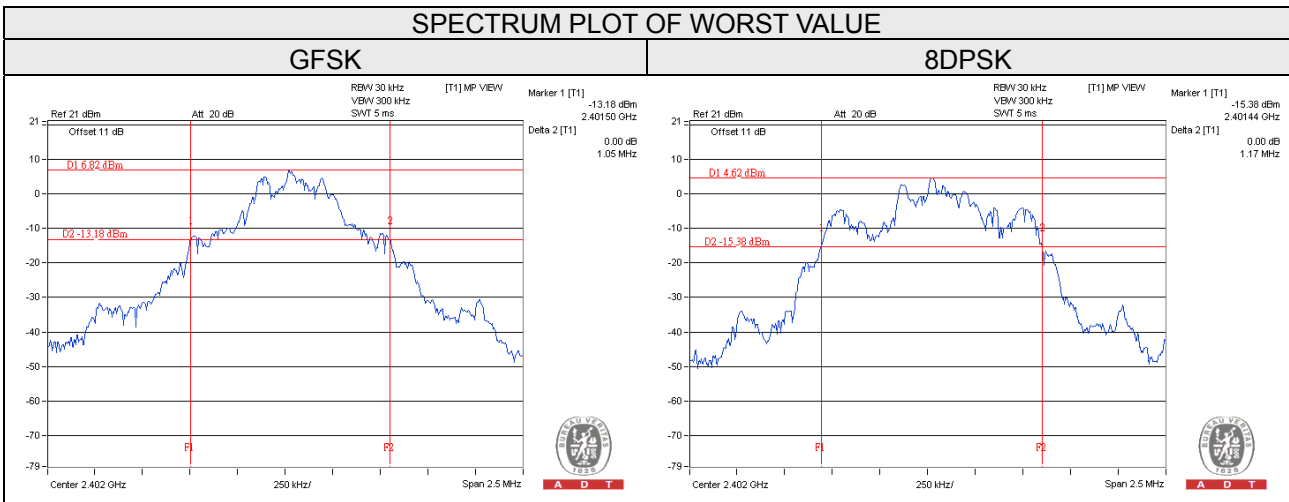

4.6 Hopping Channel Separation

4.6.1 Limits of Hopping Channel Separation Measurement

At least 25kHz or two-third of 20dB hopping channel bandwidth (whichever is greater).

4.6.2 Test Setup

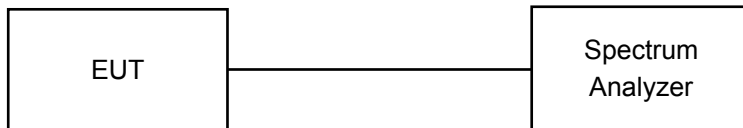

4.6.3 Test Instruments

Refer to section 4.1.2 to get information of above instrument.

4.6.4 Test Procedure

MEASUREMENT PROCEDURE REF

- Check the calibration of the measuring instrument using either an internal calibrator or a known signal from an external generator.
- Turn on the EUT and connect it to measurement instrument. Then set it to any one convenient frequency within its operating range.
- By using the MaxHold function record the separation of two adjacent channels.
- Measure the frequency difference of these two adjacent channels by SA MARK function. And then plot the result on SA screen.
- Repeat above procedures until all frequencies measured were complete.

4.6.5 Deviation from Test Standard

No deviation.

4.6.6 Test Results

Channel	Frequency (MHz)	Adjacent Channel Separation (MHz)		20dB Bandwidth (MHz)		Minimum Limit (MHz)		Pass / Fail
		GFSK	8DPSK	GFSK	8DPSK	GFSK	8DPSK	
0	2402	1.00	1.01	1.05	1.17	0.70	0.78	Pass
39	2441	1.00	1.01	1.04	1.17	0.69	0.78	Pass
78	2480	1.00	1.00	1.05	1.16	0.70	0.77	Pass

Note: The minimum limit is two-third 20dB bandwidth.

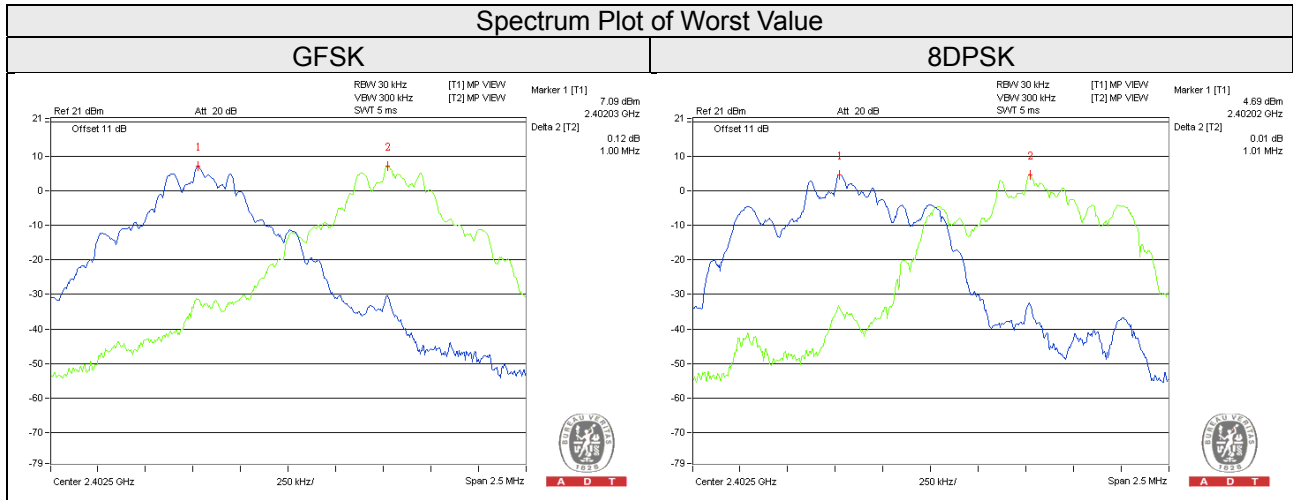

4.7 Maximum Output Power

4.7.1 Limits of Maximum Output Power Measurement

The Maximum Output Power Measurement is 125mW.

4.7.2 Test Setup

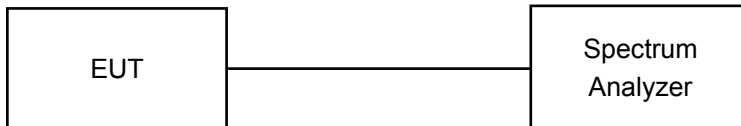

4.7.3 Test Instruments

Refer to section 4.1.2 to get information of above instrument.

4.7.4 Test Procedure

- a. Check the calibration of the measuring instrument using either an internal calibrator or a known signal from an external generator.
- b. Turn on the EUT and connect it to measurement instrument. Then set it to any one convenient frequency within its operating range. Set a reference level on the measuring instrument equal to the highest peak value.
- c. The center frequency of the spectrum analyzer is set to the fundamental frequency and using 3MHz RBW and 10 MHz VBW.
- d. Measure the captured power within the band and recording the plot.
- e. Repeat above procedures until all frequencies required were complete.

4.7.5 Deviation from Test Standard

No deviation.

4.7.6 EUT Operating Condition

The software provided by client enabled the EUT to transmit and receive data at lowest, middle and highest channel frequencies individually.

4.7.7 Test Results

Channel	Frequency (MHz)	Output Power (mW)		Output Power (dBm)		Power Limit (mW)	Pass / Fail
		GFSK	8DPSK	GFSK	8DPSK		
0	2402	10.765	10.471	10.32	10.20	125	Pass
39	2441	12.303	11.695	10.90	10.68	125	Pass
78	2480	11.695	10.765	10.68	10.32	125	Pass

Spectrum Plot of Worst Value

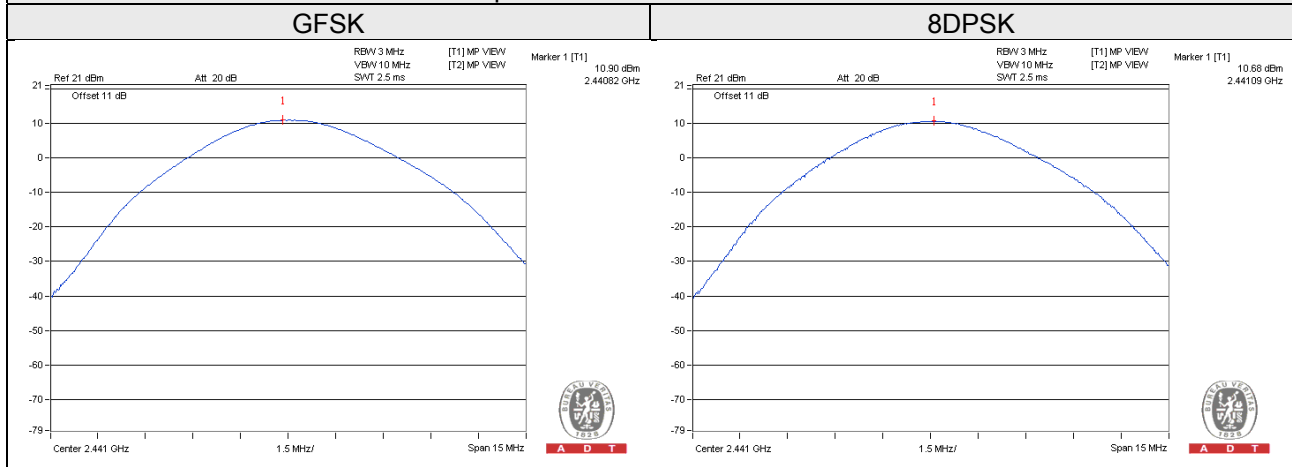

4.8 Conducted Out of Band Emission Measurement

4.8.1 Limits of Conducted Out of Band Emission Measurement

Below -20dB of the highest emission level of operating band (in 100kHz RBW).

4.8.2 Test Instruments

Refer to section 4.1.2 to get information of above instrument.

4.8.3 Test Procedure

The transmitter output was connected to the spectrum analyzer via a low lose cable. Set both RBW and VBW of spectrum analyzer to 100 kHz and 300 kHz with suitable frequency span including 100 MHz bandwidth from band edge. The band edges was measured and recorded.

4.8.4 Deviation from Test Standard

No deviation.

4.8.5 EUT Operating Condition

The software provided by client enabled the EUT to transmit and receive data at lowest, middle and highest channel frequencies individually.

4.8.6 Test Results

The spectrum plots are attached on the following images. D1 line indicates the highest level, D2 line indicates the 20dB offset below D1. It shows compliance with the requirement.

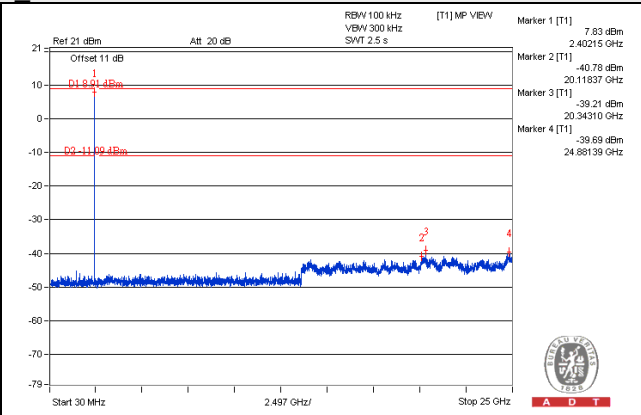
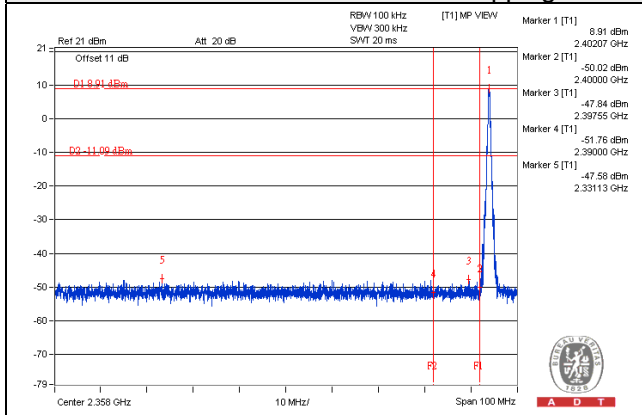
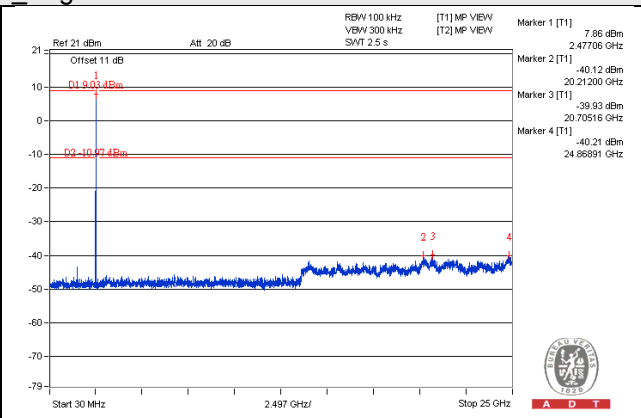
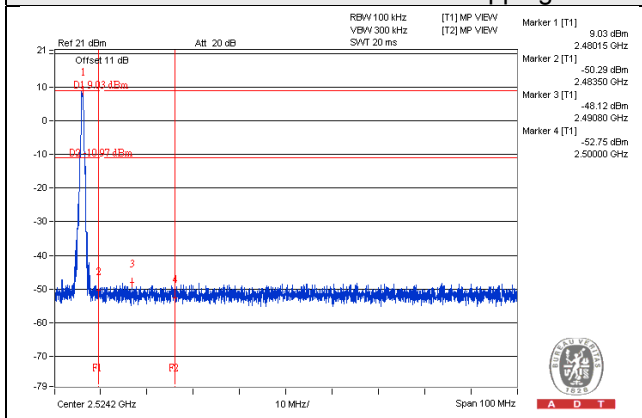
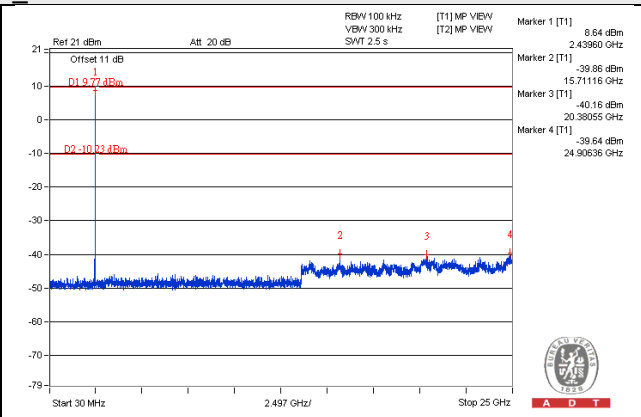
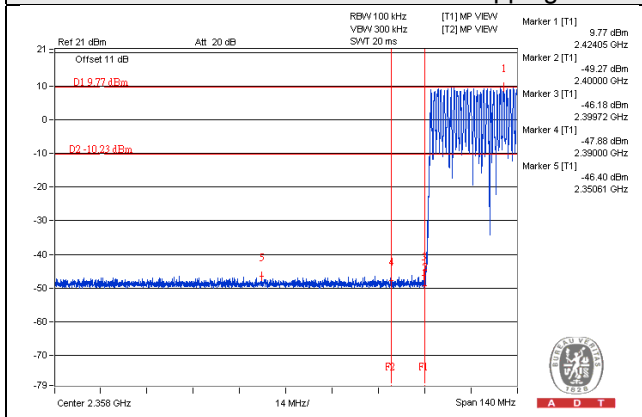
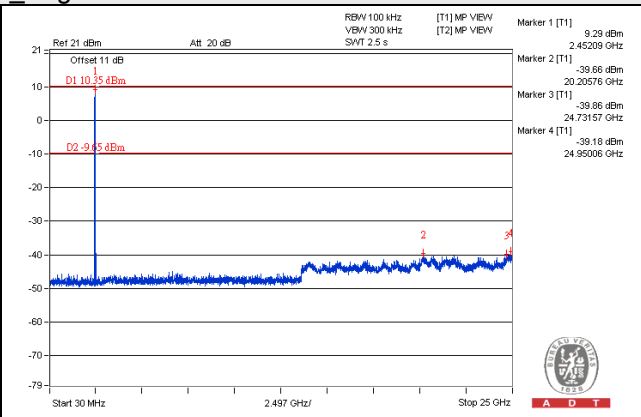
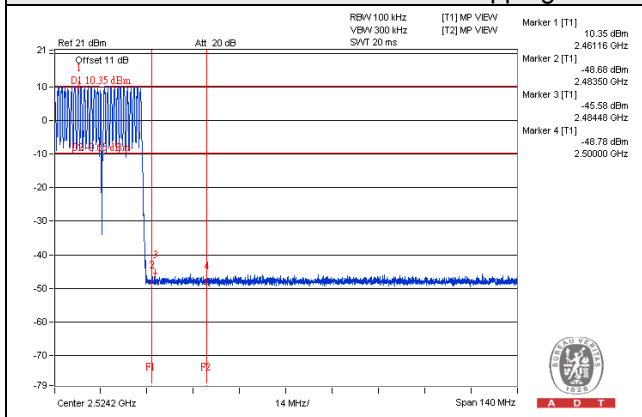
GFSK**Hopping disabled Low Channel****Hopping disabled High Channel****Hopping enabled Low Channel****Hopping enabled High Channel**

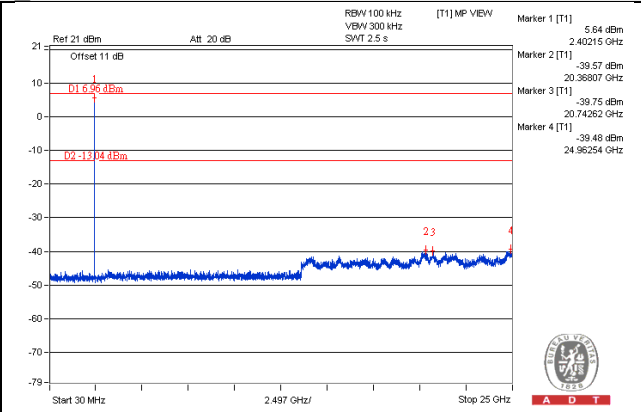
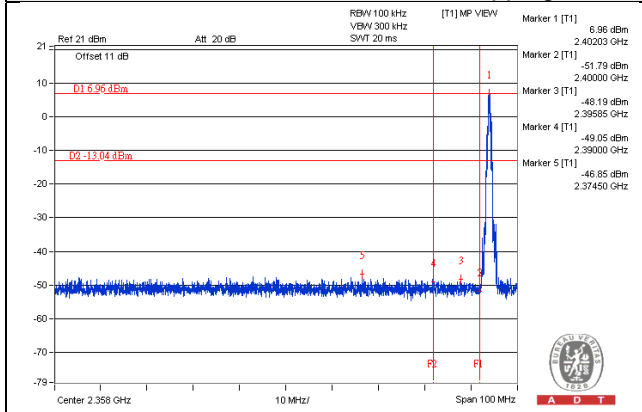
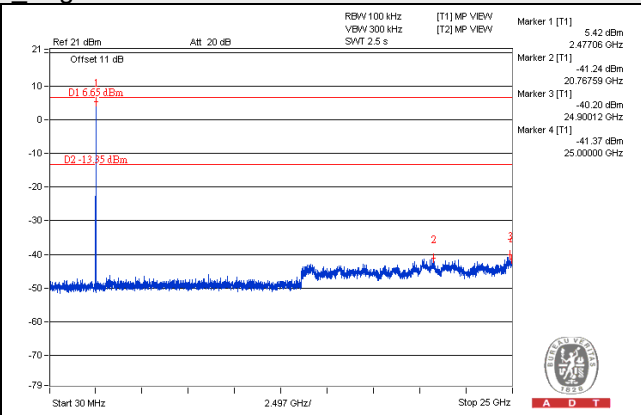
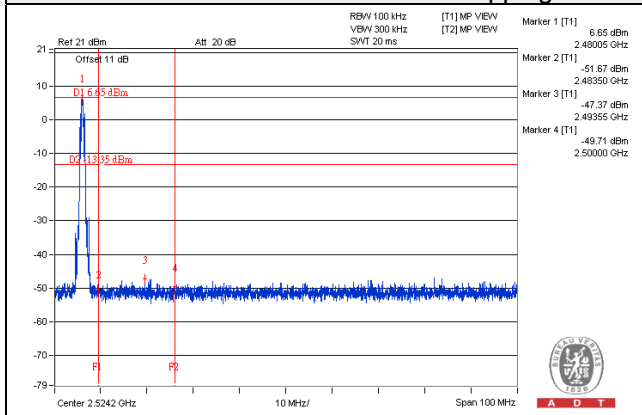
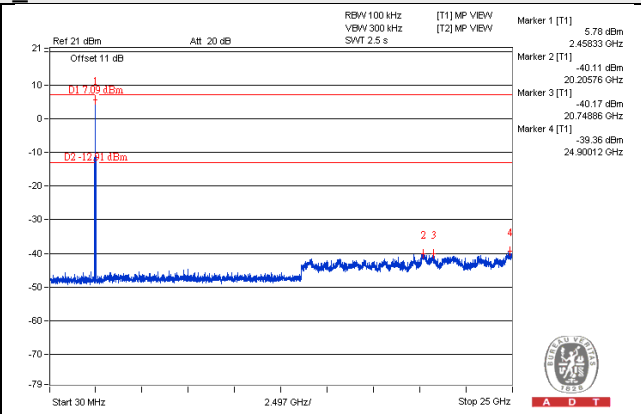
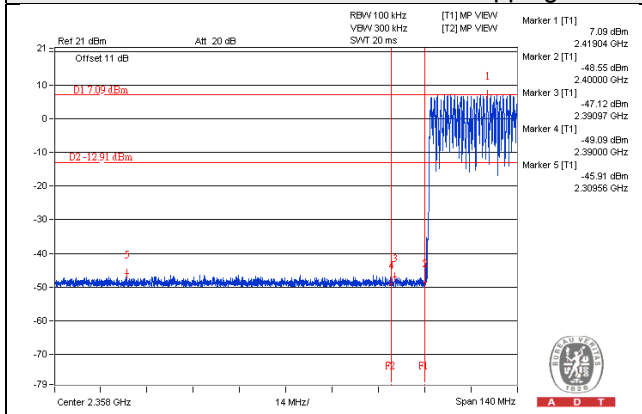
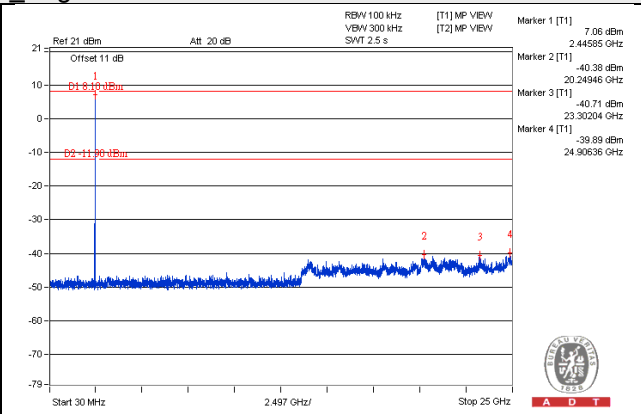
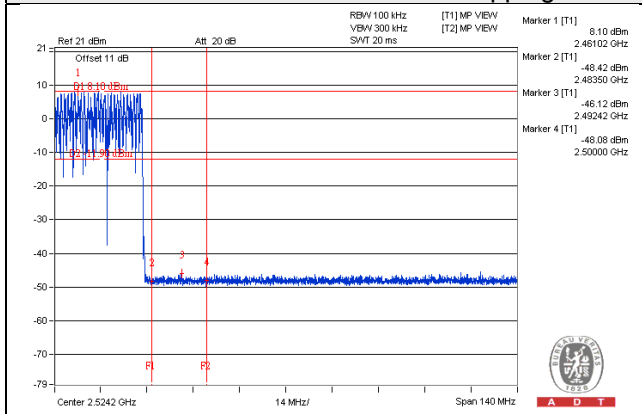
8DPSK**Hopping disabled Low Channel****Hopping disabled High Channel****Hopping enabled Low Channel****Hopping enabled High Channel**

5 Pictures of Test Arrangements

Please refer to the attached file (Test Setup Photo).

Appendix – Information on the Testing Laboratories

We, Bureau Veritas Consumer Products Services (H.K.) Ltd., Taoyuan Branch, were founded in 1988 to provide our best service in EMC, Radio, Telecom and Safety consultation. Our laboratories are accredited and approved according to ISO/IEC 17025.

If you have any comments, please feel free to contact us at the following:

Linko EMC/RF Lab

Tel: 886-2-26052180

Fax: 886-2-26051924

Hsin Chu EMC/RF/Telecom Lab

Tel: 886-3-6668565

Fax: 886-3-6668323

Hwa Ya EMC/RF/Safety Lab

Tel: 886-3-3183232

Fax: 886-3-3270892

Email: service.adt@tw.bureauveritas.com

Web Site: www.bureauveritas-adt.com

The address and road map of all our labs can be found in our web site also.

--- END ---