

FCC Test Report

Report No.: RF151230E03-1

FCC ID: 2AHBN-AP41

Test Model: AP41

Received Date: Dec. 23, 2015

Test Date: Dec. 24, 2015 ~ Jan. 19, 2016

Issued Date: Jan. 25, 2016

Applicant: Mist Systems, Inc.

Address: 1601 South De Anza Blvd. Suite 248 Cupertino California United States
95014

Issued By: Bureau Veritas Consumer Products Services (H.K.) Ltd., Taoyuan Branch

Lab Address: No. 47-2, 14th Ling, Chia Pau Vil., Lin Kou Dist., New Taipei City, Taiwan,
R.O.C.

Test Location: No. 19, Hwa Ya 2nd Rd., Wen Hwa Vil., Kwei Shan Dist., Taoyuan City
33383, TAIWAN (R.O.C.)



This report is for your exclusive use. Any copying or replication of this report to or for any other person or entity, or use of our name or trademark, is permitted only with our prior written permission. This report sets forth our findings solely with respect to the test samples identified herein. The results set forth in this report are not indicative or representative of the quality or characteristics of the lot from which a test sample was taken or any similar or identical product unless specifically and expressly noted. Our report includes all of the tests requested by you and the results thereof based upon the information that you provided to us. You have 60 days from date of issuance of this report to notify us of any material error or omission caused by our negligence, provided, however, that such notice shall be in writing and shall specifically address the issue you wish to raise. A failure to raise such issue within the prescribed time shall constitute your unqualified acceptance of the completeness of this report, the tests conducted and the correctness of the report contents. Unless specific mention, the uncertainty of measurement has been explicitly taken into account to declare the compliance or non-compliance to the specification. The report must not be used by the client to claim product certification, approval, or endorsement by TAF or any government agencies.

Table of Contents

Release Control Record	4
1 Certificate of Conformity	5
2 Summary of Test Results	6
2.1 Measurement Uncertainty.....	6
2.2 Modification Record.....	6
3 General Information	7
3.1 General Description of EUT.....	7
3.2 Description of Test Modes.....	9
3.2.1 Test Mode Applicability and Tested Channel Detail.....	10
3.3 Duty Cycle of Test Signal.....	12
3.4 Description of Support Units.....	17
3.4.1 Configuration of System under Test.....	17
3.5 General Description of Applied Standards.....	18
4 Test Types and Results	19
4.1 Radiated Emission and Bandedge Measurement.....	19
4.1.1 Limits of Radiated Emission and Bandedge Measurement.....	19
4.1.2 Test Instruments.....	20
4.1.3 Test Procedures.....	21
4.1.4 Deviation from Test Standard.....	21
4.1.5 Test Set Up.....	22
4.1.6 EUT Operating Conditions.....	22
4.1.7 Test Results.....	23
4.2 Conducted Emission Measurement.....	117
4.2.1 Limits of Conducted Emission Measurement.....	117
4.2.2 Test Instruments.....	117
4.2.3 Test Procedures.....	118
4.2.4 Deviation from Test Standard.....	118
4.2.5 Test Setup.....	118
4.2.6 EUT Operating Conditions.....	118
4.2.7 Test Results.....	119
4.3 Transmit Power Measurement.....	127
4.3.1 Limits of Transmit Power Measurement.....	127
4.3.2 Test Setup.....	127
4.3.3 Test Instruments.....	127
4.3.4 Test Procedure.....	128
4.3.5 Deviation from Test Standard.....	128
4.3.6 EUT Operating Conditions.....	128
4.3.7 Test Result.....	129
4.4 Peak Power Spectral Density Measurement.....	157
4.4.1 Limits of Peak Power Spectral Density Measurement.....	157
4.4.2 Test Setup.....	157
4.4.3 Test Instruments.....	157
4.4.4 Test Procedures.....	158
4.4.5 Deviation from Test Standard.....	158
4.4.6 EUT Operating Conditions.....	158
4.4.7 Test Results.....	159
4.5 Frequency Stability.....	183
4.5.1 Limits of Frequency Stability Measurement.....	183
4.5.2 Test Setup.....	183
4.5.3 Test Instruments.....	183
4.5.4 Test Procedure.....	183
4.5.5 Deviation from Test Standard.....	183
4.5.6 EUT Operating Condition.....	183

4.5.7 Test Results	184
4.6 6dB Bandwidth Measurement	189
4.6.1 Limits of 6dB Bandwidth Measurement	189
4.6.2 Test Setup	189
4.6.3 Test Instruments	189
4.6.4 Test Procedure	189
4.6.5 Deviation from Test Standard	189
4.6.6 EUT Operating Condition	189
4.6.7 Test Results	190
5 Pictures of Test Arrangements	200
Appendix – Information on the Testing Laboratories	201



Release Control Record

Issue No.	Description	Date Issued
RF151230E03-1	Original release	Jan. 25, 2016

1 Certificate of Conformity

Product: Premium Wi-Fi & BLE Array AP

Brand: Mist

Test Model: AP41

Sample Status: Engineering sample

Applicant: Mist Systems, Inc.

Test Date: Dec. 24, 2015 ~ Jan. 19, 2016

Standards: 47 CFR FCC Part 15, Subpart E (Section 15.407)
ANSI C63.10:2013

The above equipment has been tested by **Bureau Veritas Consumer Products Services (H.K.) Ltd., Taoyuan Branch**, and found compliance with the requirement of the above standards. The test record, data evaluation & Equipment Under Test (EUT) configurations represented herein are true and accurate accounts of the measurements of the sample's EMC characteristics under the conditions specified in this report.

Prepared by :  _____, **Date:** _____ Jan. 25, 2016
Pettie Chen / Senior Specialist

Approved by :  _____, **Date:** _____ Jan. 25, 2016
Ken Liu / Senior Manager

2 Summary of Test Results

47 CFR FCC Part 15, Subpart E (SECTION 15.407)			
FCC Clause	Test Item	Result	Remarks
15.407(b)(6)	AC Power Conducted Emissions	Pass	Meet the requirement of limit. Minimum passing margin is -3.28dB at 0.38828MHz.
15.407(b) (1/2/3/4/6)	Radiated Emissions & Band Edge Measurement	Pass	Meet the requirement of limit. Minimum passing margin is -0.1dB at 5150.00, 5722.90, 5860.10MHz.
15.407(a)(1/2 /3)	Max Average Transmit Power	Pass	Meet the requirement of limit.
15.407(a)(1/2 /3)	Peak Power Spectral Density	Pass	Meet the requirement of limit.
15.407(e)	6dB bandwidth	Pass	Meet the requirement of limit. (U-NII-3 Band only)
15.407(g)	Frequency Stability	Pass	Meet the requirement of limit.
15.203	Antenna Requirement	Pass	Antenna connector is IPEX not a standard connector.

2.1 Measurement Uncertainty

Where relevant, the following measurement uncertainty levels have been estimated for tests performed on the EUT as specified in CISPR 16-4-2:

Measurement	Frequency	Expanded Uncertainty (k=2) (\pm)
Conducted Emissions at mains ports	150kHz ~ 30MHz	2.44 dB
Radiated Emissions up to 1 GHz	30MHz ~ 200MHz	3.59 dB
	200MHz ~ 1000MHz	3.60 dB
Radiated Emissions above 1 GHz	1GHz ~ 18GHz	2.29 dB
	18GHz ~ 40GHz	2.29 dB

2.2 Modification Record

There were no modifications required for compliance.

3 General Information

3.1 General Description of EUT

Product	Premium Wi-Fi & BLE Array AP
Brand	Mist
Test Model	AP41
Status of EUT	Engineering sample
Power Supply Rating	12Vdc from adapter 55Vdc from PoE
Modulation Type	256QAM, 64QAM, 16QAM, QPSK, BPSK
Modulation Technology	OFDM
Transfer Rate	802.11a: 54.0/ 48.0/ 36.0/ 24.0/ 18.0/ 12.0/ 9.0/ 6.0Mbps 802.11n: up to 600.0Mbps 802.11ac: up to 1733.3Mbps
Operating Frequency	5180 ~ 5240MHz & 5745 ~ 5825MHz
Number of Channel	5180 ~ 5240MHz: 4 for 802.11a, 802.11n (HT20), 802.11ac (VHT20) 2 for 802.11n (HT40), 802.11ac (VHT40) 1 for 802.11ac (VHT80) 5745 ~ 5825MHz: 5 for 802.11a, 802.11n (HT20), 802.11ac (VHT20) 2 for 802.11n (HT40), 802.11ac (VHT40) 1 for 802.11ac (VHT80)
Output Power	Radio 1: 1TX 5180 ~ 5240MHz: 326.588mW 5745 ~ 5825MHz: 214.783mW 2TX 5180 ~ 5240MHz: 557.474mW 5745 ~ 5825MHz: 393.199mW 3TX 5180 ~ 5240MHz: 531.255mW 5745 ~ 5825MHz: 533.297mW 4TX 5180 ~ 5240MHz: 383.860mW 5745 ~ 5825MHz: 663.544mW Radio 2: 1TX 5180 ~ 5240MHz: 261.216mW 5745 ~ 5825MHz: 244.343mW
Antenna Type	Refer to Note
Antenna Connector	IPEX
Accessory Device	N/A
Data Cable Supplied	N/A

Note:

1. There are three radios for the EUT.

Radio	Brand	Model	Function
Radio 1	Broadcom	BCM43465	WLAN 2.4G & 5G
Radio 2	Broadcom	BCM43465	WLAN 2.4G & 5G
Radio 3	Broadcom	BCM20704	BT EDR & BT LE

2. The EUT incorporates a MIMO function. Physically, the EUT provides 4 completed transmitters and 4 receivers.

Modulation Mode	TX Function	Beamforming
Radio 1		
802.11a	1TX/2TX/3TX/4TX	Not Support
802.11n (HT20)	1TX/2TX/3TX/4TX	Support
802.11n (HT40)	1TX/2TX/3TX/4TX	Support
802.11ac (VHT20)	1TX/2TX/3TX/4TX	Support
802.11ac (VHT40)	1TX/2TX/3TX/4TX	Support
802.11ac (VHT80)	1TX/2TX/3TX/4TX	Support
Radio 2		
802.11a	1TX	Not Support
802.11n (HT20)	1TX	Not Support
802.11n (HT40)	1TX	Not Support
802.11ac (VHT20)	1TX	Not Support
802.11ac (VHT40)	1TX	Not Support
802.11ac (VHT80)	1TX	Not Support

*The worst case of Radio 1 is beamforming on mode for the final tests.

*The modulation and bandwidth are similar for 802.11n mode for HT20 / HT40 and 802.11ac mode for VHT20 / VHT40, therefore investigated worst case to representative mode in test report. (Final test mode refer section 3.2.1)

*The worst configuration is as below.

Mode	Chain
Radio 1 / 1TX	Chain 0
Radio 1 / 2TX	Chain 0 + 1
Radio 1 / 3TX	Chain 0 + 1 + 2
Radio 1 / 4TX	Chain 0 + 1 + 2 + 3

3. The EUT uses following adapter & PoE. (Support unit only)

Adapter	
Brand	Channel Well Technology
Model	2ABN036F US
Input Power	100-240Vac~50/60Hz 1.0A
Output Power	12.0Vdc / 3.0A
Power Line	1.45m DC cable without core attached on adapter

PoE	
Brand	Microsemi
Model	PD-9001GR/AT/AC
Input Power	100-240Vac~50/60Hz 0.67A
Output Power	55Vdc / 0.6A

4. The following antennas were provided to the EUT.

Antenna Type	PIFA				
Antenna Connector	IPEX				
Gain (dBi)	Frequency				
	2.4~2.4835GHz	5.15~5.25GHz	5.25~5.35GHz	5.47~5.725GHz	5.725~5.85GHz
Int. WIFI Ant. 1	3.06	3.85	3.97	4.21	4.18
Int. WIFI Ant. 2	3.64	4.49	4.21	3.27	3.99
Int. WIFI Ant. 3	3.37	3.50	4.04	4.14	4.34
Int. WIFI Ant. 4	3.54	3.87	3.77	4.02	4.17
Scanning Radio Ant.	3.61	3.59	4.21	4.43	4.29

*Int. WIFI Ant. 1~4 were for Radio 1.

*Scanning Radio Ant. was for Radio 2

3.2 Description of Test Modes

FOR 5180 ~ 5240MHz:

4 channels are provided for 802.11a, 802.11n (HT20), 802.11ac (VHT20):

Channel	Frequency	Channel	Frequency
36	5180 MHz	44	5220 MHz
40	5200 MHz	48	5240 MHz

2 channels are provided for 802.11n (HT40), 802.11ac (VHT40):

Channel	Frequency	Channel	Frequency
38	5190 MHz	46	5230 MHz

1 channel is provided for 802.11ac (VHT80):

Channel	Frequency
42	5210 MHz

FOR 5745 ~ 5825MHz:

5 channels are provided for 802.11a, 802.11n (HT20), 802.11ac (VHT20):

Channel	Frequency	Channel	Frequency
149	5745MHz	161	5805MHz
153	5765MHz	165	5825MHz
157	5785MHz		

2 channels are provided for 802.11n (HT40), 802.11ac (VHT40):

Channel	Frequency	Channel	Frequency
151	5755MHz	159	5795MHz

1 channel is provided for 802.11ac (VHT80):

Channel	Frequency
155	5775MHz

3.2.1 Test Mode Applicability and Tested Channel Detail

EUT CONFIGURE MODE	APPLICABLE TO				DESCRIPTION
	RE \geq 1G	RE $<$ 1G	PLC	APCM	
A	-	√	√	√	Radio 1 (Power from adapter)
B	√	√	√	-	Radio 1 (Power from PoE)
C	-	√	√	√	Radio 2 (Power from adapter)
D	√	√	√	-	Radio 2 (Power from PoE)

Where **RE \geq 1G**: Radiated Emission above 1GHz & Bandedge Measurement
RE $<$ 1G: Radiated Emission below 1GHz
PLC: Power Line Conducted Emission
APCM: Antenna Port Conducted Measurement

NOTE: 1. The EUT could just position on the Z-plane according to manufacturer's requirement.
 2. "-" means no effect.

Radiated Emission Test (Above 1GHz):

- Pre-Scan has been conducted to determine the worst-case mode from all possible combinations between available modulations, data rates and antenna ports (if EUT with antenna diversity architecture).
- Following channel(s) was (were) selected for the final test as listed below.

EUT CONFIGURE MODE	MODE	FREQ. BAND (MHz)	AVAILABLE CHANNEL	TESTED CHANNEL	MODULATION TECHNOLOGY	MODULATION TYPE	DATA RATE (Mbps)
B, D	802.11a	5180-5240	36 to 48	36, 40, 48	OFDM	BPSK	6.0
B, D	802.11n (HT20)		36 to 48	36, 40, 48	OFDM	BPSK	6.5
B, D	802.11n (HT40)		38 to 46	38, 46	OFDM	BPSK	13.5
B, D	802.11ac (VHT80)		42	42	OFDM	BPSK	29.3
B, D	802.11a	5745-5825	149 to 165	149, 157, 165	OFDM	BPSK	6.0
B, D	802.11n (HT20)		149 to 165	149, 157, 165	OFDM	BPSK	6.5
B, D	802.11n (HT40)		151 to 159	151, 159	OFDM	BPSK	13.5
B, D	802.11ac (VHT80)		155	155	OFDM	BPSK	29.3

Radiated Emission Test (Below 1GHz):

- Pre-Scan has been conducted to determine the worst-case mode from all possible combinations between available modulations, data rates and antenna ports (if EUT with antenna diversity architecture).
- Following channel(s) was (were) selected for the final test as listed below.

EUT CONFIGURE MODE	MODE	FREQ. BAND (MHz)	AVAILABLE CHANNEL	TESTED CHANNEL	MODULATION TECHNOLOGY	MODULATION TYPE	DATA RATE (Mbps)
A, B, C, D	802.11a	5180-5240	36 to 48	157	OFDM	BPSK	6.0
	802.11a	5745-5825	149 to 165		OFDM	BPSK	6.0

Power Line Conducted Emission Test:

- Pre-Scan has been conducted to determine the worst-case mode from all possible combinations between available modulations, data rates and antenna ports (if EUT with antenna diversity architecture).
- Following channel(s) was (were) selected for the final test as listed below.

EUT CONFIGURE MODE	MODE	FREQ. BAND (MHz)	AVAILABLE CHANNEL	TESTED CHANNEL	MODULATION TECHNOLOGY	MODULATION TYPE	DATA RATE (Mbps)
A, B, C, D	802.11a	5180-5240	36 to 48	157	OFDM	BPSK	6.0
	802.11a	5745-5825	149 to 165		OFDM	BPSK	6.0

Antenna Port Conducted Measurement:

- This item includes all test value of each mode, but only includes spectrum plot of worst value of each mode.
- Pre-Scan has been conducted to determine the worst-case mode from all possible combinations between available modulations, data rates and antenna ports (if EUT with antenna diversity architecture).
- Following channel(s) was (were) selected for the final test as listed below.

EUT CONFIGURE MODE	MODE	FREQ. BAND (MHz)	AVAILABLE CHANNEL	TESTED CHANNEL	MODULATION TECHNOLOGY	MODULATION TYPE	DATA RATE (Mbps)
A, C	802.11a	5180-5240	36 to 48	36, 40, 48	OFDM	BPSK	6.0
A, C	802.11n (HT20)		36 to 48	36, 40, 48	OFDM	BPSK	6.5
A, C	802.11n (HT40)		38 to 46	38, 46	OFDM	BPSK	13.5
A, C	802.11ac (VHT80)		42	42	OFDM	BPSK	29.3
A, C	802.11a	5745-5825	149 to 165	149, 157, 165	OFDM	BPSK	6.0
A, C	802.11n (HT20)		149 to 165	149, 157, 165	OFDM	BPSK	6.5
A, C	802.11n (HT40)		151 to 159	151, 159	OFDM	BPSK	13.5
A, C	802.11ac (VHT80)		155	155	OFDM	BPSK	29.3

Test Condition:

APPLICABLE TO	ENVIRONMENTAL CONDITIONS	INPUT POWER	TESTED BY
RE_≥1G	22deg. C, 65%RH 23deg. C, 66%RH	120Vac, 60Hz	Chris Lin Alan Wu
RE_{<}1G	23deg. C, 66%RH	120Vac, 60Hz 55Vdc	Alan Wu
PLC	25deg. C, 65%RH	120Vac, 60Hz 55Vdc	Chris Lin
APCM	25deg. C, 60%RH	120Vac, 60Hz	Frاند Liu

3.3 Duty Cycle of Test Signal

Radio 1:

1TX

Duty cycle of test signal is > 98%, duty factor is not required

Duty cycle of test signal is < 98 %, duty factor is required

802.11a: Duty cycle = 2.057/2.094 = 0.981

802.11n (HT20): Duty cycle = 1.90/1.94= 0.979, Duty factor = $10 * \log(1/0.979) = 0.09$

802.11n (HT40): Duty cycle = 0.942/0.972= 0.969, Duty factor = $10 * \log(1/0.969) = 0.14$

802.11ac (VHT80): Duty cycle = 0.46/0.49= 0.939, Duty factor = $10 * \log(1/0.939) = 0.27$

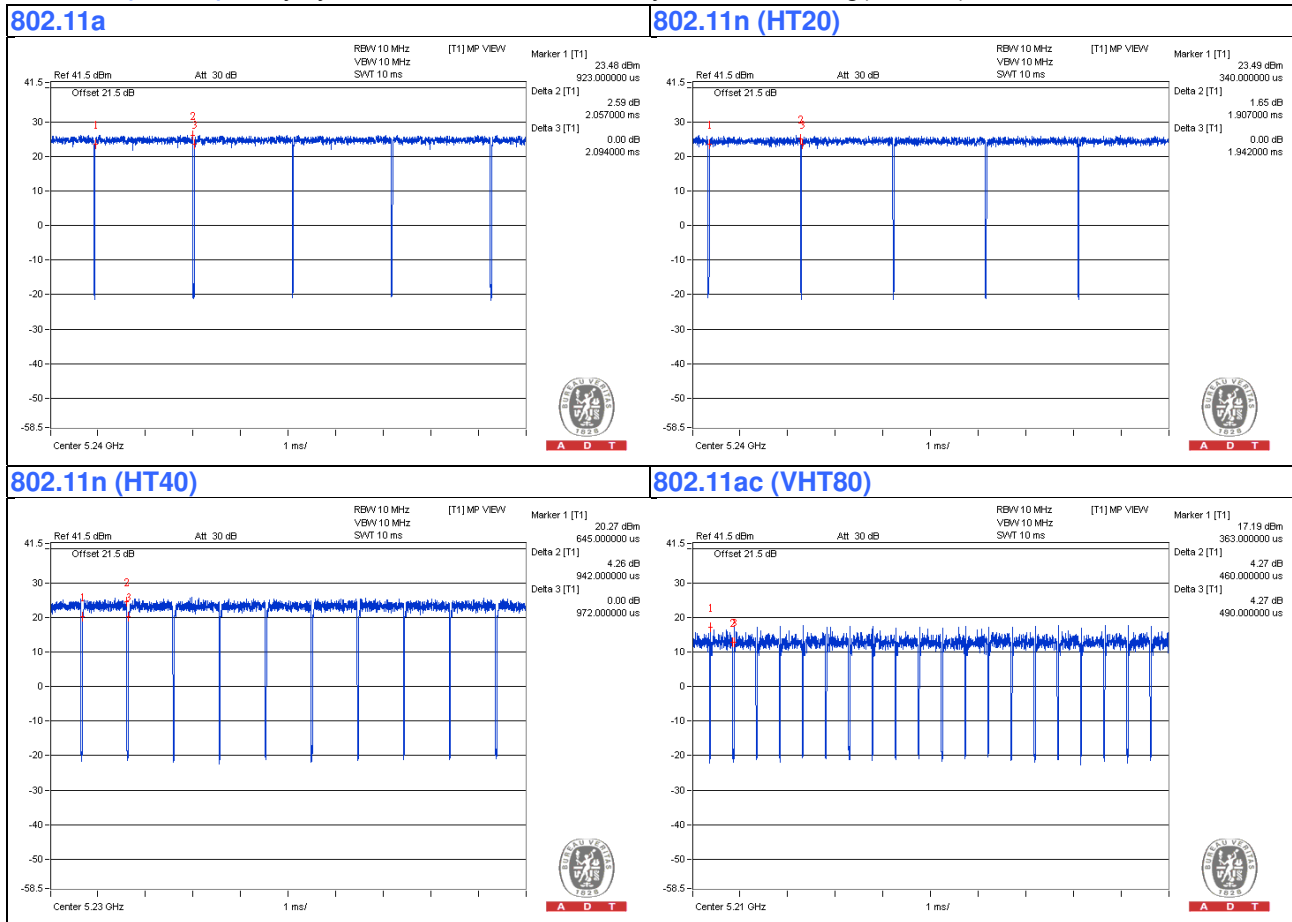

2TX

Duty cycle of test signal is > 98%, duty factor is not required

Duty cycle of test signal is < 98 %, duty factor is required

802.11a: Duty cycle = 2.06/2.095 = 0.983

802.11n (HT20): Duty cycle = 1.915/1.967 = 0.974, Duty factor = $10 * \log(1/0.974) = 0.12$

802.11n (HT40): Duty cycle = 0.939/0.969 = 0.969, Duty factor = $10 * \log(1/0.969) = 0.14$

802.11ac (VHT80): Duty cycle = 0.463/0.49 = 0.945, Duty factor = $10 * \log(1/0.945) = 0.25$

802.11a

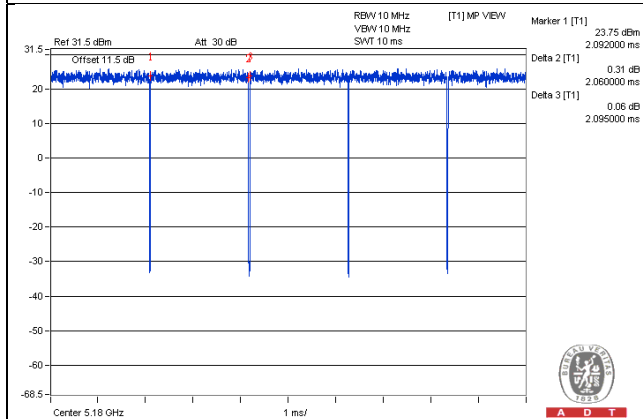

802.11n (HT20)

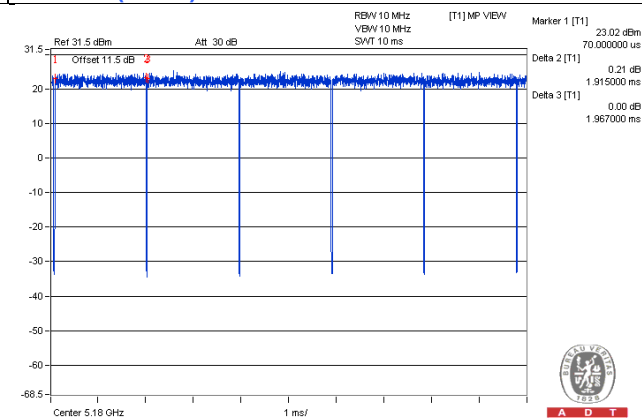

802.11n (HT40)

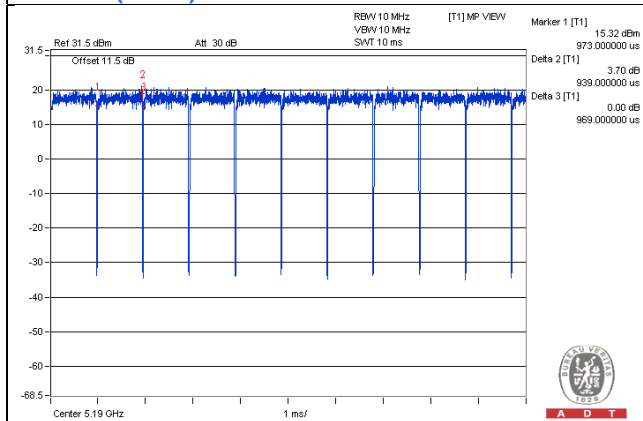

802.11ac (VHT80)

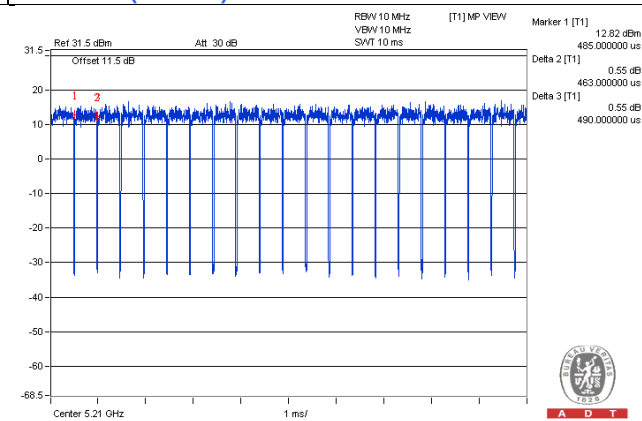

3TX

Duty cycle of test signal is > 98%, duty factor is not required

Duty cycle of test signal is < 98 %, duty factor is required

802.11a: Duty cycle = $2.063/2.093 = 0.986$

802.11n (HT20): Duty cycle = $1.915/1.965 = 0.975$, Duty factor = $10 * \log(1/0.975) = 0.11$

802.11n (HT40): Duty cycle = $0.942/0.992 = 0.95$, Duty factor = $10 * \log(1/0.95) = 0.22$

802.11ac (VHT80): Duty cycle = $0.458/0.543 = 0.843$, Duty factor = $10 * \log(1/0.843) = 0.74$

802.11a

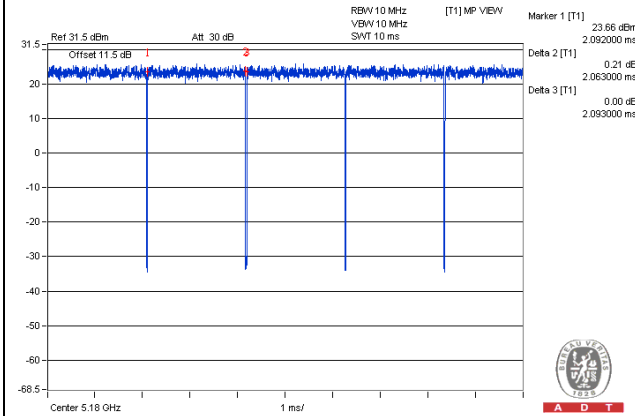

802.11n (HT20)

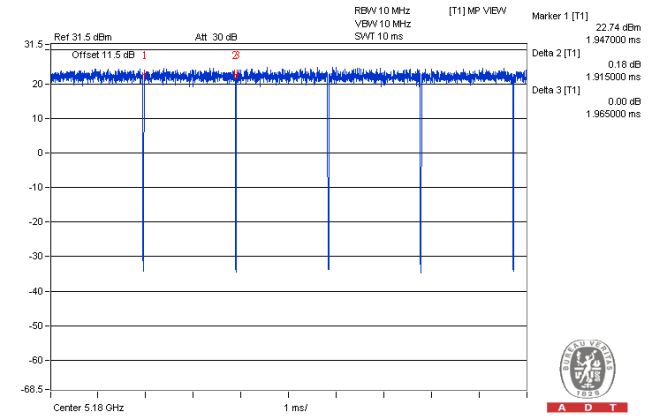

802.11n (HT40)

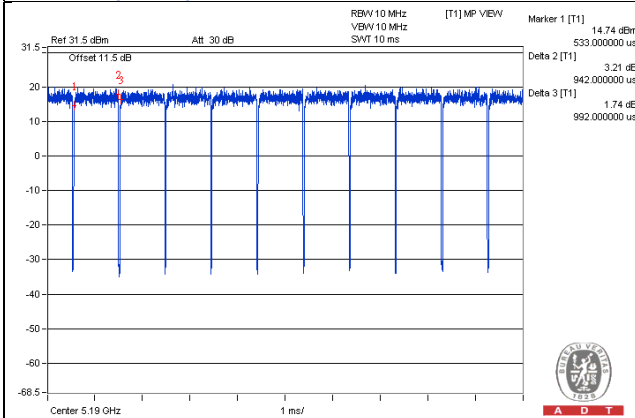

802.11ac (VHT80)

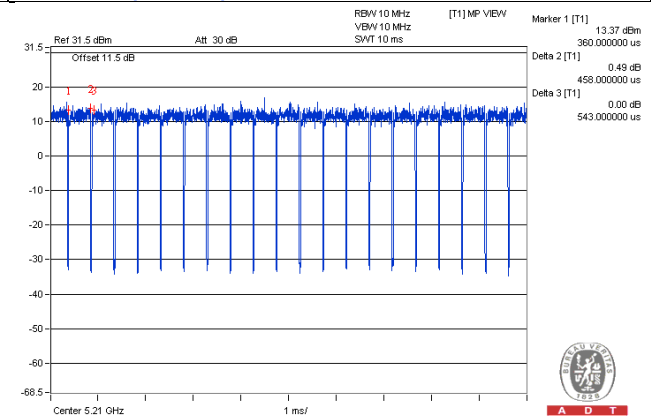

4TX

Duty cycle of test signal is > 98%, duty factor is not required

Duty cycle of test signal is < 98 %, duty factor is required

802.11a: Duty cycle = $2.065/2.115 = 0.976$, Duty factor = $10 * \log(1/0.976) = 0.10$

802.11n (HT20): Duty cycle = $1.92/1.95 = 0.985$

802.11n (HT40): Duty cycle = $0.942/0.99 = 0.952$, Duty factor = $10 * \log(1/0.952) = 0.22$

802.11ac (VHT80): Duty cycle = $0.453/0.49 = 0.924$, Duty factor = $10 * \log(1/0.924) = 0.34$

802.11a

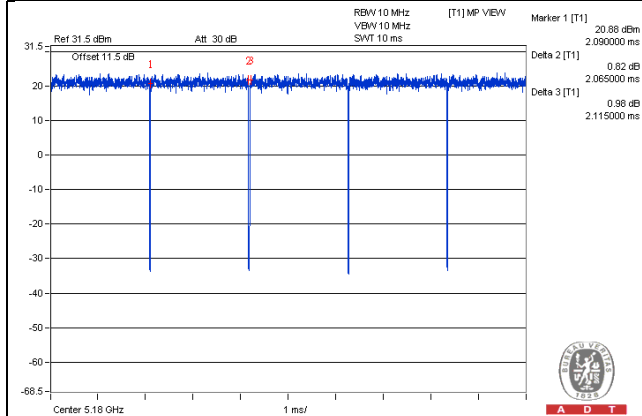

802.11n (HT20)

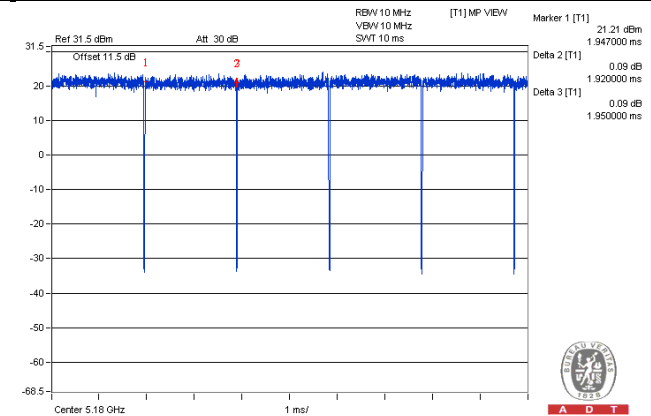

802.11n (HT40)

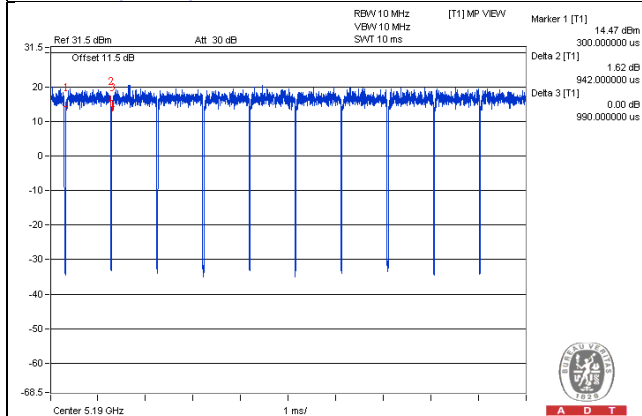

802.11ac (VHT80)

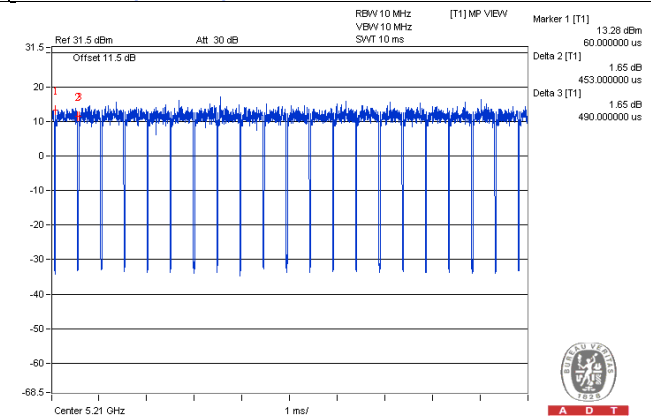

Radio 2:

1TX

Duty cycle of test signal is < 98 %, duty factor is required

802.11a: Duty cycle = 2.01/2.1 = 0.957, Duty factor = $10 * \log(1/0.957) = 0.19$

802.11n (HT20): Duty cycle = 2.01/2.10 = 0.957, Duty factor = $10 * \log(1/0.957) = 0.19$

802.11n (HT40): Duty cycle = 0.875/1.01 = 0.866, Duty factor = $10 * \log(1/0.866) = 0.62$

802.11ac (VHT80): Duty cycle = 0.401/0.513 = 0.782, Duty factor = $10 * \log(1/0.782) = 1.07$

802.11a

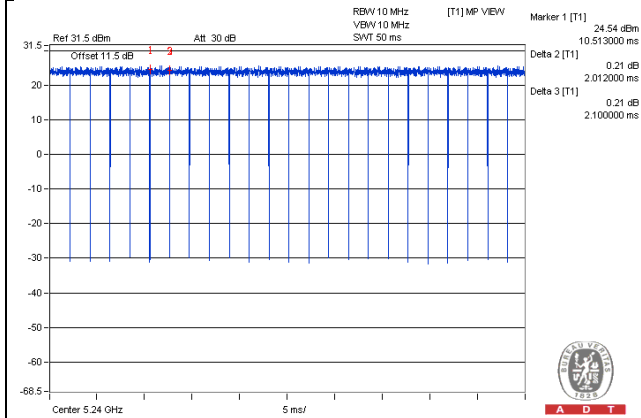

802.11n (HT20)

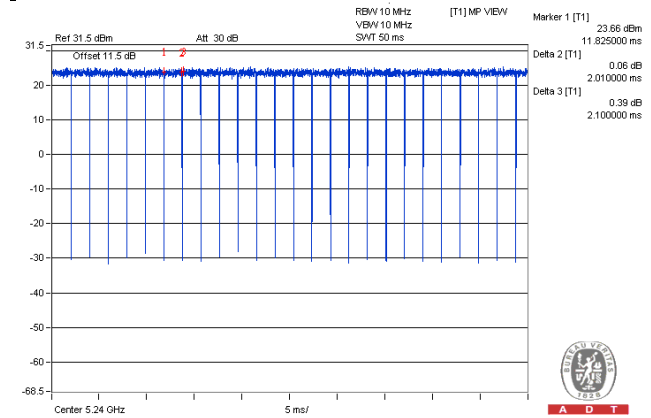

802.11n (HT40)

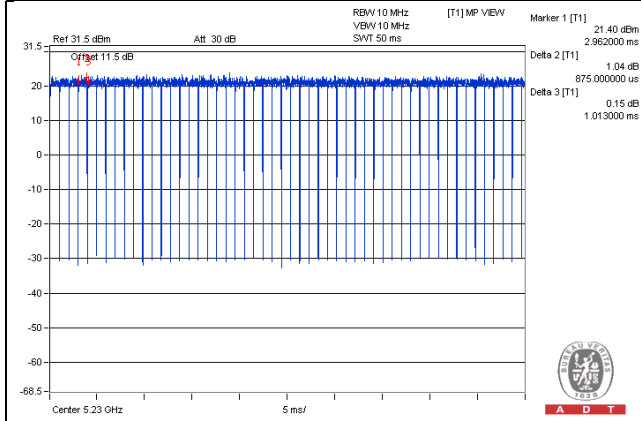

802.11ac (VHT80)

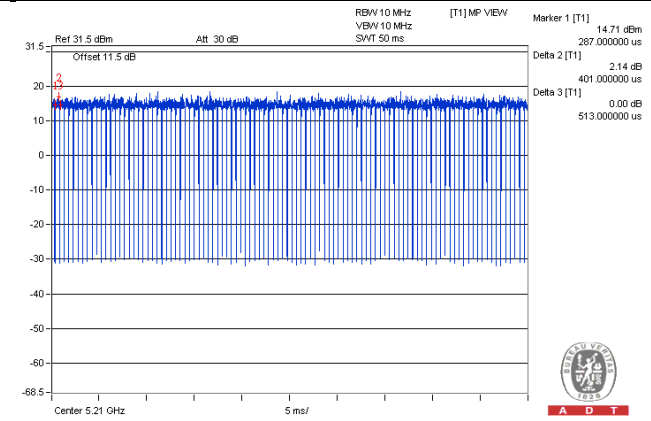

3.4 Description of Support Units

The EUT has been tested as an independent unit together with other necessary accessories or support units. The following support units or accessories were used to form a representative test configuration during the tests.

ID	Product	Brand	Model No.	Serial No.	FCC ID	Remarks
A.	Notebook	DELL	E5410	6RP2YM1	FCC DoC Approved	-
B.	USB 3.0 Flash Drive	HP	v250w	N/A	FCC DoC Approved	-
C.	Adapter	Channel Well Technology	2ABN036F US	N/A	N/A	Provided by client
D.	Load	N/A	N/A	N/A	N/A	-
E.	PoE	Microsemi	PD-9001GR/AT/AC	N/A	N/A	Provided by client

Note:

1. All power cords of the above support units are non-shielded (1.8m).
2. Items A acted as communication partners to transfer data.

ID	Descriptions	Qty.	Length (m)	Shielding (Yes/No)	Cores (Qty.)	Remarks
1.	RJ45 cable	1	10	N	0	-
2.	RJ45 cable	2	1.8	N	0	-
3.	DC cable	1	1.45	-	0	attached on adapter
4.	RJ45 cable	1	3	N	0	-

Note: The core(s) is(are) originally attached to the cable(s).

3.4.1 Configuration of System under Test

Test Mode A, C

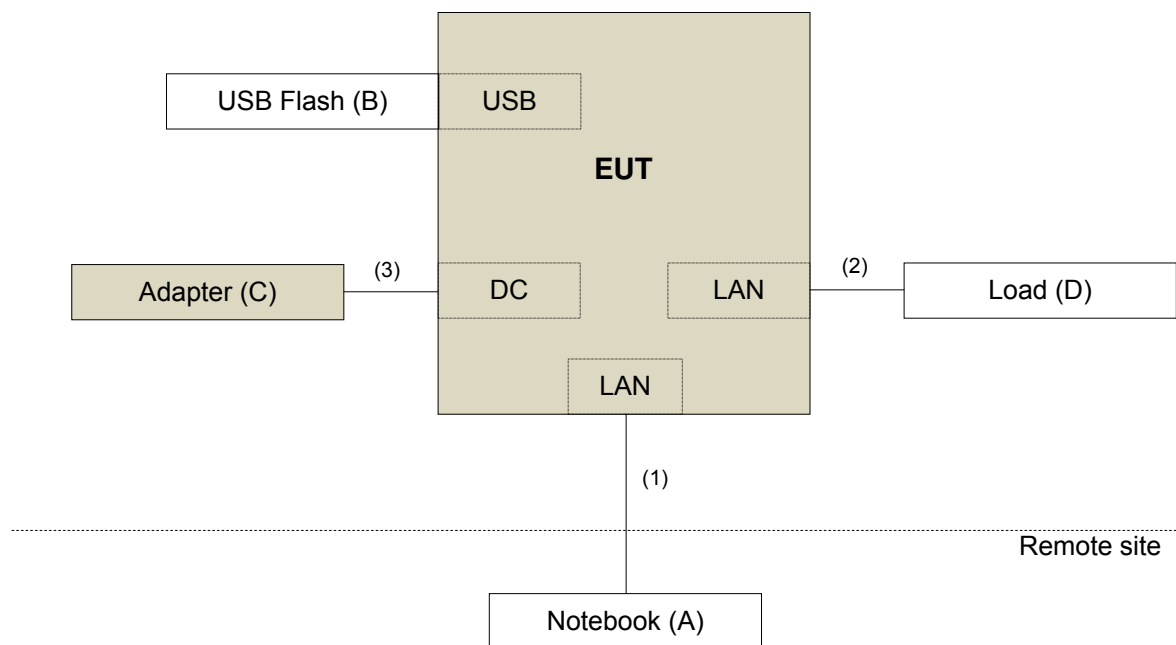

Test Mode B, D

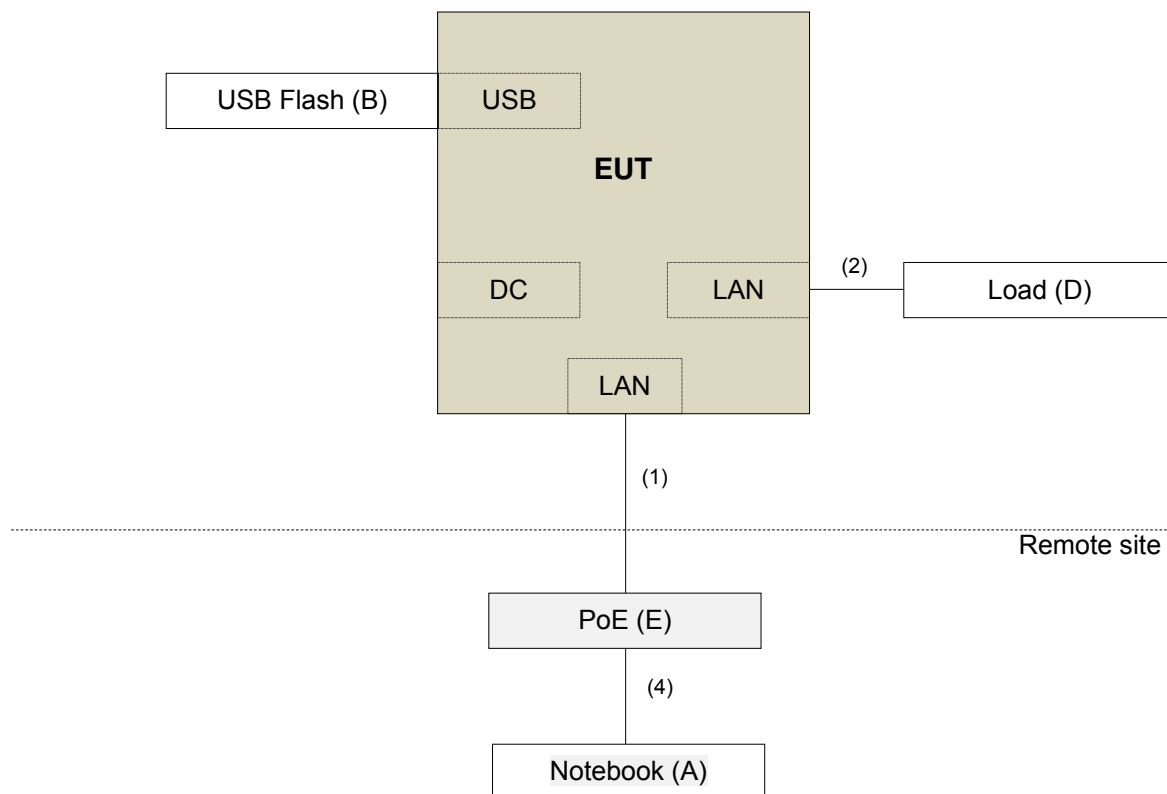

3.5 General Description of Applied Standards

The EUT is a RF Product. According to the specifications of the manufacturer, it must comply with the requirements of the following standards:

FCC Part 15, Subpart E (15.407)

789033 D02 General UNII Test Procedures New Rules v01r01

662911 D01 Multiple Transmitter Output v02r01

ANSI C63.10-2013

All test items have been performed and recorded as per the above standards.

NOTE: The EUT has been verified to comply with the requirements of FCC Part 15, Subpart B, Class B (DoC). The test report has been issued separately.

4 Test Types and Results

4.1 Radiated Emission and Bandedge Measurement

4.1.1 Limits of Radiated Emission and Bandedge Measurement

Radiated emissions which fall in the restricted bands must comply with the radiated emission limits specified as below table.

Frequencies (MHz)	Field Strength (microvolts/meter)	Measurement Distance (meters)
0.009 ~ 0.490	2400/F(kHz)	300
0.490 ~ 1.705	24000/F(kHz)	30
1.705 ~ 30.0	30	30
30 ~ 88	100	3
88 ~ 216	150	3
216 ~ 960	200	3
Above 960	500	3

NOTE:

1. The lower limit shall apply at the transition frequencies.
2. Emission level (dBuV/m) = 20 log Emission level (uV/m).
3. For frequencies above 1000MHz, the field strength limits are based on average detector, however, the peak field strength of any emission shall not exceed the maximum permitted average limits, specified above by more than 20dB under any condition of modulation.

LIMITS OF UNWANTED EMISSION OUT OF THE RESTRICTED BANDS

APPLICABLE TO	LIMIT	
789033 D02 General UNII Test Procedures New Rules v01	FIELD STRENGTH AT 3m	
	PK:74 (dBuV/m)	AV:54 (dBuV/m)
APPLICABLE TO	EIRP LIMIT	EQUIVALENT FIELD STRENGTH AT 3m
15.407(b)(1)	PK:-27 (dBm/MHz)	PK:68.2(dBuV/m)
15.407(b)(2)		
15.407(b)(3)		
15.407(b)(4)	PK:-27 (dBm/MHz) ^{*1} PK:-17 (dBm/MHz) ^{*2}	PK: 68.2(dBuV/m) ^{*1} PK:78.2 (dBuV/m) ^{*2}

NOTE: ^{*1} beyond 10MHz of the band edge ^{*2} within 10 MHz of band edge

The following formula is used to convert the equipment isotropic radiated power (eirp) to field strength:

$$E = \frac{1000000 \sqrt{30P}}{3} \mu\text{V/m, where P is the eirp (Watts).}$$

4.1.2 Test Instruments

Description & Manufacturer	Model No.	Serial No.	Date Of Calibration	Due Date Of Calibration
Test Receiver ROHDE & SCHWARZ	ESCI	100424	Oct. 12, 2015	Oct. 11, 2016
Spectrum Analyzer ROHDE & SCHWARZ	FSP40	100040	Jul. 08, 2015	Jul. 07, 2016
BILOG Antenna SCHWARZBECK	VULB9168	9168-155	Feb. 06, 2015	Feb. 05, 2016
HORN Antenna SCHWARZBECK	BBHA 9120D	9120D-1170	Feb. 05, 2015	Feb. 04, 2016
HORN Antenna SCHWARZBECK	BBHA 9170	BBHA9170241	Feb. 09, 2015	Feb. 08, 2016
Preamplifier Agilent	8449B	3008A01960	Aug. 09, 2015	Aug. 08, 2016
Preamplifier Agilent	8447D	2944A10631	Aug. 09, 2015	Aug. 08, 2016
RF signal cable HUBER+SUHNER	SUCOFLEX 104	Cable-CH4-02(295 012+309220)	Aug. 09, 2015	Aug. 08, 2016
RF signal cable HUBER+SUHNER	SUCOFLEX 104	Cable-CH4-03(250 724)	Aug. 09, 2015	Aug. 08, 2016
Software BV ADT	ADT_Radiated_ V7.6.15.9.4	NA	NA	NA
Antenna Tower inn-co GmbH	MA 4000	010303	NA	NA
Antenna Tower Controller BV ADT	AT100	AT93021703	NA	NA
Turn Table BV ADT	TT100	TT93021703	NA	NA
Turn Table Controller BV ADT	SC100.	SC93021703	NA	NA
26GHz ~ 40GHz Amplifier	EM26400	815221	Oct. 18, 2015	Oct. 17, 2016
High Speed Peak Power Meter	ML2495A	0824011	Jul. 09, 2015	Jul. 08, 2016
Power Sensor	MA2411B	0738171	Jul. 09, 2015	Jul. 08, 2016

Note: 1. The calibration interval of the above test instruments is 12 months and the calibrations are traceable to NML/ROC and NIST/USA.

2. The test was performed in HwaYa Chamber 4.

3. The horn antenna and preamplifier (model: 8449B) are used only for the measurement of emission frequency above 1GHz if tested.

4. The FCC Site Registration No. is 460141.

5. The IC Site Registration No. is IC7450F-4.

4.1.3 Test Procedures

- a. The EUT was placed on the top of a rotating table 0.8 meters (for below 1GHz) / 1.5 meters (for above 1GHz) above the ground at 3 meter chamber room for test. The table was rotated 360 degrees to determine the position of the highest radiation.
- b. The EUT was set 3 meters away from the interference-receiving antenna, which was mounted on the top of a variable-height antenna tower.
- c. The height of antenna is varied from one meter to four meters above the ground to determine the maximum value of the field strength. Both horizontal and vertical polarizations of the antenna are set to make the measurement.
- d. For each suspected emission, the EUT was arranged to its worst case and then the antenna was tuned to heights from 1 meter to 4 meters and the rotatable table was turned from 0 degrees to 360 degrees to find the maximum reading.
- e. The test-receiver system was set to quasi-peak detect function and specified bandwidth with maximum hold mode when the test frequency is below 1 GHz.
- f. The test-receiver system was set to peak and average detect function and specified bandwidth with maximum hold mode when the test frequency is above 1 GHz. If the peak reading value also meets average limit, measurement with the average detector is unnecessary.

Note:

1. The resolution bandwidth and video bandwidth of test receiver/spectrum analyzer is 120kHz for Quasi-peak detection (QP) at frequency below 1GHz.
2. The resolution bandwidth of test receiver/spectrum analyzer is 1 MHz and the video bandwidth is 3 MHz for Peak detection (PK) at frequency above 1GHz.
3. The resolution bandwidth of test receiver/spectrum analyzer is 1MHz and the video bandwidth is 3MHz for RMS Average (Duty cycle < 98%) for Average detection (AV) at frequency above 1GHz, then the measurement results was added to a correction factor ($10 \log(1/\text{duty cycle})$).
4. The resolution bandwidth of test receiver/spectrum analyzer is 1MHz and the video bandwidth is 10Hz (Duty cycle $\geq 98\%$) for Average detection (AV) at frequency above 1GHz.
5. All modes of operation were investigated and the worst-case emissions are reported.

4.1.4 Deviation from Test Standard

No deviation.

4.1.5 Test Set Up

<Frequency Range 30MHz ~ 1GHz>

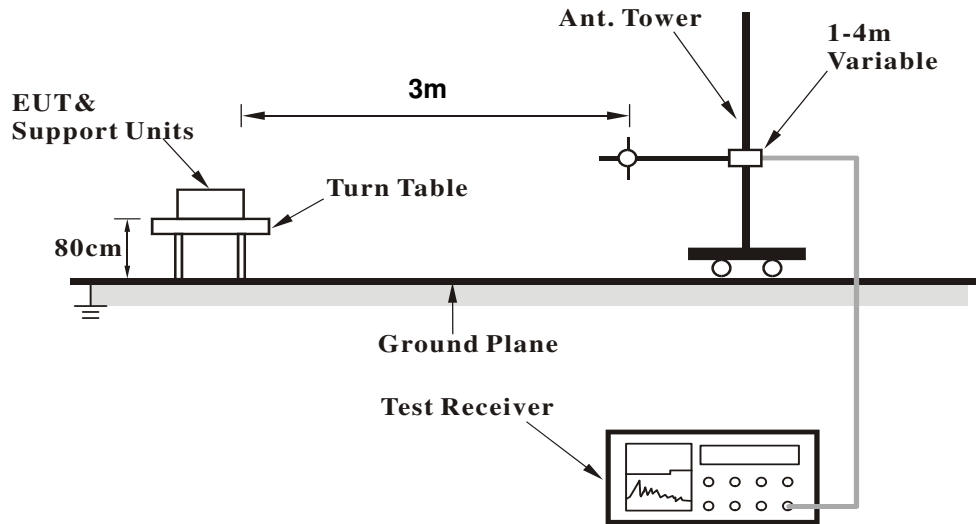

<Frequency Range above 1GHz>

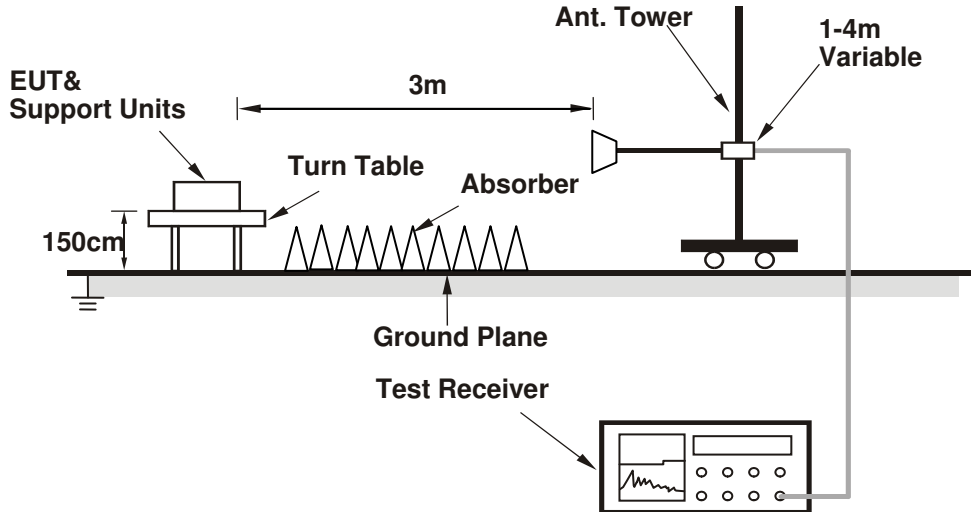

For the actual test configuration, please refer to the attached file (Test Setup Photo)

4.1.6 EUT Operating Conditions

- Placed the EUT on the testing table.
- Prepared notebook to act as communication partner and placed it outside of testing area.
- The communication partner connected with EUT via a RJ45 cable and ran a test program (provided by manufacturer) to enable EUT under transmission condition continuously at specific channel frequency.
- The communication partner sent data to EUT by command "PING".
- The necessary accessories enable the system in full functions.

4.1.7 Test Results

Above 1GHz data:

Test Mode B

1TX

802.11a

CHANNEL	TX Channel 36	DETECTOR FUNCTION	Peak (PK)
FREQUENCY RANGE	1GHz ~ 40GHz		Average (AV)

ANTENNA POLARITY & TEST DISTANCE: HORIZONTAL AT 3 M

NO.	FREQ. (MHz)	EMISSION LEVEL (dBuV/m)	LIMIT (dBuV/m)	MARGIN (dB)	ANTENNA HEIGHT (m)	TABLE ANGLE (Degree)	RAW VALUE (dBuV)	CORRECTION FACTOR (dB/m)
1	5150.00	62.9 PK	74.0	-11.1	1.82 H	51	57.90	5.00
2	5150.00	49.1 AV	54.0	-4.9	1.82 H	51	44.10	5.00
3	*5180.00	109.4 PK			1.80 H	49	70.30	39.10
4	*5180.00	99.6 AV			1.80 H	49	60.50	39.10
5	#10360.00	59.9 PK	74.0	-14.1	1.28 H	74	42.80	17.10
6	#10360.00	47.5 AV	54.0	-6.5	1.28 H	74	30.40	17.10

ANTENNA POLARITY & TEST DISTANCE: VERTICAL AT 3 M

NO.	FREQ. (MHz)	EMISSION LEVEL (dBuV/m)	LIMIT (dBuV/m)	MARGIN (dB)	ANTENNA HEIGHT (m)	TABLE ANGLE (Degree)	RAW VALUE (dBuV)	CORRECTION FACTOR (dB/m)
1	5150.00	66.0 PK	74.0	-8.0	1.00 V	13	61.00	5.00
2	5150.00	52.5 AV	54.0	-1.5	1.00 V	13	47.50	5.00
3	*5180.00	112.3 PK			1.01 V	27	73.20	39.10
4	*5180.00	102.6 AV			1.01 V	27	63.50	39.10
5	#10360.00	59.7 PK	74.0	-14.3	1.36 V	97	42.60	17.10
6	#10360.00	47.2 AV	54.0	-6.8	1.36 V	97	30.10	17.10

REMARKS:

1. Emission Level(dBuV/m) = Raw Value(dBuV) + Correction Factor(dB/m)
2. Correction Factor(dB/m) = Antenna Factor(dB/m) + Cable Factor(dB)
3. The other emission levels were very low against the limit.
4. Margin value = Emission Level – Limit value
5. " * ": Fundamental frequency.
6. " # ": The radiated frequency is out of the restricted band.

CHANNEL	TX Channel 40	DETECTOR FUNCTION	Peak (PK)
FREQUENCY RANGE	1GHz ~ 40GHz		Average (AV)

ANTENNA POLARITY & TEST DISTANCE: HORIZONTAL AT 3 M

NO.	FREQ. (MHz)	EMISSION LEVEL (dBuV/m)	LIMIT (dBuV/m)	MARGIN (dB)	ANTENNA HEIGHT (m)	TABLE ANGLE (Degree)	RAW VALUE (dBuV)	CORRECTION FACTOR (dB/m)
1	*5200.00	112.4 PK			1.14 H	49	73.20	39.20
2	*5200.00	102.4 AV			1.14 H	49	63.20	39.20
3	#10400.00	58.8 PK	74.0	-15.2	1.07 H	85	41.50	17.30
4	#10400.00	47.0 AV	54.0	-7.0	1.07 H	85	29.70	17.30

ANTENNA POLARITY & TEST DISTANCE: VERTICAL AT 3 M

NO.	FREQ. (MHz)	EMISSION LEVEL (dBuV/m)	LIMIT (dBuV/m)	MARGIN (dB)	ANTENNA HEIGHT (m)	TABLE ANGLE (Degree)	RAW VALUE (dBuV)	CORRECTION FACTOR (dB/m)
1	5150.00	66.3 PK	74.0	-7.7	1.09 V	14	61.30	5.00
2	5150.00	52.7 AV	54.0	-1.3	1.09 V	14	47.70	5.00
3	*5200.00	116.1 PK			1.09 V	30	76.90	39.20
4	*5200.00	105.2 AV			1.09 V	30	66.00	39.20
5	#10400.00	59.9 PK	74.0	-14.1	1.32 V	96	42.60	17.30
6	#10400.00	47.4 AV	54.0	-6.6	1.32 V	96	30.10	17.30

REMARKS:

1. Emission Level(dBuV/m) = Raw Value(dBuV) + Correction Factor(dB/m)
2. Correction Factor(dB/m) = Antenna Factor(dB/m) + Cable Factor(dB)
3. The other emission levels were very low against the limit.
4. Margin value = Emission Level – Limit value
5. " * ": Fundamental frequency.
6. " # ": The radiated frequency is out of the restricted band.



CHANNEL	TX Channel 48	DETECTOR FUNCTION	Peak (PK)
FREQUENCY RANGE	1GHz ~ 40GHz		Average (AV)

ANTENNA POLARITY & TEST DISTANCE: HORIZONTAL AT 3 M								
NO.	FREQ. (MHz)	EMISSION LEVEL (dBuV/m)	LIMIT (dBuV/m)	MARGIN (dB)	ANTENNA HEIGHT (m)	TABLE ANGLE (Degree)	RAW VALUE (dBuV)	CORRECTION FACTOR (dB/m)
1	*5240.00	114.4 PK			2.01 H	51	75.20	39.20
2	*5240.00	102.5 AV			2.01 H	51	63.30	39.20
3	5350.00	59.2 PK	74.0	-14.8	2.08 H	53	53.80	5.40
4	5350.00	46.1 AV	54.0	-7.9	2.08 H	53	40.70	5.40
5	#10480.00	58.8 PK	74.0	-15.2	1.08 H	55	41.50	17.30
6	#10480.00	47.0 AV	54.0	-7.0	1.08 H	55	29.70	17.30

ANTENNA POLARITY & TEST DISTANCE: VERTICAL AT 3 M								
NO.	FREQ. (MHz)	EMISSION LEVEL (dBuV/m)	LIMIT (dBuV/m)	MARGIN (dB)	ANTENNA HEIGHT (m)	TABLE ANGLE (Degree)	RAW VALUE (dBuV)	CORRECTION FACTOR (dB/m)
1	*5240.00	118.8 PK			1.14 V	360	79.60	39.20
2	*5240.00	107.2 AV			1.14 V	360	68.00	39.20
3	5350.00	61.4 PK	74.0	-12.6	1.60 V	15	56.00	5.40
4	5350.00	48.2 AV	54.0	-5.8	1.60 V	15	42.80	5.40
5	#10480.00	59.9 PK	74.0	-14.1	1.26 V	87	42.60	17.30
6	#10480.00	47.7 AV	54.0	-6.3	1.26 V	87	30.40	17.30

REMARKS:

1. Emission Level(dBuV/m) = Raw Value(dBuV) + Correction Factor(dB/m)
2. Correction Factor(dB/m) = Antenna Factor(dB/m) + Cable Factor(dB)
3. The other emission levels were very low against the limit.
4. Margin value = Emission Level – Limit value
5. " * ": Fundamental frequency.
6. " # ": The radiated frequency is out of the restricted band.

CHANNEL	TX Channel 149	DETECTOR FUNCTION	Peak (PK)
FREQUENCY RANGE	1GHz ~ 40GHz		Average (AV)

ANTENNA POLARITY & TEST DISTANCE: HORIZONTAL AT 3 M

NO.	FREQ. (MHz)	EMISSION LEVEL (dBuV/m)	LIMIT (dBuV/m)	MARGIN (dB)	ANTENNA HEIGHT (m)	TABLE ANGLE (Degree)	RAW VALUE (dBuV)	CORRECTION FACTOR (dB/m)
1	#5714.00	57.9 PK	74.0	-16.1	1.32 H	302	51.90	6.00
2	#5714.00	45.0 AV	54.0	-9.0	1.32 H	302	39.00	6.00
3	#5722.00	66.6 PK	78.2	-11.6	1.31 H	310	60.50	6.10
4	#5725.00	59.7 PK	78.2	-18.5	1.32 H	310	53.60	6.10
5	*5745.00	104.3 PK			1.29 H	300	64.00	40.30
6	*5745.00	93.9 AV			1.29 H	300	53.60	40.30
7	11490.00	58.6 PK	74.0	-15.4	1.07 H	85	41.00	17.60
8	11490.00	46.3 AV	54.0	-7.7	1.07 H	85	28.70	17.60

ANTENNA POLARITY & TEST DISTANCE: VERTICAL AT 3 M

NO.	FREQ. (MHz)	EMISSION LEVEL (dBuV/m)	LIMIT (dBuV/m)	MARGIN (dB)	ANTENNA HEIGHT (m)	TABLE ANGLE (Degree)	RAW VALUE (dBuV)	CORRECTION FACTOR (dB/m)
1	#5714.00	59.4 PK	74.0	-14.6	1.12 V	38	53.40	6.00
2	#5714.00	46.5 AV	54.0	-7.5	1.12 V	38	40.50	6.00
3	#5722.00	76.9 PK	78.2	-1.3	1.10 V	37	70.80	6.10
4	#5725.00	65.1 PK	78.2	-13.1	1.13 V	42	59.00	6.10
5	*5745.00	105.4 PK			1.10 V	36	65.10	40.30
6	*5745.00	95.3 AV			1.10 V	36	55.00	40.30
7	11490.00	59.5 PK	74.0	-14.5	1.25 V	89	41.90	17.60
8	11490.00	46.0 AV	54.0	-8.0	1.25 V	89	28.40	17.60

REMARKS:

1. Emission Level(dBuV/m) = Raw Value(dBuV) + Correction Factor(dB/m)
2. Correction Factor(dB/m) = Antenna Factor(dB/m) + Cable Factor(dB)
3. The other emission levels were very low against the limit.
4. Margin value = Emission Level – Limit value
5. " * ": Fundamental frequency.
6. " # ": The radiated frequency is out of the restricted band.

CHANNEL	TX Channel 157	DETECTOR FUNCTION	Peak (PK)
FREQUENCY RANGE	1GHz ~ 40GHz		Average (AV)

ANTENNA POLARITY & TEST DISTANCE: HORIZONTAL AT 3 M

NO.	FREQ. (MHz)	EMISSION LEVEL (dBuV/m)	LIMIT (dBuV/m)	MARGIN (dB)	ANTENNA HEIGHT (m)	TABLE ANGLE (Degree)	RAW VALUE (dBuV)	CORRECTION FACTOR (dB/m)
1	#5714.00	60.7 PK	74.0	-13.3	1.82 H	56	54.70	6.00
2	#5714.00	46.9 AV	54.0	-7.1	1.82 H	56	40.90	6.00
3	#5722.00	65.3 PK	78.2	-12.9	1.82 H	56	59.20	6.10
4	*5785.00	112.8 PK			1.80 H	53	72.50	40.30
5	*5785.00	101.2 AV			1.80 H	53	60.90	40.30
6	11570.00	59.0 PK	74.0	-15.0	1.36 H	98	41.50	17.50
7	11570.00	46.0 AV	54.0	-8.0	1.36 H	98	28.50	17.50

ANTENNA POLARITY & TEST DISTANCE: VERTICAL AT 3 M

NO.	FREQ. (MHz)	EMISSION LEVEL (dBuV/m)	LIMIT (dBuV/m)	MARGIN (dB)	ANTENNA HEIGHT (m)	TABLE ANGLE (Degree)	RAW VALUE (dBuV)	CORRECTION FACTOR (dB/m)
1	#5714.00	72.5 PK	74.0	-1.5	2.03 V	322	66.50	6.00
2	#5714.00	51.1 AV	54.0	-2.9	2.03 V	322	45.10	6.00
3	#5722.00	76.8 PK	78.2	-1.4	2.04 V	322	70.70	6.10
4	*5785.00	116.3 PK			2.21 V	326	76.00	40.30
5	*5785.00	104.3 AV			2.21 V	326	64.00	40.30
6	11570.00	60.1 PK	74.0	-13.9	1.32 V	64	42.60	17.50
7	11570.00	47.6 AV	54.0	-6.4	1.32 V	64	30.10	17.50

REMARKS:

1. Emission Level(dBuV/m) = Raw Value(dBuV) + Correction Factor(dB/m)
2. Correction Factor(dB/m) = Antenna Factor(dB/m) + Cable Factor(dB)
3. The other emission levels were very low against the limit.
4. Margin value = Emission Level – Limit value
5. " * ": Fundamental frequency.

CHANNEL	TX Channel 165	DETECTOR FUNCTION	Peak (PK)
FREQUENCY RANGE	1GHz ~ 40GHz		Average (AV)

ANTENNA POLARITY & TEST DISTANCE: HORIZONTAL AT 3 M

NO.	FREQ. (MHz)	EMISSION LEVEL (dBuV/m)	LIMIT (dBuV/m)	MARGIN (dB)	ANTENNA HEIGHT (m)	TABLE ANGLE (Degree)	RAW VALUE (dBuV)	CORRECTION FACTOR (dB/m)
1	*5825.00	107.5 PK			1.02 H	309	67.10	40.40
2	*5825.00	97.6 AV			1.02 H	309	57.20	40.40
3	#5850.00	59.6 PK	78.2	-18.6	1.10 H	312	53.20	6.40
4	#5853.00	71.6 PK	78.2	-6.6	1.06 H	309	65.20	6.40
5	#5861.00	66.0 PK	74.0	-8.0	1.06 H	310	59.60	6.40
6	#5861.00	47.7 AV	54.0	-6.3	1.06 H	310	41.30	6.40
7	11650.00	58.8 PK	74.0	-15.2	1.08 H	54	41.50	17.30
8	11650.00	46.0 AV	54.0	-8.0	1.08 H	54	28.70	17.30

ANTENNA POLARITY & TEST DISTANCE: VERTICAL AT 3 M

NO.	FREQ. (MHz)	EMISSION LEVEL (dBuV/m)	LIMIT (dBuV/m)	MARGIN (dB)	ANTENNA HEIGHT (m)	TABLE ANGLE (Degree)	RAW VALUE (dBuV)	CORRECTION FACTOR (dB/m)
1	*5825.00	111.5 PK			2.15 V	328	71.10	40.40
2	*5825.00	102.0 AV			2.15 V	328	61.60	40.40
3	#5850.00	65.1 PK	78.2	-13.1	2.30 V	334	58.70	6.40
4	#5853.00	76.8 PK	78.2	-1.4	2.25 V	328	70.40	6.40
5	#5861.00	72.5 PK	74.0	-1.5	2.25 V	328	66.10	6.40
6	#5861.00	53.3 AV	54.0	-0.7	2.25 V	328	46.90	6.40
7	11650.00	58.9 PK	74.0	-15.1	1.07 V	41	41.60	17.30
8	11650.00	47.0 AV	54.0	-7.0	1.07 V	41	29.70	17.30

REMARKS:

1. Emission Level(dBuV/m) = Raw Value(dBuV) + Correction Factor(dB/m)
2. Correction Factor(dB/m) = Antenna Factor(dB/m) + Cable Factor(dB)
3. The other emission levels were very low against the limit.
4. Margin value = Emission Level – Limit value
5. " * ": Fundamental frequency.
6. " # ": The radiated frequency is out of the restricted band.

802.11n (HT20)

CHANNEL	TX Channel 36	DETECTOR FUNCTION	Peak (PK)
FREQUENCY RANGE	1GHz ~ 40GHz		Average (AV)

ANTENNA POLARITY & TEST DISTANCE: HORIZONTAL AT 3 M								
NO.	FREQ. (MHz)	EMISSION LEVEL (dBuV/m)	LIMIT (dBuV/m)	MARGIN (dB)	ANTENNA HEIGHT (m)	TABLE ANGLE (Degree)	RAW VALUE (dBuV)	CORRECTION FACTOR (dB/m)
1	5150.00	64.0 PK	74.0	-10.0	1.01 H	49	59.00	5.00
2	5150.00	49.6 AV	54.0	-4.4	1.01 H	49	44.60	5.00
3	*5180.00	109.4 PK			1.00 H	48	70.30	39.10
4	*5180.00	98.8 AV			1.00 H	48	59.70	39.10
5	#10360.00	57.9 PK	74.0	-16.1	1.08 H	54	40.80	17.10
6	#10360.00	46.1 AV	54.0	-7.9	1.08 H	54	29.00	17.10

ANTENNA POLARITY & TEST DISTANCE: VERTICAL AT 3 M								
NO.	FREQ. (MHz)	EMISSION LEVEL (dBuV/m)	LIMIT (dBuV/m)	MARGIN (dB)	ANTENNA HEIGHT (m)	TABLE ANGLE (Degree)	RAW VALUE (dBuV)	CORRECTION FACTOR (dB/m)
1	5150.00	67.5 PK	74.0	-6.5	1.37 V	353	62.50	5.00
2	5150.00	52.9 AV	54.0	-1.1	1.37 V	353	47.90	5.00
3	*5180.00	112.8 PK			1.38 V	356	73.70	39.10
4	*5180.00	103.0 AV			1.38 V	356	63.90	39.10
5	#10360.00	58.9 PK	74.0	-15.1	1.23 V	96	41.80	17.10
6	#10360.00	47.2 AV	54.0	-6.8	1.23 V	96	30.10	17.10

REMARKS:

1. Emission Level(dBuV/m) = Raw Value(dBuV) + Correction Factor(dB/m)
2. Correction Factor(dB/m) = Antenna Factor(dB/m) + Cable Factor(dB)
3. The other emission levels were very low against the limit.
4. Margin value = Emission Level – Limit value
5. " * ": Fundamental frequency.
6. " # ": The radiated frequency is out of the restricted band.

CHANNEL	TX Channel 40	DETECTOR FUNCTION	Peak (PK)
FREQUENCY RANGE	1GHz ~ 40GHz		Average (AV)

ANTENNA POLARITY & TEST DISTANCE: HORIZONTAL AT 3 M

NO.	FREQ. (MHz)	EMISSION LEVEL (dBuV/m)	LIMIT (dBuV/m)	MARGIN (dB)	ANTENNA HEIGHT (m)	TABLE ANGLE (Degree)	RAW VALUE (dBuV)	CORRECTION FACTOR (dB/m)
1	*5200.00	111.9 PK			1.13 H	49	72.70	39.20
2	*5200.00	101.6 AV			1.13 H	49	62.40	39.20
3	#10400.00	57.9 PK	74.0	-16.1	1.25 H	87	40.60	17.30
4	#10400.00	46.0 AV	54.0	-8.0	1.25 H	87	28.70	17.30

ANTENNA POLARITY & TEST DISTANCE: VERTICAL AT 3 M

NO.	FREQ. (MHz)	EMISSION LEVEL (dBuV/m)	LIMIT (dBuV/m)	MARGIN (dB)	ANTENNA HEIGHT (m)	TABLE ANGLE (Degree)	RAW VALUE (dBuV)	CORRECTION FACTOR (dB/m)
1	5150.00	66.1 PK	74.0	-7.9	1.10 V	14	61.10	5.00
2	5150.00	52.6 AV	54.0	-1.4	1.10 V	14	47.60	5.00
3	*5200.00	116.1 PK			1.06 V	14	76.90	39.20
4	*5200.00	105.4 AV			1.06 V	14	66.20	39.20
5	#10400.00	59.9 PK	74.0	-14.1	1.08 V	74	42.60	17.30
6	#10400.00	47.3 AV	54.0	-6.7	1.08 V	74	30.00	17.30

REMARKS:

1. Emission Level(dBuV/m) = Raw Value(dBuV) + Correction Factor(dB/m)
2. Correction Factor(dB/m) = Antenna Factor(dB/m) + Cable Factor(dB)
3. The other emission levels were very low against the limit.
4. Margin value = Emission Level – Limit value
5. " * ": Fundamental frequency.
6. " # ": The radiated frequency is out of the restricted band.

CHANNEL	TX Channel 48	DETECTOR FUNCTION	Peak (PK)
FREQUENCY RANGE	1GHz ~ 40GHz		Average (AV)

ANTENNA POLARITY & TEST DISTANCE: HORIZONTAL AT 3 M

NO.	FREQ. (MHz)	EMISSION LEVEL (dBuV/m)	LIMIT (dBuV/m)	MARGIN (dB)	ANTENNA HEIGHT (m)	TABLE ANGLE (Degree)	RAW VALUE (dBuV)	CORRECTION FACTOR (dB/m)
1	*5240.00	114.0 PK			2.38 H	50	74.80	39.20
2	*5240.00	102.6 AV			2.38 H	50	63.40	39.20
3	5350.00	56.6 PK	74.0	-17.4	2.41 H	60	51.20	5.40
4	5350.00	47.0 AV	54.0	-7.0	2.41 H	60	41.60	5.40
5	#10480.00	58.8 PK	74.0	-15.2	1.36 H	97	41.50	17.30
6	#10480.00	46.0 AV	54.0	-8.0	1.36 H	97	28.70	17.30

ANTENNA POLARITY & TEST DISTANCE: VERTICAL AT 3 M

NO.	FREQ. (MHz)	EMISSION LEVEL (dBuV/m)	LIMIT (dBuV/m)	MARGIN (dB)	ANTENNA HEIGHT (m)	TABLE ANGLE (Degree)	RAW VALUE (dBuV)	CORRECTION FACTOR (dB/m)
1	*5240.00	117.5 PK			2.10 V	352	78.30	39.20
2	*5240.00	105.5 AV			2.10 V	352	66.30	39.20
3	5350.00	64.7 PK	74.0	-9.3	2.09 V	359	59.30	5.40
4	5350.00	49.1 AV	54.0	-4.9	2.09 V	359	43.70	5.40
5	#10480.00	59.9 PK	74.0	-14.1	1.32 V	97	42.60	17.30
6	#10480.00	48.0 AV	54.0	-6.0	1.32 V	97	30.70	17.30

REMARKS:

1. Emission Level(dBuV/m) = Raw Value(dBuV) + Correction Factor(dB/m)
2. Correction Factor(dB/m) = Antenna Factor(dB/m) + Cable Factor(dB)
3. The other emission levels were very low against the limit.
4. Margin value = Emission Level – Limit value
5. " * ": Fundamental frequency.
6. " # ": The radiated frequency is out of the restricted band.

CHANNEL	TX Channel 149	DETECTOR FUNCTION	Peak (PK)
FREQUENCY RANGE	1GHz ~ 40GHz		Average (AV)

ANTENNA POLARITY & TEST DISTANCE: HORIZONTAL AT 3 M

NO.	FREQ. (MHz)	EMISSION LEVEL (dBuV/m)	LIMIT (dBuV/m)	MARGIN (dB)	ANTENNA HEIGHT (m)	TABLE ANGLE (Degree)	RAW VALUE (dBuV)	CORRECTION FACTOR (dB/m)
1	#5714.00	57.6 PK	74.0	-16.4	2.08 H	300	51.60	6.00
2	#5714.00	45.0 AV	54.0	-9.0	2.08 H	300	39.00	6.00
3	#5722.00	70.6 PK	78.2	-7.6	2.08 H	300	64.50	6.10
4	#5725.00	59.7 PK	78.2	-18.5	2.08 H	301	53.60	6.10
5	*5745.00	70.1 PK			2.04 H	97	63.80	6.30
6	*5745.00	59.2 AV			2.04 H	97	52.90	6.30
7	11490.00	59.2 PK	74.0	-14.8	1.25 H	96	41.60	17.60
8	11490.00	45.4 AV	54.0	-8.6	1.25 H	96	27.80	17.60

ANTENNA POLARITY & TEST DISTANCE: VERTICAL AT 3 M

NO.	FREQ. (MHz)	EMISSION LEVEL (dBuV/m)	LIMIT (dBuV/m)	MARGIN (dB)	ANTENNA HEIGHT (m)	TABLE ANGLE (Degree)	RAW VALUE (dBuV)	CORRECTION FACTOR (dB/m)
1	#5714.00	61.8 PK	74.0	-12.2	2.45 V	330	55.80	6.00
2	#5714.00	46.5 AV	54.0	-7.5	2.45 V	330	40.50	6.00
3	#5722.00	76.7 PK	78.2	-1.5	2.41 V	326	70.60	6.10
4	#5725.00	65.7 PK	78.2	-12.5	2.45 V	315	59.60	6.10
5	*5745.00	74.5 PK			2.14 V	0	68.20	6.30
6	*5745.00	63.8 AV			2.14 V	0	57.50	6.30
7	11490.00	59.2 PK	74.0	-14.8	1.25 V	96	41.60	17.60
8	11490.00	45.4 AV	54.0	-8.6	1.25 V	96	27.80	17.60

REMARKS:

1. Emission Level(dBuV/m) = Raw Value(dBuV) + Correction Factor(dB/m)
2. Correction Factor(dB/m) = Antenna Factor(dB/m) + Cable Factor(dB)
3. The other emission levels were very low against the limit.
4. Margin value = Emission Level – Limit value
5. " * ": Fundamental frequency.
6. " # ": The radiated frequency is out of the restricted band.

CHANNEL	TX Channel 157	DETECTOR FUNCTION	Peak (PK)
FREQUENCY RANGE	1GHz ~ 40GHz		Average (AV)

ANTENNA POLARITY & TEST DISTANCE: HORIZONTAL AT 3 M

NO.	FREQ. (MHz)	EMISSION LEVEL (dBuV/m)	LIMIT (dBuV/m)	MARGIN (dB)	ANTENNA HEIGHT (m)	TABLE ANGLE (Degree)	RAW VALUE (dBuV)	CORRECTION FACTOR (dB/m)
1	#5714.00	69.4 PK	74.0	-4.6	2.06 H	306	63.40	6.00
2	#5714.00	50.9 AV	54.0	-3.1	2.06 H	306	44.90	6.00
3	#5722.00	73.1 PK	78.2	-5.1	2.08 H	312	67.00	6.10
4	#5725.00	59.7 PK	78.2	-18.5	2.18 H	316	53.60	6.10
5	*5785.00	112.1 PK			2.08 H	310	71.80	40.30
6	*5785.00	99.8 AV			2.08 H	310	59.50	40.30
7	11570.00	59.0 PK	74.0	-15.0	1.32 H	64	41.50	17.50
8	11570.00	46.2 AV	54.0	-7.8	1.32 H	64	28.70	17.50

ANTENNA POLARITY & TEST DISTANCE: VERTICAL AT 3 M

NO.	FREQ. (MHz)	EMISSION LEVEL (dBuV/m)	LIMIT (dBuV/m)	MARGIN (dB)	ANTENNA HEIGHT (m)	TABLE ANGLE (Degree)	RAW VALUE (dBuV)	CORRECTION FACTOR (dB/m)
1	#5714.00	72.0 PK	74.0	-2.0	1.12 V	41	66.00	6.00
2	#5714.00	50.7 AV	54.0	-3.3	1.12 V	41	44.70	6.00
3	#5722.00	76.9 PK	78.2	-1.3	1.11 V	39	70.80	6.10
4	#5725.00	64.9 PK	78.2	-13.3	1.16 V	42	58.80	6.10
5	*5785.00	116.4 PK			2.37 V	326	76.10	40.30
6	*5785.00	104.2 AV			2.37 V	326	63.90	40.30
7	11570.00	60.1 PK	74.0	-13.9	1.02 V	96	42.60	17.50
8	11570.00	45.9 AV	54.0	-8.1	1.02 V	96	28.40	17.50

REMARKS:

1. Emission Level(dBuV/m) = Raw Value(dBuV) + Correction Factor(dB/m)
2. Correction Factor(dB/m) = Antenna Factor(dB/m) + Cable Factor(dB)
3. The other emission levels were very low against the limit.
4. Margin value = Emission Level – Limit value
5. " * ": Fundamental frequency.



CHANNEL	TX Channel 165	DETECTOR FUNCTION	Peak (PK)
FREQUENCY RANGE	1GHz ~ 40GHz		Average (AV)

ANTENNA POLARITY & TEST DISTANCE: HORIZONTAL AT 3 M

NO.	FREQ. (MHz)	EMISSION LEVEL (dBuV/m)	LIMIT (dBuV/m)	MARGIN (dB)	ANTENNA HEIGHT (m)	TABLE ANGLE (Degree)	RAW VALUE (dBuV)	CORRECTION FACTOR (dB/m)
1	*5825.00	106.1 PK			2.09 H	296	65.70	40.40
2	*5825.00	95.7 AV			2.09 H	296	55.30	40.40
3	#5850.00	59.7 PK	78.2	-18.5	1.98 H	305	53.30	6.40
4	#5853.00	68.2 PK	78.2	-10.0	2.14 H	301	61.80	6.40
5	#5861.00	65.1 PK	74.0	-8.9	2.11 H	300	58.70	6.40
6	#5861.00	46.3 AV	54.0	-7.7	2.11 H	300	39.90	6.40
7	11650.00	58.9 PK	74.0	-15.1	1.25 H	87	41.60	17.30
8	11650.00	46.0 AV	54.0	-8.0	1.25 H	87	28.70	17.30

ANTENNA POLARITY & TEST DISTANCE: VERTICAL AT 3 M

NO.	FREQ. (MHz)	EMISSION LEVEL (dBuV/m)	LIMIT (dBuV/m)	MARGIN (dB)	ANTENNA HEIGHT (m)	TABLE ANGLE (Degree)	RAW VALUE (dBuV)	CORRECTION FACTOR (dB/m)
1	*5825.00	111.4 PK			2.20 V	330	71.00	40.40
2	*5825.00	100.8 AV			2.20 V	330	60.40	40.40
3	#5850.00	64.9 PK	78.2	-13.3	2.07 V	324	58.50	6.40
4	#5853.00	73.0 PK	78.2	-5.2	2.21 V	335	66.60	6.40
5	#5861.00	72.3 PK	74.0	-1.7	2.19 V	331	65.90	6.40
6	#5861.00	49.7 AV	54.0	-4.3	2.19 V	331	43.30	6.40
7	11650.00	59.9 PK	74.0	-14.1	1.28 V	54	42.60	17.30
8	11650.00	47.4 AV	54.0	-6.6	1.28 V	54	30.10	17.30

REMARKS:

1. Emission Level(dBuV/m) = Raw Value(dBuV) + Correction Factor(dB/m)
2. Correction Factor(dB/m) = Antenna Factor(dB/m) + Cable Factor(dB)
3. The other emission levels were very low against the limit.
4. Margin value = Emission Level – Limit value
5. " * ": Fundamental frequency.
6. " # ": The radiated frequency is out of the restricted band.

802.11n (HT40)

CHANNEL	TX Channel 38	DETECTOR FUNCTION	Peak (PK)
FREQUENCY RANGE	1GHz ~ 40GHz		Average (AV)

ANTENNA POLARITY & TEST DISTANCE: HORIZONTAL AT 3 M								
NO.	FREQ. (MHz)	EMISSION LEVEL (dBuV/m)	LIMIT (dBuV/m)	MARGIN (dB)	ANTENNA HEIGHT (m)	TABLE ANGLE (Degree)	RAW VALUE (dBuV)	CORRECTION FACTOR (dB/m)
1	5150.00	63.3 PK	74.0	-10.7	1.15 H	53	58.30	5.00
2	5150.00	49.5 AV	54.0	-4.5	1.15 H	53	44.50	5.00
3	*5190.00	103.4 PK			1.13 H	50	64.30	39.10
4	*5190.00	93.1 AV			1.13 H	50	54.00	39.10
5	#10380.00	58.8 PK	74.0	-15.2	1.25 H	87	41.60	17.20
6	#10380.00	45.9 AV	54.0	-8.1	1.25 H	87	28.70	17.20

ANTENNA POLARITY & TEST DISTANCE: VERTICAL AT 3 M								
NO.	FREQ. (MHz)	EMISSION LEVEL (dBuV/m)	LIMIT (dBuV/m)	MARGIN (dB)	ANTENNA HEIGHT (m)	TABLE ANGLE (Degree)	RAW VALUE (dBuV)	CORRECTION FACTOR (dB/m)
1	5150.00	72.6 PK	74.0	-1.4	1.39 V	0	67.60	5.00
2	5150.00	52.9 AV	54.0	-1.1	1.39 V	0	47.90	5.00
3	*5190.00	105.8 PK			1.57 V	2	66.70	39.10
4	*5190.00	95.7 AV			1.57 V	2	56.60	39.10
5	#10380.00	59.9 PK	74.0	-14.1	1.05 V	87	42.70	17.20
6	#10380.00	47.0 AV	54.0	-7.0	1.05 V	87	29.80	17.20

REMARKS:

1. Emission Level(dBuV/m) = Raw Value(dBuV) + Correction Factor(dB/m)
2. Correction Factor(dB/m) = Antenna Factor(dB/m) + Cable Factor(dB)
3. The other emission levels were very low against the limit.
4. Margin value = Emission Level – Limit value
5. " * ": Fundamental frequency.
6. " # ": The radiated frequency is out of the restricted band.

CHANNEL	TX Channel 46	DETECTOR FUNCTION	Peak (PK)
FREQUENCY RANGE	1GHz ~ 40GHz		Average (AV)

ANTENNA POLARITY & TEST DISTANCE: HORIZONTAL AT 3 M

NO.	FREQ. (MHz)	EMISSION LEVEL (dBuV/m)	LIMIT (dBuV/m)	MARGIN (dB)	ANTENNA HEIGHT (m)	TABLE ANGLE (Degree)	RAW VALUE (dBuV)	CORRECTION FACTOR (dB/m)
1	5150.00	66.0 PK	74.0	-8.0	2.20 H	60	61.00	5.00
2	5150.00	49.9 AV	54.0	-4.1	2.20 H	60	44.90	5.00
3	*5230.00	109.6 PK			2.17 H	54	70.40	39.20
4	*5230.00	99.1 AV			2.17 H	54	59.90	39.20
5	5350.00	59.2 PK	74.0	-14.8	2.20 H	52	53.80	5.40
6	5350.00	45.9 AV	54.0	-8.1	2.20 H	52	40.50	5.40
7	#10460.00	58.1 PK	74.0	-15.9	1.26 H	97	40.90	17.20
8	#10460.00	45.9 AV	54.0	-8.1	1.26 H	97	28.70	17.20

ANTENNA POLARITY & TEST DISTANCE: VERTICAL AT 3 M

NO.	FREQ. (MHz)	EMISSION LEVEL (dBuV/m)	LIMIT (dBuV/m)	MARGIN (dB)	ANTENNA HEIGHT (m)	TABLE ANGLE (Degree)	RAW VALUE (dBuV)	CORRECTION FACTOR (dB/m)
1	5150.00	66.3 PK	74.0	-7.7	1.78 V	353	61.30	5.00
2	5150.00	53.0 AV	54.0	-1.0	1.78 V	353	48.00	5.00
3	*5230.00	113.2 PK			2.13 V	352	74.00	39.20
4	*5230.00	101.3 AV			2.13 V	352	62.10	39.20
5	5350.00	63.3 PK	74.0	-10.7	1.80 V	355	57.90	5.40
6	5350.00	49.4 AV	54.0	-4.6	1.80 V	355	44.00	5.40
7	#10460.00	59.8 PK	74.0	-14.2	1.08 V	56	42.60	17.20
8	#10460.00	47.8 AV	54.0	-6.2	1.08 V	56	30.60	17.20

REMARKS:

1. Emission Level(dBuV/m) = Raw Value(dBuV) + Correction Factor(dB/m)
2. Correction Factor(dB/m) = Antenna Factor(dB/m) + Cable Factor(dB)
3. The other emission levels were very low against the limit.
4. Margin value = Emission Level – Limit value
5. " * ": Fundamental frequency.
6. " # ": The radiated frequency is out of the restricted band.

CHANNEL	TX Channel 151	DETECTOR FUNCTION	Peak (PK)
FREQUENCY RANGE	1GHz ~ 40GHz		Average (AV)

ANTENNA POLARITY & TEST DISTANCE: HORIZONTAL AT 3 M

NO.	FREQ. (MHz)	EMISSION LEVEL (dBuV/m)	LIMIT (dBuV/m)	MARGIN (dB)	ANTENNA HEIGHT (m)	TABLE ANGLE (Degree)	RAW VALUE (dBuV)	CORRECTION FACTOR (dB/m)
1	#5714.00	67.2 PK	74.0	-6.8	1.96 H	310	61.20	6.00
2	#5714.00	49.2 AV	54.0	-4.8	1.96 H	310	43.20	6.00
3	#5722.00	67.4 PK	78.2	-10.8	1.96 H	302	61.30	6.10
4	#5725.00	59.3 PK	78.2	-18.9	1.94 H	302	53.20	6.10
5	*5755.00	101.2 PK			1.95 H	302	60.90	40.30
6	*5755.00	90.8 AV			1.95 H	302	50.50	40.30
7	11510.00	57.9 PK	74.0	-16.1	1.47 H	87	40.50	17.40
8	11510.00	46.1 AV	54.0	-7.9	1.47 H	87	28.70	17.40

ANTENNA POLARITY & TEST DISTANCE: VERTICAL AT 3 M

NO.	FREQ. (MHz)	EMISSION LEVEL (dBuV/m)	LIMIT (dBuV/m)	MARGIN (dB)	ANTENNA HEIGHT (m)	TABLE ANGLE (Degree)	RAW VALUE (dBuV)	CORRECTION FACTOR (dB/m)
1	#5714.00	72.3 PK	74.0	-1.7	2.05 V	323	66.30	6.00
2	#5714.00	52.9 AV	54.0	-1.1	2.05 V	323	46.90	6.00
3	#5722.00	56.9 PK	78.2	-21.3	2.10 V	325	50.80	6.10
4	#5725.00	63.1 PK	78.2	-15.1	2.10 V	336	57.00	6.10
5	*5755.00	104.7 PK			2.05 V	325	64.40	40.30
6	*5755.00	94.6 AV			2.05 V	325	54.30	40.30
7	11510.00	59.2 PK	74.0	-14.8	1.07 V	85	41.80	17.40
8	11510.00	46.1 AV	54.0	-7.9	1.07 V	85	28.70	17.40

REMARKS:

1. Emission Level(dBuV/m) = Raw Value(dBuV) + Correction Factor(dB/m)
2. Correction Factor(dB/m) = Antenna Factor(dB/m) + Cable Factor(dB)
3. The other emission levels were very low against the limit.
4. Margin value = Emission Level – Limit value
5. " * ": Fundamental frequency.
6. " # ": The radiated frequency is out of the restricted band.

CHANNEL	TX Channel 159	DETECTOR FUNCTION	Peak (PK)
FREQUENCY RANGE	1GHz ~ 40GHz		Average (AV)

ANTENNA POLARITY & TEST DISTANCE: HORIZONTAL AT 3 M

NO.	FREQ. (MHz)	EMISSION LEVEL (dBuV/m)	LIMIT (dBuV/m)	MARGIN (dB)	ANTENNA HEIGHT (m)	TABLE ANGLE (Degree)	RAW VALUE (dBuV)	CORRECTION FACTOR (dB/m)
1	*5795.00	104.8 PK			2.10 H	298	64.50	40.30
2	*5795.00	94.3 AV			2.10 H	298	54.00	40.30
3	#5850.00	59.0 PK	78.2	-19.2	2.11 H	312	52.60	6.40
4	#5853.00	65.8 PK	78.2	-12.4	2.14 H	301	59.40	6.40
5	#5861.00	67.6 PK	74.0	-6.4	2.11 H	300	61.20	6.40
6	#5861.00	49.2 AV	54.0	-4.8	2.11 H	300	42.80	6.40
7	11590.00	58.8 PK	74.0	-15.2	1.23 H	64	41.50	17.30
8	11590.00	45.7 AV	54.0	-8.3	1.23 H	64	28.40	17.30

ANTENNA POLARITY & TEST DISTANCE: VERTICAL AT 3 M

NO.	FREQ. (MHz)	EMISSION LEVEL (dBuV/m)	LIMIT (dBuV/m)	MARGIN (dB)	ANTENNA HEIGHT (m)	TABLE ANGLE (Degree)	RAW VALUE (dBuV)	CORRECTION FACTOR (dB/m)
1	*5795.00	109.1 PK			1.84 V	14	68.80	40.30
2	*5795.00	98.7 AV			1.84 V	14	58.40	40.30
3	#5850.00	65.1 PK	78.2	-13.1	1.82 V	12	58.70	6.40
4	#5853.00	72.4 PK	78.2	-5.8	1.85 V	10	66.00	6.40
5	#5861.00	71.4 PK	74.0	-2.6	1.85 V	4	65.00	6.40
6	#5861.00	53.0 AV	54.0	-1.0	1.85 V	4	46.60	6.40
7	11590.00	58.8 PK	74.0	-15.2	1.25 V	87	41.50	17.30
8	11590.00	47.0 AV	54.0	-7.0	1.25 V	87	29.70	17.30

REMARKS:

1. Emission Level(dBuV/m) = Raw Value(dBuV) + Correction Factor(dB/m)
2. Correction Factor(dB/m) = Antenna Factor(dB/m) + Cable Factor(dB)
3. The other emission levels were very low against the limit.
4. Margin value = Emission Level – Limit value
5. " * ": Fundamental frequency.
6. " # ": The radiated frequency is out of the restricted band.

802.11ac (VHT80)

CHANNEL	TX Channel 42	DETECTOR FUNCTION	Peak (PK)
FREQUENCY RANGE	1GHz ~ 40GHz		Average (AV)

ANTENNA POLARITY & TEST DISTANCE: HORIZONTAL AT 3 M								
NO.	FREQ. (MHz)	EMISSION LEVEL (dBuV/m)	LIMIT (dBuV/m)	MARGIN (dB)	ANTENNA HEIGHT (m)	TABLE ANGLE (Degree)	RAW VALUE (dBuV)	CORRECTION FACTOR (dB/m)
1	5150.00	70.3 PK	74.0	-3.7	2.19 H	55	65.30	5.00
2	5150.00	45.9 AV	54.0	-8.1	2.19 H	55	40.90	5.00
3	*5210.00	98.5 PK			2.17 H	53	59.30	39.20
4	*5210.00	87.7 AV			2.17 H	53	48.50	39.20
5	#10420.00	57.5 PK	74.0	-16.5	1.07 H	41	40.20	17.30
6	#10420.00	46.0 AV	54.0	-8.0	1.07 H	41	28.70	17.30
ANTENNA POLARITY & TEST DISTANCE: VERTICAL AT 3 M								
NO.	FREQ. (MHz)	EMISSION LEVEL (dBuV/m)	LIMIT (dBuV/m)	MARGIN (dB)	ANTENNA HEIGHT (m)	TABLE ANGLE (Degree)	RAW VALUE (dBuV)	CORRECTION FACTOR (dB/m)
1	5150.00	73.4 PK	74.0	-0.6	1.51 V	0	68.40	5.00
2	5150.00	45.5 AV	54.0	-8.5	1.51 V	0	40.50	5.00
3	*5210.00	101.6 PK			1.84 V	66	62.40	39.20
4	*5210.00	91.0 AV			1.84 V	66	51.80	39.20
5	#10420.00	57.9 PK	74.0	-16.1	1.05 V	78	40.60	17.30
6	#10420.00	46.3 AV	54.0	-7.7	1.05 V	78	29.00	17.30

REMARKS:

1. Emission Level(dBuV/m) = Raw Value(dBuV) + Correction Factor(dB/m)
2. Correction Factor(dB/m) = Antenna Factor(dB/m) + Cable Factor(dB)
3. The other emission levels were very low against the limit.
4. Margin value = Emission Level – Limit value
5. " * ": Fundamental frequency.
6. " # ": The radiated frequency is out of the restricted band.



CHANNEL	TX Channel 155	DETECTOR FUNCTION	Peak (PK)
FREQUENCY RANGE	1GHz ~ 40GHz		Average (AV)

ANTENNA POLARITY & TEST DISTANCE: HORIZONTAL AT 3 M

NO.	FREQ. (MHz)	EMISSION LEVEL (dBuV/m)	LIMIT (dBuV/m)	MARGIN (dB)	ANTENNA HEIGHT (m)	TABLE ANGLE (Degree)	RAW VALUE (dBuV)	CORRECTION FACTOR (dB/m)
1	#5714.00	69.1 PK	74.0	-4.9	2.10 H	310	63.10	6.00
2	#5714.00	49.8 AV	54.0	-4.2	2.10 H	310	43.80	6.00
3	#5722.00	66.7 PK	78.2	-11.5	2.05 H	306	60.60	6.10
4	#5725.00	58.5 PK	78.2	-19.7	2.06 H	307	52.40	6.10
5	*5775.00	97.9 PK			2.02 H	301	57.60	40.30
6	*5775.00	86.2 AV			2.02 H	301	45.90	40.30
7	11550.00	57.9 PK	74.0	-16.1	1.32 H	64	40.50	17.40
8	11550.00	46.1 AV	54.0	-7.9	1.32 H	64	28.70	17.40

ANTENNA POLARITY & TEST DISTANCE: VERTICAL AT 3 M

NO.	FREQ. (MHz)	EMISSION LEVEL (dBuV/m)	LIMIT (dBuV/m)	MARGIN (dB)	ANTENNA HEIGHT (m)	TABLE ANGLE (Degree)	RAW VALUE (dBuV)	CORRECTION FACTOR (dB/m)
1	#5714.00	73.3 PK	74.0	-0.7	2.04 V	322	67.30	6.00
2	#5714.00	51.9 AV	54.0	-2.1	2.04 V	322	45.90	6.00
3	#5722.00	71.6 PK	78.2	-6.6	2.10 V	330	65.50	6.10
4	#5725.00	62.5 PK	78.2	-15.7	2.05 V	321	56.40	6.10
5	*5775.00	101.8 PK			2.08 V	314	61.50	40.30
6	*5775.00	90.9 AV			2.08 V	314	50.60	40.30
7	11550.00	58.0 PK	74.0	-16.0	1.05 V	20	40.60	17.40
8	11550.00	45.9 AV	54.0	-8.1	1.05 V	20	28.50	17.40

REMARKS:

1. Emission Level(dBuV/m) = Raw Value(dBuV) + Correction Factor(dB/m)
2. Correction Factor(dB/m) = Antenna Factor(dB/m) + Cable Factor(dB)
3. The other emission levels were very low against the limit.
4. Margin value = Emission Level – Limit value
5. " * ": Fundamental frequency.

Test Mode B
2TX
802.11a

CHANNEL	TX Channel 36	DETECTOR FUNCTION	Peak (PK)
FREQUENCY RANGE	1GHz ~ 40GHz		Average (AV)

ANTENNA POLARITY & TEST DISTANCE: HORIZONTAL AT 3 M								
NO.	FREQ. (MHz)	EMISSION LEVEL (dBuV/m)	LIMIT (dBuV/m)	MARGIN (dB)	ANTENNA HEIGHT (m)	TABLE ANGLE (Degree)	RAW VALUE (dBuV)	CORRECTION FACTOR (dB/m)
1	5150.00	62.4 PK	74.0	-11.6	1.49 H	48	57.40	5.00
2	5150.00	48.5 AV	54.0	-5.5	1.49 H	48	43.50	5.00
3	*5180.00	115.0 PK			1.46 H	48	75.90	39.10
4	*5180.00	105.2 AV			1.46 H	48	66.10	39.10
5	#10360.00	58.5 PK	74.0	-15.5	1.00 H	71	41.40	17.10
6	#10360.00	46.7 AV	54.0	-7.3	1.00 H	71	29.60	17.10
ANTENNA POLARITY & TEST DISTANCE: VERTICAL AT 3 M								
NO.	FREQ. (MHz)	EMISSION LEVEL (dBuV/m)	LIMIT (dBuV/m)	MARGIN (dB)	ANTENNA HEIGHT (m)	TABLE ANGLE (Degree)	RAW VALUE (dBuV)	CORRECTION FACTOR (dB/m)
1	5150.00	68.0 PK	74.0	-6.0	1.00 V	12	63.00	5.00
2	5150.00	53.1 AV	54.0	-0.9	1.00 V	12	48.10	5.00
3	*5180.00	118.8 PK			1.00 V	354	79.70	39.10
4	*5180.00	108.9 AV			1.00 V	354	69.80	39.10
5	#10360.00	59.6 PK	74.0	-14.4	1.37 V	97	42.50	17.10
6	#10360.00	47.7 AV	54.0	-6.3	1.37 V	97	30.60	17.10

REMARKS:

1. Emission Level(dBuV/m) = Raw Value(dBuV) + Correction Factor(dB/m)
2. Correction Factor(dB/m) = Antenna Factor(dB/m) + Cable Factor(dB)
3. The other emission levels were very low against the limit.
4. Margin value = Emission Level – Limit value
5. " * ": Fundamental frequency.
6. " # ": The radiated frequency is out of the restricted band.

CHANNEL	TX Channel 40	DETECTOR FUNCTION	Peak (PK)
FREQUENCY RANGE	1GHz ~ 40GHz		Average (AV)

ANTENNA POLARITY & TEST DISTANCE: HORIZONTAL AT 3 M

NO.	FREQ. (MHz)	EMISSION LEVEL (dBuV/m)	LIMIT (dBuV/m)	MARGIN (dB)	ANTENNA HEIGHT (m)	TABLE ANGLE (Degree)	RAW VALUE (dBuV)	CORRECTION FACTOR (dB/m)
1	5150.00	62.8 PK	74.0	-11.2	1.48 H	43	57.80	5.00
2	5150.00	48.3 AV	54.0	-5.7	1.48 H	43	43.30	5.00
3	*5200.00	117.3 PK			1.44 H	48	78.10	39.20
4	*5200.00	107.5 AV			1.44 H	48	68.30	39.20
5	#10400.00	59.0 PK	74.0	-15.0	1.00 H	81	41.70	17.30
6	#10400.00	47.1 AV	54.0	-6.9	1.00 H	81	29.80	17.30

ANTENNA POLARITY & TEST DISTANCE: VERTICAL AT 3 M

NO.	FREQ. (MHz)	EMISSION LEVEL (dBuV/m)	LIMIT (dBuV/m)	MARGIN (dB)	ANTENNA HEIGHT (m)	TABLE ANGLE (Degree)	RAW VALUE (dBuV)	CORRECTION FACTOR (dB/m)
1	5150.00	66.9 PK	74.0	-7.1	1.22 V	356	61.90	5.00
2	5150.00	53.2 AV	54.0	-0.8	1.22 V	356	48.20	5.00
3	*5200.00	122.3 PK			1.21 V	354	83.10	39.20
4	*5200.00	111.8 AV			1.21 V	354	72.60	39.20
5	#10400.00	60.4 PK	74.0	-13.6	1.30 V	90	43.10	17.30
6	#10400.00	47.8 AV	54.0	-6.2	1.30 V	90	30.50	17.30

REMARKS:

1. Emission Level(dBuV/m) = Raw Value(dBuV) + Correction Factor(dB/m)
2. Correction Factor(dB/m) = Antenna Factor(dB/m) + Cable Factor(dB)
3. The other emission levels were very low against the limit.
4. Margin value = Emission Level – Limit value
5. " * ": Fundamental frequency.
6. " # ": The radiated frequency is out of the restricted band.

CHANNEL	TX Channel 48	DETECTOR FUNCTION	Peak (PK)
FREQUENCY RANGE	1GHz ~ 40GHz		Average (AV)

ANTENNA POLARITY & TEST DISTANCE: HORIZONTAL AT 3 M

NO.	FREQ. (MHz)	EMISSION LEVEL (dBuV/m)	LIMIT (dBuV/m)	MARGIN (dB)	ANTENNA HEIGHT (m)	TABLE ANGLE (Degree)	RAW VALUE (dBuV)	CORRECTION FACTOR (dB/m)
1	*5240.00	119.0 PK			1.73 H	50	79.80	39.20
2	*5240.00	108.6 AV			1.73 H	50	69.40	39.20
3	5350.00	64.2 PK	74.0	-9.8	1.77 H	45	58.80	5.40
4	5350.00	46.6 AV	54.0	-7.4	1.77 H	45	41.20	5.40
5	#10480.00	58.9 PK	74.0	-15.1	1.00 H	52	41.60	17.30
6	#10480.00	47.3 AV	54.0	-6.7	1.00 H	52	30.00	17.30

ANTENNA POLARITY & TEST DISTANCE: VERTICAL AT 3 M

NO.	FREQ. (MHz)	EMISSION LEVEL (dBuV/m)	LIMIT (dBuV/m)	MARGIN (dB)	ANTENNA HEIGHT (m)	TABLE ANGLE (Degree)	RAW VALUE (dBuV)	CORRECTION FACTOR (dB/m)
1	*5240.00	124.2 PK			1.26 V	358	85.00	39.20
2	*5240.00	112.8 AV			1.26 V	358	73.60	39.20
3	5350.00	64.7 PK	74.0	-9.3	1.24 V	353	59.30	5.40
4	5350.00	46.9 AV	54.0	-7.1	1.24 V	353	41.50	5.40
5	#10480.00	60.2 PK	74.0	-13.8	1.21 V	87	42.90	17.30
6	#10480.00	47.9 AV	54.0	-6.1	1.21 V	87	30.60	17.30

REMARKS:

1. Emission Level(dBuV/m) = Raw Value(dBuV) + Correction Factor(dB/m)
2. Correction Factor(dB/m) = Antenna Factor(dB/m) + Cable Factor(dB)
3. The other emission levels were very low against the limit.
4. Margin value = Emission Level – Limit value
5. " * ": Fundamental frequency.
6. " # ": The radiated frequency is out of the restricted band.

CHANNEL	TX Channel 149	DETECTOR FUNCTION	Peak (PK)
FREQUENCY RANGE	1GHz ~ 40GHz		Average (AV)

ANTENNA POLARITY & TEST DISTANCE: HORIZONTAL AT 3 M

NO.	FREQ. (MHz)	EMISSION LEVEL (dBuV/m)	LIMIT (dBuV/m)	MARGIN (dB)	ANTENNA HEIGHT (m)	TABLE ANGLE (Degree)	RAW VALUE (dBuV)	CORRECTION FACTOR (dB/m)
1	#5714.90	59.5 PK	74.0	-14.5	1.00 H	63	53.50	6.00
2	#5714.90	45.7 AV	54.0	-8.3	1.00 H	63	39.70	6.00
3	#5722.90	65.2 PK	78.2	-13.0	1.00 H	63	59.10	6.10
4	#5725.00	58.3 PK	78.2	-19.9	1.00 H	63	52.20	6.10
5	*5745.00	110.7 PK			1.00 H	64	70.40	40.30
6	*5745.00	101.5 AV			1.00 H	64	61.20	40.30
7	11490.00	58.7 PK	74.0	-15.3	1.00 H	83	41.10	17.60
8	11490.00	45.7 AV	54.0	-8.3	1.00 H	83	28.10	17.60

ANTENNA POLARITY & TEST DISTANCE: VERTICAL AT 3 M

NO.	FREQ. (MHz)	EMISSION LEVEL (dBuV/m)	LIMIT (dBuV/m)	MARGIN (dB)	ANTENNA HEIGHT (m)	TABLE ANGLE (Degree)	RAW VALUE (dBuV)	CORRECTION FACTOR (dB/m)
1	#5714.90	60.8 PK	74.0	-13.2	1.74 V	321	54.80	6.00
2	#5714.90	47.9 AV	54.0	-6.1	1.74 V	321	41.90	6.00
3	#5722.90	76.7 PK	78.2	-1.5	1.76 V	320	70.60	6.10
4	#5725.00	60.1 PK	78.2	-18.1	1.74 V	321	54.00	6.10
5	*5745.00	114.0 PK			1.77 V	359	73.70	40.30
6	*5745.00	104.5 AV			1.77 V	359	64.20	40.30
7	11490.00	59.7 PK	74.0	-14.3	1.23 V	85	42.10	17.60
8	11490.00	46.9 AV	54.0	-7.1	1.23 V	85	29.30	17.60

REMARKS:

1. Emission Level(dBuV/m) = Raw Value(dBuV) + Correction Factor(dB/m)
2. Correction Factor(dB/m) = Antenna Factor(dB/m) + Cable Factor(dB)
3. The other emission levels were very low against the limit.
4. Margin value = Emission Level – Limit value
5. " * ": Fundamental frequency.
6. " # ": The radiated frequency is out of the restricted band.

CHANNEL	TX Channel 157	DETECTOR FUNCTION	Peak (PK)
FREQUENCY RANGE	1GHz ~ 40GHz		Average (AV)

ANTENNA POLARITY & TEST DISTANCE: HORIZONTAL AT 3 M

NO.	FREQ. (MHz)	EMISSION LEVEL (dBuV/m)	LIMIT (dBuV/m)	MARGIN (dB)	ANTENNA HEIGHT (m)	TABLE ANGLE (Degree)	RAW VALUE (dBuV)	CORRECTION FACTOR (dB/m)
1	#5714.90	63.1 PK	74.0	-10.9	1.00 H	61	57.10	6.00
2	#5714.90	49.3 AV	54.0	-4.7	1.00 H	61	43.30	6.00
3	#5722.90	66.5 PK	78.2	-11.7	1.00 H	61	60.40	6.10
4	*5785.00	117.5 PK			1.00 H	68	77.20	40.30
5	*5785.00	106.9 AV			1.00 H	68	66.60	40.30
6	11570.00	59.2 PK	74.0	-14.8	1.00 H	97	41.70	17.50
7	11570.00	46.5 AV	54.0	-7.5	1.00 H	97	29.00	17.50

ANTENNA POLARITY & TEST DISTANCE: VERTICAL AT 3 M

NO.	FREQ. (MHz)	EMISSION LEVEL (dBuV/m)	LIMIT (dBuV/m)	MARGIN (dB)	ANTENNA HEIGHT (m)	TABLE ANGLE (Degree)	RAW VALUE (dBuV)	CORRECTION FACTOR (dB/m)
1	#5714.90	68.6 PK	74.0	-5.4	1.89 V	6	62.60	6.00
2	#5714.90	53.8 AV	54.0	-0.2	1.89 V	6	47.80	6.00
3	#5722.90	72.8 PK	78.2	-5.4	1.85 V	6	66.70	6.10
4	*5785.00	121.7 PK			2.02 V	1	81.40	40.30
5	*5785.00	111.2 AV			2.02 V	1	70.90	40.30
6	11570.00	60.5 PK	74.0	-13.5	1.34 V	62	43.00	17.50
7	11570.00	47.9 AV	54.0	-6.1	1.34 V	62	30.40	17.50

REMARKS:

1. Emission Level(dBuV/m) = Raw Value(dBuV) + Correction Factor(dB/m)
2. Correction Factor(dB/m) = Antenna Factor(dB/m) + Cable Factor(dB)
3. The other emission levels were very low against the limit.
4. Margin value = Emission Level – Limit value
5. " * ": Fundamental frequency.

CHANNEL	TX Channel 165	DETECTOR FUNCTION	Peak (PK)
FREQUENCY RANGE	1GHz ~ 40GHz		Average (AV)

ANTENNA POLARITY & TEST DISTANCE: HORIZONTAL AT 3 M

NO.	FREQ. (MHz)	EMISSION LEVEL (dBuV/m)	LIMIT (dBuV/m)	MARGIN (dB)	ANTENNA HEIGHT (m)	TABLE ANGLE (Degree)	RAW VALUE (dBuV)	CORRECTION FACTOR (dB/m)
1	*5825.00	114.1 PK			1.54 H	56	73.70	40.40
2	*5825.00	104.3 AV			1.54 H	56	63.90	40.40
3	#5850.00	56.1 PK	78.2	-22.1	1.52 H	59	49.70	6.40
4	#5852.10	69.1 PK	78.2	-9.1	1.52 H	59	62.70	6.40
5	#5860.10	65.8 PK	74.0	-8.2	1.52 H	59	59.40	6.40
6	#5860.10	50.4 AV	54.0	-3.6	1.52 H	59	44.00	6.40
7	11650.00	59.0 PK	74.0	-15.0	1.00 H	57	41.70	17.30
8	11650.00	46.2 AV	54.0	-7.8	1.00 H	57	28.90	17.30

ANTENNA POLARITY & TEST DISTANCE: VERTICAL AT 3 M

NO.	FREQ. (MHz)	EMISSION LEVEL (dBuV/m)	LIMIT (dBuV/m)	MARGIN (dB)	ANTENNA HEIGHT (m)	TABLE ANGLE (Degree)	RAW VALUE (dBuV)	CORRECTION FACTOR (dB/m)
1	*5825.00	117.5 PK			1.78 V	1	77.10	40.40
2	*5825.00	107.9 AV			1.78 V	1	67.50	40.40
3	#5850.00	61.7 PK	78.2	-16.5	1.85 V	7	55.30	6.40
4	#5852.10	72.2 PK	78.2	-6.0	1.85 V	7	65.80	6.40
5	#5860.10	68.9 PK	74.0	-5.1	1.77 V	4	62.50	6.40
6	#5860.10	53.3 AV	54.0	-0.7	1.77 V	4	46.90	6.40
7	11650.00	60.2 PK	74.0	-13.8	1.31 V	63	42.90	17.30
8	11650.00	47.6 AV	54.0	-6.4	1.31 V	63	30.30	17.30

REMARKS:

1. Emission Level(dBuV/m) = Raw Value(dBuV) + Correction Factor(dB/m)
2. Correction Factor(dB/m) = Antenna Factor(dB/m) + Cable Factor(dB)
3. The other emission levels were very low against the limit.
4. Margin value = Emission Level – Limit value
5. " * ": Fundamental frequency.
6. " # ": The radiated frequency is out of the restricted band.

802.11n (HT20)

CHANNEL	TX Channel 36	DETECTOR FUNCTION	Peak (PK)
FREQUENCY RANGE	1GHz ~ 40GHz		Average (AV)

ANTENNA POLARITY & TEST DISTANCE: HORIZONTAL AT 3 M								
NO.	FREQ. (MHz)	EMISSION LEVEL (dBuV/m)	LIMIT (dBuV/m)	MARGIN (dB)	ANTENNA HEIGHT (m)	TABLE ANGLE (Degree)	RAW VALUE (dBuV)	CORRECTION FACTOR (dB/m)
1	5150.00	65.1 PK	74.0	-8.9	1.56 H	51	60.10	5.00
2	5150.00	48.8 AV	54.0	-5.2	1.56 H	51	43.80	5.00
3	*5180.00	113.5 PK			1.56 H	59	74.40	39.10
4	*5180.00	104.3 AV			1.56 H	59	65.20	39.10
5	#10360.00	58.9 PK	74.0	-15.1	1.00 H	77	41.80	17.10
6	#10360.00	46.5 AV	54.0	-7.5	1.00 H	77	29.40	17.10

ANTENNA POLARITY & TEST DISTANCE: VERTICAL AT 3 M								
NO.	FREQ. (MHz)	EMISSION LEVEL (dBuV/m)	LIMIT (dBuV/m)	MARGIN (dB)	ANTENNA HEIGHT (m)	TABLE ANGLE (Degree)	RAW VALUE (dBuV)	CORRECTION FACTOR (dB/m)
1	5150.00	70.2 PK	74.0	-3.8	1.69 V	350	65.20	5.00
2	5150.00	53.6 AV	54.0	-0.4	1.69 V	350	48.60	5.00
3	*5180.00	118.6 PK			1.68 V	342	79.50	39.10
4	*5180.00	108.9 AV			1.68 V	342	69.80	39.10
5	#10360.00	59.4 PK	74.0	-14.6	1.32 V	96	42.30	17.10
6	#10360.00	46.7 AV	54.0	-7.3	1.32 V	96	29.60	17.10

REMARKS:

1. Emission Level(dBuV/m) = Raw Value(dBuV) + Correction Factor(dB/m)
2. Correction Factor(dB/m) = Antenna Factor(dB/m) + Cable Factor(dB)
3. The other emission levels were very low against the limit.
4. Margin value = Emission Level – Limit value
5. " * ": Fundamental frequency.
6. " # ": The radiated frequency is out of the restricted band.

CHANNEL	TX Channel 40	DETECTOR FUNCTION	Peak (PK)
FREQUENCY RANGE	1GHz ~ 40GHz		Average (AV)

ANTENNA POLARITY & TEST DISTANCE: HORIZONTAL AT 3 M

NO.	FREQ. (MHz)	EMISSION LEVEL (dBuV/m)	LIMIT (dBuV/m)	MARGIN (dB)	ANTENNA HEIGHT (m)	TABLE ANGLE (Degree)	RAW VALUE (dBuV)	CORRECTION FACTOR (dB/m)
1	5150.00	68.3 PK	74.0	-5.7	1.25 H	55	63.30	5.00
2	5150.00	49.8 AV	54.0	-4.2	1.25 H	55	44.80	5.00
3	*5200.00	115.3 PK			1.27 H	56	76.10	39.20
4	*5200.00	106.1 AV			1.27 H	56	66.90	39.20
5	#10400.00	58.8 PK	74.0	-15.2	1.00 H	80	41.50	17.30
6	#10400.00	47.0 AV	54.0	-7.0	1.00 H	80	29.70	17.30

ANTENNA POLARITY & TEST DISTANCE: VERTICAL AT 3 M

NO.	FREQ. (MHz)	EMISSION LEVEL (dBuV/m)	LIMIT (dBuV/m)	MARGIN (dB)	ANTENNA HEIGHT (m)	TABLE ANGLE (Degree)	RAW VALUE (dBuV)	CORRECTION FACTOR (dB/m)
1	5150.00	68.8 PK	74.0	-5.2	1.43 V	359	63.80	5.00
2	5150.00	52.9 AV	54.0	-1.1	1.43 V	359	47.90	5.00
3	*5200.00	122.8 PK			1.90 V	11	83.60	39.20
4	*5200.00	113.3 AV			1.90 V	11	74.10	39.20
5	#10400.00	60.0 PK	74.0	-14.0	1.31 V	95	42.70	17.30
6	#10400.00	47.5 AV	54.0	-6.5	1.31 V	95	30.20	17.30

REMARKS:

1. Emission Level(dBuV/m) = Raw Value(dBuV) + Correction Factor(dB/m)
2. Correction Factor(dB/m) = Antenna Factor(dB/m) + Cable Factor(dB)
3. The other emission levels were very low against the limit.
4. Margin value = Emission Level – Limit value
5. " * ": Fundamental frequency.
6. " # ": The radiated frequency is out of the restricted band.

CHANNEL	TX Channel 48	DETECTOR FUNCTION	Peak (PK)
FREQUENCY RANGE	1GHz ~ 40GHz		Average (AV)

ANTENNA POLARITY & TEST DISTANCE: HORIZONTAL AT 3 M

NO.	FREQ. (MHz)	EMISSION LEVEL (dBuV/m)	LIMIT (dBuV/m)	MARGIN (dB)	ANTENNA HEIGHT (m)	TABLE ANGLE (Degree)	RAW VALUE (dBuV)	CORRECTION FACTOR (dB/m)
1	*5240.00	118.3 PK			1.56 H	59	79.10	39.20
2	*5240.00	108.0 AV			1.56 H	59	68.80	39.20
3	5350.00	61.8 PK	74.0	-12.2	1.55 H	56	56.40	5.40
4	5350.00	45.8 AV	54.0	-8.2	1.55 H	56	40.40	5.40
5	#10480.00	59.1 PK	74.0	-14.9	1.00 H	51	41.80	17.30
6	#10480.00	46.8 AV	54.0	-7.2	1.00 H	51	29.50	17.30

ANTENNA POLARITY & TEST DISTANCE: VERTICAL AT 3 M

NO.	FREQ. (MHz)	EMISSION LEVEL (dBuV/m)	LIMIT (dBuV/m)	MARGIN (dB)	ANTENNA HEIGHT (m)	TABLE ANGLE (Degree)	RAW VALUE (dBuV)	CORRECTION FACTOR (dB/m)
1	*5240.00	123.4 PK			1.20 V	18	84.20	39.20
2	*5240.00	113.0 AV			1.20 V	18	73.80	39.20
3	5350.00	62.1 PK	74.0	-11.9	1.17 V	11	56.70	5.40
4	5350.00	46.1 AV	54.0	-7.9	1.17 V	11	40.70	5.40
5	#10480.00	59.7 PK	74.0	-14.3	1.26 V	88	42.40	17.30
6	#10480.00	47.3 AV	54.0	-6.7	1.26 V	88	30.00	17.30

REMARKS:

1. Emission Level(dBuV/m) = Raw Value(dBuV) + Correction Factor(dB/m)
2. Correction Factor(dB/m) = Antenna Factor(dB/m) + Cable Factor(dB)
3. The other emission levels were very low against the limit.
4. Margin value = Emission Level – Limit value
5. " * ": Fundamental frequency.
6. " # ": The radiated frequency is out of the restricted band.

CHANNEL	TX Channel 149	DETECTOR FUNCTION	Peak (PK)
FREQUENCY RANGE	1GHz ~ 40GHz		Average (AV)

ANTENNA POLARITY & TEST DISTANCE: HORIZONTAL AT 3 M

NO.	FREQ. (MHz)	EMISSION LEVEL (dBuV/m)	LIMIT (dBuV/m)	MARGIN (dB)	ANTENNA HEIGHT (m)	TABLE ANGLE (Degree)	RAW VALUE (dBuV)	CORRECTION FACTOR (dB/m)
1	#5714.00	58.6 PK	74.0	-15.4	1.56 H	72	52.60	6.00
2	#5714.00	47.5 AV	54.0	-6.5	1.56 H	72	41.50	6.00
3	#5722.00	68.7 PK	78.2	-9.5	1.69 H	320	62.60	6.10
4	#5725.00	57.7 PK	78.2	-20.5	1.36 H	28	51.60	6.10
5	*5745.00	111.9 PK			1.45 H	64	71.60	40.30
6	*5745.00	99.8 AV			1.45 H	64	59.50	40.30
7	11490.00	57.9 PK	74.0	-16.1	1.32 H	64	40.30	17.60
8	11490.00	44.7 AV	54.0	-9.3	1.32 H	64	27.10	17.60

ANTENNA POLARITY & TEST DISTANCE: VERTICAL AT 3 M

NO.	FREQ. (MHz)	EMISSION LEVEL (dBuV/m)	LIMIT (dBuV/m)	MARGIN (dB)	ANTENNA HEIGHT (m)	TABLE ANGLE (Degree)	RAW VALUE (dBuV)	CORRECTION FACTOR (dB/m)
1	#5714.00	61.2 PK	74.0	-12.8	1.81 V	331	55.20	6.00
2	#5714.00	47.5 AV	54.0	-6.5	1.81 V	331	41.50	6.00
3	#5722.00	77.2 PK	78.2	-1.0	1.46 V	330	71.10	6.10
4	#5725.00	65.1 PK	78.2	-13.1	1.74 V	321	59.00	6.10
5	*5745.00	113.4 PK			1.45 V	329	73.10	40.30
6	*5745.00	102.6 AV			1.45 V	329	62.30	40.30
7	11490.00	58.8 PK	74.0	-15.2	1.32 V	64	41.20	17.60
8	11490.00	46.6 AV	54.0	-7.4	1.32 V	64	29.00	17.60

REMARKS:

1. Emission Level(dBuV/m) = Raw Value(dBuV) + Correction Factor(dB/m)
2. Correction Factor(dB/m) = Antenna Factor(dB/m) + Cable Factor(dB)
3. The other emission levels were very low against the limit.
4. Margin value = Emission Level – Limit value
5. " * ": Fundamental frequency.
6. " # ": The radiated frequency is out of the restricted band.

CHANNEL	TX Channel 157	DETECTOR FUNCTION	Peak (PK)
FREQUENCY RANGE	1GHz ~ 40GHz		Average (AV)

ANTENNA POLARITY & TEST DISTANCE: HORIZONTAL AT 3 M

NO.	FREQ. (MHz)	EMISSION LEVEL (dBuV/m)	LIMIT (dBuV/m)	MARGIN (dB)	ANTENNA HEIGHT (m)	TABLE ANGLE (Degree)	RAW VALUE (dBuV)	CORRECTION FACTOR (dB/m)
1	*5785.00	114.8 PK			1.77 H	58	74.50	40.30
2	*5785.00	104.9 AV			1.77 H	58	64.60	40.30
3	11570.00	57.5 PK	74.0	-16.5	1.32 H	64	40.00	17.50
4	11570.00	45.0 AV	54.0	-9.0	1.32 H	64	27.50	17.50

ANTENNA POLARITY & TEST DISTANCE: VERTICAL AT 3 M

NO.	FREQ. (MHz)	EMISSION LEVEL (dBuV/m)	LIMIT (dBuV/m)	MARGIN (dB)	ANTENNA HEIGHT (m)	TABLE ANGLE (Degree)	RAW VALUE (dBuV)	CORRECTION FACTOR (dB/m)
1	*5785.00	117.5 PK			1.96 V	332	77.20	40.30
2	*5785.00	106.2 AV			1.96 V	332	65.90	40.30
3	11570.00	59.2 PK	74.0	-14.8	1.25 V	87	41.70	17.50
4	11570.00	46.5 AV	54.0	-7.5	1.25 V	87	29.00	17.50

REMARKS:

1. Emission Level(dBuV/m) = Raw Value(dBuV) + Correction Factor(dB/m)
2. Correction Factor(dB/m) = Antenna Factor(dB/m) + Cable Factor(dB)
3. The other emission levels were very low against the limit.
4. Margin value = Emission Level – Limit value
5. " * ": Fundamental frequency.

CHANNEL	TX Channel 165	DETECTOR FUNCTION	Peak (PK)
FREQUENCY RANGE	1GHz ~ 40GHz		Average (AV)

ANTENNA POLARITY & TEST DISTANCE: HORIZONTAL AT 3 M

NO.	FREQ. (MHz)	EMISSION LEVEL (dBuV/m)	LIMIT (dBuV/m)	MARGIN (dB)	ANTENNA HEIGHT (m)	TABLE ANGLE (Degree)	RAW VALUE (dBuV)	CORRECTION FACTOR (dB/m)
1	*5825.00	112.0 PK			1.92 H	56	71.60	40.40
2	*5825.00	101.2 AV			1.92 H	56	60.80	40.40
3	#5850.00	58.0 PK	78.2	-20.2	1.63 H	87	51.60	6.40
4	#5853.00	73.1 PK	78.2	-5.1	1.84 H	63	66.70	6.40
5	#5861.00	68.0 PK	74.0	-6.0	1.58 H	61	61.60	6.40
6	#5861.00	50.1 AV	54.0	-3.9	1.58 H	61	43.70	6.40
7	11650.00	57.6 PK	74.0	-16.4	1.23 H	64	40.30	17.30
8	11650.00	44.4 AV	54.0	-9.6	1.23 H	64	27.10	17.30

ANTENNA POLARITY & TEST DISTANCE: VERTICAL AT 3 M

NO.	FREQ. (MHz)	EMISSION LEVEL (dBuV/m)	LIMIT (dBuV/m)	MARGIN (dB)	ANTENNA HEIGHT (m)	TABLE ANGLE (Degree)	RAW VALUE (dBuV)	CORRECTION FACTOR (dB/m)
1	*5825.00	115.0 PK			1.60 V	6	74.60	40.40
2	*5825.00	105.7 AV			1.60 V	6	65.30	40.40
3	#5850.00	66.5 PK	78.2	-11.7	1.61 V	30	60.10	6.40
4	#5853.00	76.4 PK	78.2	-1.8	1.59 V	21	70.00	6.40
5	#5861.00	68.1 PK	74.0	-5.9	1.99 V	2	61.70	6.40
6	#5861.00	52.8 AV	54.0	-1.2	1.99 V	2	46.40	6.40
7	11650.00	58.8 PK	74.0	-15.2	1.36 V	98	41.50	17.30
8	11650.00	45.7 AV	54.0	-8.3	1.36 V	98	28.40	17.30

REMARKS:

1. Emission Level(dBuV/m) = Raw Value(dBuV) + Correction Factor(dB/m)
2. Correction Factor(dB/m) = Antenna Factor(dB/m) + Cable Factor(dB)
3. The other emission levels were very low against the limit.
4. Margin value = Emission Level – Limit value
5. " * ": Fundamental frequency.
6. " # ": The radiated frequency is out of the restricted band.

802.11n (HT40)

CHANNEL	TX Channel 38	DETECTOR FUNCTION	Peak (PK)
FREQUENCY RANGE	1GHz ~ 40GHz		Average (AV)

ANTENNA POLARITY & TEST DISTANCE: HORIZONTAL AT 3 M								
NO.	FREQ. (MHz)	EMISSION LEVEL (dBuV/m)	LIMIT (dBuV/m)	MARGIN (dB)	ANTENNA HEIGHT (m)	TABLE ANGLE (Degree)	RAW VALUE (dBuV)	CORRECTION FACTOR (dB/m)
1	5150.00	66.0 PK	74.0	-8.0	1.57 H	57	61.00	5.00
2	5150.00	47.3 AV	54.0	-6.7	1.57 H	57	42.30	5.00
3	*5190.00	107.4 PK			1.56 H	60	68.30	39.10
4	*5190.00	98.2 AV			1.56 H	60	59.10	39.10
5	#10380.00	57.7 PK	74.0	-16.3	1.00 H	84	40.50	17.20
6	#10380.00	45.3 AV	54.0	-8.7	1.00 H	84	28.10	17.20
ANTENNA POLARITY & TEST DISTANCE: VERTICAL AT 3 M								
NO.	FREQ. (MHz)	EMISSION LEVEL (dBuV/m)	LIMIT (dBuV/m)	MARGIN (dB)	ANTENNA HEIGHT (m)	TABLE ANGLE (Degree)	RAW VALUE (dBuV)	CORRECTION FACTOR (dB/m)
1	5150.00	73.6 PK	74.0	-0.4	2.17 V	8	68.60	5.00
2	5150.00	53.6 AV	54.0	-0.4	2.17 V	8	48.60	5.00
3	*5190.00	113.4 PK			2.20 V	1	74.30	39.10
4	*5190.00	104.4 AV			2.20 V	1	65.30	39.10
5	#10380.00	58.7 PK	74.0	-15.3	1.37 V	97	41.50	17.20
6	#10380.00	45.7 AV	54.0	-8.3	1.37 V	97	28.50	17.20

REMARKS:

1. Emission Level(dBuV/m) = Raw Value(dBuV) + Correction Factor(dB/m)
2. Correction Factor(dB/m) = Antenna Factor(dB/m) + Cable Factor(dB)
3. The other emission levels were very low against the limit.
4. Margin value = Emission Level – Limit value
5. " * ": Fundamental frequency.
6. " # ": The radiated frequency is out of the restricted band.

CHANNEL	TX Channel 46	DETECTOR FUNCTION	Peak (PK)
FREQUENCY RANGE	1GHz ~ 40GHz		Average (AV)

ANTENNA POLARITY & TEST DISTANCE: HORIZONTAL AT 3 M

NO.	FREQ. (MHz)	EMISSION LEVEL (dBuV/m)	LIMIT (dBuV/m)	MARGIN (dB)	ANTENNA HEIGHT (m)	TABLE ANGLE (Degree)	RAW VALUE (dBuV)	CORRECTION FACTOR (dB/m)
1	5150.00	68.1 PK	74.0	-5.9	1.66 H	52	63.10	5.00
2	5150.00	49.5 AV	54.0	-4.5	1.66 H	52	44.50	5.00
3	*5230.00	114.6 PK			1.70 H	58	75.40	39.20
4	*5230.00	104.5 AV			1.70 H	58	65.30	39.20
5	#10460.00	58.0 PK	74.0	-16.0	1.00 H	68	40.80	17.20
6	#10460.00	45.8 AV	54.0	-8.2	1.00 H	68	28.60	17.20

ANTENNA POLARITY & TEST DISTANCE: VERTICAL AT 3 M

NO.	FREQ. (MHz)	EMISSION LEVEL (dBuV/m)	LIMIT (dBuV/m)	MARGIN (dB)	ANTENNA HEIGHT (m)	TABLE ANGLE (Degree)	RAW VALUE (dBuV)	CORRECTION FACTOR (dB/m)
1	5150.00	73.4 PK	74.0	-0.6	1.13 V	4	68.40	5.00
2	5150.00	53.6 AV	54.0	-0.4	1.13 V	4	48.60	5.00
3	*5230.00	116.7 PK			1.13 V	15	77.50	39.20
4	*5230.00	106.4 AV			1.13 V	15	67.20	39.20
5	#10460.00	59.3 PK	74.0	-14.7	1.33 V	99	42.10	17.20
6	#10460.00	45.9 AV	54.0	-8.1	1.33 V	99	28.70	17.20

REMARKS:

1. Emission Level(dBuV/m) = Raw Value(dBuV) + Correction Factor(dB/m)
2. Correction Factor(dB/m) = Antenna Factor(dB/m) + Cable Factor(dB)
3. The other emission levels were very low against the limit.
4. Margin value = Emission Level – Limit value
5. " * ": Fundamental frequency.
6. " # ": The radiated frequency is out of the restricted band.

CHANNEL	TX Channel 151	DETECTOR FUNCTION	Peak (PK)
FREQUENCY RANGE	1GHz ~ 40GHz		Average (AV)

ANTENNA POLARITY & TEST DISTANCE: HORIZONTAL AT 3 M

NO.	FREQ. (MHz)	EMISSION LEVEL (dBuV/m)	LIMIT (dBuV/m)	MARGIN (dB)	ANTENNA HEIGHT (m)	TABLE ANGLE (Degree)	RAW VALUE (dBuV)	CORRECTION FACTOR (dB/m)
1	#5714.00	69.9 PK	74.0	-4.1	1.56 H	75	63.90	6.00
2	#5714.00	48.6 AV	54.0	-5.4	1.56 H	75	42.60	6.00
3	#5722.00	74.0 PK	78.2	-4.2	1.56 H	75	67.90	6.10
4	#5725.00	58.8 PK	78.2	-19.4	1.63 H	100	52.70	6.10
5	*5755.00	108.5 PK			1.45 H	60	68.20	40.30
6	*5755.00	98.0 AV			1.45 H	60	57.70	40.30
7	11510.00	57.4 PK	74.0	-16.6	1.32 H	65	40.00	17.40
8	11510.00	44.4 AV	54.0	-9.6	1.32 H	65	27.00	17.40

ANTENNA POLARITY & TEST DISTANCE: VERTICAL AT 3 M

NO.	FREQ. (MHz)	EMISSION LEVEL (dBuV/m)	LIMIT (dBuV/m)	MARGIN (dB)	ANTENNA HEIGHT (m)	TABLE ANGLE (Degree)	RAW VALUE (dBuV)	CORRECTION FACTOR (dB/m)
1	#5714.00	72.0 PK	74.0	-2.0	2.30 V	351	66.00	6.00
2	#5714.00	53.0 AV	54.0	-1.0	2.30 V	351	47.00	6.00
3	#5722.00	74.2 PK	78.2	-4.0	2.11 V	353	68.10	6.10
4	#5725.00	63.0 PK	78.2	-15.2	2.19 V	357	56.90	6.10
5	*5755.00	108.9 PK			2.45 V	333	68.60	40.30
6	*5755.00	98.3 AV			2.45 V	333	58.00	40.30
7	11510.00	58.7 PK	74.0	-15.3	1.32 V	64	41.30	17.40
8	11510.00	45.4 AV	54.0	-8.6	1.32 V	64	28.00	17.40

REMARKS:

1. Emission Level(dBuV/m) = Raw Value(dBuV) + Correction Factor(dB/m)
2. Correction Factor(dB/m) = Antenna Factor(dB/m) + Cable Factor(dB)
3. The other emission levels were very low against the limit.
4. Margin value = Emission Level – Limit value
5. " * ": Fundamental frequency.
6. " # ": The radiated frequency is out of the restricted band.

CHANNEL	TX Channel 159	DETECTOR FUNCTION	Peak (PK)
FREQUENCY RANGE	1GHz ~ 40GHz		Average (AV)

ANTENNA POLARITY & TEST DISTANCE: HORIZONTAL AT 3 M

NO.	FREQ. (MHz)	EMISSION LEVEL (dBuV/m)	LIMIT (dBuV/m)	MARGIN (dB)	ANTENNA HEIGHT (m)	TABLE ANGLE (Degree)	RAW VALUE (dBuV)	CORRECTION FACTOR (dB/m)
1	*5795.00	109.3 PK			1.01 H	57	69.00	40.30
2	*5795.00	99.2 AV			1.01 H	57	58.90	40.30
3	#5850.00	58.7 PK	78.2	-19.5	1.63 H	98	52.30	6.40
4	#5853.00	67.9 PK	78.2	-10.3	1.47 H	85	61.50	6.40
5	#5861.00	65.4 PK	74.0	-8.6	1.10 H	60	59.00	6.40
6	#5861.00	49.1 AV	54.0	-4.9	1.10 H	60	42.70	6.40
7	11590.00	57.4 PK	74.0	-16.6	1.25 H	98	40.10	17.30
8	11590.00	44.8 AV	54.0	-9.2	1.25 H	98	27.50	17.30

ANTENNA POLARITY & TEST DISTANCE: VERTICAL AT 3 M

NO.	FREQ. (MHz)	EMISSION LEVEL (dBuV/m)	LIMIT (dBuV/m)	MARGIN (dB)	ANTENNA HEIGHT (m)	TABLE ANGLE (Degree)	RAW VALUE (dBuV)	CORRECTION FACTOR (dB/m)
1	*5795.00	111.1 PK			1.12 V	332	70.80	40.30
2	*5795.00	100.8 AV			1.12 V	332	60.50	40.30
3	#5850.00	63.1 PK	78.2	-15.1	1.52 V	354	56.70	6.40
4	#5853.00	74.8 PK	78.2	-3.4	1.60 V	360	68.40	6.40
5	#5861.00	68.8 PK	74.0	-5.2	1.56 V	13	62.40	6.40
6	#5861.00	53.4 AV	54.0	-0.6	1.56 V	13	47.00	6.40
7	11590.00	59.0 PK	74.0	-15.0	1.39 V	64	41.70	17.30
8	11590.00	45.6 AV	54.0	-8.4	1.39 V	64	28.30	17.30

REMARKS:

1. Emission Level(dBuV/m) = Raw Value(dBuV) + Correction Factor(dB/m)
2. Correction Factor(dB/m) = Antenna Factor(dB/m) + Cable Factor(dB)
3. The other emission levels were very low against the limit.
4. Margin value = Emission Level – Limit value
5. " * ": Fundamental frequency.
6. " # ": The radiated frequency is out of the restricted band.

802.11ac (VHT80)

CHANNEL	TX Channel 42	DETECTOR FUNCTION	Peak (PK)
FREQUENCY RANGE	1GHz ~ 40GHz		Average (AV)

ANTENNA POLARITY & TEST DISTANCE: HORIZONTAL AT 3 M								
NO.	FREQ. (MHz)	EMISSION LEVEL (dBuV/m)	LIMIT (dBuV/m)	MARGIN (dB)	ANTENNA HEIGHT (m)	TABLE ANGLE (Degree)	RAW VALUE (dBuV)	CORRECTION FACTOR (dB/m)
1	5150.00	73.0 PK	74.0	-1.0	1.54 H	53	68.00	5.00
2	5150.00	46.5 AV	54.0	-7.5	1.54 H	53	41.50	5.00
3	*5210.00	104.2 PK			1.55 H	57	65.00	39.20
4	*5210.00	93.8 AV			1.55 H	57	54.60	39.20
5	#10420.00	57.6 PK	74.0	-16.4	1.00 H	87	40.30	17.30
6	#10420.00	45.1 AV	54.0	-8.9	1.00 H	87	27.80	17.30
ANTENNA POLARITY & TEST DISTANCE: VERTICAL AT 3 M								
NO.	FREQ. (MHz)	EMISSION LEVEL (dBuV/m)	LIMIT (dBuV/m)	MARGIN (dB)	ANTENNA HEIGHT (m)	TABLE ANGLE (Degree)	RAW VALUE (dBuV)	CORRECTION FACTOR (dB/m)
1	5150.00	73.5 PK	74.0	-0.5	1.44 V	358	68.50	5.00
2	5150.00	49.6 AV	54.0	-4.4	1.44 V	358	44.60	5.00
3	*5210.00	106.6 PK			1.12 V	14	67.40	39.20
4	*5210.00	96.7 AV			1.12 V	14	57.50	39.20
5	#10420.00	58.2 PK	74.0	-15.8	1.30 V	92	40.90	17.30
6	#10420.00	45.3 AV	54.0	-8.7	1.30 V	92	28.00	17.30

REMARKS:

1. Emission Level(dBuV/m) = Raw Value(dBuV) + Correction Factor(dB/m)
2. Correction Factor(dB/m) = Antenna Factor(dB/m) + Cable Factor(dB)
3. The other emission levels were very low against the limit.
4. Margin value = Emission Level – Limit value
5. " * ": Fundamental frequency.
6. " # ": The radiated frequency is out of the restricted band.



CHANNEL	TX Channel 155	DETECTOR FUNCTION	Peak (PK)
FREQUENCY RANGE	1GHz ~ 40GHz		Average (AV)

ANTENNA POLARITY & TEST DISTANCE: HORIZONTAL AT 3 M

NO.	FREQ. (MHz)	EMISSION LEVEL (dBuV/m)	LIMIT (dBuV/m)	MARGIN (dB)	ANTENNA HEIGHT (m)	TABLE ANGLE (Degree)	RAW VALUE (dBuV)	CORRECTION FACTOR (dB/m)
1	#5714.00	58.6 PK	74.0	-15.4	2.30 H	100	52.60	6.00
2	#5714.00	48.6 AV	54.0	-5.4	2.30 H	100	42.60	6.00
3	#5722.00	62.5 PK	78.2	-15.7	2.10 H	105	56.40	6.10
4	#5725.00	59.1 PK	78.2	-19.1	1.36 H	97	53.00	6.10
5	*5775.00	107.4 PK			2.27 H	56	67.10	40.30
6	*5775.00	97.9 AV			2.27 H	56	57.60	40.30
7	11550.00	57.8 PK	74.0	-16.2	1.25 H	63	40.40	17.40
8	11550.00	44.5 AV	54.0	-9.5	1.25 H	63	27.10	17.40

ANTENNA POLARITY & TEST DISTANCE: VERTICAL AT 3 M

NO.	FREQ. (MHz)	EMISSION LEVEL (dBuV/m)	LIMIT (dBuV/m)	MARGIN (dB)	ANTENNA HEIGHT (m)	TABLE ANGLE (Degree)	RAW VALUE (dBuV)	CORRECTION FACTOR (dB/m)
1	#5714.00	70.8 PK	74.0	-3.2	2.37 V	333	64.80	6.00
2	#5714.00	52.7 AV	54.0	-1.3	2.37 V	333	46.70	6.00
3	#5722.00	77.4 PK	78.2	-0.8	1.98 V	329	71.30	6.10
4	#5725.00	63.1 PK	78.2	-15.1	2.04 V	317	57.00	6.10
5	*5775.00	109.3 PK			1.30 V	19	69.00	40.30
6	*5775.00	99.3 AV			1.30 V	19	59.00	40.30
7	11550.00	58.9 PK	74.0	-15.1	1.63 V	69	41.50	17.40
8	11550.00	45.9 AV	54.0	-8.1	1.63 V	69	28.50	17.40

REMARKS:

1. Emission Level(dBuV/m) = Raw Value(dBuV) + Correction Factor(dB/m)
2. Correction Factor(dB/m) = Antenna Factor(dB/m) + Cable Factor(dB)
3. The other emission levels were very low against the limit.
4. Margin value = Emission Level – Limit value
5. " * ": Fundamental frequency.

Test Mode B
3TX
802.11a

CHANNEL	TX Channel 36	DETECTOR FUNCTION	Peak (PK)
FREQUENCY RANGE	1GHz ~ 40GHz		Average (AV)

ANTENNA POLARITY & TEST DISTANCE: HORIZONTAL AT 3 M								
NO.	FREQ. (MHz)	EMISSION LEVEL (dBuV/m)	LIMIT (dBuV/m)	MARGIN (dB)	ANTENNA HEIGHT (m)	TABLE ANGLE (Degree)	RAW VALUE (dBuV)	CORRECTION FACTOR (dB/m)
1	5150.00	63.7 PK	74.0	-10.3	1.17 H	50	58.70	5.00
2	5150.00	48.5 AV	54.0	-5.5	1.17 H	50	43.50	5.00
3	*5180.00	117.4 PK			1.19 H	55	78.30	39.10
4	*5180.00	107.6 AV			1.19 H	55	68.50	39.10
5	#10360.00	59.1 PK	74.0	-14.9	1.00 H	77	42.00	17.10
6	#10360.00	47.1 AV	54.0	-6.9	1.00 H	77	30.00	17.10
ANTENNA POLARITY & TEST DISTANCE: VERTICAL AT 3 M								
NO.	FREQ. (MHz)	EMISSION LEVEL (dBuV/m)	LIMIT (dBuV/m)	MARGIN (dB)	ANTENNA HEIGHT (m)	TABLE ANGLE (Degree)	RAW VALUE (dBuV)	CORRECTION FACTOR (dB/m)
1	5150.00	70.2 PK	74.0	-3.8	1.30 V	357	65.20	5.00
2	5150.00	53.6 AV	54.0	-0.4	1.30 V	357	48.60	5.00
3	*5180.00	120.7 PK			1.28 V	359	81.60	39.10
4	*5180.00	111.1 AV			1.28 V	359	72.00	39.10
5	#10360.00	60.3 PK	74.0	-13.7	1.30 V	98	43.20	17.10
6	#10360.00	47.2 AV	54.0	-6.8	1.30 V	98	30.10	17.10

REMARKS:

1. Emission Level(dBuV/m) = Raw Value(dBuV) + Correction Factor(dB/m)
2. Correction Factor(dB/m) = Antenna Factor(dB/m) + Cable Factor(dB)
3. The other emission levels were very low against the limit.
4. Margin value = Emission Level – Limit value
5. " * ": Fundamental frequency.
6. " # ": The radiated frequency is out of the restricted band.

CHANNEL	TX Channel 40	DETECTOR FUNCTION	Peak (PK)
FREQUENCY RANGE	1GHz ~ 40GHz		Average (AV)

ANTENNA POLARITY & TEST DISTANCE: HORIZONTAL AT 3 M

NO.	FREQ. (MHz)	EMISSION LEVEL (dBuV/m)	LIMIT (dBuV/m)	MARGIN (dB)	ANTENNA HEIGHT (m)	TABLE ANGLE (Degree)	RAW VALUE (dBuV)	CORRECTION FACTOR (dB/m)
1	5150.00	62.5 PK	74.0	-11.5	1.42 H	57	57.50	5.00
2	5150.00	50.6 AV	54.0	-3.4	1.42 H	57	45.60	5.00
3	*5200.00	121.5 PK			1.45 H	55	82.30	39.20
4	*5200.00	110.8 AV			1.45 H	55	71.60	39.20
5	#10400.00	59.5 PK	74.0	-14.5	1.00 H	89	42.20	17.30
6	#10400.00	47.4 AV	54.0	-6.6	1.00 H	89	30.10	17.30

ANTENNA POLARITY & TEST DISTANCE: VERTICAL AT 3 M

NO.	FREQ. (MHz)	EMISSION LEVEL (dBuV/m)	LIMIT (dBuV/m)	MARGIN (dB)	ANTENNA HEIGHT (m)	TABLE ANGLE (Degree)	RAW VALUE (dBuV)	CORRECTION FACTOR (dB/m)
1	5150.00	68.9 PK	74.0	-5.1	1.30 V	7	63.90	5.00
2	5150.00	53.4 AV	54.0	-0.6	1.30 V	7	48.40	5.00
3	*5200.00	124.9 PK			1.28 V	358	85.70	39.20
4	*5200.00	114.5 AV			1.28 V	358	75.30	39.20
5	#10400.00	60.6 PK	74.0	-13.4	1.35 V	95	43.30	17.30
6	#10400.00	47.9 AV	54.0	-6.1	1.35 V	95	30.60	17.30

REMARKS:

1. Emission Level(dBuV/m) = Raw Value(dBuV) + Correction Factor(dB/m)
2. Correction Factor(dB/m) = Antenna Factor(dB/m) + Cable Factor(dB)
3. The other emission levels were very low against the limit.
4. Margin value = Emission Level – Limit value
5. " * ": Fundamental frequency.
6. " # ": The radiated frequency is out of the restricted band.

CHANNEL	TX Channel 48	DETECTOR FUNCTION	Peak (PK)
FREQUENCY RANGE	1GHz ~ 40GHz		Average (AV)

ANTENNA POLARITY & TEST DISTANCE: HORIZONTAL AT 3 M

NO.	FREQ. (MHz)	EMISSION LEVEL (dBuV/m)	LIMIT (dBuV/m)	MARGIN (dB)	ANTENNA HEIGHT (m)	TABLE ANGLE (Degree)	RAW VALUE (dBuV)	CORRECTION FACTOR (dB/m)
1	*5240.00	122.4 PK			1.45 H	54	83.20	39.20
2	*5240.00	111.6 AV			1.45 H	54	72.40	39.20
3	5350.00	60.0 PK	74.0	-14.0	1.40 H	55	54.60	5.40
4	5350.00	47.5 AV	54.0	-6.5	1.40 H	55	42.10	5.40
5	#10480.00	59.6 PK	74.0	-14.4	1.00 H	85	42.30	17.30
6	#10480.00	47.6 AV	54.0	-6.4	1.00 H	85	30.30	17.30

ANTENNA POLARITY & TEST DISTANCE: VERTICAL AT 3 M

NO.	FREQ. (MHz)	EMISSION LEVEL (dBuV/m)	LIMIT (dBuV/m)	MARGIN (dB)	ANTENNA HEIGHT (m)	TABLE ANGLE (Degree)	RAW VALUE (dBuV)	CORRECTION FACTOR (dB/m)
1	*5240.00	125.0 PK			1.26 V	359	85.80	39.20
2	*5240.00	114.8 AV			1.26 V	359	75.60	39.20
3	5350.00	60.2 PK	74.0	-13.8	1.24 V	355	54.80	5.40
4	5350.00	47.8 AV	54.0	-6.2	1.24 V	355	42.40	5.40
5	#10480.00	60.8 PK	74.0	-13.2	1.29 V	81	43.50	17.30
6	#10480.00	48.1 AV	54.0	-5.9	1.29 V	81	30.80	17.30

REMARKS:

1. Emission Level(dBuV/m) = Raw Value(dBuV) + Correction Factor(dB/m)
2. Correction Factor(dB/m) = Antenna Factor(dB/m) + Cable Factor(dB)
3. The other emission levels were very low against the limit.
4. Margin value = Emission Level – Limit value
5. " * ": Fundamental frequency.
6. " # ": The radiated frequency is out of the restricted band.



CHANNEL	TX Channel 149	DETECTOR FUNCTION	Peak (PK)
FREQUENCY RANGE	1GHz ~ 40GHz		Average (AV)

ANTENNA POLARITY & TEST DISTANCE: HORIZONTAL AT 3 M

NO.	FREQ. (MHz)	EMISSION LEVEL (dBuV/m)	LIMIT (dBuV/m)	MARGIN (dB)	ANTENNA HEIGHT (m)	TABLE ANGLE (Degree)	RAW VALUE (dBuV)	CORRECTION FACTOR (dB/m)
1	#5714.90	61.5 PK	74.0	-12.5	1.00 H	64	55.50	6.00
2	#5714.90	47.0 AV	54.0	-7.0	1.00 H	64	41.00	6.00
3	#5722.90	68.8 PK	78.2	-9.4	1.00 H	64	62.70	6.10
4	#5725.00	58.2 PK	78.2	-20.0	1.00 H	64	52.10	6.10
5	*5745.00	114.2 PK			1.00 H	65	73.90	40.30
6	*5745.00	104.4 AV			1.00 H	65	64.10	40.30
7	11490.00	59.1 PK	74.0	-14.9	1.00 H	84	41.50	17.60
8	11490.00	45.8 AV	54.0	-8.2	1.00 H	84	28.20	17.60

ANTENNA POLARITY & TEST DISTANCE: VERTICAL AT 3 M

NO.	FREQ. (MHz)	EMISSION LEVEL (dBuV/m)	LIMIT (dBuV/m)	MARGIN (dB)	ANTENNA HEIGHT (m)	TABLE ANGLE (Degree)	RAW VALUE (dBuV)	CORRECTION FACTOR (dB/m)
1	#5714.90	64.3 PK	74.0	-9.7	1.65 V	328	58.30	6.00
2	#5714.90	49.7 AV	54.0	-4.3	1.65 V	328	43.70	6.00
3	#5722.90	77.0 PK	78.2	-1.2	1.68 V	323	70.90	6.10
4	#5725.00	62.4 PK	78.2	-15.8	1.65 V	328	56.30	6.10
5	*5745.00	115.9 PK			1.46 V	324	75.60	40.30
6	*5745.00	106.2 AV			1.46 V	324	65.90	40.30
7	11490.00	60.1 PK	74.0	-13.9	1.23 V	83	42.50	17.60
8	11490.00	47.1 AV	54.0	-6.9	1.23 V	83	29.50	17.60

REMARKS:

1. Emission Level(dBuV/m) = Raw Value(dBuV) + Correction Factor(dB/m)
2. Correction Factor(dB/m) = Antenna Factor(dB/m) + Cable Factor(dB)
3. The other emission levels were very low against the limit.
4. Margin value = Emission Level – Limit value
5. " * ": Fundamental frequency.
6. " # ": The radiated frequency is out of the restricted band.

CHANNEL	TX Channel 157	DETECTOR FUNCTION	Peak (PK)
FREQUENCY RANGE	1GHz ~ 40GHz		Average (AV)

ANTENNA POLARITY & TEST DISTANCE: HORIZONTAL AT 3 M

NO.	FREQ. (MHz)	EMISSION LEVEL (dBuV/m)	LIMIT (dBuV/m)	MARGIN (dB)	ANTENNA HEIGHT (m)	TABLE ANGLE (Degree)	RAW VALUE (dBuV)	CORRECTION FACTOR (dB/m)
1	#5714.90	62.7 PK	74.0	-11.3	1.00 H	67	56.70	6.00
2	#5714.90	48.4 AV	54.0	-5.6	1.00 H	67	42.40	6.00
3	#5722.90	67.9 PK	78.2	-10.3	1.00 H	67	61.80	6.10
4	*5785.00	119.9 PK			1.00 H	67	79.60	40.30
5	*5785.00	109.5 AV			1.00 H	67	69.20	40.30
6	11570.00	59.5 PK	74.0	-14.5	1.00 H	92	42.00	17.50
7	11570.00	46.7 AV	54.0	-7.3	1.00 H	92	29.20	17.50

ANTENNA POLARITY & TEST DISTANCE: VERTICAL AT 3 M

NO.	FREQ. (MHz)	EMISSION LEVEL (dBuV/m)	LIMIT (dBuV/m)	MARGIN (dB)	ANTENNA HEIGHT (m)	TABLE ANGLE (Degree)	RAW VALUE (dBuV)	CORRECTION FACTOR (dB/m)
1	#5714.90	68.2 PK	74.0	-5.8	1.98 V	4	62.20	6.00
2	#5714.90	53.3 AV	54.0	-0.7	1.98 V	4	47.30	6.00
3	#5722.90	73.4 PK	78.2	-4.8	1.91 V	10	67.30	6.10
4	*5785.00	124.1 PK			1.95 V	5	83.80	40.30
5	*5785.00	113.6 AV			1.95 V	5	73.30	40.30
6	11570.00	60.9 PK	74.0	-13.1	1.30 V	60	43.40	17.50
7	11570.00	47.9 AV	54.0	-6.1	1.30 V	60	30.40	17.50

REMARKS:

1. Emission Level(dBuV/m) = Raw Value(dBuV) + Correction Factor(dB/m)
2. Correction Factor(dB/m) = Antenna Factor(dB/m) + Cable Factor(dB)
3. The other emission levels were very low against the limit.
4. Margin value = Emission Level – Limit value
5. " * ": Fundamental frequency.

CHANNEL	TX Channel 165	DETECTOR FUNCTION	Peak (PK)
FREQUENCY RANGE	1GHz ~ 40GHz		Average (AV)

ANTENNA POLARITY & TEST DISTANCE: HORIZONTAL AT 3 M

NO.	FREQ. (MHz)	EMISSION LEVEL (dBuV/m)	LIMIT (dBuV/m)	MARGIN (dB)	ANTENNA HEIGHT (m)	TABLE ANGLE (Degree)	RAW VALUE (dBuV)	CORRECTION FACTOR (dB/m)
1	*5825.00	116.9 PK			1.19 H	63	76.50	40.40
2	*5825.00	107.1 AV			1.19 H	63	66.70	40.40
3	#5850.00	56.8 PK	78.2	-21.4	1.15 H	68	50.40	6.40
4	#5852.10	72.3 PK	78.2	-5.9	1.15 H	68	65.90	6.40
5	#5860.10	67.9 PK	74.0	-6.1	1.15 H	68	61.50	6.40
6	#5860.10	49.9 AV	54.0	-4.1	1.15 H	68	43.50	6.40
7	11650.00	59.1 PK	74.0	-14.9	1.00 H	53	41.80	17.30
8	11650.00	46.3 AV	54.0	-7.7	1.00 H	53	29.00	17.30

ANTENNA POLARITY & TEST DISTANCE: VERTICAL AT 3 M

NO.	FREQ. (MHz)	EMISSION LEVEL (dBuV/m)	LIMIT (dBuV/m)	MARGIN (dB)	ANTENNA HEIGHT (m)	TABLE ANGLE (Degree)	RAW VALUE (dBuV)	CORRECTION FACTOR (dB/m)
1	*5825.00	119.8 PK			2.11 V	3	79.40	40.40
2	*5825.00	110.0 AV			2.11 V	3	69.60	40.40
3	#5850.00	64.0 PK	78.2	-14.2	1.60 V	7	57.60	6.40
4	#5852.10	73.4 PK	78.2	-4.8	1.60 V	7	67.00	6.40
5	#5860.10	69.4 PK	74.0	-4.6	1.60 V	1	63.00	6.40
6	#5860.10	53.9 AV	54.0	-0.1	1.60 V	1	47.50	6.40
7	11650.00	60.3 PK	74.0	-13.7	1.33 V	61	43.00	17.30
8	11650.00	47.6 AV	54.0	-6.4	1.33 V	61	30.30	17.30

REMARKS:

1. Emission Level(dBuV/m) = Raw Value(dBuV) + Correction Factor(dB/m)
2. Correction Factor(dB/m) = Antenna Factor(dB/m) + Cable Factor(dB)
3. The other emission levels were very low against the limit.
4. Margin value = Emission Level – Limit value
5. " * ": Fundamental frequency.
6. " # ": The radiated frequency is out of the restricted band.

802.11n (HT20)

CHANNEL	TX Channel 36	DETECTOR FUNCTION	Peak (PK)
FREQUENCY RANGE	1GHz ~ 40GHz		Average (AV)

ANTENNA POLARITY & TEST DISTANCE: HORIZONTAL AT 3 M

NO.	FREQ. (MHz)	EMISSION LEVEL (dBuV/m)	LIMIT (dBuV/m)	MARGIN (dB)	ANTENNA HEIGHT (m)	TABLE ANGLE (Degree)	RAW VALUE (dBuV)	CORRECTION FACTOR (dB/m)
1	5150.00	57.8 PK	74.0	-16.2	1.65 H	45	52.80	5.00
2	5150.00	45.8 AV	54.0	-8.2	1.65 H	45	40.80	5.00
3	*5180.00	115.2 PK			1.70 H	42	76.10	39.10
4	*5180.00	105.3 AV			1.70 H	42	66.20	39.10
5	#10360.00	58.7 PK	74.0	-15.3	1.00 H	70	41.60	17.10
6	#10360.00	46.5 AV	54.0	-7.5	1.00 H	70	29.40	17.10

ANTENNA POLARITY & TEST DISTANCE: VERTICAL AT 3 M

NO.	FREQ. (MHz)	EMISSION LEVEL (dBuV/m)	LIMIT (dBuV/m)	MARGIN (dB)	ANTENNA HEIGHT (m)	TABLE ANGLE (Degree)	RAW VALUE (dBuV)	CORRECTION FACTOR (dB/m)
1	5150.00	69.1 PK	74.0	-4.9	1.90 V	14	64.10	5.00
2	5150.00	53.0 AV	54.0	-1.0	1.90 V	14	48.00	5.00
3	*5180.00	118.4 PK			1.98 V	8	79.30	39.10
4	*5180.00	109.7 AV			1.98 V	8	70.60	39.10
5	#10360.00	60.2 PK	74.0	-13.8	1.31 V	91	43.10	17.10
6	#10360.00	46.6 AV	54.0	-7.4	1.31 V	91	29.50	17.10

REMARKS:

1. Emission Level(dBuV/m) = Raw Value(dBuV) + Correction Factor(dB/m)
2. Correction Factor(dB/m) = Antenna Factor(dB/m) + Cable Factor(dB)
3. The other emission levels were very low against the limit.
4. Margin value = Emission Level – Limit value
5. " * ": Fundamental frequency.
6. " # ": The radiated frequency is out of the restricted band.

CHANNEL	TX Channel 40	DETECTOR FUNCTION	Peak (PK)
FREQUENCY RANGE	1GHz ~ 40GHz		Average (AV)

ANTENNA POLARITY & TEST DISTANCE: HORIZONTAL AT 3 M

NO.	FREQ. (MHz)	EMISSION LEVEL (dBuV/m)	LIMIT (dBuV/m)	MARGIN (dB)	ANTENNA HEIGHT (m)	TABLE ANGLE (Degree)	RAW VALUE (dBuV)	CORRECTION FACTOR (dB/m)
1	5150.00	68.5 PK	74.0	-5.5	1.76 H	65	63.50	5.00
2	5150.00	48.3 AV	54.0	-5.7	1.76 H	65	43.30	5.00
3	*5200.00	118.2 PK			1.72 H	62	79.00	39.20
4	*5200.00	107.5 AV			1.72 H	62	68.30	39.20
5	#10400.00	59.2 PK	74.0	-14.8	1.00 H	81	41.90	17.30
6	#10400.00	47.2 AV	54.0	-6.8	1.00 H	81	29.90	17.30

ANTENNA POLARITY & TEST DISTANCE: VERTICAL AT 3 M

NO.	FREQ. (MHz)	EMISSION LEVEL (dBuV/m)	LIMIT (dBuV/m)	MARGIN (dB)	ANTENNA HEIGHT (m)	TABLE ANGLE (Degree)	RAW VALUE (dBuV)	CORRECTION FACTOR (dB/m)
1	5150.00	73.9 PK	74.0	-0.1	1.57 V	14	68.90	5.00
2	5150.00	51.5 AV	54.0	-2.5	1.57 V	14	46.50	5.00
3	*5200.00	121.8 PK			1.21 V	10	82.60	39.20
4	*5200.00	112.4 AV			1.21 V	10	73.20	39.20
5	#10400.00	60.4 PK	74.0	-13.6	1.34 V	98	43.10	17.30
6	#10400.00	47.6 AV	54.0	-6.4	1.34 V	98	30.30	17.30

REMARKS:

1. Emission Level(dBuV/m) = Raw Value(dBuV) + Correction Factor(dB/m)
2. Correction Factor(dB/m) = Antenna Factor(dB/m) + Cable Factor(dB)
3. The other emission levels were very low against the limit.
4. Margin value = Emission Level – Limit value
5. " * ": Fundamental frequency.
6. " # ": The radiated frequency is out of the restricted band.

CHANNEL	TX Channel 48	DETECTOR FUNCTION	Peak (PK)
FREQUENCY RANGE	1GHz ~ 40GHz		Average (AV)

ANTENNA POLARITY & TEST DISTANCE: HORIZONTAL AT 3 M

NO.	FREQ. (MHz)	EMISSION LEVEL (dBuV/m)	LIMIT (dBuV/m)	MARGIN (dB)	ANTENNA HEIGHT (m)	TABLE ANGLE (Degree)	RAW VALUE (dBuV)	CORRECTION FACTOR (dB/m)
1	*5240.00	121.3 PK			1.56 H	58	82.10	39.20
2	*5240.00	111.0 AV			1.56 H	58	71.80	39.20
3	5350.00	59.5 PK	74.0	-14.5	1.57 H	52	54.10	5.40
4	5350.00	46.5 AV	54.0	-7.5	1.57 H	52	41.10	5.40
5	#10480.00	59.4 PK	74.0	-14.6	1.00 H	89	42.10	17.30
6	#10480.00	47.1 AV	54.0	-6.9	1.00 H	89	29.80	17.30

ANTENNA POLARITY & TEST DISTANCE: VERTICAL AT 3 M

NO.	FREQ. (MHz)	EMISSION LEVEL (dBuV/m)	LIMIT (dBuV/m)	MARGIN (dB)	ANTENNA HEIGHT (m)	TABLE ANGLE (Degree)	RAW VALUE (dBuV)	CORRECTION FACTOR (dB/m)
1	*5240.00	124.8 PK			1.19 V	19	85.60	39.20
2	*5240.00	114.3 AV			1.19 V	19	75.10	39.20
3	5350.00	68.7 PK	74.0	-5.3	1.18 V	16	63.30	5.40
4	5350.00	49.6 AV	54.0	-4.4	1.18 V	16	44.20	5.40
5	#10480.00	60.4 PK	74.0	-13.6	1.22 V	84	43.10	17.30
6	#10480.00	47.4 AV	54.0	-6.6	1.22 V	84	30.10	17.30

REMARKS:

1. Emission Level(dBuV/m) = Raw Value(dBuV) + Correction Factor(dB/m)
2. Correction Factor(dB/m) = Antenna Factor(dB/m) + Cable Factor(dB)
3. The other emission levels were very low against the limit.
4. Margin value = Emission Level – Limit value
5. " * ": Fundamental frequency.
6. " # ": The radiated frequency is out of the restricted band.

CHANNEL	TX Channel 149	DETECTOR FUNCTION	Peak (PK)
FREQUENCY RANGE	1GHz ~ 40GHz		Average (AV)

ANTENNA POLARITY & TEST DISTANCE: HORIZONTAL AT 3 M

NO.	FREQ. (MHz)	EMISSION LEVEL (dBuV/m)	LIMIT (dBuV/m)	MARGIN (dB)	ANTENNA HEIGHT (m)	TABLE ANGLE (Degree)	RAW VALUE (dBuV)	CORRECTION FACTOR (dB/m)
1	#5660.00	57.8 PK	74.0	-16.2	1.31 H	50	51.80	6.00
2	#5660.00	45.8 AV	54.0	-8.2	1.31 H	50	39.80	6.00
3	#5722.90	72.3 PK	78.2	-5.9	1.31 H	50	66.20	6.10
4	#5725.00	58.8 PK	78.2	-19.4	1.31 H	50	52.70	6.10
5	*5745.00	112.0 PK			1.32 H	58	71.70	40.30
6	*5745.00	102.8 AV			1.32 H	58	62.50	40.30
7	11490.00	58.8 PK	74.0	-15.2	1.00 H	91	41.20	17.60
8	11490.00	45.3 AV	54.0	-8.7	1.00 H	91	27.70	17.60

ANTENNA POLARITY & TEST DISTANCE: VERTICAL AT 3 M

NO.	FREQ. (MHz)	EMISSION LEVEL (dBuV/m)	LIMIT (dBuV/m)	MARGIN (dB)	ANTENNA HEIGHT (m)	TABLE ANGLE (Degree)	RAW VALUE (dBuV)	CORRECTION FACTOR (dB/m)
1	#5660.00	61.5 PK	74.0	-12.5	2.12 V	6	55.50	6.00
2	#5660.00	48.6 AV	54.0	-5.4	2.12 V	6	42.60	6.00
3	#5722.90	77.4 PK	78.2	-0.8	2.16 V	6	71.30	6.10
4	#5725.00	63.2 PK	78.2	-15.0	2.16 V	6	57.10	6.10
5	*5745.00	115.2 PK			1.78 V	7	74.90	40.30
6	*5745.00	105.5 AV			1.78 V	7	65.20	40.30
7	11490.00	59.7 PK	74.0	-14.3	1.34 V	68	42.10	17.60
8	11490.00	47.0 AV	54.0	-7.0	1.34 V	68	29.40	17.60

REMARKS:

1. Emission Level(dBuV/m) = Raw Value(dBuV) + Correction Factor(dB/m)
2. Correction Factor(dB/m) = Antenna Factor(dB/m) + Cable Factor(dB)
3. The other emission levels were very low against the limit.
4. Margin value = Emission Level – Limit value
5. " * ": Fundamental frequency.
6. " # ": The radiated frequency is out of the restricted band.



CHANNEL	TX Channel 157	DETECTOR FUNCTION	Peak (PK)
FREQUENCY RANGE	1GHz ~ 40GHz		Average (AV)

ANTENNA POLARITY & TEST DISTANCE: HORIZONTAL AT 3 M

NO.	FREQ. (MHz)	EMISSION LEVEL (dBuV/m)	LIMIT (dBuV/m)	MARGIN (dB)	ANTENNA HEIGHT (m)	TABLE ANGLE (Degree)	RAW VALUE (dBuV)	CORRECTION FACTOR (dB/m)
1	#5714.90	66.0 PK	74.0	-8.0	2.39 H	63	60.00	6.00
2	#5714.90	49.7 AV	54.0	-4.3	2.39 H	63	43.70	6.00
3	#5722.90	66.1 PK	78.2	-12.1	2.39 H	63	60.00	6.10
4	*5785.00	117.6 PK			2.33 H	69	77.30	40.30
5	*5785.00	108.1 AV			2.33 H	69	67.80	40.30
6	11570.00	59.3 PK	74.0	-14.7	1.00 H	92	41.80	17.50
7	11570.00	46.5 AV	54.0	-7.5	1.00 H	92	29.00	17.50

ANTENNA POLARITY & TEST DISTANCE: VERTICAL AT 3 M

NO.	FREQ. (MHz)	EMISSION LEVEL (dBuV/m)	LIMIT (dBuV/m)	MARGIN (dB)	ANTENNA HEIGHT (m)	TABLE ANGLE (Degree)	RAW VALUE (dBuV)	CORRECTION FACTOR (dB/m)
1	#5714.90	68.8 PK	74.0	-5.2	1.73 V	11	62.80	6.00
2	#5714.90	52.6 AV	54.0	-1.4	1.73 V	11	46.60	6.00
3	#5722.90	74.8 PK	78.2	-3.4	1.73 V	18	68.70	6.10
4	*5785.00	121.0 PK			2.15 V	9	80.70	40.30
5	*5785.00	110.8 AV			2.15 V	9	70.50	40.30
6	11570.00	60.1 PK	74.0	-13.9	1.35 V	61	42.60	17.50
7	11570.00	47.5 AV	54.0	-6.5	1.35 V	61	30.00	17.50

REMARKS:

1. Emission Level(dBuV/m) = Raw Value(dBuV) + Correction Factor(dB/m)
2. Correction Factor(dB/m) = Antenna Factor(dB/m) + Cable Factor(dB)
3. The other emission levels were very low against the limit.
4. Margin value = Emission Level – Limit value
5. " * ": Fundamental frequency.

CHANNEL	TX Channel 165	DETECTOR FUNCTION	Peak (PK)
FREQUENCY RANGE	1GHz ~ 40GHz		Average (AV)

ANTENNA POLARITY & TEST DISTANCE: HORIZONTAL AT 3 M

NO.	FREQ. (MHz)	EMISSION LEVEL (dBuV/m)	LIMIT (dBuV/m)	MARGIN (dB)	ANTENNA HEIGHT (m)	TABLE ANGLE (Degree)	RAW VALUE (dBuV)	CORRECTION FACTOR (dB/m)
1	*5825.00	115.3 PK			1.63 H	63	74.90	40.40
2	*5825.00	105.6 AV			1.63 H	63	65.20	40.40
3	#5850.00	65.1 PK	78.2	-13.1	1.64 H	64	58.70	6.40
4	#5852.10	72.6 PK	78.2	-5.6	1.64 H	64	66.20	6.40
5	#5860.10	68.2 PK	74.0	-5.8	1.64 H	64	61.80	6.40
6	#5860.10	49.1 AV	54.0	-4.9	1.64 H	64	42.70	6.40
7	11650.00	59.2 PK	74.0	-14.8	1.00 H	58	41.90	17.30
8	11650.00	46.1 AV	54.0	-7.9	1.00 H	58	28.80	17.30

ANTENNA POLARITY & TEST DISTANCE: VERTICAL AT 3 M

NO.	FREQ. (MHz)	EMISSION LEVEL (dBuV/m)	LIMIT (dBuV/m)	MARGIN (dB)	ANTENNA HEIGHT (m)	TABLE ANGLE (Degree)	RAW VALUE (dBuV)	CORRECTION FACTOR (dB/m)
1	*5825.00	117.6 PK			2.14 V	2	77.20	40.40
2	*5825.00	108.0 AV			2.14 V	2	67.60	40.40
3	#5850.00	69.4 PK	78.2	-8.8	2.25 V	355	63.00	6.40
4	#5852.10	73.6 PK	78.2	-4.6	2.25 V	355	67.20	6.40
5	#5860.10	70.0 PK	74.0	-4.0	2.22 V	357	63.60	6.40
6	#5860.10	53.1 AV	54.0	-0.9	2.22 V	357	46.70	6.40
7	11650.00	59.9 PK	74.0	-14.1	1.30 V	60	42.60	17.30
8	11650.00	47.3 AV	54.0	-6.7	1.30 V	60	30.00	17.30

REMARKS:

1. Emission Level(dBuV/m) = Raw Value(dBuV) + Correction Factor(dB/m)
2. Correction Factor(dB/m) = Antenna Factor(dB/m) + Cable Factor(dB)
3. The other emission levels were very low against the limit.
4. Margin value = Emission Level – Limit value
5. " * ": Fundamental frequency.
6. " # ": The radiated frequency is out of the restricted band.

802.11n (HT40)

CHANNEL	TX Channel 38	DETECTOR FUNCTION	Peak (PK)
FREQUENCY RANGE	1GHz ~ 40GHz		Average (AV)

ANTENNA POLARITY & TEST DISTANCE: HORIZONTAL AT 3 M

NO.	FREQ. (MHz)	EMISSION LEVEL (dBuV/m)	LIMIT (dBuV/m)	MARGIN (dB)	ANTENNA HEIGHT (m)	TABLE ANGLE (Degree)	RAW VALUE (dBuV)	CORRECTION FACTOR (dB/m)
1	5150.00	69.9 PK	74.0	-4.1	1.77 H	55	64.90	5.00
2	5150.00	47.2 AV	54.0	-6.8	1.77 H	55	42.20	5.00
3	*5190.00	109.8 PK			1.73 H	59	70.70	39.10
4	*5190.00	99.6 AV			1.73 H	59	60.50	39.10
5	#10380.00	58.5 PK	74.0	-15.5	1.00 H	82	41.30	17.20
6	#10380.00	44.5 AV	54.0	-9.5	1.00 H	82	27.30	17.20

ANTENNA POLARITY & TEST DISTANCE: VERTICAL AT 3 M

NO.	FREQ. (MHz)	EMISSION LEVEL (dBuV/m)	LIMIT (dBuV/m)	MARGIN (dB)	ANTENNA HEIGHT (m)	TABLE ANGLE (Degree)	RAW VALUE (dBuV)	CORRECTION FACTOR (dB/m)
1	5150.00	71.6 PK	74.0	-2.4	2.06 V	5	66.60	5.00
2	5150.00	53.7 AV	54.0	-0.3	2.06 V	5	48.70	5.00
3	*5190.00	114.5 PK			2.04 V	3	75.40	39.10
4	*5190.00	104.6 AV			2.04 V	3	65.50	39.10
5	#10380.00	59.9 PK	74.0	-14.1	1.31 V	91	42.70	17.20
6	#10380.00	45.1 AV	54.0	-8.9	1.31 V	91	27.90	17.20

REMARKS:

1. Emission Level(dBuV/m) = Raw Value(dBuV) + Correction Factor(dB/m)
2. Correction Factor(dB/m) = Antenna Factor(dB/m) + Cable Factor(dB)
3. The other emission levels were very low against the limit.
4. Margin value = Emission Level – Limit value
5. " * ": Fundamental frequency.
6. " # ": The radiated frequency is out of the restricted band.



CHANNEL	TX Channel 46	DETECTOR FUNCTION	Peak (PK)
FREQUENCY RANGE	1GHz ~ 40GHz		Average (AV)

ANTENNA POLARITY & TEST DISTANCE: HORIZONTAL AT 3 M								
NO.	FREQ. (MHz)	EMISSION LEVEL (dBuV/m)	LIMIT (dBuV/m)	MARGIN (dB)	ANTENNA HEIGHT (m)	TABLE ANGLE (Degree)	RAW VALUE (dBuV)	CORRECTION FACTOR (dB/m)
1	5150.00	64.5 PK	74.0	-9.5	1.55 H	51	59.50	5.00
2	5150.00	47.4 AV	54.0	-6.6	1.55 H	51	42.40	5.00
3	*5230.00	116.0 PK			1.56 H	59	76.80	39.20
4	*5230.00	105.4 AV			1.56 H	59	66.20	39.20
5	#10460.00	58.6 PK	74.0	-15.4	1.00 H	66	41.40	17.20
6	#10460.00	45.9 AV	54.0	-8.1	1.00 H	66	28.70	17.20

ANTENNA POLARITY & TEST DISTANCE: VERTICAL AT 3 M								
NO.	FREQ. (MHz)	EMISSION LEVEL (dBuV/m)	LIMIT (dBuV/m)	MARGIN (dB)	ANTENNA HEIGHT (m)	TABLE ANGLE (Degree)	RAW VALUE (dBuV)	CORRECTION FACTOR (dB/m)
1	5150.00	71.5 PK	74.0	-2.5	2.01 V	358	66.50	5.00
2	5150.00	53.4 AV	54.0	-0.6	2.01 V	358	48.40	5.00
3	*5230.00	117.2 PK			1.11 V	16	78.00	39.20
4	*5230.00	106.4 AV			1.11 V	16	67.20	39.20
5	#10460.00	59.9 PK	74.0	-14.1	1.30 V	96	42.70	17.20
6	#10460.00	46.0 AV	54.0	-8.0	1.30 V	96	28.80	17.20

REMARKS:

1. Emission Level(dBuV/m) = Raw Value(dBuV) + Correction Factor(dB/m)
2. Correction Factor(dB/m) = Antenna Factor(dB/m) + Cable Factor(dB)
3. The other emission levels were very low against the limit.
4. Margin value = Emission Level – Limit value
5. " * ": Fundamental frequency.
6. " # ": The radiated frequency is out of the restricted band.

CHANNEL	TX Channel 151	DETECTOR FUNCTION	Peak (PK)
FREQUENCY RANGE	1GHz ~ 40GHz		Average (AV)

ANTENNA POLARITY & TEST DISTANCE: HORIZONTAL AT 3 M

NO.	FREQ. (MHz)	EMISSION LEVEL (dBuV/m)	LIMIT (dBuV/m)	MARGIN (dB)	ANTENNA HEIGHT (m)	TABLE ANGLE (Degree)	RAW VALUE (dBuV)	CORRECTION FACTOR (dB/m)
1	#5714.90	63.0 PK	74.0	-11.0	2.30 H	68	57.00	6.00
2	#5714.90	46.5 AV	54.0	-7.5	2.30 H	68	40.50	6.00
3	#5722.90	70.3 PK	78.2	-7.9	2.30 H	68	64.20	6.10
4	#5725.00	60.2 PK	78.2	-18.0	2.30 H	68	54.10	6.10
5	*5755.00	109.5 PK			2.33 H	66	69.20	40.30
6	*5755.00	99.9 AV			2.33 H	66	59.60	40.30
7	11510.00	58.4 PK	74.0	-15.6	1.00 H	88	41.00	17.40
8	11510.00	44.8 AV	54.0	-9.2	1.00 H	88	27.40	17.40

ANTENNA POLARITY & TEST DISTANCE: VERTICAL AT 3 M

NO.	FREQ. (MHz)	EMISSION LEVEL (dBuV/m)	LIMIT (dBuV/m)	MARGIN (dB)	ANTENNA HEIGHT (m)	TABLE ANGLE (Degree)	RAW VALUE (dBuV)	CORRECTION FACTOR (dB/m)
1	#5714.90	68.2 PK	74.0	-5.8	1.82 V	9	62.20	6.00
2	#5714.90	53.6 AV	54.0	-0.4	1.82 V	9	47.60	6.00
3	#5722.90	76.5 PK	78.2	-1.7	1.82 V	9	70.40	6.10
4	#5725.00	60.8 PK	78.2	-17.4	1.82 V	9	54.70	6.10
5	*5755.00	112.1 PK			1.86 V	7	71.80	40.30
6	*5755.00	102.3 AV			1.86 V	7	62.00	40.30
7	11510.00	59.3 PK	74.0	-14.7	1.31 V	67	41.90	17.40
8	11510.00	46.5 AV	54.0	-7.5	1.31 V	67	29.10	17.40

REMARKS:

1. Emission Level(dBuV/m) = Raw Value(dBuV) + Correction Factor(dB/m)
2. Correction Factor(dB/m) = Antenna Factor(dB/m) + Cable Factor(dB)
3. The other emission levels were very low against the limit.
4. Margin value = Emission Level – Limit value
5. " * ": Fundamental frequency.
6. " # ": The radiated frequency is out of the restricted band.

CHANNEL	TX Channel 159	DETECTOR FUNCTION	Peak (PK)
FREQUENCY RANGE	1GHz ~ 40GHz		Average (AV)

ANTENNA POLARITY & TEST DISTANCE: HORIZONTAL AT 3 M

NO.	FREQ. (MHz)	EMISSION LEVEL (dBuV/m)	LIMIT (dBuV/m)	MARGIN (dB)	ANTENNA HEIGHT (m)	TABLE ANGLE (Degree)	RAW VALUE (dBuV)	CORRECTION FACTOR (dB/m)
1	*5795.00	112.4 PK			2.25 H	74	72.10	40.30
2	*5795.00	102.8 AV			2.25 H	74	62.50	40.30
3	#5850.00	58.4 PK	78.2	-19.8	2.25 H	79	52.00	6.40
4	#5852.10	71.7 PK	78.2	-6.5	2.25 H	79	65.30	6.40
5	#5860.10	65.1 PK	74.0	-8.9	2.25 H	79	58.70	6.40
6	#5860.10	49.0 AV	54.0	-5.0	2.25 H	79	42.60	6.40
7	11590.00	58.6 PK	74.0	-15.4	1.00 H	54	41.30	17.30
8	11590.00	46.0 AV	54.0	-8.0	1.00 H	54	28.70	17.30

ANTENNA POLARITY & TEST DISTANCE: VERTICAL AT 3 M

NO.	FREQ. (MHz)	EMISSION LEVEL (dBuV/m)	LIMIT (dBuV/m)	MARGIN (dB)	ANTENNA HEIGHT (m)	TABLE ANGLE (Degree)	RAW VALUE (dBuV)	CORRECTION FACTOR (dB/m)
1	*5795.00	115.2 PK			2.13 V	9	74.90	40.30
2	*5795.00	105.9 AV			2.13 V	9	65.60	40.30
3	#5850.00	65.9 PK	78.2	-12.3	1.60 V	15	59.50	6.40
4	#5852.10	77.1 PK	78.2	-1.1	1.60 V	15	70.70	6.40
5	#5860.10	73.5 PK	74.0	-0.5	1.68 V	12	67.10	6.40
6	#5860.10	53.5 AV	54.0	-0.5	1.68 V	12	47.10	6.40
7	11590.00	59.7 PK	74.0	-14.3	1.35 V	65	42.40	17.30
8	11590.00	47.1 AV	54.0	-6.9	1.35 V	65	29.80	17.30

REMARKS:

1. Emission Level(dBuV/m) = Raw Value(dBuV) + Correction Factor(dB/m)
2. Correction Factor(dB/m) = Antenna Factor(dB/m) + Cable Factor(dB)
3. The other emission levels were very low against the limit.
4. Margin value = Emission Level – Limit value
5. " * ": Fundamental frequency.
6. " # ": The radiated frequency is out of the restricted band.

802.11ac (VHT80)

CHANNEL	TX Channel 42	DETECTOR FUNCTION	Peak (PK)
FREQUENCY RANGE	1GHz ~ 40GHz		Average (AV)

ANTENNA POLARITY & TEST DISTANCE: HORIZONTAL AT 3 M								
NO.	FREQ. (MHz)	EMISSION LEVEL (dBuV/m)	LIMIT (dBuV/m)	MARGIN (dB)	ANTENNA HEIGHT (m)	TABLE ANGLE (Degree)	RAW VALUE (dBuV)	CORRECTION FACTOR (dB/m)
1	5150.00	72.9 PK	74.0	-1.1	1.55 H	56	67.90	5.00
2	5150.00	45.2 AV	54.0	-8.8	1.55 H	56	40.20	5.00
3	*5210.00	106.7 PK			1.56 H	59	67.50	39.20
4	*5210.00	96.6 AV			1.56 H	59	57.40	39.20
5	#10420.00	58.3 PK	74.0	-15.7	1.00 H	81	41.00	17.30
6	#10420.00	44.2 AV	54.0	-9.8	1.00 H	81	26.90	17.30

ANTENNA POLARITY & TEST DISTANCE: VERTICAL AT 3 M								
NO.	FREQ. (MHz)	EMISSION LEVEL (dBuV/m)	LIMIT (dBuV/m)	MARGIN (dB)	ANTENNA HEIGHT (m)	TABLE ANGLE (Degree)	RAW VALUE (dBuV)	CORRECTION FACTOR (dB/m)
1	5150.00	73.6 PK	74.0	-0.4	1.59 V	340	68.60	5.00
2	5150.00	48.2 AV	54.0	-5.8	1.59 V	340	43.20	5.00
3	*5210.00	107.1 PK			1.11 V	18	67.90	39.20
4	*5210.00	97.1 AV			1.11 V	18	57.90	39.20
5	#10420.00	59.8 PK	74.0	-14.2	1.27 V	97	42.50	17.30
6	#10420.00	45.0 AV	54.0	-9.0	1.27 V	97	27.70	17.30

REMARKS:

1. Emission Level(dBuV/m) = Raw Value(dBuV) + Correction Factor(dB/m)
2. Correction Factor(dB/m) = Antenna Factor(dB/m) + Cable Factor(dB)
3. The other emission levels were very low against the limit.
4. Margin value = Emission Level – Limit value
5. " * ": Fundamental frequency.
6. " # ": The radiated frequency is out of the restricted band.

CHANNEL	TX Channel 155	DETECTOR FUNCTION	Peak (PK)
FREQUENCY RANGE	1GHz ~ 40GHz		Average (AV)

ANTENNA POLARITY & TEST DISTANCE: HORIZONTAL AT 3 M

NO.	FREQ. (MHz)	EMISSION LEVEL (dBuV/m)	LIMIT (dBuV/m)	MARGIN (dB)	ANTENNA HEIGHT (m)	TABLE ANGLE (Degree)	RAW VALUE (dBuV)	CORRECTION FACTOR (dB/m)
1	#5714.90	68.6 PK	74.0	-5.4	2.11 H	61	62.60	6.00
2	#5714.90	47.9 AV	54.0	-6.1	2.11 H	61	41.90	6.00
3	#5722.90	74.3 PK	78.2	-3.9	2.11 H	61	68.20	6.10
4	#5725.00	58.6 PK	78.2	-19.6	2.11 H	61	52.50	6.10
5	*5775.00	104.7 PK			2.16 H	6	64.40	40.30
6	*5775.00	94.4 AV			2.16 H	6	54.10	40.30
7	11550.00	57.8 PK	74.0	-16.2	1.00 H	82	40.40	17.40
8	11550.00	44.5 AV	54.0	-9.5	1.00 H	82	27.10	17.40

ANTENNA POLARITY & TEST DISTANCE: VERTICAL AT 3 M

NO.	FREQ. (MHz)	EMISSION LEVEL (dBuV/m)	LIMIT (dBuV/m)	MARGIN (dB)	ANTENNA HEIGHT (m)	TABLE ANGLE (Degree)	RAW VALUE (dBuV)	CORRECTION FACTOR (dB/m)
1	#5714.90	72.6 PK	74.0	-1.4	1.92 V	2	66.60	6.00
2	#5714.90	53.5 AV	54.0	-0.5	1.92 V	2	47.50	6.00
3	#5722.90	75.6 PK	78.2	-2.6	1.92 V	2	69.50	6.10
4	#5725.00	62.2 PK	78.2	-16.0	1.92 V	2	56.10	6.10
5	*5775.00	107.8 PK			1.91 V	7	67.50	40.30
6	*5775.00	97.7 AV			1.91 V	7	57.40	40.30
7	11550.00	59.2 PK	74.0	-14.8	1.30 V	64	41.80	17.40
8	11550.00	46.4 AV	54.0	-7.6	1.30 V	64	29.00	17.40

REMARKS:

1. Emission Level(dBuV/m) = Raw Value(dBuV) + Correction Factor(dB/m)
2. Correction Factor(dB/m) = Antenna Factor(dB/m) + Cable Factor(dB)
3. The other emission levels were very low against the limit.
4. Margin value = Emission Level – Limit value
5. " * ": Fundamental frequency.

Test Mode B

4TX

802.11a

CHANNEL	TX Channel 36	DETECTOR FUNCTION	Peak (PK)
FREQUENCY RANGE	1GHz ~ 40GHz		Average (AV)

ANTENNA POLARITY & TEST DISTANCE: HORIZONTAL AT 3 M

NO.	FREQ. (MHz)	EMISSION LEVEL (dBuV/m)	LIMIT (dBuV/m)	MARGIN (dB)	ANTENNA HEIGHT (m)	TABLE ANGLE (Degree)	RAW VALUE (dBuV)	CORRECTION FACTOR (dB/m)
1	5150.00	62.3 PK	74.0	-11.7	1.96 H	54	57.30	5.00
2	5150.00	49.3 AV	54.0	-4.7	1.96 H	54	44.30	5.00
3	*5180.00	118.9 PK			1.94 H	54	79.80	39.10
4	*5180.00	109.4 AV			1.94 H	54	70.30	39.10
5	#10360.00	58.7 PK	74.0	-15.3	1.00 H	82	41.60	17.10
6	#10360.00	47.3 AV	54.0	-6.7	1.00 H	82	30.20	17.10

ANTENNA POLARITY & TEST DISTANCE: VERTICAL AT 3 M

NO.	FREQ. (MHz)	EMISSION LEVEL (dBuV/m)	LIMIT (dBuV/m)	MARGIN (dB)	ANTENNA HEIGHT (m)	TABLE ANGLE (Degree)	RAW VALUE (dBuV)	CORRECTION FACTOR (dB/m)
1	5150.00	70.0 PK	74.0	-4.0	1.00 V	14	65.00	5.00
2	5150.00	53.4 AV	54.0	-0.6	1.00 V	14	48.40	5.00
3	*5180.00	121.0 PK			1.21 V	9	81.90	39.10
4	*5180.00	111.4 AV			1.21 V	9	72.30	39.10
5	#10360.00	60.1 PK	74.0	-13.9	1.26 V	90	43.00	17.10
6	#10360.00	47.5 AV	54.0	-6.5	1.26 V	90	30.40	17.10

REMARKS:

1. Emission Level(dBuV/m) = Raw Value(dBuV) + Correction Factor(dB/m)
2. Correction Factor(dB/m) = Antenna Factor(dB/m) + Cable Factor(dB)
3. The other emission levels were very low against the limit.
4. Margin value = Emission Level – Limit value
5. " * ": Fundamental frequency.
6. " # ": The radiated frequency is out of the restricted band.

CHANNEL	TX Channel 40	DETECTOR FUNCTION	Peak (PK)
FREQUENCY RANGE	1GHz ~ 40GHz		Average (AV)

ANTENNA POLARITY & TEST DISTANCE: HORIZONTAL AT 3 M

NO.	FREQ. (MHz)	EMISSION LEVEL (dBuV/m)	LIMIT (dBuV/m)	MARGIN (dB)	ANTENNA HEIGHT (m)	TABLE ANGLE (Degree)	RAW VALUE (dBuV)	CORRECTION FACTOR (dB/m)
1	5150.00	62.2 PK	74.0	-11.8	1.85 H	52	57.20	5.00
2	5150.00	48.7 AV	54.0	-5.3	1.85 H	52	43.70	5.00
3	*5200.00	121.9 PK			1.89 H	56	82.70	39.20
4	*5200.00	111.7 AV			1.89 H	56	72.50	39.20
5	#10400.00	59.6 PK	74.0	-14.4	1.00 H	87	42.30	17.30
6	#10400.00	47.7 AV	54.0	-6.3	1.00 H	87	30.40	17.30

ANTENNA POLARITY & TEST DISTANCE: VERTICAL AT 3 M

NO.	FREQ. (MHz)	EMISSION LEVEL (dBuV/m)	LIMIT (dBuV/m)	MARGIN (dB)	ANTENNA HEIGHT (m)	TABLE ANGLE (Degree)	RAW VALUE (dBuV)	CORRECTION FACTOR (dB/m)
1	5150.00	70.6 PK	74.0	-3.4	2.59 V	12	65.60	5.00
2	5150.00	53.8 AV	54.0	-0.2	2.59 V	12	48.80	5.00
3	*5200.00	123.9 PK			1.28 V	8	84.70	39.20
4	*5200.00	114.1 AV			1.28 V	8	74.90	39.20
5	#10400.00	60.6 PK	74.0	-13.4	1.30 V	89	43.30	17.30
6	#10400.00	48.0 AV	54.0	-6.0	1.30 V	89	30.70	17.30

REMARKS:

1. Emission Level(dBuV/m) = Raw Value(dBuV) + Correction Factor(dB/m)
2. Correction Factor(dB/m) = Antenna Factor(dB/m) + Cable Factor(dB)
3. The other emission levels were very low against the limit.
4. Margin value = Emission Level – Limit value
5. " * ": Fundamental frequency.
6. " # ": The radiated frequency is out of the restricted band.

CHANNEL	TX Channel 48	DETECTOR FUNCTION	Peak (PK)
FREQUENCY RANGE	1GHz ~ 40GHz		Average (AV)

ANTENNA POLARITY & TEST DISTANCE: HORIZONTAL AT 3 M

NO.	FREQ. (MHz)	EMISSION LEVEL (dBuV/m)	LIMIT (dBuV/m)	MARGIN (dB)	ANTENNA HEIGHT (m)	TABLE ANGLE (Degree)	RAW VALUE (dBuV)	CORRECTION FACTOR (dB/m)
1	*5240.00	124.3 PK			2.07 H	56	85.10	39.20
2	*5240.00	113.5 AV			2.07 H	56	74.30	39.20
3	5350.00	59.7 PK	74.0	-14.3	2.05 H	56	54.30	5.40
4	5350.00	46.5 AV	54.0	-7.5	2.05 H	56	41.10	5.40
5	#10480.00	59.7 PK	74.0	-14.3	1.00 H	91	42.40	17.30
6	#10480.00	47.8 AV	54.0	-6.2	1.00 H	91	30.50	17.30

ANTENNA POLARITY & TEST DISTANCE: VERTICAL AT 3 M

NO.	FREQ. (MHz)	EMISSION LEVEL (dBuV/m)	LIMIT (dBuV/m)	MARGIN (dB)	ANTENNA HEIGHT (m)	TABLE ANGLE (Degree)	RAW VALUE (dBuV)	CORRECTION FACTOR (dB/m)
1	*5240.00	126.3 PK			1.41 V	8	87.10	39.20
2	*5240.00	115.9 AV			1.41 V	8	76.70	39.20
3	5350.00	64.4 PK	74.0	-9.6	1.40 V	301	59.00	5.40
4	5350.00	50.2 AV	54.0	-3.8	1.40 V	301	44.80	5.40
5	#10480.00	61.4 PK	74.0	-12.6	1.27 V	87	44.10	17.30
6	#10480.00	48.4 AV	54.0	-5.6	1.27 V	87	31.10	17.30

REMARKS:

1. Emission Level(dBuV/m) = Raw Value(dBuV) + Correction Factor(dB/m)
2. Correction Factor(dB/m) = Antenna Factor(dB/m) + Cable Factor(dB)
3. The other emission levels were very low against the limit.
4. Margin value = Emission Level – Limit value
5. " * ": Fundamental frequency.
6. " # ": The radiated frequency is out of the restricted band.

CHANNEL	TX Channel 149	DETECTOR FUNCTION	Peak (PK)
FREQUENCY RANGE	1GHz ~ 40GHz		Average (AV)

ANTENNA POLARITY & TEST DISTANCE: HORIZONTAL AT 3 M

NO.	FREQ. (MHz)	EMISSION LEVEL (dBuV/m)	LIMIT (dBuV/m)	MARGIN (dB)	ANTENNA HEIGHT (m)	TABLE ANGLE (Degree)	RAW VALUE (dBuV)	CORRECTION FACTOR (dB/m)
1	#5660.00	60.2 PK	74.0	-13.8	2.05 H	60	54.20	6.00
2	#5660.00	49.0 AV	54.0	-5.0	2.05 H	60	43.00	6.00
3	#5722.90	64.1 PK	78.2	-14.1	2.05 H	60	58.00	6.10
4	#5725.00	59.2 PK	78.2	-19.0	2.05 H	60	53.10	6.10
5	*5745.00	116.2 PK			2.10 H	67	75.90	40.30
6	*5745.00	106.6 AV			2.10 H	67	66.30	40.30
7	11490.00	59.1 PK	74.0	-14.9	1.00 H	85	41.50	17.60
8	11490.00	46.2 AV	54.0	-7.8	1.00 H	85	28.60	17.60

ANTENNA POLARITY & TEST DISTANCE: VERTICAL AT 3 M

NO.	FREQ. (MHz)	EMISSION LEVEL (dBuV/m)	LIMIT (dBuV/m)	MARGIN (dB)	ANTENNA HEIGHT (m)	TABLE ANGLE (Degree)	RAW VALUE (dBuV)	CORRECTION FACTOR (dB/m)
1	#5660.00	62.1 PK	74.0	-11.9	1.69 V	17	56.10	6.00
2	#5660.00	50.0 AV	54.0	-4.0	1.69 V	17	44.00	6.00
3	#5722.90	77.3 PK	78.2	-0.9	1.64 V	12	71.20	6.10
4	#5725.00	65.8 PK	78.2	-12.4	1.69 V	17	59.70	6.10
5	*5745.00	118.6 PK			1.62 V	359	78.30	40.30
6	*5745.00	108.7 AV			1.62 V	359	68.40	40.30
7	11490.00	60.4 PK	74.0	-13.6	1.32 V	80	42.80	17.60
8	11490.00	47.5 AV	54.0	-6.5	1.32 V	80	29.90	17.60

REMARKS:

1. Emission Level(dBuV/m) = Raw Value(dBuV) + Correction Factor(dB/m)
2. Correction Factor(dB/m) = Antenna Factor(dB/m) + Cable Factor(dB)
3. The other emission levels were very low against the limit.
4. Margin value = Emission Level – Limit value
5. " * ": Fundamental frequency.
6. " # ": The radiated frequency is out of the restricted band.

CHANNEL	TX Channel 157	DETECTOR FUNCTION	Peak (PK)
FREQUENCY RANGE	1GHz ~ 40GHz		Average (AV)

ANTENNA POLARITY & TEST DISTANCE: HORIZONTAL AT 3 M

NO.	FREQ. (MHz)	EMISSION LEVEL (dBuV/m)	LIMIT (dBuV/m)	MARGIN (dB)	ANTENNA HEIGHT (m)	TABLE ANGLE (Degree)	RAW VALUE (dBuV)	CORRECTION FACTOR (dB/m)
1	#5714.90	62.9 PK	74.0	-11.1	1.93 H	60	56.90	6.00
2	#5714.90	49.3 AV	54.0	-4.7	1.93 H	60	43.30	6.00
3	#5722.90	64.7 PK	78.2	-13.5	1.93 H	60	58.60	6.10
4	*5785.00	121.8 PK			1.94 H	67	81.50	40.30
5	*5785.00	111.5 AV			1.94 H	67	71.20	40.30
6	11570.00	59.6 PK	74.0	-14.4	1.00 H	93	42.10	17.50
7	11570.00	47.3 AV	54.0	-6.7	1.00 H	93	29.80	17.50

ANTENNA POLARITY & TEST DISTANCE: VERTICAL AT 3 M

NO.	FREQ. (MHz)	EMISSION LEVEL (dBuV/m)	LIMIT (dBuV/m)	MARGIN (dB)	ANTENNA HEIGHT (m)	TABLE ANGLE (Degree)	RAW VALUE (dBuV)	CORRECTION FACTOR (dB/m)
1	#5714.90	68.6 PK	74.0	-5.4	1.84 V	7	62.60	6.00
2	#5714.90	53.4 AV	54.0	-0.6	1.84 V	7	47.40	6.00
3	#5722.90	69.4 PK	78.2	-8.8	1.85 V	4	63.30	6.10
4	*5785.00	126.4 PK			1.87 V	4	86.10	40.30
5	*5785.00	115.3 AV			1.87 V	4	75.00	40.30
6	11570.00	61.0 PK	74.0	-13.0	1.36 V	66	43.50	17.50
7	11570.00	48.3 AV	54.0	-5.7	1.36 V	66	30.80	17.50

REMARKS:

1. Emission Level(dBuV/m) = Raw Value(dBuV) + Correction Factor(dB/m)
2. Correction Factor(dB/m) = Antenna Factor(dB/m) + Cable Factor(dB)
3. The other emission levels were very low against the limit.
4. Margin value = Emission Level – Limit value
5. " * ": Fundamental frequency.

CHANNEL	TX Channel 165	DETECTOR FUNCTION	Peak (PK)
FREQUENCY RANGE	1GHz ~ 40GHz		Average (AV)

ANTENNA POLARITY & TEST DISTANCE: HORIZONTAL AT 3 M

NO.	FREQ. (MHz)	EMISSION LEVEL (dBuV/m)	LIMIT (dBuV/m)	MARGIN (dB)	ANTENNA HEIGHT (m)	TABLE ANGLE (Degree)	RAW VALUE (dBuV)	CORRECTION FACTOR (dB/m)
1	*5825.00	118.6 PK			1.79 H	65	78.20	40.40
2	*5825.00	108.8 AV			1.79 H	65	68.40	40.40
3	#5850.00	55.6 PK	78.2	-22.6	1.74 H	69	49.20	6.40
4	#5852.10	68.5 PK	78.2	-9.7	1.74 H	69	62.10	6.40
5	#5860.10	63.7 PK	74.0	-10.3	1.74 H	69	57.30	6.40
6	#5860.10	49.5 AV	54.0	-4.5	1.74 H	69	43.10	6.40
7	11650.00	59.4 PK	74.0	-14.6	1.00 H	55	42.10	17.30
8	11650.00	46.6 AV	54.0	-7.4	1.00 H	55	29.30	17.30

ANTENNA POLARITY & TEST DISTANCE: VERTICAL AT 3 M

NO.	FREQ. (MHz)	EMISSION LEVEL (dBuV/m)	LIMIT (dBuV/m)	MARGIN (dB)	ANTENNA HEIGHT (m)	TABLE ANGLE (Degree)	RAW VALUE (dBuV)	CORRECTION FACTOR (dB/m)
1	*5825.00	121.6 PK			1.93 V	4	81.20	40.40
2	*5825.00	111.5 AV			1.93 V	4	71.10	40.40
3	#5850.00	61.3 PK	78.2	-16.9	1.59 V	4	54.90	6.40
4	#5852.10	69.2 PK	78.2	-9.0	1.59 V	4	62.80	6.40
5	#5860.10	68.7 PK	74.0	-5.3	1.60 V	4	62.30	6.40
6	#5860.10	53.9 AV	54.0	-0.1	1.60 V	4	47.50	6.40
7	11650.00	60.7 PK	74.0	-13.3	1.30 V	66	43.40	17.30
8	11650.00	48.2 AV	54.0	-5.8	1.30 V	66	30.90	17.30

REMARKS:

1. Emission Level(dBuV/m) = Raw Value(dBuV) + Correction Factor(dB/m)
2. Correction Factor(dB/m) = Antenna Factor(dB/m) + Cable Factor(dB)
3. The other emission levels were very low against the limit.
4. Margin value = Emission Level – Limit value
5. " * ": Fundamental frequency.
6. " # ": The radiated frequency is out of the restricted band.

802.11n (HT20)

CHANNEL	TX Channel 36	DETECTOR FUNCTION	Peak (PK)
FREQUENCY RANGE	1GHz ~ 40GHz		Average (AV)

ANTENNA POLARITY & TEST DISTANCE: HORIZONTAL AT 3 M

NO.	FREQ. (MHz)	EMISSION LEVEL (dBuV/m)	LIMIT (dBuV/m)	MARGIN (dB)	ANTENNA HEIGHT (m)	TABLE ANGLE (Degree)	RAW VALUE (dBuV)	CORRECTION FACTOR (dB/m)
1	5150.00	64.4 PK	74.0	-9.6	1.80 H	65	58.60	5.80
2	5150.00	49.4 AV	54.0	-4.6	1.80 H	65	43.60	5.80
3	*5180.00	115.7 PK			1.72 H	59	75.80	39.90
4	*5180.00	105.9 AV			1.72 H	59	66.00	39.90
5	#10360.00	57.1 PK	74.0	-16.9	1.17 H	84	40.30	16.80
6	#10360.00	44.3 AV	54.0	-9.7	1.17 H	84	27.50	16.80

ANTENNA POLARITY & TEST DISTANCE: VERTICAL AT 3 M

NO.	FREQ. (MHz)	EMISSION LEVEL (dBuV/m)	LIMIT (dBuV/m)	MARGIN (dB)	ANTENNA HEIGHT (m)	TABLE ANGLE (Degree)	RAW VALUE (dBuV)	CORRECTION FACTOR (dB/m)
1	5150.00	68.7 PK	74.0	-5.3	1.69 V	25	62.90	5.80
2	5150.00	52.7 AV	54.0	-1.3	1.69 V	25	46.90	5.80
3	*5180.00	117.0 PK			1.06 V	34	77.10	39.90
4	*5180.00	107.9 AV			1.06 V	34	68.00	39.90
5	#10360.00	58.3 PK	74.0	-15.7	1.17 V	41	41.50	16.80
6	#10360.00	45.5 AV	54.0	-8.5	1.17 V	41	28.70	16.80

REMARKS:

1. Emission Level(dBuV/m) = Raw Value(dBuV) + Correction Factor(dB/m)
2. Correction Factor(dB/m) = Antenna Factor(dB/m) + Cable Factor(dB)
3. The other emission levels were very low against the limit.
4. Margin value = Emission Level – Limit value
5. " * ": Fundamental frequency.
6. " # ": The radiated frequency is out of the restricted band.



CHANNEL	TX Channel 40	DETECTOR FUNCTION	Peak (PK)
FREQUENCY RANGE	1GHz ~ 40GHz		Average (AV)

ANTENNA POLARITY & TEST DISTANCE: HORIZONTAL AT 3 M

NO.	FREQ. (MHz)	EMISSION LEVEL (dBuV/m)	LIMIT (dBuV/m)	MARGIN (dB)	ANTENNA HEIGHT (m)	TABLE ANGLE (Degree)	RAW VALUE (dBuV)	CORRECTION FACTOR (dB/m)
1	5150.00	67.1 PK	74.0	-6.9	1.72 H	320	61.30	5.80
2	5150.00	50.0 AV	54.0	-4.0	1.72 H	320	44.20	5.80
3	*5200.00	119.1 PK			1.69 H	316	79.20	39.90
4	*5200.00	110.0 AV			1.69 H	316	70.10	39.90
5	#10400.00	57.3 PK	74.0	-16.7	1.36 H	95	40.00	17.30
6	#10400.00	44.9 AV	54.0	-9.1	1.36 H	95	27.60	17.30

ANTENNA POLARITY & TEST DISTANCE: VERTICAL AT 3 M

NO.	FREQ. (MHz)	EMISSION LEVEL (dBuV/m)	LIMIT (dBuV/m)	MARGIN (dB)	ANTENNA HEIGHT (m)	TABLE ANGLE (Degree)	RAW VALUE (dBuV)	CORRECTION FACTOR (dB/m)
1	5150.00	72.5 PK	74.0	-1.5	1.44 V	9	66.70	5.80
2	5150.00	50.9 AV	54.0	-3.1	1.44 V	9	45.10	5.80
3	*5200.00	120.6 PK			1.00 V	46	80.70	39.90
4	*5200.00	110.4 AV			1.00 V	46	70.50	39.90
5	#10400.00	59.1 PK	74.0	-14.9	1.05 V	96	41.80	17.30
6	#10400.00	45.7 AV	54.0	-8.3	1.05 V	96	28.40	17.30

REMARKS:

1. Emission Level(dBuV/m) = Raw Value(dBuV) + Correction Factor(dB/m)
2. Correction Factor(dB/m) = Antenna Factor(dB/m) + Cable Factor(dB)
3. The other emission levels were very low against the limit.
4. Margin value = Emission Level – Limit value
5. " * ": Fundamental frequency.
6. " # ": The radiated frequency is out of the restricted band.



CHANNEL	TX Channel 48	DETECTOR FUNCTION	Peak (PK)
FREQUENCY RANGE	1GHz ~ 40GHz		Average (AV)

ANTENNA POLARITY & TEST DISTANCE: HORIZONTAL AT 3 M

NO.	FREQ. (MHz)	EMISSION LEVEL (dBuV/m)	LIMIT (dBuV/m)	MARGIN (dB)	ANTENNA HEIGHT (m)	TABLE ANGLE (Degree)	RAW VALUE (dBuV)	CORRECTION FACTOR (dB/m)
1	*5240.00	119.1 PK			1.44 H	64	79.20	39.90
2	*5240.00	109.8 AV			1.44 H	64	69.90	39.90
3	5350.00	58.1 PK	74.0	-15.9	1.50 H	70	52.00	6.10
4	5350.00	46.8 AV	54.0	-7.2	1.50 H	70	40.70	6.10
5	#10480.00	57.9 PK	74.0	-16.1	1.25 H	63	40.60	17.30
6	#10480.00	44.4 AV	54.0	-9.6	1.25 H	63	27.10	17.30

ANTENNA POLARITY & TEST DISTANCE: VERTICAL AT 3 M

NO.	FREQ. (MHz)	EMISSION LEVEL (dBuV/m)	LIMIT (dBuV/m)	MARGIN (dB)	ANTENNA HEIGHT (m)	TABLE ANGLE (Degree)	RAW VALUE (dBuV)	CORRECTION FACTOR (dB/m)
1	*5240.00	120.0 PK			1.16 V	19	80.10	39.90
2	*5240.00	110.7 AV			1.16 V	19	70.80	39.90
3	5350.00	59.8 PK	74.0	-14.2	2.21 V	17	53.70	6.10
4	5350.00	46.7 AV	54.0	-7.3	2.21 V	17	40.60	6.10
5	#10480.00	59.2 PK	74.0	-14.8	1.26 V	34	41.90	17.30
6	#10480.00	45.7 AV	54.0	-8.3	1.26 V	34	28.40	17.30

REMARKS:

1. Emission Level(dBuV/m) = Raw Value(dBuV) + Correction Factor(dB/m)
2. Correction Factor(dB/m) = Antenna Factor(dB/m) + Cable Factor(dB)
3. The other emission levels were very low against the limit.
4. Margin value = Emission Level – Limit value
5. " * ": Fundamental frequency.
6. " # ": The radiated frequency is out of the restricted band.



CHANNEL	TX Channel 149	DETECTOR FUNCTION	Peak (PK)
FREQUENCY RANGE	1GHz ~ 40GHz		Average (AV)

ANTENNA POLARITY & TEST DISTANCE: HORIZONTAL AT 3 M

NO.	FREQ. (MHz)	EMISSION LEVEL (dBuV/m)	LIMIT (dBuV/m)	MARGIN (dB)	ANTENNA HEIGHT (m)	TABLE ANGLE (Degree)	RAW VALUE (dBuV)	CORRECTION FACTOR (dB/m)
1	#5660.00	58.6 PK	74.0	-15.4	1.37 H	53	52.60	6.00
2	#5660.00	46.2 AV	54.0	-7.8	1.37 H	53	40.20	6.00
3	#5722.90	69.6 PK	78.2	-8.6	1.37 H	53	63.50	6.10
4	#5725.00	57.0 PK	78.2	-21.2	1.37 H	53	50.90	6.10
5	*5745.00	112.7 PK			1.40 H	55	72.40	40.30
6	*5745.00	102.4 AV			1.40 H	55	62.10	40.30
7	11490.00	58.9 PK	74.0	-15.1	1.00 H	80	41.30	17.60
8	11490.00	45.6 AV	54.0	-8.4	1.00 H	80	28.00	17.60

ANTENNA POLARITY & TEST DISTANCE: VERTICAL AT 3 M

NO.	FREQ. (MHz)	EMISSION LEVEL (dBuV/m)	LIMIT (dBuV/m)	MARGIN (dB)	ANTENNA HEIGHT (m)	TABLE ANGLE (Degree)	RAW VALUE (dBuV)	CORRECTION FACTOR (dB/m)
1	#5660.00	62.4 PK	74.0	-11.6	1.80 V	9	56.40	6.00
2	#5660.00	49.4 AV	54.0	-4.6	1.80 V	9	43.40	6.00
3	#5722.90	78.0 PK	78.2	-0.2	1.84 V	5	71.90	6.10
4	#5725.00	62.6 PK	78.2	-15.6	1.84 V	5	56.50	6.10
5	*5745.00	116.2 PK			1.79 V	7	75.90	40.30
6	*5745.00	105.9 AV			1.79 V	7	65.60	40.30
7	11490.00	60.1 PK	74.0	-13.9	1.33 V	85	42.50	17.60
8	11490.00	47.4 AV	54.0	-6.6	1.33 V	85	29.80	17.60

REMARKS:

1. Emission Level(dBuV/m) = Raw Value(dBuV) + Correction Factor(dB/m)
2. Correction Factor(dB/m) = Antenna Factor(dB/m) + Cable Factor(dB)
3. The other emission levels were very low against the limit.
4. Margin value = Emission Level – Limit value
5. " * ": Fundamental frequency.
6. " # ": The radiated frequency is out of the restricted band.

CHANNEL	TX Channel 157	DETECTOR FUNCTION	Peak (PK)
FREQUENCY RANGE	1GHz ~ 40GHz		Average (AV)

ANTENNA POLARITY & TEST DISTANCE: HORIZONTAL AT 3 M

NO.	FREQ. (MHz)	EMISSION LEVEL (dBuV/m)	LIMIT (dBuV/m)	MARGIN (dB)	ANTENNA HEIGHT (m)	TABLE ANGLE (Degree)	RAW VALUE (dBuV)	CORRECTION FACTOR (dB/m)
1	#5714.90	62.6 PK	74.0	-11.4	1.13 H	59	56.60	6.00
2	#5714.90	48.9 AV	54.0	-5.1	1.13 H	59	42.90	6.00
3	#5722.90	64.5 PK	78.2	-13.7	1.13 H	59	58.40	6.10
4	*5785.00	118.2 PK			1.14 H	58	77.90	40.30
5	*5785.00	108.0 AV			1.14 H	58	67.70	40.30
6	11570.00	59.1 PK	74.0	-14.9	1.00 H	96	41.60	17.50
7	11570.00	46.8 AV	54.0	-7.2	1.00 H	96	29.30	17.50

ANTENNA POLARITY & TEST DISTANCE: VERTICAL AT 3 M

NO.	FREQ. (MHz)	EMISSION LEVEL (dBuV/m)	LIMIT (dBuV/m)	MARGIN (dB)	ANTENNA HEIGHT (m)	TABLE ANGLE (Degree)	RAW VALUE (dBuV)	CORRECTION FACTOR (dB/m)
1	#5700.00	64.8 PK	74.0	-9.2	1.89 V	12	58.80	6.00
2	#5700.00	51.8 AV	54.0	-2.2	1.89 V	12	45.80	6.00
3	#5722.90	70.2 PK	78.2	-8.0	1.88 V	17	64.10	6.10
4	*5785.00	122.8 PK			1.81 V	15	82.50	40.30
5	*5785.00	111.5 AV			1.81 V	15	71.20	40.30
6	11570.00	60.7 PK	74.0	-13.3	1.31 V	65	43.20	17.50
7	11570.00	47.7 AV	54.0	-6.3	1.31 V	65	30.20	17.50

REMARKS:

1. Emission Level(dBuV/m) = Raw Value(dBuV) + Correction Factor(dB/m)
2. Correction Factor(dB/m) = Antenna Factor(dB/m) + Cable Factor(dB)
3. The other emission levels were very low against the limit.
4. Margin value = Emission Level – Limit value
5. " * ": Fundamental frequency.

CHANNEL	TX Channel 165	DETECTOR FUNCTION	Peak (PK)
FREQUENCY RANGE	1GHz ~ 40GHz		Average (AV)

ANTENNA POLARITY & TEST DISTANCE: HORIZONTAL AT 3 M

NO.	FREQ. (MHz)	EMISSION LEVEL (dBuV/m)	LIMIT (dBuV/m)	MARGIN (dB)	ANTENNA HEIGHT (m)	TABLE ANGLE (Degree)	RAW VALUE (dBuV)	CORRECTION FACTOR (dB/m)
1	*5825.00	114.4 PK			1.59 H	59	74.00	40.40
2	*5825.00	104.1 AV			1.59 H	59	63.70	40.40
3	#5850.00	62.6 PK	78.2	-15.6	1.51 H	54	56.20	6.40
4	#5852.10	73.5 PK	78.2	-4.7	1.51 H	54	67.10	6.40
5	#5860.10	66.9 PK	74.0	-7.1	1.51 H	54	60.50	6.40
6	#5860.10	49.4 AV	54.0	-4.6	1.51 H	54	43.00	6.40
7	11650.00	58.8 PK	74.0	-15.2	1.00 H	53	41.50	17.30
8	11650.00	46.5 AV	54.0	-7.5	1.00 H	53	29.20	17.30

ANTENNA POLARITY & TEST DISTANCE: VERTICAL AT 3 M

NO.	FREQ. (MHz)	EMISSION LEVEL (dBuV/m)	LIMIT (dBuV/m)	MARGIN (dB)	ANTENNA HEIGHT (m)	TABLE ANGLE (Degree)	RAW VALUE (dBuV)	CORRECTION FACTOR (dB/m)
1	*5825.00	117.6 PK			1.61 V	333	77.20	40.40
2	*5825.00	108.1 AV			1.61 V	333	67.70	40.40
3	#5850.00	68.6 PK	78.2	-9.6	1.59 V	21	62.20	6.40
4	#5852.10	74.8 PK	78.2	-3.4	1.59 V	21	68.40	6.40
5	#5860.10	72.2 PK	74.0	-1.8	1.60 V	20	65.80	6.40
6	#5860.10	52.8 AV	54.0	-1.2	1.60 V	20	46.40	6.40
7	11650.00	60.3 PK	74.0	-13.7	1.38 V	60	43.00	17.30
8	11650.00	47.9 AV	54.0	-6.1	1.38 V	60	30.60	17.30

REMARKS:

1. Emission Level(dBuV/m) = Raw Value(dBuV) + Correction Factor(dB/m)
2. Correction Factor(dB/m) = Antenna Factor(dB/m) + Cable Factor(dB)
3. The other emission levels were very low against the limit.
4. Margin value = Emission Level – Limit value
5. " * ": Fundamental frequency.
6. " # ": The radiated frequency is out of the restricted band.

802.11n (HT40)

CHANNEL	TX Channel 38	DETECTOR FUNCTION	Peak (PK)
FREQUENCY RANGE	1GHz ~ 40GHz		Average (AV)

ANTENNA POLARITY & TEST DISTANCE: HORIZONTAL AT 3 M								
NO.	FREQ. (MHz)	EMISSION LEVEL (dBuV/m)	LIMIT (dBuV/m)	MARGIN (dB)	ANTENNA HEIGHT (m)	TABLE ANGLE (Degree)	RAW VALUE (dBuV)	CORRECTION FACTOR (dB/m)
1	5150.00	66.4 PK	74.0	-7.6	1.75 H	315	60.60	5.80
2	5150.00	48.1 AV	54.0	-5.9	1.75 H	315	42.30	5.80
3	*5190.00	110.6 PK			1.72 H	312	70.70	39.90
4	*5190.00	100.4 AV			1.72 H	312	60.50	39.90
5	#10380.00	57.1 PK	74.0	-16.9	1.47 H	87	40.00	17.10
6	#10380.00	44.5 AV	54.0	-9.5	1.47 H	87	27.40	17.10
ANTENNA POLARITY & TEST DISTANCE: VERTICAL AT 3 M								
NO.	FREQ. (MHz)	EMISSION LEVEL (dBuV/m)	LIMIT (dBuV/m)	MARGIN (dB)	ANTENNA HEIGHT (m)	TABLE ANGLE (Degree)	RAW VALUE (dBuV)	CORRECTION FACTOR (dB/m)
1	5150.00	69.3 PK	74.0	-4.7	2.06 V	357	63.50	5.80
2	5150.00	53.0 AV	54.0	-1.0	2.06 V	357	47.20	5.80
3	*5190.00	112.4 PK			1.42 V	38	72.50	39.90
4	*5190.00	102.0 AV			1.42 V	38	62.10	39.90
5	#10380.00	58.7 PK	74.0	-15.3	1.07 V	41	41.60	17.10
6	#10380.00	45.5 AV	54.0	-8.5	1.07 V	41	28.40	17.10

REMARKS:

1. Emission Level(dBuV/m) = Raw Value(dBuV) + Correction Factor(dB/m)
2. Correction Factor(dB/m) = Antenna Factor(dB/m) + Cable Factor(dB)
3. The other emission levels were very low against the limit.
4. Margin value = Emission Level – Limit value
5. " * ": Fundamental frequency.
6. " # ": The radiated frequency is out of the restricted band.

CHANNEL	TX Channel 46	DETECTOR FUNCTION	Peak (PK)
FREQUENCY RANGE	1GHz ~ 40GHz		Average (AV)

ANTENNA POLARITY & TEST DISTANCE: HORIZONTAL AT 3 M

NO.	FREQ. (MHz)	EMISSION LEVEL (dBuV/m)	LIMIT (dBuV/m)	MARGIN (dB)	ANTENNA HEIGHT (m)	TABLE ANGLE (Degree)	RAW VALUE (dBuV)	CORRECTION FACTOR (dB/m)
1	5150.00	67.8 PK	74.0	-6.2	1.75 H	60	62.00	5.80
2	5150.00	49.4 AV	54.0	-4.6	1.75 H	60	43.60	5.80
3	*5230.00	115.6 PK			1.70 H	56	75.70	39.90
4	*5230.00	105.8 AV			1.70 H	56	65.90	39.90
5	5350.00	62.1 PK	74.0	-11.9	1.65 H	50	56.00	6.10
6	5350.00	49.1 AV	54.0	-4.9	1.65 H	50	43.00	6.10
7	#10460.00	57.2 PK	74.0	-16.8	1.32 H	64	40.00	17.20
8	#10460.00	44.7 AV	54.0	-9.3	1.32 H	64	27.50	17.20

ANTENNA POLARITY & TEST DISTANCE: VERTICAL AT 3 M

NO.	FREQ. (MHz)	EMISSION LEVEL (dBuV/m)	LIMIT (dBuV/m)	MARGIN (dB)	ANTENNA HEIGHT (m)	TABLE ANGLE (Degree)	RAW VALUE (dBuV)	CORRECTION FACTOR (dB/m)
1	5150.00	68.9 PK	74.0	-5.1	1.78 V	0	63.10	5.80
2	5150.00	53.0 AV	54.0	-1.0	1.78 V	0	47.20	5.80
3	*5230.00	116.2 PK			1.92 V	48	76.30	39.90
4	*5230.00	105.0 AV			1.92 V	48	65.10	39.90
5	5350.00	63.4 PK	74.0	-10.6	1.56 V	300	57.30	6.10
6	5350.00	46.8 AV	54.0	-7.2	1.56 V	300	40.70	6.10
7	#10460.00	58.4 PK	74.0	-15.6	1.36 V	98	41.20	17.20
8	#10460.00	45.6 AV	54.0	-8.4	1.36 V	98	28.40	17.20

REMARKS:

1. Emission Level(dBuV/m) = Raw Value(dBuV) + Correction Factor(dB/m)
2. Correction Factor(dB/m) = Antenna Factor(dB/m) + Cable Factor(dB)
3. The other emission levels were very low against the limit.
4. Margin value = Emission Level – Limit value
5. " * ": Fundamental frequency.
6. " # ": The radiated frequency is out of the restricted band.



CHANNEL	TX Channel 151	DETECTOR FUNCTION	Peak (PK)
FREQUENCY RANGE	1GHz ~ 40GHz		Average (AV)

ANTENNA POLARITY & TEST DISTANCE: HORIZONTAL AT 3 M

NO.	FREQ. (MHz)	EMISSION LEVEL (dBuV/m)	LIMIT (dBuV/m)	MARGIN (dB)	ANTENNA HEIGHT (m)	TABLE ANGLE (Degree)	RAW VALUE (dBuV)	CORRECTION FACTOR (dB/m)
1	#5714.90	64.3 PK	74.0	-9.7	2.17 H	68	58.30	6.00
2	#5714.90	48.0 AV	54.0	-6.0	2.17 H	68	42.00	6.00
3	#5722.90	69.8 PK	78.2	-8.4	2.17 H	68	63.70	6.10
4	#5725.00	61.4 PK	78.2	-16.8	2.17 H	68	55.30	6.10
5	*5755.00	110.1 PK			2.17 H	66	69.80	40.30
6	*5755.00	99.5 AV			2.17 H	66	59.20	40.30
7	11510.00	58.7 PK	74.0	-15.3	1.00 H	85	41.30	17.40
8	11510.00	45.4 AV	54.0	-8.6	1.00 H	85	28.00	17.40

ANTENNA POLARITY & TEST DISTANCE: VERTICAL AT 3 M

NO.	FREQ. (MHz)	EMISSION LEVEL (dBuV/m)	LIMIT (dBuV/m)	MARGIN (dB)	ANTENNA HEIGHT (m)	TABLE ANGLE (Degree)	RAW VALUE (dBuV)	CORRECTION FACTOR (dB/m)
1	#5714.90	68.8 PK	74.0	-5.2	1.80 V	8	62.80	6.00
2	#5714.90	53.7 AV	54.0	-0.3	1.80 V	8	47.70	6.00
3	#5722.90	76.5 PK	78.2	-1.7	1.80 V	8	70.40	6.10
4	#5725.00	61.5 PK	78.2	-16.7	1.80 V	8	55.40	6.10
5	*5755.00	112.8 PK			1.86 V	8	72.50	40.30
6	*5755.00	102.4 AV			1.86 V	8	62.10	40.30
7	11510.00	60.0 PK	74.0	-14.0	1.38 V	88	42.60	17.40
8	11510.00	47.3 AV	54.0	-6.7	1.38 V	88	29.90	17.40

REMARKS:

1. Emission Level(dBuV/m) = Raw Value(dBuV) + Correction Factor(dB/m)
2. Correction Factor(dB/m) = Antenna Factor(dB/m) + Cable Factor(dB)
3. The other emission levels were very low against the limit.
4. Margin value = Emission Level – Limit value
5. " * ": Fundamental frequency.
6. " # ": The radiated frequency is out of the restricted band.



CHANNEL	TX Channel 159	DETECTOR FUNCTION	Peak (PK)
FREQUENCY RANGE	1GHz ~ 40GHz		Average (AV)

ANTENNA POLARITY & TEST DISTANCE: HORIZONTAL AT 3 M

NO.	FREQ. (MHz)	EMISSION LEVEL (dBuV/m)	LIMIT (dBuV/m)	MARGIN (dB)	ANTENNA HEIGHT (m)	TABLE ANGLE (Degree)	RAW VALUE (dBuV)	CORRECTION FACTOR (dB/m)
1	*5795.00	110.8 PK			2.25 H	70	70.50	40.30
2	*5795.00	101.2 AV			2.25 H	70	60.90	40.30
3	#5850.00	61.3 PK	78.2	-16.9	2.28 H	73	54.90	6.40
4	#5852.10	69.9 PK	78.2	-8.3	2.28 H	73	63.50	6.40
5	#5860.10	69.1 PK	74.0	-4.9	2.28 H	73	62.70	6.40
6	#5860.10	49.5 AV	54.0	-4.5	2.28 H	73	43.10	6.40
7	11590.00	58.5 PK	74.0	-15.5	1.00 H	51	41.20	17.30
8	11590.00	46.3 AV	54.0	-7.7	1.00 H	51	29.00	17.30

ANTENNA POLARITY & TEST DISTANCE: VERTICAL AT 3 M

NO.	FREQ. (MHz)	EMISSION LEVEL (dBuV/m)	LIMIT (dBuV/m)	MARGIN (dB)	ANTENNA HEIGHT (m)	TABLE ANGLE (Degree)	RAW VALUE (dBuV)	CORRECTION FACTOR (dB/m)
1	*5795.00	115.1 PK			1.80 V	13	74.80	40.30
2	*5795.00	105.5 AV			1.80 V	13	65.20	40.30
3	#5850.00	65.2 PK	78.2	-13.0	1.96 V	7	58.80	6.40
4	#5852.10	76.8 PK	78.2	-1.4	1.96 V	7	70.40	6.40
5	#5860.10	70.5 PK	74.0	-3.5	1.98 V	10	64.10	6.40
6	#5860.10	53.4 AV	54.0	-0.6	1.98 V	10	47.00	6.40
7	11590.00	60.2 PK	74.0	-13.8	1.31 V	63	42.90	17.30
8	11590.00	47.7 AV	54.0	-6.3	1.31 V	63	30.40	17.30

REMARKS:

1. Emission Level(dBuV/m) = Raw Value(dBuV) + Correction Factor(dB/m)
2. Correction Factor(dB/m) = Antenna Factor(dB/m) + Cable Factor(dB)
3. The other emission levels were very low against the limit.
4. Margin value = Emission Level – Limit value
5. " * ": Fundamental frequency.
6. " # ": The radiated frequency is out of the restricted band.

802.11ac (VHT80)

CHANNEL	TX Channel 42	DETECTOR FUNCTION	Peak (PK)
FREQUENCY RANGE	1GHz ~ 40GHz		Average (AV)

ANTENNA POLARITY & TEST DISTANCE: HORIZONTAL AT 3 M								
NO.	FREQ. (MHz)	EMISSION LEVEL (dBuV/m)	LIMIT (dBuV/m)	MARGIN (dB)	ANTENNA HEIGHT (m)	TABLE ANGLE (Degree)	RAW VALUE (dBuV)	CORRECTION FACTOR (dB/m)
1	5150.00	72.8 PK	74.0	-1.2	1.50 H	316	67.80	5.00
2	5150.00	45.1 AV	54.0	-8.9	1.50 H	316	40.10	5.00
3	*5210.00	106.1 PK			1.55 H	313	66.90	39.20
4	*5210.00	96.0 AV			1.55 H	313	56.80	39.20
5	#10420.00	57.0 PK	74.0	-17.0	1.00 H	86	39.70	17.30
6	#10420.00	44.4 AV	54.0	-9.6	1.00 H	86	27.10	17.30

ANTENNA POLARITY & TEST DISTANCE: VERTICAL AT 3 M								
NO.	FREQ. (MHz)	EMISSION LEVEL (dBuV/m)	LIMIT (dBuV/m)	MARGIN (dB)	ANTENNA HEIGHT (m)	TABLE ANGLE (Degree)	RAW VALUE (dBuV)	CORRECTION FACTOR (dB/m)
1	5150.00	73.4 PK	74.0	-0.6	1.39 V	66	68.40	5.00
2	5150.00	49.6 AV	54.0	-4.4	1.39 V	66	44.60	5.00
3	*5210.00	107.5 PK			1.80 V	63	68.30	39.20
4	*5210.00	98.0 AV			1.80 V	63	58.80	39.20
5	#10420.00	58.2 PK	74.0	-15.8	1.22 V	96	40.90	17.30
6	#10420.00	44.8 AV	54.0	-9.2	1.22 V	96	27.50	17.30

REMARKS:

1. Emission Level(dBuV/m) = Raw Value(dBuV) + Correction Factor(dB/m)
2. Correction Factor(dB/m) = Antenna Factor(dB/m) + Cable Factor(dB)
3. The other emission levels were very low against the limit.
4. Margin value = Emission Level – Limit value
5. " * ": Fundamental frequency.
6. " # ": The radiated frequency is out of the restricted band.

CHANNEL	TX Channel 155	DETECTOR FUNCTION	Peak (PK)
FREQUENCY RANGE	1GHz ~ 40GHz		Average (AV)

ANTENNA POLARITY & TEST DISTANCE: HORIZONTAL AT 3 M

NO.	FREQ. (MHz)	EMISSION LEVEL (dBuV/m)	LIMIT (dBuV/m)	MARGIN (dB)	ANTENNA HEIGHT (m)	TABLE ANGLE (Degree)	RAW VALUE (dBuV)	CORRECTION FACTOR (dB/m)
1	#5714.90	68.9 PK	74.0	-5.1	2.28 H	69	62.90	6.00
2	#5714.90	50.1 AV	54.0	-3.9	2.28 H	69	44.10	6.00
3	#5722.90	76.4 PK	78.2	-1.8	2.28 H	69	70.30	6.10
4	#5725.00	61.0 PK	78.2	-17.2	2.28 H	69	54.90	6.10
5	*5775.00	104.6 PK			2.23 H	65	64.30	40.30
6	*5775.00	94.3 AV			2.23 H	65	54.00	40.30
7	11550.00	58.0 PK	74.0	-16.0	1.00 H	81	40.60	17.40
8	11550.00	45.3 AV	54.0	-8.7	1.00 H	81	27.90	17.40

ANTENNA POLARITY & TEST DISTANCE: VERTICAL AT 3 M

NO.	FREQ. (MHz)	EMISSION LEVEL (dBuV/m)	LIMIT (dBuV/m)	MARGIN (dB)	ANTENNA HEIGHT (m)	TABLE ANGLE (Degree)	RAW VALUE (dBuV)	CORRECTION FACTOR (dB/m)
1	#5714.90	72.5 PK	74.0	-1.5	1.64 V	14	66.50	6.00
2	#5714.90	53.6 AV	54.0	-0.4	1.64 V	14	47.60	6.00
3	#5722.90	78.1 PK	78.2	-0.1	1.61 V	11	72.00	6.10
4	#5725.00	62.1 PK	78.2	-16.1	1.61 V	11	56.00	6.10
5	*5775.00	107.9 PK			1.60 V	359	67.60	40.30
6	*5775.00	97.7 AV			1.60 V	359	57.40	40.30
7	11550.00	59.9 PK	74.0	-14.1	1.30 V	82	42.50	17.40
8	11550.00	47.2 AV	54.0	-6.8	1.30 V	82	29.80	17.40

REMARKS:

1. Emission Level(dBuV/m) = Raw Value(dBuV) + Correction Factor(dB/m)
2. Correction Factor(dB/m) = Antenna Factor(dB/m) + Cable Factor(dB)
3. The other emission levels were very low against the limit.
4. Margin value = Emission Level – Limit value
5. " * ": Fundamental frequency.

Test Mode D
1TX
802.11a

CHANNEL	TX Channel 36	DETECTOR FUNCTION	Peak (PK)
FREQUENCY RANGE	1GHz ~ 40GHz		Average (AV)

ANTENNA POLARITY & TEST DISTANCE: HORIZONTAL AT 3 M

NO.	FREQ. (MHz)	EMISSION LEVEL (dBuV/m)	LIMIT (dBuV/m)	MARGIN (dB)	ANTENNA HEIGHT (m)	TABLE ANGLE (Degree)	RAW VALUE (dBuV)	CORRECTION FACTOR (dB/m)
1	5150.00	67.4 PK	74.0	-6.6	1.16 H	32	62.40	5.00
2	5150.00	52.7 AV	54.0	-1.3	1.16 H	32	47.70	5.00
3	*5180.00	111.3 PK			1.23 H	31	72.20	39.10
4	*5180.00	101.2 AV			1.23 H	31	62.10	39.10
5	#10360.00	61.5 PK	74.0	-12.5	1.39 H	327	44.40	17.10
6	#10360.00	49.2 AV	54.0	-4.8	1.39 H	327	32.10	17.10

ANTENNA POLARITY & TEST DISTANCE: VERTICAL AT 3 M

NO.	FREQ. (MHz)	EMISSION LEVEL (dBuV/m)	LIMIT (dBuV/m)	MARGIN (dB)	ANTENNA HEIGHT (m)	TABLE ANGLE (Degree)	RAW VALUE (dBuV)	CORRECTION FACTOR (dB/m)
1	5150.00	65.7 PK	74.0	-8.3	1.00 V	340	60.70	5.00
2	5150.00	49.3 AV	54.0	-4.7	1.00 V	340	44.30	5.00
3	*5180.00	105.7 PK			1.00 V	335	66.60	39.10
4	*5180.00	95.3 AV			1.00 V	335	56.20	39.10
5	#10360.00	58.9 PK	74.0	-15.1	1.36 V	97	41.80	17.10
6	#10360.00	47.2 AV	54.0	-6.8	1.36 V	97	30.10	17.10

REMARKS:

1. Emission Level(dBuV/m) = Raw Value(dBuV) + Correction Factor(dB/m)
2. Correction Factor(dB/m) = Antenna Factor(dB/m) + Cable Factor(dB)
3. The other emission levels were very low against the limit.
4. Margin value = Emission Level – Limit value
5. " * ": Fundamental frequency.
6. " # ": The radiated frequency is out of the restricted band.

CHANNEL	TX Channel 40	DETECTOR FUNCTION	Peak (PK)
FREQUENCY RANGE	1GHz ~ 40GHz		Average (AV)

ANTENNA POLARITY & TEST DISTANCE: HORIZONTAL AT 3 M

NO.	FREQ. (MHz)	EMISSION LEVEL (dBuV/m)	LIMIT (dBuV/m)	MARGIN (dB)	ANTENNA HEIGHT (m)	TABLE ANGLE (Degree)	RAW VALUE (dBuV)	CORRECTION FACTOR (dB/m)
1	5150.00	73.3 PK	74.0	-0.7	1.77 H	38	68.30	5.00
2	5150.00	53.9 AV	54.0	-0.1	1.77 H	38	48.90	5.00
3	*5200.00	116.8 PK			1.75 H	32	77.60	39.20
4	*5200.00	105.3 AV			1.75 H	32	66.10	39.20
5	#10400.00	62.6 PK	74.0	-11.4	1.19 H	329	45.30	17.30
6	#10400.00	49.8 AV	54.0	-4.2	1.19 H	329	32.50	17.30

ANTENNA POLARITY & TEST DISTANCE: VERTICAL AT 3 M

NO.	FREQ. (MHz)	EMISSION LEVEL (dBuV/m)	LIMIT (dBuV/m)	MARGIN (dB)	ANTENNA HEIGHT (m)	TABLE ANGLE (Degree)	RAW VALUE (dBuV)	CORRECTION FACTOR (dB/m)
1	5150.00	67.4 PK	74.0	-6.6	1.09 V	353	62.40	5.00
2	5150.00	49.4 AV	54.0	-4.6	1.09 V	353	44.40	5.00
3	*5200.00	111.3 PK			1.06 V	357	72.10	39.20
4	*5200.00	99.9 AV			1.06 V	357	60.70	39.20
5	#10400.00	59.4 PK	74.0	-14.6	1.00 V	92	42.10	17.30
6	#10400.00	47.8 AV	54.0	-6.2	1.00 V	92	30.50	17.30

REMARKS:

1. Emission Level(dBuV/m) = Raw Value(dBuV) + Correction Factor(dB/m)
2. Correction Factor(dB/m) = Antenna Factor(dB/m) + Cable Factor(dB)
3. The other emission levels were very low against the limit.
4. Margin value = Emission Level – Limit value
5. " * ": Fundamental frequency.
6. " # ": The radiated frequency is out of the restricted band.

CHANNEL	TX Channel 48	DETECTOR FUNCTION	Peak (PK)
FREQUENCY RANGE	1GHz ~ 40GHz		Average (AV)

ANTENNA POLARITY & TEST DISTANCE: HORIZONTAL AT 3 M

NO.	FREQ. (MHz)	EMISSION LEVEL (dBuV/m)	LIMIT (dBuV/m)	MARGIN (dB)	ANTENNA HEIGHT (m)	TABLE ANGLE (Degree)	RAW VALUE (dBuV)	CORRECTION FACTOR (dB/m)
1	*5240.00	117.2 PK			1.64 H	29	78.00	39.20
2	*5240.00	105.6 AV			1.64 H	29	66.40	39.20
3	5350.00	59.4 PK	74.0	-14.6	1.64 H	28	54.00	5.40
4	5350.00	47.6 AV	54.0	-6.4	1.64 H	28	42.20	5.40
5	#10480.00	62.8 PK	74.0	-11.2	1.10 H	323	45.50	17.30
6	#10480.00	50.0 AV	54.0	-4.0	1.10 H	323	32.70	17.30

ANTENNA POLARITY & TEST DISTANCE: VERTICAL AT 3 M

NO.	FREQ. (MHz)	EMISSION LEVEL (dBuV/m)	LIMIT (dBuV/m)	MARGIN (dB)	ANTENNA HEIGHT (m)	TABLE ANGLE (Degree)	RAW VALUE (dBuV)	CORRECTION FACTOR (dB/m)
1	*5240.00	109.2 PK			2.34 V	344	70.00	39.20
2	*5240.00	98.3 AV			2.34 V	344	59.10	39.20
3	5350.00	58.3 PK	74.0	-15.7	2.30 V	349	52.90	5.40
4	5350.00	46.8 AV	54.0	-7.2	2.30 V	349	41.40	5.40
5	#10480.00	60.0 PK	74.0	-14.0	1.00 V	99	42.70	17.30
6	#10480.00	48.0 AV	54.0	-6.0	1.00 V	99	30.70	17.30

REMARKS:

1. Emission Level(dBuV/m) = Raw Value(dBuV) + Correction Factor(dB/m)
2. Correction Factor(dB/m) = Antenna Factor(dB/m) + Cable Factor(dB)
3. The other emission levels were very low against the limit.
4. Margin value = Emission Level – Limit value
5. " * ": Fundamental frequency.
6. " # ": The radiated frequency is out of the restricted band.

CHANNEL	TX Channel 149	DETECTOR FUNCTION	Peak (PK)
FREQUENCY RANGE	1GHz ~ 40GHz		Average (AV)

ANTENNA POLARITY & TEST DISTANCE: HORIZONTAL AT 3 M

NO.	FREQ. (MHz)	EMISSION LEVEL (dBuV/m)	LIMIT (dBuV/m)	MARGIN (dB)	ANTENNA HEIGHT (m)	TABLE ANGLE (Degree)	RAW VALUE (dBuV)	CORRECTION FACTOR (dB/m)
1	#5714.90	66.3 PK	74.0	-7.7	1.75 H	356	60.30	6.00
2	#5714.90	50.9 AV	54.0	-3.1	1.75 H	356	44.90	6.00
3	#5722.90	77.7 PK	78.2	-0.5	1.75 H	6	71.60	6.10
4	#5725.00	69.1 PK	78.2	-9.1	1.75 H	6	63.00	6.10
5	*5745.00	112.8 PK			1.70 H	358	72.50	40.30
6	*5745.00	102.5 AV			1.70 H	358	62.20	40.30
7	11490.00	61.3 PK	74.0	-12.7	1.11 H	321	43.70	17.60
8	11490.00	47.7 AV	54.0	-6.3	1.11 H	321	30.10	17.60

ANTENNA POLARITY & TEST DISTANCE: VERTICAL AT 3 M

NO.	FREQ. (MHz)	EMISSION LEVEL (dBuV/m)	LIMIT (dBuV/m)	MARGIN (dB)	ANTENNA HEIGHT (m)	TABLE ANGLE (Degree)	RAW VALUE (dBuV)	CORRECTION FACTOR (dB/m)
1	#5714.90	62.3 PK	74.0	-11.7	1.58 V	10	56.30	6.00
2	#5714.90	47.5 AV	54.0	-6.5	1.58 V	10	41.50	6.00
3	#5722.90	74.1 PK	78.2	-4.1	1.58 V	10	68.00	6.10
4	#5725.00	65.2 PK	78.2	-13.0	1.58 V	10	59.10	6.10
5	*5745.00	109.5 PK			1.58 V	1	69.20	40.30
6	*5745.00	99.3 AV			1.58 V	1	59.00	40.30
7	11490.00	58.4 PK	74.0	-15.6	1.00 V	98	40.80	17.60
8	11490.00	46.9 AV	54.0	-7.1	1.00 V	98	29.30	17.60

REMARKS:

1. Emission Level(dBuV/m) = Raw Value(dBuV) + Correction Factor(dB/m)
2. Correction Factor(dB/m) = Antenna Factor(dB/m) + Cable Factor(dB)
3. The other emission levels were very low against the limit.
4. Margin value = Emission Level – Limit value
5. " * ": Fundamental frequency.
6. " # ": The radiated frequency is out of the restricted band.

CHANNEL	TX Channel 157	DETECTOR FUNCTION	Peak (PK)
FREQUENCY RANGE	1GHz ~ 40GHz		Average (AV)

ANTENNA POLARITY & TEST DISTANCE: HORIZONTAL AT 3 M

NO.	FREQ. (MHz)	EMISSION LEVEL (dBuV/m)	LIMIT (dBuV/m)	MARGIN (dB)	ANTENNA HEIGHT (m)	TABLE ANGLE (Degree)	RAW VALUE (dBuV)	CORRECTION FACTOR (dB/m)
1	#5714.90	72.1 PK	74.0	-1.9	1.90 H	2	66.10	6.00
2	#5714.90	53.3 AV	54.0	-0.7	1.90 H	2	47.30	6.00
3	*5785.00	117.2 PK			1.97 H	358	76.90	40.30
4	*5785.00	106.3 AV			1.97 H	358	66.00	40.30
5	11570.00	61.9 PK	74.0	-12.1	1.10 H	320	44.40	17.50
6	11570.00	48.9 AV	54.0	-5.1	1.10 H	320	31.40	17.50
7	11570.00	46.5 AV	54.0	-7.5	1.00 H	97	29.00	17.50

ANTENNA POLARITY & TEST DISTANCE: VERTICAL AT 3 M

NO.	FREQ. (MHz)	EMISSION LEVEL (dBuV/m)	LIMIT (dBuV/m)	MARGIN (dB)	ANTENNA HEIGHT (m)	TABLE ANGLE (Degree)	RAW VALUE (dBuV)	CORRECTION FACTOR (dB/m)
1	#5714.90	60.7 PK	74.0	-13.3	1.60 V	4	54.70	6.00
2	#5714.90	46.4 AV	54.0	-7.6	1.60 V	4	40.40	6.00
3	*5785.00	114.5 PK			1.63 V	9	74.20	40.30
4	*5785.00	103.2 AV			1.63 V	9	62.90	40.30
5	11570.00	58.9 PK	74.0	-15.1	1.00 V	94	41.40	17.50
6	11570.00	47.5 AV	54.0	-6.5	1.00 V	94	30.00	17.50
7	11570.00	47.9 AV	54.0	-6.1	1.34 V	62	30.40	17.50

REMARKS:

1. Emission Level(dBuV/m) = Raw Value(dBuV) + Correction Factor(dB/m)
2. Correction Factor(dB/m) = Antenna Factor(dB/m) + Cable Factor(dB)
3. The other emission levels were very low against the limit.
4. Margin value = Emission Level – Limit value
5. " * ": Fundamental frequency.

CHANNEL	TX Channel 165	DETECTOR FUNCTION	Peak (PK)
FREQUENCY RANGE	1GHz ~ 40GHz		Average (AV)

ANTENNA POLARITY & TEST DISTANCE: HORIZONTAL AT 3 M

NO.	FREQ. (MHz)	EMISSION LEVEL (dBuV/m)	LIMIT (dBuV/m)	MARGIN (dB)	ANTENNA HEIGHT (m)	TABLE ANGLE (Degree)	RAW VALUE (dBuV)	CORRECTION FACTOR (dB/m)
1	*5825.00	114.8 PK			1.73 H	3	74.40	40.40
2	*5825.00	104.8 AV			1.73 H	3	64.40	40.40
3	#5850.00	64.5 PK	78.2	-13.7	1.76 H	5	58.10	6.40
4	#5852.10	77.1 PK	78.2	-1.1	1.76 H	5	70.70	6.40
5	#5860.10	69.8 PK	74.0	-4.2	1.76 H	5	63.40	6.40
6	#5860.10	52.6 AV	54.0	-1.4	1.76 H	5	46.20	6.40
7	11650.00	61.8 PK	74.0	-12.2	1.11 H	321	44.50	17.30
8	11650.00	48.2 AV	54.0	-5.8	1.11 H	321	30.90	17.30

ANTENNA POLARITY & TEST DISTANCE: VERTICAL AT 3 M

NO.	FREQ. (MHz)	EMISSION LEVEL (dBuV/m)	LIMIT (dBuV/m)	MARGIN (dB)	ANTENNA HEIGHT (m)	TABLE ANGLE (Degree)	RAW VALUE (dBuV)	CORRECTION FACTOR (dB/m)
1	*5825.00	110.9 PK			1.48 V	4	70.50	40.40
2	*5825.00	100.9 AV			1.48 V	4	60.50	40.40
3	#5850.00	59.1 PK	78.2	-19.1	1.41 V	6	52.70	6.40
4	#5852.10	70.2 PK	78.2	-8.0	1.41 V	6	63.80	6.40
5	#5860.10	64.9 PK	74.0	-9.1	1.41 V	6	58.50	6.40
6	#5860.10	49.0 AV	54.0	-5.0	1.41 V	6	42.60	6.40
7	11650.00	58.5 PK	74.0	-15.5	1.00 V	97	41.20	17.30
8	11650.00	47.4 AV	54.0	-6.6	1.00 V	97	30.10	17.30

REMARKS:

1. Emission Level(dBuV/m) = Raw Value(dBuV) + Correction Factor(dB/m)
2. Correction Factor(dB/m) = Antenna Factor(dB/m) + Cable Factor(dB)
3. The other emission levels were very low against the limit.
4. Margin value = Emission Level – Limit value
5. " * ": Fundamental frequency.
6. " # ": The radiated frequency is out of the restricted band.

802.11n (HT20)

CHANNEL	TX Channel 36	DETECTOR FUNCTION	Peak (PK)
FREQUENCY RANGE	1GHz ~ 40GHz		Average (AV)

ANTENNA POLARITY & TEST DISTANCE: HORIZONTAL AT 3 M								
NO.	FREQ. (MHz)	EMISSION LEVEL (dBuV/m)	LIMIT (dBuV/m)	MARGIN (dB)	ANTENNA HEIGHT (m)	TABLE ANGLE (Degree)	RAW VALUE (dBuV)	CORRECTION FACTOR (dB/m)
1	5150.00	70.2 PK	74.0	-3.8	1.63 H	28	65.20	5.00
2	5150.00	53.7 AV	54.0	-0.3	1.63 H	28	48.70	5.00
3	*5180.00	114.1 PK			1.69 H	27	75.00	39.10
4	*5180.00	103.1 AV			1.69 H	27	64.00	39.10
5	#10360.00	61.1 PK	74.0	-12.9	1.15 H	321	44.00	17.10
6	#10360.00	49.1 AV	54.0	-4.9	1.15 H	321	32.00	17.10
ANTENNA POLARITY & TEST DISTANCE: VERTICAL AT 3 M								
NO.	FREQ. (MHz)	EMISSION LEVEL (dBuV/m)	LIMIT (dBuV/m)	MARGIN (dB)	ANTENNA HEIGHT (m)	TABLE ANGLE (Degree)	RAW VALUE (dBuV)	CORRECTION FACTOR (dB/m)
1	5150.00	66.2 PK	74.0	-7.8	1.00 V	359	61.20	5.00
2	5150.00	49.5 AV	54.0	-4.5	1.00 V	359	44.50	5.00
3	*5180.00	106.8 PK			1.00 V	358	67.70	39.10
4	*5180.00	96.5 AV			1.00 V	358	57.40	39.10
5	#10360.00	58.5 PK	74.0	-15.5	1.00 V	99	41.40	17.10
6	#10360.00	47.1 AV	54.0	-6.9	1.00 V	99	30.00	17.10

REMARKS:

1. Emission Level(dBuV/m) = Raw Value(dBuV) + Correction Factor(dB/m)
2. Correction Factor(dB/m) = Antenna Factor(dB/m) + Cable Factor(dB)
3. The other emission levels were very low against the limit.
4. Margin value = Emission Level – Limit value
5. " * ": Fundamental frequency.
6. " # ": The radiated frequency is out of the restricted band.

CHANNEL	TX Channel 40	DETECTOR FUNCTION	Peak (PK)
FREQUENCY RANGE	1GHz ~ 40GHz		Average (AV)

ANTENNA POLARITY & TEST DISTANCE: HORIZONTAL AT 3 M

NO.	FREQ. (MHz)	EMISSION LEVEL (dBuV/m)	LIMIT (dBuV/m)	MARGIN (dB)	ANTENNA HEIGHT (m)	TABLE ANGLE (Degree)	RAW VALUE (dBuV)	CORRECTION FACTOR (dB/m)
1	5150.00	71.9 PK	74.0	-2.1	1.90 H	25	66.90	5.00
2	5150.00	52.9 AV	54.0	-1.1	1.90 H	25	47.90	5.00
3	*5200.00	117.0 PK			1.93 H	27	77.80	39.20
4	*5200.00	105.8 AV			1.93 H	27	66.60	39.20
5	#10400.00	62.5 PK	74.0	-11.5	1.10 H	325	45.20	17.30
6	#10400.00	49.4 AV	54.0	-4.6	1.10 H	325	32.10	17.30

ANTENNA POLARITY & TEST DISTANCE: VERTICAL AT 3 M

NO.	FREQ. (MHz)	EMISSION LEVEL (dBuV/m)	LIMIT (dBuV/m)	MARGIN (dB)	ANTENNA HEIGHT (m)	TABLE ANGLE (Degree)	RAW VALUE (dBuV)	CORRECTION FACTOR (dB/m)
1	5150.00	67.0 PK	74.0	-7.0	1.00 V	353	62.00	5.00
2	5150.00	49.1 AV	54.0	-4.9	1.00 V	353	44.10	5.00
3	*5200.00	111.1 PK			1.06 V	357	71.90	39.20
4	*5200.00	99.4 AV			1.06 V	357	60.20	39.20
5	#10400.00	59.2 PK	74.0	-14.8	1.00 V	93	41.90	17.30
6	#10400.00	47.3 AV	54.0	-6.7	1.00 V	93	30.00	17.30

REMARKS:

1. Emission Level(dBuV/m) = Raw Value(dBuV) + Correction Factor(dB/m)
2. Correction Factor(dB/m) = Antenna Factor(dB/m) + Cable Factor(dB)
3. The other emission levels were very low against the limit.
4. Margin value = Emission Level – Limit value
5. " * ": Fundamental frequency.
6. " # ": The radiated frequency is out of the restricted band.

CHANNEL	TX Channel 48	DETECTOR FUNCTION	Peak (PK)
FREQUENCY RANGE	1GHz ~ 40GHz		Average (AV)

ANTENNA POLARITY & TEST DISTANCE: HORIZONTAL AT 3 M

NO.	FREQ. (MHz)	EMISSION LEVEL (dBuV/m)	LIMIT (dBuV/m)	MARGIN (dB)	ANTENNA HEIGHT (m)	TABLE ANGLE (Degree)	RAW VALUE (dBuV)	CORRECTION FACTOR (dB/m)
1	*5240.00	117.2 PK			1.82 H	29	78.00	39.20
2	*5240.00	105.7 AV			1.82 H	29	66.50	39.20
3	5350.00	67.1 PK	74.0	-6.9	1.83 H	28	61.70	5.40
4	5350.00	48.1 AV	54.0	-5.9	1.83 H	28	42.70	5.40
5	#10480.00	62.2 PK	74.0	-11.8	1.11 H	325	44.90	17.30
6	#10480.00	49.2 AV	54.0	-4.8	1.11 H	325	31.90	17.30

ANTENNA POLARITY & TEST DISTANCE: VERTICAL AT 3 M

NO.	FREQ. (MHz)	EMISSION LEVEL (dBuV/m)	LIMIT (dBuV/m)	MARGIN (dB)	ANTENNA HEIGHT (m)	TABLE ANGLE (Degree)	RAW VALUE (dBuV)	CORRECTION FACTOR (dB/m)
1	*5240.00	110.3 PK			2.24 V	343	71.10	39.20
2	*5240.00	98.4 AV			2.24 V	343	59.20	39.20
3	5350.00	58.8 PK	74.0	-15.2	2.28 V	346	53.40	5.40
4	5350.00	46.9 AV	54.0	-7.1	2.28 V	346	41.50	5.40
5	#10480.00	59.4 PK	74.0	-14.6	1.00 V	92	42.10	17.30
6	#10480.00	47.6 AV	54.0	-6.4	1.00 V	92	30.30	17.30

REMARKS:

1. Emission Level(dBuV/m) = Raw Value(dBuV) + Correction Factor(dB/m)
2. Correction Factor(dB/m) = Antenna Factor(dB/m) + Cable Factor(dB)
3. The other emission levels were very low against the limit.
4. Margin value = Emission Level – Limit value
5. " * ": Fundamental frequency.
6. " # ": The radiated frequency is out of the restricted band.

CHANNEL	TX Channel 149	DETECTOR FUNCTION	Peak (PK)
FREQUENCY RANGE	1GHz ~ 40GHz		Average (AV)

ANTENNA POLARITY & TEST DISTANCE: HORIZONTAL AT 3 M

NO.	FREQ. (MHz)	EMISSION LEVEL (dBuV/m)	LIMIT (dBuV/m)	MARGIN (dB)	ANTENNA HEIGHT (m)	TABLE ANGLE (Degree)	RAW VALUE (dBuV)	CORRECTION FACTOR (dB/m)
1	#5714.90	65.1 PK	74.0	-8.9	1.83 H	351	59.10	6.00
2	#5714.90	49.2 AV	54.0	-4.8	1.83 H	351	43.20	6.00
3	#5722.90	77.8 PK	78.2	-0.4	1.83 H	351	71.70	6.10
4	#5725.00	65.2 PK	78.2	-13.0	1.83 H	351	59.10	6.10
5	*5745.00	112.1 PK			1.82 H	354	71.80	40.30
6	*5745.00	101.2 AV			1.82 H	354	60.90	40.30
7	11490.00	60.9 PK	74.0	-13.1	1.12 H	324	43.30	17.60
8	11490.00	47.3 AV	54.0	-6.7	1.12 H	324	29.70	17.60

ANTENNA POLARITY & TEST DISTANCE: VERTICAL AT 3 M

NO.	FREQ. (MHz)	EMISSION LEVEL (dBuV/m)	LIMIT (dBuV/m)	MARGIN (dB)	ANTENNA HEIGHT (m)	TABLE ANGLE (Degree)	RAW VALUE (dBuV)	CORRECTION FACTOR (dB/m)
1	#5714.90	62.0 PK	74.0	-12.0	1.50 V	6	56.00	6.00
2	#5714.90	47.1 AV	54.0	-6.9	1.50 V	6	41.10	6.00
3	#5722.90	73.8 PK	78.2	-4.4	1.50 V	6	67.70	6.10
4	#5725.00	65.0 PK	78.2	-13.2	1.50 V	6	58.90	6.10
5	*5745.00	108.7 PK			1.51 V	1	68.40	40.30
6	*5745.00	97.9 AV			1.51 V	1	57.60	40.30
7	11490.00	58.2 PK	74.0	-15.8	1.00 V	96	40.60	17.60
8	11490.00	46.6 AV	54.0	-7.4	1.00 V	96	29.00	17.60

REMARKS:

1. Emission Level(dBuV/m) = Raw Value(dBuV) + Correction Factor(dB/m)
2. Correction Factor(dB/m) = Antenna Factor(dB/m) + Cable Factor(dB)
3. The other emission levels were very low against the limit.
4. Margin value = Emission Level – Limit value
5. " * ": Fundamental frequency.
6. " # ": The radiated frequency is out of the restricted band.

CHANNEL	TX Channel 157	DETECTOR FUNCTION	Peak (PK)
FREQUENCY RANGE	1GHz ~ 40GHz		Average (AV)

ANTENNA POLARITY & TEST DISTANCE: HORIZONTAL AT 3 M

NO.	FREQ. (MHz)	EMISSION LEVEL (dBuV/m)	LIMIT (dBuV/m)	MARGIN (dB)	ANTENNA HEIGHT (m)	TABLE ANGLE (Degree)	RAW VALUE (dBuV)	CORRECTION FACTOR (dB/m)
1	#5714.90	71.4 PK	74.0	-2.6	1.74 H	358	65.40	6.00
2	#5714.90	53.0 AV	54.0	-1.0	1.74 H	358	47.00	6.00
3	*5785.00	117.5 PK			1.74 H	359	77.20	40.30
4	*5785.00	106.3 AV			1.74 H	359	66.00	40.30
5	11570.00	61.7 PK	74.0	-12.3	1.12 H	324	44.20	17.50
6	11570.00	48.6 AV	54.0	-5.4	1.12 H	324	31.10	17.50

ANTENNA POLARITY & TEST DISTANCE: VERTICAL AT 3 M

NO.	FREQ. (MHz)	EMISSION LEVEL (dBuV/m)	LIMIT (dBuV/m)	MARGIN (dB)	ANTENNA HEIGHT (m)	TABLE ANGLE (Degree)	RAW VALUE (dBuV)	CORRECTION FACTOR (dB/m)
1	#5714.90	60.5 PK	74.0	-13.5	1.58 V	10	54.50	6.00
2	#5714.90	46.0 AV	54.0	-8.0	1.58 V	10	40.00	6.00
3	*5785.00	114.0 PK			1.57 V	1	73.70	40.30
4	*5785.00	102.6 AV			1.57 V	1	62.30	40.30
5	11570.00	58.7 PK	74.0	-15.3	1.00 V	98	41.20	17.50
6	11570.00	46.9 AV	54.0	-7.1	1.00 V	98	29.40	17.50

REMARKS:

1. Emission Level(dBuV/m) = Raw Value(dBuV) + Correction Factor(dB/m)
2. Correction Factor(dB/m) = Antenna Factor(dB/m) + Cable Factor(dB)
3. The other emission levels were very low against the limit.
4. Margin value = Emission Level – Limit value
5. " * " : Fundamental frequency.



CHANNEL	TX Channel 165	DETECTOR FUNCTION	Peak (PK)
FREQUENCY RANGE	1GHz ~ 40GHz		Average (AV)

ANTENNA POLARITY & TEST DISTANCE: HORIZONTAL AT 3 M

NO.	FREQ. (MHz)	EMISSION LEVEL (dBuV/m)	LIMIT (dBuV/m)	MARGIN (dB)	ANTENNA HEIGHT (m)	TABLE ANGLE (Degree)	RAW VALUE (dBuV)	CORRECTION FACTOR (dB/m)
1	*5825.00	114.6 PK			1.88 H	3	74.20	40.40
2	*5825.00	104.0 AV			1.88 H	3	63.60	40.40
3	#5850.00	67.6 PK	78.2	-10.6	1.82 H	5	61.20	6.40
4	#5852.10	77.3 PK	78.2	-0.9	1.82 H	5	70.90	6.40
5	#5860.10	72.6 PK	74.0	-1.4	1.82 H	5	66.20	6.40
6	#5860.10	52.9 AV	54.0	-1.1	1.82 H	5	46.50	6.40
7	11650.00	61.6 PK	74.0	-12.4	1.13 H	327	44.30	17.30
8	11650.00	47.9 AV	54.0	-6.1	1.13 H	327	30.60	17.30

ANTENNA POLARITY & TEST DISTANCE: VERTICAL AT 3 M

NO.	FREQ. (MHz)	EMISSION LEVEL (dBuV/m)	LIMIT (dBuV/m)	MARGIN (dB)	ANTENNA HEIGHT (m)	TABLE ANGLE (Degree)	RAW VALUE (dBuV)	CORRECTION FACTOR (dB/m)
1	*5825.00	111.5 PK			1.62 V	8	71.10	40.40
2	*5825.00	100.8 AV			1.62 V	8	60.40	40.40
3	#5850.00	58.8 PK	78.2	-19.4	1.63 V	4	52.40	6.40
4	#5852.10	70.0 PK	78.2	-8.2	1.63 V	4	63.60	6.40
5	#5860.10	64.8 PK	74.0	-9.2	1.63 V	4	58.40	6.40
6	#5860.10	48.4 AV	54.0	-5.6	1.63 V	4	42.00	6.40
7	11650.00	58.2 PK	74.0	-15.8	1.00 V	91	40.90	17.30
8	11650.00	46.8 AV	54.0	-7.2	1.00 V	91	29.50	17.30

REMARKS:

1. Emission Level(dBuV/m) = Raw Value(dBuV) + Correction Factor(dB/m)
2. Correction Factor(dB/m) = Antenna Factor(dB/m) + Cable Factor(dB)
3. The other emission levels were very low against the limit.
4. Margin value = Emission Level – Limit value
5. " * ": Fundamental frequency.
6. " # ": The radiated frequency is out of the restricted band.

802.11n (HT40)

CHANNEL	TX Channel 38	DETECTOR FUNCTION	Peak (PK)
FREQUENCY RANGE	1GHz ~ 40GHz		Average (AV)

ANTENNA POLARITY & TEST DISTANCE: HORIZONTAL AT 3 M								
NO.	FREQ. (MHz)	EMISSION LEVEL (dBuV/m)	LIMIT (dBuV/m)	MARGIN (dB)	ANTENNA HEIGHT (m)	TABLE ANGLE (Degree)	RAW VALUE (dBuV)	CORRECTION FACTOR (dB/m)
1	5150.00	71.2 PK	74.0	-2.8	1.74 H	22	66.20	5.00
2	5150.00	53.5 AV	54.0	-0.5	1.74 H	22	48.50	5.00
3	*5190.00	106.9 PK			1.75 H	26	67.80	39.10
4	*5190.00	96.1 AV			1.75 H	26	57.00	39.10
5	#10380.00	60.7 PK	74.0	-13.3	1.12 H	326	43.50	17.20
6	#10380.00	48.7 AV	54.0	-5.3	1.12 H	326	31.50	17.20

ANTENNA POLARITY & TEST DISTANCE: VERTICAL AT 3 M								
NO.	FREQ. (MHz)	EMISSION LEVEL (dBuV/m)	LIMIT (dBuV/m)	MARGIN (dB)	ANTENNA HEIGHT (m)	TABLE ANGLE (Degree)	RAW VALUE (dBuV)	CORRECTION FACTOR (dB/m)
1	5150.00	65.6 PK	74.0	-8.4	1.02 V	357	60.60	5.00
2	5150.00	47.3 AV	54.0	-6.7	1.02 V	357	42.30	5.00
3	*5190.00	100.8 PK			1.05 V	358	61.70	39.10
4	*5190.00	90.1 AV			1.05 V	358	51.00	39.10
5	#10380.00	57.8 PK	74.0	-16.2	1.00 V	95	40.60	17.20
6	#10380.00	46.1 AV	54.0	-7.9	1.00 V	95	28.90	17.20

REMARKS:

1. Emission Level(dBuV/m) = Raw Value(dBuV) + Correction Factor(dB/m)
2. Correction Factor(dB/m) = Antenna Factor(dB/m) + Cable Factor(dB)
3. The other emission levels were very low against the limit.
4. Margin value = Emission Level – Limit value
5. " * ": Fundamental frequency.
6. " # ": The radiated frequency is out of the restricted band.

CHANNEL	TX Channel 46	DETECTOR FUNCTION	Peak (PK)
FREQUENCY RANGE	1GHz ~ 40GHz		Average (AV)

ANTENNA POLARITY & TEST DISTANCE: HORIZONTAL AT 3 M

NO.	FREQ. (MHz)	EMISSION LEVEL (dBuV/m)	LIMIT (dBuV/m)	MARGIN (dB)	ANTENNA HEIGHT (m)	TABLE ANGLE (Degree)	RAW VALUE (dBuV)	CORRECTION FACTOR (dB/m)
1	5150.00	73.1 PK	74.0	-0.9	1.78 H	29	68.10	5.00
2	5150.00	53.8 AV	54.0	-0.2	1.78 H	29	48.80	5.00
3	*5230.00	112.5 PK			1.75 H	29	73.30	39.20
4	*5230.00	101.6 AV			1.75 H	29	62.40	39.20
5	#10460.00	61.8 PK	74.0	-12.2	1.11 H	327	44.60	17.20
6	#10460.00	49.0 AV	54.0	-5.0	1.11 H	327	31.80	17.20

ANTENNA POLARITY & TEST DISTANCE: VERTICAL AT 3 M

NO.	FREQ. (MHz)	EMISSION LEVEL (dBuV/m)	LIMIT (dBuV/m)	MARGIN (dB)	ANTENNA HEIGHT (m)	TABLE ANGLE (Degree)	RAW VALUE (dBuV)	CORRECTION FACTOR (dB/m)
1	5150.00	66.5 PK	74.0	-7.5	1.06 V	357	61.50	5.00
2	5150.00	48.9 AV	54.0	-5.1	1.06 V	357	43.90	5.00
3	*5230.00	105.8 PK			1.06 V	358	66.60	39.20
4	*5230.00	95.3 AV			1.06 V	358	56.10	39.20
5	#10460.00	58.4 PK	74.0	-15.6	1.00 V	91	41.20	17.20
6	#10460.00	46.8 AV	54.0	-7.2	1.00 V	91	29.60	17.20

REMARKS:

1. Emission Level(dBuV/m) = Raw Value(dBuV) + Correction Factor(dB/m)
2. Correction Factor(dB/m) = Antenna Factor(dB/m) + Cable Factor(dB)
3. The other emission levels were very low against the limit.
4. Margin value = Emission Level – Limit value
5. " * ": Fundamental frequency.
6. " # ": The radiated frequency is out of the restricted band.

CHANNEL	TX Channel 151	DETECTOR FUNCTION	Peak (PK)
FREQUENCY RANGE	1GHz ~ 40GHz		Average (AV)

ANTENNA POLARITY & TEST DISTANCE: HORIZONTAL AT 3 M

NO.	FREQ. (MHz)	EMISSION LEVEL (dBuV/m)	LIMIT (dBuV/m)	MARGIN (dB)	ANTENNA HEIGHT (m)	TABLE ANGLE (Degree)	RAW VALUE (dBuV)	CORRECTION FACTOR (dB/m)
1	#5714.90	70.9 PK	74.0	-3.1	1.77 H	350	64.90	6.00
2	#5714.90	53.1 AV	54.0	-0.9	1.77 H	350	47.10	6.00
3	#5722.90	71.4 PK	78.2	-6.8	1.77 H	350	65.30	6.10
4	#5725.00	60.8 PK	78.2	-17.4	1.77 H	350	54.70	6.10
5	*5755.00	108.0 PK			1.76 H	355	67.70	40.30
6	*5755.00	97.4 AV			1.76 H	355	57.10	40.30
7	11510.00	60.7 PK	74.0	-13.3	1.17 H	327	43.30	17.40
8	11510.00	47.1 AV	54.0	-6.9	1.17 H	327	29.70	17.40

ANTENNA POLARITY & TEST DISTANCE: VERTICAL AT 3 M

NO.	FREQ. (MHz)	EMISSION LEVEL (dBuV/m)	LIMIT (dBuV/m)	MARGIN (dB)	ANTENNA HEIGHT (m)	TABLE ANGLE (Degree)	RAW VALUE (dBuV)	CORRECTION FACTOR (dB/m)
1	#5714.90	67.4 PK	74.0	-6.6	1.50 V	8	61.40	6.00
2	#5714.90	49.6 AV	54.0	-4.4	1.50 V	8	43.60	6.00
3	#5722.90	67.4 PK	78.2	-10.8	1.50 V	8	61.30	6.10
4	#5725.00	57.2 PK	78.2	-21.0	1.50 V	8	51.10	6.10
5	*5755.00	105.1 PK			1.50 V	3	64.80	40.30
6	*5755.00	94.1 AV			1.50 V	3	53.80	40.30
7	11510.00	57.6 PK	74.0	-16.4	1.00 V	98	40.20	17.40
8	11510.00	46.1 AV	54.0	-7.9	1.00 V	98	28.70	17.40

REMARKS:

1. Emission Level(dBuV/m) = Raw Value(dBuV) + Correction Factor(dB/m)
2. Correction Factor(dB/m) = Antenna Factor(dB/m) + Cable Factor(dB)
3. The other emission levels were very low against the limit.
4. Margin value = Emission Level – Limit value
5. " * ": Fundamental frequency.
6. " # ": The radiated frequency is out of the restricted band.



CHANNEL	TX Channel 159	DETECTOR FUNCTION	Peak (PK)
FREQUENCY RANGE	1GHz ~ 40GHz		Average (AV)

ANTENNA POLARITY & TEST DISTANCE: HORIZONTAL AT 3 M

NO.	FREQ. (MHz)	EMISSION LEVEL (dBuV/m)	LIMIT (dBuV/m)	MARGIN (dB)	ANTENNA HEIGHT (m)	TABLE ANGLE (Degree)	RAW VALUE (dBuV)	CORRECTION FACTOR (dB/m)
1	*5795.00	112.6 PK			1.80 H	1	72.30	40.30
2	*5795.00	101.2 AV			1.80 H	1	60.90	40.30
3	#5850.00	60.9 PK	78.2	-17.3	1.79 H	6	54.50	6.40
4	#5852.10	73.1 PK	78.2	-5.1	1.79 H	6	66.70	6.40
5	#5860.10	71.5 PK	74.0	-2.5	1.79 H	6	65.10	6.40
6	#5860.10	53.4 AV	54.0	-0.6	1.79 H	6	47.00	6.40
7	11590.00	60.9 PK	74.0	-13.1	1.13 H	325	43.60	17.30
8	11590.00	47.3 AV	54.0	-6.7	1.13 H	325	30.00	17.30

ANTENNA POLARITY & TEST DISTANCE: VERTICAL AT 3 M

NO.	FREQ. (MHz)	EMISSION LEVEL (dBuV/m)	LIMIT (dBuV/m)	MARGIN (dB)	ANTENNA HEIGHT (m)	TABLE ANGLE (Degree)	RAW VALUE (dBuV)	CORRECTION FACTOR (dB/m)
1	*5795.00	108.0 PK			1.55 V	358	67.70	40.30
2	*5795.00	97.7 AV			1.55 V	358	57.40	40.30
3	#5850.00	56.9 PK	78.2	-21.3	1.53 V	352	50.50	6.40
4	#5852.10	67.8 PK	78.2	-10.4	1.53 V	352	61.40	6.40
5	#5860.10	66.4 PK	74.0	-7.6	1.53 V	352	60.00	6.40
6	#5860.10	49.5 AV	54.0	-4.5	1.53 V	352	43.10	6.40
7	11590.00	57.8 PK	74.0	-16.2	1.00 V	95	40.50	17.30
8	11590.00	46.4 AV	54.0	-7.6	1.00 V	95	29.10	17.30

REMARKS:

1. Emission Level(dBuV/m) = Raw Value(dBuV) + Correction Factor(dB/m)
2. Correction Factor(dB/m) = Antenna Factor(dB/m) + Cable Factor(dB)
3. The other emission levels were very low against the limit.
4. Margin value = Emission Level – Limit value
5. " * ": Fundamental frequency.
6. " # ": The radiated frequency is out of the restricted band.

802.11ac (VHT80)

CHANNEL	TX Channel 42	DETECTOR FUNCTION	Peak (PK)
FREQUENCY RANGE	1GHz ~ 40GHz		Average (AV)

ANTENNA POLARITY & TEST DISTANCE: HORIZONTAL AT 3 M								
NO.	FREQ. (MHz)	EMISSION LEVEL (dBuV/m)	LIMIT (dBuV/m)	MARGIN (dB)	ANTENNA HEIGHT (m)	TABLE ANGLE (Degree)	RAW VALUE (dBuV)	CORRECTION FACTOR (dB/m)
1	5150.00	66.4 PK	74.0	-7.6	1.86 H	25	61.40	5.00
2	5150.00	53.0 AV	54.0	-1.0	1.86 H	25	48.00	5.00
3	*5210.00	104.7 PK			1.83 H	29	65.50	39.20
4	*5210.00	93.7 AV			1.83 H	29	54.50	39.20
5	#10420.00	60.2 PK	74.0	-13.8	1.13 H	325	42.90	17.30
6	#10420.00	48.2 AV	54.0	-5.8	1.13 H	325	30.90	17.30

ANTENNA POLARITY & TEST DISTANCE: VERTICAL AT 3 M								
NO.	FREQ. (MHz)	EMISSION LEVEL (dBuV/m)	LIMIT (dBuV/m)	MARGIN (dB)	ANTENNA HEIGHT (m)	TABLE ANGLE (Degree)	RAW VALUE (dBuV)	CORRECTION FACTOR (dB/m)
1	5150.00	60.2 PK	74.0	-13.8	1.01 V	355	55.20	5.00
2	5150.00	45.9 AV	54.0	-8.1	1.01 V	355	40.90	5.00
3	*5210.00	98.5 PK			1.05 V	357	59.30	39.20
4	*5210.00	87.4 AV			1.05 V	357	48.20	39.20
5	#10420.00	57.3 PK	74.0	-16.7	1.00 V	94	40.00	17.30
6	#10420.00	45.6 AV	54.0	-8.4	1.00 V	94	28.30	17.30

REMARKS:

1. Emission Level(dBuV/m) = Raw Value(dBuV) + Correction Factor(dB/m)
2. Correction Factor(dB/m) = Antenna Factor(dB/m) + Cable Factor(dB)
3. The other emission levels were very low against the limit.
4. Margin value = Emission Level – Limit value
5. " * ": Fundamental frequency.
6. " # ": The radiated frequency is out of the restricted band.

CHANNEL	TX Channel 155	DETECTOR FUNCTION	Peak (PK)
FREQUENCY RANGE	1GHz ~ 40GHz		Average (AV)

ANTENNA POLARITY & TEST DISTANCE: HORIZONTAL AT 3 M

NO.	FREQ. (MHz)	EMISSION LEVEL (dBuV/m)	LIMIT (dBuV/m)	MARGIN (dB)	ANTENNA HEIGHT (m)	TABLE ANGLE (Degree)	RAW VALUE (dBuV)	CORRECTION FACTOR (dB/m)
1	#5714.90	66.1 PK	74.0	-7.9	1.68 H	357	60.10	6.00
2	#5714.90	53.2 AV	54.0	-0.8	1.68 H	357	47.20	6.00
3	#5722.90	67.9 PK	78.2	-10.3	1.68 H	357	61.80	6.10
4	#5725.00	59.0 PK	78.2	-19.2	1.68 H	357	52.90	6.10
5	*5775.00	105.6 PK			1.62 H	358	65.30	40.30
6	*5775.00	94.5 AV			1.62 H	358	54.20	40.30
7	11550.00	60.1 PK	74.0	-13.9	1.11 H	325	42.70	17.40
8	11550.00	46.9 AV	54.0	-7.1	1.11 H	325	29.50	17.40

ANTENNA POLARITY & TEST DISTANCE: VERTICAL AT 3 M

NO.	FREQ. (MHz)	EMISSION LEVEL (dBuV/m)	LIMIT (dBuV/m)	MARGIN (dB)	ANTENNA HEIGHT (m)	TABLE ANGLE (Degree)	RAW VALUE (dBuV)	CORRECTION FACTOR (dB/m)
1	#5714.90	61.8 PK	74.0	-12.2	1.42 V	10	55.80	6.00
2	#5714.90	48.2 AV	54.0	-5.8	1.42 V	10	42.20	6.00
3	#5722.90	63.4 PK	78.2	-14.8	1.42 V	10	57.30	6.10
4	#5725.00	55.0 PK	78.2	-23.2	1.42 V	10	48.90	6.10
5	*5775.00	101.2 PK			1.49 V	4	60.90	40.30
6	*5775.00	90.0 AV			1.49 V	4	49.70	40.30
7	11550.00	57.3 PK	74.0	-16.7	1.00 V	92	39.90	17.40
8	11550.00	45.7 AV	54.0	-8.3	1.00 V	92	28.30	17.40

REMARKS:

1. Emission Level(dBuV/m) = Raw Value(dBuV) + Correction Factor(dB/m)
2. Correction Factor(dB/m) = Antenna Factor(dB/m) + Cable Factor(dB)
3. The other emission levels were very low against the limit.
4. Margin value = Emission Level – Limit value
5. " * ": Fundamental frequency.

Below 1GHz worst-case data:

Test Mode A

802.11a

CHANNEL	TX Channel 157	DETECTOR FUNCTION	Quasi-Peak (QP)
FREQUENCY RANGE	9kHz ~ 1GHz		

ANTENNA POLARITY & TEST DISTANCE: HORIZONTAL AT 3 M

NO.	FREQ. (MHz)	EMISSION LEVEL (dBuV/m)	LIMIT (dBuV/m)	MARGIN (dB)	ANTENNA HEIGHT (m)	TABLE ANGLE (Degree)	RAW VALUE (dBuV)	CORRECTION FACTOR (dB/m)
1	37.66	33.0 QP	40.0	-7.0	1.25 H	254	47.70	-14.70
2	148.26	30.2 QP	43.5	-13.3	1.50 H	247	43.90	-13.70
3	189.01	36.8 QP	43.5	-6.7	1.25 H	247	53.00	-16.20
4	198.71	39.1 QP	43.5	-4.4	1.00 H	241	55.70	-16.60
5	400.52	29.9 QP	46.0	-16.1	1.00 H	273	41.10	-11.20
6	794.42	27.6 QP	46.0	-18.4	1.00 H	10	30.80	-3.20

ANTENNA POLARITY & TEST DISTANCE: VERTICAL AT 3 M

NO.	FREQ. (MHz)	EMISSION LEVEL (dBuV/m)	LIMIT (dBuV/m)	MARGIN (dB)	ANTENNA HEIGHT (m)	TABLE ANGLE (Degree)	RAW VALUE (dBuV)	CORRECTION FACTOR (dB/m)
1	33.78	34.6 QP	40.0	-5.4	1.00 V	16	49.60	-15.00
2	51.24	35.6 QP	40.0	-4.4	1.25 V	102	49.50	-13.90
3	198.71	30.6 QP	43.5	-12.9	1.00 V	148	47.20	-16.60
4	212.30	31.4 QP	43.5	-12.1	1.00 V	125	47.90	-16.50
5	429.62	32.3 QP	46.0	-13.7	1.00 V	177	42.80	-10.50
6	540.23	28.3 QP	46.0	-17.7	1.75 V	192	37.20	-8.90

REMARKS:

1. Emission Level(dBuV/m) = Raw Value(dBuV) + Correction Factor(dB/m)
2. Correction Factor(dB/m) = Antenna Factor(dB/m) + Cable Factor(dB)
3. The other emission levels were very low against the limit.
4. Margin value = Emission Level – Limit value

Test Mode B
802.11a

CHANNEL	TX Channel 157	DETECTOR FUNCTION	Quasi-Peak (QP)
FREQUENCY RANGE	9kHz ~ 1GHz		

ANTENNA POLARITY & TEST DISTANCE: HORIZONTAL AT 3 M

NO.	FREQ. (MHz)	EMISSION LEVEL (dBuV/m)	LIMIT (dBuV/m)	MARGIN (dB)	ANTENNA HEIGHT (m)	TABLE ANGLE (Degree)	RAW VALUE (dBuV)	CORRECTION FACTOR (dB/m)
1	37.66	32.0 QP	40.0	-8.0	1.49 H	7	46.70	-14.70
2	97.81	27.6 QP	43.5	-15.9	1.25 H	283	46.40	-18.80
3	144.38	29.8 QP	43.5	-13.7	1.00 H	119	43.80	-14.00
4	198.71	39.8 QP	43.5	-3.7	1.49 H	111	56.40	-16.60
5	309.32	30.5 QP	46.0	-15.5	1.00 H	161	43.00	-12.50
6	780.83	28.1 QP	46.0	-17.9	1.49 H	7	31.40	-3.30

ANTENNA POLARITY & TEST DISTANCE: VERTICAL AT 3 M

NO.	FREQ. (MHz)	EMISSION LEVEL (dBuV/m)	LIMIT (dBuV/m)	MARGIN (dB)	ANTENNA HEIGHT (m)	TABLE ANGLE (Degree)	RAW VALUE (dBuV)	CORRECTION FACTOR (dB/m)
1	33.78	34.2 QP	40.0	-5.8	1.00 V	172	49.20	-15.00
2	62.89	34.9 QP	40.0	-5.1	1.00 V	336	49.60	-14.70
3	132.74	28.4 QP	43.5	-15.1	3.00 V	109	43.30	-14.90
4	198.71	39.7 QP	43.5	-3.8	1.00 V	126	56.30	-16.60
5	359.77	29.4 QP	46.0	-16.6	1.00 V	162	41.40	-12.00
6	600.38	30.1 QP	46.0	-15.9	1.00 V	12	37.20	-7.10

REMARKS:

1. Emission Level(dBuV/m) = Raw Value(dBuV) + Correction Factor(dB/m)
2. Correction Factor(dB/m) = Antenna Factor(dB/m) + Cable Factor(dB)
3. The other emission levels were very low against the limit.
4. Margin value = Emission Level – Limit value

Test Mode C

802.11a

CHANNEL	TX Channel 157	DETECTOR FUNCTION	Quasi-Peak (QP)
FREQUENCY RANGE	9kHz ~ 1GHz		

ANTENNA POLARITY & TEST DISTANCE: HORIZONTAL AT 3 M

NO.	FREQ. (MHz)	EMISSION LEVEL (dBuV/m)	LIMIT (dBuV/m)	MARGIN (dB)	ANTENNA HEIGHT (m)	TABLE ANGLE (Degree)	RAW VALUE (dBuV)	CORRECTION FACTOR (dB/m)
1	37.66	34.4 QP	40.0	-5.6	1.25 H	218	49.10	-14.70
2	148.26	29.6 QP	43.5	-13.9	1.00 H	264	43.30	-13.70
3	187.07	35.7 QP	43.5	-7.8	3.00 H	91	51.70	-16.00
4	198.71	38.9 QP	43.5	-4.6	1.25 H	240	55.50	-16.60
5	394.70	29.9 QP	46.0	-16.1	1.00 H	255	41.10	-11.20
6	794.42	26.9 QP	46.0	-19.1	1.25 H	8	30.10	-3.20

ANTENNA POLARITY & TEST DISTANCE: VERTICAL AT 3 M

NO.	FREQ. (MHz)	EMISSION LEVEL (dBuV/m)	LIMIT (dBuV/m)	MARGIN (dB)	ANTENNA HEIGHT (m)	TABLE ANGLE (Degree)	RAW VALUE (dBuV)	CORRECTION FACTOR (dB/m)
1	33.78	34.6 QP	40.0	-5.4	1.24 V	140	49.60	-15.00
2	51.24	35.9 QP	40.0	-4.1	1.00 V	44	49.80	-13.90
3	187.07	30.6 QP	43.5	-12.9	1.00 V	317	46.60	-16.00
4	212.30	32.5 QP	43.5	-11.0	1.00 V	175	49.00	-16.50
5	427.68	32.7 QP	46.0	-13.3	2.00 V	196	43.20	-10.50
6	547.99	28.6 QP	46.0	-17.4	1.00 V	337	37.30	-8.70

REMARKS:

1. Emission Level(dBuV/m) = Raw Value(dBuV) + Correction Factor(dB/m)
2. Correction Factor(dB/m) = Antenna Factor(dB/m) + Cable Factor(dB)
3. The other emission levels were very low against the limit.
4. Margin value = Emission Level – Limit value

Test Mode D
802.11a

CHANNEL	TX Channel 157	DETECTOR FUNCTION	Quasi-Peak (QP)
FREQUENCY RANGE	9kHz ~ 1GHz		

ANTENNA POLARITY & TEST DISTANCE: HORIZONTAL AT 3 M

NO.	FREQ. (MHz)	EMISSION LEVEL (dBuV/m)	LIMIT (dBuV/m)	MARGIN (dB)	ANTENNA HEIGHT (m)	TABLE ANGLE (Degree)	RAW VALUE (dBuV)	CORRECTION FACTOR (dB/m)
1	37.66	30.7 QP	40.0	-9.3	1.50 H	90	45.40	-14.70
2	97.81	29.1 QP	43.5	-14.4	1.75 H	272	47.90	-18.80
3	148.26	29.6 QP	43.5	-13.9	1.50 H	281	43.30	-13.70
4	198.71	39.6 QP	43.5	-3.9	1.50 H	122	56.20	-16.60
5	307.38	29.7 QP	46.0	-16.3	1.00 H	147	42.30	-12.60
6	794.42	27.2 QP	46.0	-18.8	1.00 H	157	30.40	-3.20

ANTENNA POLARITY & TEST DISTANCE: VERTICAL AT 3 M

NO.	FREQ. (MHz)	EMISSION LEVEL (dBuV/m)	LIMIT (dBuV/m)	MARGIN (dB)	ANTENNA HEIGHT (m)	TABLE ANGLE (Degree)	RAW VALUE (dBuV)	CORRECTION FACTOR (dB/m)
1	33.78	34.7 QP	40.0	-5.3	1.00 V	170	49.70	-15.00
2	62.89	33.9 QP	40.0	-6.1	1.00 V	316	48.60	-14.70
3	136.62	28.5 QP	43.5	-15.0	1.00 V	129	43.20	-14.70
4	198.71	40.1 QP	43.5	-3.4	1.00 V	159	56.70	-16.60
5	274.39	29.6 QP	46.0	-16.4	2.00 V	254	42.90	-13.30
6	600.38	29.3 QP	46.0	-16.7	1.00 V	354	36.40	-7.10

REMARKS:

1. Emission Level(dBuV/m) = Raw Value(dBuV) + Correction Factor(dB/m)
2. Correction Factor(dB/m) = Antenna Factor(dB/m) + Cable Factor(dB)
3. The other emission levels were very low against the limit.
4. Margin value = Emission Level – Limit value

4.2 Conducted Emission Measurement

4.2.1 Limits of Conducted Emission Measurement

Frequency (MHz)	Conducted Limit (dBuV)	
	Quasi-peak	Average
0.15 - 0.5	66 - 56	56 - 46
0.50 - 5.0	56	46
5.0 - 30.0	60	50

- Note:** 1. The lower limit shall apply at the transition frequencies.
 2. The limit decreases in line with the logarithm of the frequency in the range of 0.15 to 0.50MHz.

4.2.2 Test Instruments

Description & Manufacturer	Model No.	Serial No.	Date Of Calibration	Due Date Of Calibration
Test Receiver ROHDE & SCHWARZ	ESCS 30	100288	Apr. 27, 2015	Apr. 26, 2016
RF signal cable (with 10dB PAD) Woken	5D-FB	Cable-cond2-01	Dec. 26, 2015	Dec. 25, 2016
LISN ROHDE & SCHWARZ (EUT)	ESH3-Z5	835239/001	Feb. 26, 2015	Feb. 25, 2016
LISN ROHDE & SCHWARZ (Peripheral)	ESH3-Z5	100312	Jul. 21, 2015	Jul. 20, 2016
Software ADT	BV ADT_Cond_ V7.3.7.3	NA	NA	NA

- Note:** 1. The calibration interval of the above test instruments is 12 months and the calibrations are traceable to NML/ROC and NIST/USA.
 2. The test was performed in HwaYa Shielded Room 2.
 3. The VCCI Site Registration No. is C-2047.

4.2.3 Test Procedures

- The EUT was placed 0.4 meters from the conducting wall of the shielded room with EUT being connected to the power mains through a line impedance stabilization network (LISN). Other support units were connected to the power mains through another LISN. The two LISNs provide 50 ohm/ 50uH of coupling impedance for the measuring instrument.
- Both lines of the power mains connected to the EUT were checked for maximum conducted interference.
- The frequency range from 150kHz to 30MHz was searched. Emission levels under (Limit - 20dB) was not recorded.

NOTE: The resolution bandwidth and video bandwidth of test receiver is 9kHz for quasi-peak detection (QP) and average detection (AV) at frequency 0.15MHz-30MHz.

4.2.4 Deviation from Test Standard

No deviation.

4.2.5 Test Setup

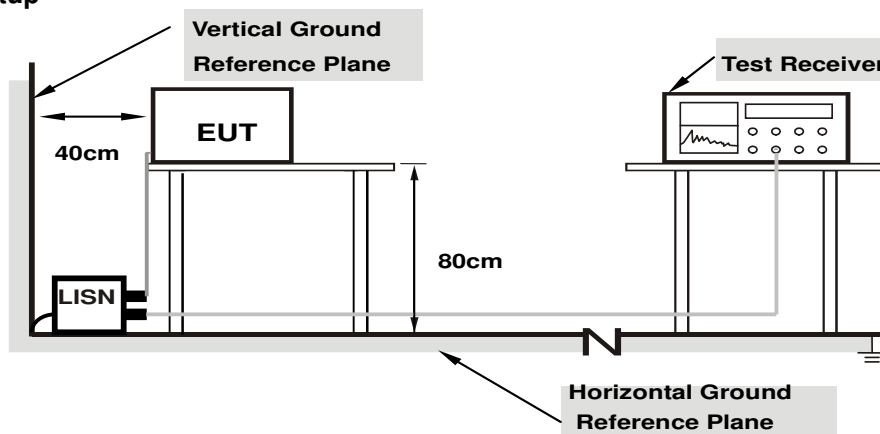

Note: 1.Support units were connected to second LISN.

For the actual test configuration, please refer to the attached file (Test Setup Photo).

4.2.6 EUT Operating Conditions

Same as 4.1.6.

4.2.7 Test Results

Phase	Line (L)	Detector Function	Quasi-Peak (QP) / Average (AV)
Test Mode	A		

No	Freq. [MHz]	Corr. Factor (dB)	Reading Value [dB (uV)]		Emission Level [dB (uV)]		Limit [dB (uV)]		Margin (dB)	
			Q.P.	AV.	Q.P.	AV.	Q.P.	AV.	Q.P.	AV.
			1	0.15000	10.10	39.67	30.74	49.77	40.84	66.00
2	0.38828	10.15	38.87	34.67	49.02	44.82	58.10	48.10	-9.08	-3.28
3	0.68906	10.17	23.07	14.60	33.24	24.77	56.00	46.00	-22.76	-21.23
4	1.53125	10.22	18.85	11.83	29.07	22.05	56.00	46.00	-26.93	-23.95
5	5.08984	10.35	14.97	8.17	25.32	18.52	60.00	50.00	-34.68	-31.48
6	11.85547	10.47	6.33	0.68	16.80	11.15	60.00	50.00	-43.20	-38.85

REMARKS:

1. Q.P. and AV. are abbreviations of quasi-peak and average individually.
2. The emission levels of other frequencies were very low against the limit.
3. Margin value = Emission level - Limit value
4. Correction factor = Insertion loss + Cable loss
5. Emission Level = Correction Factor + Reading Value.

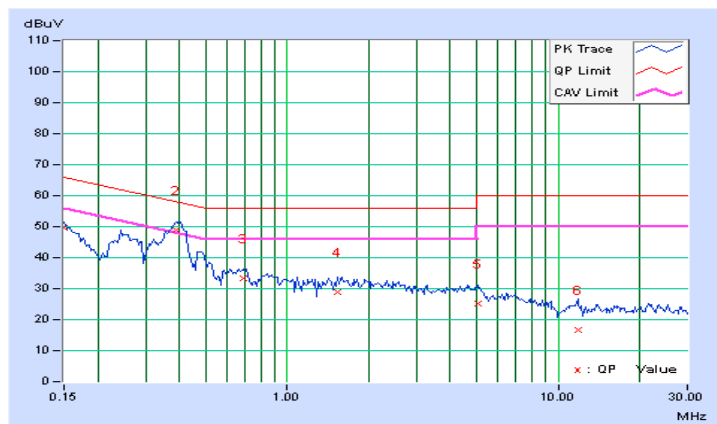

Phase	Neutral (N)	Detector Function	Quasi-Peak (QP) / Average (AV)
Test Mode	A		

No	Freq. [MHz]	Corr. Factor (dB)	Reading Value		Emission Level		Limit		Margin	
			[dB (uV)]		[dB (uV)]		[dB (uV)]		(dB)	
			Q.P.	AV.	Q.P.	AV.	Q.P.	AV.	Q.P.	AV.
1	0.15000	10.11	40.88	31.28	50.99	41.39	66.00	56.00	-15.01	-14.61
2	0.40000	10.17	39.40	30.12	49.57	40.29	57.85	47.85	-8.28	-7.56
3	0.70859	10.19	22.55	10.85	32.74	21.04	56.00	46.00	-23.26	-24.96
4	1.80859	10.26	18.12	11.62	28.38	21.88	56.00	46.00	-27.62	-24.12
5	4.71484	10.37	16.48	10.37	26.85	20.74	56.00	46.00	-29.15	-25.26
6	10.83984	10.55	11.05	6.13	21.60	16.68	60.00	50.00	-38.40	-33.32

REMARKS:

1. Q.P. and AV. are abbreviations of quasi-peak and average individually.
2. The emission levels of other frequencies were very low against the limit.
3. Margin value = Emission level - Limit value
4. Correction factor = Insertion loss + Cable loss
5. Emission Level = Correction Factor + Reading Value.

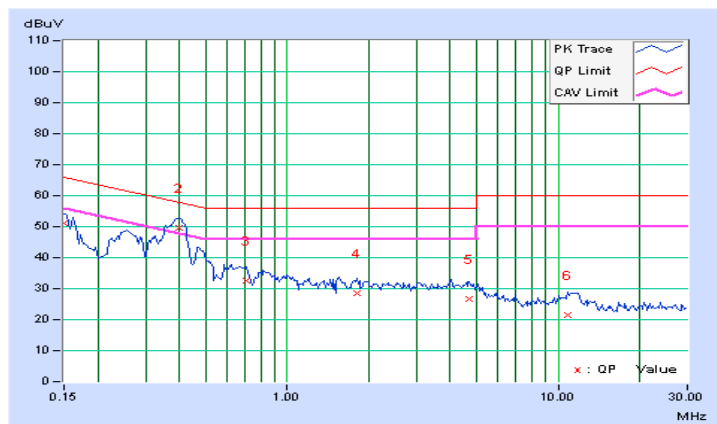

Phase	Line (L)	Detector Function	Quasi-Peak (QP) / Average (AV)
Test Mode	B		

No	Freq. [MHz]	Corr. Factor (dB)	Reading Value [dB (uV)]		Emission Level [dB (uV)]		Limit [dB (uV)]		Margin (dB)	
			Q.P.	AV.	Q.P.	AV.	Q.P.	AV.	Q.P.	AV.
			1	0.15781	10.10	39.50	26.92	49.60	37.02	65.58
2	0.20078	10.11	34.20	26.07	44.31	36.18	63.58	53.58	-19.27	-17.40
3	0.40391	10.15	30.28	25.20	40.43	35.35	57.77	47.77	-17.34	-12.42
4	1.16016	10.20	18.39	11.57	28.59	21.77	56.00	46.00	-27.41	-24.23
5	9.64453	10.45	16.28	10.69	26.73	21.14	60.00	50.00	-33.27	-28.86
6	23.93750	10.49	21.87	16.44	32.36	26.93	60.00	50.00	-27.64	-23.07

REMARKS:

1. Q.P. and AV. are abbreviations of quasi-peak and average individually.
2. The emission levels of other frequencies were very low against the limit.
3. Margin value = Emission level - Limit value
4. Correction factor = Insertion loss + Cable loss
5. Emission Level = Correction Factor + Reading Value.

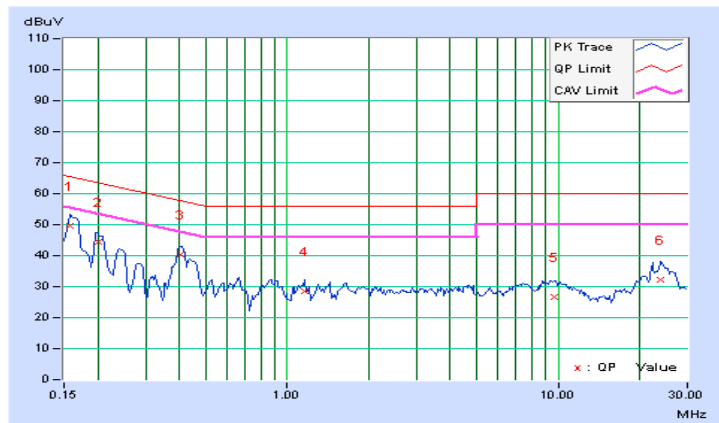

Phase	Neutral (N)	Detector Function	Quasi-Peak (QP) / Average (AV)
Test Mode	B		

No	Freq. [MHz]	Corr. Factor (dB)	Reading Value [dB (uV)]		Emission Level [dB (uV)]		Limit [dB (uV)]		Margin (dB)	
			Q.P.	AV.	Q.P.	AV.	Q.P.	AV.	Q.P.	AV.
			1	0.15781	10.11	39.75	26.68	49.86	36.79	65.58
2	0.19687	10.12	33.53	20.75	43.65	30.87	63.74	53.74	-20.09	-22.87
3	0.40781	10.17	28.91	23.94	39.08	34.11	57.69	47.69	-18.61	-13.58
4	0.85703	10.19	16.11	8.93	26.30	19.12	56.00	46.00	-29.70	-26.88
5	8.19922	10.48	13.29	7.84	23.77	18.32	60.00	50.00	-36.23	-31.68
6	24.41406	10.63	21.32	16.10	31.95	26.73	60.00	50.00	-28.05	-23.27

REMARKS:

1. Q.P. and AV. are abbreviations of quasi-peak and average individually.
2. The emission levels of other frequencies were very low against the limit.
3. Margin value = Emission level - Limit value
4. Correction factor = Insertion loss + Cable loss
5. Emission Level = Correction Factor + Reading Value.

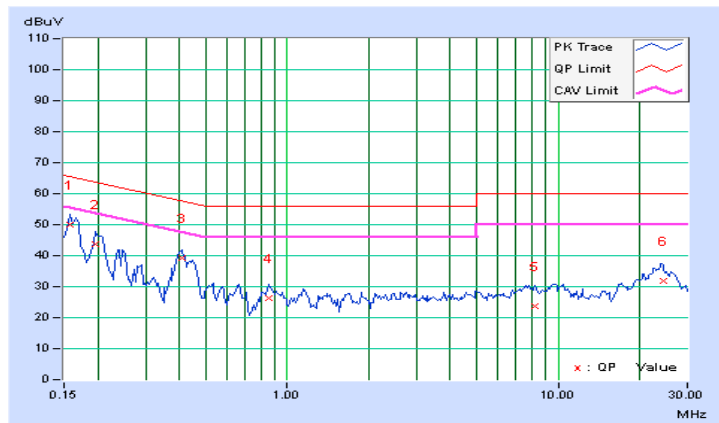

Phase	Line (L)	Detector Function	Quasi-Peak (QP) / Average (AV)
Test Mode	C		

No	Freq. [MHz]	Corr. Factor (dB)	Reading Value [dB (uV)]		Emission Level [dB (uV)]		Limit [dB (uV)]		Margin (dB)	
			Q.P.	AV.	Q.P.	AV.	Q.P.	AV.	Q.P.	AV.
			1	0.15391	10.10	38.80	27.88	48.90	37.98	65.79
2	0.25156	10.12	35.36	27.23	45.48	37.35	61.71	51.71	-16.23	-14.36
3	0.38828	10.15	38.97	34.26	49.12	44.41	58.10	48.10	-8.98	-3.69
4	1.64844	10.23	18.42	11.28	28.65	21.51	56.00	46.00	-27.35	-24.49
5	4.83594	10.34	15.61	8.53	25.95	18.87	56.00	46.00	-30.05	-27.13
6	17.76172	10.53	1.01	-3.44	11.54	7.09	60.00	50.00	-48.46	-42.91

REMARKS:

1. Q.P. and AV. are abbreviations of quasi-peak and average individually.
2. The emission levels of other frequencies were very low against the limit.
3. Margin value = Emission level - Limit value
4. Correction factor = Insertion loss + Cable loss
5. Emission Level = Correction Factor + Reading Value.

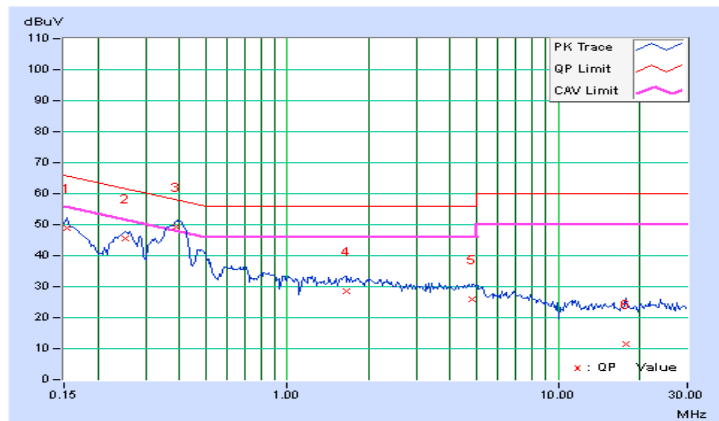

Phase	Neutral (N)	Detector Function	Quasi-Peak (QP) / Average (AV)
Test Mode	C		

No	Freq. [MHz]	Corr. Factor (dB)	Reading Value [dB (uV)]		Emission Level [dB (uV)]		Limit [dB (uV)]		Margin (dB)	
			Q.P.	AV.	Q.P.	AV.	Q.P.	AV.	Q.P.	AV.
			1	0.15000	10.11	40.88	31.34	50.99	41.45	66.00
2	0.40391	10.17	39.83	29.71	50.00	39.88	57.77	47.77	-7.77	-7.89
3	0.70078	10.19	23.26	13.93	33.45	24.12	56.00	46.00	-22.55	-21.88
4	1.60156	10.24	18.93	12.51	29.17	22.75	56.00	46.00	-26.83	-23.25
5	4.70313	10.37	16.37	10.40	26.74	20.77	56.00	46.00	-29.26	-25.23
6	11.13281	10.56	11.61	6.55	22.17	17.11	60.00	50.00	-37.83	-32.89

REMARKS:

1. Q.P. and AV. are abbreviations of quasi-peak and average individually.
2. The emission levels of other frequencies were very low against the limit.
3. Margin value = Emission level - Limit value
4. Correction factor = Insertion loss + Cable loss
5. Emission Level = Correction Factor + Reading Value.

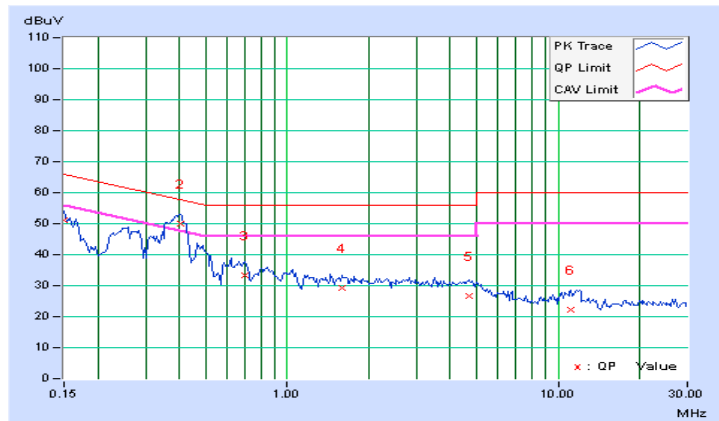

Phase	Line (L)	Detector Function	Quasi-Peak (QP) / Average (AV)
Test Mode	D		

No	Freq. [MHz]	Corr. Factor (dB)	Reading Value [dB (uV)]		Emission Level [dB (uV)]		Limit [dB (uV)]		Margin (dB)	
			Q.P.	AV.	Q.P.	AV.	Q.P.	AV.	Q.P.	AV.
			1	0.15781	10.10	39.36	27.39	49.46	37.49	65.58
2	0.39609	10.15	29.86	20.43	40.01	30.58	57.93	47.93	-17.93	-17.36
3	0.66172	10.17	20.18	13.20	30.35	23.37	56.00	46.00	-25.65	-22.63
4	1.15625	10.20	18.43	11.97	28.63	22.17	56.00	46.00	-27.37	-23.83
5	3.28906	10.30	13.75	7.60	24.05	17.90	56.00	46.00	-31.95	-28.10
6	23.73047	10.49	21.70	16.36	32.19	26.85	60.00	50.00	-27.81	-23.15

REMARKS:

1. Q.P. and AV. are abbreviations of quasi-peak and average individually.
2. The emission levels of other frequencies were very low against the limit.
3. Margin value = Emission level - Limit value
4. Correction factor = Insertion loss + Cable loss
5. Emission Level = Correction Factor + Reading Value.

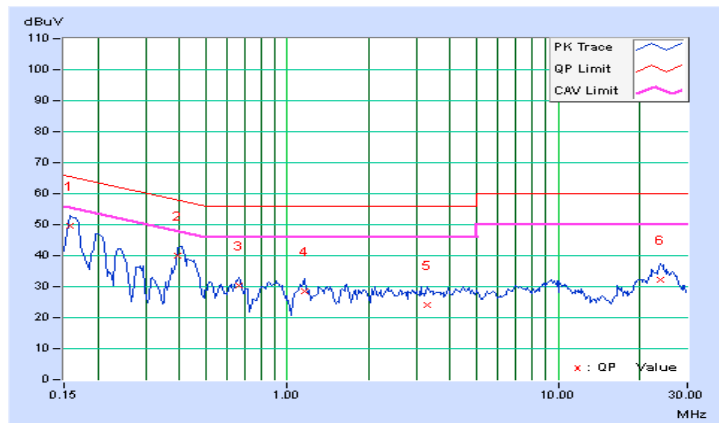

Phase	Neutral (N)	Detector Function	Quasi-Peak (QP) / Average (AV)
Test Mode	D		

No	Freq. [MHz]	Corr. Factor (dB)	Reading Value		Emission Level		Limit		Margin	
			[dB (uV)]		[dB (uV)]		[dB (uV)]		(dB)	
			Q.P.	AV.	Q.P.	AV.	Q.P.	AV.	Q.P.	AV.
1	0.16172	10.11	39.25	30.11	49.36	40.22	65.38	55.38	-16.01	-15.15
2	0.20078	10.12	33.17	24.32	43.29	34.44	63.58	53.58	-20.29	-19.14
3	0.40391	10.17	28.99	23.65	39.16	33.82	57.77	47.77	-18.61	-13.95
4	0.87266	10.19	16.39	8.65	26.58	18.84	56.00	46.00	-29.42	-27.16
5	7.35938	10.46	13.88	8.26	24.34	18.72	60.00	50.00	-35.66	-31.28
6	23.60938	10.65	21.23	15.89	31.88	26.54	60.00	50.00	-28.12	-23.46

REMARKS:

1. Q.P. and AV. are abbreviations of quasi-peak and average individually.
2. The emission levels of other frequencies were very low against the limit.
3. Margin value = Emission level - Limit value
4. Correction factor = Insertion loss + Cable loss
5. Emission Level = Correction Factor + Reading Value.

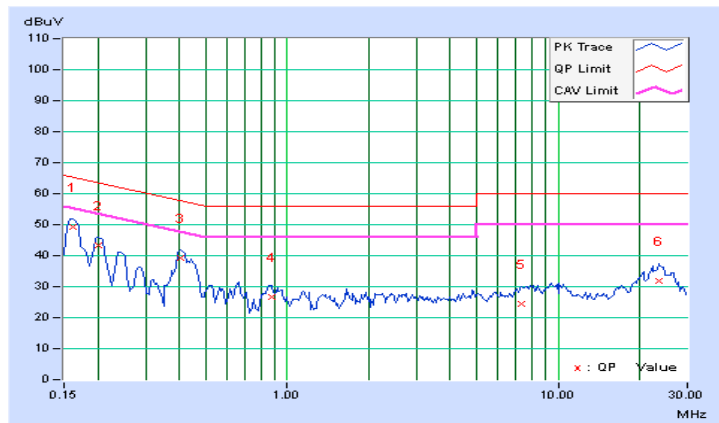

4.3 Transmit Power Measurement

4.3.1 Limits of Transmit Power Measurement

Operation Band	EUT Category		LIMIT
U-NII-1		Outdoor Access Point	1 Watt (30 dBm) (Max. e.i.r.p \leq 125mW(21 dBm) at any elevation angle above 30 degrees as measured from the horizon)
		Fixed point-to-point Access Point	1 Watt (30 dBm)
	√	Indoor Access Point	1 Watt (30 dBm)
		Mobile and Portable client device	250mW (24 dBm)
U-NII-2A	-		250mW (24 dBm) or 11 dBm+10 log B*
U-NII-2C	-		250mW (24 dBm) or 11 dBm+10 log B*
U-NII-3	√		1 Watt (30 dBm)

*B is the 26 dB emission bandwidth in megahertz

Per KDB 662911 Method of conducted output power measurement on IEEE 802.11 devices,

Array Gain = 0 dB (i.e., no array gain) for $N_{ANT} \leq 4$;

Array Gain = 0 dB (i.e., no array gain) for channel widths ≥ 40 MHz for any N_{ANT} ;

Array Gain = $5 \log(N_{ANT}/N_{SS})$ dB or 3 dB, whichever is less for 20-MHz channel widths with $N_{ANT} \geq 5$.

For power measurements on all other devices: Array Gain = $10 \log(N_{ANT}/N_{SS})$ dB.

4.3.2 Test Setup

For Power Output Measurement

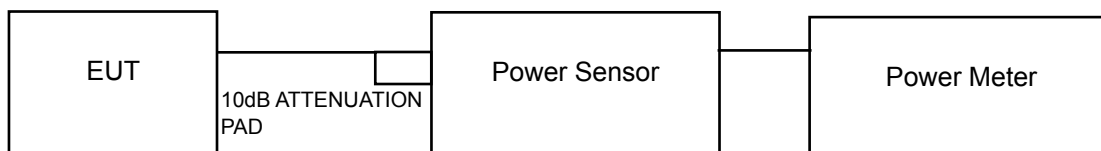

For 26dB and Occupied Bandwidth

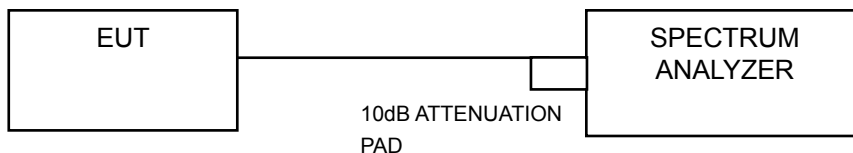

4.3.3 Test Instruments

Refer to section 4.1.2 to get information of above instrument.

4.3.4 Test Procedure

FOR AVERAGE POWER MEASUREMENT

For 802.11a, 802.11n (HT20), 802.11n (HT40)

Method PM is used to perform output power measurement, trigger and gating function of wide band power meter is enabled to measure max output power of TX on burst. Duty factor is not added to measured value.

For 802.11ac (VHT80)

- 1) Set span to encompass the entire 26 dB EBW (or, alternatively, the entire 99% occupied bandwidth) of the signal.
- 2) Set sweep trigger to "free run".
- 3) Set RBW = 1 MHz.
- 4) Set VBW \geq 3 MHz
- 5) Number of points in sweep \geq 2 Span / RBW.
- 6) Sweep time \leq (number of points in sweep) * T
- 7) Using emission bandwidth to determine the frequency span for integration the channel bandwidth.
- 8) Detector = RMS.
- 9) Trace mode = max hold.
- 10) Allow max hold to run for at least 60 seconds, or longer as needed to allow the trace to stabilize.

4.3.5 Deviation from Test Standard

No deviation.

4.3.6 EUT Operating Conditions

The software provided by client to enable the EUT under transmission condition continuously at lowest, middle and highest channel frequencies individually.

4.3.7 Test Result

POWER OUTPUT:

Test Mode A

1TX

802.11a

Chan.	Freq. (MHz)	Maximum Conducted Power (mW)	Maximum Conducted Power (dBm)	Power Limit (dBm)	Pass / Fail
36	5180	179.061	22.53	30	Pass
40	5200	326.588	25.14	30	Pass
48	5240	162.181	22.10	30	Pass
149	5745	63.973	18.06	30	Pass
157	5785	200.447	23.02	30	Pass
165	5825	124.738	20.96	30	Pass

802.11n (HT20)

Chan.	Freq. (MHz)	Maximum Conducted Power (mW)	Maximum Conducted Power (dBm)	Power Limit (dBm)	Pass / Fail
36	5180	163.305	22.13	30	Pass
40	5200	285.759	24.56	30	Pass
48	5240	158.489	22.00	30	Pass
149	5745	51.286	17.10	30	Pass
157	5785	214.783	23.32	30	Pass
165	5825	104.232	20.18	30	Pass

802.11n (HT40)

Chan.	Freq. (MHz)	Maximum Conducted Power (mW)	Maximum Conducted Power (dBm)	Power Limit (dBm)	Pass / Fail
38	5190	83.368	19.21	30	Pass
46	5230	207.491	23.17	30	Pass
151	5755	47.206	16.74	30	Pass
159	5795	118.032	20.72	30	Pass

802.11ac (VHT80)

Chan.	Freq. (MHz)	Maximum Conducted Power (mW)	Maximum Conducted Power (dBm)	Power Limit (dBm)	Pass / Fail
42	5210	38.194	15.82	30	Pass
155	5775	40.365	16.06	30	Pass

Test Mode A
2TX
802.11a

Chan.	Freq. (MHz)	Maximum Conducted Power (dBm)		Total Power (mW)	Total Power (dBm)	Power Limit (dBm)	Pass / Fail
		Chain 0	Chain 1				
36	5180	21.93	21.40	293.993	24.68	30	Pass
40	5200	24.27	24.23	532.151	27.26	30	Pass
48	5240	21.76	22.32	320.576	25.06	30	Pass
149	5745	17.48	17.90	117.636	20.71	30	Pass
157	5785	22.85	23.02	393.199	25.95	30	Pass
165	5825	20.37	20.48	220.579	23.44	30	Pass

802.11n (HT20)

Chan.	Freq. (MHz)	Maximum Conducted Power (dBm)		Total Power (mW)	Total Power (dBm)	Power Limit (dBm)	Pass / Fail
		Chain 0	Chain 1				
36	5180	21.44	20.52	252.036	24.01	28.81	Pass
40	5200	24.58	24.32	557.474	27.46	28.81	Pass
48	5240	21.61	22.42	319.459	25.04	28.81	Pass
149	5745	16.45	16.27	86.521	19.37	28.90	Pass
157	5785	22.25	22.45	343.672	25.36	28.90	Pass
165	5825	20.08	20.07	203.484	23.09	28.90	Pass

Note:

For U-NII-1: Directional gain = $10 \log[(10^{G1/20} + 10^{G2/20} + \dots + 10^{GN/20})^2/N]$ = 7.19dBi > 6dBi, so the power limit shall be reduced to 30-(7.19-6) = 28.81dBm.

For U-NII-3: Directional gain = $10 \log[(10^{G1/20} + 10^{G2/20} + \dots + 10^{GN/20})^2/N]$ = 7.10dBi > 6dBi, so the power limit shall be reduced to 30-(7.10-6) = 28.90dBm.

802.11n (HT40)

Chan.	Freq. (MHz)	Maximum Conducted Power (dBm)		Total Power (mW)	Total Power (dBm)	Power Limit (dBm)	Pass / Fail
		Chain 0	Chain 1				
38	5190	18.88	18.17	142.883	21.55	28.81	Pass
46	5230	22.93	21.71	344.588	25.37	28.81	Pass
151	5755	15.63	15.29	70.365	18.47	28.90	Pass
159	5795	20.10	19.97	201.641	23.05	28.90	Pass

Note:

For U-NII-1: Directional gain = $10 \log[(10^{G1/20} + 10^{G2/20} + \dots + 10^{GN/20})^2/N]$ = 7.19dBi > 6dBi, so the power limit shall be reduced to 30-(7.19-6) = 28.81dBm.

For U-NII-3: Directional gain = $10 \log[(10^{G1/20} + 10^{G2/20} + \dots + 10^{GN/20})^2/N]$ = 7.10dBi > 6dBi, so the power limit shall be reduced to 30-(7.10-6) = 28.90dBm.

802.11ac (VHT80)

Chan.	Freq. (MHz)	Maximum Conducted Power (dBm)		Total Power (mW)	Total Power (dBm)	Power Limit (dBm)	Pass / Fail
		Chain 0	Chain 1				
42	5210	17.16	16.71	98.881	19.95	28.81	Pass
155	5775	15.03	14.87	62.532	17.96	28.90	Pass

Note:

For U-NII-1: Directional gain = $10 \log[(10^{G1/20} + 10^{G2/20} + \dots + 10^{GN/20})^2/N]$ = 7.19dBi > 6dBi, so the power limit shall be reduced to $30-(7.19-6) = 28.81\text{dBm}$.

For U-NII-3: Directional gain = $10 \log[(10^{G1/20} + 10^{G2/20} + \dots + 10^{GN/20})^2/N]$ = 7.10dBi > 6dBi, so the power limit shall be reduced to $30-(7.10-6) = 28.90\text{dBm}$.

Test Mode A
3TX
802.11a

Chan.	Freq. (MHz)	Maximum Conducted Power (dBm)			Total Power (mW)	Total Power (dBm)	Power Limit (dBm)	Pass / Fail
		Chain 0	Chain 1	Chain 2				
36	5180	20.23	20.44	21.12	345.521	25.38	30.00	Pass
40	5200	22.31	22.52	22.61	531.255	27.25	30.00	Pass
48	5240	21.72	22.12	22.13	474.829	26.77	30.00	Pass
149	5745	17.58	18.09	17.77	181.538	22.59	30.00	Pass
157	5785	22.42	22.28	22.78	533.297	27.27	30.00	Pass
165	5825	20.28	20.07	19.98	307.826	24.88	30.00	Pass

802.11n (HT20)

Chan.	Freq. (MHz)	Maximum Conducted Power (dBm)			Total Power (mW)	Total Power (dBm)	Power Limit (dBm)	Pass / Fail
		Chain 0	Chain 1	Chain 2				
36	5180	20.23	20.71	21.12	352.620	25.47	27.27	Pass
40	5200	22.02	22.42	22.52	512.452	27.10	27.27	Pass
48	5240	22.06	22.31	22.53	509.971	27.08	27.27	Pass
149	5745	15.52	16.18	16.23	119.116	20.76	27.06	Pass
157	5785	22.13	20.91	20.61	401.695	26.04	27.06	Pass
165	5825	19.78	20.04	20.02	296.447	24.72	27.06	Pass

Note:

For U-NII-1: Directional gain = $10 \log[(10^{G1/20} + 10^{G2/20} + \dots + 10^{GN/20})^2/N]$ = 8.73dBi > 6dBi, so the power limit shall be reduced to $30 - (8.73 - 6) = 27.27$ dBm.

For U-NII-3: Directional gain = $10 \log[(10^{G1/20} + 10^{G2/20} + \dots + 10^{GN/20})^2/N]$ = 8.94dBi > 6dBi, so the power limit shall be reduced to $30 - (8.94 - 6) = 27.06$ dBm.

802.11n (HT40)

Chan.	Freq. (MHz)	Maximum Conducted Power (dBm)			Total Power (mW)	Total Power (dBm)	Power Limit (dBm)	Pass / Fail
		Chain 0	Chain 1	Chain 2				
38	5190	17.38	18.13	17.25	172.803	22.38	27.27	Pass
46	5230	23.02	21.56	22.16	508.103	27.06	27.27	Pass
151	5755	14.82	15.24	14.90	94.662	19.76	27.06	Pass
159	5795	20.01	20.05	19.84	297.772	24.74	27.06	Pass

Note:

For U-NII-1: Directional gain = $10 \log[(10^{G1/20} + 10^{G2/20} + \dots + 10^{GN/20})^2/N]$ = 8.73dBi > 6dBi, so the power limit shall be reduced to $30 - (8.73 - 6) = 27.27$ dBm.

For U-NII-3: Directional gain = $10 \log[(10^{G1/20} + 10^{G2/20} + \dots + 10^{GN/20})^2/N]$ = 8.94dBi > 6dBi, so the power limit shall be reduced to $30 - (8.94 - 6) = 27.06$ dBm.

802.11ac (VHT80)

Chan.	Freq. (MHz)	Maximum Conducted Power (dBm)			Total Power (mW)	Total Power (dBm)	Power Limit (dBm)	Pass / Fail
		Chain 0	Chain 1	Chain 2				
42	5210	15.47	16.08	15.55	111.680	20.48	27.27	Pass
155	5775	14.10	14.40	14.11	79.009	18.98	27.06	Pass

Note:

For U-NII-1: Directional gain = $10 \log[(10^{G1/20} + 10^{G2/20} + \dots + 10^{GN/20})^2/N]$ = 8.73dBi > 6dBi, so the power limit shall be reduced to $30-(8.73-6) = 27.27\text{dBm}$.

For U-NII-3: Directional gain = $10 \log[(10^{G1/20} + 10^{G2/20} + \dots + 10^{GN/20})^2/N]$ = 8.94dBi > 6dBi, so the power limit shall be reduced to $30-(8.94-6) = 27.06\text{dBm}$.

Test Mode A
4TX
802.11a

Chan.	Freq. (MHz)	Maximum Conducted Power (dBm)				Total Power (mW)	Total Power (dBm)	Power Limit (dBm)	Pass / Fail
		Chain 0	Chain 1	Chain 2	Chain 3				
36	5180	19.56	19.61	20.77	19.16	383.589	25.84	30.00	Pass
40	5200	19.52	19.34	20.47	18.82	363.074	25.60	30.00	Pass
48	5240	19.59	19.52	20.32	18.92	366.157	25.64	30.00	Pass
149	5745	17.37	17.63	16.68	17.22	211.801	23.26	30.00	Pass
157	5785	22.79	21.72	22.41	21.78	663.544	28.22	30.00	Pass
165	5825	19.51	18.92	19.09	19.21	331.778	25.21	30.00	Pass

802.11n (HT20)

Chan.	Freq. (MHz)	Maximum Conducted Power (dBm)				Total Power (mW)	Total Power (dBm)	Power Limit (dBm)	Pass / Fail
		Chain 0	Chain 1	Chain 2	Chain 3				
36	5180	19.45	19.37	20.42	19.58	375.538	25.75	26.04	Pass
40	5200	19.45	19.42	20.23	19.71	374.583	25.74	26.04	Pass
48	5240	19.51	19.56	20.43	19.72	383.860	25.84	26.04	Pass
149	5745	15.65	14.98	15.97	15.49	143.142	21.56	25.81	Pass
157	5785	18.82	18.21	18.65	18.72	290.185	24.63	25.81	Pass
165	5825	18.82	18.32	18.71	18.85	295.166	24.70	25.81	Pass

Note:

For U-NII-1: Directional gain = $10 \log[(10^{G1/20} + 10^{G2/20} + \dots + 10^{GN/20})^2/N]$ = 9.96dBi > 6dBi, so the power limit shall be reduced to $30-(9.96-6) = 26.04$ dBm.

For U-NII-3: Directional gain = $10 \log[(10^{G1/20} + 10^{G2/20} + \dots + 10^{GN/20})^2/N]$ = 10.19dBi > 6dBi, so the power limit shall be reduced to $30-(10.19-6) = 25.81$ dBm.

802.11n (HT40)

Chan.	Freq. (MHz)	Maximum Conducted Power (dBm)				Total Power (mW)	Total Power (dBm)	Power Limit (dBm)	Pass / Fail
		Chain 0	Chain 1	Chain 2	Chain 3				
38	5190	17.86	17.34	17.58	17.14	224.335	23.51	26.04	Pass
46	5230	20.25	19.21	20.05	19.36	376.749	25.76	26.04	Pass
151	5755	14.39	14.34	14.78	14.94	115.893	20.64	25.81	Pass
159	5795	19.21	18.65	18.72	18.71	305.425	24.85	25.81	Pass

Note:

For U-NII-1: Directional gain = $10 \log[(10^{G1/20} + 10^{G2/20} + \dots + 10^{GN/20})^2/N]$ = 9.96dBi > 6dBi, so the power limit shall be reduced to $30-(9.96-6) = 26.04$ dBm.

For U-NII-3: Directional gain = $10 \log[(10^{G1/20} + 10^{G2/20} + \dots + 10^{GN/20})^2/N]$ = 10.19dBi > 6dBi, so the power limit shall be reduced to $30-(10.19-6) = 25.81$ dBm.

802.11ac (VHT80)

Chan.	Freq. (MHz)	Maximum Conducted Power (dBm)				Total Power (mW)	Total Power (dBm)	Power Limit (dBm)	Pass / Fail
		Chain 0	Chain 1	Chain 2	Chain 3				
42	5210	15.46	15.32	16.04	15.62	145.851	21.64	26.04	Pass
155	5775	14.16	14.27	14.54	14.19	107.479	20.31	25.81	Pass

Note:

For U-NII-1: Directional gain = $10 \log[(10^{G1/20} + 10^{G2/20} + \dots + 10^{GN/20})^2/N]$ = 9.96dBi > 6dBi, so the power limit shall be reduced to $30-(9.96-6) = 26.04\text{dBm}$.

For U-NII-3: Directional gain = $10 \log[(10^{G1/20} + 10^{G2/20} + \dots + 10^{GN/20})^2/N]$ = 10.19dBi > 6dBi, so the power limit shall be reduced to $30-(10.19-6) = 25.81\text{dBm}$.

Test Mode C

1TX

802.11a

Chan.	Freq. (MHz)	Maximum Conducted Power (mW)	Maximum Conducted Power (dBm)	Power Limit (dBm)	Pass / Fail
36	5180	163.305	22.13	30	Pass
40	5200	261.216	24.17	30	Pass
48	5240	85.114	19.30	30	Pass
149	5745	95.060	19.78	30	Pass
157	5785	244.343	23.88	30	Pass
165	5825	159.221	22.02	30	Pass

802.11n (HT20)

Chan.	Freq. (MHz)	Maximum Conducted Power (mW)	Maximum Conducted Power (dBm)	Power Limit (dBm)	Pass / Fail
36	5180	150.314	21.77	30	Pass
40	5200	219.280	23.41	30	Pass
48	5240	81.283	19.10	30	Pass
149	5745	68.234	18.34	30	Pass
157	5785	243.220	23.86	30	Pass
165	5825	156.675	21.95	30	Pass

802.11n (HT40)

Chan.	Freq. (MHz)	Maximum Conducted Power (mW)	Maximum Conducted Power (dBm)	Power Limit (dBm)	Pass / Fail
38	5190	86.298	19.36	30	Pass
46	5230	83.176	19.20	30	Pass
151	5755	57.810	17.62	30	Pass
159	5795	144.212	21.59	30	Pass

802.11ac (VHT80)

Chan.	Freq. (MHz)	Maximum Conducted Power (mW)	Maximum Conducted Power (dBm)	Power Limit (dBm)	Pass / Fail
42	5210	55.590	17.45	30	Pass
155	5775	57.810	17.62	30	Pass

26dB BANDWIDTH:**Test Mode A****1TX****802.11a**

Chan.	Freq. (MHz)	26dBc Bandwidth (MHz)	Pass / Fail
36	5180	31.87	Pass
40	5200	46.32	Pass
48	5240	31.85	Pass

802.11n (HT20)

Chan.	Freq. (MHz)	26dBc Bandwidth (MHz)	Pass / Fail
36	5180	28.12	Pass
40	5200	49.18	Pass
48	5240	34.98	Pass

802.11n (HT40)

Chan.	Freq. (MHz)	26dBc Bandwidth (MHz)	Pass / Fail
38	5190	41.41	Pass
46	5230	103.60	Pass

802.11ac (VHT80)

Chan.	Freq. (MHz)	26dBc Bandwidth (MHz)	Pass / Fail
42	5210	104.19	Pass

Spectrum Plot of Worst Value

802.11a

802.11n (HT20)

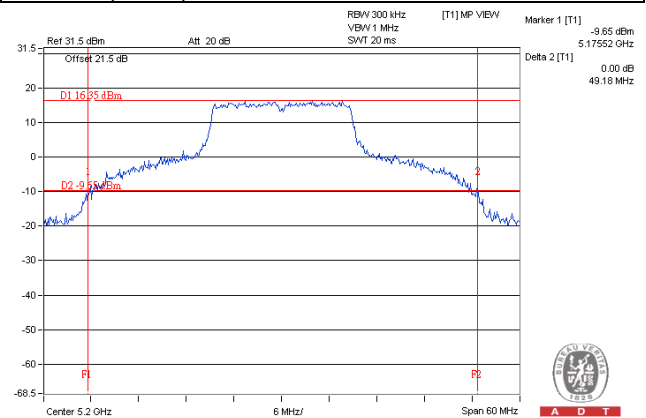
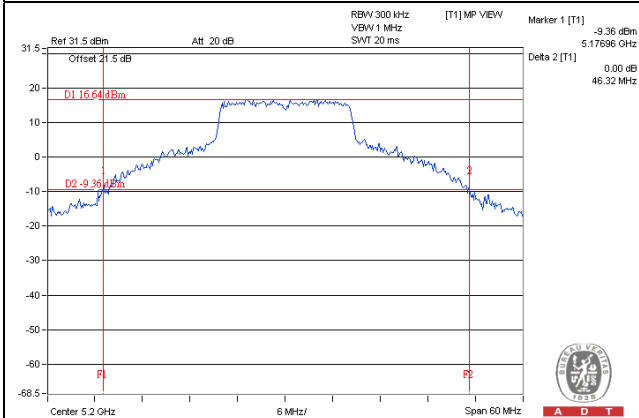

802.11n (HT40)

802.11ac (VHT80)

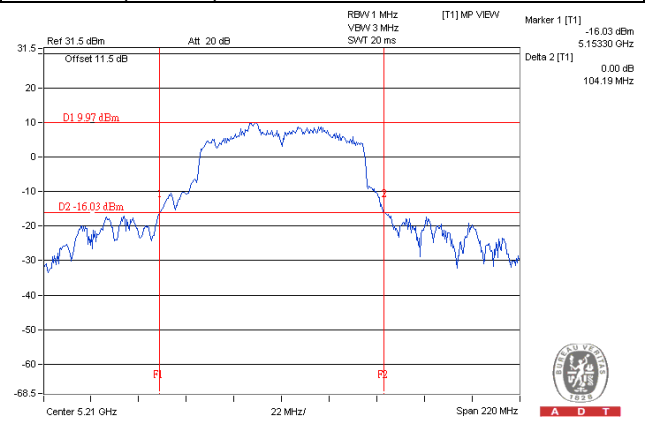
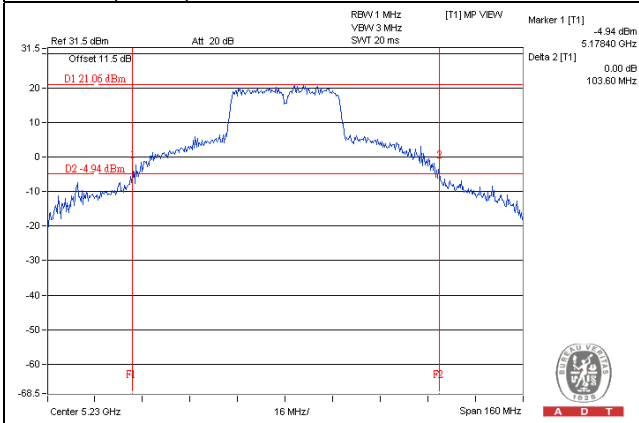

Test Mode A
2TX
802.11a

Chan.	Freq. (MHz)	26dBc Bandwidth (MHz)		Pass / Fail
		Chain 0	Chain 1	
36	5180	28.13	26.86	Pass
40	5200	43.52	43.52	Pass
48	5240	35.31	37.37	Pass

802.11n (HT20)

Chan.	Freq. (MHz)	26dBc Bandwidth (MHz)		Pass / Fail
		Chain 0	Chain 1	
6	5180	21.97	22.05	Pass
40	5200	48.53	46.65	Pass
48	5240	37.12	40.88	Pass

802.11n (HT40)

Chan.	Freq. (MHz)	26dBc Bandwidth (MHz)		Pass / Fail
		Chain 0	Chain 1	
38	5190	41.44	41.36	Pass
46	5230	93.78	96.09	Pass

802.11ac (VHT80)

Chan.	Freq. (MHz)	26dBc Bandwidth (MHz)		Pass / Fail
		Chain 0	Chain 1	
42	5210	132.15	131.75	Pass

Spectrum Plot of Worst Value

802.11a

802.11n (HT20)

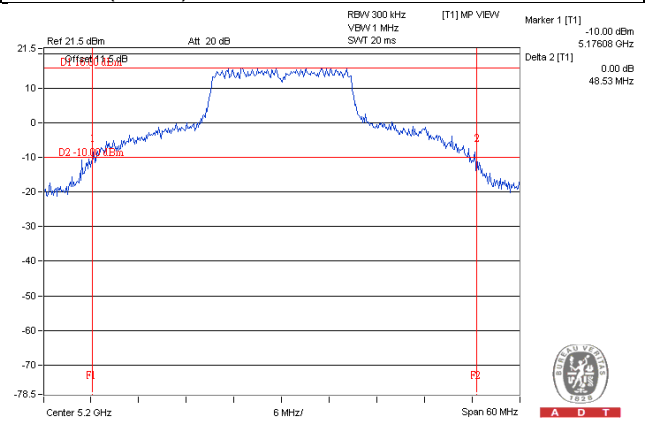
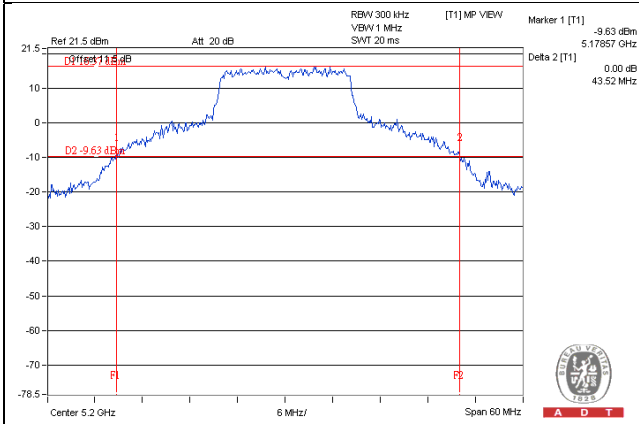

802.11n (HT40)

802.11ac (VHT80)

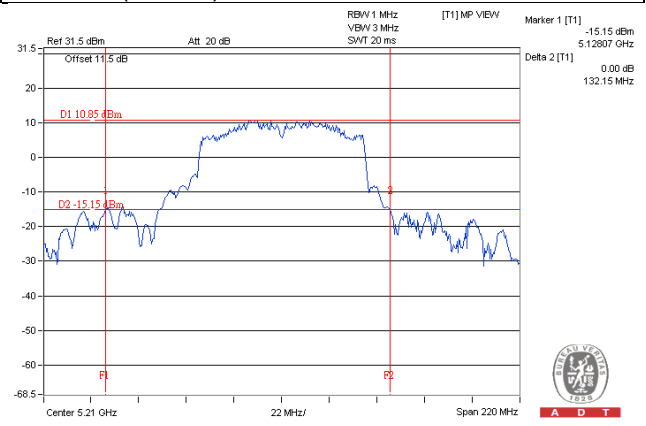
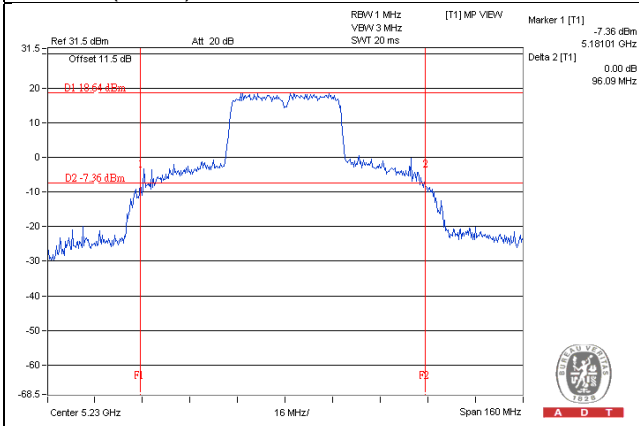

Test Mode A
3TX
802.11a

Chan.	Freq. (MHz)	26dBc Bandwidth (MHz)			Pass / Fail
		Chain 0	Chain 1	Chain 2	
36	5180	27.16	21.77	33.33	Pass
40	5200	29.93	32.35	38.14	Pass
48	5240	33.20	35.84	38.53	Pass

802.11n (HT20)

Chan.	Freq. (MHz)	26dBc Bandwidth (MHz)			Pass / Fail
		Chain 0	Chain 1	Chain 2	
36	5180	21.97	22.04	32.31	Pass
40	5200	22.23	33.22	40.82	Pass
48	5240	31.53	33.67	39.29	Pass

802.11n (HT40)

Chan.	Freq. (MHz)	26dBc Bandwidth (MHz)			Pass / Fail
		Chain 0	Chain 1	Chain 2	
38	5190	41.31	41.51	41.54	Pass
46	5230	81.42	41.60	67.40	Pass

802.11ac (VHT80)

Chan.	Freq. (MHz)	26dBc Bandwidth (MHz)			Pass / Fail
		Chain 0	Chain 1	Chain 2	
42	5210	105.71	125.22	131.70	Pass

Spectrum Plot of Worst Value

802.11a

802.11n (HT20)

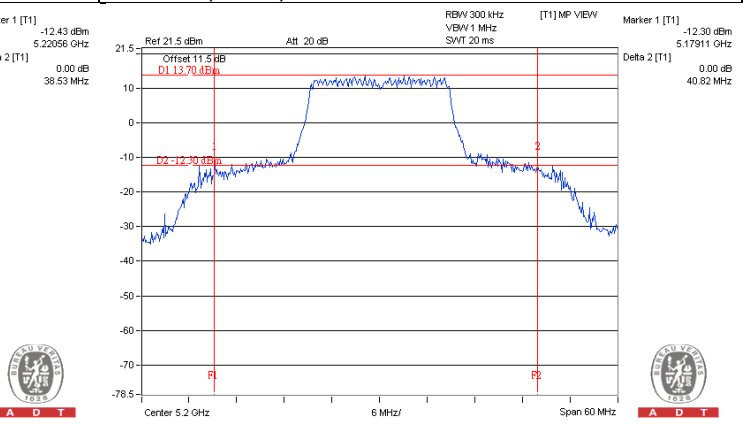
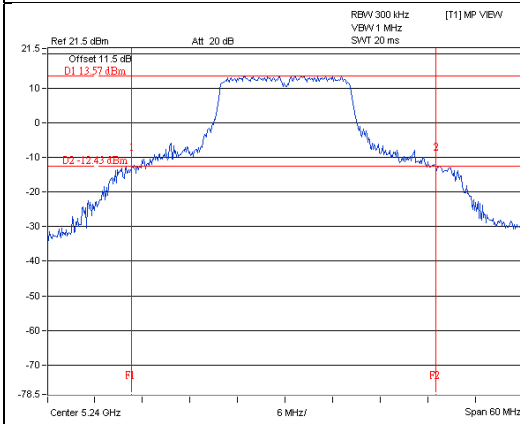

802.11n (HT40)

802.11ac (VHT80)

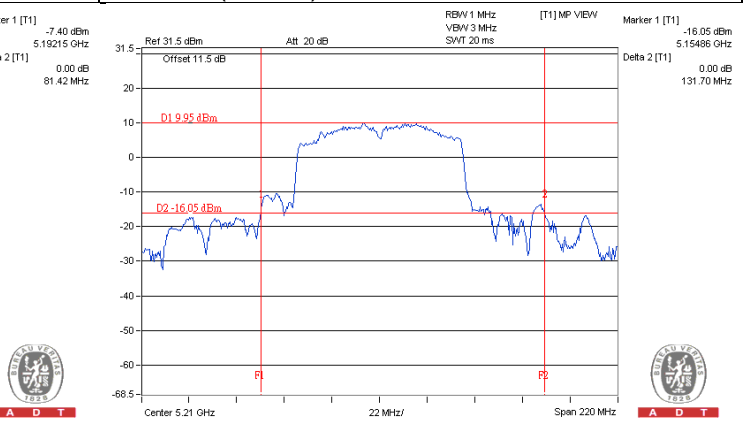
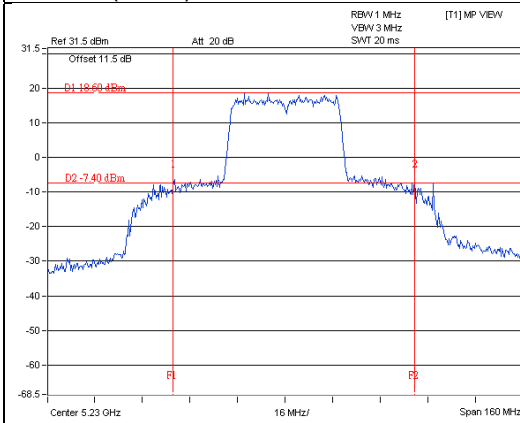

Test Mode A
4TX
802.11a

Chan.	Freq. (MHz)	26dBc Bandwidth (MHz)				Pass / Fail
		Chain 0	Chain 1	Chain 2	Chain 3	
36	5180	21.72	21.68	21.96	22.02	Pass
40	5200	21.61	21.73	21.81	21.96	Pass
48	5240	21.68	21.67	21.88	21.84	Pass

802.11n (HT20)

Chan.	Freq. (MHz)	26dBc Bandwidth (MHz)				Pass / Fail
		Chain 0	Chain 1	Chain 2	Chain 3	
36	5180	21.95	21.93	22.07	22.13	Pass
40	5200	21.76	21.89	21.88	22.12	Pass
48	5240	21.92	21.79	21.98	22.17	Pass

802.11n (HT40)

Chan.	Freq. (MHz)	26dBc Bandwidth (MHz)				Pass / Fail
		Chain 0	Chain 1	Chain 2	Chain 3	
38	5190	41.18	41.46	41.37	41.40	Pass
46	5230	41.63	41.59	41.54	41.55	Pass

802.11ac (VHT80)

Chan.	Freq. (MHz)	26dBc Bandwidth (MHz)				Pass / Fail
		Chain 0	Chain 1	Chain 2	Chain 3	
42	5210	104.98	125.81	131.68	164.89	Pass

Spectrum Plot of Worst Value

802.11a

802.11n (HT20)

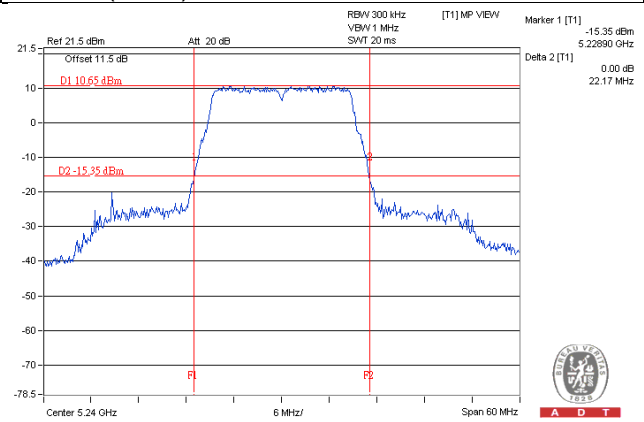
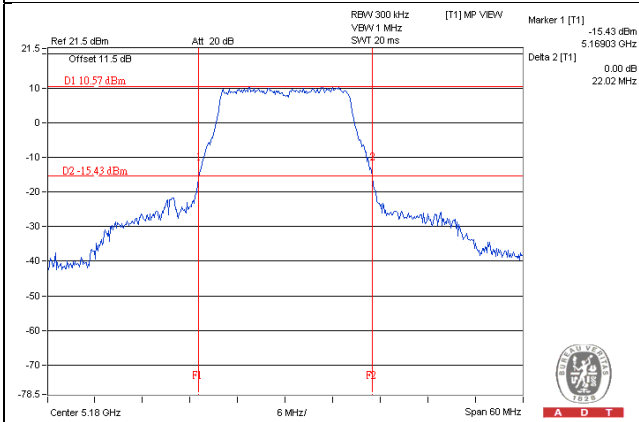

802.11n (HT40)

802.11ac (VHT80)

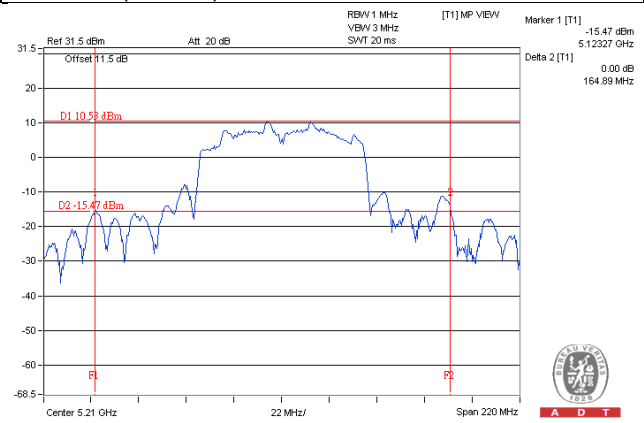
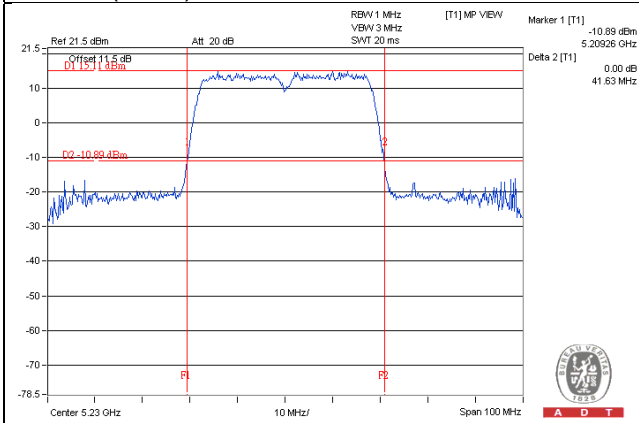

Test Mode C**1TX****802.11a**

Chan.	Freq. (MHz)	26dBc Bandwidth (MHz)	Pass / Fail
36	5180	36.84	Pass
40	5200	43.57	Pass
48	5240	36.52	Pass

802.11n (HT20)

Chan.	Freq. (MHz)	26dBc Bandwidth (MHz)	Pass / Fail
36	5180	42.88	Pass
40	5200	46.59	Pass
48	5240	38.69	Pass

802.11n (HT40)

Chan.	Freq. (MHz)	26dBc Bandwidth (MHz)	Pass / Fail
38	5190	41.96	Pass
46	5230	99.52	Pass

802.11ac (VHT80)

Chan.	Freq. (MHz)	26dBc Bandwidth (MHz)	Pass / Fail
42	5210	82.25	Pass

Spectrum Plot of Worst Value

802.11a

802.11n (HT20)

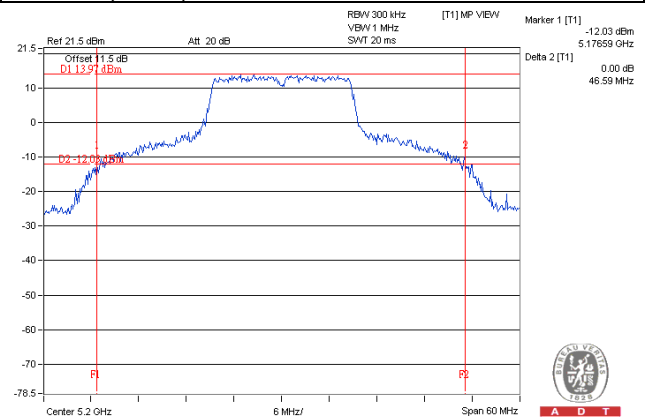
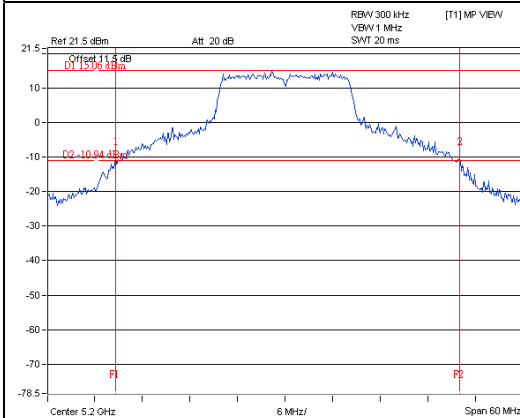

802.11n (HT40)

802.11ac (VHT80)

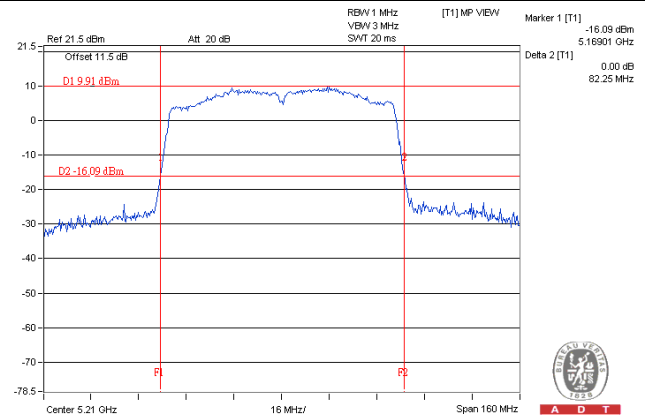
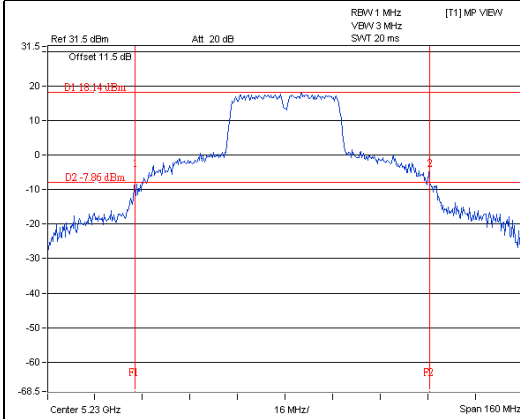

OCCUPIED BANDWIDTH:
Test Mode A
1TX
802.11a

Chan.	Freq. (MHz)	Occupied Bandwidth (MHz)
36	5180	17.64
40	5200	31.80
48	5240	17.88
149	5745	17.22
157	5785	38.28
165	5825	24.00

802.11n (HT20)

Chan.	Freq. (MHz)	Occupied Bandwidth (MHz)
36	5180	18.48
40	5200	31.80
48	5240	18.72
149	5745	18.24
157	5785	44.16
165	5825	19.08

802.11n (HT40)

Chan.	Freq. (MHz)	Occupied Bandwidth (MHz)
38	5190	36.96
46	5230	38.04
151	5755	36.96
159	5795	37.68

802.11ac (VHT80)

Chan.	Freq. (MHz)	Occupied Bandwidth (MHz)
42	5210	76.44
155	5775	76.16

Spectrum Plot of Worst Value

802.11a

802.11n (HT20)

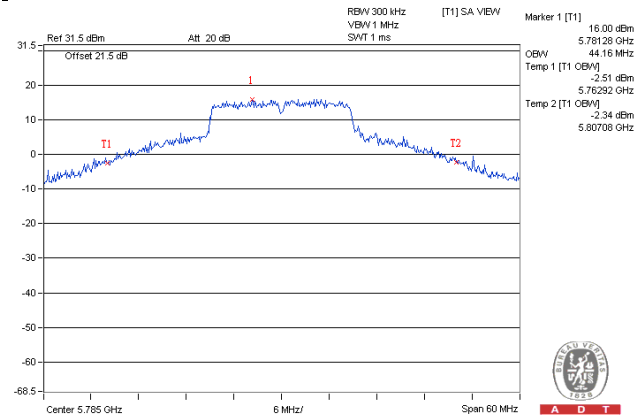
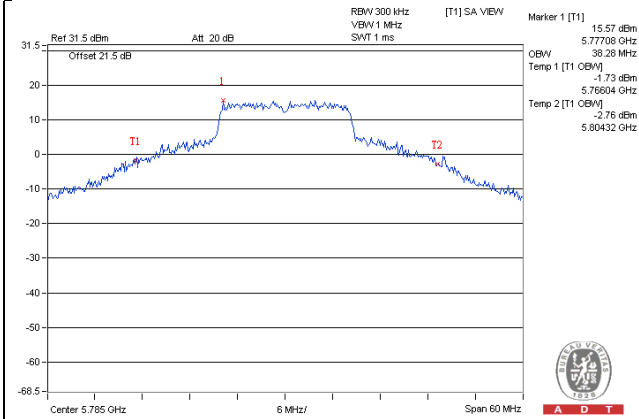

802.11n (HT40)

802.11ac (VHT80)

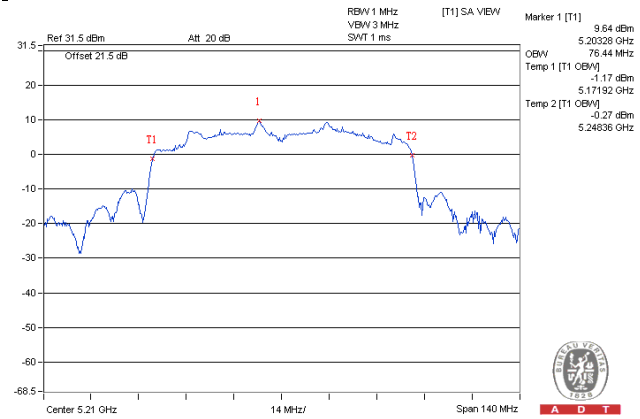
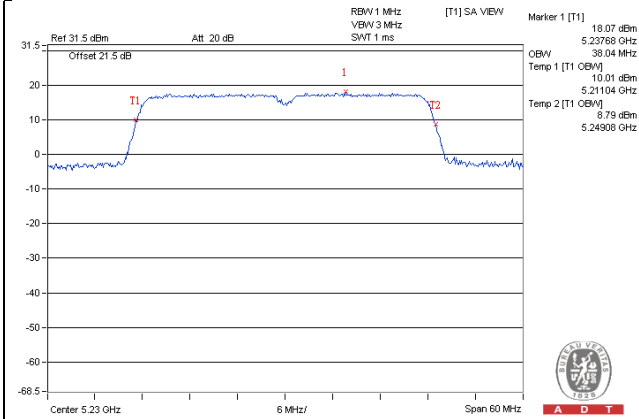

Test Mode A
2TX
802.11a

Chan.	Freq. (MHz)	Occupied Bandwidth (MHz)	
		Chain 0	Chain 1
36	5180	17.16	17.16
40	5200	28.68	27.72
48	5240	17.64	17.64
149	5745	16.92	17.04
157	5785	39.00	32.52
165	5825	18.24	22.32

802.11n (HT20)

Chan.	Freq. (MHz)	Occupied Bandwidth (MHz)	
		Chain 0	Chain 1
36	5180	18.12	18.12
40	5200	29.88	30.36
48	5240	18.72	18.60
149	5745	18.12	18.00
157	5785	40.92	34.92
165	5825	18.72	22.68

802.11n (HT40)

Chan.	Freq. (MHz)	Occupied Bandwidth (MHz)	
		Chain 0	Chain 1
38	5190	36.84	36.72
46	5230	37.80	37.20
151	5755	36.72	36.84
159	5795	37.08	37.20

802.11ac (VHT80)

Chan.	Freq. (MHz)	Occupied Bandwidth (MHz)	
		Chain 0	Chain 1
42	5210	75.32	75.04
155	5775	75.88	75.88

Spectrum Plot of Worst Value

802.11a

802.11n (HT20)

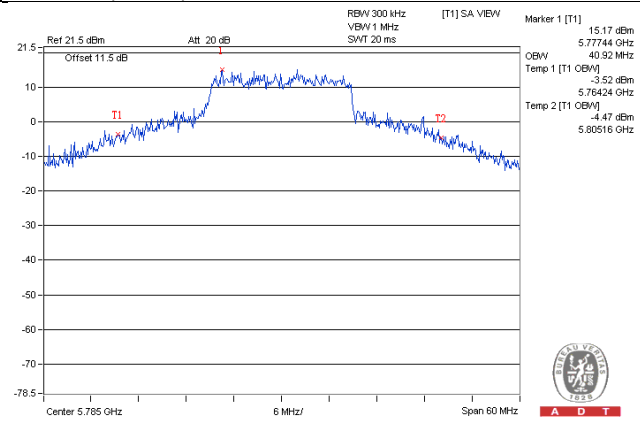
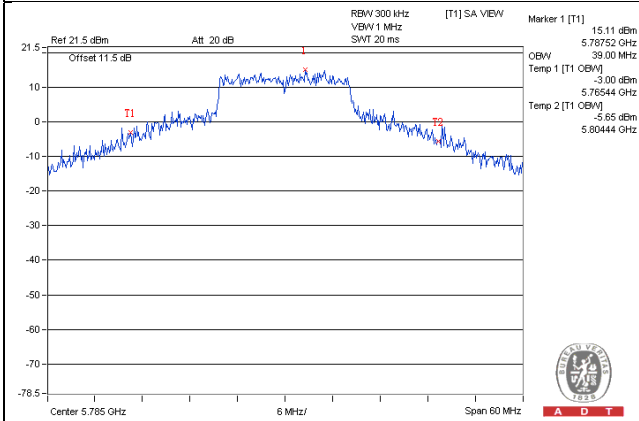

802.11n (HT40)

802.11ac (VHT80)

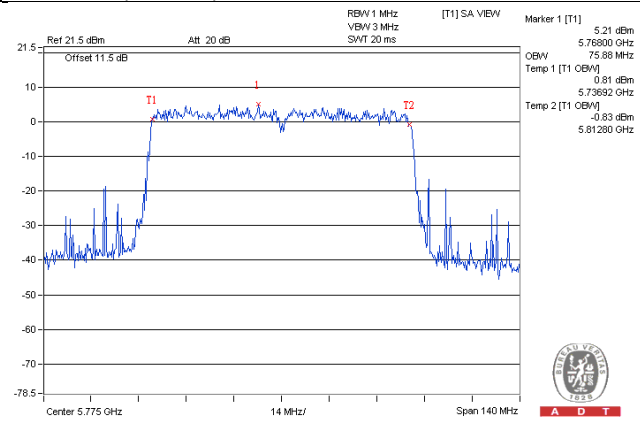
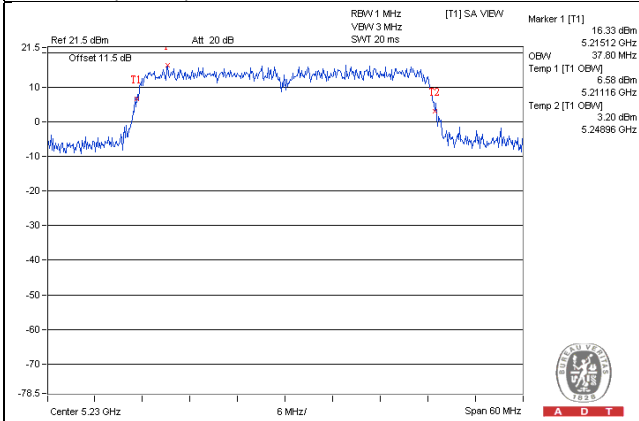

Test Mode A
3TX
802.11a

Chan.	Freq. (MHz)	Occupied Bandwidth (MHz)		
		Chain 0	Chain 1	Chain 2
36	5180	17.16	17.04	17.28
40	5200	17.28	17.52	18.24
48	5240	17.28	17.76	18.12
149	5745	16.92	16.92	17.04
157	5785	38.28	27.48	32.52
165	5825	17.64	17.28	21.24

802.11n (HT20)

Chan.	Freq. (MHz)	Occupied Bandwidth (MHz)		
		Chain 0	Chain 1	Chain 2
36	5180	18.12	18.24	18.60
40	5200	18.12	18.24	18.48
48	5240	18.36	18.24	18.60
149	5745	18.12	18.12	18.00
157	5785	27.48	22.32	30.12
165	5825	18.60	18.60	21.48

802.11n (HT40)

Chan.	Freq. (MHz)	Occupied Bandwidth (MHz)		
		Chain 0	Chain 1	Chain 2
38	5190	36.72	36.72	36.72
46	5230	37.20	36.72	37.20
151	5755	36.96	36.60	36.72
159	5795	37.08	36.84	37.56

802.11ac (VHT80)

Chan.	Freq. (MHz)	Occupied Bandwidth (MHz)		
		Chain 0	Chain 1	Chain 2
42	5210	75.32	75.32	75.60
155	5775	76.16	75.88	75.88

Spectrum Plot of Worst Value

802.11a

802.11n (HT20)

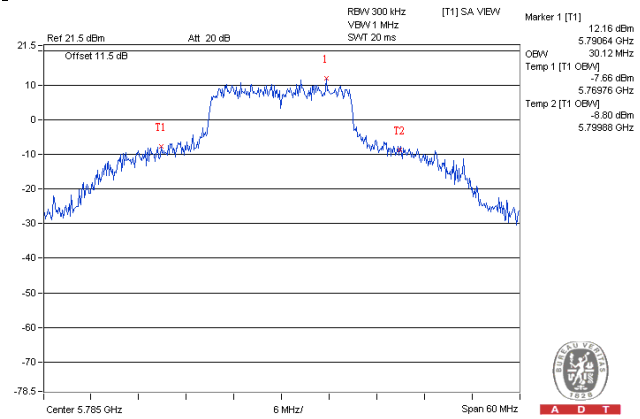
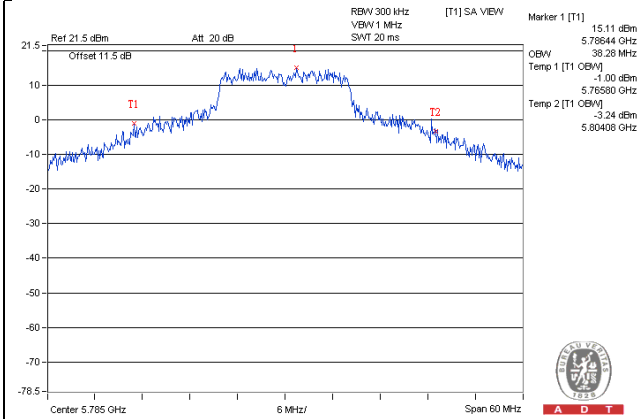

802.11n (HT40)

802.11ac (VHT80)

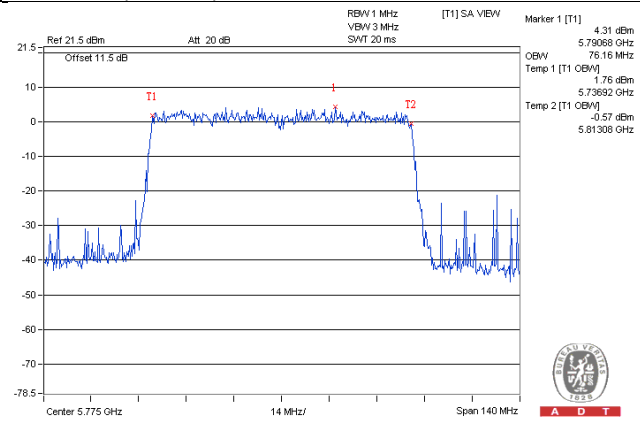
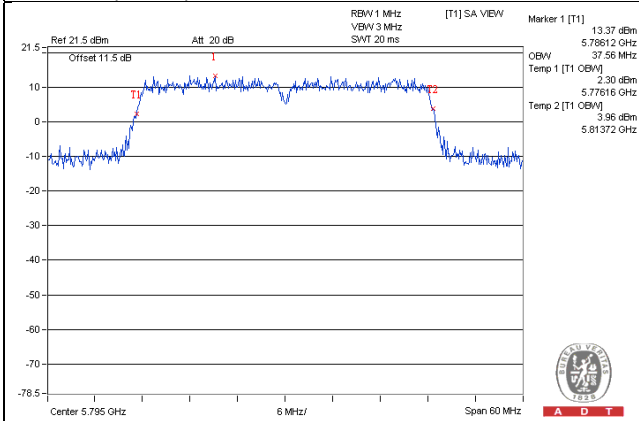

Test Mode A
4TX
802.11a

Chan.	Freq. (MHz)	Occupied Bandwidth (MHz)			
		Chain 0	Chain 1	Chain 2	Chain 3
36	5180	17.04	17.04	17.04	17.04
40	5200	16.92	16.80	17.16	17.16
48	5240	16.92	17.04	17.04	16.92
149	5745	17.04	17.04	16.92	16.92
157	5785	29.52	31.92	27.48	35.16
165	5825	17.64	18.36	17.52	17.28

802.11n (HT20)

Chan.	Freq. (MHz)	Occupied Bandwidth (MHz)			
		Chain 0	Chain 1	Chain 2	Chain 3
36	5180	18.00	18.24	18.24	18.36
40	5200	18.24	18.00	18.12	18.24
48	5240	18.12	18.12	18.24	18.12
149	5745	18.12	18.12	18.00	18.12
157	5785	18.12	18.12	18.36	18.24
165	5825	18.12	18.12	18.84	18.24

802.11n (HT40)

Chan.	Freq. (MHz)	Occupied Bandwidth (MHz)			
		Chain 0	Chain 1	Chain 2	Chain 3
38	5190	36.72	36.84	36.84	36.72
46	5230	36.84	36.84	36.72	36.72
151	5755	36.72	36.84	36.72	36.72
159	5795	36.84	36.84	37.08	36.96

802.11ac (VHT80)

Chan.	Freq. (MHz)	Occupied Bandwidth (MHz)			
		Chain 0	Chain 1	Chain 2	Chain 3
42	5210	75.04	75.04	75.04	75.32
155	5775	76.16	76.16	75.88	75.60

Spectrum Plot of Worst Value

802.11a

802.11n (HT20)

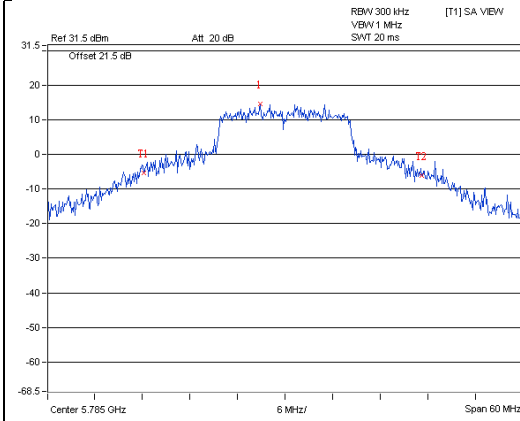

Marker 1 [T1]
14.72 dBm
5.78176 GHz
OBW
-3.32 dBm
5.76712 GHz
Temp 2 [T1] OBW
-6.06 dBm
5.80228 GHz



A D T

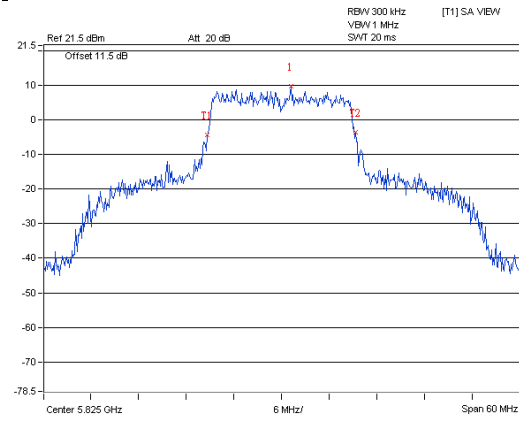

Marker 1 [T1]
9.65 dBm
5.82620 GHz
OBW
-4.40 dBm
5.81552 GHz
Temp 2 [T1] OBW
-3.57 dBm
5.83436 GHz



A D T

802.11n (HT40)

802.11ac (VHT80)

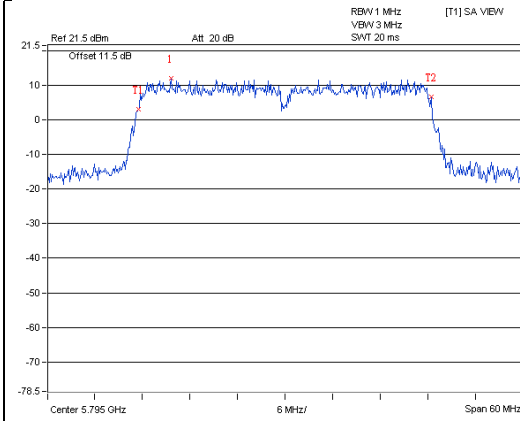

Marker 1 [T1]
11.98 dBm
5.78048 GHz
OBW
37.08 MHz
Temp 1 [T1] OBW
3.03 dBm
5.77640 GHz
Temp 2 [T1] OBW
5.60 dBm
5.81348 GHz



A D T

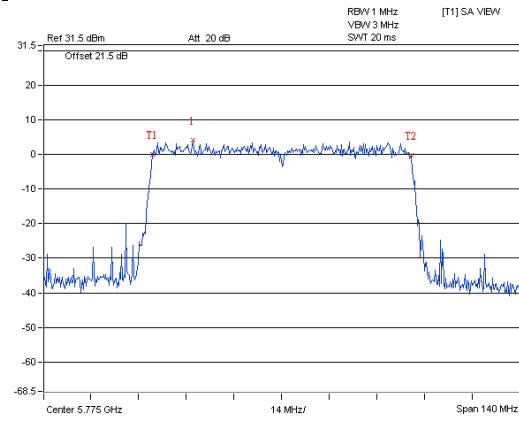

Marker 1 [T1]
4.04 dBm
5.74868 GHz
OBW
76.16 MHz
Temp 1 [T1] OBW
-0.01 dBm
5.73692 GHz
Temp 2 [T1] OBW
-0.17 dBm
5.81308 GHz



A D T

Test Mode C
1TX
802.11a

Chan.	Freq. (MHz)	Occupied Bandwidth (MHz)
36	5180	18.00
40	5200	26.40
48	5240	18.60
149	5745	17.28
157	5785	26.64
165	5825	18.36

802.11n (HT20)

Chan.	Freq. (MHz)	Occupied Bandwidth (MHz)
36	5180	18.84
40	5200	24.12
48	5240	18.48
149	5745	18.00
157	5785	28.20
165	5825	19.20

802.11n (HT40)

Chan.	Freq. (MHz)	Occupied Bandwidth (MHz)
38	5190	36.72
46	5230	38.00
151	5755	36.72
159	5795	36.96

802.11ac (VHT80)

Chan.	Freq. (MHz)	Occupied Bandwidth (MHz)
42	5210	75.36
155	5775	76.08

Spectrum Plot of Worst Value

802.11a

802.11n (HT20)

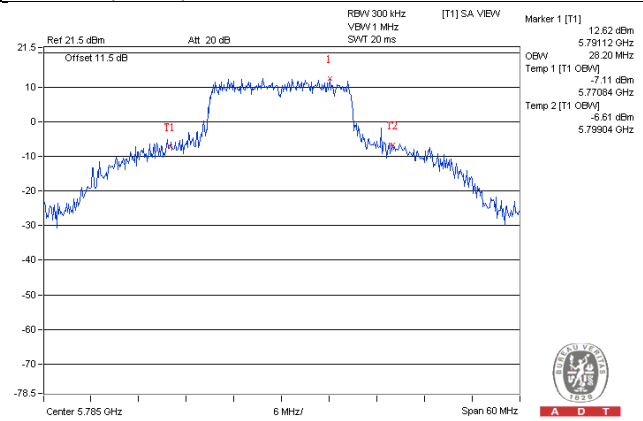
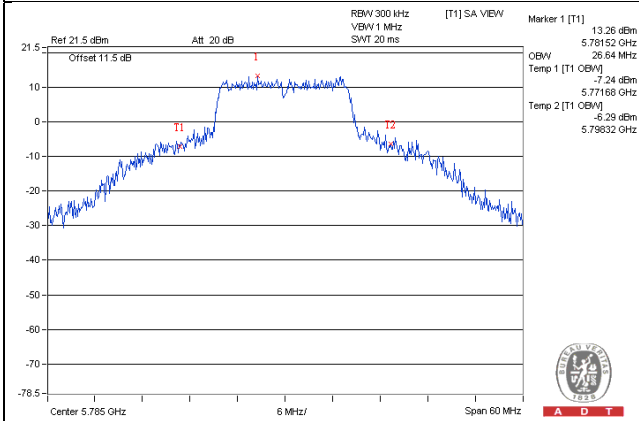

802.11n (HT40)

802.11ac (VHT80)

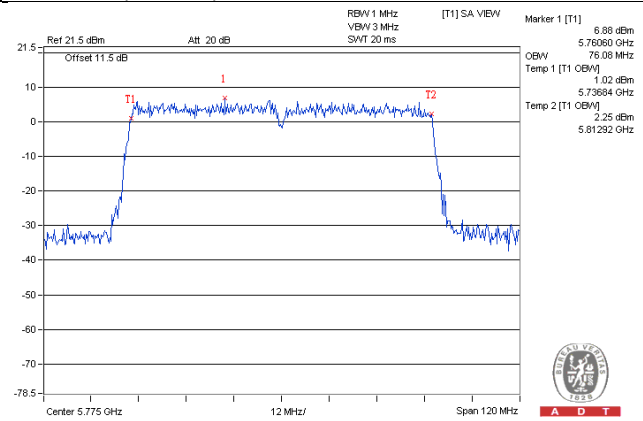
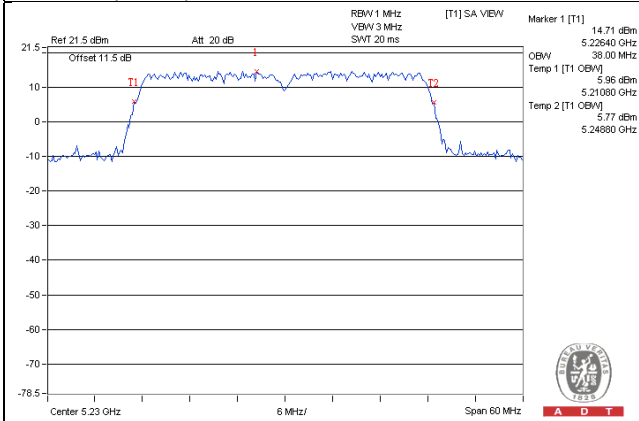

4.4 Peak Power Spectral Density Measurement

4.4.1 Limits of Peak Power Spectral Density Measurement

Operation Band	EUT Category		LIMIT
U-NII-1		Outdoor Access Point	17dBm/ MHz
		Fixed point-to-point Access Point	
	√	Indoor Access Point	11dBm/ MHz
		Mobile and Portable client device	
U-NII-2A	-		11dBm/ MHz
U-NII-2C	-		11dBm/ MHz
U-NII-3	√		30dBm/ 500kHz

4.4.2 Test Setup

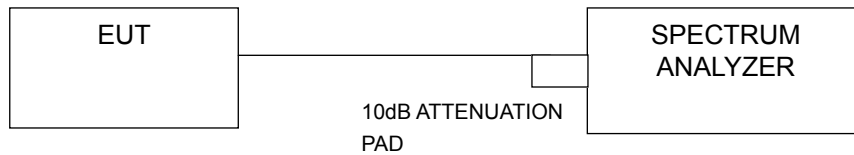

4.4.3 Test Instruments

Refer to section 4.1.2 to get information of above instrument.

4.4.4 Test Procedures

For U-NII-1 band:

Using method SA-2

- 1) Set span to encompass the entire emission bandwidth (EBW) of the signal.
- 2) Set RBW = 1 MHz, Set VBW \geq 3 MHz, Detector = RMS
- 3) Set Channel power measure = 1MHz
- 4) Sweep time = auto, trigger set to "free run".
- 5) Trace average at least 100 traces in power averaging mode.
- 6) Record the max value and add $10 \log (1/\text{duty cycle})$

For U-NII-3 band:

- 1) Set span to encompass the entire emission bandwidth (EBW) of the signal.
- 2) Set RBW = 300 kHz, Set VBW \geq 1 MHz, Detector = RMS
- 3) Use the peak marker function to determine the maximum power level in any 300 kHz band segment within the fundamental EBW.
- 4) Scale the observed power level to an equivalent value in 500 kHz by adjusting (reducing) the measured power by a bandwidth correction factor (BWCF) where $\text{BWCF} = 10\log(500 \text{ kHz}/300\text{kHz})$
- 5) Sweep time = auto, trigger set to "free run".
- 6) Trace average at least 100 traces in power averaging mode.
- 7) Record the max value and add $10 \log (1/\text{duty cycle})$

4.4.5 Deviation from Test Standard

No deviation.

4.4.6 EUT Operating Conditions

Same as Item 4.3.6.

4.4.7 Test Results

For U-NII-1 Band

Test Mode A

1TX

802.11a

Chan.	Freq. (MHz)	PSD (dBm)	Max. Limit (dBm)	Pass / Fail
36	5180	9.22	17.00	Pass
40	5200	12.28	17.00	Pass
48	5240	9.07	17.00	Pass

802.11n (HT20)

Chan.	Freq. (MHz)	PSD w/o duty factor (dBm)	Duty factor	PSD with duty factor (dBm)	Max. Limit (dBm)	Pass / Fail
36	5180	8.59	0.09	8.68	17.00	Pass
40	5200	11.51	0.09	11.60	17.00	Pass
48	5240	8.72	0.09	8.81	17.00	Pass

802.11n (HT40)

Chan.	Freq. (MHz)	PSD w/o duty factor (dBm)	Duty factor	PSD with duty factor (dBm)	Max. Limit (dBm)	Pass / Fail
38	5190	2.28	0.14	2.42	17.00	Pass
46	5230	7.19	0.14	7.33	17.00	Pass

802.11ac (VHT80)

Chan.	Freq. (MHz)	PSD w/o duty factor (dBm)	Duty factor	PSD with duty factor (dBm)	Max. Limit (dBm)	Pass / Fail
42	5210	-3.03	0.27	-2.76	17.00	Pass

Spectrum Plot of Worst Value

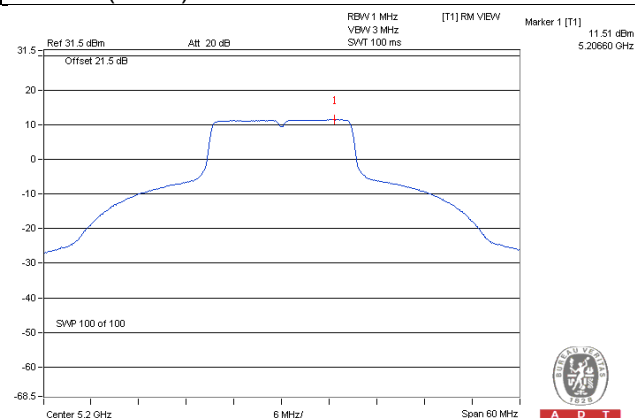
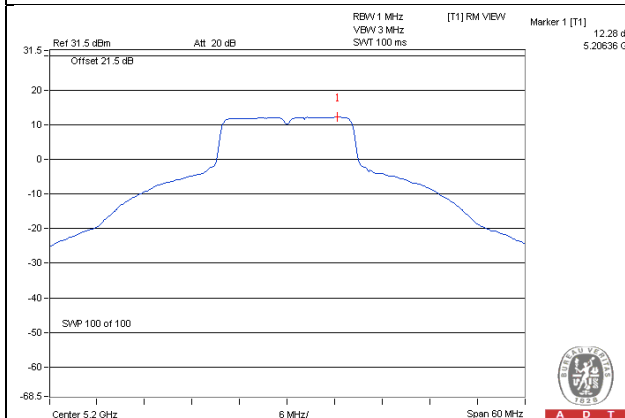
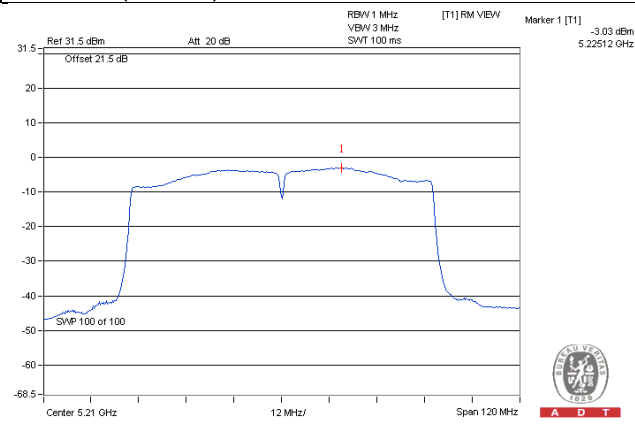
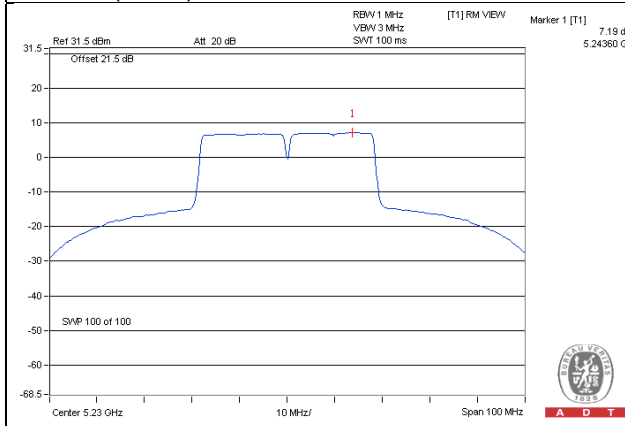
802.11a / Ch 40**802.11n (HT20) / Ch 40****802.11n (HT40) / Ch 46 / Chain 1****802.11ac (VHT80) / Ch 42**

Test Mode A
2TX
802.11a

Chan.	Freq. (MHz)	PSD (dBm)		Total PSD (dBm)	Max. Limit (dBm)	Pass / Fail
		Chain 0	Chain 1			
36	5180	7.51	7.63	10.58	15.81	Pass
40	5200	10.22	10.33	13.29	15.81	Pass
48	5240	8.23	8.23	11.24	15.81	Pass

Note:

- Method 1 of power density measurement of KDB 662911 is using for calculating total power density. Total power density is summing entire spectra across corresponding frequency bins on the various outputs by computer.
- Directional gain = $10 \log[(10^{G1/20} + 10^{G2/20} + \dots + 10^{GN/20})^2/N]$ = 7.19dBi > 6dBi, so the power density limit shall be reduced to $17-(7.19-6) = 15.81\text{dBm}$.

802.11n (HT20)

Chan.	Freq. (MHz)	PSD (dBm)		Total PSD w/o duty factor (dBm)	Duty factor	Total PSD with duty factor (dBm)	Max. Limit (dBm)	Pass / Fail
		Chain 0	Chain 1					
36	5180	6.49	6.44	9.47	0.12	9.59	15.81	Pass
40	5200	9.88	9.98	12.94	0.12	13.06	15.81	Pass
48	5240	7.92	8.00	10.96	0.12	11.08	15.81	Pass

Note:

- Method 1 of power density measurement of KDB 662911 is using for calculating total power density. Total power density is summing entire spectra across corresponding frequency bins on the various outputs by computer.
- Directional gain = $10 \log[(10^{G1/20} + 10^{G2/20} + \dots + 10^{GN/20})^2/N]$ = 7.19dBi > 6dBi, so the power density limit shall be reduced to $17-(7.19-6) = 15.81\text{dBm}$.
- Refer to section 3.3 for duty cycle spectrum plot.

802.11n (HT40)

Chan.	Freq. (MHz)	PSD (dBm)		Total PSD w/o duty factor (dBm)	Duty factor	Total PSD with duty factor (dBm)	Max. Limit (dBm)	Pass / Fail
		Chain 0	Chain 1					
38	5190	1.90	1.87	4.89	0.14	5.03	15.81	Pass
46	5230	6.34	6.14	9.25	0.14	9.39	15.81	Pass

Note:

1. Method 1 of power density measurement of KDB 662911 is using for calculating total power density. Total power density is summing entire spectra across corresponding frequency bins on the various outputs by computer.
2. Directional gain = $10 \log[(10^{G1/20} + 10^{G2/20} + \dots + 10^{GN/20})^2/N] = 7.19\text{dBi} > 6\text{dBi}$, so the power density limit shall be reduced to $17-(7.19-6) = 15.81\text{dBm}$.
3. Refer to section 3.3 for duty cycle spectrum plot.

802.11ac (VHT80)

Chan.	Freq. (MHz)	PSD (dBm)		Total PSD w/o duty factor (dBm)	Duty factor	Total PSD with duty factor (dBm)	Max. Limit (dBm)	Pass / Fail
		Chain 0	Chain 1					
42	5210	-2.48	-2.17	0.68	0.25	0.93	15.81	Pass

Note:

1. Method 1 of power density measurement of KDB 662911 is using for calculating total power density. Total power density is summing entire spectra across corresponding frequency bins on the various outputs by computer.
2. Directional gain = $10 \log[(10^{G1/20} + 10^{G2/20} + \dots + 10^{GN/20})^2/N] = 7.19\text{dBi} > 6\text{dBi}$, so the power density limit shall be reduced to $17-(7.19-6) = 15.81\text{dBm}$.
3. Refer to section 3.3 for duty cycle spectrum plot.

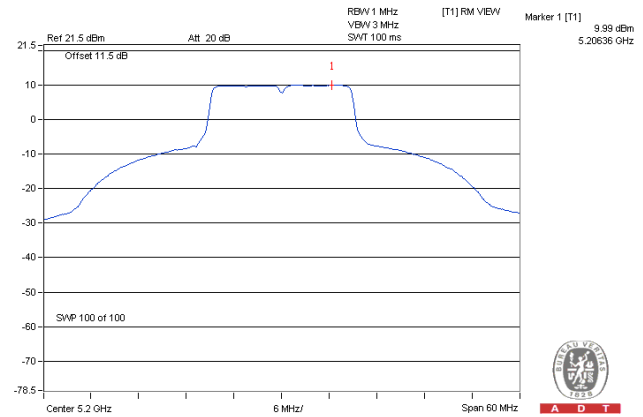
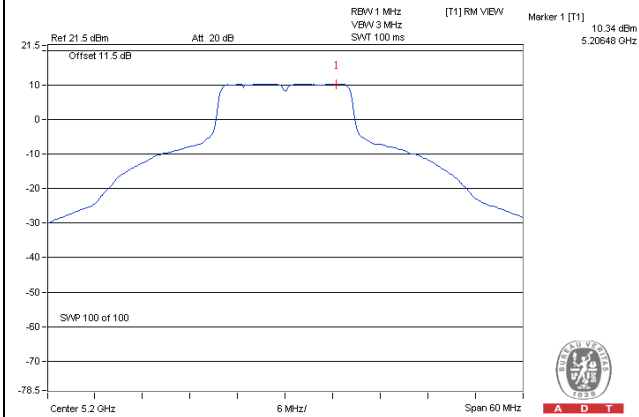
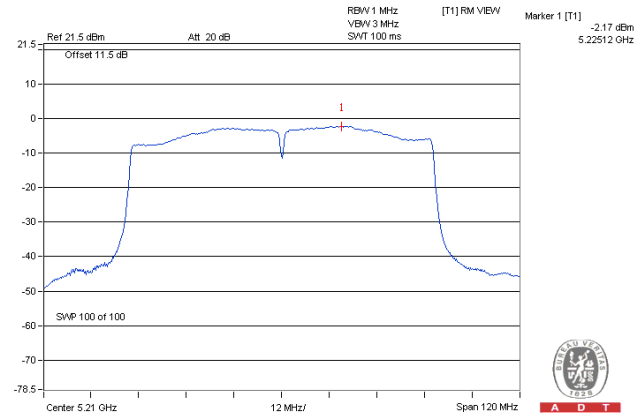
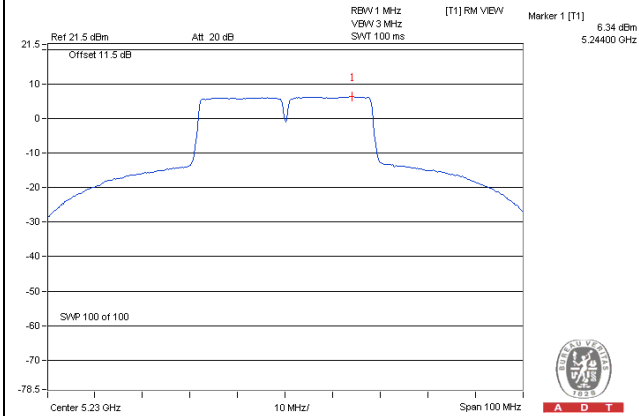
Spectrum Plot of Worst Value**802.11a / Ch 40 / Chain 1****802.11n (HT20) / Ch 40 / Chain 1****802.11n (HT40) / Ch 46 / Chain 0****802.11ac (VHT80) / Ch 42 / Chain 1**

Test Mode A
3TX
802.11a

Chan.	Freq. (MHz)	PSD (dBm)			Total PSD (dBm)	Max. Limit (dBm)	Pass / Fail
		Chain 0	Chain 1	Chain 2			
36	5180	7.97	8.99	9.34	13.58	14.27	Pass
40	5200	9.14	8.74	9.59	13.94	14.27	Pass
48	5240	8.84	8.40	9.12	13.57	14.27	Pass

Note:

- Method 1 of power density measurement of KDB 662911 is using for calculating total power density. Total power density is summing entire spectra across corresponding frequency bins on the various outputs by computer.
- Directional gain = $10 \log[(10^{G1/20} + 10^{G2/20} + \dots + 10^{GN/20})^2/N]$ = 8.73dBi > 6dBi, so the power density limit shall be reduced to 17-(8.73-6) = 14.27dBm.
- Refer to section 3.3 for duty cycle spectrum plot.

802.11n (HT20)

Chan.	Freq. (MHz)	PSD (dBm)			Total PSD w/o duty factor (dBm)	Duty factor	Total PSD with duty factor (dBm)	Max. Limit (dBm)	Pass / Fail
		Chain 0	Chain 1	Chain 2					
36	5180	6.74	6.65	7.54	11.77	0.11	11.88	14.27	Pass
40	5200	6.92	7.53	7.38	12.06	0.11	12.17	14.27	Pass
48	5240	7.00	7.44	7.52	12.10	0.11	12.21	14.27	Pass

Note:

- Method 1 of power density measurement of KDB 662911 is using for calculating total power density. Total power density is summing entire spectra across corresponding frequency bins on the various outputs by computer.
- Directional gain = $10 \log[(10^{G1/20} + 10^{G2/20} + \dots + 10^{GN/20})^2/N]$ = 8.73dBi > 6dBi, so the power density limit shall be reduced to 17-(8.73-6) = 14.27dBm.
- Refer to section 3.3 for duty cycle spectrum plot.

802.11n (HT40)

Chan.	Freq. (MHz)	PSD (dBm)			Total PSD w/o duty factor (dBm)	Duty factor	Total PSD with duty factor (dBm)	Max. Limit (dBm)	Pass / Fail
		Chain 0	Chain 1	Chain 2					
38	5190	1.44	0.76	1.45	6.00	0.22	6.22	14.27	Pass
46	5230	6.35	5.10	5.81	10.56	0.22	10.78	14.27	Pass

Note:

- Method 1 of power density measurement of KDB 662911 is using for calculating total power density. Total power density is summing entire spectra across corresponding frequency bins on the various outputs by computer.
- Directional gain = $10 \log[(10^{G1/20} + 10^{G2/20} + \dots + 10^{GN/20})^2/N]$ = 8.73dBi > 6dBi, so the power density limit shall be reduced to 17-(8.73-6) = 14.27dBm.
- Refer to section 3.3 for duty cycle spectrum plot.

802.11ac (VHT80)

Chan.	Freq. (MHz)	PSD (dBm)			Total PSD w/o duty factor (dBm)	Duty factor	Total PSD with duty factor (dBm)	Max. Limit (dBm)	Pass / Fail
		Chain 0	Chain 1	Chain 2					
42	5210	-3.61	-3.20	-2.43	1.72	0.74	2.46	14.27	Pass

Note:

- Method 1 of power density measurement of KDB 662911 is using for calculating total power density. Total power density is summing entire spectra across corresponding frequency bins on the various outputs by computer.
- Directional gain = $10 \log[(10^{G1/20} + 10^{G2/20} + \dots + 10^{GN/20})^2/N] = 8.73\text{dBi} > 6\text{dBi}$, so the power density limit shall be reduced to $17-(8.73-6) = 14.27\text{dBm}$.
- Refer to section 3.3 for duty cycle spectrum plot.

Spectrum Plot of Worst Value

802.11a / Ch 40 / Chain 2

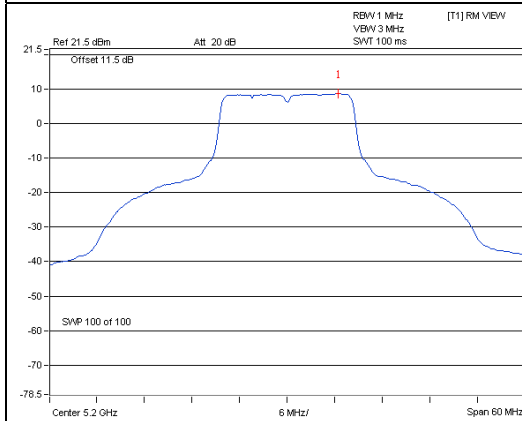

802.11n (HT20) / Ch 36 / Chain 2

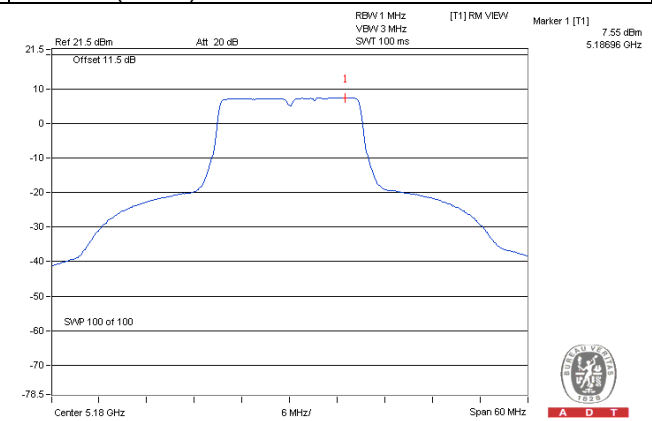

802.11n (HT40) / Ch 46 / Chain 0

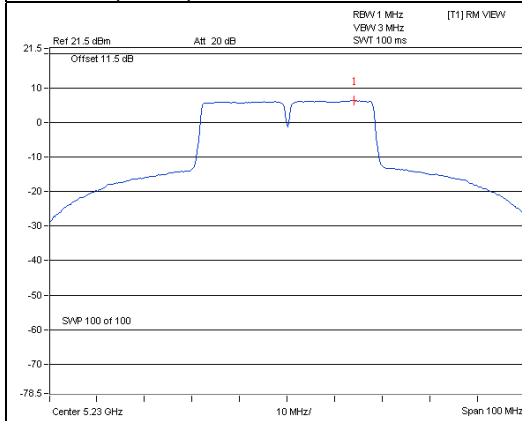

802.11ac (VHT80) / Ch 42 / Chain 2

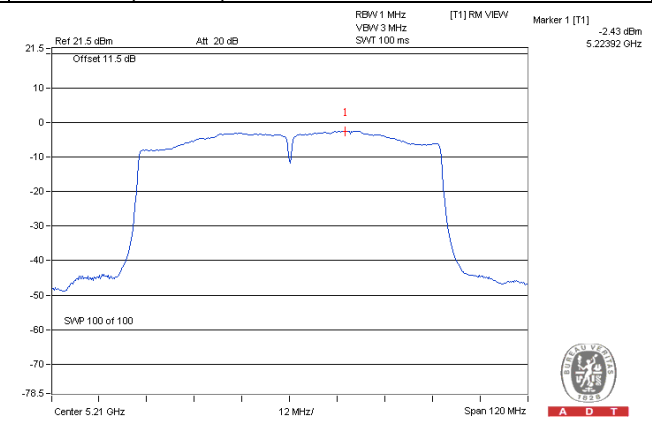

Test Mode A
4TX
802.11a

Chan.	Freq. (MHz)	PSD (dBm)				Total PSD w/o duty factor (dBm)	Duty factor	Total PSD with duty factor (dBm)	Max. Limit (dBm)	Pass / Fail
		Chain 0	Chain 1	Chain 2	Chain 3					
36	5180	6.25	5.88	7.29	6.70	12.59	0.10	12.69	13.04	Pass
40	5200	6.06	6.04	7.25	6.57	12.53	0.10	12.63	13.04	Pass
48	5240	6.17	5.90	7.21	6.50	12.50	0.10	12.60	13.04	Pass

Note:

- Method 1 of power density measurement of KDB 662911 is using for calculating total power density. Total power density is summing entire spectra across corresponding frequency bins on the various outputs by computer.
- Directional gain = $10 \log[(10^{G1/20} + 10^{G2/20} + \dots + 10^{GN/20})^2/N]$ = 9.96dBi > 6dBi, so the power density limit shall be reduced to $17-(9.96-6) = 13.04$ dBm.
- Refer to section 3.3 for duty cycle spectrum plot.

802.11n (HT20)

Chan.	Freq. (MHz)	PSD (dBm)				Total PSD (dBm)	Max. Limit (dBm)	Pass / Fail
		Chain 0	Chain 1	Chain 2	Chain 3			
36	5180	6.26	5.93	7.34	6.59	12.58	13.04	Pass
40	5200	6.31	6.27	7.43	6.84	12.76	13.04	Pass
48	5240	6.44	5.70	6.98	5.77	12.28	13.04	Pass

Note:

- Method 1 of power density measurement of KDB 662911 is using for calculating total power density. Total power density is summing entire spectra across corresponding frequency bins on the various outputs by computer.
- Directional gain = $10 \log[(10^{G1/20} + 10^{G2/20} + \dots + 10^{GN/20})^2/N]$ = 9.96dBi > 6dBi, so the power density limit shall be reduced to $17-(9.96-6) = 13.04$ dBm.

802.11n (HT40)

Chan.	Freq. (MHz)	PSD (dBm)				Total PSD w/o duty factor (dBm)	Duty factor	Total PSD with duty factor (dBm)	Max. Limit (dBm)	Pass / Fail
		Chain 0	Chain 1	Chain 2	Chain 3					
38	5190	1.09	0.54	1.30	0.57	6.90	0.22	7.12	13.04	Pass
46	5230	6.24	4.84	5.74	5.03	11.51	0.22	11.73	13.04	Pass

Note:

- Method 1 of power density measurement of KDB 662911 is using for calculating total power density. Total power density is summing entire spectra across corresponding frequency bins on the various outputs by computer.
- Directional gain = $10 \log[(10^{G1/20} + 10^{G2/20} + \dots + 10^{GN/20})^2/N]$ = 9.96dBi > 6dBi, so the power density limit shall be reduced to $17-(9.96-6) = 13.04$ dBm.
- Refer to section 3.3 for duty cycle spectrum plot.

802.11ac (VHT80)

Chan.	Freq. (MHz)	PSD (dBm)				Total PSD w/o duty factor (dBm)	Duty factor	Total PSD with duty factor (dBm)	Max. Limit (dBm)	Pass / Fail
		Chain 0	Chain 1	Chain 2	Chain 3					
42	5210	-3.53	-3.44	-2.42	-3.21	2.90	0.34	3.24	13.04	Pass

Note:

- Method 1 of power density measurement of KDB 662911 is using for calculating total power density. Total power density is summing entire spectra across corresponding frequency bins on the various outputs by computer.
- Directional gain = $10 \log[(10^{G1/20} + 10^{G2/20} + \dots + 10^{GN/20})^2/N]$ = 9.96dBi > 6dBi, so the power density limit shall be reduced to $17-(9.96-6) = 13.04\text{dBm}$.
- Refer to section 3.3 for duty cycle spectrum plot.

Spectrum Plot of Worst Value

802.11a / Ch 36 / Chain 2

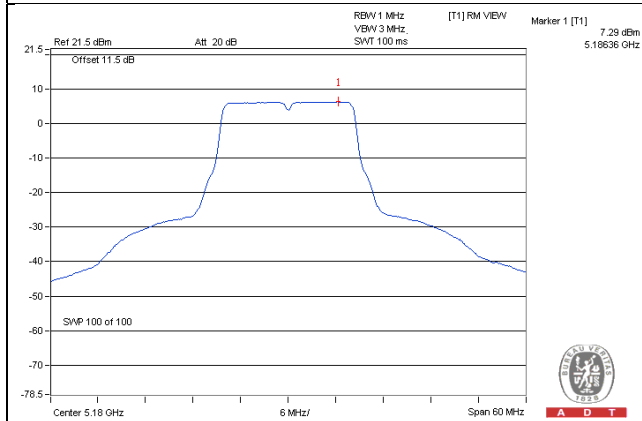

802.11n (HT20) / Ch 40 / Chain 2

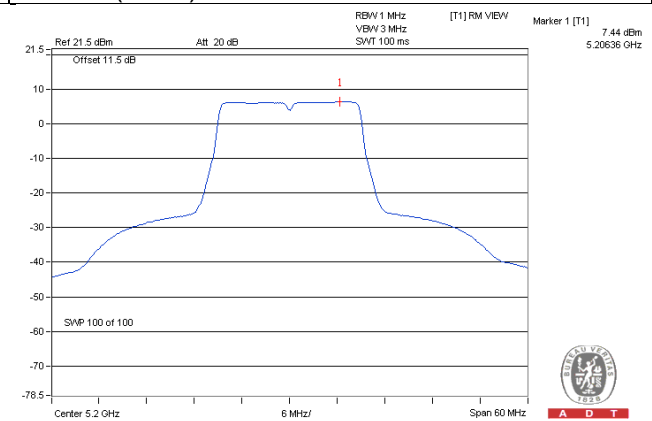

802.11n (HT40) / Ch 46 / Chain 0

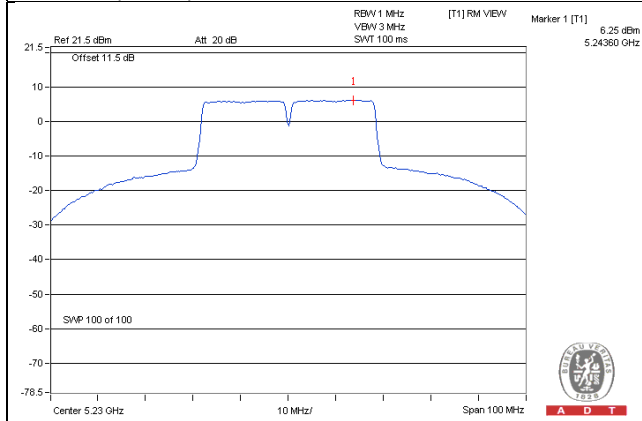

802.11ac (VHT80) / Ch 42 / Chain 2

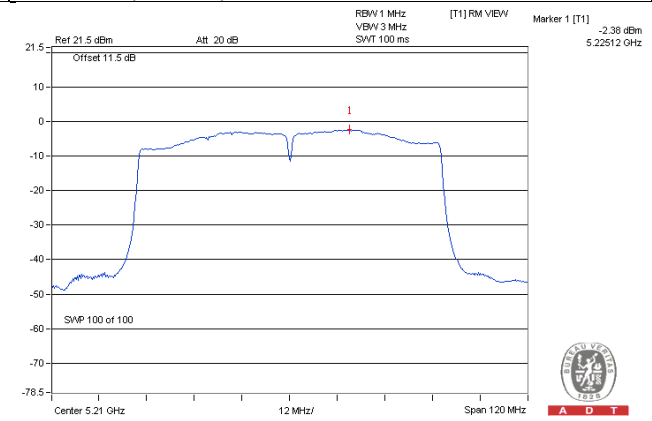

Test Mode C
1TX
802.11a

Chan.	Freq. (MHz)	PSD w/o duty factor (dBm)	Duty factor	PSD with duty factor (dBm)	Max. Limit (dBm)	Pass / Fail
36	5180	7.50	0.19	7.69	17.00	Pass
40	5200	9.34	0.19	9.53	17.00	Pass
48	5240	7.45	0.19	7.64	17.00	Pass

802.11n (HT20)

Chan.	Freq. (MHz)	PSD w/o duty factor (dBm)	Duty factor	PSD with duty factor (dBm)	Max. Limit (dBm)	Pass / Fail
36	5180	6.96	0.19	7.15	17.00	Pass
40	5200	8.59	0.19	8.78	17.00	Pass
48	5240	7.12	0.19	7.31	17.00	Pass

802.11n (HT40)

Chan.	Freq. (MHz)	PSD w/o duty factor (dBm)	Duty factor	PSD with duty factor (dBm)	Max. Limit (dBm)	Pass / Fail
38	5190	0.83	0.62	1.45	17.00	Pass
46	5230	4.19	0.62	4.81	17.00	Pass

802.11ac (VHT80)

Chan.	Freq. (MHz)	PSD w/o duty factor (dBm)	Duty factor	PSD with duty factor (dBm)	Max. Limit (dBm)	Pass / Fail
42	5210	-1.53	1.07	-0.46	17.00	Pass

Spectrum Plot of Worst Value

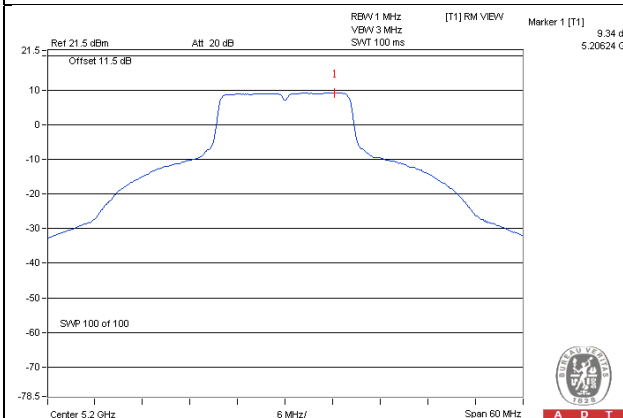
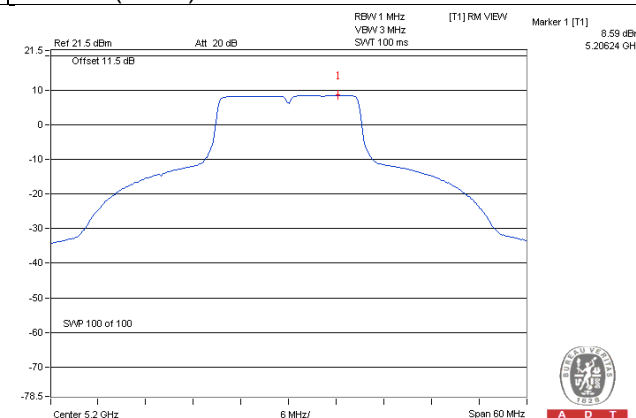
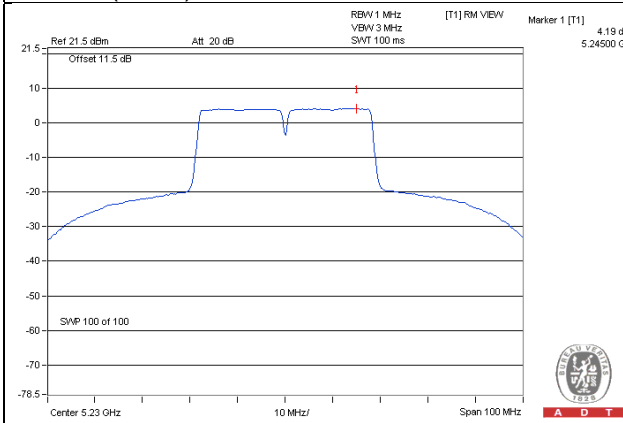
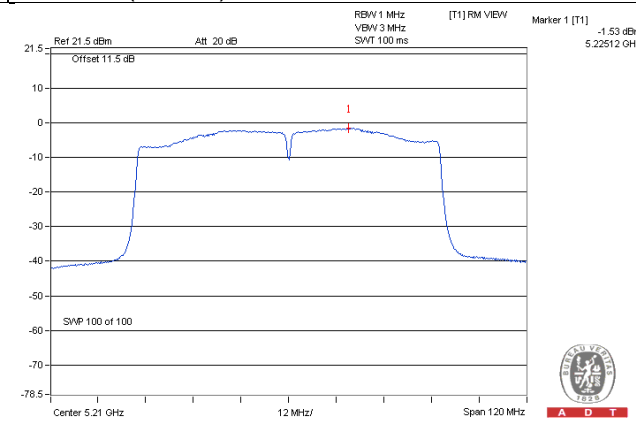
802.11a / Ch 40**802.11n (HT20) / Ch 40****802.11n (HT40) / Ch 46****802.11ac (VHT80) / Ch 58**

For U-NII-3 Band

Test Mode A

1TX

802.11a

Chan.	Freq. (MHz)	PSD (dBm/300kHz)	PSD (dBm/500kHz)	Limit (dBm/500kHz)	Pass / Fail
149	5745	-3.04	-0.82	30.00	Pass
157	5785	2.86	5.08	30.00	Pass
165	5825	0.37	2.59	30.00	Pass

802.11n (HT20)

Chan.	Freq. (MHz)	PSD (dBm/300k Hz)	PSD (dBm/500k Hz)	Duty factor	Total PSD (dBm/500k Hz)	Limit (dBm/500k Hz)	Pass / Fail
149	5745	-4.55	-2.33	0.09	-2.24	30.00	Pass
157	5785	2.28	4.50	0.09	4.59	30.00	Pass
165	5825	-1.35	0.87	0.09	0.96	30.00	Pass

802.11n (HT40)

Chan.	Freq. (MHz)	PSD (dBm/300k Hz)	PSD (dBm/500k Hz)	Duty factor	Total PSD (dBm/500k Hz)	Limit (dBm/500k Hz)	Pass / Fail
151	5755	-8.28	-6.06	0.14	-5.92	30.00	Pass
159	5795	-3.72	-1.50	0.14	-1.36	30.00	Pass

802.11ac (VHT80)

Chan.	Freq. (MHz)	PSD (dBm/300k Hz)	PSD (dBm/500k Hz)	Duty factor	Total PSD (dBm/500k Hz)	Limit (dBm/500k Hz)	Pass / Fail
155	5775	-12.27	-10.05	0.27	-9.78	30.00	Pass

Spectrum Plot of Worst Value

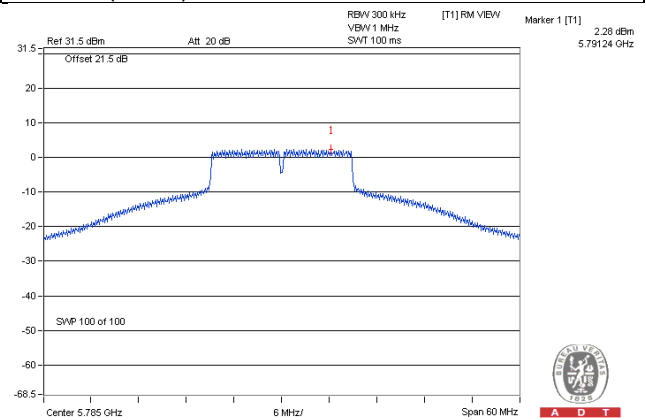
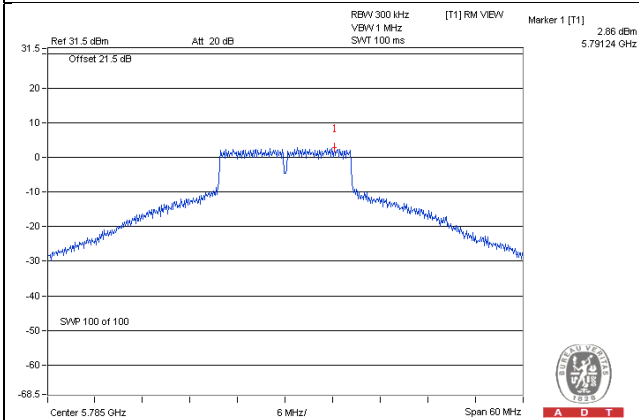
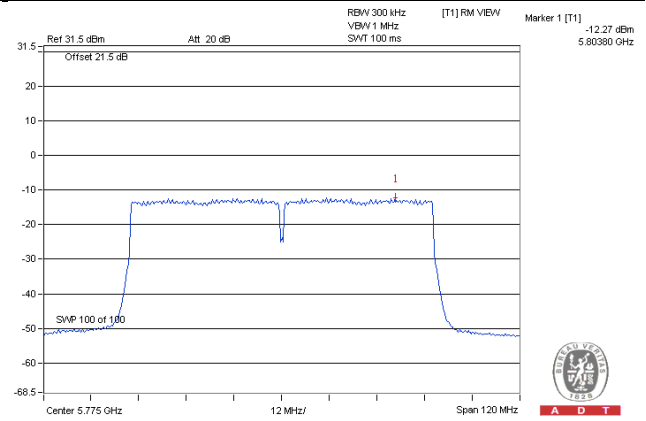
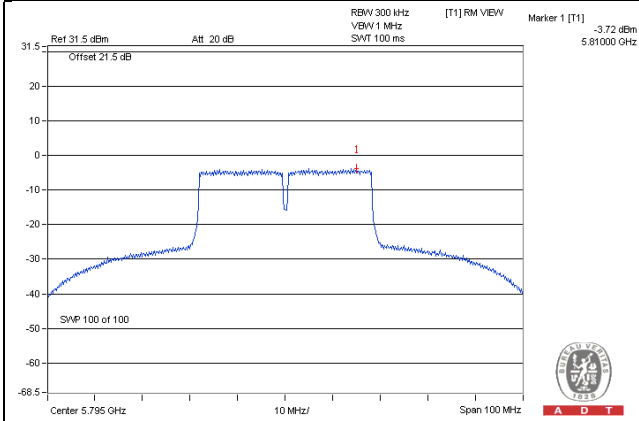
802.11a**802.11n (HT20)****802.11n (HT40)****802.11ac (VHT80)**

Test Mode A
2TX
802.11a

TX chain	Chan.	Freq. (MHz)	PSD (dBm/300 kHz)	PSD (dBm/500 kHz)	10 log (N=2) dB	Total PSD (dBm/500 kHz)	Limit (dBm/500 kHz)	Pass / Fail
0	149	5745	-3.57	-1.35	3.01	1.66	28.90	Pass
	157	5785	2.10	4.32	3.01	7.33	28.90	Pass
	165	5825	-1.15	1.07	3.01	4.08	28.90	Pass
1	149	5745	-3.18	-0.96	3.01	2.05	28.90	Pass
	157	5785	0.09	2.31	3.01	5.32	28.90	Pass
	165	5825	-1.48	0.74	3.01	3.75	28.90	Pass

Note:

- Method 1 of power density measurement of KDB 662911 is using for calculating total power density. Total power density is summing entire spectra across corresponding frequency bins on the various outputs by computer.
- Directional gain = $10 \log[(10^{G1/20} + 10^{G2/20} + \dots + 10^{GN/20})^2/N]$ = 7.10dBi > 6dBi, so the power density limit shall be reduced to $30-(7.10-6) = 28.90\text{dBm}$.

802.11n (HT20)

TX chain	Chan.	Freq. (MHz)	PSD (dBm/300 kHz)	PSD (dBm/500 kHz)	10 log (N=2) dB	Duty factor	Total PSD (dBm/500 kHz)	Limit (dBm/500 kHz)	Pass / Fail
0	149	5745	-6.22	-4.00	3.01	0.12	-0.87	28.90	Pass
	157	5785	1.68	3.90	3.01	0.12	7.03	28.90	Pass
	165	5825	-1.84	0.38	3.01	0.12	3.51	28.90	Pass
1	149	5745	-5.54	-3.32	3.01	0.12	-0.19	28.90	Pass
	157	5785	-0.26	1.96	3.01	0.12	5.09	28.90	Pass
	165	5825	-2.11	0.11	3.01	0.12	3.24	28.90	Pass

Note:

- Method 1 of power density measurement of KDB 662911 is using for calculating total power density. Total power density is summing entire spectra across corresponding frequency bins on the various outputs by computer.
- Directional gain = $10 \log[(10^{G1/20} + 10^{G2/20} + \dots + 10^{GN/20})^2/N]$ = 7.10dBi > 6dBi, so the power density limit shall be reduced to $30-(7.10-6) = 28.90\text{dBm}$.
- Refer to section 3.3 for duty cycle spectrum plot.

802.11n (HT40)

TX chain	Chan.	Freq. (MHz)	PSD (dBm/300 kHz)	PSD (dBm/500 kHz)	10 log (N=2) dB	Duty factor	Total PSD (dBm/500 kHz)	Limit (dBm/500 kHz)	Pass / Fail
0	151	5755	-10.27	-8.05	3.01	0.14	-4.90	28.90	Pass
	159	5795	-5.01	-2.79	3.01	0.14	0.36	28.90	Pass
1	151	5755	-9.81	-7.59	3.01	0.14	-4.44	28.90	Pass
	159	5795	-5.37	-3.15	3.01	0.14	0.00	28.90	Pass

Note:

- Method 1 of power density measurement of KDB 662911 is using for calculating total power density. Total power density is summing entire spectra across corresponding frequency bins on the various outputs by computer.
- Directional gain = $10 \log[(10^{G1/20} + 10^{G2/20} + \dots + 10^{GN/20})^2/N]$ = 7.10dBi > 6dBi, so the power density limit shall be reduced to $30-(7.10-6) = 28.90\text{dBm}$.
- Refer to section 3.3 for duty cycle spectrum plot.

802.11ac (VHT80)

TX chain	Chan.	Freq. (MHz)	PSD (dBm/300 kHz)	PSD (dBm/500 kHz)	10 log (N=2) dB	Duty factor	Total PSD (dBm/500 kHz)	Limit (dBm/500 kHz)	Pass / Fail
0	155	5775	-13.44	-11.22	3.01	0.25	-7.96	28.90	Pass
1	155	5775	-13.26	-11.04	3.01	0.25	-7.78	28.90	Pass

Note:

- Method 1 of power density measurement of KDB 662911 is using for calculating total power density. Total power density is summing entire spectra across corresponding frequency bins on the various outputs by computer.
- Directional gain = $10 \log[(10^{G1/20} + 10^{G2/20} + \dots + 10^{GN/20})^2/N]$ = 7.10dBi > 6dBi, so the power density limit shall be reduced to $30-(7.10-6) = 28.90\text{dBm}$.
- Refer to section 3.3 for duty cycle spectrum plot.

Spectrum Plot of Worst Value

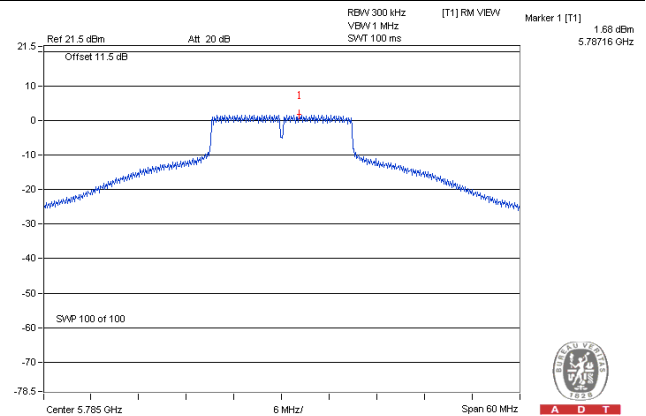
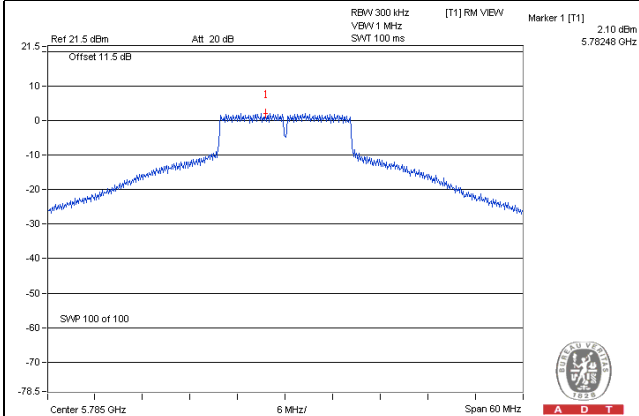
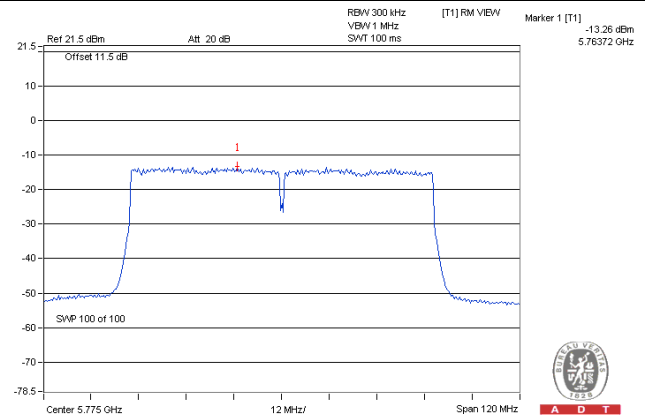
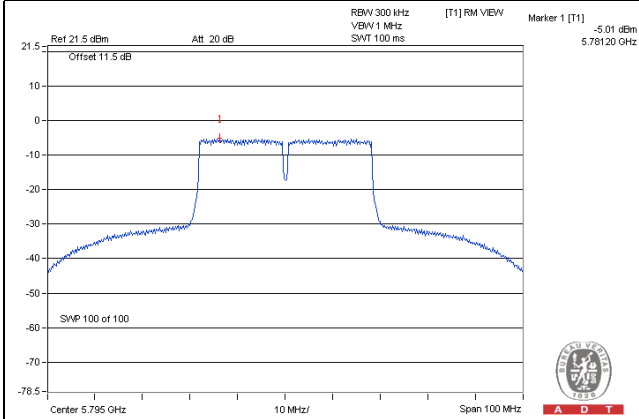
802.11a**802.11n (HT20)****802.11n (HT40)****802.11ac (VHT80)**

Test Mode A
3TX
802.11a

TX chain	Chan.	Freq. (MHz)	PSD (dBm/300kHz)	PSD (dBm/500kHz)	10 log (N=3) dB	Total PSD (dBm/500kHz)	Limit (dBm/500kHz)	Pass /Fail
0	149	5745	-3.57	-1.35	4.77	3.42	27.06	Pass
	157	5785	2.27	4.49	4.77	9.26	27.06	Pass
	165	5825	-1.32	0.90	4.77	5.67	27.06	Pass
1	149	5745	-4.53	-2.31	4.77	2.46	27.06	Pass
	157	5785	-0.17	2.05	4.77	6.82	27.06	Pass
	165	5825	-3.00	-0.78	4.77	3.99	27.06	Pass
2	149	5745	-3.32	-1.10	4.77	3.67	27.06	Pass
	157	5785	0.26	2.48	4.77	7.25	27.06	Pass
	165	5825	-1.41	0.81	4.77	5.58	27.06	Pass

Note:

- Directional gain = $10 \log[(10^{G1/20} + 10^{G2/20} + \dots + 10^{GN/20})^2/N]$ = 8.94dBi > 6dBi, so the power density limit shall be reduced to $30-(8.94-6) = 27.06\text{dBm}$.

802.11n (HT20)

TX chain	Chan.	Freq. (MHz)	PSD (dBm/300kHz)	PSD (dBm/500kHz)	10 log (N=3) dB	Duty Factor	Total PSD (dBm/500kHz)	Limit (dBm/500kHz)	Pass /Fail
0	149	5745	-5.87	-3.65	4.77	0.11	1.23	27.06	Pass
	157	5785	-0.11	2.11	4.77	0.11	6.99	27.06	Pass
	165	5825	-1.56	0.66	4.77	0.11	5.54	27.06	Pass
1	149	5745	-7.18	-4.96	4.77	0.11	-0.08	27.06	Pass
	157	5785	-1.17	1.05	4.77	0.11	5.93	27.06	Pass
	165	5825	-3.25	-1.03	4.77	0.11	3.85	27.06	Pass
2	149	5745	-5.66	-3.44	4.77	0.11	1.44	27.06	Pass
	157	5785	-1.37	0.85	4.77	0.11	5.73	27.06	Pass
	165	5825	-1.96	0.26	4.77	0.11	5.14	27.06	Pass

Note:

- Directional gain = $10 \log[(10^{G1/20} + 10^{G2/20} + \dots + 10^{GN/20})^2/N]$ = 8.94dBi > 6dBi, so the power density limit shall be reduced to $30-(8.94-6) = 27.06\text{dBm}$.
- Refer to section 3.3 for duty cycle spectrum plot.

802.11n (HT40)

TX chain	Chan.	Freq. (MHz)	PSD (dBm/300kHz)	PSD (dBm/500kHz)	10 log (N=3) dB	Duty Factor	Total PSD (dBm/500kHz)	Limit (dBm/500kHz)	Pass /Fail
0	151	5755	-10.44	-8.22	4.77	0.22	-3.23	27.06	Pass
	159	5795	-4.91	-2.69	4.77	0.22	2.30	27.06	Pass
1	151	5755	-11.11	-8.89	4.77	0.22	-3.90	27.06	Pass
	159	5795	-6.21	-3.99	4.77	0.22	1.00	27.06	Pass
2	151	5755	-9.94	-7.72	4.77	0.22	-2.73	27.06	Pass
	159	5795	-5.32	-3.10	4.77	0.22	1.89	27.06	Pass

Note:

- Directional gain = $10 \log[(10^{G1/20} + 10^{G2/20} + \dots + 10^{GN/20})^2/N] = 8.94\text{dBi} > 6\text{dBi}$, so the power density limit shall be reduced to $30-(8.94-6) = 27.06\text{dBm}$.
- Refer to section 3.3 for duty cycle spectrum plot.

802.11ac (VHT80)

TX chain	Chan.	Freq. (MHz)	PSD (dBm/300kHz)	PSD (dBm/500kHz)	10 log (N=3) dB	Duty Factor	Total PSD (dBm/500kHz)	Limit (dBm/500kHz)	Pass /Fail
0	155	5775	-14.20	-11.98	4.77	0.74	-6.47	27.06	Pass
1	155	5775	-15.20	-12.98	4.77	0.74	-7.47	27.06	Pass
2	155	5775	-13.57	-11.35	4.77	0.74	-5.84	27.06	Pass

Note:

- Directional gain = $10 \log[(10^{G1/20} + 10^{G2/20} + \dots + 10^{GN/20})^2/N] = 8.94\text{dBi} > 6\text{dBi}$, so the power density limit shall be reduced to $30-(8.94-6) = 27.06\text{dBm}$.
- Refer to section 3.3 for duty cycle spectrum plot.

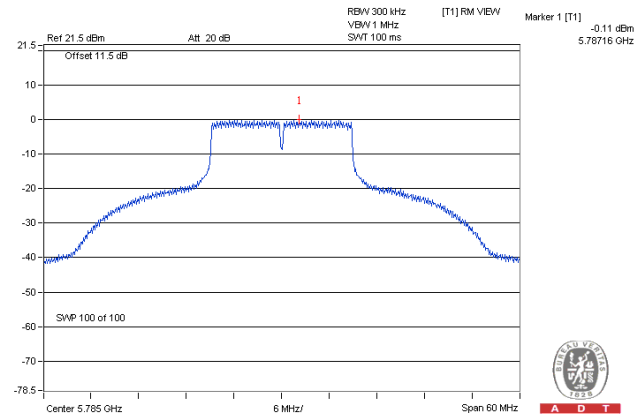
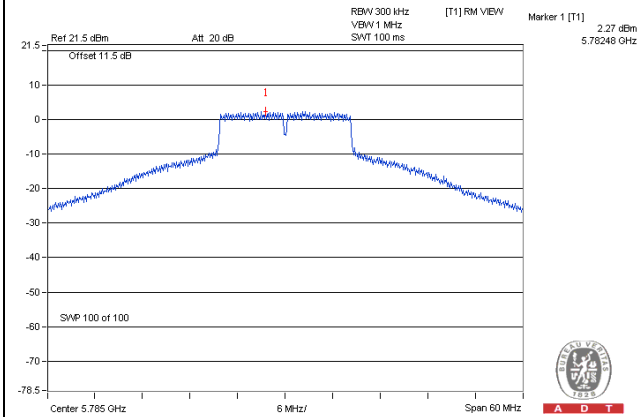
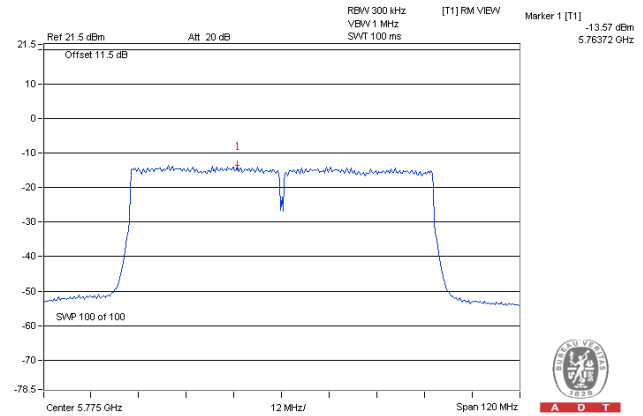
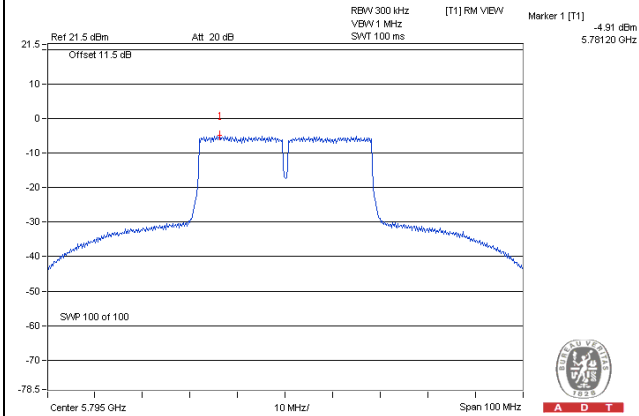
Spectrum Plot of Worst Value**802.11a****802.11n (HT20)****802.11n (HT40)****802.11ac (VHT80)**

Test Mode A
4TX
802.11a

TX chain	Chan.	Freq. (MHz)	PSD (dBm/300kHz)	PSD (dBm/500kHz)	10 log (N=4) dB	Duty Factor	Total PSD (dBm/500kHz)	Limit (dBm/500kHz)	Pass /Fail
0	149	5745	-3.65	-1.43	6.02	0.10	4.69	25.81	Pass
	157	5785	0.86	3.08	6.02	0.10	9.20	25.81	Pass
	165	5825	-2.06	0.16	6.02	0.10	6.28	25.81	Pass
1	149	5745	-3.19	-0.97	6.02	0.10	5.15	25.81	Pass
	157	5785	-0.03	2.19	6.02	0.10	8.31	25.81	Pass
	165	5825	-2.33	-0.11	6.02	0.10	6.01	25.81	Pass
2	149	5745	-5.22	-3.00	6.02	0.10	3.12	25.81	Pass
	157	5785	-0.60	1.62	6.02	0.10	7.74	25.81	Pass
	165	5825	-3.74	-1.52	6.02	0.10	4.60	25.81	Pass
3	149	5745	-3.99	-1.77	6.02	0.10	4.35	25.81	Pass
	157	5785	1.89	4.11	6.02	0.10	10.23	25.81	Pass
	165	5825	-2.18	0.04	6.02	0.10	6.16	25.81	Pass

Note:

1. Directional gain = $10 \log[(10^{G1/20} + 10^{G2/20} + \dots + 10^{GN/20})^2/N] = 10.19\text{dBi} > 6\text{dBi}$, so the power density limit shall be reduced to $30-(10.19-6) = 25.81\text{dBm}$.
2. Refer to section 3.3 for duty cycle spectrum plot.

802.11n (HT20)

TX chain	Chan.	Freq. (MHz)	PSD (dBm/300kHz)	PSD (dBm/500kHz)	10 log (N=4) dB	Total PSD (dBm/500kHz)	Limit (dBm/500kHz)	Pass /Fail
0	149	5745	-6.29	-4.07	6.02	1.95	25.81	Pass
	157	5785	-3.49	-1.27	6.02	4.75	25.81	Pass
	165	5825	-3.37	-1.15	6.02	4.87	25.81	Pass
1	149	5745	-6.22	-4.00	6.02	2.02	25.81	Pass
	157	5785	-4.01	-1.79	6.02	4.23	25.81	Pass
	165	5825	-3.84	-1.62	6.02	4.40	25.81	Pass
2	149	5745	-7.95	-5.73	6.02	0.29	25.81	Pass
	157	5785	-3.43	-1.21	6.02	4.81	25.81	Pass
	165	5825	-3.39	-1.17	6.02	4.85	25.81	Pass
3	149	5745	-6.58	-4.36	6.02	1.66	25.81	Pass
	157	5785	-3.60	-1.38	6.02	4.64	25.81	Pass
	165	5825	-3.65	-1.43	6.02	4.59	25.81	Pass

Note:

1. Directional gain = $10 \log[(10^{G1/20} + 10^{G2/20} + \dots + 10^{GN/20})^2/N] = 10.19\text{dBi} > 6\text{dBi}$, so the power density limit shall be reduced to $30-(10.19-6) = 25.81\text{dBm}$.

802.11n (HT40)

TX chain	Chan.	Freq. (MHz)	PSD (dBm/300kHz)	PSD (dBm/500kHz)	10 log (N=4) dB	Duty Factor	Total PSD (dBm/500kHz)	Limit (dBm/500kHz)	Pass /Fail
0	151	5755	-10.44	-8.22	6.02	0.22	-1.98	25.81	Pass
	159	5795	-6.48	-4.26	6.02	0.22	1.98	25.81	Pass
1	151	5755	-10.32	-8.10	6.02	0.22	-1.86	25.81	Pass
	159	5795	-6.63	-4.41	6.02	0.22	1.83	25.81	Pass
2	151	5755	-11.34	-9.12	6.02	0.22	-2.88	25.81	Pass
	159	5795	-6.72	-4.50	6.02	0.22	1.74	25.81	Pass
3	151	5755	-10.88	-8.66	6.02	0.22	-2.42	25.81	Pass
	159	5795	-6.81	-4.59	6.02	0.22	1.65	25.81	Pass

Note:

1. Directional gain = $10 \log[(10^{G1/20} + 10^{G2/20} + \dots + 10^{GN/20})^2/N] = 10.19\text{dBi} > 6\text{dBi}$, so the power density limit shall be reduced to $30-(10.19-6) = 25.81\text{dBm}$.
2. Refer to section 3.3 for duty cycle spectrum plot.

802.11ac (VHT80)

TX chain	Chan.	Freq. (MHz)	PSD (dBm/300kHz)	PSD (dBm/500kHz)	10 log (N=4) dB	Duty Factor	Total PSD (dBm/500kHz)	Limit (dBm/500kHz)	Pass /Fail
0	155	5775	-13.96	-11.74	6.02	0.34	-5.38	25.81	Pass
1	155	5775	-13.73	-11.51	6.02	0.34	-5.15	25.81	Pass
2	155	5775	-15.23	-13.01	6.02	0.34	-6.65	25.81	Pass
3	155	5775	-14.20	-11.98	6.02	0.34	-5.62	25.81	Pass

Note:

- Directional gain = $10 \log[(10^{G1/20} + 10^{G2/20} + \dots + 10^{GN/20})^2/N] = 10.19\text{dBi} > 6\text{dBi}$, so the power density limit shall be reduced to $30-(10.19-6) = 25.81\text{dBm}$.
- Refer to section 3.3 for duty cycle spectrum plot.

Spectrum Plot of Worst Value

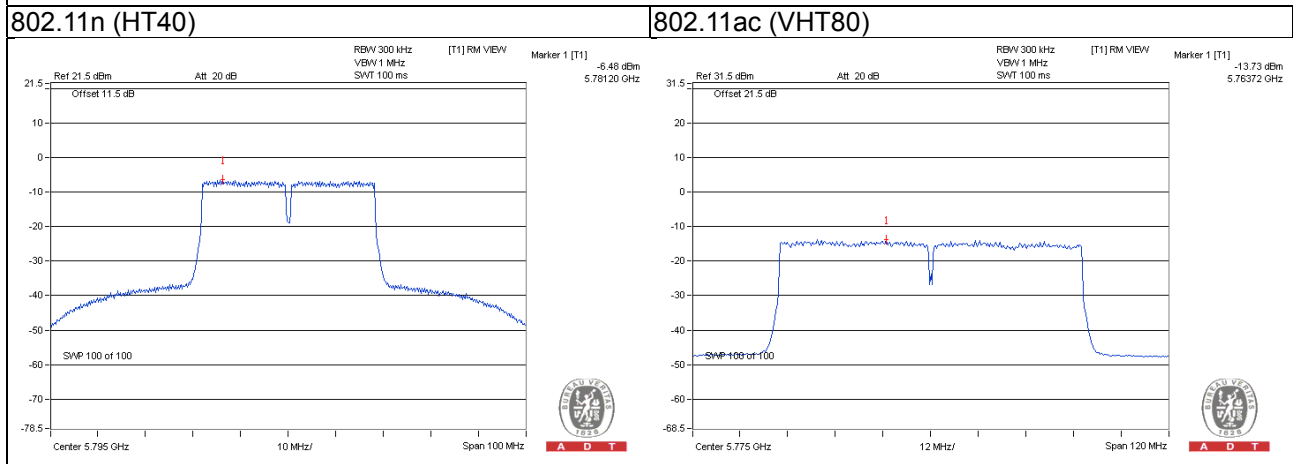
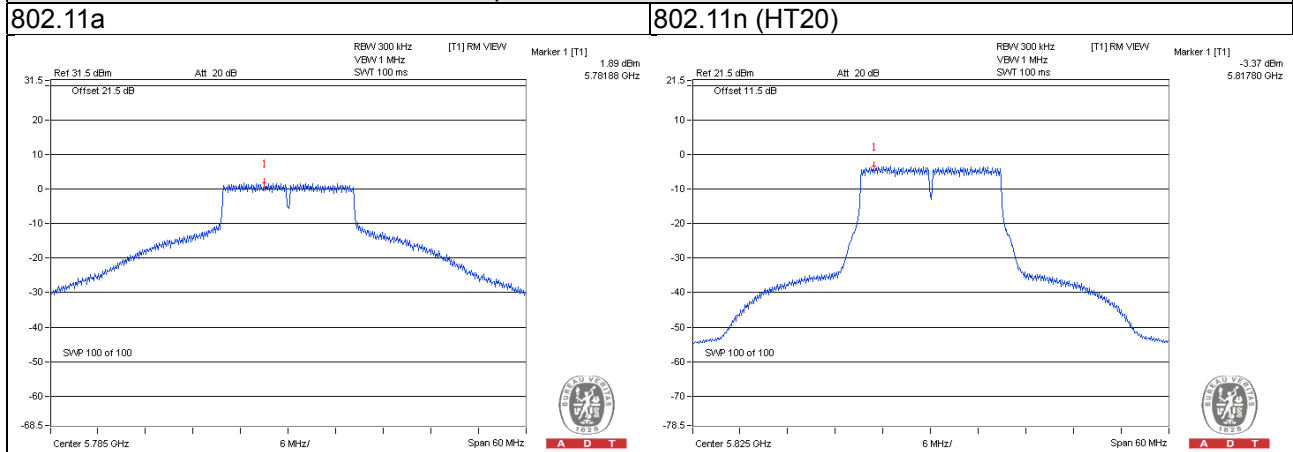

Test Mode C
1TX
802.11a

Chan.	Freq. (MHz)	PSD (dBm/300k Hz)	PSD (dBm/500k Hz)	Duty factor	Total PSD (dBm/500k Hz)	Limit (dBm/500k Hz)	Pass / Fail
149	5745	-2.36	-0.14	0.19	0.05	30.00	Pass
157	5785	0.84	3.06	0.19	3.25	30.00	Pass
165	5825	-0.52	1.70	0.19	1.89	30.00	Pass

802.11n (HT20)

Chan.	Freq. (MHz)	PSD (dBm/300k Hz)	PSD (dBm/500k Hz)	Duty factor	Total PSD (dBm/500k Hz)	Limit (dBm/500k Hz)	Pass / Fail
149	5745	-4.70	-2.48	0.19	-2.29	30.00	Pass
157	5785	0.39	2.61	0.19	2.80	30.00	Pass
165	5825	-1.09	1.13	0.19	1.32	30.00	Pass

802.11n (HT40)

Chan.	Freq. (MHz)	PSD (dBm/300k Hz)	PSD (dBm/500k Hz)	Duty factor	Total PSD (dBm/500k Hz)	Limit (dBm/500k Hz)	Pass / Fail
151	5755	-8.67	-6.45	0.62	-5.83	30.00	Pass
159	5795	-4.76	-2.54	0.62	-1.92	30.00	Pass

802.11ac (VHT80)

Chan.	Freq. (MHz)	PSD (dBm/300k Hz)	PSD (dBm/500k Hz)	Duty factor	Total PSD (dBm/500k Hz)	Limit (dBm/500k Hz)	Pass / Fail
155	5775	-12.22	-10.00	1.07	-8.93	30.00	Pass

Spectrum Plot of Worst Value

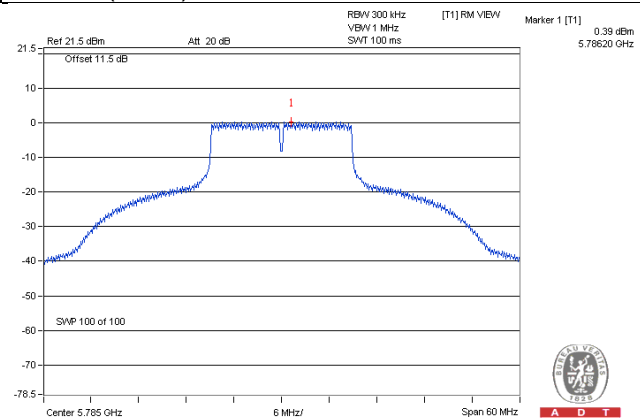
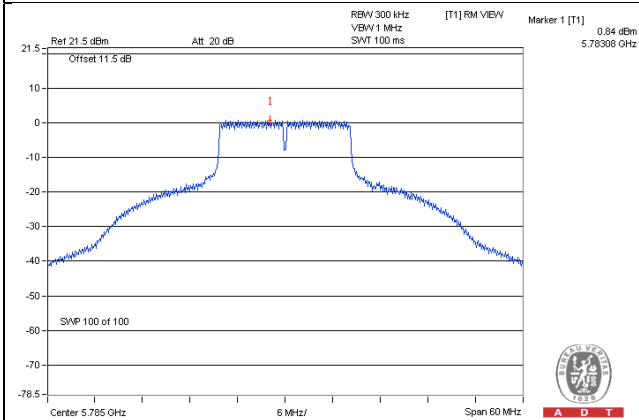
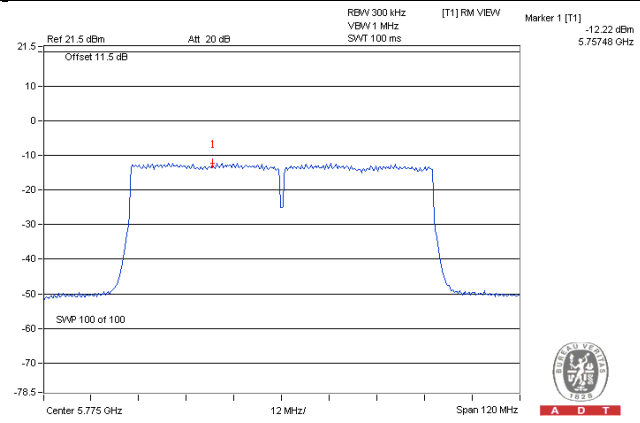
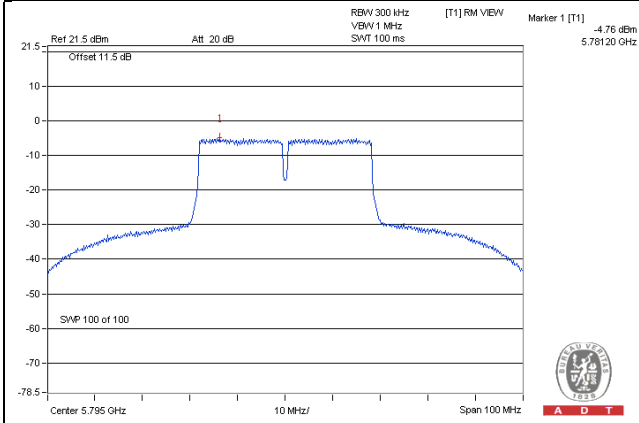
802.11a**802.11n (HT20)****802.11n (HT40)****802.11ac (VHT80)**

4.5 Frequency Stability

4.5.1 Limits of Frequency Stability Measurement

The frequency of the carrier signal shall be maintained within band of operation

4.5.2 Test Setup

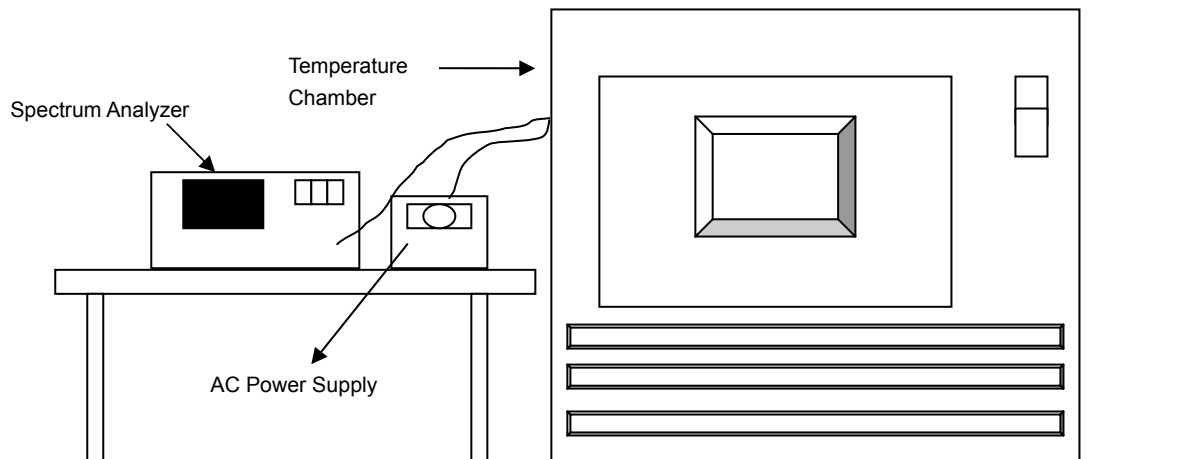

4.5.3 Test Instruments

Refer to section 4.1.2 to get information of above instrument.

4.5.4 Test Procedure

- The EUT was placed inside the environmental test chamber and powered by nominal AC voltage.
- Turn the EUT on and couple its output to a spectrum analyzer.
- Turn the EUT off and set the chamber to the highest temperature specified.
- Allow sufficient time (approximately 30 min) for the temperature of the chamber to stabilize, turn the EUT on and measure the operating frequency after 2, 5, and 10 minutes.
- Repeat step 2 and 3 with the temperature chamber set to the lowest temperature.
- The test chamber was allowed to stabilize at +20 degree C for a minimum of 30 minutes. The supply voltage was then adjusted on the EUT from 85% to 115% and the frequency record.

4.5.5 Deviation from Test Standard

No deviation.

4.5.6 EUT Operating Condition

Set the EUT transmit at un-modulation mode to test frequency stability.

4.5.7 Test Results

Test Mode A

1TX

Frequency Stability Versus Temp.									
Operating Frequency: 5180MHz									
Temp. (°C)	Power Supply (Vac)	0 Minute		2 Minute		5 Minute		10 Minute	
		Measured Frequency (MHz)	Frequency Drift (%)	Measured Frequency (MHz)	Frequency Drift (%)	Measured Frequency (MHz)	Frequency Drift (%)	Measured Frequency (MHz)	Frequency Drift (%)
50	120	5179.9991	-0.00002	5179.9968	-0.00006	5179.9987	-0.00003	5180.0009	0.00002
40	120	5180.0129	0.00025	5180.0139	0.00027	5180.0147	0.00028	5180.0109	0.00021
30	120	5179.9914	-0.00017	5179.9904	-0.00019	5179.9933	-0.00013	5179.9912	-0.00017
20	120	5179.9833	-0.00032	5179.9793	-0.00040	5179.9831	-0.00033	5179.9834	-0.00032
10	120	5180.0023	0.00004	5180.0044	0.00008	5180.0065	0.00013	5180.0051	0.00010
0	120	5180.0043	0.00008	5180.0021	0.00004	5180.0041	0.00008	5180.0060	0.00012
-10	120	5179.9879	-0.00023	5179.9867	-0.00026	5179.9871	-0.00025	5179.9863	-0.00026
-20	120	5179.9819	-0.00035	5179.9826	-0.00034	5179.9808	-0.00037	5179.9824	-0.00034
-30	120	5180.0197	0.00038	5180.0181	0.00035	5180.0207	0.00040	5180.0182	0.00035

Frequency Stability Versus Voltage									
Operating Frequency: 5180MHz									
Temp. (°C)	Power Supply (Vac)	0 Minute		2 Minute		5 Minute		10 Minute	
		Measured Frequency (MHz)	Frequency Drift (%)	Measured Frequency (MHz)	Frequency Drift (%)	Measured Frequency (MHz)	Frequency Drift (%)	Measured Frequency (MHz)	Frequency Drift (%)
20	138	5179.9832	-0.00032	5179.9787	-0.00041	5179.9829	-0.00033	5179.9832	-0.00032
	120	5179.9833	-0.00032	5179.9793	-0.00040	5179.9831	-0.00033	5179.9834	-0.00032
	102	5179.9823	-0.00034	5179.9795	-0.00040	5179.9829	-0.00033	5179.9826	-0.00034

Test Mode A
2TX

Frequency Stability Versus Temp.									
Operating Frequency: 5180MHz									
Temp. (°C)	Power Supply (Vac)	0 Minute		2 Minute		5 Minute		10 Minute	
		Measured Frequency (MHz)	Frequency Drift (%)	Measured Frequency (MHz)	Frequency Drift (%)	Measured Frequency (MHz)	Frequency Drift (%)	Measured Frequency (MHz)	Frequency Drift (%)
50	120	5179.9745	-0.00049	5179.9788	-0.00041	5179.9789	-0.00041	5179.9745	-0.00049
40	120	5180.0100	0.00019	5180.0129	0.00025	5180.0130	0.00025	5180.0117	0.00023
30	120	5179.9821	-0.00035	5179.9802	-0.00038	5179.9802	-0.00038	5179.9776	-0.00043
20	120	5179.9959	-0.00008	5179.9962	-0.00007	5179.9990	-0.00002	5179.9966	-0.00007
10	120	5180.0202	0.00039	5180.0191	0.00037	5180.0211	0.00041	5180.0233	0.00045
0	120	5180.0207	0.00040	5180.0208	0.00040	5180.0196	0.00038	5180.0202	0.00039
-10	120	5179.9950	-0.00010	5179.9938	-0.00012	5179.9968	-0.00006	5179.9961	-0.00008
-20	120	5180.0045	0.00009	5180.0059	0.00011	5180.0046	0.00009	5180.0025	0.00005
-30	120	5180.0048	0.00009	5180.0066	0.00013	5180.0068	0.00013	5180.0032	0.00006

Frequency Stability Versus Voltage									
Operating Frequency: 5180MHz									
Temp. (°C)	Power Supply (Vac)	0 Minute		2 Minute		5 Minute		10 Minute	
		Measured Frequency (MHz)	Frequency Drift (%)	Measured Frequency (MHz)	Frequency Drift (%)	Measured Frequency (MHz)	Frequency Drift (%)	Measured Frequency (MHz)	Frequency Drift (%)
20	138	5179.9950	-0.00010	5179.9963	-0.00007	5179.9987	-0.00003	5179.9972	-0.00005
	120	5179.9959	-0.00008	5179.9962	-0.00007	5179.9990	-0.00002	5179.9966	-0.00007
	102	5179.9967	-0.00006	5179.9969	-0.00006	5179.9980	-0.00004	5179.9972	-0.00005



Test Mode A

3TX

Frequency Stability Versus Temp.									
Operating Frequency: 5180MHz									
Temp. (°C)	Power Supply (Vac)	0 Minute		2 Minute		5 Minute		10 Minute	
		Measured Frequency (MHz)	Frequency Drift (%)	Measured Frequency (MHz)	Frequency Drift (%)	Measured Frequency (MHz)	Frequency Drift (%)	Measured Frequency (MHz)	Frequency Drift (%)
50	120	5180.0208	0.00040	5180.0192	0.00037	5180.0201	0.00039	5180.0190	0.00037
40	120	5179.9961	-0.00008	5179.9940	-0.00012	5179.9956	-0.00008	5179.9954	-0.00009
30	120	5180.0000	0.00000	5179.9977	-0.00004	5180.0009	0.00002	5179.9998	0.00000
20	120	5179.9781	-0.00042	5179.9757	-0.00047	5179.9778	-0.00043	5179.9800	-0.00039
10	120	5180.0108	0.00021	5180.0068	0.00013	5180.0066	0.00013	5180.0070	0.00014
0	120	5179.9842	-0.00031	5179.9875	-0.00024	5179.9846	-0.00030	5179.9839	-0.00031
-10	120	5179.9965	-0.00007	5179.9943	-0.00011	5179.9983	-0.00003	5179.9963	-0.00007
-20	120	5180.0021	0.00004	5180.0015	0.00003	5179.9998	0.00000	5179.9987	-0.00003
-30	120	5179.9938	-0.00012	5179.9952	-0.00009	5179.9943	-0.00011	5179.9923	-0.00015

Frequency Stability Versus Voltage									
Operating Frequency: 5180MHz									
Temp. (°C)	Power Supply (Vac)	0 Minute		2 Minute		5 Minute		10 Minute	
		Measured Frequency (MHz)	Frequency Drift (%)	Measured Frequency (MHz)	Frequency Drift (%)	Measured Frequency (MHz)	Frequency Drift (%)	Measured Frequency (MHz)	Frequency Drift (%)
20	138	5179.9775	-0.00043	5179.9754	-0.00047	5179.9774	-0.00044	5179.9803	-0.00038
	120	5179.9781	-0.00042	5179.9757	-0.00047	5179.9778	-0.00043	5179.9800	-0.00039
	102	5179.9774	-0.00044	5179.9760	-0.00046	5179.9768	-0.00045	5179.9796	-0.00039

Test Mode A
4TX

Frequency Stability Versus Temp.									
Operating Frequency: 5180MHz									
Temp. (°C)	Power Supply (Vac)	0 Minute		2 Minute		5 Minute		10 Minute	
		Measured Frequency (MHz)	Frequency Drift (%)	Measured Frequency (MHz)	Frequency Drift (%)	Measured Frequency (MHz)	Frequency Drift (%)	Measured Frequency (MHz)	Frequency Drift (%)
50	120	5180.0160	0.00031	5180.0154	0.00030	5180.0165	0.00032	5180.0155	0.00030
40	120	5179.9996	-0.00001	5180.0002	0.00000	5179.9996	-0.00001	5180.0039	0.00008
30	120	5179.9970	-0.00006	5179.9962	-0.00007	5179.9928	-0.00014	5179.9966	-0.00007
20	120	5179.9754	-0.00047	5179.9760	-0.00046	5179.9747	-0.00049	5179.9750	-0.00048
10	120	5179.9783	-0.00042	5179.9802	-0.00038	5179.9812	-0.00036	5179.9785	-0.00042
0	120	5180.0191	0.00037	5180.0178	0.00034	5180.0188	0.00036	5180.0201	0.00039
-10	120	5179.9818	-0.00035	5179.9783	-0.00042	5179.9791	-0.00040	5179.9769	-0.00045
-20	120	5180.0134	0.00026	5180.0175	0.00034	5180.0178	0.00034	5180.0140	0.00027
-30	120	5179.9784	-0.00042	5179.9783	-0.00042	5179.9799	-0.00039	5179.9763	-0.00046

Frequency Stability Versus Voltage									
Operating Frequency: 5180MHz									
Temp. (°C)	Power Supply (Vac)	0 Minute		2 Minute		5 Minute		10 Minute	
		Measured Frequency (MHz)	Frequency Drift (%)	Measured Frequency (MHz)	Frequency Drift (%)	Measured Frequency (MHz)	Frequency Drift (%)	Measured Frequency (MHz)	Frequency Drift (%)
20	138	5179.9760	-0.00046	5179.9763	-0.00046	5179.9749	-0.00048	5179.9748	-0.00049
	120	5179.9754	-0.00047	5179.9760	-0.00046	5179.9747	-0.00049	5179.9750	-0.00048
	102	5179.9748	-0.00049	5179.9756	-0.00047	5179.9746	-0.00049	5179.9743	-0.00050



Test Mode C

1TX

Frequency Stability Versus Temp.									
Operating Frequency: 5180MHz									
Temp. (°C)	Power Supply (Vac)	0 Minute		2 Minute		5 Minute		10 Minute	
		Measured Frequency (MHz)	Frequency Drift (%)	Measured Frequency (MHz)	Frequency Drift (%)	Measured Frequency (MHz)	Frequency Drift (%)	Measured Frequency (MHz)	Frequency Drift (%)
50	120	5179.9955	-0.00009	5179.9986	-0.00003	5179.9957	-0.00008	5179.9992	-0.00002
40	120	5180.0072	0.00014	5180.0066	0.00013	5180.0041	0.00008	5180.0085	0.00016
30	120	5179.9885	-0.00022	5179.9863	-0.00026	5179.9858	-0.00027	5179.9885	-0.00022
20	120	5179.9735	-0.00051	5179.9744	-0.00049	5179.9734	-0.00051	5179.9736	-0.00051
10	120	5179.9882	-0.00023	5179.9871	-0.00025	5179.9842	-0.00031	5179.9844	-0.00030
0	120	5180.0214	0.00041	5180.0210	0.00041	5180.0200	0.00039	5180.0243	0.00047
-10	120	5180.0202	0.00039	5180.0219	0.00042	5180.0224	0.00043	5180.0208	0.00040
-20	120	5180.0018	0.00003	5179.9984	-0.00003	5179.9983	-0.00003	5180.0008	0.00002
-30	120	5179.9990	-0.00002	5179.9962	-0.00007	5179.9982	-0.00003	5179.9998	0.00000

Frequency Stability Versus Voltage									
Operating Frequency: 5180MHz									
Temp. (°C)	Power Supply (Vac)	0 Minute		2 Minute		5 Minute		10 Minute	
		Measured Frequency (MHz)	Frequency Drift (%)	Measured Frequency (MHz)	Frequency Drift (%)	Measured Frequency (MHz)	Frequency Drift (%)	Measured Frequency (MHz)	Frequency Drift (%)
20	138	5179.9736	-0.00051	5179.9750	-0.00048	5179.9732	-0.00052	5179.9743	-0.00050
	120	5179.9735	-0.00051	5179.9744	-0.00049	5179.9734	-0.00051	5179.9736	-0.00051
	102	5179.9744	-0.00049	5179.9749	-0.00048	5179.9741	-0.00050	5179.9743	-0.00050

4.6 6dB Bandwidth Measurement

4.6.1 Limits of 6dB Bandwidth Measurement

The minimum of 6dB Bandwidth Measurement is 0.5MHz.

4.6.2 Test Setup

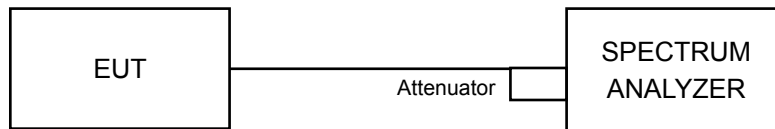

4.6.3 Test Instruments

Refer to section 4.1.2 to get information of above instrument.

4.6.4 Test Procedure

MEASUREMENT PROCEDURE REF

- Set resolution bandwidth (RBW) = 100kHz
- Set the video bandwidth (VBW) $\geq 3 \times$ RBW, Detector = Peak.
- Trace mode = max hold.
- Sweep = auto couple.
- Measure the maximum width of the emission that is constrained by the frequencies associated with the two amplitude points (upper and lower) that are attenuated by 6 dB relative to the maximum level measured in the fundamental emission

4.6.5 Deviation from Test Standard

No deviation.

4.6.6 EUT Operating Condition

The software provided by client to enable the EUT under transmission condition continuously at lowest, middle and highest channel frequencies individually.

4.6.7 Test Results

Test Mode A

1TX

802.11a

Channel	Frequency (MHz)	6dB Bandwidth (MHz)	Minimum Limit (MHz)	Pass / Fail
149	5745	16.39	0.5	Pass
157	5785	16.41	0.5	Pass
165	5825	16.40	0.5	Pass

802.11n (HT20)

Channel	Frequency (MHz)	6dB Bandwidth (MHz)	Minimum Limit (MHz)	Pass / Fail
149	5745	17.66	0.5	Pass
157	5785	17.67	0.5	Pass
165	5825	17.66	0.5	Pass

802.11n (HT40)

Channel	Frequency (MHz)	6dB Bandwidth (MHz)	Minimum Limit (MHz)	Pass / Fail
151	5755	36.49	0.5	Pass
159	5795	36.47	0.5	Pass

802.11ac (VHT80)

Channel	Frequency (MHz)	6dB Bandwidth (MHz)	Minimum Limit (MHz)	Pass / Fail
155	5775	76.46	0.5	Pass

Spectrum Plot of Worst Value

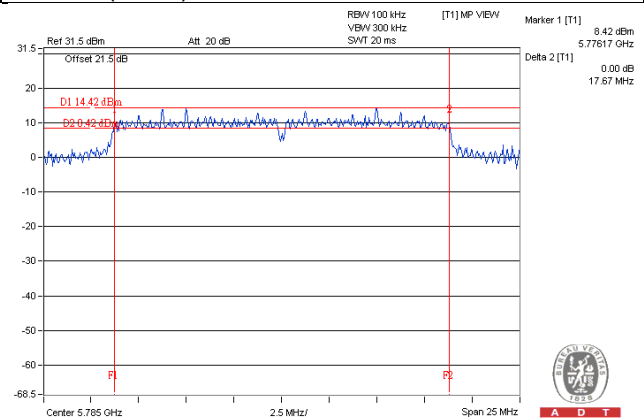
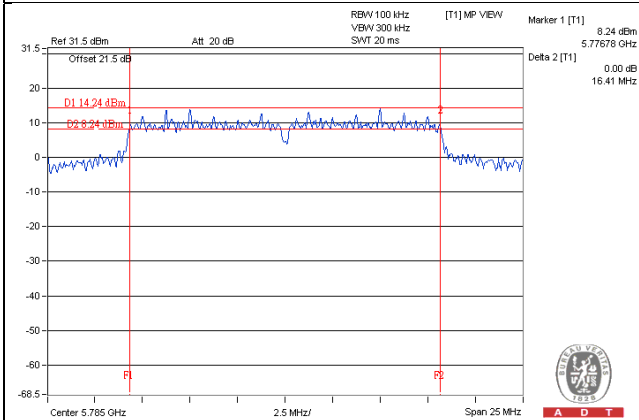
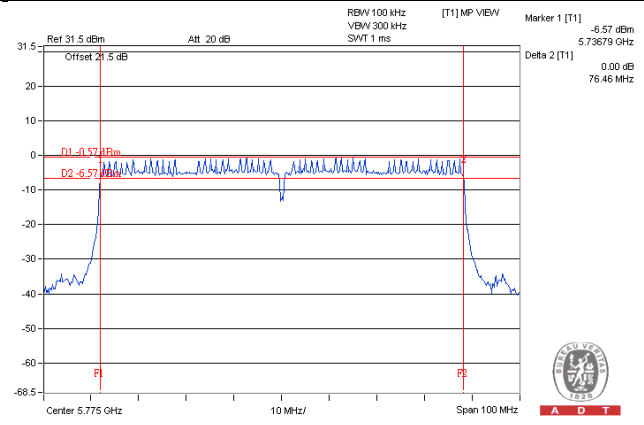
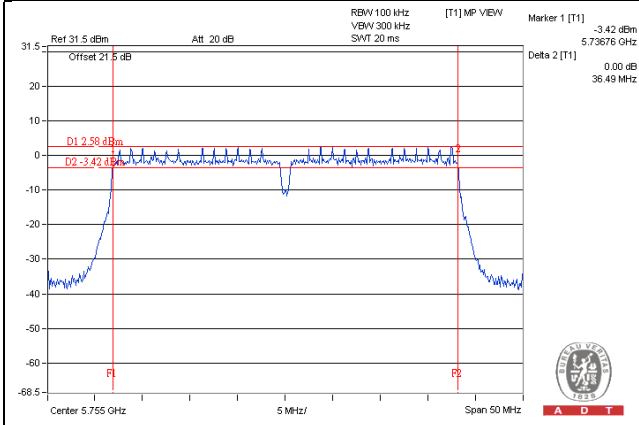
802.11a**802.11n (HT20)****802.11n (HT40)****802.11ac (VHT80)**

Test Mode A
2TX
802.11a

Chan.	Freq. (MHz)	6dB Bandwidth (MHz)		Minimum Limit (MHz)	Pass / Fail
		Chain 0	Chain 1		
149	5745	16.42	16.41	0.5	Pass
157	5785	16.42	16.39	0.5	Pass
165	5825	16.40	16.38	0.5	Pass

802.11n (HT20)

Chan.	Freq. (MHz)	6dB Bandwidth (MHz)		Minimum Limit (MHz)	Pass / Fail
		Chain 0	Chain 1		
149	5745	17.69	17.69	0.5	Pass
157	5785	17.61	17.64	0.5	Pass
165	5825	17.63	17.64	0.5	Pass

802.11n (HT40)

Chan.	Freq. (MHz)	6dB Bandwidth (MHz)		Minimum Limit (MHz)	Pass / Fail
		Chain 0	Chain 1		
151	5755	36.47	36.49	0.5	Pass
159	5795	36.47	36.51	0.5	Pass

802.11ac (VHT80)

Chan.	Freq. (MHz)	6dB Bandwidth (MHz)		Minimum Limit (MHz)	Pass / Fail
		Chain 0	Chain 1		
155	5775	76.37	76.48	0.5	Pass

Spectrum Plot of Worst Value

802.11a

802.11n (HT20)

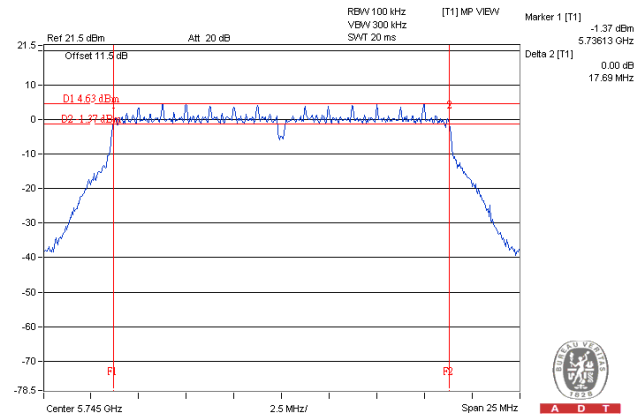
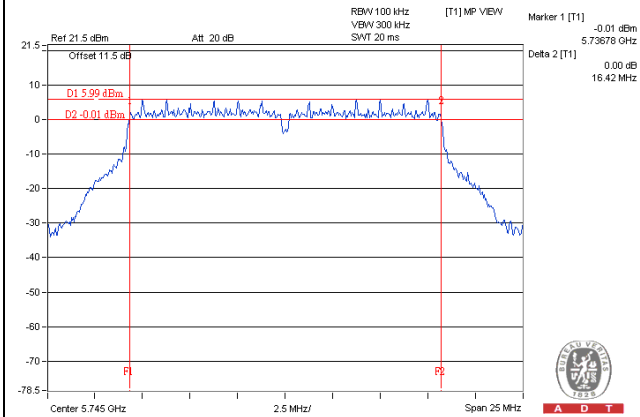

802.11n (HT40)

802.11ac (VHT80)

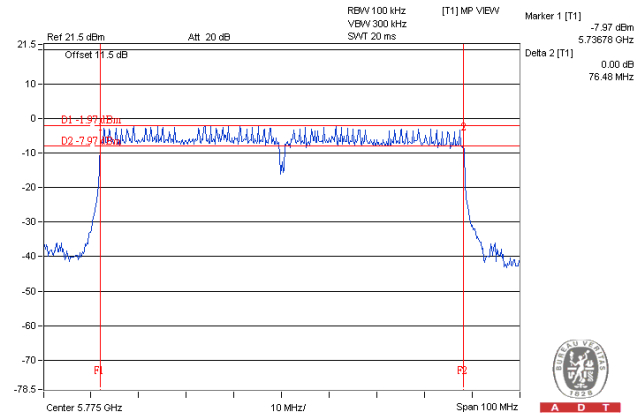
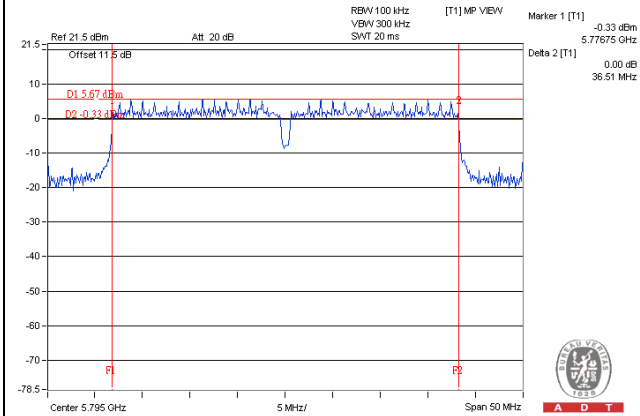

Test Mode A
3TX
802.11a

Chan.	Freq. (MHz)	6dB Bandwidth (MHz)			Minimum Limit (MHz)	Pass / Fail
		Chain 0	Chain 1	Chain 2		
149	5745	16.41	16.41	16.40	0.5	Pass
157	5785	16.38	16.38	16.38	0.5	Pass
165	5825	16.40	16.41	16.41	0.5	Pass

802.11n (HT20)

Chan.	Freq. (MHz)	6dB Bandwidth (MHz)			Minimum Limit (MHz)	Pass / Fail
		Chain 0	Chain 1	Chain 2		
149	5745	17.69	17.67	17.70	0.5	Pass
157	5785	17.63	17.61	17.63	0.5	Pass
165	5825	17.64	17.62	17.63	0.5	Pass

802.11n (HT40)

Chan.	Freq. (MHz)	6dB Bandwidth (MHz)			Minimum Limit (MHz)	Pass / Fail
		Chain 0	Chain 1	Chain 2		
151	5755	36.49	36.45	36.50	0.5	Pass
159	5795	36.47	36.47	36.47	0.5	Pass

802.11ac (VHT80)

Chan.	Freq. (MHz)	6dB Bandwidth (MHz)			Minimum Limit (MHz)	Pass / Fail
		Chain 0	Chain 1	Chain 2		
155	5775	76.22	76.45	76.48	0.5	Pass

Spectrum Plot of Worst Value

802.11a

802.11n (HT20)

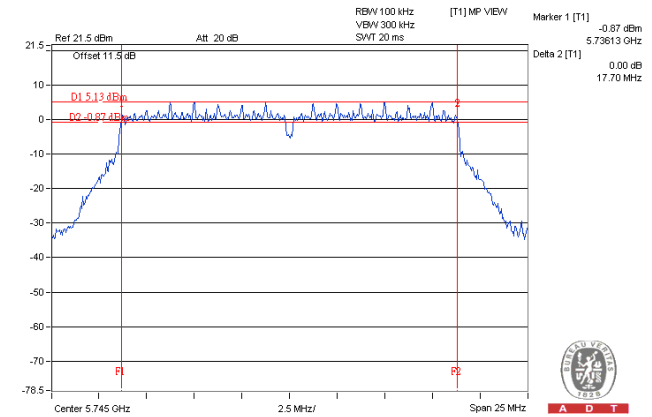
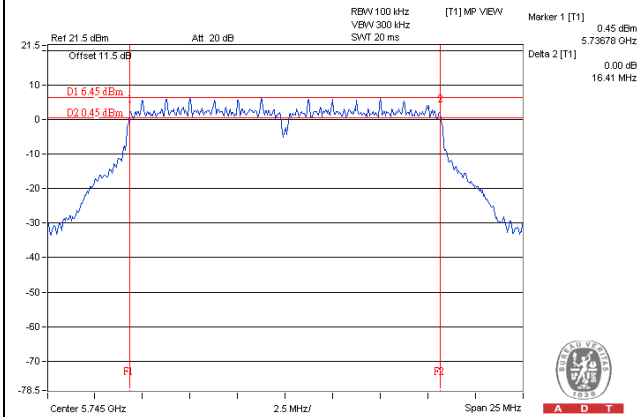

802.11n (HT40)

802.11ac (VHT80)

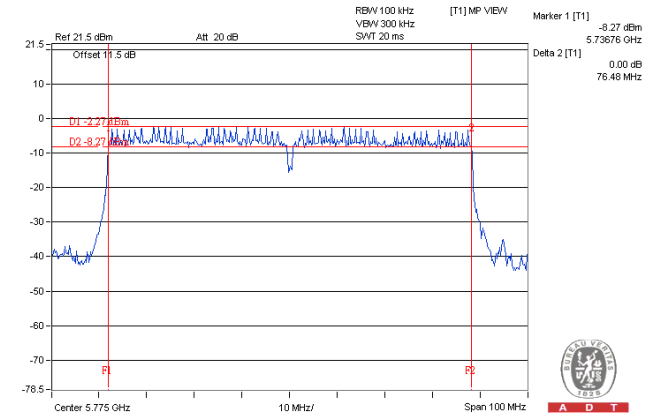
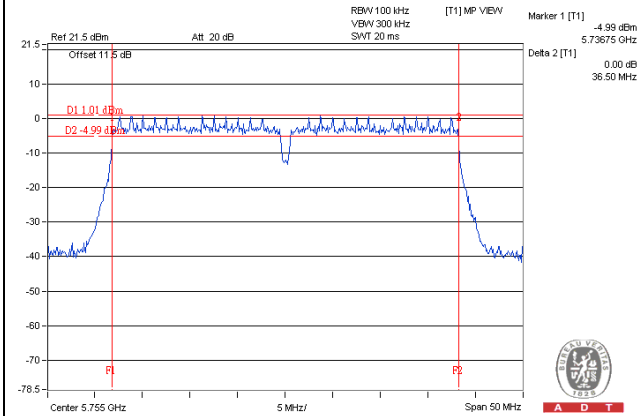

Test Mode A
4TX
802.11a

Chan.	Freq. (MHz)	6dB Bandwidth (MHz)				Minimum Limit (MHz)	Pass / Fail
		Chain 0	Chain 1	Chain 2	Chain 3		
149	5745	16.41	16.41	16.42	16.42	0.5	Pass
157	5785	16.40	16.38	16.38	16.38	0.5	Pass
165	5825	16.40	16.38	16.41	16.41	0.5	Pass

802.11n (HT20)

Chan.	Freq. (MHz)	6dB Bandwidth (MHz)				Minimum Limit (MHz)	Pass / Fail
		Chain 0	Chain 1	Chain 2	Chain 3		
149	5745	17.69	17.70	17.67	17.69	0.5	Pass
157	5785	17.66	17.68	17.65	17.64	0.5	Pass
165	5825	17.63	17.64	17.65	17.64	0.5	Pass

802.11n (HT40)

Chan.	Freq. (MHz)	6dB Bandwidth (MHz)				Minimum Limit (MHz)	Pass / Fail
		Chain 0	Chain 1	Chain 2	Chain 3		
151	5755	36.46	36.51	36.48	36.46	0.5	Pass
159	5795	36.46	36.49	36.50	36.47	0.5	Pass

802.11ac (VHT80)

Chan.	Freq. (MHz)	6dB Bandwidth (MHz)				Minimum Limit (MHz)	Pass / Fail
		Chain 0	Chain 1	Chain 2	Chain 3		
155	5775	76.20	76.43	76.44	76.19	0.5	Pass

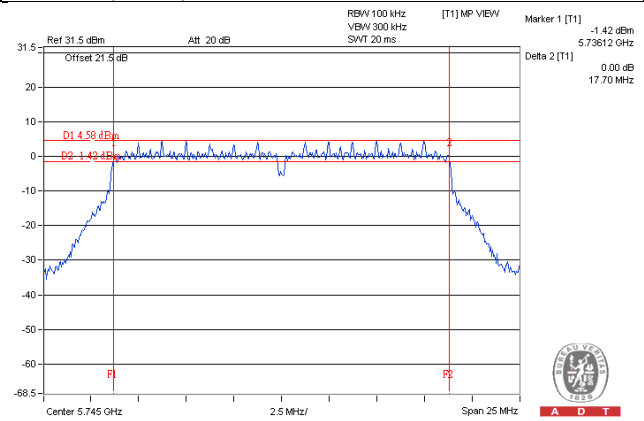
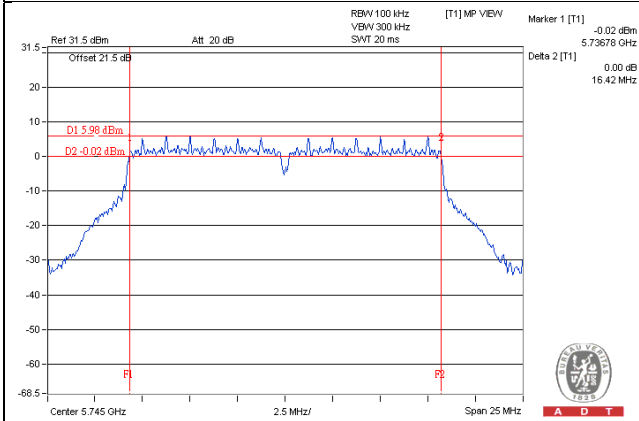
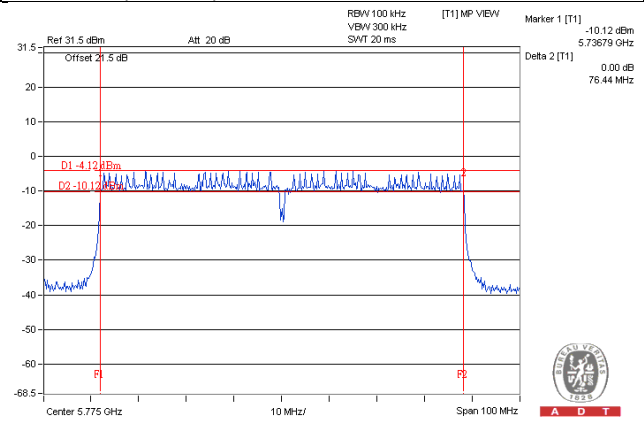
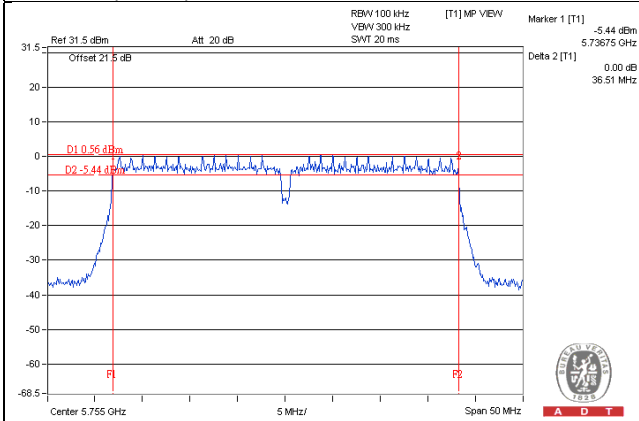
Spectrum Plot of Worst Value**802.11a****802.11n (HT20)****802.11n (HT40)****802.11ac (VHT80)**

Test Mode C**1TX****802.11a**

Channel	Frequency (MHz)	6dB Bandwidth (MHz)	Minimum Limit (MHz)	Pass / Fail
149	5745	16.42	0.5	Pass
157	5785	16.41	0.5	Pass
165	5825	16.39	0.5	Pass

802.11n (HT20)

Channel	Frequency (MHz)	6dB Bandwidth (MHz)	Minimum Limit (MHz)	Pass / Fail
149	5745	17.66	0.5	Pass
157	5785	17.62	0.5	Pass
165	5825	17.64	0.5	Pass

802.11n (HT40)

Channel	Frequency (MHz)	6dB Bandwidth (MHz)	Minimum Limit (MHz)	Pass / Fail
151	5755	36.47	0.5	Pass
159	5795	36.46	0.5	Pass

802.11ac (VHT80)

Channel	Frequency (MHz)	6dB Bandwidth (MHz)	Minimum Limit (MHz)	Pass / Fail
155	5775	76.42	0.5	Pass

Spectrum Plot of Worst Value

802.11a

802.11n (HT20)

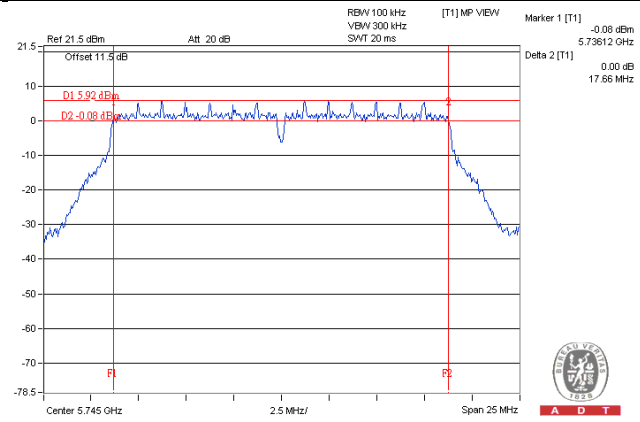
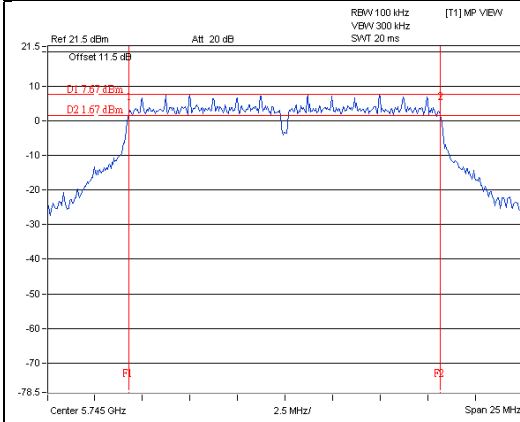

802.11n (HT40)

802.11ac (VHT80)

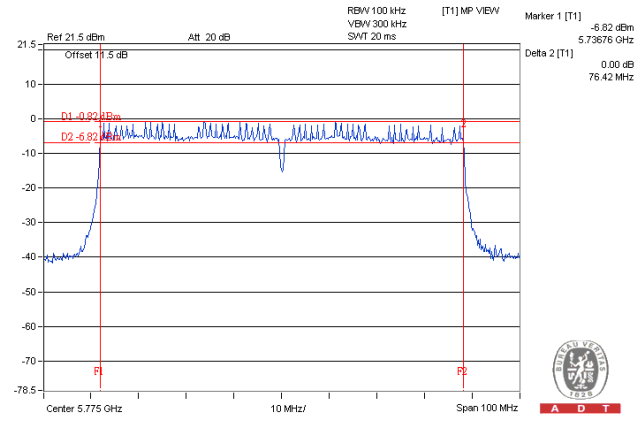
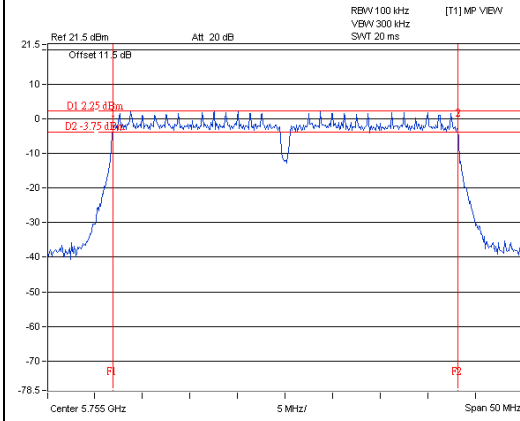



5 Pictures of Test Arrangements

Please refer to the attached file (Test Setup Photo).

Appendix – Information on the Testing Laboratories

We, Bureau Veritas Consumer Products Services (H.K.) Ltd., Taoyuan Branch, were founded in 1988 to provide our best service in EMC, Radio, Telecom and Safety consultation. Our laboratories are accredited and approved according to ISO/IEC 17025.

If you have any comments, please feel free to contact us at the following:

Linko EMC/RF Lab

Tel: 886-2-26052180

Fax: 886-2-26051924

Hsin Chu EMC/RF/Telecom Lab

Tel: 886-3-6668565

Fax: 886-3-6668323

Hwa Ya EMC/RF/Safety

Tel: 886-3-3183232

Fax: 886-3-3270892

Email: service.adt@tw.bureauveritas.com

Web Site: www.bureauveritas-adt.com

The address and road map of all our labs can be found in our web site also.

--- END ---