

FCC Test Report

Report No.: RF151230E03

FCC ID: 2AHBN-AP41

Test Model: AP41

Received Date: Dec. 23, 2015

Test Date: Dec. 24, 2015 ~ Jan. 19, 2016

Issued Date: Jan. 25, 2016

Applicant: Mist Systems, Inc.

Address: 1601 South De Anza Blvd. Suite 248 Cupertino California United States
95014

Issued By: Bureau Veritas Consumer Products Services (H.K.) Ltd., Taoyuan Branch

Lab Address: No. 47-2, 14th Ling, Chia Pau Vil., Lin Kou Dist., New Taipei City, Taiwan,
R.O.C.

Test Location: No. 19, Hwa Ya 2nd Rd., Wen Hwa Vil., Kwei Shan Dist., Taoyuan City
33383, TAIWAN (R.O.C.)



This report is for your exclusive use. Any copying or replication of this report to or for any other person or entity, or use of our name or trademark, is permitted only with our prior written permission. This report sets forth our findings solely with respect to the test samples identified herein. The results set forth in this report are not indicative or representative of the quality or characteristics of the lot from which a test sample was taken or any similar or identical product unless specifically and expressly noted. Our report includes all of the tests requested by you and the results thereof based upon the information that you provided to us. You have 60 days from date of issuance of this report to notify us of any material error or omission caused by our negligence, provided, however, that such notice shall be in writing and shall specifically address the issue you wish to raise. A failure to raise such issue within the prescribed time shall constitute your unqualified acceptance of the completeness of this report, the tests conducted and the correctness of the report contents. Unless specifically mentioned, the uncertainty of measurement has been explicitly taken into account to declare the compliance or non-compliance to the specification. This report should not be used by the client to claim product certification, approval, or endorsement by TAF or any government agencies.

Table of Contents

Release Control Record	4
1 Certificate of Conformity	5
2 Summary of Test Results	6
2.1 Measurement Uncertainty.....	6
2.2 Modification Record.....	6
3 General Information	7
3.1 General Description of EUT.....	7
3.2 Description of Test Modes.....	9
3.2.1 Test Mode Applicability and Tested Channel Detail.....	10
3.3 Duty Cycle of Test Signal.....	12
3.4 Description of Support Units.....	17
3.4.1 Configuration of System under Test.....	17
3.5 General Description of Applied Standards.....	18
4 Test Types and Results	19
4.1 Radiated Emission and Bandedge Measurement.....	19
4.1.1 Limits of Radiated Emission and Bandedge Measurement.....	19
4.1.2 Test Instruments.....	20
4.1.3 Test Procedures.....	21
4.1.4 Deviation from Test Standard.....	21
4.1.5 Test Set Up.....	22
4.1.6 EUT Operating Conditions.....	22
4.1.7 Test Results.....	23
4.2 Conducted Emission Measurement.....	87
4.2.1 Limits of Conducted Emission Measurement.....	87
4.2.2 Test Instruments.....	87
4.2.3 Test Procedures.....	88
4.2.4 Deviation from Test Standard.....	88
4.2.5 Test Setup.....	88
4.2.6 EUT Operating Conditions.....	88
4.2.7 Test Results.....	89
4.3 6dB Bandwidth Measurement.....	97
4.3.1 Limits of 6dB Bandwidth Measurement.....	97
4.3.2 Test Setup.....	97
4.3.3 Test Instruments.....	97
4.3.4 Test Procedure.....	97
4.3.5 Deviation from Test Standard.....	97
4.3.6 EUT Operating Conditions.....	97
4.3.7 Test Result.....	98
4.4 Conducted Output Power Measurement.....	108
4.4.1 Limits of Conducted Output Power Measurement.....	108
4.4.2 Test Setup.....	108
4.4.3 Test Instruments.....	108
4.4.4 Test Procedures.....	108
4.4.5 Deviation from Test Standard.....	108
4.4.6 EUT Operating Conditions.....	108
4.4.7 Test Results.....	109
4.5 Power Spectral Density Measurement.....	114
4.5.1 Limits of Power Spectral Density Measurement.....	114
4.5.2 Test Setup.....	114
4.5.3 Test Instruments.....	114
4.5.4 Test Procedure.....	114
4.5.5 Deviation from Test Standard.....	115
4.5.6 EUT Operating Condition.....	115

4.5.7 Test Results	115
4.6 Conducted Out of Band Emission Measurement.....	130
4.6.1 Limits of Conducted Out of Band Emission Measurement	130
4.6.2 Test Setup.....	130
4.6.3 Test Instruments	130
4.6.4 Test Procedure	130
4.6.5 Deviation from Test Standard	131
4.6.6 EUT Operating Condition	131
4.6.7 Test Results	131
5 Pictures of Test Arrangements.....	176
Appendix – Information on the Testing Laboratories	177



A D T

Release Control Record

Issue No.	Description	Date Issued
RF151230E03	Original release	Jan. 26, 2016



1 Certificate of Conformity

Product: Premium Wi-Fi & BLE Array AP

Brand: Mist

Test Model: AP41

Sample Status: Engineering sample

Applicant: Mist Systems, Inc.

Test Date: Dec. 24, 2015 ~ Jan. 19, 2016

Standards: 47 CFR FCC Part 15, Subpart C (Section 15.247)
ANSI C63.10:2013

The above equipment has been tested by **Bureau Veritas Consumer Products Services (H.K.) Ltd., Taoyuan Branch**, and found compliance with the requirement of the above standards. The test record, data evaluation & Equipment Under Test (EUT) configurations represented herein are true and accurate accounts of the measurements of the sample's EMC characteristics under the conditions specified in this report.

Prepared by :  , **Date:** Jan. 25, 2016
Pettie Chen / Senior Specialist

Approved by :  , **Date:** Jan. 25, 2016
Ken Liu / Senior Manager

2 Summary of Test Results

47 CFR FCC Part 15, Subpart C (Section 15.247)			
FCC Clause	Test Item	Result	Remarks
15.207	AC Power Conducted Emission	Pass	Meet the requirement of limit. Minimum passing margin is -3.06dB at 0.39219MHz
15.205 / 15.209 / 15.247(d)	Radiated Emissions and Band Edge Measurement	Pass	Meet the requirement of limit. Minimum passing margin is -0.1dB at 2390.0, 2483.50MHz.
15.247(d)	Antenna Port Emission	Pass	Meet the requirement of limit.
15.247(a)(2)	6dB bandwidth	Pass	Meet the requirement of limit.
15.247(b)	Conducted power	Pass	Meet the requirement of limit.
15.247(e)	Power Spectral Density	Pass	Meet the requirement of limit.
15.203	Antenna Requirement	Pass	Antenna connector is IPEX not a standard connector.

2.1 Measurement Uncertainty

Where relevant, the following measurement uncertainty levels have been estimated for tests performed on the EUT as specified in CISPR 16-4-2:

Measurement	Frequency	Expanded Uncertainty (k=2) (\pm)
Conducted Emissions at mains ports	150kHz ~ 30MHz	2.44 dB
Radiated Emissions up to 1 GHz	30MHz ~ 200MHz	3.59 dB
	200MHz ~ 1000MHz	3.60 dB
Radiated Emissions above 1 GHz	1GHz ~ 18GHz	2.29 dB
	18GHz ~ 40GHz	2.29 dB

2.2 Modification Record

There were no modifications required for compliance.

3 General Information

3.1 General Description of EUT

Product	Premium Wi-Fi & BLE Array AP
Brand	Mist
Test Model	AP41
Status of EUT	Engineering sample
Power Supply Rating	12Vdc from adapter 55Vdc from PoE
Modulation Type	CCK, DQPSK, DBPSK for DSSS 256QAM, 64QAM, 16QAM, QPSK, BPSK for OFDM
Modulation Technology	DSSS, OFDM
Transfer Rate	802.11b: 11.0/ 5.5/ 2.0/ 1.0Mbps 802.11g: 54.0/ 48.0/ 36.0/ 24.0/ 18.0/ 12.0/ 9.0/ 6.0Mbps 802.11n: up to 800.0Mbps with 256QAM
Operating Frequency	2412 ~ 2462MHz
Number of Channel	11 for 802.11b, 802.11g, 802.11n (HT20) 7 for 802.11n (HT40)
Output Power	Radio 1: 1TX: 184.077mW 2TX: 350.495mW 3TX: 509.626mW 4TX: 688.496mW Radio 2: 1TX: 22.336mW
Antenna Type	Refer to Note
Antenna Connector	IPEX
Accessory Device	N/A
Data Cable Supplied	N/A

Note:

1. There are three radios for the EUT.

Radio	Brand	Model	Function
Radio 1	Broadcom	BCM43465	WLAN 2.4G & 5G
Radio 2	Broadcom	BCM43465	WLAN 2.4G & 5G
Radio 3	Broadcom	BCM20704	BT EDR & BT LE

2. The EUT incorporates a MIMO function. Physically, the EUT provides 4 completed transmitters and 4 receivers.

Modulation Mode	TX Function	Beamforming
Radio 1		
802.11b	1TX/2TX/3TX/4TX	Not Support
802.11g	1TX/2TX/3TX/4TX	Not Support
802.11n (HT20)/(VHT20)	1TX/2TX/3TX/4TX	Support
802.11n (HT40)/(VHT40)	1TX/2TX/3TX/4TX	Support
Radio 2		
802.11b	1TX	Not Support
802.11g	1TX	Not Support
802.11n (HT20)	1TX	Not Support
802.11n (HT40)	1TX	Not Support

*The worst case of Radio 1 is beamforming on mode for the final tests.

*The worst configuration is as below.

Mode	Chain
Radio 1 / 1TX	Chain 0
Radio 1 / 2TX	Chain 0 + 1
Radio 1 / 3TX	Chain 0 + 1 + 2
Radio 1 / 4TX	Chain 0 + 1 + 2 + 3

3. The EUT uses following adapter & PoE. (Support unit only)

Adapter	
Brand	Channel Well Technology
Model	2ABN036F US
Input Power	100-240Vac~50/60Hz 1.0A
Output Power	12.0Vdc / 3.0A
Power Line	1.45m DC cable without core attached on adapter

PoE	
Brand	Microsemi
Model	PD-9001GR/AT/AC
Input Power	100-240Vac~50/60Hz 0.67A
Output Power	55Vdc / 0.6A

4. The following antennas were provided to the EUT.

Antenna Type	PIFA				
Antenna Connector	IPEX				
Gain (dBi)	Frequency				
	2.4~2.4835GHz	5.15~5.25GHz	5.25~5.35GHz	5.47~5.725GHz	5.725~5.85GHz
Int. WIFI Ant. 1	3.06	3.85	3.97	4.21	4.18
Int. WIFI Ant. 2	3.64	4.49	4.21	3.27	3.99
Int. WIFI Ant. 3	3.37	3.50	4.04	4.14	4.34
Int. WIFI Ant. 4	3.54	3.87	3.77	4.02	4.17
Scanning Radio Ant.	3.61	3.59	4.21	4.43	4.29

*Int. WIFI Ant. 1~4 were for Radio 1.

*Scanning Radio Ant. was for Radio 2

3.2 Description of Test Modes

For 2.4GHz:

11 channels are provided for 802.11b, 802.11g and 802.11n (HT20):

Channel	Frequency	Channel	Frequency
1	2412MHz	7	2442MHz
2	2417MHz	8	2447MHz
3	2422MHz	9	2452MHz
4	2427MHz	10	2457MHz
5	2432MHz	11	2462MHz
6	2437MHz		

7 channels are provided for 802.11n (HT40):

Channel	Frequency	Channel	Frequency
3	2422MHz	7	2442MHz
4	2427MHz	8	2447MHz
5	2432MHz	9	2452MHz
6	2437MHz		

3.2.1 Test Mode Applicability and Tested Channel Detail

EUT CONFIGURE MODE	APPLICABLE TO				DESCRIPTION
	RE≥1G	RE<1G	PLC	APCM	
A	-	√	√	√	Radio 1 (Power from adapter)
B	√	√	√	-	Radio 1 (Power from PoE)
C	-	√	√	√	Radio 2 (Power from adapter)
D	√	√	√	-	Radio 2 (Power from PoE)

Where **RE≥1G**: Radiated Emission above 1GHz & Bandedge Measurement

RE<1G: Radiated Emission below 1GHz

PLC: Power Line Conducted Emission

APCM: Antenna Port Conducted Measurement

NOTE: 1. The EUT could just position on the Z-plane according to manufacturer's requirement.

2. "-" means no effect.

Radiated Emission Test (Above 1GHz):

- Pre-Scan has been conducted to determine the worst-case mode from all possible combinations between available modulations, data rates and antenna ports (if EUT with antenna diversity architecture).
- Following channel(s) was (were) selected for the final test as listed below.

EUT CONFIGURE MODE	MODE	AVAILABLE CHANNEL	TESTED CHANNEL	MODULATION TECHNOLOGY	MODULATION TYPE	DATA RATE (Mbps)
B, D	802.11b	1 to 11	1, 6, 11	DSSS	DBPSK	1.0
B, D	802.11g	1 to 11	1, 6, 11	OFDM	BPSK	6.0
B, D	802.11n (HT20)	1 to 11	1, 6, 11	OFDM	BPSK	6.5
B, D	802.11n (HT40)	3 to 9	3, 6, 9	OFDM	BPSK	13.5

Radiated Emission Test (Below 1GHz):

- Pre-Scan has been conducted to determine the worst-case mode from all possible combinations between available modulations, data rates and antenna ports (if EUT with antenna diversity architecture).
- Following channel(s) was (were) selected for the final test as listed below.

EUT CONFIGURE MODE	MODE	AVAILABLE CHANNEL	TESTED CHANNEL	MODULATION TECHNOLOGY	MODULATION TYPE	DATA RATE (Mbps)
A, B, C, D	802.11g	1 to 11	6	OFDM	BPSK	6.0

Power Line Conducted Emission Test:

- Pre-Scan has been conducted to determine the worst-case mode from all possible combinations between available modulations, data rates and antenna ports (if EUT with antenna diversity architecture).
- Following channel(s) was (were) selected for the final test as listed below.

EUT CONFIGURE MODE	MODE	AVAILABLE CHANNEL	TESTED CHANNEL	MODULATION TECHNOLOGY	MODULATION TYPE	DATA RATE (Mbps)
A, B, C, D	802.11g	1 to 11	6	OFDM	BPSK	6.0

Antenna Port Conducted Measurement:

- This item includes all test value of each mode, but only includes spectrum plot of worst value of each mode.
- Pre-Scan has been conducted to determine the worst-case mode from all possible combinations between available modulations, data rates and antenna ports (if EUT with antenna diversity architecture).
- Following channel(s) was (were) selected for the final test as listed below.

EUT CONFIGURE MODE	MODE	AVAILABLE CHANNEL	TESTED CHANNEL	MODULATION TECHNOLOGY	MODULATION TYPE	DATA RATE (Mbps)
A, C	802.11b	1 to 11	1, 6, 11	DSSS	DBPSK	1.0
A, C	802.11g	1 to 11	1, 6, 11	OFDM	BPSK	6.0
A, C	802.11n (HT20)	1 to 11	1, 6, 11	OFDM	BPSK	6.5
A, C	802.11n (HT40)	3 to 9	3, 6, 9	OFDM	BPSK	13.5

Test Condition:

APPLICABLE TO	ENVIRONMENTAL CONDITIONS	INPUT POWER	TESTED BY
RE≥1G	19deg. C, 71%RH 25deg. C, 65%RH	55Vdc	Jones Chang Chris Lin
RE<1G	23deg. C, 66%RH	120Vac, 60Hz 55Vdc	Alan Wu
PLC	25deg. C, 65%RH	120Vac, 60Hz 55Vdc	Chris Lin
APCM	25deg. C, 60%RH	120Vac, 60Hz	Frank Liu Leo Tsai

3.3 Duty Cycle of Test Signal

Radio 1:

1TX

Duty cycle of test signal is > 98%, duty factor is not required

Duty cycle of test signal is < 98 %, duty factor is required

802.11b: Duty cycle = 100%

802.11g: Duty cycle = 2.06/2.094 = 0.984

802.11n (HT20): Duty cycle = 1.919/1.95 = 0.984

802.11n (HT40): Duty cycle = 0.942/0.981 = 0.96, Duty factor = $10 * \log(1/0.96) = 0.18$

802.11b 802.11g

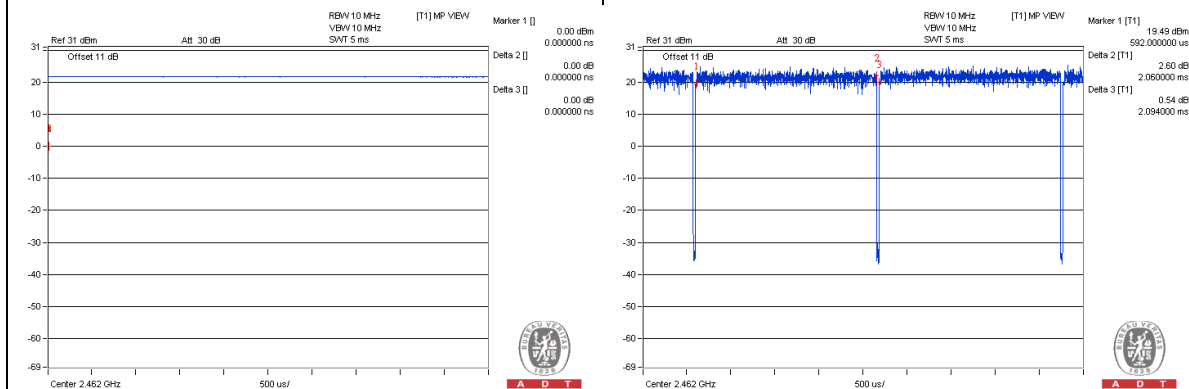

802.11n (HT20) 802.11n (HT40)

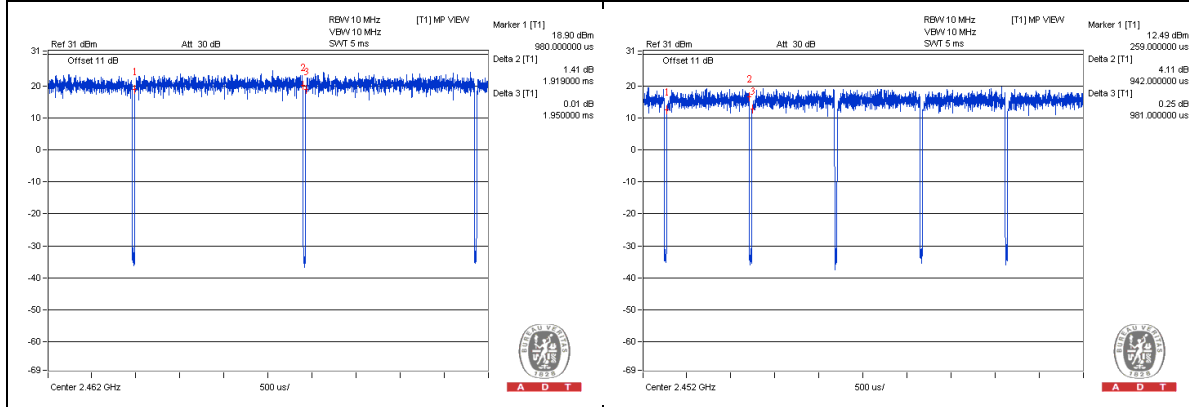

2TX

Duty cycle of test signal is > 98%, duty factor is not required

Duty cycle of test signal is < 98 %, duty factor is required

802.11b: Duty cycle = 100%

802.11g: Duty cycle = 2.06/2.097 = 0.982

802.11n (HT20): Duty cycle = 1.92/1.949 = 0.985

802.11n (HT40): Duty cycle = 0.938/0.98 = 0.957, Duty factor = $10 * \log(1/0.957) = 0.19$

802.11b

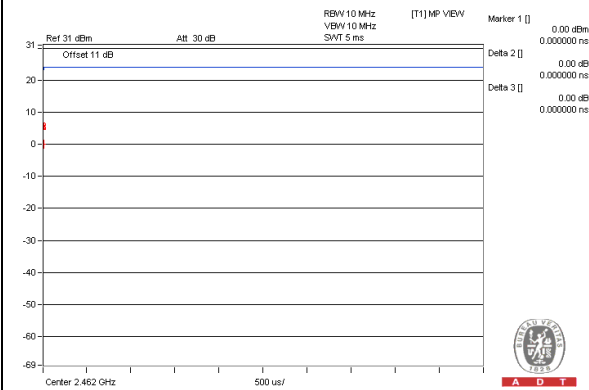

802.11g

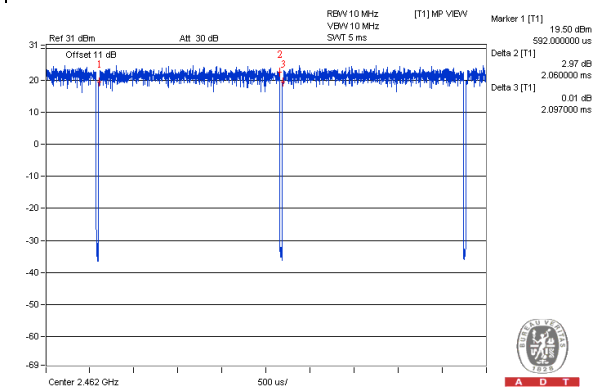

802.11n (HT20)

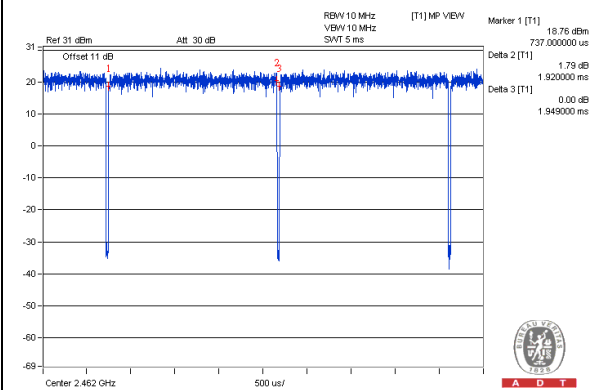

802.11n (HT40)

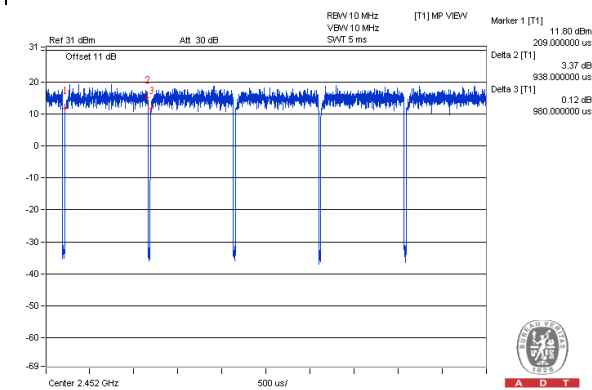

3TX

Duty cycle of test signal is > 98%, duty factor is not required

Duty cycle of test signal is < 98 %, duty factor is required

802.11b: Duty cycle = 100%

802.11g: Duty cycle = 2.059/2.098 = 0.981

802.11n (HT20): Duty cycle = 1.915/1.948 = 0.983

802.11n (HT40): Duty cycle = 0.941/0.972 = 0.968, Duty factor = $10 * \log(1/0.968) = 0.14$

802.11b **802.11g**

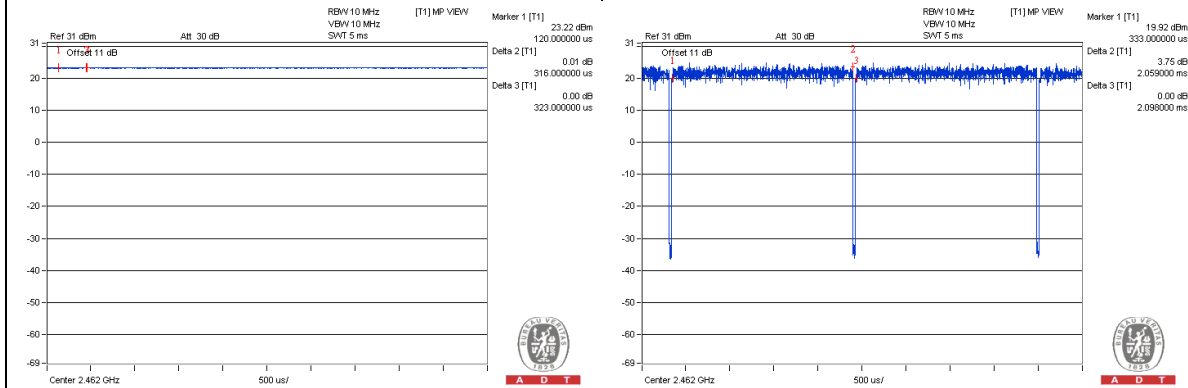

802.11n (HT20) **802.11n (HT40)**

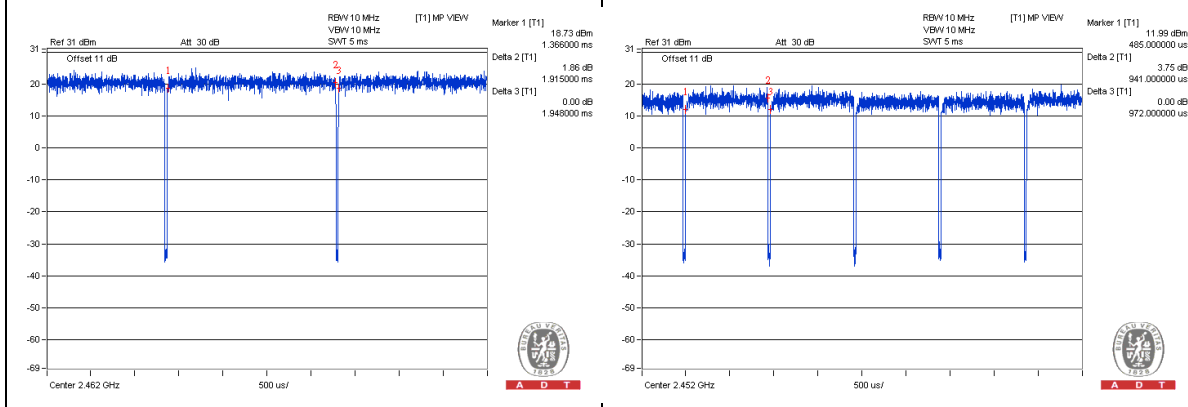

4TX

Duty cycle of test signal is > 98%, duty factor is not required

Duty cycle of test signal is < 98 %, duty factor is required

802.11b: Duty cycle = 100%

802.11g: Duty cycle = 2.06/2.094 = 0.984

802.11n (HT20): Duty cycle = 1.917/1.947 = 0.985

802.11n (HT40): Duty cycle = 0.942/0.973 = 0.968, Duty factor = $10 * \log(1/0.968) = 0.14$

802.11b

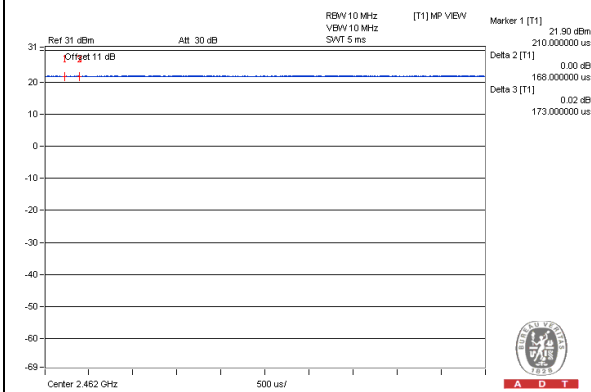

802.11g

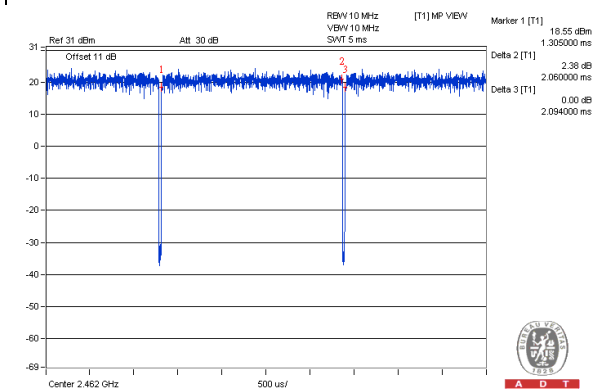

802.11n (HT20)

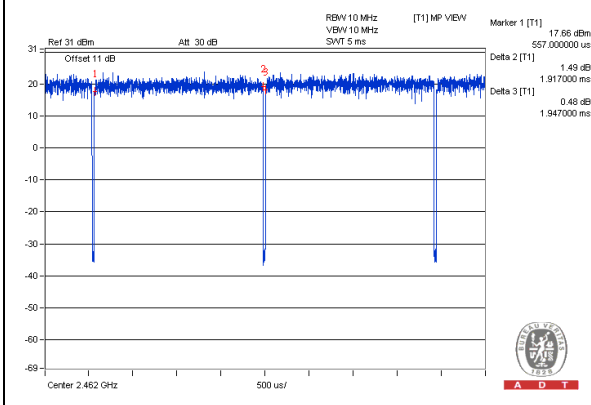

802.11n (HT40)

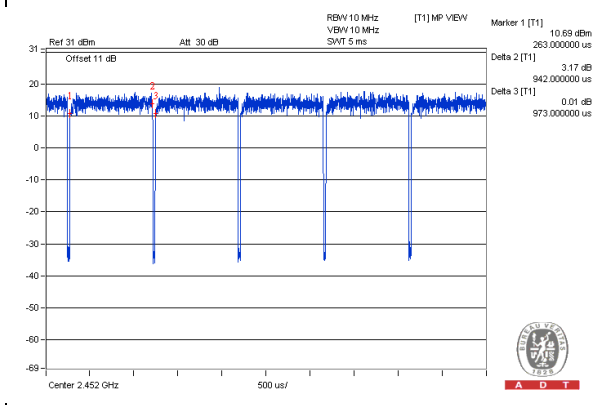

Radio 2:

1TX

Duty cycle of test signal is > 98%, duty factor is not required

Duty cycle of test signal is < 98 %, duty factor is required

802.11b: Duty cycle = 100%

802.11g: Duty cycle = $2.054/2.109 = 0.974$, Duty factor = $10 * \log(1/0.974) = 0.11$

802.11n (HT20): Duty cycle = $1.917/1.967 = 0.975$, Duty factor = $10 * \log(1/0.975) = 0.11$

802.11n (HT40): Duty cycle = $0.94/0.982 = 0.957$, Duty factor = $10 * \log(1/0.957) = 0.19$

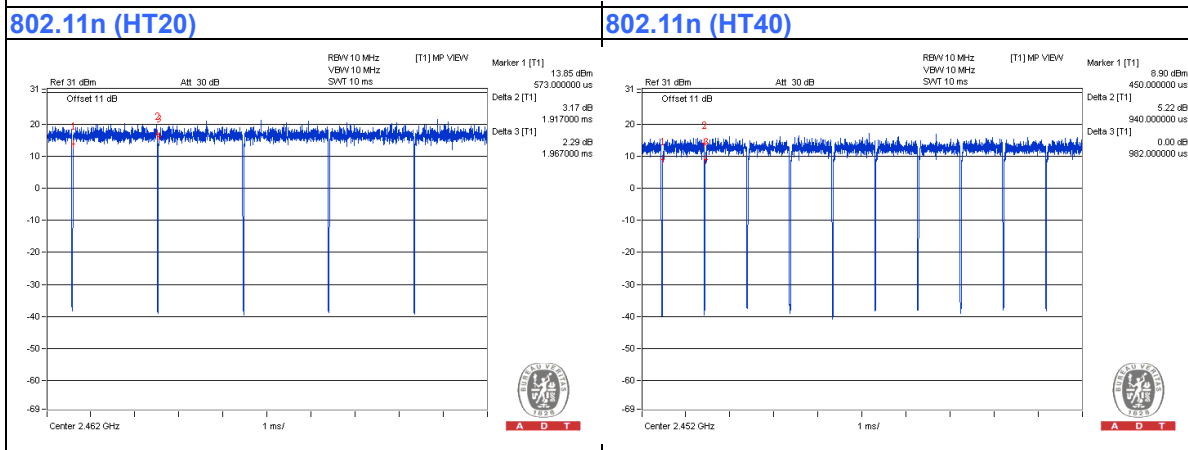
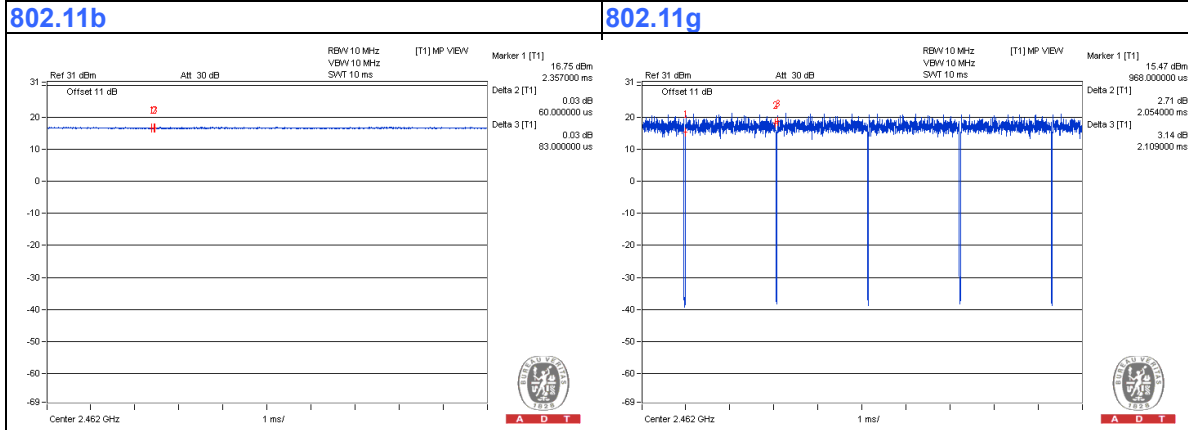

3.4 Description of Support Units

The EUT has been tested as an independent unit together with other necessary accessories or support units. The following support units or accessories were used to form a representative test configuration during the tests.

ID	Product	Brand	Model No.	Serial No.	FCC ID	Remarks
A.	Notebook	DELL	E5410	6RP2YM1	FCC DoC Approved	-
B.	USB 3.0 Flash Drive	HP	v250w	N/A	FCC DoC Approved	-
C.	Adapter	Channel Well Technology	2ABN036F US	N/A	N/A	Provided by client
D.	Load	N/A	N/A	N/A	N/A	-
E.	PoE	Microsemi	PD-9001GR/AT/AC	N/A	N/A	Provided by client

Note:

1. All power cords of the above support units are non-shielded (1.8m).
2. Items A acted as communication partners to transfer data.

ID	Descriptions	Qty.	Length (m)	Shielding (Yes/No)	Cores (Qty.)	Remarks
1.	RJ45 cable	1	10	N	0	-
2.	RJ45 cable	2	1.8	N	0	-
3.	DC cable	1	1.45	-	0	attached on adapter
4.	RJ45 cable	1	3	N	0	-

Note: The core(s) is(are) originally attached to the cable(s).

3.4.1 Configuration of System under Test

Test Mode A, C

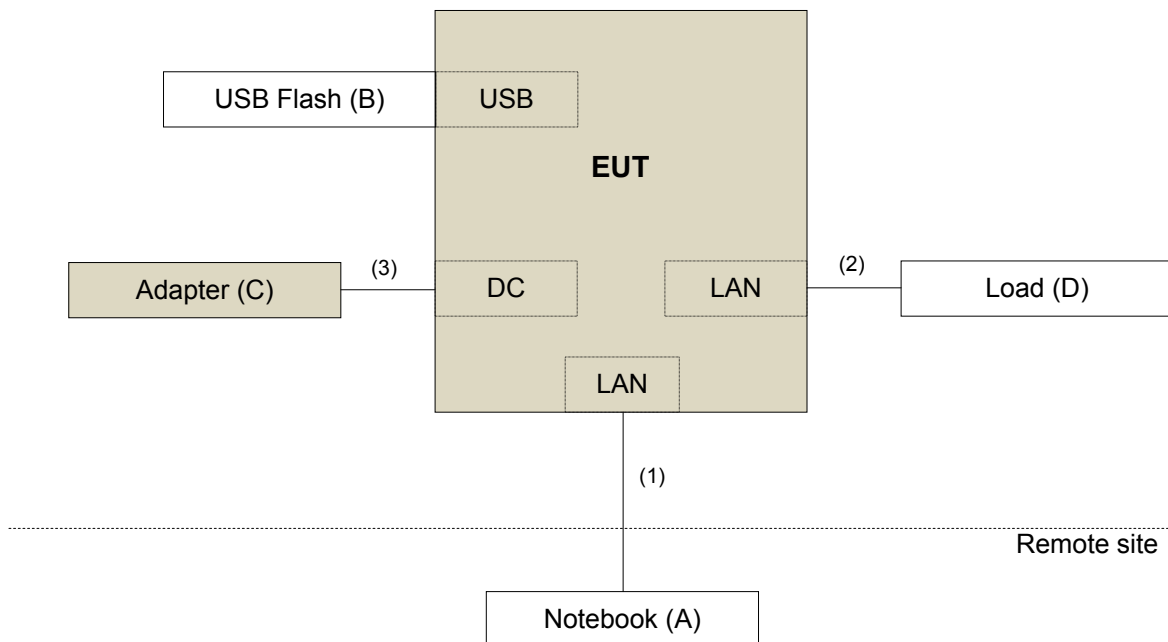

Test Mode B, D

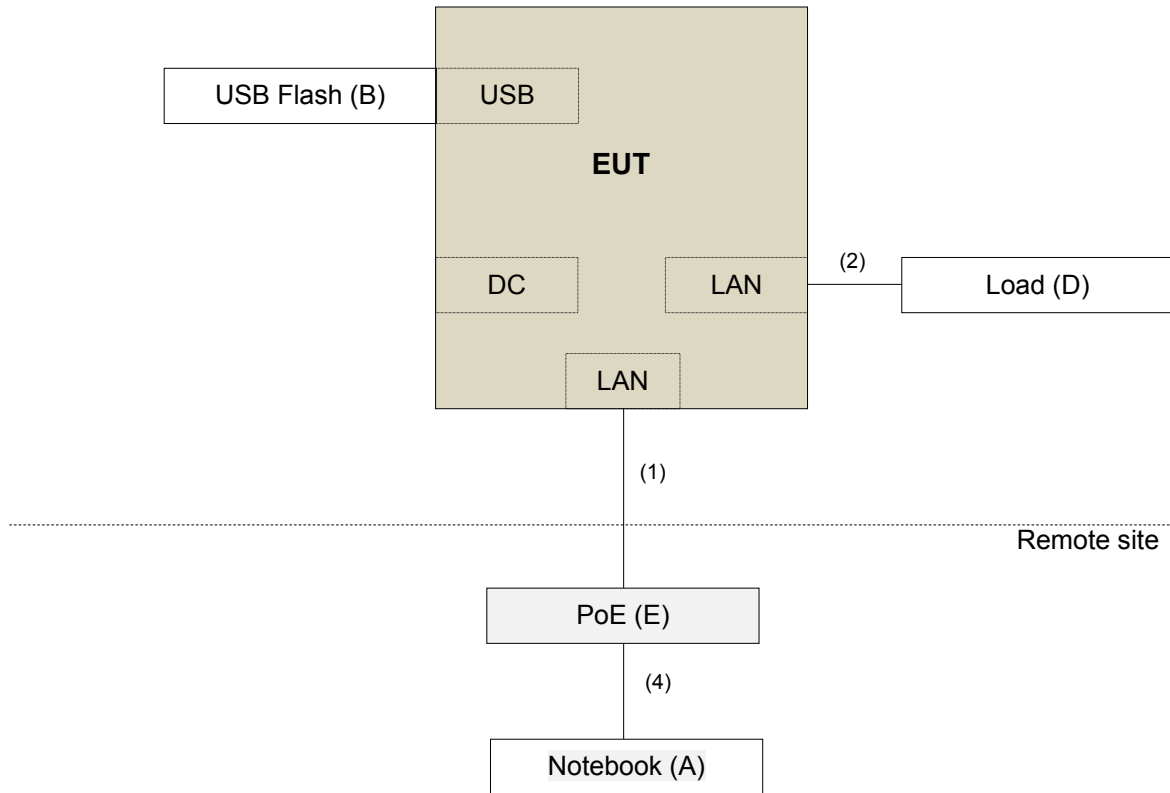

3.5 General Description of Applied Standards

The EUT is a RF Product. According to the specifications of the manufacturer, it must comply with the requirements of the following standards:

- FCC Part 15, Subpart C (15.247)**
- 558074 D01 DTS Meas Guidance v03r04**
- 662911 D01 Multiple Transmitter Output v02r01**
- ANSI C63.10-2013

All test items have been performed and recorded as per the above standards.

NOTE: The EUT has been verified to comply with the requirements of FCC Part 15, Subpart B, Class B (DoC). The test report has been issued separately.

4 Test Types and Results

4.1 Radiated Emission and Bandedge Measurement

4.1.1 Limits of Radiated Emission and Bandedge Measurement

Radiated emissions which fall in the restricted bands must comply with the radiated emission limits specified as below table. Other emissions shall be at least 30dB below the highest level of the desired power:

Frequencies (MHz)	Field Strength (microvolts/meter)	Measurement Distance (meters)
0.009 ~ 0.490	2400/F(kHz)	300
0.490 ~ 1.705	24000/F(kHz)	30
1.705 ~ 30.0	30	30
30 ~ 88	100	3
88 ~ 216	150	3
216 ~ 960	200	3
Above 960	500	3

Note:

1. The lower limit shall apply at the transition frequencies.
2. Emission level (dBuV/m) = 20 log Emission level (uV/m).
3. For frequencies above 1000MHz, the field strength limits are based on average detector, however, the peak field strength of any emission shall not exceed the maximum permitted average limits, specified above by more than 30dB under any condition of modulation.

4.1.2 Test Instruments

Description & Manufacturer	Model No.	Serial No.	Date Of Calibration	Due Date Of Calibration
Test Receiver ROHDE & SCHWARZ	ESCI	100424	Oct. 12, 2015	Oct. 11, 2016
Spectrum Analyzer ROHDE & SCHWARZ	FSP40	100040	Jul. 08, 2015	Jul. 07, 2016
BILOG Antenna SCHWARZBECK	VULB9168	9168-155	Feb. 06, 2015	Feb. 05, 2016
HORN Antenna SCHWARZBECK	BBHA 9120D	9120D-1170	Feb. 05, 2015	Feb. 04, 2016
HORN Antenna SCHWARZBECK	BBHA 9170	BBHA9170241	Feb. 09, 2015	Feb. 08, 2016
Preamplifier Agilent	8449B	3008A01960	Aug. 09, 2015	Aug. 08, 2016
Preamplifier Agilent	8447D	2944A10631	Aug. 09, 2015	Aug. 08, 2016
RF signal cable HUBER+SUHNER	SUCOFLEX 104	Cable-CH4-02(295012+309220)	Aug. 09, 2015	Aug. 08, 2016
RF signal cable HUBER+SUHNER	SUCOFLEX 104	Cable-CH4-03(250724)	Aug. 09, 2015	Aug. 08, 2016
Software BV ADT	ADT_Radiated_V7.6.15.9.4	NA	NA	NA
Antenna Tower inn-co GmbH	MA 4000	010303	NA	NA
Antenna Tower Controller BV ADT	AT100	AT93021703	NA	NA
Turn Table BV ADT	TT100	TT93021703	NA	NA
Turn Table Controller BV ADT	SC100.	SC93021703	NA	NA
26GHz ~ 40GHz Amplifier	EM26400	815221	Oct. 18, 2015	Oct. 17, 2016
High Speed Peak Power Meter	ML2495A	0824011	Jul. 09, 2015	Jul. 08, 2016
Power Sensor	MA2411B	0738171	Jul. 09, 2015	Jul. 08, 2016

- Note:
1. The calibration interval of the above test instruments is 12 months and the calibrations are traceable to NML/ROC and NIST/USA.
 2. The test was performed in HwaYa Chamber 4.
 3. The horn antenna and preamplifier (model: 8449B) are used only for the measurement of emission frequency above 1GHz if tested.
 4. The FCC Site Registration No. is 460141.
 5. The IC Site Registration No. is IC7450F-4.

4.1.3 Test Procedures

- a. The EUT was placed on the top of a rotating table 0.8 meters (for below 1GHz) / 1.5 meters (for above 1GHz) above the ground at 3 meter chamber room for test. The table was rotated 360 degrees to determine the position of the highest radiation.
- b. The EUT was set 3 meters away from the interference-receiving antenna, which was mounted on the top of a variable-height antenna tower.
- c. The height of antenna is varied from one meter to four meters above the ground to determine the maximum value of the field strength. Both horizontal and vertical polarizations of the antenna are set to make the measurement.
- d. For each suspected emission, the EUT was arranged to its worst case and then the antenna was tuned to heights from 1 meter to 4 meters and the rotatable table was turned from 0 degrees to 360 degrees to find the maximum reading.
- e. The test-receiver system was set to quasi-peak detect function and specified bandwidth with maximum hold mode when the test frequency is below 1 GHz.
- f. The test-receiver system was set to peak and average detect function and specified bandwidth with maximum hold mode when the test frequency is above 1 GHz. If the peak reading value also meets average limit, measurement with the average detector is unnecessary.

Note:

1. The resolution bandwidth and video bandwidth of test receiver/spectrum analyzer is 120kHz for Quasi-peak detection (QP) at frequency below 1GHz.
2. The resolution bandwidth of test receiver/spectrum analyzer is 1 MHz and the video bandwidth is 3 MHz for Peak detection (PK) at frequency above 1GHz.
3. The resolution bandwidth of test receiver/spectrum analyzer is 1MHz and the video bandwidth is 3MHz for RMS Average (Duty cycle < 98%) for Average detection (AV) at frequency above 1GHz, then the measurement results was added to a correction factor ($10 \log(1/\text{duty cycle})$).
4. The resolution bandwidth of test receiver/spectrum analyzer is 1MHz and the video bandwidth is 10Hz (Duty cycle $\geq 98\%$) for Average detection (AV) at frequency above 1GHz.
5. All modes of operation were investigated and the worst-case emissions are reported.

4.1.4 Deviation from Test Standard

No deviation.

4.1.5 Test Set Up

<Frequency Range below 1GHz>

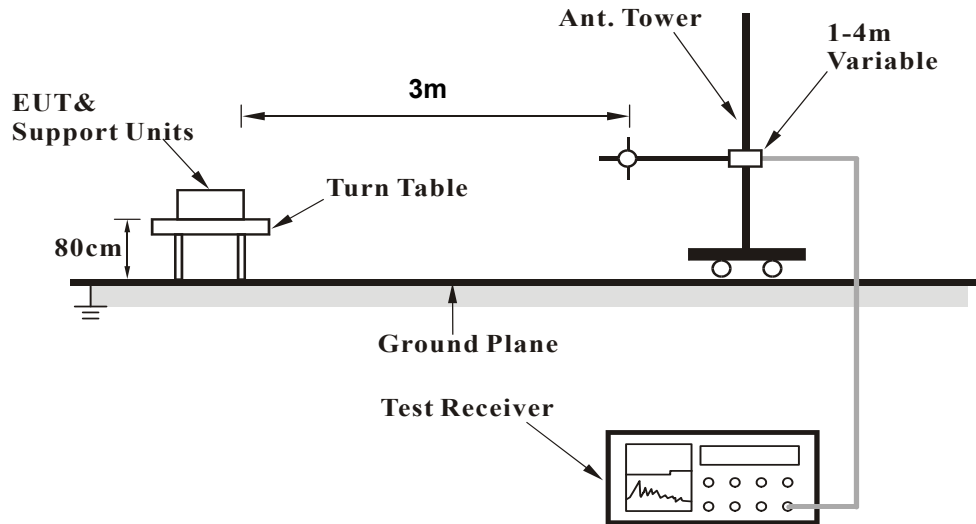

<Frequency Range above 1GHz>

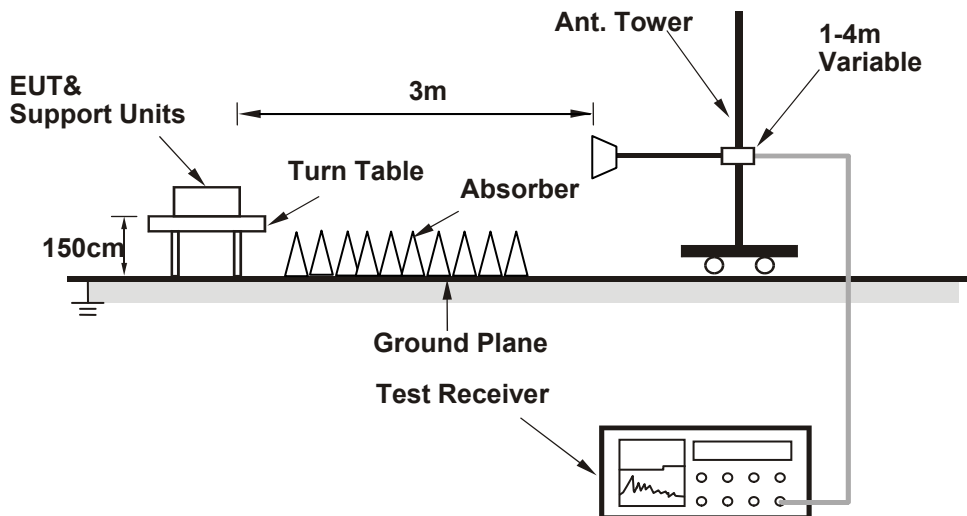

For the actual test configuration, please refer to the attached file (Test Setup Photo).

4.1.6 EUT Operating Conditions

- Placed the EUT on the testing table.
- Prepared notebook to act as communication partner and placed it outside of testing area.
- The communication partner connected with EUT via a RJ45 cable and ran a test program (provided by manufacturer) to enable EUT under transmission condition continuously at specific channel frequency.
- The communication partner sent data to EUT by command "PING".
- The necessary accessories enable the system in full functions.

4.1.7 Test Results

Above 1GHz data:

Test Mode B

1TX

802.11b

CHANNEL	TX Channel 1	DETECTOR FUNCTION	Peak (PK)
FREQUENCY RANGE	1GHz ~ 25GHz		Average (AV)

ANTENNA POLARITY & TEST DISTANCE: HORIZONTAL AT 3 M								
NO.	FREQ. (MHz)	EMISSION LEVEL (dBuV/m)	LIMIT (dBuV/m)	MARGIN (dB)	ANTENNA HEIGHT (m)	TABLE ANGLE (Degree)	RAW VALUE (dBuV)	CORRECTION FACTOR (dB/m)
1	2389.00	63.3 PK	74.0	-10.7	1.26 H	282	30.80	32.50
2	2389.00	52.4 AV	54.0	-1.6	1.26 H	282	19.90	32.50
3	*2412.00	112.6 PK			1.60 H	276	80.00	32.60
4	*2412.00	109.0 AV			1.60 H	276	76.40	32.60
5	4824.00	54.8 PK	74.0	-19.2	1.34 H	284	48.70	6.10
6	4824.00	51.9 AV	54.0	-2.1	1.34 H	284	45.80	6.10

ANTENNA POLARITY & TEST DISTANCE: VERTICAL AT 3 M								
NO.	FREQ. (MHz)	EMISSION LEVEL (dBuV/m)	LIMIT (dBuV/m)	MARGIN (dB)	ANTENNA HEIGHT (m)	TABLE ANGLE (Degree)	RAW VALUE (dBuV)	CORRECTION FACTOR (dB/m)
1	2390.00	57.9 PK	74.0	-16.1	1.19 V	341	25.40	32.50
2	2390.00	48.2 AV	54.0	-5.8	1.19 V	341	15.70	32.50
3	*2412.00	107.7 PK			1.19 V	341	75.10	32.60
4	*2412.00	104.2 AV			1.19 V	341	71.60	32.60
5	4824.00	53.2 PK	74.0	-20.8	1.54 V	0	47.10	6.10
6	4824.00	46.9 AV	54.0	-7.1	1.54 V	0	40.80	6.10

REMARKS:

1. Emission Level(dBuV/m) = Raw Value(dBuV) + Correction Factor(dB/m)
2. Correction Factor(dB/m) = Antenna Factor(dB/m) + Cable Factor(dB)
3. The other emission levels were very low against the limit.
4. Margin value = Emission Level – Limit value
5. " * ": Fundamental frequency.

CHANNEL	TX Channel 6	DETECTOR FUNCTION	Peak (PK)
FREQUENCY RANGE	1GHz ~ 25GHz		Average (AV)

ANTENNA POLARITY & TEST DISTANCE: HORIZONTAL AT 3 M

NO.	FREQ. (MHz)	EMISSION LEVEL (dBuV/m)	LIMIT (dBuV/m)	MARGIN (dB)	ANTENNA HEIGHT (m)	TABLE ANGLE (Degree)	RAW VALUE (dBuV)	CORRECTION FACTOR (dB/m)
1	*2437.00	111.9 PK			1.61 H	271	79.20	32.70
2	*2437.00	108.2 AV			1.61 H	271	75.50	32.70
3	4874.00	56.5 PK	74.0	-17.5	1.21 H	286	50.30	6.20
4	4874.00	52.2 AV	54.0	-1.8	1.21 H	286	46.00	6.20

ANTENNA POLARITY & TEST DISTANCE: VERTICAL AT 3 M

NO.	FREQ. (MHz)	EMISSION LEVEL (dBuV/m)	LIMIT (dBuV/m)	MARGIN (dB)	ANTENNA HEIGHT (m)	TABLE ANGLE (Degree)	RAW VALUE (dBuV)	CORRECTION FACTOR (dB/m)
1	*2437.00	106.9 PK			1.12 V	339	74.20	32.70
2	*2437.00	103.1 AV			1.12 V	339	70.40	32.70
3	4874.00	52.3 PK	74.0	-21.7	1.78 V	359	46.10	6.20
4	4874.00	45.7 AV	54.0	-8.3	1.78 V	359	39.50	6.20

REMARKS:

1. Emission Level(dBuV/m) = Raw Value(dBuV) + Correction Factor(dB/m)
2. Correction Factor(dB/m) = Antenna Factor(dB/m) + Cable Factor(dB)
3. The other emission levels were very low against the limit.
4. Margin value = Emission Level – Limit value
5. " * ": Fundamental frequency.

CHANNEL	TX Channel 11	DETECTOR FUNCTION	Peak (PK)
FREQUENCY RANGE	1GHz ~ 25GHz		Average (AV)

ANTENNA POLARITY & TEST DISTANCE: HORIZONTAL AT 3 M

NO.	FREQ. (MHz)	EMISSION LEVEL (dBuV/m)	LIMIT (dBuV/m)	MARGIN (dB)	ANTENNA HEIGHT (m)	TABLE ANGLE (Degree)	RAW VALUE (dBuV)	CORRECTION FACTOR (dB/m)
1	*2462.00	108.4 PK			1.60 H	277	75.80	32.60
2	*2462.00	105.1 AV			1.60 H	277	72.50	32.60
3	2483.50	62.7 PK	74.0	-11.3	1.19 H	280	30.00	32.70
4	2483.50	51.7 AV	54.0	-2.3	1.19 H	280	19.00	32.70
5	4924.00	59.8 PK	74.0	-14.2	1.16 H	289	53.50	6.30
6	4924.00	52.2 AV	54.0	-1.8	1.16 H	289	45.90	6.30

ANTENNA POLARITY & TEST DISTANCE: VERTICAL AT 3 M

NO.	FREQ. (MHz)	EMISSION LEVEL (dBuV/m)	LIMIT (dBuV/m)	MARGIN (dB)	ANTENNA HEIGHT (m)	TABLE ANGLE (Degree)	RAW VALUE (dBuV)	CORRECTION FACTOR (dB/m)
1	*2462.00	105.3 PK			1.23 V	344	72.70	32.60
2	*2462.00	102.0 AV			1.23 V	344	69.40	32.60
3	2483.50	57.5 PK	74.0	-16.5	1.23 V	344	24.80	32.70
4	2483.50	46.6 AV	54.0	-7.4	1.23 V	344	13.90	32.70
5	4924.00	51.6 PK	74.0	-22.4	1.54 V	356	45.30	6.30
6	4924.00	42.6 AV	54.0	-11.4	1.54 V	356	36.30	6.30

REMARKS:

1. Emission Level(dBuV/m) = Raw Value(dBuV) + Correction Factor(dB/m)
2. Correction Factor(dB/m) = Antenna Factor(dB/m) + Cable Factor(dB)
3. The other emission levels were very low against the limit.
4. Margin value = Emission Level – Limit value
5. " * " : Fundamental frequency.

802.11g

CHANNEL	TX Channel 1	DETECTOR FUNCTION	Peak (PK)
FREQUENCY RANGE	1GHz ~ 25GHz		Average (AV)

ANTENNA POLARITY & TEST DISTANCE: HORIZONTAL AT 3 M

NO.	FREQ. (MHz)	EMISSION LEVEL (dBuV/m)	LIMIT (dBuV/m)	MARGIN (dB)	ANTENNA HEIGHT (m)	TABLE ANGLE (Degree)	RAW VALUE (dBuV)	CORRECTION FACTOR (dB/m)
1	2390.00	71.6 PK	74.0	-2.4	1.61 H	271	39.10	32.50
2	2390.00	52.1 AV	54.0	-1.9	1.61 H	271	19.60	32.50
3	*2412.00	109.8 PK			1.59 H	278	77.20	32.60
4	*2412.00	99.8 AV			1.59 H	278	67.20	32.60
5	4824.00	49.1 PK	74.0	-24.9	1.39 H	250	43.00	6.10
6	4824.00	35.7 AV	54.0	-18.3	1.39 H	250	29.60	6.10

ANTENNA POLARITY & TEST DISTANCE: VERTICAL AT 3 M

NO.	FREQ. (MHz)	EMISSION LEVEL (dBuV/m)	LIMIT (dBuV/m)	MARGIN (dB)	ANTENNA HEIGHT (m)	TABLE ANGLE (Degree)	RAW VALUE (dBuV)	CORRECTION FACTOR (dB/m)
1	2390.00	64.1 PK	74.0	-9.9	1.25 V	329	31.60	32.50
2	2390.00	49.4 AV	54.0	-4.6	1.25 V	329	16.90	32.50
3	*2412.00	105.2 PK			1.15 V	336	72.60	32.60
4	*2412.00	95.8 AV			1.15 V	336	63.20	32.60
5	4824.00	48.1 PK	74.0	-25.9	1.57 V	357	42.00	6.10
6	4824.00	35.2 AV	54.0	-18.8	1.57 V	357	29.10	6.10

REMARKS:

1. Emission Level(dBuV/m) = Raw Value(dBuV) + Correction Factor(dB/m)
2. Correction Factor(dB/m) = Antenna Factor(dB/m) + Cable Factor(dB)
3. The other emission levels were very low against the limit.
4. Margin value = Emission Level – Limit value
5. " * ": Fundamental frequency.

CHANNEL	TX Channel 6	DETECTOR FUNCTION	Peak (PK)
FREQUENCY RANGE	1GHz ~ 25GHz		Average (AV)

ANTENNA POLARITY & TEST DISTANCE: HORIZONTAL AT 3 M

NO.	FREQ. (MHz)	EMISSION LEVEL (dBuV/m)	LIMIT (dBuV/m)	MARGIN (dB)	ANTENNA HEIGHT (m)	TABLE ANGLE (Degree)	RAW VALUE (dBuV)	CORRECTION FACTOR (dB/m)
1	2390.00	65.5 PK	74.0	-8.5	1.28 H	258	33.00	32.50
2	2390.00	52.1 AV	54.0	-1.9	1.28 H	258	19.60	32.50
3	*2437.00	116.0 PK			1.60 H	271	83.30	32.70
4	*2437.00	106.6 AV			1.60 H	271	73.90	32.70
5	4874.00	61.4 PK	74.0	-12.6	1.32 H	282	55.20	6.20
6	4874.00	47.1 AV	54.0	-6.9	1.32 H	282	40.90	6.20

ANTENNA POLARITY & TEST DISTANCE: VERTICAL AT 3 M

NO.	FREQ. (MHz)	EMISSION LEVEL (dBuV/m)	LIMIT (dBuV/m)	MARGIN (dB)	ANTENNA HEIGHT (m)	TABLE ANGLE (Degree)	RAW VALUE (dBuV)	CORRECTION FACTOR (dB/m)
1	2390.00	62.8 PK	74.0	-11.2	1.20 V	330	30.30	32.50
2	2390.00	46.6 AV	54.0	-7.4	1.20 V	330	14.10	32.50
3	*2437.00	110.5 PK			1.15 V	339	77.80	32.70
4	*2437.00	101.4 AV			1.15 V	339	68.70	32.70
5	4874.00	52.0 PK	74.0	-22.0	1.50 V	0	45.80	6.20
6	4874.00	39.5 AV	54.0	-14.5	1.50 V	0	33.30	6.20

REMARKS:

1. Emission Level(dBuV/m) = Raw Value(dBuV) + Correction Factor(dB/m)
2. Correction Factor(dB/m) = Antenna Factor(dB/m) + Cable Factor(dB)
3. The other emission levels were very low against the limit.
4. Margin value = Emission Level – Limit value
5. " * ": Fundamental frequency.

CHANNEL	TX Channel 11	DETECTOR FUNCTION	Peak (PK)
FREQUENCY RANGE	1GHz ~ 25GHz		Average (AV)

ANTENNA POLARITY & TEST DISTANCE: HORIZONTAL AT 3 M

NO.	FREQ. (MHz)	EMISSION LEVEL (dBuV/m)	LIMIT (dBuV/m)	MARGIN (dB)	ANTENNA HEIGHT (m)	TABLE ANGLE (Degree)	RAW VALUE (dBuV)	CORRECTION FACTOR (dB/m)
1	*2462.00	109.8 PK			1.59 H	271	77.20	32.60
2	*2462.00	99.7 AV			1.59 H	271	67.10	32.60
3	2483.50	70.4 PK	74.0	-3.6	1.59 H	278	37.70	32.70
4	2483.50	53.0 AV	54.0	-1.0	1.59 H	278	20.30	32.70
5	4924.00	53.9 PK	74.0	-20.1	1.13 H	282	47.60	6.30
6	4924.00	40.0 AV	54.0	-14.0	1.13 H	282	33.70	6.30

ANTENNA POLARITY & TEST DISTANCE: VERTICAL AT 3 M

NO.	FREQ. (MHz)	EMISSION LEVEL (dBuV/m)	LIMIT (dBuV/m)	MARGIN (dB)	ANTENNA HEIGHT (m)	TABLE ANGLE (Degree)	RAW VALUE (dBuV)	CORRECTION FACTOR (dB/m)
1	*2462.00	107.3 PK			1.05 V	340	74.70	32.60
2	*2462.00	97.8 AV			1.05 V	340	65.20	32.60
3	2483.50	66.7 PK	74.0	-7.3	1.23 V	333	34.00	32.70
4	2483.50	49.7 AV	54.0	-4.3	1.23 V	333	17.00	32.70
5	4924.00	49.5 PK	74.0	-24.5	1.60 V	359	43.20	6.30
6	4924.00	36.6 AV	54.0	-17.4	1.60 V	359	30.30	6.30

REMARKS:

1. Emission Level(dBuV/m) = Raw Value(dBuV) + Correction Factor(dB/m)
2. Correction Factor(dB/m) = Antenna Factor(dB/m) + Cable Factor(dB)
3. The other emission levels were very low against the limit.
4. Margin value = Emission Level – Limit value
5. " * " : Fundamental frequency.

802.11n (HT20)

CHANNEL	TX Channel 1	DETECTOR FUNCTION	Peak (PK)
FREQUENCY RANGE	1GHz ~ 25GHz		Average (AV)

ANTENNA POLARITY & TEST DISTANCE: HORIZONTAL AT 3 M								
NO.	FREQ. (MHz)	EMISSION LEVEL (dBuV/m)	LIMIT (dBuV/m)	MARGIN (dB)	ANTENNA HEIGHT (m)	TABLE ANGLE (Degree)	RAW VALUE (dBuV)	CORRECTION FACTOR (dB/m)
1	2390.00	73.0 PK	74.0	-1.0	1.00 H	265	40.50	32.50
2	2390.00	52.0 AV	54.0	-2.0	1.00 H	265	19.50	32.50
3	*2412.00	109.4 PK			1.62 H	280	76.80	32.60
4	*2412.00	99.4 AV			1.62 H	280	66.80	32.60
5	4824.00	48.5 PK	74.0	-25.5	1.35 H	259	42.40	6.10
6	4824.00	35.4 AV	54.0	-18.6	1.35 H	259	29.30	6.10

ANTENNA POLARITY & TEST DISTANCE: VERTICAL AT 3 M								
NO.	FREQ. (MHz)	EMISSION LEVEL (dBuV/m)	LIMIT (dBuV/m)	MARGIN (dB)	ANTENNA HEIGHT (m)	TABLE ANGLE (Degree)	RAW VALUE (dBuV)	CORRECTION FACTOR (dB/m)
1	2390.00	63.7 PK	74.0	-10.3	1.26 V	323	31.20	32.50
2	2390.00	49.1 AV	54.0	-4.9	1.26 V	323	16.60	32.50
3	*2412.00	103.8 PK			1.12 V	339	71.20	32.60
4	*2412.00	94.4 AV			1.12 V	339	61.80	32.60
5	4824.00	48.4 PK	74.0	-25.6	1.54 V	268	42.30	6.10
6	4824.00	35.4 AV	54.0	-18.6	1.54 V	268	29.30	6.10

REMARKS:

1. Emission Level(dBuV/m) = Raw Value(dBuV) + Correction Factor(dB/m)
2. Correction Factor(dB/m) = Antenna Factor(dB/m) + Cable Factor(dB)
3. The other emission levels were very low against the limit.
4. Margin value = Emission Level – Limit value
5. " * ": Fundamental frequency.

CHANNEL	TX Channel 6	DETECTOR FUNCTION	Peak (PK)
FREQUENCY RANGE	1GHz ~ 25GHz		Average (AV)

ANTENNA POLARITY & TEST DISTANCE: HORIZONTAL AT 3 M

NO.	FREQ. (MHz)	EMISSION LEVEL (dBuV/m)	LIMIT (dBuV/m)	MARGIN (dB)	ANTENNA HEIGHT (m)	TABLE ANGLE (Degree)	RAW VALUE (dBuV)	CORRECTION FACTOR (dB/m)
1	2390.00	64.8 PK	74.0	-9.2	1.20 H	252	32.30	32.50
2	2390.00	49.6 AV	54.0	-4.4	1.20 H	252	17.10	32.50
3	*2437.00	115.7 PK			1.59 H	279	83.00	32.70
4	*2437.00	106.4 AV			1.59 H	279	73.70	32.70
5	4874.00	57.5 PK	74.0	-16.5	1.38 H	288	51.30	6.20
6	4874.00	43.3 AV	54.0	-10.7	1.38 H	288	37.10	6.20

ANTENNA POLARITY & TEST DISTANCE: VERTICAL AT 3 M

NO.	FREQ. (MHz)	EMISSION LEVEL (dBuV/m)	LIMIT (dBuV/m)	MARGIN (dB)	ANTENNA HEIGHT (m)	TABLE ANGLE (Degree)	RAW VALUE (dBuV)	CORRECTION FACTOR (dB/m)
1	2390.00	62.4 PK	74.0	-11.6	1.25 V	324	29.90	32.50
2	2390.00	48.0 AV	54.0	-6.0	1.25 V	324	15.50	32.50
3	*2437.00	110.1 PK			1.11 V	339	77.40	32.70
4	*2437.00	101.2 AV			1.11 V	339	68.50	32.70
5	4874.00	51.5 PK	74.0	-22.5	1.55 V	0	45.30	6.20
6	4874.00	38.3 AV	54.0	-15.7	1.55 V	0	32.10	6.20

REMARKS:

1. Emission Level(dBuV/m) = Raw Value(dBuV) + Correction Factor(dB/m)
2. Correction Factor(dB/m) = Antenna Factor(dB/m) + Cable Factor(dB)
3. The other emission levels were very low against the limit.
4. Margin value = Emission Level – Limit value
5. " * ": Fundamental frequency.

CHANNEL	TX Channel 11	DETECTOR FUNCTION	Peak (PK)
FREQUENCY RANGE	1GHz ~ 25GHz		Average (AV)

ANTENNA POLARITY & TEST DISTANCE: HORIZONTAL AT 3 M

NO.	FREQ. (MHz)	EMISSION LEVEL (dBuV/m)	LIMIT (dBuV/m)	MARGIN (dB)	ANTENNA HEIGHT (m)	TABLE ANGLE (Degree)	RAW VALUE (dBuV)	CORRECTION FACTOR (dB/m)
1	*2462.00	109.2 PK			1.59 H	280	76.60	32.60
2	*2462.00	98.7 AV			1.59 H	280	66.10	32.60
3	2483.50	72.7 PK	74.0	-1.3	1.18 H	278	40.00	32.70
4	2483.50	52.4 AV	54.0	-1.6	1.18 H	278	19.70	32.70
5	4924.00	51.9 PK	74.0	-22.1	1.36 H	290	45.60	6.30
6	4924.00	38.2 AV	54.0	-15.8	1.36 H	290	31.90	6.30

ANTENNA POLARITY & TEST DISTANCE: VERTICAL AT 3 M

NO.	FREQ. (MHz)	EMISSION LEVEL (dBuV/m)	LIMIT (dBuV/m)	MARGIN (dB)	ANTENNA HEIGHT (m)	TABLE ANGLE (Degree)	RAW VALUE (dBuV)	CORRECTION FACTOR (dB/m)
1	*2462.00	104.2 PK			1.14 V	340	71.60	32.60
2	*2462.00	95.2 AV			1.14 V	340	62.60	32.60
3	2483.50	68.5 PK	74.0	-5.5	1.23 V	333	35.80	32.70
4	2483.50	49.8 AV	54.0	-4.2	1.23 V	333	17.10	32.70
5	4924.00	49.0 PK	74.0	-25.0	1.54 V	358	42.70	6.30
6	4924.00	36.1 AV	54.0	-17.9	1.54 V	358	29.80	6.30

REMARKS:

1. Emission Level(dBuV/m) = Raw Value(dBuV) + Correction Factor(dB/m)
2. Correction Factor(dB/m) = Antenna Factor(dB/m) + Cable Factor(dB)
3. The other emission levels were very low against the limit.
4. Margin value = Emission Level – Limit value
5. " * " : Fundamental frequency.

802.11n (HT40)

CHANNEL	TX Channel 3	DETECTOR FUNCTION	Peak (PK)
FREQUENCY RANGE	1GHz ~ 25GHz		Average (AV)

ANTENNA POLARITY & TEST DISTANCE: HORIZONTAL AT 3 M								
NO.	FREQ. (MHz)	EMISSION LEVEL (dBuV/m)	LIMIT (dBuV/m)	MARGIN (dB)	ANTENNA HEIGHT (m)	TABLE ANGLE (Degree)	RAW VALUE (dBuV)	CORRECTION FACTOR (dB/m)
1	2390.00	71.8 PK	74.0	-2.2	1.05 H	262	39.30	32.50
2	2390.00	52.9 AV	54.0	-1.1	1.05 H	262	20.40	32.50
3	*2422.00	105.9 PK			1.62 H	286	73.30	32.60
4	*2422.00	94.9 AV			1.62 H	286	62.30	32.60
5	4844.00	48.2 PK	74.0	-25.8	1.36 H	244	42.10	6.10
6	4844.00	35.3 AV	54.0	-18.7	1.36 H	244	29.20	6.10

ANTENNA POLARITY & TEST DISTANCE: VERTICAL AT 3 M								
NO.	FREQ. (MHz)	EMISSION LEVEL (dBuV/m)	LIMIT (dBuV/m)	MARGIN (dB)	ANTENNA HEIGHT (m)	TABLE ANGLE (Degree)	RAW VALUE (dBuV)	CORRECTION FACTOR (dB/m)
1	2390.00	65.4 PK	74.0	-8.6	1.24 V	320	32.90	32.50
2	2390.00	49.2 AV	54.0	-4.8	1.24 V	320	16.70	32.50
3	*2422.00	99.9 PK			1.15 V	326	67.30	32.60
4	*2422.00	89.9 AV			1.15 V	326	57.30	32.60
5	4844.00	47.5 PK	74.0	-26.5	1.49 V	1	41.40	6.10
6	4844.00	34.4 AV	54.0	-19.6	1.49 V	1	28.30	6.10

REMARKS:

1. Emission Level(dBuV/m) = Raw Value(dBuV) + Correction Factor(dB/m)
2. Correction Factor(dB/m) = Antenna Factor(dB/m) + Cable Factor(dB)
3. The other emission levels were very low against the limit.
4. Margin value = Emission Level – Limit value
5. " * ": Fundamental frequency.

CHANNEL	TX Channel 6	DETECTOR FUNCTION	Peak (PK)
FREQUENCY RANGE	1GHz ~ 25GHz		Average (AV)

ANTENNA POLARITY & TEST DISTANCE: HORIZONTAL AT 3 M

NO.	FREQ. (MHz)	EMISSION LEVEL (dBuV/m)	LIMIT (dBuV/m)	MARGIN (dB)	ANTENNA HEIGHT (m)	TABLE ANGLE (Degree)	RAW VALUE (dBuV)	CORRECTION FACTOR (dB/m)
1	2390.00	70.6 PK	74.0	-3.4	1.00 H	261	38.10	32.50
2	2390.00	52.8 AV	54.0	-1.2	1.00 H	261	20.30	32.50
3	*2437.00	107.0 PK			1.60 H	270	74.30	32.70
4	*2437.00	96.7 AV			1.60 H	270	64.00	32.70
5	2483.50	72.3 PK	74.0	-1.7	1.18 H	280	39.60	32.70
6	2483.50	51.2 AV	54.0	-2.8	1.18 H	280	18.50	32.70
7	4874.00	49.1 PK	74.0	-24.9	1.39 H	250	42.90	6.20
8	4874.00	35.9 AV	54.0	-18.1	1.39 H	250	29.70	6.20

ANTENNA POLARITY & TEST DISTANCE: VERTICAL AT 3 M

NO.	FREQ. (MHz)	EMISSION LEVEL (dBuV/m)	LIMIT (dBuV/m)	MARGIN (dB)	ANTENNA HEIGHT (m)	TABLE ANGLE (Degree)	RAW VALUE (dBuV)	CORRECTION FACTOR (dB/m)
1	*2437.00	102.0 PK			1.16 V	341	69.30	32.70
2	*2437.00	92.0 AV			1.16 V	341	59.30	32.70
3	2483.50	68.7 PK	74.0	-5.3	1.26 V	329	36.00	32.70
4	2483.50	50.5 AV	54.0	-3.5	1.26 V	329	17.80	32.70
5	4874.00	48.2 PK	74.0	-25.8	1.60 V	3	42.00	6.20
6	4874.00	35.1 AV	54.0	-18.9	1.60 V	3	28.90	6.20

REMARKS:

1. Emission Level(dBuV/m) = Raw Value(dBuV) + Correction Factor(dB/m)
2. Correction Factor(dB/m) = Antenna Factor(dB/m) + Cable Factor(dB)
3. The other emission levels were very low against the limit.
4. Margin value = Emission Level – Limit value
5. " * ": Fundamental frequency.

CHANNEL	TX Channel 9	DETECTOR FUNCTION	Peak (PK)
FREQUENCY RANGE	1GHz ~ 25GHz		Average (AV)

ANTENNA POLARITY & TEST DISTANCE: HORIZONTAL AT 3 M

NO.	FREQ. (MHz)	EMISSION LEVEL (dBuV/m)	LIMIT (dBuV/m)	MARGIN (dB)	ANTENNA HEIGHT (m)	TABLE ANGLE (Degree)	RAW VALUE (dBuV)	CORRECTION FACTOR (dB/m)
1	*2452.00	104.8 PK			1.61 H	277	72.10	32.70
2	*2452.00	95.1 AV			1.61 H	277	62.40	32.70
3	2483.50	72.5 PK	74.0	-1.5	1.15 H	291	39.80	32.70
4	2483.50	51.4 AV	54.0	-2.6	1.15 H	291	18.70	32.70
5	4904.00	48.2 PK	74.0	-25.8	1.31 H	257	42.10	6.10
6	4904.00	35.1 AV	54.0	-18.9	1.31 H	257	29.00	6.10

ANTENNA POLARITY & TEST DISTANCE: VERTICAL AT 3 M

NO.	FREQ. (MHz)	EMISSION LEVEL (dBuV/m)	LIMIT (dBuV/m)	MARGIN (dB)	ANTENNA HEIGHT (m)	TABLE ANGLE (Degree)	RAW VALUE (dBuV)	CORRECTION FACTOR (dB/m)
1	*2452.00	100.4 PK			1.14 V	336	67.70	32.70
2	*2452.00	90.6 AV			1.14 V	336	57.90	32.70
3	2483.50	66.8 PK	74.0	-7.2	1.25 V	326	34.10	32.70
4	2483.50	49.3 AV	54.0	-4.7	1.25 V	326	16.60	32.70
5	4904.00	47.7 PK	74.0	-26.3	1.55 V	359	41.60	6.10
6	4904.00	34.5 AV	54.0	-19.5	1.55 V	359	28.40	6.10

REMARKS:

1. Emission Level(dBuV/m) = Raw Value(dBuV) + Correction Factor(dB/m)
2. Correction Factor(dB/m) = Antenna Factor(dB/m) + Cable Factor(dB)
3. The other emission levels were very low against the limit.
4. Margin value = Emission Level – Limit value
5. " * " : Fundamental frequency.

Test Mode B
2TX
802.11b

CHANNEL	TX Channel 1	DETECTOR FUNCTION	Peak (PK)
FREQUENCY RANGE	1GHz ~ 25GHz		Average (AV)

ANTENNA POLARITY & TEST DISTANCE: HORIZONTAL AT 3 M

NO.	FREQ. (MHz)	EMISSION LEVEL (dBuV/m)	LIMIT (dBuV/m)	MARGIN (dB)	ANTENNA HEIGHT (m)	TABLE ANGLE (Degree)	RAW VALUE (dBuV)	CORRECTION FACTOR (dB/m)
1	2390.00	59.0 PK	74.0	-15.0	1.38 H	280	27.40	31.60
2	2390.00	50.9 AV	54.0	-3.1	1.38 H	280	19.30	31.60
3	*2412.00	111.1 PK			1.55 H	334	79.30	31.80
4	*2412.00	108.0 AV			1.55 H	334	76.20	31.80
5	4824.00	56.9 PK	74.0	-17.1	1.00 H	295	52.00	4.90
6	4824.00	53.8 AV	54.0	-0.2	1.00 H	295	48.90	4.90

ANTENNA POLARITY & TEST DISTANCE: VERTICAL AT 3 M

NO.	FREQ. (MHz)	EMISSION LEVEL (dBuV/m)	LIMIT (dBuV/m)	MARGIN (dB)	ANTENNA HEIGHT (m)	TABLE ANGLE (Degree)	RAW VALUE (dBuV)	CORRECTION FACTOR (dB/m)
1	2390.00	55.9 PK	74.0	-18.1	1.02 V	340	24.30	31.60
2	2390.00	48.5 AV	54.0	-5.5	1.02 V	340	16.90	31.60
3	*2412.00	108.6 PK			1.00 V	336	76.80	31.80
4	*2412.00	105.4 AV			1.00 V	336	73.60	31.80
5	4824.00	50.2 PK	74.0	-23.8	1.02 V	27	45.30	4.90
6	4824.00	42.8 AV	54.0	-11.2	1.02 V	27	37.90	4.90

REMARKS:

1. Emission Level(dBuV/m) = Raw Value(dBuV) + Correction Factor(dB/m)
2. Correction Factor(dB/m) = Antenna Factor(dB/m) + Cable Factor(dB)
3. The other emission levels were very low against the limit.
4. Margin value = Emission Level – Limit value
5. " * ": Fundamental frequency.

CHANNEL	TX Channel 6	DETECTOR FUNCTION	Peak (PK)
FREQUENCY RANGE	1GHz ~ 25GHz		Average (AV)

ANTENNA POLARITY & TEST DISTANCE: HORIZONTAL AT 3 M

NO.	FREQ. (MHz)	EMISSION LEVEL (dBuV/m)	LIMIT (dBuV/m)	MARGIN (dB)	ANTENNA HEIGHT (m)	TABLE ANGLE (Degree)	RAW VALUE (dBuV)	CORRECTION FACTOR (dB/m)
1	*2437.00	111.5 PK			1.27 H	279	79.60	31.90
2	*2437.00	107.7 AV			1.27 H	279	75.80	31.90
3	4874.00	56.8 PK	74.0	-17.2	1.04 H	295	51.80	5.00
4	4874.00	53.7 AV	54.0	-0.3	1.04 H	295	48.70	5.00

ANTENNA POLARITY & TEST DISTANCE: VERTICAL AT 3 M

NO.	FREQ. (MHz)	EMISSION LEVEL (dBuV/m)	LIMIT (dBuV/m)	MARGIN (dB)	ANTENNA HEIGHT (m)	TABLE ANGLE (Degree)	RAW VALUE (dBuV)	CORRECTION FACTOR (dB/m)
1	*2437.00	108.2 PK			1.00 V	331	76.30	31.90
2	*2437.00	104.7 AV			1.00 V	331	72.80	31.90
3	4874.00	50.2 PK	74.0	-23.8	1.13 V	26	45.20	5.00
4	4874.00	43.0 AV	54.0	-11.0	1.13 V	26	38.00	5.00

REMARKS:

1. Emission Level(dBuV/m) = Raw Value(dBuV) + Correction Factor(dB/m)
2. Correction Factor(dB/m) = Antenna Factor(dB/m) + Cable Factor(dB)
3. The other emission levels were very low against the limit.
4. Margin value = Emission Level – Limit value
5. " * ": Fundamental frequency.

CHANNEL	TX Channel 11	DETECTOR FUNCTION	Peak (PK)
FREQUENCY RANGE	1GHz ~ 25GHz		Average (AV)

ANTENNA POLARITY & TEST DISTANCE: HORIZONTAL AT 3 M

NO.	FREQ. (MHz)	EMISSION LEVEL (dBuV/m)	LIMIT (dBuV/m)	MARGIN (dB)	ANTENNA HEIGHT (m)	TABLE ANGLE (Degree)	RAW VALUE (dBuV)	CORRECTION FACTOR (dB/m)
1	*2462.00	112.1 PK			1.63 H	334	80.10	32.00
2	*2462.00	108.5 AV			1.63 H	334	76.50	32.00
3	2483.50	59.2 PK	74.0	-14.8	1.01 H	284	27.20	32.00
4	2483.50	50.5 AV	54.0	-3.5	1.01 H	284	18.50	32.00
5	4924.00	55.5 PK	74.0	-18.5	1.11 H	289	50.40	5.10
6	4924.00	53.5 AV	54.0	-0.5	1.11 H	289	48.40	5.10

ANTENNA POLARITY & TEST DISTANCE: VERTICAL AT 3 M

NO.	FREQ. (MHz)	EMISSION LEVEL (dBuV/m)	LIMIT (dBuV/m)	MARGIN (dB)	ANTENNA HEIGHT (m)	TABLE ANGLE (Degree)	RAW VALUE (dBuV)	CORRECTION FACTOR (dB/m)
1	*2462.00	108.8 PK			1.12 V	339	76.80	32.00
2	*2462.00	105.5 AV			1.12 V	339	73.50	32.00
3	2483.50	57.5 PK	74.0	-16.5	1.15 V	341	25.50	32.00
4	2483.50	48.9 AV	54.0	-5.1	1.15 V	341	16.90	32.00
5	4924.00	49.9 PK	74.0	-24.1	1.13 V	22	44.80	5.10
6	4924.00	43.3 AV	54.0	-10.7	1.13 V	22	38.20	5.10

REMARKS:

1. Emission Level(dBuV/m) = Raw Value(dBuV) + Correction Factor(dB/m)
2. Correction Factor(dB/m) = Antenna Factor(dB/m) + Cable Factor(dB)
3. The other emission levels were very low against the limit.
4. Margin value = Emission Level – Limit value
5. " * " : Fundamental frequency.

802.11g

CHANNEL	TX Channel 1	DETECTOR FUNCTION	Peak (PK)
FREQUENCY RANGE	1GHz ~ 25GHz		Average (AV)

ANTENNA POLARITY & TEST DISTANCE: HORIZONTAL AT 3 M

NO.	FREQ. (MHz)	EMISSION LEVEL (dBuV/m)	LIMIT (dBuV/m)	MARGIN (dB)	ANTENNA HEIGHT (m)	TABLE ANGLE (Degree)	RAW VALUE (dBuV)	CORRECTION FACTOR (dB/m)
1	2390.00	66.2 PK	74.0	-7.8	1.21 H	323	34.60	31.60
2	2390.00	53.1 AV	54.0	-0.9	1.21 H	323	21.50	31.60
3	*2412.00	111.2 PK			1.35 H	330	79.40	31.80
4	*2412.00	102.3 AV			1.35 H	330	70.50	31.80
5	4824.00	49.9 PK	74.0	-24.1	1.37 H	304	45.00	4.90
6	4824.00	38.4 AV	54.0	-15.6	1.37 H	304	33.50	4.90

ANTENNA POLARITY & TEST DISTANCE: VERTICAL AT 3 M

NO.	FREQ. (MHz)	EMISSION LEVEL (dBuV/m)	LIMIT (dBuV/m)	MARGIN (dB)	ANTENNA HEIGHT (m)	TABLE ANGLE (Degree)	RAW VALUE (dBuV)	CORRECTION FACTOR (dB/m)
1	2390.00	64.2 PK	74.0	-9.8	1.05 V	350	32.60	31.60
2	2390.00	49.6 AV	54.0	-4.4	1.05 V	350	18.00	31.60
3	*2412.00	107.3 PK			1.01 V	347	75.50	31.80
4	*2412.00	98.0 AV			1.01 V	347	66.20	31.80
5	4824.00	46.8 PK	74.0	-27.2	1.28 V	54	41.90	4.90
6	4824.00	35.3 AV	54.0	-18.7	1.28 V	54	30.40	4.90

REMARKS:

1. Emission Level(dBuV/m) = Raw Value(dBuV) + Correction Factor(dB/m)
2. Correction Factor(dB/m) = Antenna Factor(dB/m) + Cable Factor(dB)
3. The other emission levels were very low against the limit.
4. Margin value = Emission Level – Limit value
5. " * ": Fundamental frequency.

CHANNEL	TX Channel 6	DETECTOR FUNCTION	Peak (PK)
FREQUENCY RANGE	1GHz ~ 25GHz		Average (AV)

ANTENNA POLARITY & TEST DISTANCE: HORIZONTAL AT 3 M

NO.	FREQ. (MHz)	EMISSION LEVEL (dBuV/m)	LIMIT (dBuV/m)	MARGIN (dB)	ANTENNA HEIGHT (m)	TABLE ANGLE (Degree)	RAW VALUE (dBuV)	CORRECTION FACTOR (dB/m)
1	*2437.00	116.0 PK			1.29 H	286	84.10	31.90
2	*2437.00	106.2 AV			1.29 H	286	74.30	31.90
3	4874.00	58.4 PK	74.0	-15.6	1.17 H	303	53.40	5.00
4	4874.00	45.9 AV	54.0	-8.1	1.17 H	303	40.90	5.00

ANTENNA POLARITY & TEST DISTANCE: VERTICAL AT 3 M

NO.	FREQ. (MHz)	EMISSION LEVEL (dBuV/m)	LIMIT (dBuV/m)	MARGIN (dB)	ANTENNA HEIGHT (m)	TABLE ANGLE (Degree)	RAW VALUE (dBuV)	CORRECTION FACTOR (dB/m)
1	*2437.00	111.2 PK			1.00 V	355	79.30	31.90
2	*2437.00	102.5 AV			1.00 V	355	70.60	31.90
3	4874.00	52.1 PK	74.0	-21.9	2.36 V	349	47.10	5.00
4	4874.00	39.1 AV	54.0	-14.9	2.36 V	349	34.10	5.00

REMARKS:

1. Emission Level(dBuV/m) = Raw Value(dBuV) + Correction Factor(dB/m)
2. Correction Factor(dB/m) = Antenna Factor(dB/m) + Cable Factor(dB)
3. The other emission levels were very low against the limit.
4. Margin value = Emission Level – Limit value
5. " * ": Fundamental frequency.

CHANNEL	TX Channel 11	DETECTOR FUNCTION	Peak (PK)
FREQUENCY RANGE	1GHz ~ 25GHz		Average (AV)

ANTENNA POLARITY & TEST DISTANCE: HORIZONTAL AT 3 M

NO.	FREQ. (MHz)	EMISSION LEVEL (dBuV/m)	LIMIT (dBuV/m)	MARGIN (dB)	ANTENNA HEIGHT (m)	TABLE ANGLE (Degree)	RAW VALUE (dBuV)	CORRECTION FACTOR (dB/m)
1	*2462.00	111.6 PK			1.32 H	286	79.60	32.00
2	*2462.00	102.0 AV			1.32 H	286	70.00	32.00
3	2483.50	69.6 PK	74.0	-4.4	1.55 H	283	37.60	32.00
4	2483.50	53.2 AV	54.0	-0.8	1.55 H	283	21.20	32.00
5	4924.00	51.6 PK	74.0	-22.4	1.54 H	307	46.50	5.10
6	4924.00	40.0 AV	54.0	-14.0	1.54 H	307	34.90	5.10

ANTENNA POLARITY & TEST DISTANCE: VERTICAL AT 3 M

NO.	FREQ. (MHz)	EMISSION LEVEL (dBuV/m)	LIMIT (dBuV/m)	MARGIN (dB)	ANTENNA HEIGHT (m)	TABLE ANGLE (Degree)	RAW VALUE (dBuV)	CORRECTION FACTOR (dB/m)
1	*2462.00	107.4 PK			1.11 V	343	75.40	32.00
2	*2462.00	98.9 AV			1.11 V	343	66.90	32.00
3	2483.50	65.8 PK	74.0	-8.2	1.15 V	345	33.80	32.00
4	2483.50	50.7 AV	54.0	-3.3	1.15 V	345	18.70	32.00
5	4924.00	47.0 PK	74.0	-27.0	1.28 V	54	41.90	5.10
6	4924.00	36.0 AV	54.0	-18.0	1.28 V	54	30.90	5.10

REMARKS:

1. Emission Level(dBuV/m) = Raw Value(dBuV) + Correction Factor(dB/m)
2. Correction Factor(dB/m) = Antenna Factor(dB/m) + Cable Factor(dB)
3. The other emission levels were very low against the limit.
4. Margin value = Emission Level – Limit value
5. " * " : Fundamental frequency.

802.11n (HT20)

CHANNEL	TX Channel 1	DETECTOR FUNCTION	Peak (PK)
FREQUENCY RANGE	1GHz ~ 25GHz		Average (AV)

ANTENNA POLARITY & TEST DISTANCE: HORIZONTAL AT 3 M								
NO.	FREQ. (MHz)	EMISSION LEVEL (dBuV/m)	LIMIT (dBuV/m)	MARGIN (dB)	ANTENNA HEIGHT (m)	TABLE ANGLE (Degree)	RAW VALUE (dBuV)	CORRECTION FACTOR (dB/m)
1	2390.00	68.1 PK	74.0	-5.9	1.04 H	281	36.50	31.60
2	2390.00	52.5 AV	54.0	-1.5	1.04 H	281	20.90	31.60
3	*2412.00	111.3 PK			1.02 H	287	79.50	31.80
4	*2412.00	100.7 AV			1.02 H	287	68.90	31.80
5	4824.00	48.8 PK	74.0	-25.2	1.41 H	307	43.90	4.90
6	4824.00	35.7 AV	54.0	-18.3	1.41 H	307	30.80	4.90
ANTENNA POLARITY & TEST DISTANCE: VERTICAL AT 3 M								
NO.	FREQ. (MHz)	EMISSION LEVEL (dBuV/m)	LIMIT (dBuV/m)	MARGIN (dB)	ANTENNA HEIGHT (m)	TABLE ANGLE (Degree)	RAW VALUE (dBuV)	CORRECTION FACTOR (dB/m)
1	2390.00	67.5 PK	74.0	-6.5	1.00 V	22	35.90	31.60
2	2390.00	47.6 AV	54.0	-6.4	1.00 V	22	16.00	31.60
3	*2412.00	106.3 PK			1.00 V	23	74.50	31.80
4	*2412.00	96.2 AV			1.00 V	23	64.40	31.80
5	4824.00	47.9 PK	74.0	-26.1	1.00 V	6	43.00	4.90
6	4824.00	34.8 AV	54.0	-19.2	1.00 V	6	29.90	4.90

REMARKS:

1. Emission Level(dBuV/m) = Raw Value(dBuV) + Correction Factor(dB/m)
2. Correction Factor(dB/m) = Antenna Factor(dB/m) + Cable Factor(dB)
3. The other emission levels were very low against the limit.
4. Margin value = Emission Level – Limit value
5. " * ": Fundamental frequency.

CHANNEL	TX Channel 6	DETECTOR FUNCTION	Peak (PK)
FREQUENCY RANGE	1GHz ~ 25GHz		Average (AV)

ANTENNA POLARITY & TEST DISTANCE: HORIZONTAL AT 3 M

NO.	FREQ. (MHz)	EMISSION LEVEL (dBuV/m)	LIMIT (dBuV/m)	MARGIN (dB)	ANTENNA HEIGHT (m)	TABLE ANGLE (Degree)	RAW VALUE (dBuV)	CORRECTION FACTOR (dB/m)
1	2390.00	61.3 PK	74.0	-12.7	1.02 H	284	29.70	31.60
2	2390.00	46.8 AV	54.0	-7.2	1.02 H	284	15.20	31.60
3	*2437.00	115.8 PK			1.02 H	287	83.90	31.90
4	*2437.00	105.4 AV			1.02 H	287	73.50	31.90
5	4874.00	55.8 PK	74.0	-18.2	1.44 H	308	50.80	5.00
6	4874.00	44.4 AV	54.0	-9.6	1.44 H	308	39.40	5.00

ANTENNA POLARITY & TEST DISTANCE: VERTICAL AT 3 M

NO.	FREQ. (MHz)	EMISSION LEVEL (dBuV/m)	LIMIT (dBuV/m)	MARGIN (dB)	ANTENNA HEIGHT (m)	TABLE ANGLE (Degree)	RAW VALUE (dBuV)	CORRECTION FACTOR (dB/m)
1	2390.00	56.8 PK	74.0	-17.2	1.10 V	12	25.20	31.60
2	2390.00	43.6 AV	54.0	-10.4	1.10 V	12	12.00	31.60
3	*2437.00	110.2 PK			1.11 V	16	78.30	31.90
4	*2437.00	99.9 AV			1.11 V	16	68.00	31.90
5	4874.00	52.1 PK	74.0	-21.9	1.00 V	2	47.10	5.00
6	4874.00	38.8 AV	54.0	-15.2	1.00 V	2	33.80	5.00

REMARKS:

1. Emission Level(dBuV/m) = Raw Value(dBuV) + Correction Factor(dB/m)
2. Correction Factor(dB/m) = Antenna Factor(dB/m) + Cable Factor(dB)
3. The other emission levels were very low against the limit.
4. Margin value = Emission Level – Limit value
5. " * " : Fundamental frequency.

CHANNEL	TX Channel 11	DETECTOR FUNCTION	Peak (PK)
FREQUENCY RANGE	1GHz ~ 25GHz		Average (AV)

ANTENNA POLARITY & TEST DISTANCE: HORIZONTAL AT 3 M

NO.	FREQ. (MHz)	EMISSION LEVEL (dBuV/m)	LIMIT (dBuV/m)	MARGIN (dB)	ANTENNA HEIGHT (m)	TABLE ANGLE (Degree)	RAW VALUE (dBuV)	CORRECTION FACTOR (dB/m)
1	*2462.00	110.3 PK			1.00 H	284	78.30	32.00
2	*2462.00	100.5 AV			1.00 H	284	68.50	32.00
3	2483.50	70.9 PK	74.0	-3.1	1.32 H	334	38.90	32.00
4	2483.50	53.0 AV	54.0	-1.0	1.32 H	334	21.00	32.00
5	4924.00	52.3 PK	74.0	-21.7	1.40 H	309	47.20	5.10
6	4924.00	38.5 AV	54.0	-15.5	1.40 H	309	33.40	5.10

ANTENNA POLARITY & TEST DISTANCE: VERTICAL AT 3 M

NO.	FREQ. (MHz)	EMISSION LEVEL (dBuV/m)	LIMIT (dBuV/m)	MARGIN (dB)	ANTENNA HEIGHT (m)	TABLE ANGLE (Degree)	RAW VALUE (dBuV)	CORRECTION FACTOR (dB/m)
1	*2462.00	102.1 PK			1.00 V	47	70.10	32.00
2	*2462.00	92.2 AV			1.00 V	47	60.20	32.00
3	2483.50	69.5 PK	74.0	-4.5	1.00 V	44	37.50	32.00
4	2483.50	49.8 AV	54.0	-4.2	1.00 V	44	17.80	32.00
5	4924.00	49.1 PK	74.0	-24.9	1.00 V	5	44.00	5.10
6	4924.00	36.4 AV	54.0	-17.6	1.00 V	5	31.30	5.10

REMARKS:

1. Emission Level(dBuV/m) = Raw Value(dBuV) + Correction Factor(dB/m)
2. Correction Factor(dB/m) = Antenna Factor(dB/m) + Cable Factor(dB)
3. The other emission levels were very low against the limit.
4. Margin value = Emission Level – Limit value
5. " * " : Fundamental frequency.

802.11n (HT40)

CHANNEL	TX Channel 3	DETECTOR FUNCTION	Peak (PK)
FREQUENCY RANGE	1GHz ~ 25GHz		Average (AV)

ANTENNA POLARITY & TEST DISTANCE: HORIZONTAL AT 3 M								
NO.	FREQ. (MHz)	EMISSION LEVEL (dBuV/m)	LIMIT (dBuV/m)	MARGIN (dB)	ANTENNA HEIGHT (m)	TABLE ANGLE (Degree)	RAW VALUE (dBuV)	CORRECTION FACTOR (dB/m)
1	2390.00	69.1 PK	74.0	-4.9	1.65 H	288	37.50	31.60
2	2390.00	53.2 AV	54.0	-0.8	1.65 H	288	21.60	31.60
3	*2422.00	107.6 PK			1.63 H	285	75.80	31.80
4	*2422.00	97.0 AV			1.63 H	285	65.20	31.80
5	4844.00	48.4 PK	74.0	-25.6	1.44 H	306	43.50	4.90
6	4844.00	35.7 AV	54.0	-18.3	1.44 H	306	30.80	4.90
ANTENNA POLARITY & TEST DISTANCE: VERTICAL AT 3 M								
NO.	FREQ. (MHz)	EMISSION LEVEL (dBuV/m)	LIMIT (dBuV/m)	MARGIN (dB)	ANTENNA HEIGHT (m)	TABLE ANGLE (Degree)	RAW VALUE (dBuV)	CORRECTION FACTOR (dB/m)
1	2390.00	71.8 PK	74.0	-2.2	1.12 V	6	40.20	31.60
2	2390.00	50.5 AV	54.0	-3.5	1.12 V	6	18.90	31.60
3	*2422.00	101.7 PK			1.12 V	7	69.90	31.80
4	*2422.00	91.3 AV			1.12 V	7	59.50	31.80
5	4844.00	47.8 PK	74.0	-26.2	1.00 V	8	42.90	4.90
6	4844.00	34.8 AV	54.0	-19.2	1.00 V	8	29.90	4.90

REMARKS:

1. Emission Level(dBuV/m) = Raw Value(dBuV) + Correction Factor(dB/m)
2. Correction Factor(dB/m) = Antenna Factor(dB/m) + Cable Factor(dB)
3. The other emission levels were very low against the limit.
4. Margin value = Emission Level – Limit value
5. " * ": Fundamental frequency.

CHANNEL	TX Channel 6	DETECTOR FUNCTION	Peak (PK)
FREQUENCY RANGE	1GHz ~ 25GHz		Average (AV)

ANTENNA POLARITY & TEST DISTANCE: HORIZONTAL AT 3 M

NO.	FREQ. (MHz)	EMISSION LEVEL (dBuV/m)	LIMIT (dBuV/m)	MARGIN (dB)	ANTENNA HEIGHT (m)	TABLE ANGLE (Degree)	RAW VALUE (dBuV)	CORRECTION FACTOR (dB/m)
1	2390.00	65.0 PK	74.0	-9.0	1.05 H	289	33.40	31.60
2	2390.00	53.4 AV	54.0	-0.6	1.05 H	289	21.80	31.60
3	*2437.00	107.8 PK			1.04 H	292	75.90	31.90
4	*2437.00	96.5 AV			1.04 H	292	64.60	31.90
5	4874.00	49.4 PK	74.0	-24.6	1.41 H	307	44.40	5.00
6	4874.00	36.1 AV	54.0	-17.9	1.41 H	307	31.10	5.00

ANTENNA POLARITY & TEST DISTANCE: VERTICAL AT 3 M

NO.	FREQ. (MHz)	EMISSION LEVEL (dBuV/m)	LIMIT (dBuV/m)	MARGIN (dB)	ANTENNA HEIGHT (m)	TABLE ANGLE (Degree)	RAW VALUE (dBuV)	CORRECTION FACTOR (dB/m)
1	2390.00	65.3 PK	74.0	-8.7	1.00 V	11	33.70	31.60
2	2390.00	49.4 AV	54.0	-4.6	1.00 V	11	17.80	31.60
3	*2437.00	101.3 PK			1.00 V	15	69.40	31.90
4	*2437.00	90.0 AV			1.00 V	15	58.10	31.90
5	4874.00	48.3 PK	74.0	-25.7	1.00 V	1	43.30	5.00
6	4874.00	35.1 AV	54.0	-18.9	1.00 V	1	30.10	5.00

REMARKS:

1. Emission Level(dBuV/m) = Raw Value(dBuV) + Correction Factor(dB/m)
2. Correction Factor(dB/m) = Antenna Factor(dB/m) + Cable Factor(dB)
3. The other emission levels were very low against the limit.
4. Margin value = Emission Level – Limit value
5. " * ": Fundamental frequency.

CHANNEL	TX Channel 9	DETECTOR FUNCTION	Peak (PK)
FREQUENCY RANGE	1GHz ~ 25GHz		Average (AV)

ANTENNA POLARITY & TEST DISTANCE: HORIZONTAL AT 3 M

NO.	FREQ. (MHz)	EMISSION LEVEL (dBuV/m)	LIMIT (dBuV/m)	MARGIN (dB)	ANTENNA HEIGHT (m)	TABLE ANGLE (Degree)	RAW VALUE (dBuV)	CORRECTION FACTOR (dB/m)
1	*2452.00	107.3 PK			1.80 H	288	75.40	31.90
2	*2452.00	96.1 AV			1.80 H	288	64.20	31.90
3	2483.50	69.2 PK	74.0	-4.8	1.79 H	325	37.20	32.00
4	2483.50	53.6 AV	54.0	-0.4	1.79 H	325	21.60	32.00
5	4904.00	48.7 PK	74.0	-25.3	1.46 H	308	43.70	5.00
6	4904.00	35.3 AV	54.0	-18.7	1.46 H	308	30.30	5.00

ANTENNA POLARITY & TEST DISTANCE: VERTICAL AT 3 M

NO.	FREQ. (MHz)	EMISSION LEVEL (dBuV/m)	LIMIT (dBuV/m)	MARGIN (dB)	ANTENNA HEIGHT (m)	TABLE ANGLE (Degree)	RAW VALUE (dBuV)	CORRECTION FACTOR (dB/m)
1	*2452.00	101.7 PK			1.11 V	3	69.80	31.90
2	*2452.00	91.2 AV			1.11 V	3	59.30	31.90
3	2483.50	73.0 PK	74.0	-1.0	1.18 V	3	41.00	32.00
4	2483.50	52.4 AV	54.0	-1.6	1.18 V	3	20.40	32.00
5	4904.00	47.8 PK	74.0	-26.2	1.00 V	5	42.80	5.00
6	4904.00	34.3 AV	54.0	-19.7	1.00 V	5	29.30	5.00

REMARKS:

1. Emission Level(dBuV/m) = Raw Value(dBuV) + Correction Factor(dB/m)
2. Correction Factor(dB/m) = Antenna Factor(dB/m) + Cable Factor(dB)
3. The other emission levels were very low against the limit.
4. Margin value = Emission Level – Limit value
5. " * ": Fundamental frequency.

Test Mode B

3TX

802.11b

CHANNEL	TX Channel 1	DETECTOR FUNCTION	Peak (PK)
FREQUENCY RANGE	1GHz ~ 25GHz		Average (AV)

ANTENNA POLARITY & TEST DISTANCE: HORIZONTAL AT 3 M

NO.	FREQ. (MHz)	EMISSION LEVEL (dBuV/m)	LIMIT (dBuV/m)	MARGIN (dB)	ANTENNA HEIGHT (m)	TABLE ANGLE (Degree)	RAW VALUE (dBuV)	CORRECTION FACTOR (dB/m)
1	2390.00	56.5 PK	74.0	-17.5	1.33 H	278	24.90	31.60
2	2390.00	48.2 AV	54.0	-5.8	1.33 H	278	16.60	31.60
3	*2412.00	112.5 PK			1.07 H	65	80.70	31.80
4	*2412.00	109.2 AV			1.07 H	65	77.40	31.80
5	4824.00	56.4 PK	74.0	-17.6	1.09 H	297	51.50	4.90
6	4824.00	53.5 AV	54.0	-0.5	1.09 H	297	48.60	4.90

ANTENNA POLARITY & TEST DISTANCE: VERTICAL AT 3 M

NO.	FREQ. (MHz)	EMISSION LEVEL (dBuV/m)	LIMIT (dBuV/m)	MARGIN (dB)	ANTENNA HEIGHT (m)	TABLE ANGLE (Degree)	RAW VALUE (dBuV)	CORRECTION FACTOR (dB/m)
1	2390.00	55.9 PK	74.0	-18.1	1.02 V	335	24.30	31.60
2	2390.00	46.2 AV	54.0	-7.8	1.02 V	335	14.60	31.60
3	*2412.00	111.8 PK			1.00 V	335	80.00	31.80
4	*2412.00	107.8 AV			1.00 V	335	76.00	31.80
5	4824.00	51.8 PK	74.0	-22.2	1.02 V	313	46.90	4.90
6	4824.00	46.9 AV	54.0	-7.1	1.02 V	313	42.00	4.90

REMARKS:

1. Emission Level(dBuV/m) = Raw Value(dBuV) + Correction Factor(dB/m)
2. Correction Factor(dB/m) = Antenna Factor(dB/m) + Cable Factor(dB)
3. The other emission levels were very low against the limit.
4. Margin value = Emission Level – Limit value
5. " * ": Fundamental frequency.

CHANNEL	TX Channel 6	DETECTOR FUNCTION	Peak (PK)
FREQUENCY RANGE	1GHz ~ 25GHz		Average (AV)

ANTENNA POLARITY & TEST DISTANCE: HORIZONTAL AT 3 M

NO.	FREQ. (MHz)	EMISSION LEVEL (dBuV/m)	LIMIT (dBuV/m)	MARGIN (dB)	ANTENNA HEIGHT (m)	TABLE ANGLE (Degree)	RAW VALUE (dBuV)	CORRECTION FACTOR (dB/m)
1	*2437.00	112.2 PK			1.00 H	48	80.30	31.90
2	*2437.00	108.9 AV			1.00 H	48	77.00	31.90
3	4874.00	56.5 PK	74.0	-17.5	1.02 H	292	51.50	5.00
4	4874.00	53.1 AV	54.0	-0.9	1.02 H	292	48.10	5.00

ANTENNA POLARITY & TEST DISTANCE: VERTICAL AT 3 M

NO.	FREQ. (MHz)	EMISSION LEVEL (dBuV/m)	LIMIT (dBuV/m)	MARGIN (dB)	ANTENNA HEIGHT (m)	TABLE ANGLE (Degree)	RAW VALUE (dBuV)	CORRECTION FACTOR (dB/m)
1	*2437.00	111.2 PK			1.00 V	22	79.30	31.90
2	*2437.00	107.8 AV			1.00 V	22	75.90	31.90
3	4874.00	51.9 PK	74.0	-22.1	1.02 V	318	46.90	5.00
4	4874.00	47.0 AV	54.0	-7.0	1.02 V	318	42.00	5.00

REMARKS:

1. Emission Level(dBuV/m) = Raw Value(dBuV) + Correction Factor(dB/m)
2. Correction Factor(dB/m) = Antenna Factor(dB/m) + Cable Factor(dB)
3. The other emission levels were very low against the limit.
4. Margin value = Emission Level – Limit value
5. " * ": Fundamental frequency.

CHANNEL	TX Channel 11	DETECTOR FUNCTION	Peak (PK)
FREQUENCY RANGE	1GHz ~ 25GHz		Average (AV)

ANTENNA POLARITY & TEST DISTANCE: HORIZONTAL AT 3 M

NO.	FREQ. (MHz)	EMISSION LEVEL (dBuV/m)	LIMIT (dBuV/m)	MARGIN (dB)	ANTENNA HEIGHT (m)	TABLE ANGLE (Degree)	RAW VALUE (dBuV)	CORRECTION FACTOR (dB/m)
1	*2462.00	111.5 PK			1.04 H	283	79.50	32.00
2	*2462.00	108.2 AV			1.04 H	283	76.20	32.00
3	2483.50	57.0 PK	74.0	-17.0	1.10 H	290	25.00	32.00
4	2483.50	45.9 AV	54.0	-8.1	1.10 H	290	13.90	32.00
5	4924.00	56.9 PK	74.0	-17.1	2.18 H	67	51.80	5.10
6	4924.00	53.6 AV	54.0	-0.4	2.18 H	67	48.50	5.10

ANTENNA POLARITY & TEST DISTANCE: VERTICAL AT 3 M

NO.	FREQ. (MHz)	EMISSION LEVEL (dBuV/m)	LIMIT (dBuV/m)	MARGIN (dB)	ANTENNA HEIGHT (m)	TABLE ANGLE (Degree)	RAW VALUE (dBuV)	CORRECTION FACTOR (dB/m)
1	*2462.00	110.9 PK			1.01 V	338	78.90	32.00
2	*2462.00	107.4 AV			1.01 V	338	75.40	32.00
3	2483.50	56.9 PK	74.0	-17.1	1.05 V	340	24.90	32.00
4	2483.50	46.0 AV	54.0	-8.0	1.05 V	340	14.00	32.00
5	4924.00	52.2 PK	74.0	-21.8	1.35 V	14	47.10	5.10
6	4924.00	46.3 AV	54.0	-7.7	1.35 V	14	41.20	5.10

REMARKS:

1. Emission Level(dBuV/m) = Raw Value(dBuV) + Correction Factor(dB/m)
2. Correction Factor(dB/m) = Antenna Factor(dB/m) + Cable Factor(dB)
3. The other emission levels were very low against the limit.
4. Margin value = Emission Level – Limit value
5. " * " : Fundamental frequency.

802.11g

CHANNEL	TX Channel 1	DETECTOR FUNCTION	Peak (PK)
FREQUENCY RANGE	1GHz ~ 25GHz		Average (AV)

ANTENNA POLARITY & TEST DISTANCE: HORIZONTAL AT 3 M								
NO.	FREQ. (MHz)	EMISSION LEVEL (dBuV/m)	LIMIT (dBuV/m)	MARGIN (dB)	ANTENNA HEIGHT (m)	TABLE ANGLE (Degree)	RAW VALUE (dBuV)	CORRECTION FACTOR (dB/m)
1	2390.00	69.5 PK	74.0	-4.5	1.25 H	335	37.90	31.60
2	2390.00	53.1 AV	54.0	-0.9	1.25 H	335	21.50	31.60
3	*2412.00	113.1 PK			1.35 H	333	81.30	31.80
4	*2412.00	103.7 AV			1.35 H	333	71.90	31.80
5	4824.00	51.6 PK	74.0	-22.4	1.39 H	300	46.70	4.90
6	4824.00	38.8 AV	54.0	-15.2	1.39 H	300	33.90	4.90
ANTENNA POLARITY & TEST DISTANCE: VERTICAL AT 3 M								
NO.	FREQ. (MHz)	EMISSION LEVEL (dBuV/m)	LIMIT (dBuV/m)	MARGIN (dB)	ANTENNA HEIGHT (m)	TABLE ANGLE (Degree)	RAW VALUE (dBuV)	CORRECTION FACTOR (dB/m)
1	2390.00	65.2 PK	74.0	-8.8	1.02 V	334	33.60	31.60
2	2390.00	50.0 AV	54.0	-4.0	1.02 V	334	18.40	31.60
3	*2412.00	110.1 PK			1.00 V	333	78.30	31.80
4	*2412.00	101.8 AV			1.00 V	333	70.00	31.80
5	4824.00	46.4 PK	74.0	-27.6	1.52 V	69	41.50	4.90
6	4824.00	36.1 AV	54.0	-17.9	1.52 V	69	31.20	4.90

REMARKS:

1. Emission Level(dBuV/m) = Raw Value(dBuV) + Correction Factor(dB/m)
2. Correction Factor(dB/m) = Antenna Factor(dB/m) + Cable Factor(dB)
3. The other emission levels were very low against the limit.
4. Margin value = Emission Level – Limit value
5. " * ": Fundamental frequency.

CHANNEL	TX Channel 6	DETECTOR FUNCTION	Peak (PK)
FREQUENCY RANGE	1GHz ~ 25GHz		Average (AV)

ANTENNA POLARITY & TEST DISTANCE: HORIZONTAL AT 3 M

NO.	FREQ. (MHz)	EMISSION LEVEL (dBuV/m)	LIMIT (dBuV/m)	MARGIN (dB)	ANTENNA HEIGHT (m)	TABLE ANGLE (Degree)	RAW VALUE (dBuV)	CORRECTION FACTOR (dB/m)
1	*2437.00	117.5 PK			1.15 H	332	85.60	31.90
2	*2437.00	108.1 AV			1.15 H	332	76.20	31.90
3	4874.00	60.2 PK	74.0	-13.8	1.71 H	303	55.20	5.00
4	4874.00	47.9 AV	54.0	-6.1	1.71 H	303	42.90	5.00

ANTENNA POLARITY & TEST DISTANCE: VERTICAL AT 3 M

NO.	FREQ. (MHz)	EMISSION LEVEL (dBuV/m)	LIMIT (dBuV/m)	MARGIN (dB)	ANTENNA HEIGHT (m)	TABLE ANGLE (Degree)	RAW VALUE (dBuV)	CORRECTION FACTOR (dB/m)
1	*2437.00	116.0 PK			1.00 V	348	84.10	31.90
2	*2437.00	106.1 AV			1.00 V	348	74.20	31.90
3	4874.00	51.5 PK	74.0	-22.5	1.28 V	56	46.50	5.00
4	4874.00	39.1 AV	54.0	-14.9	1.28 V	56	34.10	5.00

REMARKS:

1. Emission Level(dBuV/m) = Raw Value(dBuV) + Correction Factor(dB/m)
2. Correction Factor(dB/m) = Antenna Factor(dB/m) + Cable Factor(dB)
3. The other emission levels were very low against the limit.
4. Margin value = Emission Level – Limit value
5. " * ": Fundamental frequency.

CHANNEL	TX Channel 11	DETECTOR FUNCTION	Peak (PK)
FREQUENCY RANGE	1GHz ~ 25GHz		Average (AV)

ANTENNA POLARITY & TEST DISTANCE: HORIZONTAL AT 3 M

NO.	FREQ. (MHz)	EMISSION LEVEL (dBuV/m)	LIMIT (dBuV/m)	MARGIN (dB)	ANTENNA HEIGHT (m)	TABLE ANGLE (Degree)	RAW VALUE (dBuV)	CORRECTION FACTOR (dB/m)
1	*2462.00	112.2 PK			1.00 H	327	80.20	32.00
2	*2462.00	102.5 AV			1.00 H	327	70.50	32.00
3	2483.50	70.0 PK	74.0	-4.0	1.00 H	283	38.00	32.00
4	2483.50	53.0 AV	54.0	-1.0	1.00 H	283	21.00	32.00
5	4924.00	49.1 PK	74.0	-24.9	1.25 H	87	44.00	5.10
6	4924.00	37.7 AV	54.0	-16.3	1.25 H	87	32.60	5.10

ANTENNA POLARITY & TEST DISTANCE: VERTICAL AT 3 M

NO.	FREQ. (MHz)	EMISSION LEVEL (dBuV/m)	LIMIT (dBuV/m)	MARGIN (dB)	ANTENNA HEIGHT (m)	TABLE ANGLE (Degree)	RAW VALUE (dBuV)	CORRECTION FACTOR (dB/m)
1	*2462.00	111.0 PK			1.09 V	348	79.00	32.00
2	*2462.00	102.6 AV			1.09 V	348	70.60	32.00
3	2483.50	70.1 PK	74.0	-3.9	1.10 V	351	38.10	32.00
4	2483.50	52.9 AV	54.0	-1.1	1.10 V	351	20.90	32.00
5	4924.00	47.0 PK	74.0	-27.0	1.48 V	74	41.90	5.10
6	4924.00	35.5 AV	54.0	-18.5	1.48 V	74	30.40	5.10

REMARKS:

1. Emission Level(dBuV/m) = Raw Value(dBuV) + Correction Factor(dB/m)
2. Correction Factor(dB/m) = Antenna Factor(dB/m) + Cable Factor(dB)
3. The other emission levels were very low against the limit.
4. Margin value = Emission Level – Limit value
5. " * ": Fundamental frequency.

802.11n (HT20)

CHANNEL	TX Channel 1	DETECTOR FUNCTION	Peak (PK)
FREQUENCY RANGE	1GHz ~ 25GHz		Average (AV)

ANTENNA POLARITY & TEST DISTANCE: HORIZONTAL AT 3 M								
NO.	FREQ. (MHz)	EMISSION LEVEL (dBuV/m)	LIMIT (dBuV/m)	MARGIN (dB)	ANTENNA HEIGHT (m)	TABLE ANGLE (Degree)	RAW VALUE (dBuV)	CORRECTION FACTOR (dB/m)
1	2390.00	69.1 PK	74.0	-4.9	1.50 H	31	37.50	31.60
2	2390.00	53.2 AV	54.0	-0.8	1.50 H	31	21.60	31.60
3	*2412.00	113.9 PK			1.00 H	74	82.10	31.80
4	*2412.00	103.7 AV			1.00 H	74	71.90	31.80
5	4824.00	49.2 PK	74.0	-24.8	1.94 H	74	44.30	4.90
6	4824.00	36.0 AV	54.0	-18.0	1.94 H	74	31.10	4.90
ANTENNA POLARITY & TEST DISTANCE: VERTICAL AT 3 M								
NO.	FREQ. (MHz)	EMISSION LEVEL (dBuV/m)	LIMIT (dBuV/m)	MARGIN (dB)	ANTENNA HEIGHT (m)	TABLE ANGLE (Degree)	RAW VALUE (dBuV)	CORRECTION FACTOR (dB/m)
1	2390.00	66.8 PK	74.0	-7.2	1.00 V	1	35.20	31.60
2	2390.00	50.7 AV	54.0	-3.3	1.00 V	1	19.10	31.60
3	*2412.00	111.2 PK			1.00 V	6	79.40	31.80
4	*2412.00	100.1 AV			1.00 V	6	68.30	31.80
5	4824.00	48.3 PK	74.0	-25.7	1.00 V	11	43.40	4.90
6	4824.00	35.1 AV	54.0	-18.9	1.00 V	11	30.20	4.90

REMARKS:

1. Emission Level(dBuV/m) = Raw Value(dBuV) + Correction Factor(dB/m)
2. Correction Factor(dB/m) = Antenna Factor(dB/m) + Cable Factor(dB)
3. The other emission levels were very low against the limit.
4. Margin value = Emission Level – Limit value
5. " * ": Fundamental frequency.

CHANNEL	TX Channel 6	DETECTOR FUNCTION	Peak (PK)
FREQUENCY RANGE	1GHz ~ 25GHz		Average (AV)

ANTENNA POLARITY & TEST DISTANCE: HORIZONTAL AT 3 M

NO.	FREQ. (MHz)	EMISSION LEVEL (dBuV/m)	LIMIT (dBuV/m)	MARGIN (dB)	ANTENNA HEIGHT (m)	TABLE ANGLE (Degree)	RAW VALUE (dBuV)	CORRECTION FACTOR (dB/m)
1	2390.00	64.2 PK	74.0	-9.8	1.00 H	69	32.60	31.60
2	2390.00	48.0 AV	54.0	-6.0	1.00 H	69	16.40	31.60
3	*2437.00	117.5 PK			1.00 H	62	85.60	31.90
4	*2437.00	106.9 AV			1.00 H	62	75.00	31.90
5	4874.00	60.3 PK	74.0	-13.7	1.90 H	71	55.30	5.00
6	4874.00	46.4 AV	54.0	-7.6	1.90 H	71	41.40	5.00

ANTENNA POLARITY & TEST DISTANCE: VERTICAL AT 3 M

NO.	FREQ. (MHz)	EMISSION LEVEL (dBuV/m)	LIMIT (dBuV/m)	MARGIN (dB)	ANTENNA HEIGHT (m)	TABLE ANGLE (Degree)	RAW VALUE (dBuV)	CORRECTION FACTOR (dB/m)
1	2390.00	61.5 PK	74.0	-12.5	1.00 V	8	29.90	31.60
2	2390.00	46.9 AV	54.0	-7.1	1.00 V	8	15.30	31.60
3	*2437.00	116.4 PK			1.00 V	359	84.50	31.90
4	*2437.00	105.5 AV			1.00 V	359	73.60	31.90
5	4874.00	51.4 PK	74.0	-22.6	1.00 V	37	46.40	5.00
6	4874.00	38.7 AV	54.0	-15.3	1.00 V	37	33.70	5.00

REMARKS:

1. Emission Level(dBuV/m) = Raw Value(dBuV) + Correction Factor(dB/m)
2. Correction Factor(dB/m) = Antenna Factor(dB/m) + Cable Factor(dB)
3. The other emission levels were very low against the limit.
4. Margin value = Emission Level – Limit value
5. " * ": Fundamental frequency.

CHANNEL	TX Channel 11	DETECTOR FUNCTION	Peak (PK)
FREQUENCY RANGE	1GHz ~ 25GHz		Average (AV)

ANTENNA POLARITY & TEST DISTANCE: HORIZONTAL AT 3 M

NO.	FREQ. (MHz)	EMISSION LEVEL (dBuV/m)	LIMIT (dBuV/m)	MARGIN (dB)	ANTENNA HEIGHT (m)	TABLE ANGLE (Degree)	RAW VALUE (dBuV)	CORRECTION FACTOR (dB/m)
1	*2462.00	113.2 PK			1.28 H	75	81.20	32.00
2	*2462.00	102.5 AV			1.28 H	75	70.50	32.00
3	2483.50	72.2 PK	74.0	-1.8	1.24 H	79	40.20	32.00
4	2483.50	53.6 AV	54.0	-0.4	1.24 H	79	21.60	32.00
5	4924.00	52.5 PK	74.0	-21.5	1.92 H	70	47.40	5.10
6	4924.00	39.0 AV	54.0	-15.0	1.92 H	70	33.90	5.10

ANTENNA POLARITY & TEST DISTANCE: VERTICAL AT 3 M

NO.	FREQ. (MHz)	EMISSION LEVEL (dBuV/m)	LIMIT (dBuV/m)	MARGIN (dB)	ANTENNA HEIGHT (m)	TABLE ANGLE (Degree)	RAW VALUE (dBuV)	CORRECTION FACTOR (dB/m)
1	*2462.00	110.4 PK			1.00 V	4	78.40	32.00
2	*2462.00	99.2 AV			1.00 V	4	67.20	32.00
3	2483.50	68.6 PK	74.0	-5.4	1.00 V	10	36.60	32.00
4	2483.50	50.2 AV	54.0	-3.8	1.00 V	10	18.20	32.00
5	4924.00	49.4 PK	74.0	-24.6	1.00 V	8	44.30	5.10
6	4924.00	36.9 AV	54.0	-17.1	1.00 V	8	31.80	5.10

REMARKS:

1. Emission Level(dBuV/m) = Raw Value(dBuV) + Correction Factor(dB/m)
2. Correction Factor(dB/m) = Antenna Factor(dB/m) + Cable Factor(dB)
3. The other emission levels were very low against the limit.
4. Margin value = Emission Level – Limit value
5. " * ": Fundamental frequency.

802.11n (HT40)

CHANNEL	TX Channel 3	DETECTOR FUNCTION	Peak (PK)
FREQUENCY RANGE	1GHz ~ 25GHz		Average (AV)

ANTENNA POLARITY & TEST DISTANCE: HORIZONTAL AT 3 M								
NO.	FREQ. (MHz)	EMISSION LEVEL (dBuV/m)	LIMIT (dBuV/m)	MARGIN (dB)	ANTENNA HEIGHT (m)	TABLE ANGLE (Degree)	RAW VALUE (dBuV)	CORRECTION FACTOR (dB/m)
1	2390.00	70.4 PK	74.0	-3.6	1.00 H	51	38.80	31.60
2	2390.00	53.2 AV	54.0	-0.8	1.00 H	51	21.60	31.60
3	*2422.00	107.7 PK			1.00 H	59	75.90	31.80
4	*2422.00	97.4 AV			1.00 H	59	65.60	31.80
5	4844.00	48.6 PK	74.0	-25.4	1.91 H	77	43.70	4.90
6	4844.00	36.0 AV	54.0	-18.0	1.91 H	77	31.10	4.90
ANTENNA POLARITY & TEST DISTANCE: VERTICAL AT 3 M								
NO.	FREQ. (MHz)	EMISSION LEVEL (dBuV/m)	LIMIT (dBuV/m)	MARGIN (dB)	ANTENNA HEIGHT (m)	TABLE ANGLE (Degree)	RAW VALUE (dBuV)	CORRECTION FACTOR (dB/m)
1	2390.00	69.7 PK	74.0	-4.3	1.00 V	10	38.10	31.60
2	2390.00	51.6 AV	54.0	-2.4	1.00 V	10	20.00	31.60
3	*2422.00	106.6 PK			1.00 V	13	74.80	31.80
4	*2422.00	96.0 AV			1.00 V	13	64.20	31.80
5	4844.00	48.2 PK	74.0	-25.8	1.00 V	9	43.30	4.90
6	4844.00	35.2 AV	54.0	-18.8	1.00 V	9	30.30	4.90

REMARKS:

1. Emission Level(dBuV/m) = Raw Value(dBuV) + Correction Factor(dB/m)
2. Correction Factor(dB/m) = Antenna Factor(dB/m) + Cable Factor(dB)
3. The other emission levels were very low against the limit.
4. Margin value = Emission Level – Limit value
5. " * ": Fundamental frequency.

CHANNEL	TX Channel 6	DETECTOR FUNCTION	Peak (PK)
FREQUENCY RANGE	1GHz ~ 25GHz		Average (AV)

ANTENNA POLARITY & TEST DISTANCE: HORIZONTAL AT 3 M

NO.	FREQ. (MHz)	EMISSION LEVEL (dBuV/m)	LIMIT (dBuV/m)	MARGIN (dB)	ANTENNA HEIGHT (m)	TABLE ANGLE (Degree)	RAW VALUE (dBuV)	CORRECTION FACTOR (dB/m)
1	2390.00	66.8 PK	74.0	-7.2	1.00 H	55	35.20	31.60
2	2390.00	53.6 AV	54.0	-0.4	1.00 H	55	22.00	31.60
3	*2437.00	109.0 PK			1.00 H	60	77.10	31.90
4	*2437.00	98.1 AV			1.00 H	60	66.20	31.90
5	4874.00	49.8 PK	74.0	-24.2	1.94 H	74	44.80	5.00
6	4874.00	36.3 AV	54.0	-17.7	1.94 H	74	31.30	5.00

ANTENNA POLARITY & TEST DISTANCE: VERTICAL AT 3 M

NO.	FREQ. (MHz)	EMISSION LEVEL (dBuV/m)	LIMIT (dBuV/m)	MARGIN (dB)	ANTENNA HEIGHT (m)	TABLE ANGLE (Degree)	RAW VALUE (dBuV)	CORRECTION FACTOR (dB/m)
1	2390.00	64.1 PK	74.0	-9.9	1.00 V	13	32.50	31.60
2	2390.00	48.4 AV	54.0	-5.6	1.00 V	13	16.80	31.60
3	*2437.00	108.2 PK			1.00 V	15	76.30	31.90
4	*2437.00	97.4 AV			1.00 V	15	65.50	31.90
5	4874.00	48.5 PK	74.0	-25.5	1.00 V	5	43.50	5.00
6	4874.00	35.9 AV	54.0	-18.1	1.00 V	5	30.90	5.00

REMARKS:

1. Emission Level(dBuV/m) = Raw Value(dBuV) + Correction Factor(dB/m)
2. Correction Factor(dB/m) = Antenna Factor(dB/m) + Cable Factor(dB)
3. The other emission levels were very low against the limit.
4. Margin value = Emission Level – Limit value
5. " * ": Fundamental frequency.

CHANNEL	TX Channel 9	DETECTOR FUNCTION	Peak (PK)
FREQUENCY RANGE	1GHz ~ 25GHz		Average (AV)

ANTENNA POLARITY & TEST DISTANCE: HORIZONTAL AT 3 M

NO.	FREQ. (MHz)	EMISSION LEVEL (dBuV/m)	LIMIT (dBuV/m)	MARGIN (dB)	ANTENNA HEIGHT (m)	TABLE ANGLE (Degree)	RAW VALUE (dBuV)	CORRECTION FACTOR (dB/m)
1	*2452.00	107.4 PK			1.00 H	82	75.50	31.90
2	*2452.00	97.2 AV			1.00 H	82	65.30	31.90
3	2483.50	72.5 PK	74.0	-1.5	1.39 H	82	40.50	32.00
4	2483.50	53.9 AV	54.0	-0.1	1.39 H	82	21.90	32.00
5	4904.00	48.9 PK	74.0	-25.1	1.99 H	79	43.90	5.00
6	4904.00	35.5 AV	54.0	-18.5	1.99 H	79	30.50	5.00

ANTENNA POLARITY & TEST DISTANCE: VERTICAL AT 3 M

NO.	FREQ. (MHz)	EMISSION LEVEL (dBuV/m)	LIMIT (dBuV/m)	MARGIN (dB)	ANTENNA HEIGHT (m)	TABLE ANGLE (Degree)	RAW VALUE (dBuV)	CORRECTION FACTOR (dB/m)
1	*2452.00	106.3 PK			1.00 V	1	74.40	31.90
2	*2452.00	95.6 AV			1.00 V	1	63.70	31.90
3	2483.50	70.6 PK	74.0	-3.4	1.00 V	2	38.60	32.00
4	2483.50	52.3 AV	54.0	-1.7	1.00 V	2	20.30	32.00
5	4904.00	47.9 PK	74.0	-26.1	1.00 V	7	42.90	5.00
6	4904.00	35.0 AV	54.0	-19.0	1.00 V	7	30.00	5.00

REMARKS:

1. Emission Level(dBuV/m) = Raw Value(dBuV) + Correction Factor(dB/m)
2. Correction Factor(dB/m) = Antenna Factor(dB/m) + Cable Factor(dB)
3. The other emission levels were very low against the limit.
4. Margin value = Emission Level – Limit value
5. " * ": Fundamental frequency.

Test Mode B
4TX
802.11b

CHANNEL	TX Channel 1	DETECTOR FUNCTION	Peak (PK)
FREQUENCY RANGE	1GHz ~ 25GHz		Average (AV)

ANTENNA POLARITY & TEST DISTANCE: HORIZONTAL AT 3 M

NO.	FREQ. (MHz)	EMISSION LEVEL (dBuV/m)	LIMIT (dBuV/m)	MARGIN (dB)	ANTENNA HEIGHT (m)	TABLE ANGLE (Degree)	RAW VALUE (dBuV)	CORRECTION FACTOR (dB/m)
1	2390.00	58.3 PK	74.0	-15.7	1.15 H	290	26.70	31.60
2	2390.00	48.5 AV	54.0	-5.5	1.15 H	290	16.90	31.60
3	*2412.00	116.4 PK			1.14 H	283	84.60	31.80
4	*2412.00	112.5 AV			1.14 H	283	80.70	31.80
5	4824.00	57.0 PK	74.0	-17.0	3.43 H	294	52.10	4.90
6	4824.00	53.7 AV	54.0	-0.3	3.43 H	294	48.80	4.90

ANTENNA POLARITY & TEST DISTANCE: VERTICAL AT 3 M

NO.	FREQ. (MHz)	EMISSION LEVEL (dBuV/m)	LIMIT (dBuV/m)	MARGIN (dB)	ANTENNA HEIGHT (m)	TABLE ANGLE (Degree)	RAW VALUE (dBuV)	CORRECTION FACTOR (dB/m)
1	2390.00	54.8 PK	74.0	-19.2	1.02 V	340	23.20	31.60
2	2390.00	44.6 AV	54.0	-9.4	1.02 V	340	13.00	31.60
3	*2412.00	110.4 PK			1.00 V	337	78.60	31.80
4	*2412.00	107.0 AV			1.00 V	337	75.20	31.80
5	4824.00	49.9 PK	74.0	-24.1	1.58 V	14	45.00	4.90
6	4824.00	43.1 AV	54.0	-10.9	1.58 V	14	38.20	4.90

REMARKS:

1. Emission Level(dBuV/m) = Raw Value(dBuV) + Correction Factor(dB/m)
2. Correction Factor(dB/m) = Antenna Factor(dB/m) + Cable Factor(dB)
3. The other emission levels were very low against the limit.
4. Margin value = Emission Level – Limit value
5. " * ": Fundamental frequency.

CHANNEL	TX Channel 6	DETECTOR FUNCTION	Peak (PK)
FREQUENCY RANGE	1GHz ~ 25GHz		Average (AV)

ANTENNA POLARITY & TEST DISTANCE: HORIZONTAL AT 3 M

NO.	FREQ. (MHz)	EMISSION LEVEL (dBuV/m)	LIMIT (dBuV/m)	MARGIN (dB)	ANTENNA HEIGHT (m)	TABLE ANGLE (Degree)	RAW VALUE (dBuV)	CORRECTION FACTOR (dB/m)
1	*2437.00	115.3 PK			1.29 H	281	83.40	31.90
2	*2437.00	112.0 AV			1.29 H	281	80.10	31.90
3	4874.00	56.2 PK	74.0	-17.8	1.81 H	58	51.20	5.00
4	4874.00	53.0 AV	54.0	-1.0	1.81 H	58	48.00	5.00

ANTENNA POLARITY & TEST DISTANCE: VERTICAL AT 3 M

NO.	FREQ. (MHz)	EMISSION LEVEL (dBuV/m)	LIMIT (dBuV/m)	MARGIN (dB)	ANTENNA HEIGHT (m)	TABLE ANGLE (Degree)	RAW VALUE (dBuV)	CORRECTION FACTOR (dB/m)
1	*2437.00	110.1 PK			1.02 V	334	78.20	31.90
2	*2437.00	106.6 AV			1.02 V	334	74.70	31.90
3	4874.00	51.8 PK	74.0	-22.2	1.28 V	333	46.80	5.00
4	4874.00	46.9 AV	54.0	-7.1	1.28 V	333	41.90	5.00

REMARKS:

1. Emission Level(dBuV/m) = Raw Value(dBuV) + Correction Factor(dB/m)
2. Correction Factor(dB/m) = Antenna Factor(dB/m) + Cable Factor(dB)
3. The other emission levels were very low against the limit.
4. Margin value = Emission Level – Limit value
5. " * ": Fundamental frequency.

CHANNEL	TX Channel 11	DETECTOR FUNCTION	Peak (PK)
FREQUENCY RANGE	1GHz ~ 25GHz		Average (AV)

ANTENNA POLARITY & TEST DISTANCE: HORIZONTAL AT 3 M

NO.	FREQ. (MHz)	EMISSION LEVEL (dBuV/m)	LIMIT (dBuV/m)	MARGIN (dB)	ANTENNA HEIGHT (m)	TABLE ANGLE (Degree)	RAW VALUE (dBuV)	CORRECTION FACTOR (dB/m)
1	*2462.00	114.9 PK			1.03 H	286	82.90	32.00
2	*2462.00	111.9 AV			1.03 H	286	79.90	32.00
3	2483.50	57.3 PK	74.0	-16.7	1.05 H	290	25.30	32.00
4	2483.50	46.9 AV	54.0	-7.1	1.05 H	290	14.90	32.00
5	4924.00	56.3 PK	74.0	-17.7	2.05 H	55	51.20	5.10
6	4924.00	53.3 AV	54.0	-0.7	2.05 H	55	48.20	5.10

ANTENNA POLARITY & TEST DISTANCE: VERTICAL AT 3 M

NO.	FREQ. (MHz)	EMISSION LEVEL (dBuV/m)	LIMIT (dBuV/m)	MARGIN (dB)	ANTENNA HEIGHT (m)	TABLE ANGLE (Degree)	RAW VALUE (dBuV)	CORRECTION FACTOR (dB/m)
1	*2462.00	110.4 PK			1.00 V	330	78.40	32.00
2	*2462.00	106.9 AV			1.00 V	330	74.90	32.00
3	2483.50	56.4 PK	74.0	-17.6	1.05 V	310	24.40	32.00
4	2483.50	46.0 AV	54.0	-8.0	1.05 V	310	14.00	32.00
5	4924.00	51.6 PK	74.0	-22.4	1.05 V	325	46.50	5.10
6	4924.00	46.7 AV	54.0	-7.3	1.05 V	325	41.60	5.10

REMARKS:

1. Emission Level(dBuV/m) = Raw Value(dBuV) + Correction Factor(dB/m)
2. Correction Factor(dB/m) = Antenna Factor(dB/m) + Cable Factor(dB)
3. The other emission levels were very low against the limit.
4. Margin value = Emission Level – Limit value
5. " * ": Fundamental frequency.

802.11g

CHANNEL	TX Channel 1	DETECTOR FUNCTION	Peak (PK)
FREQUENCY RANGE	1GHz ~ 25GHz		Average (AV)

ANTENNA POLARITY & TEST DISTANCE: HORIZONTAL AT 3 M

NO.	FREQ. (MHz)	EMISSION LEVEL (dBuV/m)	LIMIT (dBuV/m)	MARGIN (dB)	ANTENNA HEIGHT (m)	TABLE ANGLE (Degree)	RAW VALUE (dBuV)	CORRECTION FACTOR (dB/m)
1	2390.00	73.0 PK	74.0	-1.0	1.57 H	335	41.40	31.60
2	2390.00	53.6 AV	54.0	-0.4	1.57 H	335	22.00	31.60
3	*2412.00	115.6 PK			1.60 H	333	83.80	31.80
4	*2412.00	106.1 AV			1.60 H	333	74.30	31.80
5	4824.00	50.1 PK	74.0	-23.9	1.62 H	302	45.20	4.90
6	4824.00	37.4 AV	54.0	-16.6	1.62 H	302	32.50	4.90

ANTENNA POLARITY & TEST DISTANCE: VERTICAL AT 3 M

NO.	FREQ. (MHz)	EMISSION LEVEL (dBuV/m)	LIMIT (dBuV/m)	MARGIN (dB)	ANTENNA HEIGHT (m)	TABLE ANGLE (Degree)	RAW VALUE (dBuV)	CORRECTION FACTOR (dB/m)
1	2390.00	61.4 PK	74.0	-12.6	1.18 V	344	29.80	31.60
2	2390.00	45.3 AV	54.0	-8.7	1.18 V	344	13.70	31.60
3	*2412.00	111.0 PK			1.12 V	347	79.20	31.80
4	*2412.00	101.3 AV			1.12 V	347	69.50	31.80
5	4824.00	49.1 PK	74.0	-24.9	1.00 V	2	44.20	4.90
6	4824.00	35.4 AV	54.0	-18.6	1.00 V	2	30.50	4.90

REMARKS:

1. Emission Level(dBuV/m) = Raw Value(dBuV) + Correction Factor(dB/m)
2. Correction Factor(dB/m) = Antenna Factor(dB/m) + Cable Factor(dB)
3. The other emission levels were very low against the limit.
4. Margin value = Emission Level – Limit value
5. " * ": Fundamental frequency.

CHANNEL	TX Channel 6	DETECTOR FUNCTION	Peak (PK)
FREQUENCY RANGE	1GHz ~ 25GHz		Average (AV)

ANTENNA POLARITY & TEST DISTANCE: HORIZONTAL AT 3 M

NO.	FREQ. (MHz)	EMISSION LEVEL (dBuV/m)	LIMIT (dBuV/m)	MARGIN (dB)	ANTENNA HEIGHT (m)	TABLE ANGLE (Degree)	RAW VALUE (dBuV)	CORRECTION FACTOR (dB/m)
1	2390.00	68.4 PK	74.0	-5.6	1.74 H	292	36.80	31.60
2	2390.00	50.3 AV	54.0	-3.7	1.74 H	292	18.70	31.60
3	*2437.00	120.1 PK			1.27 H	284	88.20	31.90
4	*2437.00	111.2 AV			1.27 H	284	79.30	31.90
5	4874.00	64.9 PK	74.0	-9.1	1.67 H	305	59.90	5.00
6	4874.00	50.7 AV	54.0	-3.3	1.67 H	305	45.70	5.00

ANTENNA POLARITY & TEST DISTANCE: VERTICAL AT 3 M

NO.	FREQ. (MHz)	EMISSION LEVEL (dBuV/m)	LIMIT (dBuV/m)	MARGIN (dB)	ANTENNA HEIGHT (m)	TABLE ANGLE (Degree)	RAW VALUE (dBuV)	CORRECTION FACTOR (dB/m)
1	2390.00	68.1 PK	74.0	-5.9	1.10 V	355	36.50	31.60
2	2390.00	49.1 AV	54.0	-4.9	1.10 V	355	17.50	31.60
3	*2437.00	117.9 PK			1.25 V	343	86.00	31.90
4	*2437.00	107.6 AV			1.25 V	343	75.70	31.90
5	4874.00	55.7 PK	74.0	-18.3	1.00 V	1	50.70	5.00
6	4874.00	42.4 AV	54.0	-11.6	1.00 V	1	37.40	5.00

REMARKS:

1. Emission Level(dBuV/m) = Raw Value(dBuV) + Correction Factor(dB/m)
2. Correction Factor(dB/m) = Antenna Factor(dB/m) + Cable Factor(dB)
3. The other emission levels were very low against the limit.
4. Margin value = Emission Level – Limit value
5. " * ": Fundamental frequency.

CHANNEL	TX Channel 11	DETECTOR FUNCTION	Peak (PK)
FREQUENCY RANGE	1GHz ~ 25GHz		Average (AV)

ANTENNA POLARITY & TEST DISTANCE: HORIZONTAL AT 3 M

NO.	FREQ. (MHz)	EMISSION LEVEL (dBuV/m)	LIMIT (dBuV/m)	MARGIN (dB)	ANTENNA HEIGHT (m)	TABLE ANGLE (Degree)	RAW VALUE (dBuV)	CORRECTION FACTOR (dB/m)
1	*2462.00	116.0 PK			1.55 H	331	84.00	32.00
2	*2462.00	106.4 AV			1.55 H	331	74.40	32.00
3	2483.50	70.3 PK	74.0	-3.7	1.26 H	289	38.30	32.00
4	2483.50	53.4 AV	54.0	-0.6	1.26 H	289	21.40	32.00
5	4924.00	53.0 PK	74.0	-21.0	1.65 H	301	47.90	5.10
6	4924.00	39.8 AV	54.0	-14.2	1.65 H	301	34.70	5.10

ANTENNA POLARITY & TEST DISTANCE: VERTICAL AT 3 M

NO.	FREQ. (MHz)	EMISSION LEVEL (dBuV/m)	LIMIT (dBuV/m)	MARGIN (dB)	ANTENNA HEIGHT (m)	TABLE ANGLE (Degree)	RAW VALUE (dBuV)	CORRECTION FACTOR (dB/m)
1	*2462.00	111.8 PK			1.10 V	353	79.80	32.00
2	*2462.00	102.3 AV			1.10 V	353	70.30	32.00
3	2483.50	66.2 PK	74.0	-7.8	1.05 V	359	34.20	32.00
4	2483.50	49.6 AV	54.0	-4.4	1.05 V	359	17.60	32.00
5	4924.00	49.9 PK	74.0	-24.1	1.00 V	4	44.80	5.10
6	4924.00	37.5 AV	54.0	-16.5	1.00 V	4	32.40	5.10

REMARKS:

1. Emission Level(dBuV/m) = Raw Value(dBuV) + Correction Factor(dB/m)
2. Correction Factor(dB/m) = Antenna Factor(dB/m) + Cable Factor(dB)
3. The other emission levels were very low against the limit.
4. Margin value = Emission Level – Limit value
5. " * " : Fundamental frequency.

802.11n (HT20)

CHANNEL	TX Channel 1	DETECTOR FUNCTION	Peak (PK)
FREQUENCY RANGE	1GHz ~ 25GHz		Average (AV)

ANTENNA POLARITY & TEST DISTANCE: HORIZONTAL AT 3 M								
NO.	FREQ. (MHz)	EMISSION LEVEL (dBuV/m)	LIMIT (dBuV/m)	MARGIN (dB)	ANTENNA HEIGHT (m)	TABLE ANGLE (Degree)	RAW VALUE (dBuV)	CORRECTION FACTOR (dB/m)
1	2390.00	70.5 PK	74.0	-3.5	1.00 H	295	38.90	31.60
2	2390.00	53.3 AV	54.0	-0.7	1.00 H	295	21.70	31.60
3	*2412.00	114.0 PK			1.37 H	318	82.20	31.80
4	*2412.00	104.4 AV			1.37 H	318	72.60	31.80
5	4824.00	49.4 PK	74.0	-24.6	1.92 H	70	44.50	4.90
6	4824.00	36.8 AV	54.0	-17.2	1.92 H	70	31.90	4.90
ANTENNA POLARITY & TEST DISTANCE: VERTICAL AT 3 M								
NO.	FREQ. (MHz)	EMISSION LEVEL (dBuV/m)	LIMIT (dBuV/m)	MARGIN (dB)	ANTENNA HEIGHT (m)	TABLE ANGLE (Degree)	RAW VALUE (dBuV)	CORRECTION FACTOR (dB/m)
1	2390.00	67.3 PK	74.0	-6.7	1.00 V	13	35.70	31.60
2	2390.00	48.7 AV	54.0	-5.3	1.00 V	13	17.10	31.60
3	*2412.00	111.7 PK			1.00 V	15	79.90	31.80
4	*2412.00	101.1 AV			1.00 V	15	69.30	31.80
5	4824.00	48.6 PK	74.0	-25.4	1.00 V	3	43.70	4.90
6	4824.00	35.2 AV	54.0	-18.8	1.00 V	3	30.30	4.90

REMARKS:

1. Emission Level(dBuV/m) = Raw Value(dBuV) + Correction Factor(dB/m)
2. Correction Factor(dB/m) = Antenna Factor(dB/m) + Cable Factor(dB)
3. The other emission levels were very low against the limit.
4. Margin value = Emission Level – Limit value
5. " * ": Fundamental frequency.

CHANNEL	TX Channel 6	DETECTOR FUNCTION	Peak (PK)
FREQUENCY RANGE	1GHz ~ 25GHz		Average (AV)

ANTENNA POLARITY & TEST DISTANCE: HORIZONTAL AT 3 M

NO.	FREQ. (MHz)	EMISSION LEVEL (dBuV/m)	LIMIT (dBuV/m)	MARGIN (dB)	ANTENNA HEIGHT (m)	TABLE ANGLE (Degree)	RAW VALUE (dBuV)	CORRECTION FACTOR (dB/m)
1	2390.00	67.6 PK	74.0	-6.4	1.23 H	336	36.00	31.60
2	2390.00	51.5 AV	54.0	-2.5	1.23 H	336	19.90	31.60
3	*2437.00	122.1 PK			1.26 H	330	90.20	31.90
4	*2437.00	112.1 AV			1.26 H	330	80.20	31.90
5	4874.00	62.1 PK	74.0	-11.9	1.90 H	72	57.10	5.00
6	4874.00	47.5 AV	54.0	-6.5	1.90 H	72	42.50	5.00

ANTENNA POLARITY & TEST DISTANCE: VERTICAL AT 3 M

NO.	FREQ. (MHz)	EMISSION LEVEL (dBuV/m)	LIMIT (dBuV/m)	MARGIN (dB)	ANTENNA HEIGHT (m)	TABLE ANGLE (Degree)	RAW VALUE (dBuV)	CORRECTION FACTOR (dB/m)
1	2390.00	61.8 PK	74.0	-12.2	1.00 V	356	30.20	31.60
2	2390.00	47.7 AV	54.0	-6.3	1.00 V	356	16.10	31.60
3	*2437.00	116.9 PK			1.00 V	359	85.00	31.90
4	*2437.00	106.4 AV			1.00 V	359	74.50	31.90
5	4874.00	51.5 PK	74.0	-22.5	1.00 V	36	46.50	5.00
6	4874.00	38.9 AV	54.0	-15.1	1.00 V	36	33.90	5.00

REMARKS:

1. Emission Level(dBuV/m) = Raw Value(dBuV) + Correction Factor(dB/m)
2. Correction Factor(dB/m) = Antenna Factor(dB/m) + Cable Factor(dB)
3. The other emission levels were very low against the limit.
4. Margin value = Emission Level – Limit value
5. " * ": Fundamental frequency.

CHANNEL	TX Channel 11	DETECTOR FUNCTION	Peak (PK)
FREQUENCY RANGE	1GHz ~ 25GHz		Average (AV)

ANTENNA POLARITY & TEST DISTANCE: HORIZONTAL AT 3 M

NO.	FREQ. (MHz)	EMISSION LEVEL (dBuV/m)	LIMIT (dBuV/m)	MARGIN (dB)	ANTENNA HEIGHT (m)	TABLE ANGLE (Degree)	RAW VALUE (dBuV)	CORRECTION FACTOR (dB/m)
1	*2462.00	116.4 PK			1.32 H	326	84.40	32.00
2	*2462.00	105.1 AV			1.32 H	326	73.10	32.00
3	2483.50	70.5 PK	74.0	-3.5	1.57 H	286	38.50	32.00
4	2483.50	53.3 AV	54.0	-0.7	1.57 H	286	21.30	32.00
5	4924.00	52.8 PK	74.0	-21.2	1.91 H	71	47.70	5.10
6	4924.00	39.2 AV	54.0	-14.8	1.91 H	71	34.10	5.10

ANTENNA POLARITY & TEST DISTANCE: VERTICAL AT 3 M

NO.	FREQ. (MHz)	EMISSION LEVEL (dBuV/m)	LIMIT (dBuV/m)	MARGIN (dB)	ANTENNA HEIGHT (m)	TABLE ANGLE (Degree)	RAW VALUE (dBuV)	CORRECTION FACTOR (dB/m)
1	*2462.00	110.7 PK			1.13 V	348	78.70	32.00
2	*2462.00	99.5 AV			1.13 V	348	67.50	32.00
3	2483.50	65.1 PK	74.0	-8.9	1.19 V	347	33.10	32.00
4	2483.50	47.9 AV	54.0	-6.1	1.19 V	347	15.90	32.00
5	4924.00	49.7 PK	74.0	-24.3	1.00 V	2	44.60	5.10
6	4924.00	37.2 AV	54.0	-16.8	1.00 V	2	32.10	5.10

REMARKS:

1. Emission Level(dBuV/m) = Raw Value(dBuV) + Correction Factor(dB/m)
2. Correction Factor(dB/m) = Antenna Factor(dB/m) + Cable Factor(dB)
3. The other emission levels were very low against the limit.
4. Margin value = Emission Level – Limit value
5. " * " : Fundamental frequency.

802.11n (HT40)

CHANNEL	TX Channel 3	DETECTOR FUNCTION	Peak (PK)
FREQUENCY RANGE	1GHz ~ 25GHz		Average (AV)

ANTENNA POLARITY & TEST DISTANCE: HORIZONTAL AT 3 M								
NO.	FREQ. (MHz)	EMISSION LEVEL (dBuV/m)	LIMIT (dBuV/m)	MARGIN (dB)	ANTENNA HEIGHT (m)	TABLE ANGLE (Degree)	RAW VALUE (dBuV)	CORRECTION FACTOR (dB/m)
1	2390.00	68.0 PK	74.0	-6.0	1.68 H	289	36.40	31.60
2	2390.00	53.9 AV	54.0	-0.1	1.68 H	289	22.30	31.60
3	*2422.00	110.3 PK			1.71 H	334	78.50	31.80
4	*2422.00	99.9 AV			1.71 H	334	68.10	31.80
5	4844.00	48.8 PK	74.0	-25.2	1.91 H	71	43.90	4.90
6	4844.00	36.0 AV	54.0	-18.0	1.91 H	71	31.10	4.90

ANTENNA POLARITY & TEST DISTANCE: VERTICAL AT 3 M								
NO.	FREQ. (MHz)	EMISSION LEVEL (dBuV/m)	LIMIT (dBuV/m)	MARGIN (dB)	ANTENNA HEIGHT (m)	TABLE ANGLE (Degree)	RAW VALUE (dBuV)	CORRECTION FACTOR (dB/m)
1	2390.00	67.6 PK	74.0	-6.4	1.00 V	19	36.00	31.60
2	2390.00	49.3 AV	54.0	-4.7	1.00 V	19	17.70	31.60
3	*2422.00	106.4 PK			1.00 V	13	74.60	31.80
4	*2422.00	95.6 AV			1.00 V	13	63.80	31.80
5	4844.00	48.0 PK	74.0	-26.0	1.00 V	8	43.10	4.90
6	4844.00	35.4 AV	54.0	-18.6	1.00 V	8	30.50	4.90

REMARKS:

1. Emission Level(dBuV/m) = Raw Value(dBuV) + Correction Factor(dB/m)
2. Correction Factor(dB/m) = Antenna Factor(dB/m) + Cable Factor(dB)
3. The other emission levels were very low against the limit.
4. Margin value = Emission Level – Limit value
5. " * ": Fundamental frequency.

CHANNEL	TX Channel 6	DETECTOR FUNCTION	Peak (PK)
FREQUENCY RANGE	1GHz ~ 25GHz		Average (AV)

ANTENNA POLARITY & TEST DISTANCE: HORIZONTAL AT 3 M

NO.	FREQ. (MHz)	EMISSION LEVEL (dBuV/m)	LIMIT (dBuV/m)	MARGIN (dB)	ANTENNA HEIGHT (m)	TABLE ANGLE (Degree)	RAW VALUE (dBuV)	CORRECTION FACTOR (dB/m)
1	2390.00	65.9 PK	74.0	-8.1	1.29 H	291	34.30	31.60
2	2390.00	53.6 AV	54.0	-0.4	1.29 H	291	22.00	31.60
3	*2437.00	112.0 PK			1.29 H	326	80.10	31.90
4	*2437.00	102.1 AV			1.29 H	326	70.20	31.90
5	4874.00	50.1 PK	74.0	-23.9	1.93 H	77	45.10	5.00
6	4874.00	37.2 AV	54.0	-16.8	1.93 H	77	32.20	5.00

ANTENNA POLARITY & TEST DISTANCE: VERTICAL AT 3 M

NO.	FREQ. (MHz)	EMISSION LEVEL (dBuV/m)	LIMIT (dBuV/m)	MARGIN (dB)	ANTENNA HEIGHT (m)	TABLE ANGLE (Degree)	RAW VALUE (dBuV)	CORRECTION FACTOR (dB/m)
1	2390.00	59.2 PK	74.0	-14.8	1.17 V	9	27.60	31.60
2	2390.00	48.9 AV	54.0	-5.1	1.17 V	9	17.30	31.60
3	*2437.00	109.3 PK			1.13 V	2	77.40	31.90
4	*2437.00	98.6 AV			1.13 V	2	66.70	31.90
5	4874.00	48.7 PK	74.0	-25.3	1.00 V	16	43.70	5.00
6	4874.00	36.3 AV	54.0	-17.7	1.00 V	16	31.30	5.00

REMARKS:

1. Emission Level(dBuV/m) = Raw Value(dBuV) + Correction Factor(dB/m)
2. Correction Factor(dB/m) = Antenna Factor(dB/m) + Cable Factor(dB)
3. The other emission levels were very low against the limit.
4. Margin value = Emission Level – Limit value
5. " * ": Fundamental frequency.

CHANNEL	TX Channel 9	DETECTOR FUNCTION	Peak (PK)
FREQUENCY RANGE	1GHz ~ 25GHz		Average (AV)

ANTENNA POLARITY & TEST DISTANCE: HORIZONTAL AT 3 M								
NO.	FREQ. (MHz)	EMISSION LEVEL (dBuV/m)	LIMIT (dBuV/m)	MARGIN (dB)	ANTENNA HEIGHT (m)	TABLE ANGLE (Degree)	RAW VALUE (dBuV)	CORRECTION FACTOR (dB/m)
1	*2452.00	109.8 PK			1.75 H	334	77.90	31.90
2	*2452.00	99.3 AV			1.75 H	334	67.40	31.90
3	2483.50	71.4 PK	74.0	-2.6	1.27 H	343	39.40	32.00
4	2483.50	53.4 AV	54.0	-0.6	1.27 H	343	21.40	32.00
5	4904.00	49.6 PK	74.0	-24.4	1.92 H	72	44.60	5.00
6	4904.00	35.7 AV	54.0	-18.3	1.92 H	72	30.70	5.00

ANTENNA POLARITY & TEST DISTANCE: VERTICAL AT 3 M								
NO.	FREQ. (MHz)	EMISSION LEVEL (dBuV/m)	LIMIT (dBuV/m)	MARGIN (dB)	ANTENNA HEIGHT (m)	TABLE ANGLE (Degree)	RAW VALUE (dBuV)	CORRECTION FACTOR (dB/m)
1	*2452.00	106.7 PK			1.00 V	1	74.80	31.90
2	*2452.00	96.1 AV			1.00 V	1	64.20	31.90
3	2483.50	70.8 PK	74.0	-3.2	1.00 V	2	38.80	32.00
4	2483.50	49.7 AV	54.0	-4.3	1.00 V	2	17.70	32.00
5	4904.00	48.2 PK	74.0	-25.8	1.00 V	11	43.20	5.00
6	4904.00	35.3 AV	54.0	-18.7	1.00 V	11	30.30	5.00

REMARKS:

1. Emission Level(dBuV/m) = Raw Value(dBuV) + Correction Factor(dB/m)
2. Correction Factor(dB/m) = Antenna Factor(dB/m) + Cable Factor(dB)
3. The other emission levels were very low against the limit.
4. Margin value = Emission Level – Limit value
5. " * " : Fundamental frequency.

Test Mode D
1TX
802.11b

CHANNEL	TX Channel 1	DETECTOR FUNCTION	Peak (PK)
FREQUENCY RANGE	1GHz ~ 25GHz		Average (AV)

ANTENNA POLARITY & TEST DISTANCE: HORIZONTAL AT 3 M

NO.	FREQ. (MHz)	EMISSION LEVEL (dBuV/m)	LIMIT (dBuV/m)	MARGIN (dB)	ANTENNA HEIGHT (m)	TABLE ANGLE (Degree)	RAW VALUE (dBuV)	CORRECTION FACTOR (dB/m)
1	2390.00	57.3 PK	74.0	-16.7	1.15 H	70	25.70	31.60
2	2390.00	46.9 AV	54.0	-7.1	1.15 H	70	15.30	31.60
3	*2412.00	109.1 PK			1.13 H	63	77.30	31.80
4	*2412.00	106.0 AV			1.13 H	63	74.20	31.80
5	4824.00	55.6 PK	74.0	-18.4	1.10 H	41	50.70	4.90
6	4824.00	52.7 AV	54.0	-1.3	1.10 H	41	47.80	4.90

ANTENNA POLARITY & TEST DISTANCE: VERTICAL AT 3 M

NO.	FREQ. (MHz)	EMISSION LEVEL (dBuV/m)	LIMIT (dBuV/m)	MARGIN (dB)	ANTENNA HEIGHT (m)	TABLE ANGLE (Degree)	RAW VALUE (dBuV)	CORRECTION FACTOR (dB/m)
1	2390.00	55.5 PK	74.0	-18.5	1.35 V	175	23.90	31.60
2	2390.00	44.5 AV	54.0	-9.5	1.35 V	175	12.90	31.60
3	*2412.00	103.3 PK			1.32 V	180	71.50	31.80
4	*2412.00	99.4 AV			1.32 V	180	67.60	31.80
5	4824.00	52.4 PK	74.0	-21.6	1.00 V	347	47.50	4.90
6	4824.00	48.9 AV	54.0	-5.1	1.00 V	347	44.00	4.90

REMARKS:

1. Emission Level(dBuV/m) = Raw Value(dBuV) + Correction Factor(dB/m)
2. Correction Factor(dB/m) = Antenna Factor(dB/m) + Cable Factor(dB)
3. The other emission levels were very low against the limit.
4. Margin value = Emission Level – Limit value
5. " * ": Fundamental frequency.

CHANNEL	TX Channel 6	DETECTOR FUNCTION	Peak (PK)
FREQUENCY RANGE	1GHz ~ 25GHz		Average (AV)

ANTENNA POLARITY & TEST DISTANCE: HORIZONTAL AT 3 M

NO.	FREQ. (MHz)	EMISSION LEVEL (dBuV/m)	LIMIT (dBuV/m)	MARGIN (dB)	ANTENNA HEIGHT (m)	TABLE ANGLE (Degree)	RAW VALUE (dBuV)	CORRECTION FACTOR (dB/m)
1	*2437.00	109.7 PK			1.25 H	75	77.80	31.90
2	*2437.00	106.0 AV			1.25 H	75	74.10	31.90
3	4874.00	55.2 PK	74.0	-18.8	1.39 H	41	50.20	5.00
4	4874.00	52.5 AV	54.0	-1.5	1.39 H	41	47.50	5.00

ANTENNA POLARITY & TEST DISTANCE: VERTICAL AT 3 M

NO.	FREQ. (MHz)	EMISSION LEVEL (dBuV/m)	LIMIT (dBuV/m)	MARGIN (dB)	ANTENNA HEIGHT (m)	TABLE ANGLE (Degree)	RAW VALUE (dBuV)	CORRECTION FACTOR (dB/m)
1	*2437.00	104.2 PK			1.47 V	178	72.30	31.90
2	*2437.00	100.3 AV			1.47 V	178	68.40	31.90
3	4874.00	56.0 PK	74.0	-18.0	1.00 V	340	51.00	5.00
4	4874.00	53.0 AV	54.0	-1.0	1.00 V	340	48.00	5.00

REMARKS:

1. Emission Level(dBuV/m) = Raw Value(dBuV) + Correction Factor(dB/m)
2. Correction Factor(dB/m) = Antenna Factor(dB/m) + Cable Factor(dB)
3. The other emission levels were very low against the limit.
4. Margin value = Emission Level – Limit value
5. " * ": Fundamental frequency.

CHANNEL	TX Channel 11	DETECTOR FUNCTION	Peak (PK)
FREQUENCY RANGE	1GHz ~ 25GHz		Average (AV)

ANTENNA POLARITY & TEST DISTANCE: HORIZONTAL AT 3 M

NO.	FREQ. (MHz)	EMISSION LEVEL (dBuV/m)	LIMIT (dBuV/m)	MARGIN (dB)	ANTENNA HEIGHT (m)	TABLE ANGLE (Degree)	RAW VALUE (dBuV)	CORRECTION FACTOR (dB/m)
1	*2462.00	109.7 PK			1.39 H	68	77.70	32.00
2	*2462.00	106.0 AV			1.39 H	68	74.00	32.00
3	2483.50	60.3 PK	74.0	-13.7	1.42 H	72	28.30	32.00
4	2483.50	52.9 AV	54.0	-1.1	1.42 H	72	20.90	32.00
5	4924.00	54.9 PK	74.0	-19.1	1.62 H	81	49.80	5.10
6	4924.00	51.8 AV	54.0	-2.2	1.62 H	81	46.70	5.10

ANTENNA POLARITY & TEST DISTANCE: VERTICAL AT 3 M

NO.	FREQ. (MHz)	EMISSION LEVEL (dBuV/m)	LIMIT (dBuV/m)	MARGIN (dB)	ANTENNA HEIGHT (m)	TABLE ANGLE (Degree)	RAW VALUE (dBuV)	CORRECTION FACTOR (dB/m)
1	*2462.00	103.9 PK			1.30 V	179	71.90	32.00
2	*2462.00	100.6 AV			1.30 V	179	68.60	32.00
3	2483.50	57.8 PK	74.0	-16.2	1.35 V	181	25.80	32.00
4	2483.50	48.9 AV	54.0	-5.1	1.35 V	181	16.90	32.00
5	4924.00	53.4 PK	74.0	-20.6	1.05 V	338	48.30	5.10
6	4924.00	49.6 AV	54.0	-4.4	1.05 V	338	44.50	5.10

REMARKS:

1. Emission Level(dBuV/m) = Raw Value(dBuV) + Correction Factor(dB/m)
2. Correction Factor(dB/m) = Antenna Factor(dB/m) + Cable Factor(dB)
3. The other emission levels were very low against the limit.
4. Margin value = Emission Level – Limit value
5. " * " : Fundamental frequency.

802.11g

CHANNEL	TX Channel 1	DETECTOR FUNCTION	Peak (PK)
FREQUENCY RANGE	1GHz ~ 25GHz		Average (AV)

ANTENNA POLARITY & TEST DISTANCE: HORIZONTAL AT 3 M

NO.	FREQ. (MHz)	EMISSION LEVEL (dBuV/m)	LIMIT (dBuV/m)	MARGIN (dB)	ANTENNA HEIGHT (m)	TABLE ANGLE (Degree)	RAW VALUE (dBuV)	CORRECTION FACTOR (dB/m)
1	2390.00	70.2 PK	74.0	-3.8	1.60 H	71	38.60	31.60
2	2390.00	52.8 AV	54.0	-1.2	1.60 H	71	21.20	31.60
3	*2412.00	107.4 PK			1.61 H	74	75.60	31.80
4	*2412.00	97.7 AV			1.61 H	74	65.90	31.80
5	4824.00	47.5 PK	74.0	-26.5	1.23 H	95	42.60	4.90
6	4824.00	35.5 AV	54.0	-18.5	1.23 H	95	30.60	4.90

ANTENNA POLARITY & TEST DISTANCE: VERTICAL AT 3 M

NO.	FREQ. (MHz)	EMISSION LEVEL (dBuV/m)	LIMIT (dBuV/m)	MARGIN (dB)	ANTENNA HEIGHT (m)	TABLE ANGLE (Degree)	RAW VALUE (dBuV)	CORRECTION FACTOR (dB/m)
1	2390.00	63.9 PK	74.0	-10.1	2.85 V	350	32.30	31.60
2	2390.00	47.4 AV	54.0	-6.6	2.85 V	350	15.80	31.60
3	*2412.00	102.8 PK			2.91 V	352	71.00	31.80
4	*2412.00	93.2 AV			2.91 V	352	61.40	31.80
5	4824.00	46.4 PK	74.0	-27.6	1.32 V	96	41.50	4.90
6	4824.00	33.9 AV	54.0	-20.1	1.32 V	96	29.00	4.90

REMARKS:

1. Emission Level(dBuV/m) = Raw Value(dBuV) + Correction Factor(dB/m)
2. Correction Factor(dB/m) = Antenna Factor(dB/m) + Cable Factor(dB)
3. The other emission levels were very low against the limit.
4. Margin value = Emission Level – Limit value
5. " * ": Fundamental frequency.

CHANNEL	TX Channel 6	DETECTOR FUNCTION	Peak (PK)
FREQUENCY RANGE	1GHz ~ 25GHz		Average (AV)

ANTENNA POLARITY & TEST DISTANCE: HORIZONTAL AT 3 M

NO.	FREQ. (MHz)	EMISSION LEVEL (dBuV/m)	LIMIT (dBuV/m)	MARGIN (dB)	ANTENNA HEIGHT (m)	TABLE ANGLE (Degree)	RAW VALUE (dBuV)	CORRECTION FACTOR (dB/m)
1	*2437.00	112.9 PK			1.40 H	62	81.00	31.90
2	*2437.00	103.2 AV			1.40 H	62	71.30	31.90
3	4874.00	54.2 PK	74.0	-19.8	1.31 H	42	49.20	5.00
4	4874.00	42.0 AV	54.0	-12.0	1.31 H	42	37.00	5.00

ANTENNA POLARITY & TEST DISTANCE: VERTICAL AT 3 M

NO.	FREQ. (MHz)	EMISSION LEVEL (dBuV/m)	LIMIT (dBuV/m)	MARGIN (dB)	ANTENNA HEIGHT (m)	TABLE ANGLE (Degree)	RAW VALUE (dBuV)	CORRECTION FACTOR (dB/m)
1	*2437.00	106.6 PK			1.02 V	170	74.70	31.90
2	*2437.00	96.6 AV			1.02 V	170	64.70	31.90
3	4874.00	54.2 PK	74.0	-19.8	1.00 V	342	49.20	5.00
4	4874.00	41.3 AV	54.0	-12.7	1.00 V	342	36.30	5.00

REMARKS:

1. Emission Level(dBuV/m) = Raw Value(dBuV) + Correction Factor(dB/m)
2. Correction Factor(dB/m) = Antenna Factor(dB/m) + Cable Factor(dB)
3. The other emission levels were very low against the limit.
4. Margin value = Emission Level – Limit value
5. " * ": Fundamental frequency.

CHANNEL	TX Channel 11	DETECTOR FUNCTION	Peak (PK)
FREQUENCY RANGE	1GHz ~ 25GHz		Average (AV)

ANTENNA POLARITY & TEST DISTANCE: HORIZONTAL AT 3 M

NO.	FREQ. (MHz)	EMISSION LEVEL (dBuV/m)	LIMIT (dBuV/m)	MARGIN (dB)	ANTENNA HEIGHT (m)	TABLE ANGLE (Degree)	RAW VALUE (dBuV)	CORRECTION FACTOR (dB/m)
1	*2462.00	107.5 PK			1.83 H	45	75.50	32.00
2	*2462.00	98.0 AV			1.83 H	45	66.00	32.00
3	2483.50	69.3 PK	74.0	-4.7	1.84 H	45	37.30	32.00
4	2483.50	53.3 AV	54.0	-0.7	1.84 H	45	21.30	32.00
5	4924.00	47.7 PK	74.0	-26.3	1.10 H	25	42.60	5.10
6	4924.00	35.3 AV	54.0	-18.7	1.10 H	25	30.20	5.10

ANTENNA POLARITY & TEST DISTANCE: VERTICAL AT 3 M

NO.	FREQ. (MHz)	EMISSION LEVEL (dBuV/m)	LIMIT (dBuV/m)	MARGIN (dB)	ANTENNA HEIGHT (m)	TABLE ANGLE (Degree)	RAW VALUE (dBuV)	CORRECTION FACTOR (dB/m)
1	*2462.00	101.0 PK			1.31 V	175	69.00	32.00
2	*2462.00	91.6 AV			1.31 V	175	59.60	32.00
3	2483.50	62.3 PK	74.0	-11.7	1.35 V	180	30.30	32.00
4	2483.50	48.0 AV	54.0	-6.0	1.35 V	180	16.00	32.00
5	4924.00	46.6 PK	74.0	-27.4	1.08 V	74	41.50	5.10
6	4924.00	34.1 AV	54.0	-19.9	1.08 V	74	29.00	5.10

REMARKS:

1. Emission Level(dBuV/m) = Raw Value(dBuV) + Correction Factor(dB/m)
2. Correction Factor(dB/m) = Antenna Factor(dB/m) + Cable Factor(dB)
3. The other emission levels were very low against the limit.
4. Margin value = Emission Level – Limit value
5. " * ": Fundamental frequency.

802.11n (HT20)

CHANNEL	TX Channel 1	DETECTOR FUNCTION	Peak (PK)
FREQUENCY RANGE	1GHz ~ 25GHz		Average (AV)

ANTENNA POLARITY & TEST DISTANCE: HORIZONTAL AT 3 M								
NO.	FREQ. (MHz)	EMISSION LEVEL (dBuV/m)	LIMIT (dBuV/m)	MARGIN (dB)	ANTENNA HEIGHT (m)	TABLE ANGLE (Degree)	RAW VALUE (dBuV)	CORRECTION FACTOR (dB/m)
1	2390.00	67.3 PK	74.0	-6.7	1.15 H	75	35.70	31.60
2	2390.00	53.0 AV	54.0	-1.0	1.15 H	75	21.40	31.60
3	*2412.00	109.8 PK			1.20 H	80	78.00	31.80
4	*2412.00	99.8 AV			1.20 H	80	68.00	31.80
5	4824.00	47.8 PK	74.0	-26.2	1.39 H	64	42.90	4.90
6	4824.00	34.9 AV	54.0	-19.1	1.39 H	64	30.00	4.90

ANTENNA POLARITY & TEST DISTANCE: VERTICAL AT 3 M								
NO.	FREQ. (MHz)	EMISSION LEVEL (dBuV/m)	LIMIT (dBuV/m)	MARGIN (dB)	ANTENNA HEIGHT (m)	TABLE ANGLE (Degree)	RAW VALUE (dBuV)	CORRECTION FACTOR (dB/m)
1	2390.00	62.2 PK	74.0	-11.8	1.50 V	192	30.60	31.60
2	2390.00	49.5 AV	54.0	-4.5	1.50 V	192	17.90	31.60
3	*2412.00	103.0 PK			1.34 V	181	71.20	31.80
4	*2412.00	94.3 AV			1.34 V	181	62.50	31.80
5	4824.00	46.5 PK	74.0	-27.5	1.15 V	74	41.60	4.90
6	4824.00	33.7 AV	54.0	-20.3	1.15 V	74	28.80	4.90

REMARKS:

1. Emission Level(dBuV/m) = Raw Value(dBuV) + Correction Factor(dB/m)
2. Correction Factor(dB/m) = Antenna Factor(dB/m) + Cable Factor(dB)
3. The other emission levels were very low against the limit.
4. Margin value = Emission Level – Limit value
5. " * ": Fundamental frequency.

CHANNEL	TX Channel 6	DETECTOR FUNCTION	Peak (PK)
FREQUENCY RANGE	1GHz ~ 25GHz		Average (AV)

ANTENNA POLARITY & TEST DISTANCE: HORIZONTAL AT 3 M

NO.	FREQ. (MHz)	EMISSION LEVEL (dBuV/m)	LIMIT (dBuV/m)	MARGIN (dB)	ANTENNA HEIGHT (m)	TABLE ANGLE (Degree)	RAW VALUE (dBuV)	CORRECTION FACTOR (dB/m)
1	*2437.00	113.1 PK			1.10 H	63	81.20	31.90
2	*2437.00	104.1 AV			1.10 H	63	72.20	31.90
3	4874.00	48.0 PK	74.0	-26.0	1.38 H	54	43.00	5.00
4	4874.00	35.8 AV	54.0	-18.2	1.38 H	54	30.80	5.00

ANTENNA POLARITY & TEST DISTANCE: VERTICAL AT 3 M

NO.	FREQ. (MHz)	EMISSION LEVEL (dBuV/m)	LIMIT (dBuV/m)	MARGIN (dB)	ANTENNA HEIGHT (m)	TABLE ANGLE (Degree)	RAW VALUE (dBuV)	CORRECTION FACTOR (dB/m)
1	*2437.00	106.6 PK			1.46 V	178	74.70	31.90
2	*2437.00	96.6 AV			1.46 V	178	64.70	31.90
3	4874.00	46.5 PK	74.0	-27.5	1.08 V	64	41.50	5.00
4	4874.00	33.8 AV	54.0	-20.2	1.08 V	64	28.80	5.00

REMARKS:

1. Emission Level(dBuV/m) = Raw Value(dBuV) + Correction Factor(dB/m)
2. Correction Factor(dB/m) = Antenna Factor(dB/m) + Cable Factor(dB)
3. The other emission levels were very low against the limit.
4. Margin value = Emission Level – Limit value
5. " * ": Fundamental frequency.

CHANNEL	TX Channel 11	DETECTOR FUNCTION	Peak (PK)
FREQUENCY RANGE	1GHz ~ 25GHz		Average (AV)

ANTENNA POLARITY & TEST DISTANCE: HORIZONTAL AT 3 M

NO.	FREQ. (MHz)	EMISSION LEVEL (dBuV/m)	LIMIT (dBuV/m)	MARGIN (dB)	ANTENNA HEIGHT (m)	TABLE ANGLE (Degree)	RAW VALUE (dBuV)	CORRECTION FACTOR (dB/m)
1	*2462.00	108.8 PK			1.55 H	55	76.80	32.00
2	*2462.00	99.6 AV			1.55 H	55	67.60	32.00
3	2483.50	72.8 PK	74.0	-1.2	1.68 H	50	40.80	32.00
4	2483.50	53.0 AV	54.0	-1.0	1.68 H	50	21.00	32.00
5	4924.00	47.7 PK	74.0	-26.3	1.36 H	52	42.60	5.10
6	4924.00	35.2 AV	54.0	-18.8	1.36 H	52	30.10	5.10

ANTENNA POLARITY & TEST DISTANCE: VERTICAL AT 3 M

NO.	FREQ. (MHz)	EMISSION LEVEL (dBuV/m)	LIMIT (dBuV/m)	MARGIN (dB)	ANTENNA HEIGHT (m)	TABLE ANGLE (Degree)	RAW VALUE (dBuV)	CORRECTION FACTOR (dB/m)
1	*2462.00	102.5 PK			1.15 V	182	70.50	32.00
2	*2462.00	93.6 AV			1.15 V	182	61.60	32.00
3	2483.50	62.6 PK	74.0	-11.4	1.20 V	190	30.60	32.00
4	2483.50	48.4 AV	54.0	-5.6	1.20 V	190	16.40	32.00
5	4924.00	46.1 PK	74.0	-27.9	1.55 V	225	41.00	5.10
6	4924.00	33.5 AV	54.0	-20.5	1.55 V	225	28.40	5.10

REMARKS:

1. Emission Level(dBuV/m) = Raw Value(dBuV) + Correction Factor(dB/m)
2. Correction Factor(dB/m) = Antenna Factor(dB/m) + Cable Factor(dB)
3. The other emission levels were very low against the limit.
4. Margin value = Emission Level – Limit value
5. " * ": Fundamental frequency.

802.11n (HT40)

CHANNEL	TX Channel 3	DETECTOR FUNCTION	Peak (PK)
FREQUENCY RANGE	1GHz ~ 25GHz		Average (AV)

ANTENNA POLARITY & TEST DISTANCE: HORIZONTAL AT 3 M								
NO.	FREQ. (MHz)	EMISSION LEVEL (dBuV/m)	LIMIT (dBuV/m)	MARGIN (dB)	ANTENNA HEIGHT (m)	TABLE ANGLE (Degree)	RAW VALUE (dBuV)	CORRECTION FACTOR (dB/m)
1	2390.00	65.9 PK	74.0	-8.1	1.59 H	71	34.30	31.60
2	2390.00	52.8 AV	54.0	-1.2	1.59 H	71	21.20	31.60
3	*2422.00	97.6 PK			1.56 H	61	65.80	31.80
4	*2422.00	88.7 AV			1.56 H	61	56.90	31.80
5	4844.00	46.4 PK	74.0	-27.6	1.32 H	64	41.50	4.90
6	4844.00	34.3 AV	54.0	-19.7	1.32 H	64	29.40	4.90
ANTENNA POLARITY & TEST DISTANCE: VERTICAL AT 3 M								
NO.	FREQ. (MHz)	EMISSION LEVEL (dBuV/m)	LIMIT (dBuV/m)	MARGIN (dB)	ANTENNA HEIGHT (m)	TABLE ANGLE (Degree)	RAW VALUE (dBuV)	CORRECTION FACTOR (dB/m)
1	2390.00	60.8 PK	74.0	-13.2	1.50 V	180	29.20	31.60
2	2390.00	47.7 AV	54.0	-6.3	1.50 V	180	16.10	31.60
3	*2422.00	91.9 PK			1.47 V	178	60.10	31.80
4	*2422.00	82.3 AV			1.47 V	178	50.50	31.80
5	4844.00	45.4 PK	74.0	-28.6	1.05 V	64	40.50	4.90
6	4844.00	32.3 AV	54.0	-21.7	1.05 V	64	27.40	4.90

REMARKS:

1. Emission Level(dBuV/m) = Raw Value(dBuV) + Correction Factor(dB/m)
2. Correction Factor(dB/m) = Antenna Factor(dB/m) + Cable Factor(dB)
3. The other emission levels were very low against the limit.
4. Margin value = Emission Level – Limit value
5. " * ": Fundamental frequency.

CHANNEL	TX Channel 6	DETECTOR FUNCTION	Peak (PK)
FREQUENCY RANGE	1GHz ~ 25GHz		Average (AV)

ANTENNA POLARITY & TEST DISTANCE: HORIZONTAL AT 3 M

NO.	FREQ. (MHz)	EMISSION LEVEL (dBuV/m)	LIMIT (dBuV/m)	MARGIN (dB)	ANTENNA HEIGHT (m)	TABLE ANGLE (Degree)	RAW VALUE (dBuV)	CORRECTION FACTOR (dB/m)
1	2390.00	66.4 PK	74.0	-7.6	1.13 H	75	34.80	31.60
2	2390.00	53.3 AV	54.0	-0.7	1.13 H	75	21.70	31.60
3	*2437.00	104.8 PK			1.55 H	71	72.90	31.90
4	*2437.00	95.0 AV			1.55 H	71	63.10	31.90
5	4874.00	46.9 PK	74.0	-27.1	1.26 H	97	41.90	5.00
6	4874.00	33.7 AV	54.0	-20.3	1.26 H	97	28.70	5.00

ANTENNA POLARITY & TEST DISTANCE: VERTICAL AT 3 M

NO.	FREQ. (MHz)	EMISSION LEVEL (dBuV/m)	LIMIT (dBuV/m)	MARGIN (dB)	ANTENNA HEIGHT (m)	TABLE ANGLE (Degree)	RAW VALUE (dBuV)	CORRECTION FACTOR (dB/m)
1	2390.00	60.8 PK	74.0	-13.2	1.10 V	182	29.20	31.60
2	2390.00	47.8 AV	54.0	-6.2	1.10 V	182	16.20	31.60
3	*2437.00	98.0 PK			1.02 V	179	66.10	31.90
4	*2437.00	88.5 AV			1.02 V	179	56.60	31.90
5	4874.00	45.1 PK	74.0	-28.9	1.36 V	97	40.10	5.00
6	4874.00	32.5 AV	54.0	-21.5	1.36 V	97	27.50	5.00

REMARKS:

1. Emission Level(dBuV/m) = Raw Value(dBuV) + Correction Factor(dB/m)
2. Correction Factor(dB/m) = Antenna Factor(dB/m) + Cable Factor(dB)
3. The other emission levels were very low against the limit.
4. Margin value = Emission Level – Limit value
5. " * ": Fundamental frequency.

CHANNEL	TX Channel 9	DETECTOR FUNCTION	Peak (PK)
FREQUENCY RANGE	1GHz ~ 25GHz		Average (AV)

ANTENNA POLARITY & TEST DISTANCE: HORIZONTAL AT 3 M

NO.	FREQ. (MHz)	EMISSION LEVEL (dBuV/m)	LIMIT (dBuV/m)	MARGIN (dB)	ANTENNA HEIGHT (m)	TABLE ANGLE (Degree)	RAW VALUE (dBuV)	CORRECTION FACTOR (dB/m)
1	*2452.00	101.2 PK			1.55 H	49	69.30	31.90
2	*2452.00	92.1 AV			1.55 H	49	60.20	31.90
3	2483.50	65.6 PK	74.0	-8.4	1.37 H	62	33.60	32.00
4	2483.50	53.0 AV	54.0	-1.0	1.37 H	62	21.00	32.00
5	4904.00	46.5 PK	74.0	-27.5	1.32 H	69	41.50	5.00
6	4904.00	33.4 AV	54.0	-20.6	1.32 H	69	28.40	5.00

ANTENNA POLARITY & TEST DISTANCE: VERTICAL AT 3 M

NO.	FREQ. (MHz)	EMISSION LEVEL (dBuV/m)	LIMIT (dBuV/m)	MARGIN (dB)	ANTENNA HEIGHT (m)	TABLE ANGLE (Degree)	RAW VALUE (dBuV)	CORRECTION FACTOR (dB/m)
1	*2452.00	93.6 PK			1.47 V	181	61.70	31.90
2	*2452.00	84.3 AV			1.47 V	181	52.40	31.90
3	2483.50	58.9 PK	74.0	-15.1	1.50 V	190	26.90	32.00
4	2483.50	46.8 AV	54.0	-7.2	1.50 V	190	14.80	32.00
5	4904.00	46.5 PK	74.0	-27.5	1.32 V	64	41.50	5.00
6	4904.00	32.4 AV	54.0	-21.6	1.32 V	64	27.40	5.00

REMARKS:

1. Emission Level(dBuV/m) = Raw Value(dBuV) + Correction Factor(dB/m)
2. Correction Factor(dB/m) = Antenna Factor(dB/m) + Cable Factor(dB)
3. The other emission levels were very low against the limit.
4. Margin value = Emission Level – Limit value
5. " * ": Fundamental frequency.

Below 1GHz Worst-Case Data

Test Mode A

802.11g

CHANNEL	TX Channel 6	DETECTOR FUNCTION	Quasi-Peak (QP)
FREQUENCY RANGE	30MHz ~ 1GHz		

ANTENNA POLARITY & TEST DISTANCE: HORIZONTAL AT 3 M

NO.	FREQ. (MHz)	EMISSION LEVEL (dBuV/m)	LIMIT (dBuV/m)	MARGIN (dB)	ANTENNA HEIGHT (m)	TABLE ANGLE (Degree)	RAW VALUE (dBuV)	CORRECTION FACTOR (dB/m)
1	37.66	32.7 QP	40.0	-7.3	1.50 H	275	47.40	-14.70
2	148.26	30.6 QP	43.5	-12.9	1.24 H	254	44.30	-13.70
3	187.07	37.6 QP	43.5	-5.9	1.50 H	125	53.60	-16.00
4	198.71	38.9 QP	43.5	-4.6	1.24 H	264	55.50	-16.60
5	400.52	30.9 QP	46.0	-15.1	2.00 H	152	42.10	-11.20
6	794.42	28.8 QP	46.0	-17.2	2.00 H	344	32.00	-3.20

ANTENNA POLARITY & TEST DISTANCE: VERTICAL AT 3 M

NO.	FREQ. (MHz)	EMISSION LEVEL (dBuV/m)	LIMIT (dBuV/m)	MARGIN (dB)	ANTENNA HEIGHT (m)	TABLE ANGLE (Degree)	RAW VALUE (dBuV)	CORRECTION FACTOR (dB/m)
1	33.78	34.7 QP	40.0	-5.3	1.00 V	344	49.70	-15.00
2	62.89	35.7 QP	40.0	-4.3	1.24 V	263	50.40	-14.70
3	185.13	31.1 QP	43.5	-12.4	1.00 V	13	46.90	-15.80
4	210.36	31.3 QP	43.5	-12.2	1.00 V	176	47.80	-16.50
5	425.74	32.7 QP	46.0	-13.3	1.00 V	193	43.30	-10.60
6	544.11	29.4 QP	46.0	-16.6	1.00 V	198	38.20	-8.80

REMARKS:

1. Emission Level(dBuV/m) = Raw Value(dBuV) + Correction Factor(dB/m)
2. Correction Factor(dB/m) = Antenna Factor(dB/m) + Cable Factor(dB)
3. The other emission levels were very low against the limit.
4. Margin value = Emission Level – Limit value

Test Mode B

802.11g

CHANNEL	TX Channel 6	DETECTOR FUNCTION	Quasi-Peak (QP)
FREQUENCY RANGE	30MHz ~ 1GHz		

ANTENNA POLARITY & TEST DISTANCE: HORIZONTAL AT 3 M

NO.	FREQ. (MHz)	EMISSION LEVEL (dBuV/m)	LIMIT (dBuV/m)	MARGIN (dB)	ANTENNA HEIGHT (m)	TABLE ANGLE (Degree)	RAW VALUE (dBuV)	CORRECTION FACTOR (dB/m)
1	37.66	32.2 QP	40.0	-7.8	1.50 H	50	46.90	-14.70
2	62.89	26.9 QP	40.0	-13.1	1.50 H	276	41.60	-14.70
3	97.81	28.2 QP	43.5	-15.3	1.75 H	88	47.00	-18.80
4	138.56	30.2 QP	43.5	-13.3	1.00 H	264	44.70	-14.50
5	198.71	39.7 QP	43.5	-3.8	1.00 H	274	56.30	-16.60
6	307.38	30.2 QP	46.0	-15.8	1.00 H	138	42.80	-12.60

ANTENNA POLARITY & TEST DISTANCE: VERTICAL AT 3 M

NO.	FREQ. (MHz)	EMISSION LEVEL (dBuV/m)	LIMIT (dBuV/m)	MARGIN (dB)	ANTENNA HEIGHT (m)	TABLE ANGLE (Degree)	RAW VALUE (dBuV)	CORRECTION FACTOR (dB/m)
1	33.78	34.2 QP	40.0	-5.8	1.00 V	9	49.20	-15.00
2	62.89	34.8 QP	40.0	-5.2	1.00 V	358	49.50	-14.70
3	132.74	29.8 QP	43.5	-13.7	2.00 V	156	44.70	-14.90
4	198.71	39.9 QP	43.5	-3.6	1.00 V	146	56.50	-16.60
5	272.45	30.8 QP	46.0	-15.2	1.50 V	224	44.20	-13.40
6	600.38	29.2 QP	46.0	-16.8	1.00 V	32	36.30	-7.10

REMARKS:

1. Emission Level(dBuV/m) = Raw Value(dBuV) + Correction Factor(dB/m)
2. Correction Factor(dB/m) = Antenna Factor(dB/m) + Cable Factor(dB)
3. The other emission levels were very low against the limit.
4. Margin value = Emission Level – Limit value

Test Mode C
802.11g

CHANNEL	TX Channel 6	DETECTOR FUNCTION	Quasi-Peak (QP)
FREQUENCY RANGE	30MHz ~ 1GHz		

ANTENNA POLARITY & TEST DISTANCE: HORIZONTAL AT 3 M

NO.	FREQ. (MHz)	EMISSION LEVEL (dBuV/m)	LIMIT (dBuV/m)	MARGIN (dB)	ANTENNA HEIGHT (m)	TABLE ANGLE (Degree)	RAW VALUE (dBuV)	CORRECTION FACTOR (dB/m)
1	37.66	34.7 QP	40.0	-5.3	1.24 H	250	49.40	-14.70
2	150.20	30.8 QP	43.5	-12.7	1.50 H	282	44.50	-13.70
3	187.07	35.3 QP	43.5	-8.2	1.24 H	105	51.30	-16.00
4	198.71	39.9 QP	43.5	-3.6	1.24 H	256	56.50	-16.60
5	398.58	30.5 QP	46.0	-15.5	1.00 H	272	41.70	-11.20
6	547.99	24.9 QP	46.0	-21.1	1.00 H	279	33.60	-8.70

ANTENNA POLARITY & TEST DISTANCE: VERTICAL AT 3 M

NO.	FREQ. (MHz)	EMISSION LEVEL (dBuV/m)	LIMIT (dBuV/m)	MARGIN (dB)	ANTENNA HEIGHT (m)	TABLE ANGLE (Degree)	RAW VALUE (dBuV)	CORRECTION FACTOR (dB/m)
1	31.84	34.8 QP	40.0	-5.2	1.00 V	112	50.20	-15.40
2	51.24	36.3 QP	40.0	-3.7	1.00 V	104	50.20	-13.90
3	198.71	31.6 QP	43.5	-11.9	1.00 V	125	48.20	-16.60
4	427.68	32.3 QP	46.0	-13.7	1.00 V	180	42.80	-10.50
5	499.48	28.6 QP	46.0	-17.4	1.75 V	197	38.00	-9.40
6	546.05	29.9 QP	46.0	-16.1	1.00 V	345	38.70	-8.80

REMARKS:

1. Emission Level(dBuV/m) = Raw Value(dBuV) + Correction Factor(dB/m)
2. Correction Factor(dB/m) = Antenna Factor(dB/m) + Cable Factor(dB)
3. The other emission levels were very low against the limit.
4. Margin value = Emission Level – Limit value

Test Mode D

802.11g

CHANNEL	TX Channel 6	DETECTOR FUNCTION	Quasi-Peak (QP)
FREQUENCY RANGE	30MHz ~ 1GHz		

ANTENNA POLARITY & TEST DISTANCE: HORIZONTAL AT 3 M

NO.	FREQ. (MHz)	EMISSION LEVEL (dBuV/m)	LIMIT (dBuV/m)	MARGIN (dB)	ANTENNA HEIGHT (m)	TABLE ANGLE (Degree)	RAW VALUE (dBuV)	CORRECTION FACTOR (dB/m)
1	37.66	32.3 QP	40.0	-7.7	1.50 H	7	47.00	-14.70
2	97.81	27.5 QP	43.5	-16.0	1.50 H	122	46.30	-18.80
3	144.38	28.8 QP	43.5	-14.7	1.00 H	101	42.80	-14.00
4	198.71	39.9 QP	43.5	-3.6	1.50 H	126	56.50	-16.60
5	307.38	31.2 QP	46.0	-14.8	1.00 H	144	43.80	-12.60
6	794.42	27.8 QP	46.0	-18.2	1.25 H	12	31.00	-3.20

ANTENNA POLARITY & TEST DISTANCE: VERTICAL AT 3 M

NO.	FREQ. (MHz)	EMISSION LEVEL (dBuV/m)	LIMIT (dBuV/m)	MARGIN (dB)	ANTENNA HEIGHT (m)	TABLE ANGLE (Degree)	RAW VALUE (dBuV)	CORRECTION FACTOR (dB/m)
1	33.78	34.9 QP	40.0	-5.1	1.50 V	131	49.90	-15.00
2	62.89	33.9 QP	40.0	-6.1	1.00 V	3	48.60	-14.70
3	136.62	28.6 QP	43.5	-14.9	3.00 V	138	43.30	-14.70
4	198.71	39.5 QP	43.5	-4.0	1.00 V	227	56.10	-16.60
5	357.83	29.4 QP	46.0	-16.6	1.00 V	172	41.40	-12.00
6	794.42	29.9 QP	46.0	-16.1	1.50 V	346	33.10	-3.20

REMARKS:

1. Emission Level(dBuV/m) = Raw Value(dBuV) + Correction Factor(dB/m)
2. Correction Factor(dB/m) = Antenna Factor(dB/m) + Cable Factor(dB)
3. The other emission levels were very low against the limit.
4. Margin value = Emission Level – Limit value

4.2 Conducted Emission Measurement

4.2.1 Limits of Conducted Emission Measurement

Frequency (MHz)	Conducted Limit (dBuV)	
	Quasi-peak	Average
0.15 - 0.5	66 - 56	56 - 46
0.50 - 5.0	56	46
5.0 - 30.0	60	50

- Note:** 1. The lower limit shall apply at the transition frequencies.
 2. The limit decreases in line with the logarithm of the frequency in the range of 0.15 to 0.50MHz.

4.2.2 Test Instruments

Description & Manufacturer	Model No.	Serial No.	Cal. Date	Cal. Due
Test Receiver ROHDE & SCHWARZ	ESCS 30	100288	Apr. 27, 2015	Apr. 26, 2016
RF signal cable (with 10dB PAD) Woken	5D-FB	Cable-cond2-01	Dec. 26, 2015	Dec. 25, 2016
LISN ROHDE & SCHWARZ (EUT)	ESH3-Z5	835239/001	Feb. 26, 2015	Feb. 25, 2016
LISN ROHDE & SCHWARZ (Peripheral)	ESH3-Z5	100312	Jul. 21, 2015	Jul. 20, 2016
Software ADT	BV ADT_Cond_ V7.3.7.3	NA	NA	NA

- Note:** 1. The calibration interval of the above test instruments is 12 months and the calibrations are traceable to NML/ROC and NIST/USA.
 2. The test was performed in HwaYa Shielded Room 2.
 3. The VCCI Site Registration No. is C-2047.

4.2.3 Test Procedures

- a. The EUT was placed 0.4 meters from the conducting wall of the shielded room with EUT being connected to the power mains through a line impedance stabilization network (LISN). Other support units were connected to the power mains through another LISN. The two LISNs provide 50 ohm/ 50uH of coupling impedance for the measuring instrument.
- b. Both lines of the power mains connected to the EUT were checked for maximum conducted interference.
- c. The frequency range from 150kHz to 30MHz was searched. Emission levels under (Limit - 20dB) was not recorded.

Note: The resolution bandwidth and video bandwidth of test receiver is 9kHz for quasi-peak detection (QP) and average detection (AV) at frequency 0.15MHz-30MHz.

4.2.4 Deviation from Test Standard

No deviation.

4.2.5 Test Setup

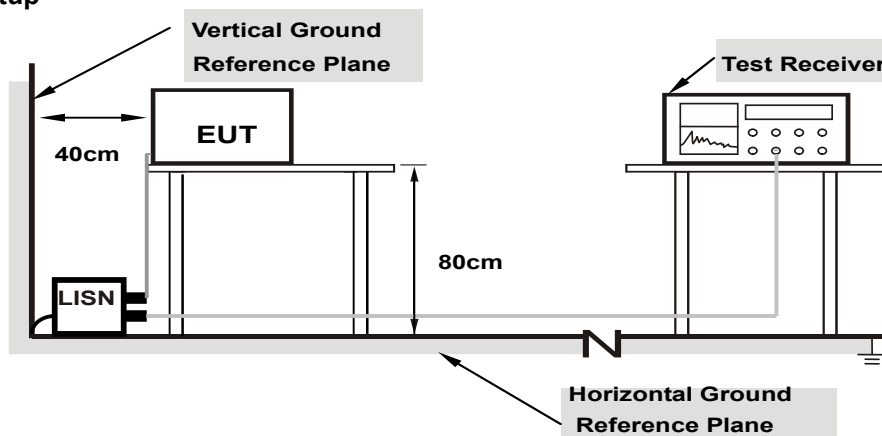

Note: 1.Support units were connected to second LISN.

For the actual test configuration, please refer to the attached file (Test Setup Photo).

4.2.6 EUT Operating Conditions

Same as 4.1.6.

4.2.7 Test Results

Phase	Line (L)	Detector Function	Quasi-Peak (QP) / Average (AV)
Test Mode	A		

No	Freq. [MHz]	Corr. Factor (dB)	Reading Value [dB (uV)]		Emission Level [dB (uV)]		Limit [dB (uV)]		Margin (dB)	
			Q.P.	AV.	Q.P.	AV.	Q.P.	AV.	Q.P.	AV.
			1	0.16172	10.10	37.44	25.04	47.54	35.14	65.38
2	0.39219	10.15	38.99	34.81	49.14	44.96	58.02	48.02	-8.88	-3.06
3	0.70469	10.17	22.06	11.83	32.23	22.00	56.00	46.00	-23.77	-24.00
4	1.44531	10.22	18.83	12.09	29.05	22.31	56.00	46.00	-26.95	-23.69
5	4.61328	10.33	15.01	7.90	25.34	18.23	56.00	46.00	-30.66	-27.77
6	12.04688	10.47	5.51	-0.19	15.98	10.28	60.00	50.00	-44.02	-39.72

REMARKS:

1. Q.P. and AV. are abbreviations of quasi-peak and average individually.
2. The emission levels of other frequencies were very low against the limit.
3. Margin value = Emission level - Limit value
4. Correction factor = Insertion loss + Cable loss
5. Emission Level = Correction Factor + Reading Value.

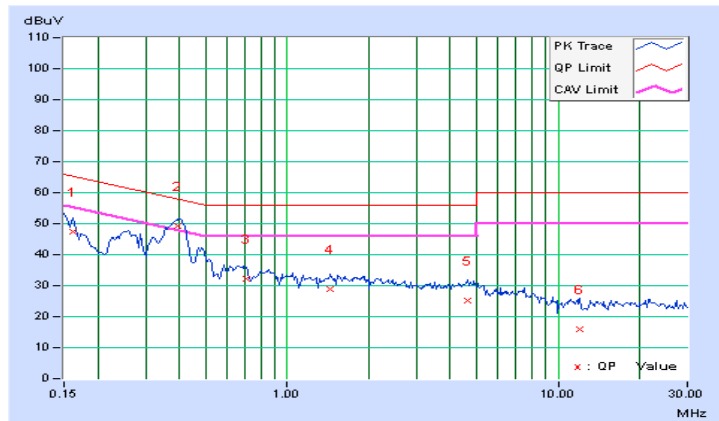

Phase	Neutral (N)	Detector Function	Quasi-Peak (QP) / Average (AV)
Test Mode	A		

No	Freq. [MHz]	Corr. Factor (dB)	Reading Value [dB (uV)]		Emission Level [dB (uV)]		Limit [dB (uV)]		Margin (dB)	
			Q.P.	AV.	Q.P.	AV.	Q.P.	AV.	Q.P.	AV.
			1	0.16172	10.11	38.29	24.92	48.40	35.03	65.38
2	0.40391	10.17	39.54	29.14	49.71	39.31	57.77	47.77	-8.06	-8.46
3	0.61094	10.18	24.05	17.67	34.23	27.85	56.00	46.00	-21.77	-18.15
4	1.20313	10.21	20.36	14.40	30.57	24.61	56.00	46.00	-25.43	-21.39
5	2.36719	10.28	17.39	10.70	27.67	20.98	56.00	46.00	-28.33	-25.02
6	11.58984	10.56	11.59	6.55	22.15	17.11	60.00	50.00	-37.85	-32.89

REMARKS:

1. Q.P. and AV. are abbreviations of quasi-peak and average individually.
2. The emission levels of other frequencies were very low against the limit.
3. Margin value = Emission level - Limit value
4. Correction factor = Insertion loss + Cable loss
5. Emission Level = Correction Factor + Reading Value.

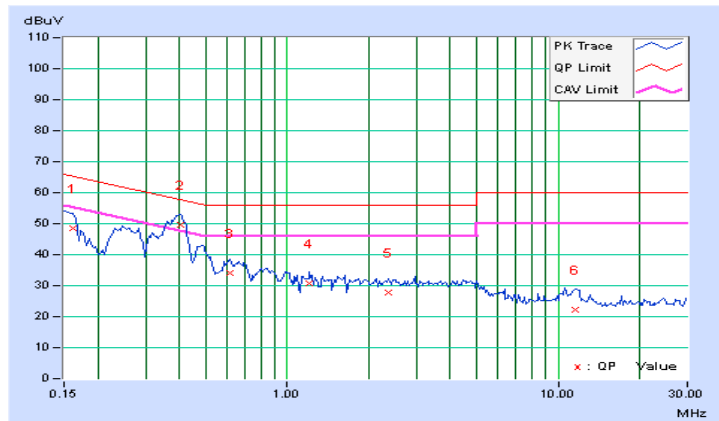

Phase	Line (L)	Detector Function	Quasi-Peak (QP) / Average (AV)
Test Mode	B		

No	Freq. [MHz]	Corr. Factor (dB)	Reading Value [dB (uV)]		Emission Level [dB (uV)]		Limit [dB (uV)]		Margin (dB)	
			Q.P.	AV.	Q.P.	AV.	Q.P.	AV.	Q.P.	AV.
			1	0.15391	10.10	38.50	22.60	48.60	32.70	65.79
2	0.19687	10.11	35.38	22.62	45.49	32.73	63.74	53.74	-18.25	-21.01
3	0.41172	10.15	29.88	24.57	40.03	34.72	57.61	47.61	-17.58	-12.89
4	1.16797	10.20	15.89	9.05	26.09	19.25	56.00	46.00	-29.91	-26.75
5	7.04297	10.39	14.15	8.71	24.54	19.10	60.00	50.00	-35.46	-30.90
6	24.16797	10.48	21.69	16.41	32.17	26.89	60.00	50.00	-27.83	-23.11

REMARKS:

1. Q.P. and AV. are abbreviations of quasi-peak and average individually.
2. The emission levels of other frequencies were very low against the limit.
3. Margin value = Emission level - Limit value
4. Correction factor = Insertion loss + Cable loss
5. Emission Level = Correction Factor + Reading Value.

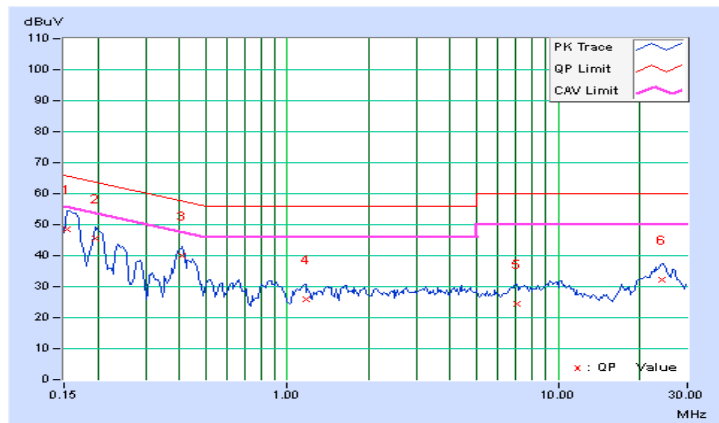

Phase	Neutral (N)	Detector Function	Quasi-Peak (QP) / Average (AV)
Test Mode	B		

No	Freq. [MHz]	Corr. Factor (dB)	Reading Value [dB (uV)]		Emission Level [dB (uV)]		Limit [dB (uV)]		Margin (dB)	
			Q.P.	AV.	Q.P.	AV.	Q.P.	AV.	Q.P.	AV.
			1	0.16172	10.11	40.65	31.47	50.76	41.58	65.38
2	0.20078	10.12	34.42	25.58	44.54	35.70	63.58	53.58	-19.04	-17.88
3	0.41172	10.17	28.77	22.72	38.94	32.89	57.61	47.61	-18.67	-14.72
4	0.86875	10.19	16.43	9.48	26.62	19.67	56.00	46.00	-29.38	-26.33
5	7.52734	10.46	13.78	8.46	24.24	18.92	60.00	50.00	-35.76	-31.08
6	23.89844	10.64	21.16	15.79	31.80	26.43	60.00	50.00	-28.20	-23.57

REMARKS:

1. Q.P. and AV. are abbreviations of quasi-peak and average individually.
2. The emission levels of other frequencies were very low against the limit.
3. Margin value = Emission level - Limit value
4. Correction factor = Insertion loss + Cable loss
5. Emission Level = Correction Factor + Reading Value.

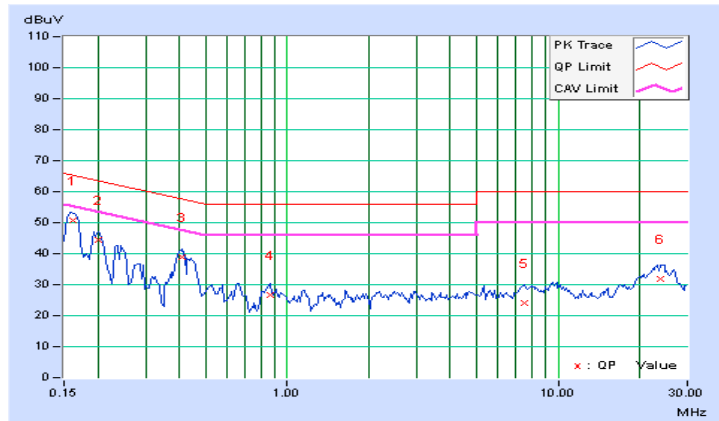

Phase	Line (L)	Detector Function	Quasi-Peak (QP) / Average (AV)
Test Mode	C		

No	Freq. [MHz]	Corr. Factor (dB)	Reading Value [dB (uV)]		Emission Level [dB (uV)]		Limit [dB (uV)]		Margin (dB)	
			Q.P.	AV.	Q.P.	AV.	Q.P.	AV.	Q.P.	AV.
			1	0.15000	10.10	39.60	30.98	49.70	41.08	66.00
2	0.39219	10.15	39.01	34.67	49.16	44.82	58.02	48.02	-8.86	-3.20
3	0.69688	10.17	22.60	14.48	32.77	24.65	56.00	46.00	-23.23	-21.35
4	1.97266	10.25	18.33	12.41	28.58	22.66	56.00	46.00	-27.42	-23.34
5	4.85938	10.34	15.80	8.78	26.14	19.12	56.00	46.00	-29.86	-26.88
6	17.82031	10.54	0.81	-3.50	11.35	7.04	60.00	50.00	-48.65	-42.96

REMARKS:

1. Q.P. and AV. are abbreviations of quasi-peak and average individually.
2. The emission levels of other frequencies were very low against the limit.
3. Margin value = Emission level - Limit value
4. Correction factor = Insertion loss + Cable loss
5. Emission Level = Correction Factor + Reading Value.

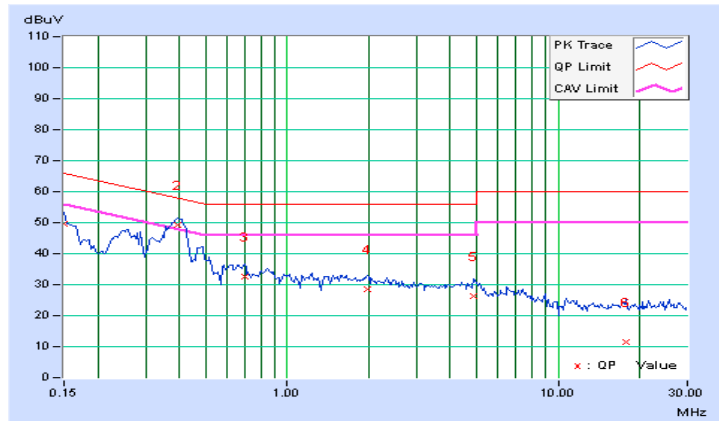

Phase	Neutral (N)	Detector Function	Quasi-Peak (QP) / Average (AV)
Test Mode	C		

No	Freq. [MHz]	Corr. Factor (dB)	Reading Value [dB (uV)]		Emission Level [dB (uV)]		Limit [dB (uV)]		Margin (dB)	
			Q.P.	AV.	Q.P.	AV.	Q.P.	AV.	Q.P.	AV.
			1	0.15391	10.11	39.36	28.37	49.47	38.48	65.79
2	0.40000	10.17	39.48	29.97	49.65	40.14	57.85	47.85	-8.20	-7.71
3	0.66172	10.18	24.30	16.86	34.48	27.04	56.00	46.00	-21.52	-18.96
4	1.59375	10.24	18.99	12.89	29.23	23.13	56.00	46.00	-26.77	-22.87
5	4.51563	10.37	16.35	10.38	26.72	20.75	56.00	46.00	-29.28	-25.25
6	11.20703	10.56	11.48	6.46	22.04	17.02	60.00	50.00	-37.96	-32.98

REMARKS:

1. Q.P. and AV. are abbreviations of quasi-peak and average individually.
2. The emission levels of other frequencies were very low against the limit.
3. Margin value = Emission level - Limit value
4. Correction factor = Insertion loss + Cable loss
5. Emission Level = Correction Factor + Reading Value.

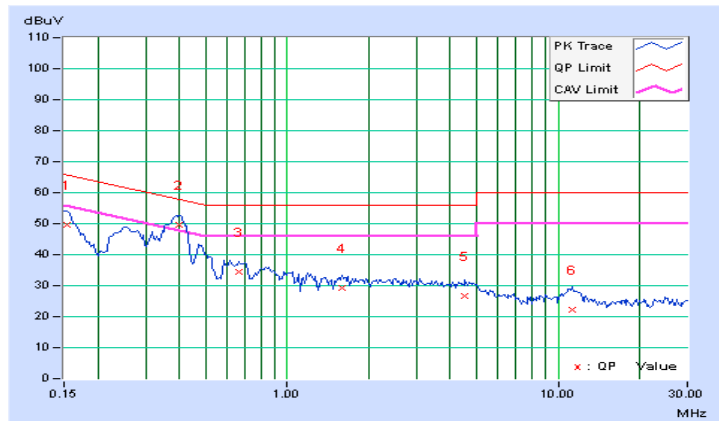

Phase	Line (L)	Detector Function	Quasi-Peak (QP) / Average (AV)
Test Mode	D		

No	Freq. [MHz]	Corr. Factor (dB)	Reading Value [dB (uV)]		Emission Level [dB (uV)]		Limit [dB (uV)]		Margin (dB)	
			Q.P.	AV.	Q.P.	AV.	Q.P.	AV.	Q.P.	AV.
			1	0.16172	10.10	39.41	30.27	49.51	40.37	65.38
2	0.20469	10.11	33.53	26.40	43.64	36.51	63.42	53.42	-19.78	-16.91
3	0.40391	10.15	30.76	25.38	40.91	35.53	57.77	47.77	-16.86	-12.24
4	0.86875	10.18	18.13	11.45	28.31	21.63	56.00	46.00	-27.69	-24.37
5	4.82422	10.34	13.71	7.92	24.05	18.26	56.00	46.00	-31.95	-27.74
6	23.60547	10.49	21.75	16.23	32.24	26.72	60.00	50.00	-27.76	-23.28

REMARKS:

1. Q.P. and AV. are abbreviations of quasi-peak and average individually.
2. The emission levels of other frequencies were very low against the limit.
3. Margin value = Emission level - Limit value
4. Correction factor = Insertion loss + Cable loss
5. Emission Level = Correction Factor + Reading Value.

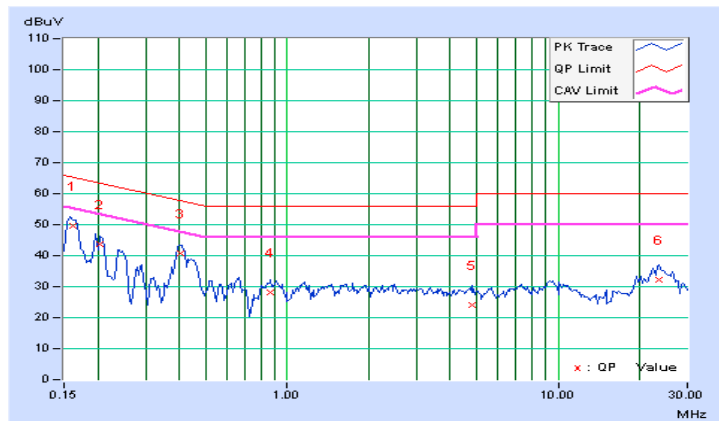

Phase	Neutral (N)	Detector Function	Quasi-Peak (QP) / Average (AV)
Test Mode	D		

No	Freq. [MHz]	Corr. Factor (dB)	Reading Value [dB (uV)]		Emission Level [dB (uV)]		Limit [dB (uV)]		Margin (dB)	
			Q.P.	AV.	Q.P.	AV.	Q.P.	AV.	Q.P.	AV.
			1	0.15781	10.11	38.90	25.91	49.01	36.02	65.58
2	0.19687	10.12	33.23	19.79	43.35	29.91	63.74	53.74	-20.39	-23.83
3	0.40781	10.17	29.33	24.20	39.50	34.37	57.69	47.69	-18.19	-13.32
4	1.45703	10.23	13.71	5.53	23.94	15.76	56.00	46.00	-32.06	-30.24
5	7.52344	10.46	14.21	8.79	24.67	19.25	60.00	50.00	-35.33	-30.75
6	23.88281	10.64	21.65	16.37	32.29	27.01	60.00	50.00	-27.71	-22.99

REMARKS:

1. Q.P. and AV. are abbreviations of quasi-peak and average individually.
2. The emission levels of other frequencies were very low against the limit.
3. Margin value = Emission level - Limit value
4. Correction factor = Insertion loss + Cable loss
5. Emission Level = Correction Factor + Reading Value.

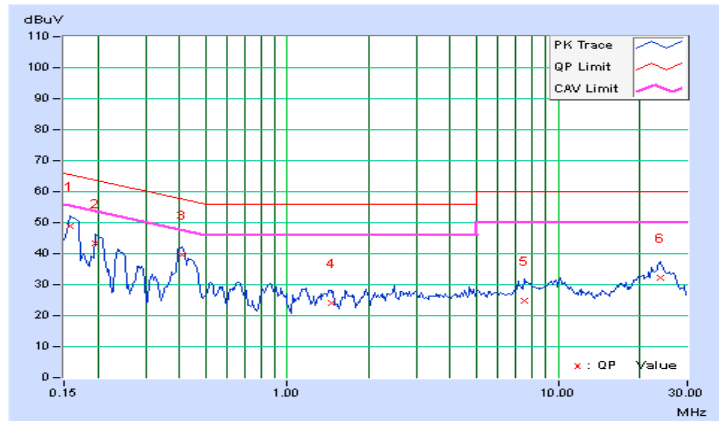

4.3 6dB Bandwidth Measurement

4.3.1 Limits of 6dB Bandwidth Measurement

The minimum of 6dB Bandwidth Measurement is 0.5 MHz.

4.3.2 Test Setup

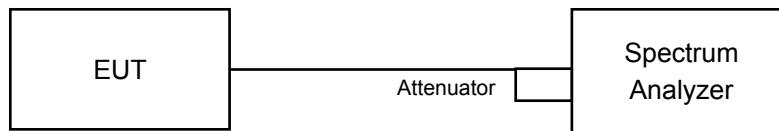

4.3.3 Test Instruments

Refer to section 4.1.2 to get information of above instrument.

4.3.4 Test Procedure

- Set resolution bandwidth (RBW) = 100kHz
- Set the video bandwidth (VBW) $\geq 3 \times$ RBW, Detector = Peak.
- Trace mode = max hold.
- Sweep = auto couple.
- Measure the maximum width of the emission that is constrained by the frequencies associated with the two amplitude points (upper and lower) that are attenuated by 6 dB relative to the maximum level measured in the fundamental emission

4.3.5 Deviation from Test Standard

No deviation.

4.3.6 EUT Operating Conditions

The software provided by client to enable the EUT under transmission condition continuously at lowest, middle and highest channel frequencies individually.

4.3.7 Test Result

Test Mode A

1TX

802.11b

Channel	Frequency (MHz)	6dB Bandwidth (MHz)	Minimum Limit (MHz)	Pass / Fail
1	2412	8.07	0.5	Pass
6	2437	8.07	0.5	Pass
11	2462	8.06	0.5	Pass

802.11g

Channel	Frequency (MHz)	6dB Bandwidth (MHz)	Minimum Limit (MHz)	Pass / Fail
1	2412	15.17	0.5	Pass
6	2437	15.16	0.5	Pass
11	2462	15.15	0.5	Pass

802.11n (HT20)

Channel	Frequency (MHz)	6dB Bandwidth (MHz)	Minimum Limit (MHz)	Pass / Fail
1	2412	15.17	0.5	Pass
6	2437	15.14	0.5	Pass
11	2462	15.15	0.5	Pass

802.11n (HT40)

Channel	Frequency (MHz)	6dB Bandwidth (MHz)	Minimum Limit (MHz)	Pass / Fail
3	2422	36.46	0.5	Pass
6	2437	36.45	0.5	Pass
9	2452	36.41	0.5	Pass

Spectrum Plot of Worst Value

802.11b

802.11g

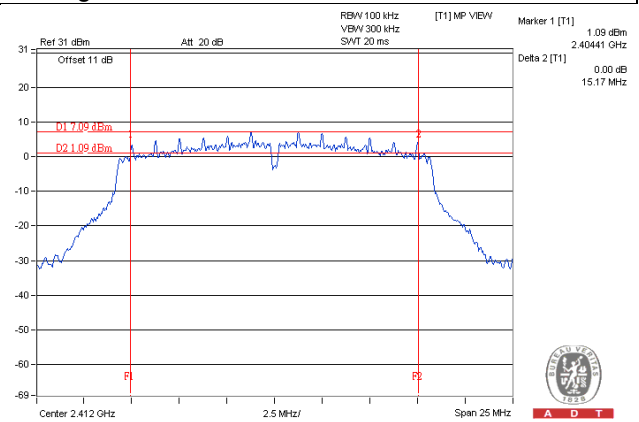
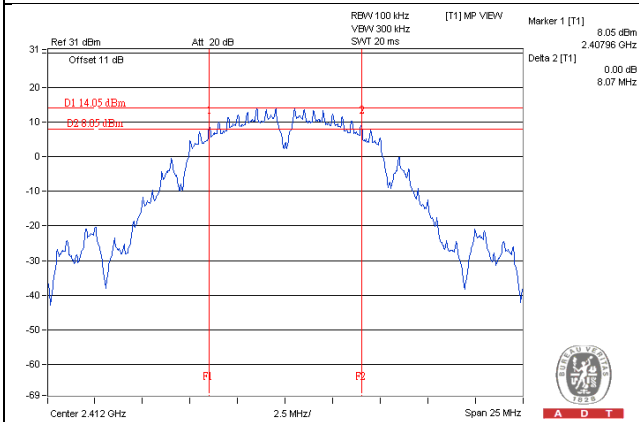

802.11n (HT20)

802.11n (HT40)

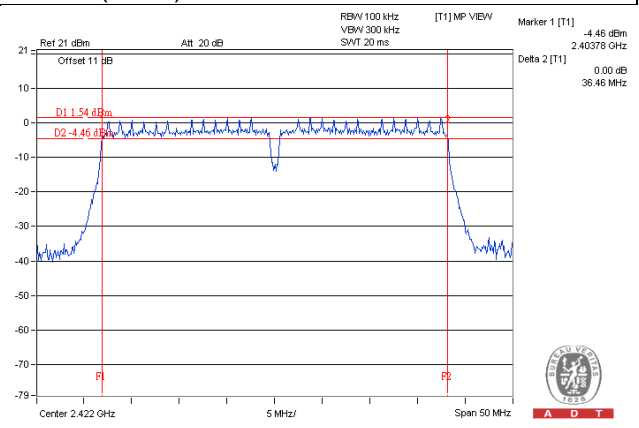
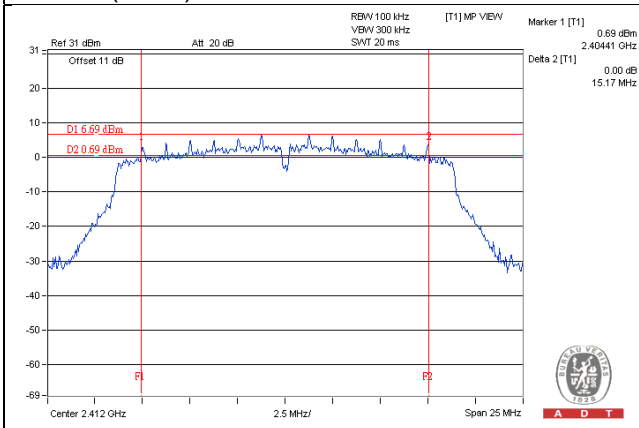

Test Mode A
2TX
802.11b

Channel	Frequency (MHz)	6dB Bandwidth (MHz)		Minimum Limit (MHz)	Pass / Fail
		Chain 0	Chain 1		
1	2412	8.08	8.07	0.5	Pass
6	2437	8.08	8.09	0.5	Pass
11	2462	8.09	8.07	0.5	Pass

802.11g

Channel	Frequency (MHz)	6dB Bandwidth (MHz)		Minimum Limit (MHz)	Pass / Fail
		Chain 0	Chain 1		
1	2412	15.18	15.17	0.5	Pass
6	2437	15.17	15.16	0.5	Pass
11	2462	15.16	15.17	0.5	Pass

802.11n (HT20)

Channel	Frequency (MHz)	6dB Bandwidth (MHz)		Minimum Limit (MHz)	Pass / Fail
		Chain 0	Chain 1		
1	2412	15.14	15.76	0.5	Pass
6	2437	15.17	15.74	0.5	Pass
11	2462	15.18	15.74	0.5	Pass

802.11n (HT40)

Channel	Frequency (MHz)	6dB Bandwidth (MHz)		Minimum Limit (MHz)	Pass / Fail
		Chain 0	Chain 1		
3	2422	36.45	36.50	0.5	Pass
6	2437	36.43	36.45	0.5	Pass
9	2452	36.42	36.47	0.5	Pass

Spectrum Plot of Worst Value

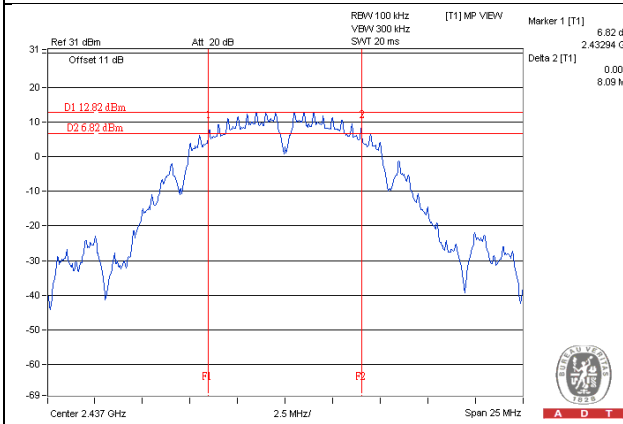
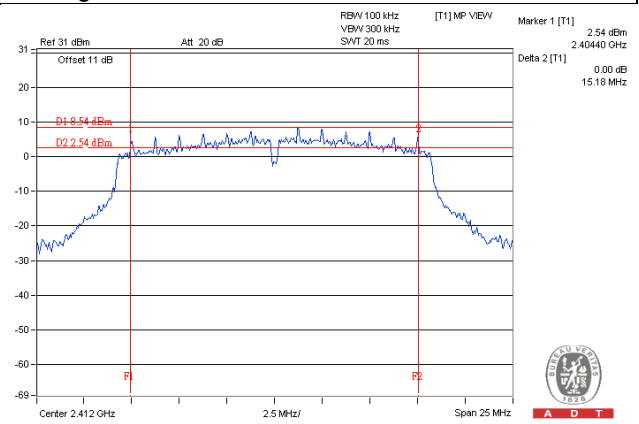
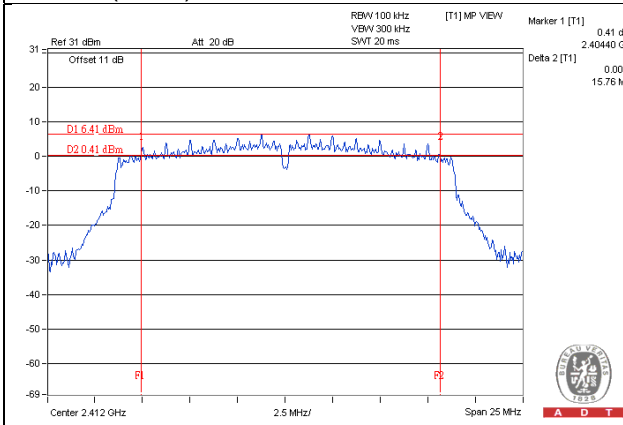
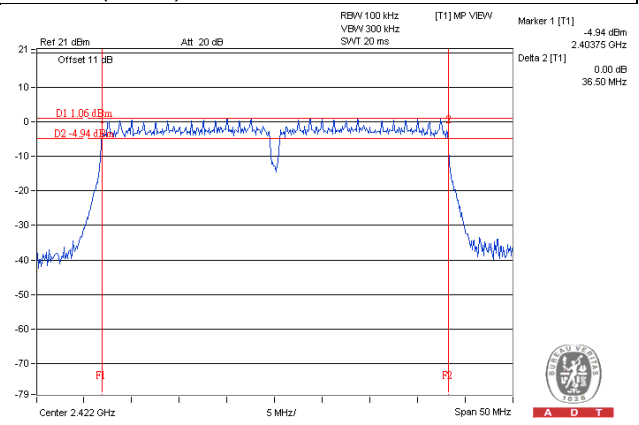
802.11b**802.11g****802.11n (HT20)****802.11n (HT40)**

Test Mode A
3TX
802.11b

Channel	Frequency (MHz)	6dB Bandwidth (MHz)			Minimum Limit (MHz)	Pass / Fail
		Chain 0	Chain 1	Chain 2		
1	2412	8.06	8.10	8.08	0.5	Pass
6	2437	8.06	8.07	8.07	0.5	Pass
11	2462	8.07	8.05	8.07	0.5	Pass

802.11b

Channel	Frequency (MHz)	6dB Bandwidth (MHz)			Minimum Limit (MHz)	Pass / Fail
		Chain 0	Chain 1	Chain 2		
1	2412	15.17	15.18	15.17	0.5	Pass
6	2437	15.16	15.17	15.15	0.5	Pass
11	2462	15.16	15.17	15.17	0.5	Pass

802.11n (HT20)

Channel	Frequency (MHz)	6dB Bandwidth (MHz)			Minimum Limit (MHz)	Pass / Fail
		Chain 0	Chain 1	Chain 2		
1	2412	15.17	15.19	15.19	0.5	Pass
6	2437	15.17	15.17	15.14	0.5	Pass
11	2462	15.15	15.17	15.72	0.5	Pass

802.11n (HT40)

Channel	Frequency (MHz)	6dB Bandwidth (MHz)			Minimum Limit (MHz)	Pass / Fail
		Chain 0	Chain 1	Chain 2		
3	2422	36.44	36.44	36.47	0.5	Pass
6	2437	36.41	36.41	36.42	0.5	Pass
9	2452	36.40	36.43	36.43	0.5	Pass

Spectrum Plot of Worst Value

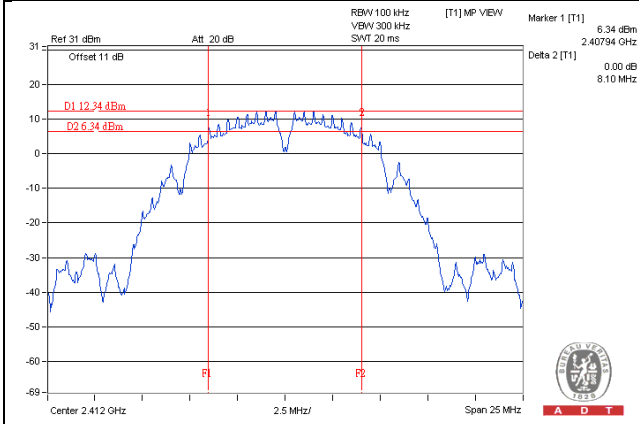
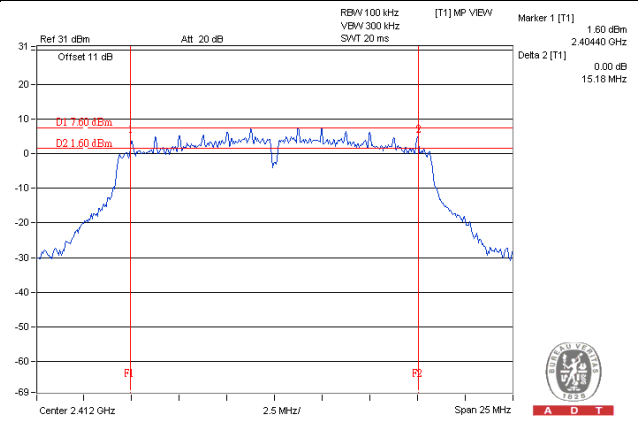
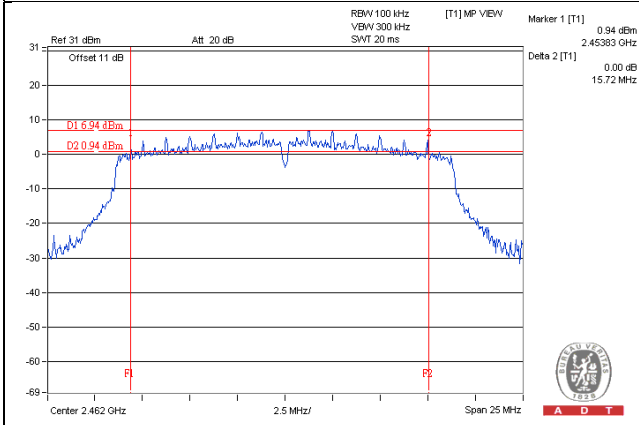
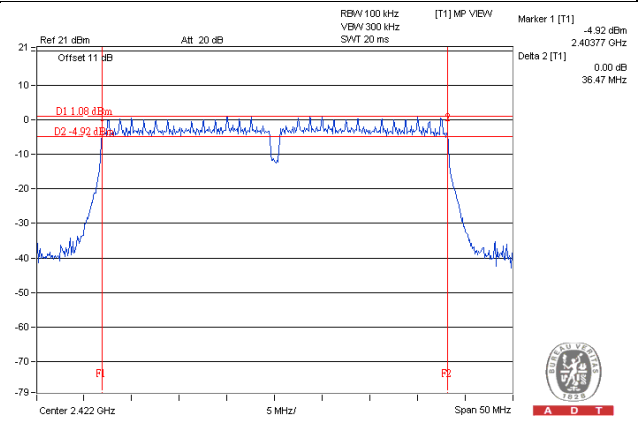
802.11b**802.11g****802.11n (HT20)****802.11n (HT40)**

Test Mode A
4TX
802.11b

Channel	Frequency (MHz)	6dB Bandwidth (MHz)				Minimum Limit (MHz)	Pass / Fail
		Chain 0	Chain 1	Chain 2	Chain 3		
1	2412	8.07	8.08	8.09	8.06	0.5	Pass
6	2437	8.10	8.09	8.06	8.08	0.5	Pass
11	2462	8.08	8.07	8.07	8.07	0.5	Pass

802.11g

Channel	Frequency (MHz)	6dB Bandwidth (MHz)				Minimum Limit (MHz)	Pass / Fail
		Chain 0	Chain 1	Chain 2	Chain 3		
1	2412	15.18	15.17	15.19	15.16	0.5	Pass
6	2437	15.17	15.18	15.16	15.14	0.5	Pass
11	2462	15.48	15.17	15.15	15.16	0.5	Pass

802.11n (HT20)

Channel	Frequency (MHz)	6dB Bandwidth (MHz)				Minimum Limit (MHz)	Pass / Fail
		Chain 0	Chain 1	Chain 2	Chain 3		
1	2412	15.21	15.76	15.19	15.76	0.5	Pass
6	2437	15.13	15.18	15.17	15.73	0.5	Pass
11	2462	15.16	15.76	15.15	15.69	0.5	Pass

802.11n (HT40)

Channel	Frequency (MHz)	6dB Bandwidth (MHz)				Minimum Limit (MHz)	Pass / Fail
		Chain 0	Chain 1	Chain 2	Chain 3		
3	2422	36.47	36.51	36.47	36.48	0.5	Pass
6	2437	36.41	36.44	36.44	36.43	0.5	Pass
9	2452	36.42	36.48	36.44	36.42	0.5	Pass

Spectrum Plot of Worst Value

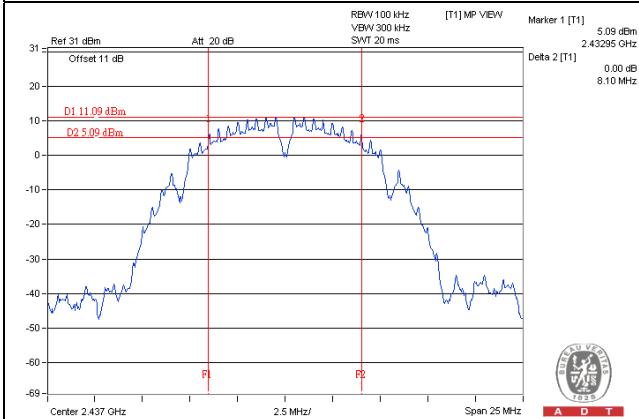
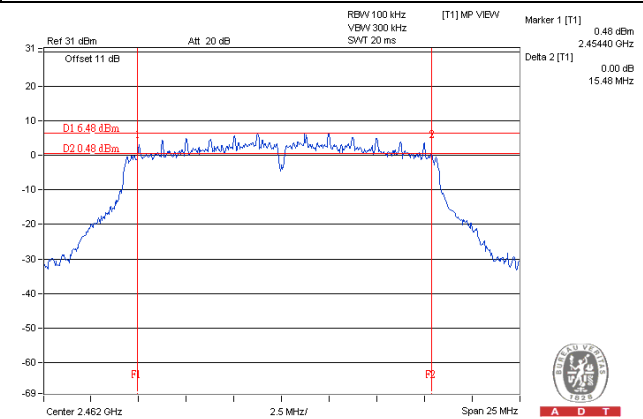
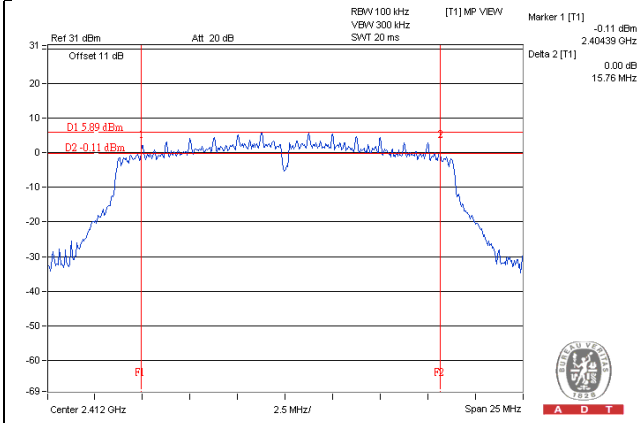
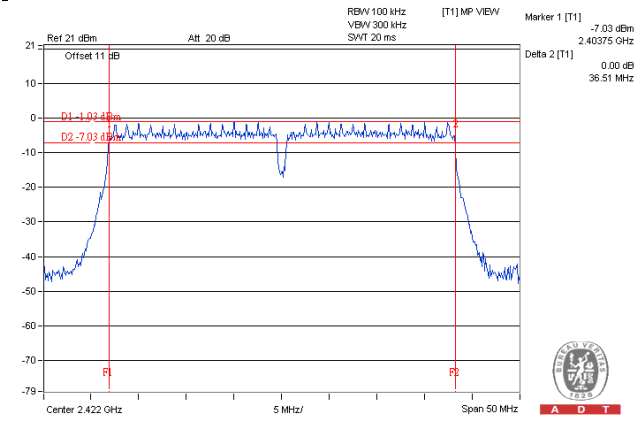
802.11b**802.11g****802.11n (HT20)****802.11n (HT40)**

Test Mode C
1TX
802.11b

Channel	Frequency (MHz)	6dB Bandwidth (MHz)	Minimum Limit (MHz)	Pass / Fail
1	2412	7.60	0.5	Pass
6	2437	8.09	0.5	Pass
11	2462	8.06	0.5	Pass

802.11g

Channel	Frequency (MHz)	6dB Bandwidth (MHz)	Minimum Limit (MHz)	Pass / Fail
1	2412	16.13	0.5	Pass
6	2437	15.80	0.5	Pass
11	2462	15.78	0.5	Pass

802.11n (HT20)

Channel	Frequency (MHz)	6dB Bandwidth (MHz)	Minimum Limit (MHz)	Pass / Fail
1	2412	16.41	0.5	Pass
6	2437	16.42	0.5	Pass
11	2462	16.38	0.5	Pass

802.11n (HT40)

Channel	Frequency (MHz)	6dB Bandwidth (MHz)	Minimum Limit (MHz)	Pass / Fail
3	2422	35.28	0.5	Pass
6	2437	35.19	0.5	Pass
9	2452	35.80	0.5	Pass

Spectrum Plot of Worst Value

802.11b

802.11g

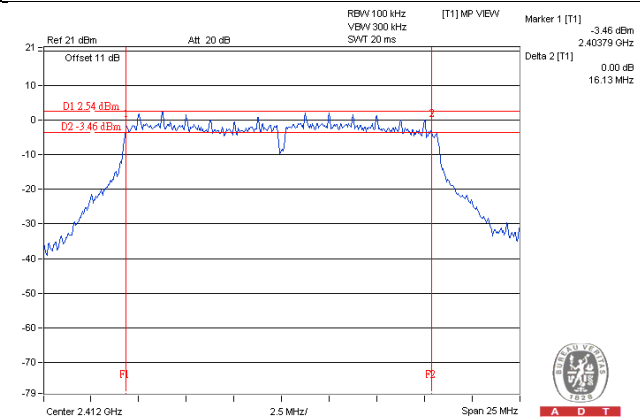
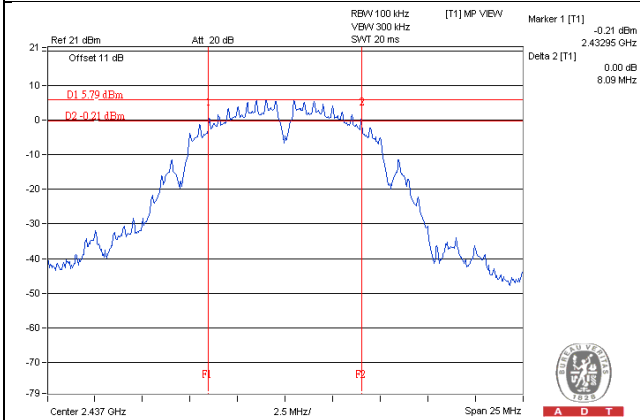

802.11n (HT20)

802.11n (HT40)

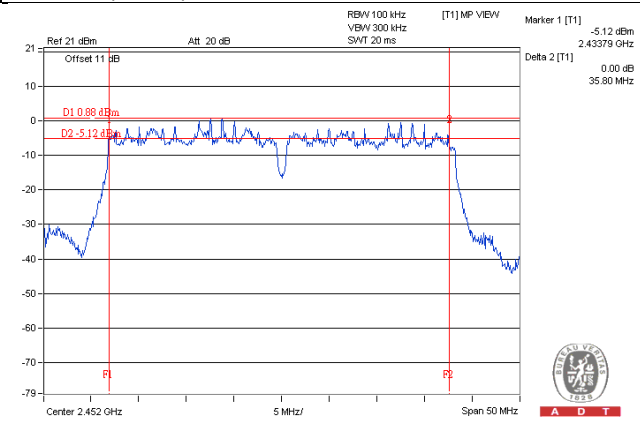
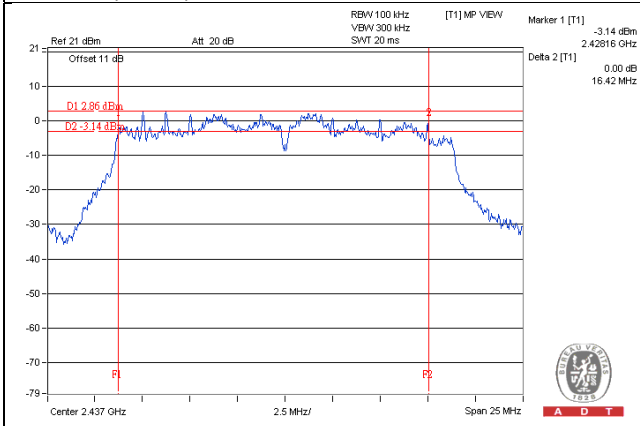

4.4 Conducted Output Power Measurement

4.4.1 Limits of Conducted Output Power Measurement

For systems using digital modulation in the 2400–2483.5 MHz bands: 1 Watt (30dBm)

Per KDB 662911 D01 Multiple Transmitter Output Method of conducted output power measurement on IEEE 802.11 devices,

Array Gain = 0 dB (i.e., no array gain) for $N_{ANT} \leq 4$;

Array Gain = 0 dB (i.e., no array gain) for channel widths ≥ 40 MHz for any N_{ANT} ;

Array Gain = $5 \log(N_{ANT}/N_{SS})$ dB or 3 dB, whichever is less for 20-MHz channel widths with $N_{ANT} \geq 5$.

For power measurements on all other devices: Array Gain = $10 \log(N_{ANT}/N_{SS})$ dB.

4.4.2 Test Setup

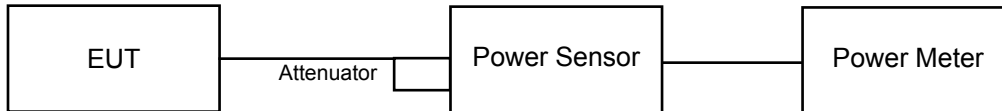

4.4.3 Test Instruments

Refer to section 4.1.2 to get information of above instrument.

4.4.4 Test Procedures

An average power sensor was used on the output port of the EUT. A power meter was used to read the response of the average power sensor. Record the power level.

4.4.5 Deviation from Test Standard

No deviation.

4.4.6 EUT Operating Conditions

Same as Item 4.3.6.

4.4.7 Test Results

Test Mode A

1TX

802.11b

Channel	Frequency (MHz)	Average Power (mW)	Average Power (dBm)	Limit (dBm)	Pass/Fail
1	2412	148.594	21.72	30	Pass
6	2437	101.391	20.06	30	Pass
11	2462	78.163	18.93	30	Pass

802.11g

Channel	Frequency (MHz)	Average Power (mW)	Average Power (dBm)	Limit (dBm)	Pass/Fail
1	2412	55.590	17.45	30	Pass
6	2437	184.077	22.65	30	Pass
11	2462	66.988	18.26	30	Pass

802.11n (HT20)

Channel	Frequency (MHz)	Average Power (mW)	Average Power (dBm)	Limit (dBm)	Pass/Fail
1	2412	50.582	17.04	30	Pass
6	2437	183.654	22.64	30	Pass
11	2462	50.466	17.03	30	Pass

802.11n (HT40)

Channel	Frequency (MHz)	Average Power (mW)	Average Power (dBm)	Limit (dBm)	Pass/Fail
3	2422	38.548	15.86	30	Pass
6	2437	53.211	17.26	30	Pass
9	2452	35.156	15.46	30	Pass

Test Mode A

2TX

802.11b

Chan.	Freq. (MHz)	Average Power (dBm)		Total Power (mW)	Total Power (dBm)	Limit (dBm)	Pass / Fail
		Chain 0	Chain 1				
1	2412	21.20	21.21	263.956	24.22	30.00	Pass
6	2437	21.07	21.03	254.703	24.06	30.00	Pass
11	2462	21.08	21.01	254.416	24.06	30.00	Pass

802.11g

Chan.	Freq. (MHz)	Average Power (dBm)		Total Power (mW)	Total Power (dBm)	Limit (dBm)	Pass / Fail
		Chain 0	Chain 1				
1	2412	18.16	18.39	134.488	21.29	30.00	Pass
6	2437	22.32	22.55	350.495	25.45	30.00	Pass
11	2462	18.23	18.15	131.840	21.20	30.00	Pass

802.11n (HT20)

Chan.	Freq. (MHz)	Average Power (dBm)		Total Power (mW)	Total Power (dBm)	Limit (dBm)	Pass / Fail
		Chain 0	Chain 1				
1	2412	16.62	16.86	94.449	19.75	29.63	Pass
6	2437	22.41	22.19	339.758	25.31	29.63	Pass
11	2462	17.01	17.31	104.061	20.17	29.63	Pass

* Directional gain = $10 \log[(10^{G1/20} + 10^{G2/20} + \dots + 10^{GN/20})^2 / N]$ = 6.37dBi > 6dBi, so the power limit shall be reduced to 30-(6.37-6) = 29.63dBm.

802.11n (HT40)

Chan.	Freq. (MHz)	Average Power (dBm)		Total Power (mW)	Total Power (dBm)	Limit (dBm)	Pass / Fail
		Chain 0	Chain 1				
3	2422	15.71	15.56	73.214	18.65	29.63	Pass
6	2437	17.25	17.03	103.554	20.15	29.63	Pass
9	2452	15.14	15.56	68.634	18.37	29.63	Pass

* Directional gain = $10 \log[(10^{G1/20} + 10^{G2/20} + \dots + 10^{GN/20})^2 / N]$ = 6.37dBi > 6dBi, so the power limit shall be reduced to 30-(6.37-6) = 29.63dBm.

Test Mode A
3TX
802.11b

Chan.	Freq. (MHz)	Average Power (dBm)			Total Power (mW)	Total Power (dBm)	Limit (dBm)	Pass / Fail
		Chain 0	Chain 1	Chain 2				
1	2412	20.74	19.98	20.05	319.276	25.04	30.00	Pass
6	2437	19.08	19.10	19.72	255.949	24.08	30.00	Pass
11	2462	20.24	20.08	19.87	304.592	24.84	30.00	Pass

802.11g

Chan.	Freq. (MHz)	Average Power (dBm)			Total Power (mW)	Total Power (dBm)	Limit (dBm)	Pass / Fail
		Chain 0	Chain 1	Chain 2				
1	2412	17.95	17.47	17.97	180.881	22.57	30.00	Pass
6	2437	22.23	22.21	22.37	506.034	27.04	30.00	Pass
11	2462	18.13	17.89	18.09	190.948	22.81	30.00	Pass

802.11n (HT20)

Chan.	Freq. (MHz)	Average Power (dBm)			Total Power (mW)	Total Power (dBm)	Limit (dBm)	Pass / Fail
		Chain 0	Chain 1	Chain 2				
1	2412	16.59	16.63	16.92	140.834	21.49	27.87	Pass
6	2437	22.22	22.23	22.45	509.626	27.07	27.87	Pass
11	2462	16.75	16.65	17.04	144.135	21.59	27.87	Pass

* Directional gain = $10 \log[(10^{G1/20} + 10^{G2/20} + \dots + 10^{GN/20})^2 / N]$ = 8.13dBi > 6dBi, so the power limit shall be reduced to 30-(8.13-6) = 27.87dBm.

802.11n (HT40)

Chan.	Freq. (MHz)	Average Power (dBm)			Total Power (mW)	Total Power (dBm)	Limit (dBm)	Pass / Fail
		Chain 0	Chain 1	Chain 2				
3	2422	15.14	15.33	14.98	98.255	19.92	27.87	Pass
6	2437	16.29	16.28	16.27	127.386	21.05	27.87	Pass
9	2452	15.04	14.38	14.96	90.664	19.57	27.87	Pass

* Directional gain = $10 \log[(10^{G1/20} + 10^{G2/20} + \dots + 10^{GN/20})^2 / N]$ = 8.13dBi > 6dBi, so the power limit shall be reduced to 30-(8.13-6) = 27.87dBm.

Test Mode A

4TX

802.11b

Chan.	Freq. (MHz)	Average Power (dBm)				Total Power (mW)	Total Power (dBm)	Limit (dBm)	Pass / Fail
		Chain 0	Chain 1	Chain 2	Chain 3				
1	2412	19.66	19.08	19.07	19.53	343.847	25.36	30.00	Pass
6	2437	19.26	18.94	18.82	19.28	323.607	25.10	30.00	Pass
11	2462	19.16	18.85	18.92	19.06	317.671	25.02	30.00	Pass

802.11g

Chan.	Freq. (MHz)	Average Power (dBm)				Total Power (mW)	Total Power (dBm)	Limit (dBm)	Pass / Fail
		Chain 0	Chain 1	Chain 2	Chain 3				
1	2412	16.37	16.05	16.25	16.47	170.154	22.31	30.00	Pass
6	2437	22.39	22.60	22.12	22.31	688.496	28.38	30.00	Pass
11	2462	17.07	16.82	17.13	17.22	203.382	23.08	30.00	Pass

802.11n (HT20)

Chan.	Freq. (MHz)	Average Power (dBm)				Total Power (mW)	Total Power (dBm)	Limit (dBm)	Pass / Fail
		Chain 0	Chain 1	Chain 2	Chain 3				
1	2412	16.54	15.46	16.13	16.51	166.029	22.20	26.57	Pass
6	2437	20.22	20.09	20.20	20.23	417.442	26.21	26.57	Pass
11	2462	16.41	16.04	16.27	16.56	171.585	22.34	26.57	Pass

* Directional gain = $10 \log[(10^{G1/20} + 10^{G2/20} + \dots + 10^{GN/20})^2 / N]$ = 9.43dBi > 6dBi, so the power limit shall be reduced to 30-(9.43-6) = 26.57dBm.

802.11n (HT40)

Chan.	Freq. (MHz)	Average Power (dBm)				Total Power (mW)	Total Power (dBm)	Limit (dBm)	Pass / Fail
		Chain 0	Chain 1	Chain 2	Chain 3				
3	2422	13.73	13.69	13.93	13.54	94.304	19.75	26.57	Pass
6	2437	15.65	15.48	15.36	15.91	145.396	21.63	26.57	Pass
9	2452	14.16	13.99	14.07	14.36	103.940	20.17	26.57	Pass

* Directional gain = $10 \log[(10^{G1/20} + 10^{G2/20} + \dots + 10^{GN/20})^2 / N]$ = 9.43dBi > 6dBi, so the power limit shall be reduced to 30-(9.43-6) = 26.57dBm.

Test Mode C

1TX

802.11b

Channel	Frequency (MHz)	Average Power (mW)	Average Power (dBm)	Limit (dBm)	Pass/Fail
1	2412	21.727	13.37	30	Pass
6	2437	22.336	13.49	30	Pass
11	2462	22.284	13.48	30	Pass

802.11g

Channel	Frequency (MHz)	Average Power (mW)	Average Power (dBm)	Limit (dBm)	Pass/Fail
1	2412	21.577	13.34	30	Pass
6	2437	21.330	13.29	30	Pass
11	2462	21.135	13.25	30	Pass

802.11n (HT20)

Channel	Frequency (MHz)	Average Power (mW)	Average Power (dBm)	Limit (dBm)	Pass/Fail
1	2412	21.232	13.27	30	Pass
6	2437	22.336	13.49	30	Pass
11	2462	21.429	13.31	30	Pass

802.11n (HT40)

Channel	Frequency (MHz)	Average Power (mW)	Average Power (dBm)	Limit (dBm)	Pass/Fail
3	2422	22.182	13.46	30	Pass
6	2437	21.528	13.33	30	Pass
9	2452	21.232	13.27	30	Pass

4.5 Power Spectral Density Measurement

4.5.1 Limits of Power Spectral Density Measurement

The Maximum of Power Spectral Density Measurement is 8dBm.

4.5.2 Test Setup

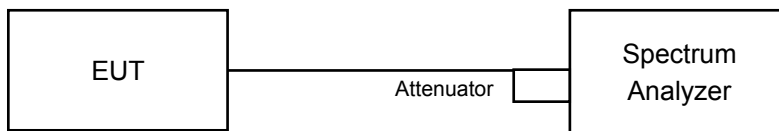

4.5.3 Test Instruments

Refer to section 4.1.2 to get information of above instrument.

4.5.4 Test Procedure

For duty cycle $\geq 98\%$

- Set instrument center frequency to DTS channel center frequency.
- Set span to at least 1.5 times the OBW.
- Set RBW to: $3 \text{ kHz} \leq \text{RBW} \leq 100 \text{ kHz}$.
- Set VBW $\geq 3 \times \text{RBW}$.
- Detector = power averaging (RMS) or sample detector (when RMS not available).
- Ensure that the number of measurement points in the sweep $\geq 2 \times \text{span}/\text{RBW}$.
- Sweep time = auto couple.
- Employ trace averaging (RMS) mode over a minimum of 100 traces.
- Use the peak marker function to determine the maximum amplitude level.

For duty cycle $< 98\%$

- Measure the duty cycle (x).
- Set instrument center frequency to DTS channel center frequency.
- Set span to at least 1.5 times the OBW.
- Set RBW to: $3 \text{ kHz} \leq \text{RBW} \leq 100 \text{ kHz}$.
- Set VBW $\geq 3 \times \text{RBW}$.
- Detector = power averaging (RMS) or sample detector (when RMS not available).
- Ensure that the number of measurement points in the sweep $\geq 2 \times \text{span}/\text{RBW}$.
- Sweep time = auto couple.
- Do not use sweep triggering. Allow sweep to "free run".
- Employ trace averaging (RMS) mode over a minimum of 100 traces.
- Use the peak marker function to determine the maximum amplitude level.
- Add $10 \log (1/x)$, where x is the duty cycle measured in step (a), to the measured PSD to compute the average PSD during the actual transmission time.

4.5.5 Deviation from Test Standard

No deviation.

4.5.6 EUT Operating Condition

Same as Item 4.3.6

4.5.7 Test Results

Test Mode A

1TX

802.11b

Channel	Freq. (MHz)	PSD (dBm)	Limit (dBm)	Pass /Fail
1	2412	-6.15	8	Pass
6	2437	-7.25	8	Pass
11	2462	-8.96	8	Pass

802.11g

Channel	Freq. (MHz)	PSD (dBm)	Limit (dBm)	Pass /Fail
1	2412	-10.72	8	Pass
6	2437	-6.20	8	Pass
11	2462	-10.34	8	Pass

802.11n (HT20)

Channel	Freq. (MHz)	PSD (dBm)	Limit (dBm)	Pass /Fail
1	2412	-13.25	8	Pass
6	2437	-6.72	8	Pass
11	2462	-12.87	8	Pass

802.11n (HT40)

Channel	Freq. (MHz)	PSD without Duty Factor (dBm)	Duty Factor	Total PSD with Duty Factor (dBm)	Limit (dBm)	Pass /Fail
3	2422	-17.71	0.18	-17.53	8	Pass
6	2437	-15.56	0.18	-15.38	8	Pass
9	2452	-17.31	0.18	-17.13	8	Pass

Spectrum Plot of Worst Value

802.11b

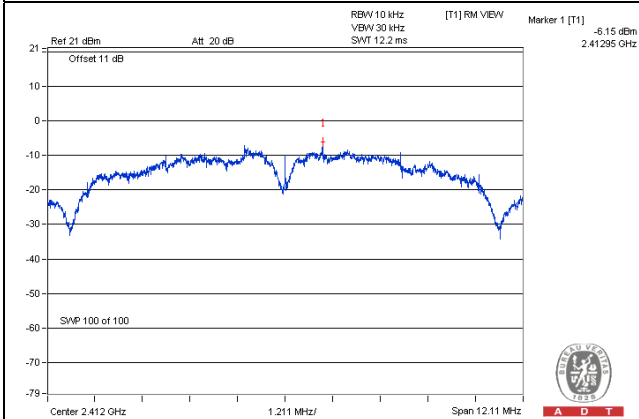

802.11g

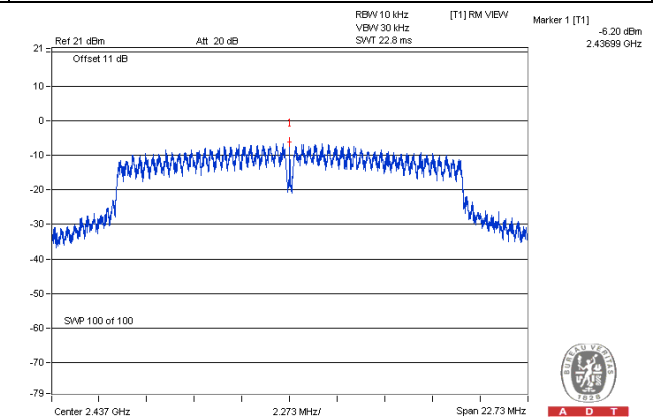

802.11n (HT20)

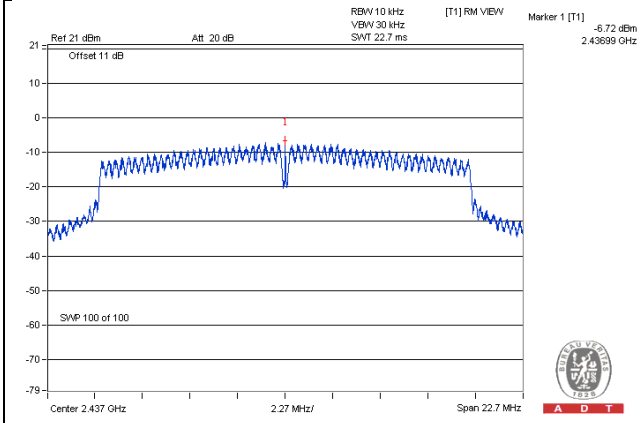

802.11n (HT40)

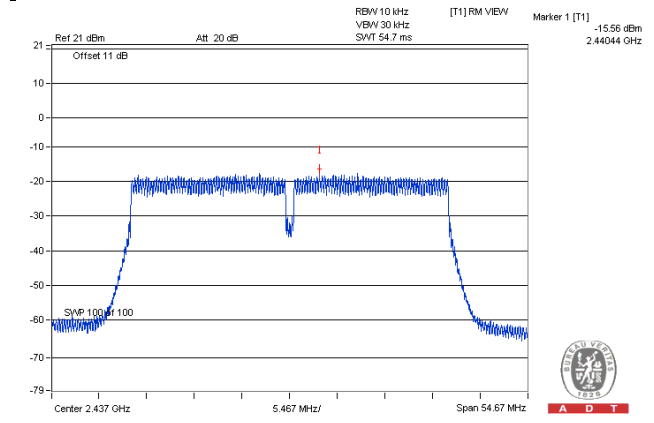

Test Mode A
2TX
802.11b

TX chain	Chan.	Freq. (MHz)	PSD (dBm/10kHz)	10 log (N=2) dB	Total PSD (dBm/10kHz)	Limit (dBm/3kHz)	Pass / Fail
0	1	2412	-6.40	3.01	-3.39	7.63	Pass
	6	2437	-6.52	3.01	-3.51	7.63	Pass
	11	2462	-6.51	3.01	-3.50	7.63	Pass
1	1	2412	-6.04	3.01	-3.03	7.63	Pass
	6	2437	-6.79	3.01	-3.78	7.63	Pass
	11	2462	-6.51	3.01	-3.50	7.63	Pass

Note:

- Method 1 of power density measurement of KDB 662911 is using for calculating total power density. Total power density is summing entire spectra across corresponding frequency bins on the various outputs by computer.
- Directional gain = $10 \log[(10^{G1/20} + 10^{G2/20} + \dots + 10^{GN/20})^2/N]$ = 6.37dBi > 6dBi, so the power density limit shall be reduced to $8-(6.37-6) = 7.63\text{dBm}$.

802.11g

TX chain	Chan.	Freq. (MHz)	PSD (dBm/10kHz)	10 log (N=2) dB	Total PSD (dBm/10kHz)	Limit (dBm/3kHz)	Pass / Fail
0	1	2412	-10.25	3.01	-7.24	7.63	Pass
	6	2437	-5.88	3.01	-2.87	7.63	Pass
	11	2462	-10.11	3.01	-7.10	7.63	Pass
1	1	2412	-10.43	3.01	-7.42	7.63	Pass
	6	2437	-6.54	3.01	-3.53	7.63	Pass
	11	2462	-10.87	3.01	-7.86	7.63	Pass

Note:

- Method 1 of power density measurement of KDB 662911 is using for calculating total power density. Total power density is summing entire spectra across corresponding frequency bins on the various outputs by computer.
- Directional gain = $10 \log[(10^{G1/20} + 10^{G2/20} + \dots + 10^{GN/20})^2/N]$ = 6.37dBi > 6dBi, so the power density limit shall be reduced to $8-(6.37-6) = 7.63\text{dBm}$.

802.11n (HT20)

TX chain	Chan.	Freq. (MHz)	PSD (dBm/10kHz)	10 log (N=2) dB	Total PSD (dBm/10kHz)	Limit (dBm/3kHz)	Pass / Fail
0	1	2412	-13.10	3.01	-10.09	7.63	Pass
	6	2437	-7.33	3.01	-4.32	7.63	Pass
	11	2462	-12.87	3.01	-9.86	7.63	Pass
1	1	2412	-12.94	3.01	-9.93	7.63	Pass
	6	2437	-7.80	3.01	-4.79	7.63	Pass
	11	2462	-13.14	3.01	-10.13	7.63	Pass

Note:

- Method 1 of power density measurement of KDB 662911 is using for calculating total power density. Total power density is summing entire spectra across corresponding frequency bins on the various outputs by computer.
- Directional gain = $10 \log[(10^{G1/20} + 10^{G2/20} + \dots + 10^{GN/20})^2/N]$ = 6.37dBi > 6dBi, so the power density limit shall be reduced to $8-(6.37-6) = 7.63\text{dBm}$.

802.11n (HT40)

TX chain	Chan.	Freq. (MHz)	PSD (dBm/10kHz)	10 log (N=2) dB	Duty Factor	Total PSD with Duty Factor (dBm/10kHz)	Limit (dBm/10kHz)	Pass / Fail
0	3	2422	-17.90	3.01	0.19	-14.70	7.63	Pass
	6	2437	-15.97	3.01	0.19	-12.77	7.63	Pass
	9	2452	-17.91	3.01	0.19	-14.71	7.63	Pass
1	3	2422	-17.88	3.01	0.19	-14.68	7.63	Pass
	6	2437	-16.03	3.01	0.19	-12.83	7.63	Pass
	9	2452	-18.76	3.01	0.19	-15.56	7.63	Pass

Note:

- Method 1 of power density measurement of KDB 662911 is using for calculating total power density. Total power density is summing entire spectra across corresponding frequency bins on the various outputs by computer.
- Directional gain = $10 \log[(10^{G1/20} + 10^{G2/20} + \dots + 10^{GN/20})^2/N]$ = 6.37dBi > 6dBi, so the power density limit shall be reduced to $8-(6.37-6) = 7.63\text{dBm}$.
- Refer to section 3.3 for duty cycle spectrum plot.

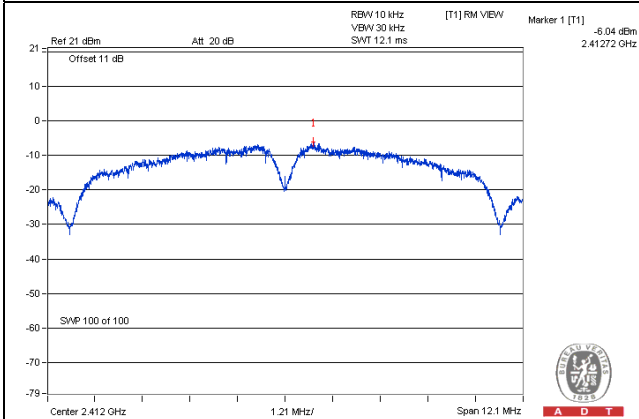
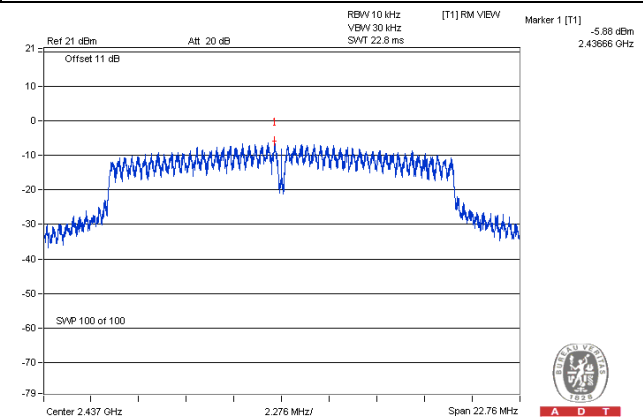
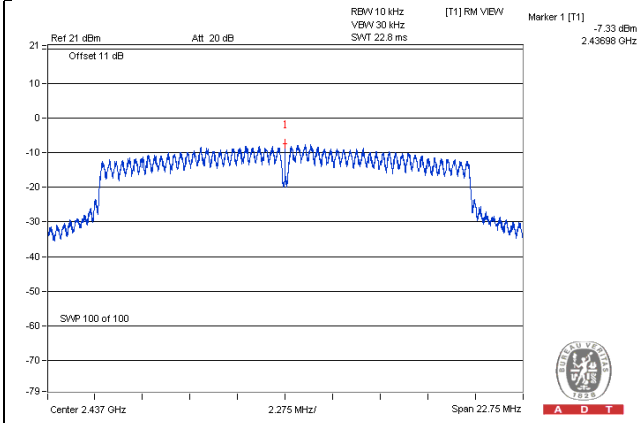
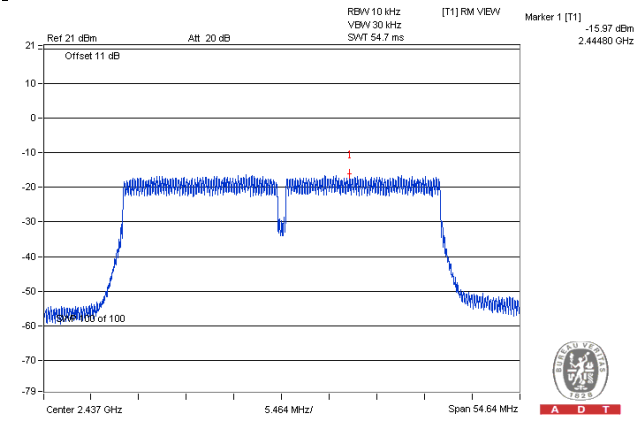
Spectrum Plot of Worst Value**802.11b****802.11g****802.11n (HT20)****802.11n (HT40)**

Test Mode A
3TX
802.11b

TX chain	Chan.	Freq. (MHz)	PSD (dBm/10kHz)	10 log (N=3) dB	Total PSD (dBm/10kHz)	Limit (dBm/3kHz)	Pass / Fail
0	1	2412	-7.23	4.77	-2.46	5.87	Pass
	6	2437	-7.84	4.77	-3.07	5.87	Pass
	11	2462	-7.44	4.77	-2.67	5.87	Pass
1	1	2412	-7.27	4.77	-2.50	5.87	Pass
	6	2437	-7.66	4.77	-2.89	5.87	Pass
	11	2462	-7.14	4.77	-2.37	5.87	Pass
2	1	2412	-7.42	4.77	-2.65	5.87	Pass
	6	2437	-8.06	4.77	-3.29	5.87	Pass
	11	2462	-7.61	4.77	-2.84	5.87	Pass

Note:

- Method 1 of power density measurement of KDB 662911 is using for calculating total power density. Total power density is summing entire spectra across corresponding frequency bins on the various outputs by computer.
- Directional gain = $10 \log[(10^{G1/20} + 10^{G2/20} + \dots + 10^{GN/20})^2/N]$ = 8.13dBi > 6dBi, so the power density limit shall be reduced to $8-(8.13-6) = 5.87$ dBm.

802.11g

TX chain	Chan.	Freq. (MHz)	PSD (dBm/10kHz)	10 log (N=3) dB	Total PSD (dBm/10kHz)	Limit (dBm/3kHz)	Pass / Fail
0	1	2412	-11.50	4.77	-6.73	5.87	Pass
	6	2437	-5.55	4.77	-0.78	5.87	Pass
	11	2462	-9.84	4.77	-5.07	5.87	Pass
1	1	2412	-10.11	4.77	-5.34	5.87	Pass
	6	2437	-6.45	4.77	-1.68	5.87	Pass
	11	2462	-10.69	4.77	-5.92	5.87	Pass
2	1	2412	-10.76	4.77	-5.99	5.87	Pass
	6	2437	-5.96	4.77	-1.19	5.87	Pass
	11	2462	-9.78	4.77	-5.01	5.87	Pass

Note:

- Method 1 of power density measurement of KDB 662911 is using for calculating total power density. Total power density is summing entire spectra across corresponding frequency bins on the various outputs by computer.
- Directional gain = $10 \log[(10^{G1/20} + 10^{G2/20} + \dots + 10^{GN/20})^2/N]$ = 8.13dBi > 6dBi, so the power density limit shall be reduced to $8-(8.13-6) = 5.87$ dBm.

802.11n (HT20)

TX chain	Chan.	Freq. (MHz)	PSD (dBm/10kHz)	10 log (N=3) dB	Total PSD (dBm/10kHz)	Limit (dBm/3kHz)	Pass / Fail
0	1	2412	-13.13	4.77	-8.36	5.87	Pass
	6	2437	-7.05	4.77	-2.28	5.87	Pass
	11	2462	-12.86	4.77	-8.09	5.87	Pass
1	1	2412	-13.12	4.77	-8.35	5.87	Pass
	6	2437	-7.65	4.77	-2.88	5.87	Pass
	11	2462	-11.91	4.77	-7.14	5.87	Pass
2	1	2412	-12.76	4.77	-7.99	5.87	Pass
	6	2437	-7.35	4.77	-2.58	5.87	Pass
	11	2462	-12.80	4.77	-8.03	5.87	Pass

Note:

- Method 1 of power density measurement of KDB 662911 is using for calculating total power density. Total power density is summing entire spectra across corresponding frequency bins on the various outputs by computer.
- Directional gain = $10 \log[(10^{G1/20} + 10^{G2/20} + \dots + 10^{GN/20})^2/N]$ = 8.13dBi > 6dBi, so the power density limit shall be reduced to 8-(8.13-6) = 5.87dBm.

802.11n (HT40)

TX chain	Chan.	Freq. (MHz)	PSD (dBm/10kHz)	10 log (N=3) dB	Duty Factor	Total PSD with Duty Factor (dBm/10kHz)	Limit (dBm/10kHz)	Pass / Fail
0	3	2422	-18.19	4.77	0.14	-13.28	5.87	Pass
	6	2437	-16.98	4.77	0.14	-12.07	5.87	Pass
	9	2452	-18.66	4.77	0.14	-13.75	5.87	Pass
1	3	2422	-18.42	4.77	0.14	-13.51	5.87	Pass
	6	2437	-16.65	4.77	0.14	-11.74	5.87	Pass
	9	2452	-18.36	4.77	0.14	-13.45	5.87	Pass
2	3	2422	-18.18	4.77	0.14	-13.27	5.87	Pass
	6	2437	-16.56	4.77	0.14	-11.65	5.87	Pass
	9	2452	-18.30	4.77	0.14	-13.39	5.87	Pass

Note:

- Method 1 of power density measurement of KDB 662911 is using for calculating total power density. Total power density is summing entire spectra across corresponding frequency bins on the various outputs by computer.
- Directional gain = $10 \log[(10^{G1/20} + 10^{G2/20} + \dots + 10^{GN/20})^2/N]$ = 8.13dBi > 6dBi, so the power density limit shall be reduced to 8-(8.13-6) = 5.87dBm.
- Refer to section 3.3 for duty cycle spectrum plot.

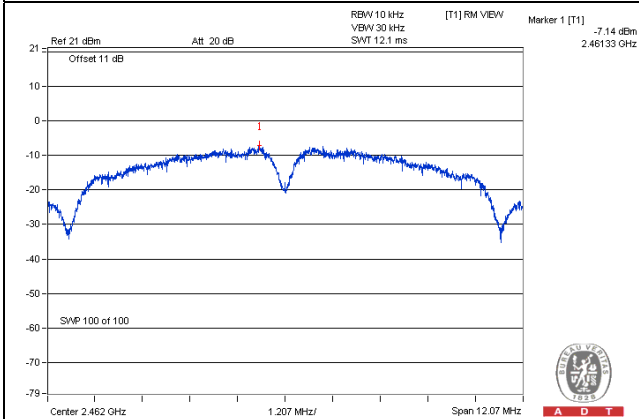
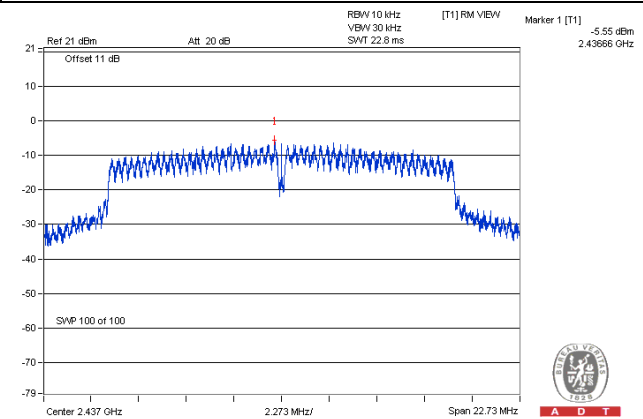
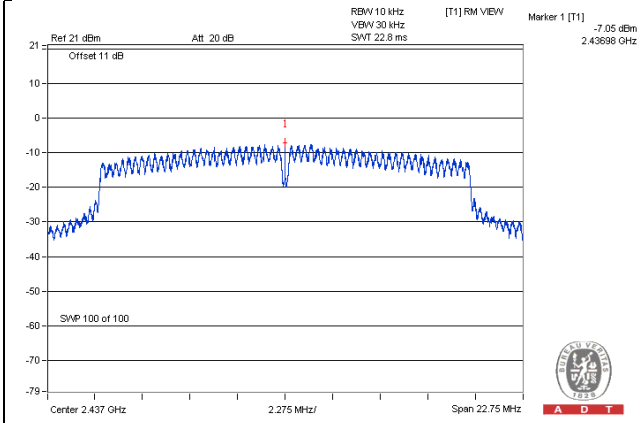
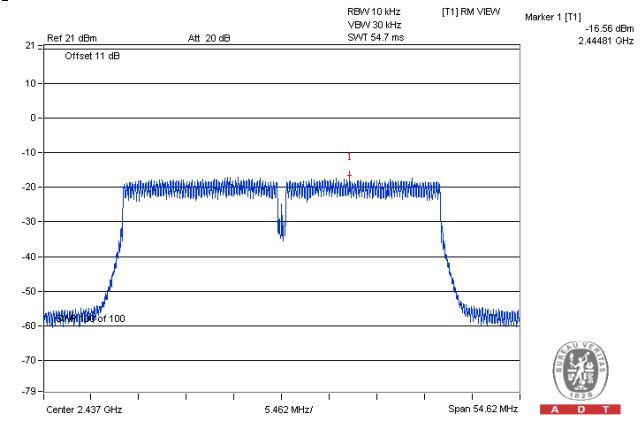
Spectrum Plot of Worst Value**802.11b****802.11g****802.11n (HT20)****802.11n (HT40)**

Test Mode A
4TX
802.11b

TX chain	Chan.	Freq. (MHz)	PSD (dBm/10kHz)	10 log (N=4) dB	Total PSD (dBm/10kHz)	Limit (dBm/3kHz)	Pass / Fail
0	1	2412	-8.05	6.02	-2.03	4.57	Pass
	6	2437	-8.33	6.02	-2.31	4.57	Pass
	11	2462	-8.55	6.02	-2.53	4.57	Pass
1	1	2412	-8.59	6.02	-2.57	4.57	Pass
	6	2437	-9.13	6.02	-3.11	4.57	Pass
	11	2462	-8.77	6.02	-2.75	4.57	Pass
2	1	2412	-8.60	6.02	-2.58	4.57	Pass
	6	2437	-8.39	6.02	-2.37	4.57	Pass
	11	2462	-8.57	6.02	-2.55	4.57	Pass
3	1	2412	-7.93	6.02	-1.91	4.57	Pass
	6	2437	-7.81	6.02	-1.79	4.57	Pass
	11	2462	-7.77	6.02	-1.75	4.57	Pass

Note:

- Method 1 of power density measurement of KDB 662911 is using for calculating total power density. Total power density is summing entire spectra across corresponding frequency bins on the various outputs by computer.
- Directional gain = $10 \log[(10^{G1/20} + 10^{G2/20} + \dots + 10^{GN/20})^2/N] = 9.43\text{dBi} > 6\text{dBi}$, so the power density limit shall be reduced to $8-(9.43-6) = 4.57\text{dBm}$.

802.11g

TX chain	Chan.	Freq. (MHz)	PSD (dBm/10kHz)	10 log (N=4) dB	Total PSD (dBm/10kHz)	Limit (dBm/3kHz)	Pass / Fail
0	1	2412	-12.05	6.02	-6.03	4.57	Pass
	6	2437	-5.98	6.02	0.04	4.57	Pass
	11	2462	-11.91	6.02	-5.89	4.57	Pass
1	1	2412	-12.58	6.02	-6.56	4.57	Pass
	6	2437	-6.15	6.02	-0.13	4.57	Pass
	11	2462	-11.57	6.02	-5.55	4.57	Pass
2	1	2412	-12.32	6.02	-6.30	4.57	Pass
	6	2437	-6.27	6.02	-0.25	4.57	Pass
	11	2462	-10.98	6.02	-4.96	4.57	Pass
3	1	2412	-11.58	6.02	-5.56	4.57	Pass
	6	2437	-5.79	6.02	0.23	4.57	Pass
	11	2462	-10.97	6.02	-4.95	4.57	Pass

Note:

- Method 1 of power density measurement of KDB 662911 is using for calculating total power density. Total power density is summing entire spectra across corresponding frequency bins on the various outputs by computer.
- Directional gain = $10 \log[(10^{G1/20} + 10^{G2/20} + \dots + 10^{GN/20})^2/N]$ = 9.43dBi > 6dBi, so the power density limit shall be reduced to 8-(9.43-6) = 4.57dBm.

802.11n (HT20)

TX chain	Chan.	Freq. (MHz)	PSD (dBm/10kHz)	10 log (N=4) dB	Total PSD (dBm/10kHz)	Limit (dBm/3kHz)	Pass / Fail
0	1	2412	-13.78	6.02	-7.76	4.57	Pass
	6	2437	-7.11	6.02	-1.09	4.57	Pass
	11	2462	-13.46	6.02	-7.44	4.57	Pass
1	1	2412	-14.39	6.02	-8.37	4.57	Pass
	6	2437	-8.03	6.02	-2.01	4.57	Pass
	11	2462	-14.22	6.02	-8.20	4.57	Pass
2	1	2412	-14.27	6.02	-8.25	4.57	Pass
	6	2437	-7.57	6.02	-1.55	4.57	Pass
	11	2462	-13.22	6.02	-7.20	4.57	Pass
3	1	2412	-13.62	6.02	-7.60	4.57	Pass
	6	2437	-7.28	6.02	-1.26	4.57	Pass
	11	2462	-13.57	6.02	-7.55	4.57	Pass

Note:

- Method 1 of power density measurement of KDB 662911 is using for calculating total power density. Total power density is summing entire spectra across corresponding frequency bins on the various outputs by computer.
- Directional gain = $10 \log[(10^{G1/20} + 10^{G2/20} + \dots + 10^{GN/20})^2/N]$ = 9.43dBi > 6dBi, so the power density limit shall be reduced to 8-(9.43-6) = 4.57dBm.

802.11n (HT40)

TX chain	Chan.	Freq. (MHz)	PSD (dBm/10kHz)	10 log (N=4) dB	Duty Factor	Total PSD with Duty Factor (dBm/10kHz)	Limit (dBm/10kHz)	Pass / Fail
0	3	2422	-19.60	6.02	0.14	-13.44	4.57	Pass
	6	2437	-17.57	6.02	0.14	-11.41	4.57	Pass
	9	2452	-19.29	6.02	0.14	-13.13	4.57	Pass
1	3	2422	-20.13	6.02	0.14	-13.97	4.57	Pass
	6	2437	-17.99	6.02	0.14	-11.83	4.57	Pass
	9	2452	-19.52	6.02	0.14	-13.36	4.57	Pass
2	3	2422	-19.74	6.02	0.14	-13.58	4.57	Pass
	6	2437	-17.73	6.02	0.14	-11.57	4.57	Pass
	9	2452	-18.98	6.02	0.14	-12.82	4.57	Pass
3	3	2422	-20.23	6.02	0.14	-14.07	4.57	Pass
	6	2437	-17.61	6.02	0.14	-11.45	4.57	Pass
	9	2452	-18.94	6.02	0.14	-12.78	4.57	Pass

Note:

- Method 1 of power density measurement of KDB 662911 is using for calculating total power density. Total power density is summing entire spectra across corresponding frequency bins on the various outputs by computer.
- Directional gain = $10 \log[(10^{G1/20} + 10^{G2/20} + \dots + 10^{GN/20})^2/N]$ = 9.43dBi > 6dBi, so the power density limit shall be reduced to 8-(9.43-6) = 4.57dBm.
- Refer to section 3.3 for duty cycle spectrum plot.

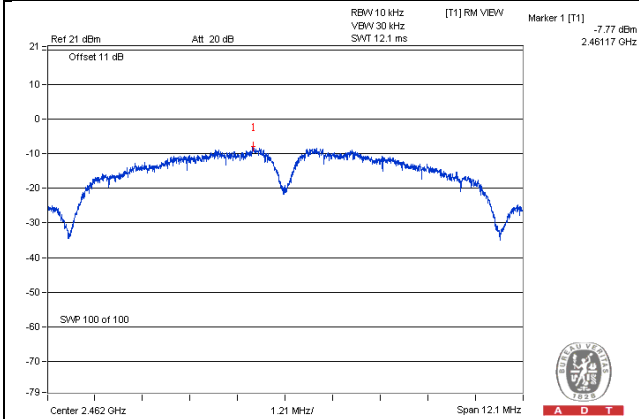
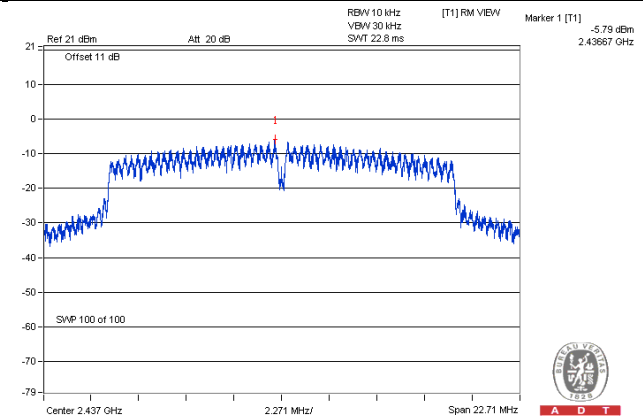
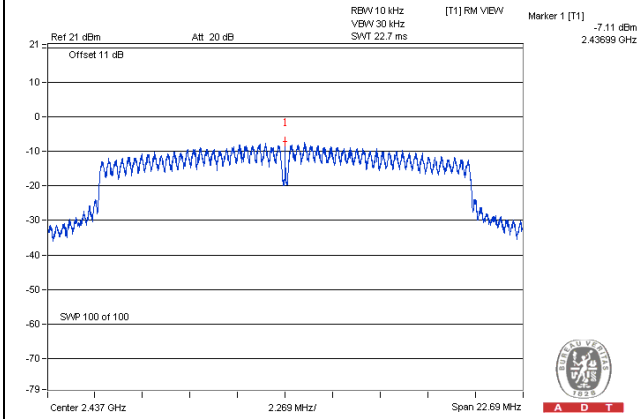
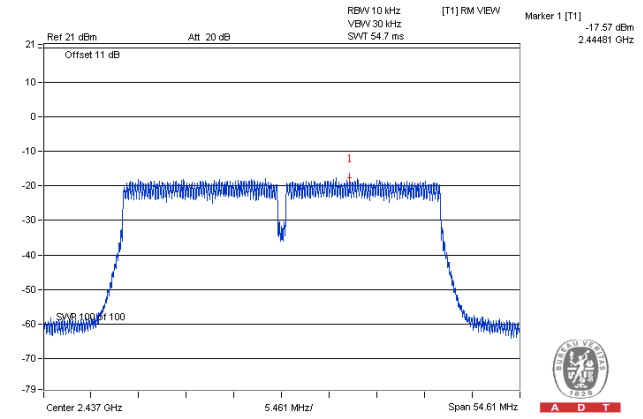
Spectrum Plot of Worst Value**802.11b****802.11g****802.11n (HT20)****802.11n (HT40)**

Test Mode C
1TX
802.11b

Channel	Freq. (MHz)	PSD (dBm)	Limit (dBm)	Pass /Fail
1	2412	-14.23	8	Pass
6	2437	-14.16	8	Pass
11	2462	-14.20	8	Pass

802.11g

Channel	Freq. (MHz)	PSD without Duty Factor (dBm)	Duty Factor	Total PSD with Duty Factor (dBm)	Limit (dBm)	Pass /Fail
1	2412	-17.27	0.11	-17.16	8	Pass
6	2437	-16.41	0.11	-16.30	8	Pass
11	2462	-17.11	0.11	-17.00	8	Pass

802.11n (HT20)

Channel	Freq. (MHz)	PSD without Duty Factor (dBm)	Duty Factor	Total PSD with Duty Factor (dBm)	Limit (dBm)	Pass /Fail
1	2412	-14.49	0.11	-14.38	8	Pass
6	2437	-15.11	0.11	-15.00	8	Pass
11	2462	-15.57	0.11	-15.46	8	Pass

802.11n (HT40)

Channel	Freq. (MHz)	PSD without Duty Factor (dBm)	Duty Factor	Total PSD with Duty Factor (dBm)	Limit (dBm)	Pass /Fail
3	2422	-19.67	0.19	-19.48	8	Pass
6	2437	-19.79	0.19	-19.60	8	Pass
9	2452	-20.07	0.19	-19.88	8	Pass

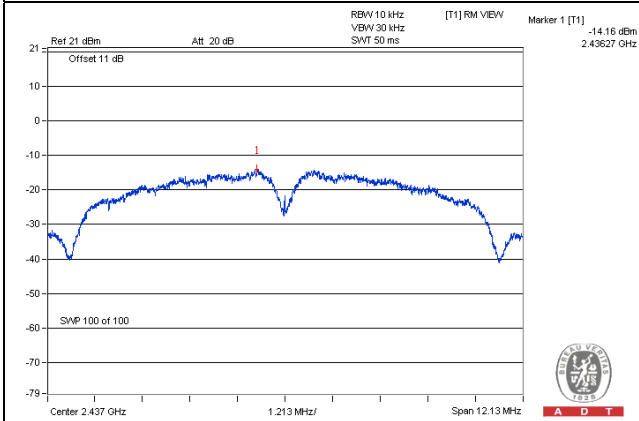
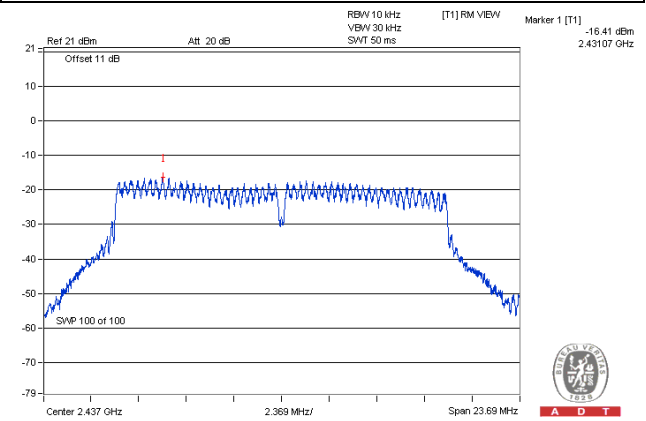
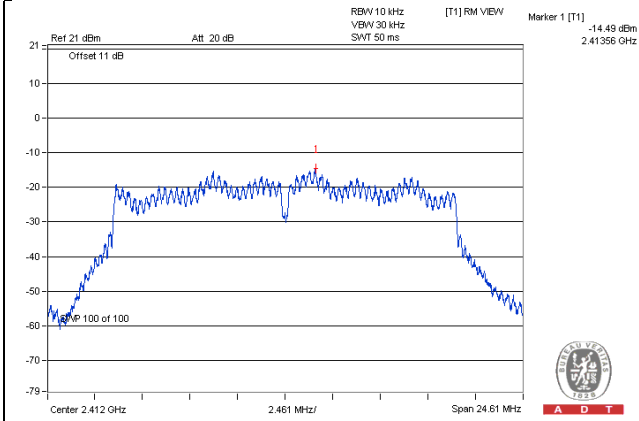
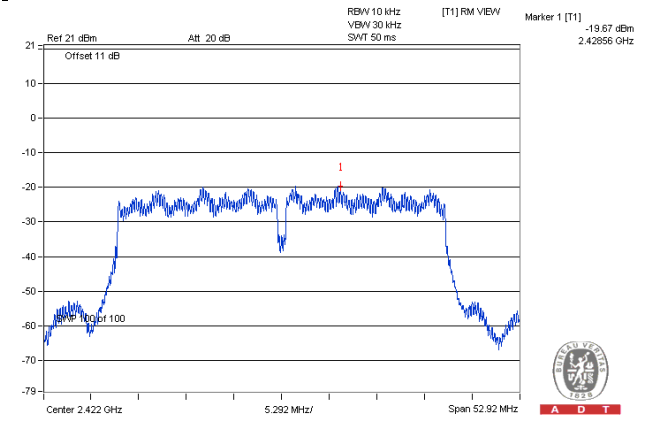
Spectrum Plot of Worst Value**802.11b****802.11g****802.11n (HT20)****802.11n (HT40)**

4.6 Conducted Out of Band Emission Measurement

4.6.1 Limits of Conducted Out of Band Emission Measurement

Below 30dB of the highest emission level of operating band (in 100kHz Resolution Bandwidth).

4.6.2 Test Setup

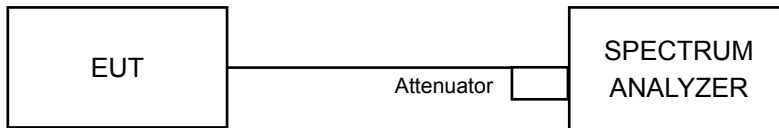

4.6.3 Test Instruments

Refer to section 4.1.2 to get information of above instrument.

4.6.4 Test Procedure

MEASUREMENT PROCEDURE REF

- a. Set the RBW = 100 kHz.
- b. Set the VBW \geq 300 kHz.
- c. Detector = average.
- d. Sweep time = auto couple.
- e. Trace mode = max hold.
- f. Allow trace to fully stabilize.
- g. Use the peak marker function to determine the maximum power level in any 100 kHz band segment within the fundamental EBW.

MEASUREMENT PROCEDURE OOB

- a. Set RBW = 100 kHz.
- b. Set VBW \geq 300 kHz.
- c. Ensure that the number of measurement points \geq span/RBW
- d. According to measurement points to set differ measurement span.
- e. Detector = average.
- f. Trace Mode = max hold.
- g. Sweep = auto couple.

4.6.5 Deviation from Test Standard

No deviation.

4.6.6 EUT Operating Condition

Same as Item 4.3.6

4.6.7 Test Results

The spectrum plots are attached on the following pages. D1 line indicates the highest level, and D2 line indicates the 30dB offset below D1. It shows compliance with the requirement.

Test Mode A

1TX

802.11b

CH 1

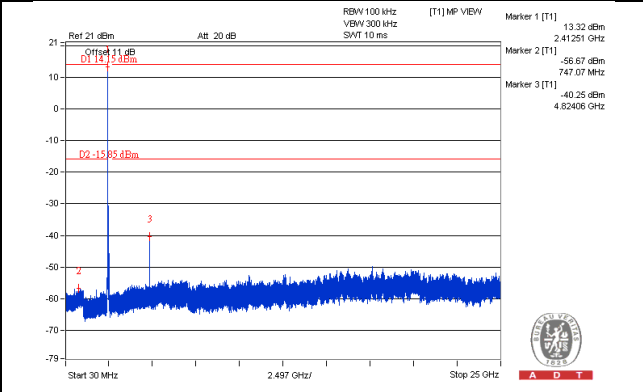
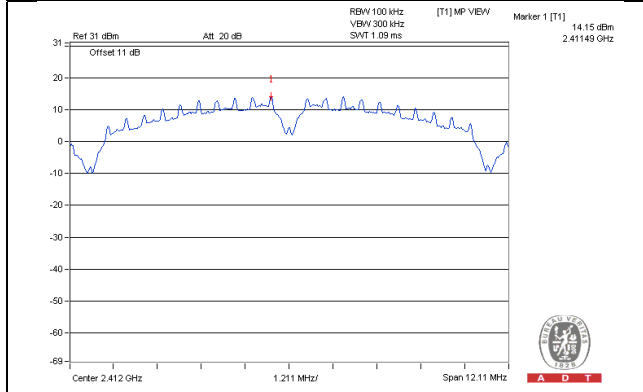

CH 6

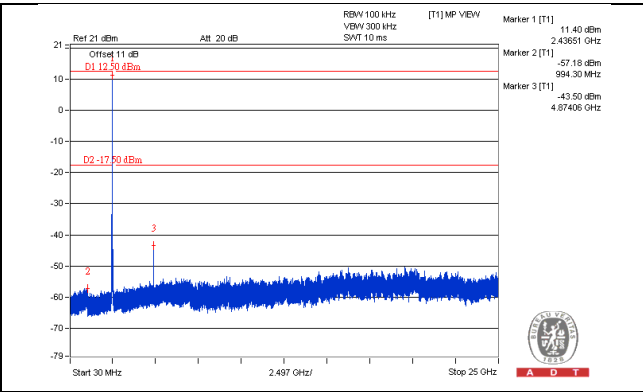
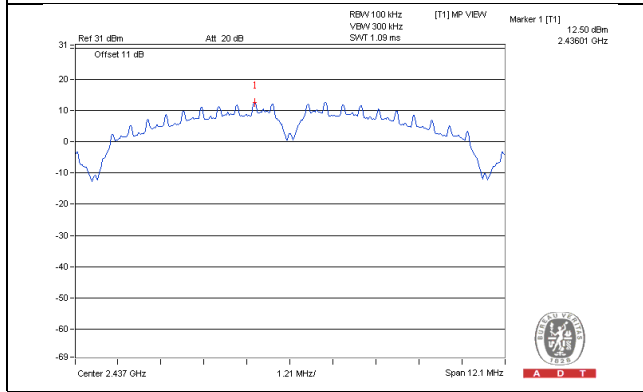

CH 11

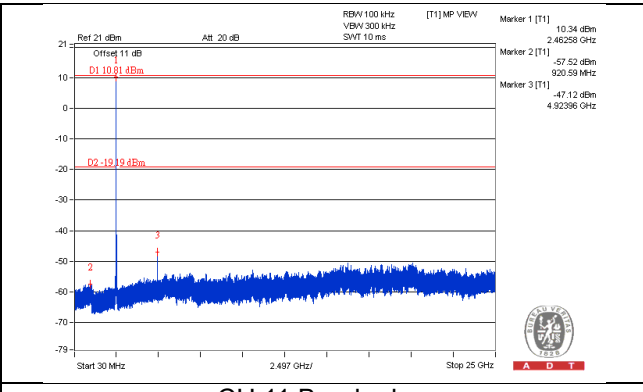
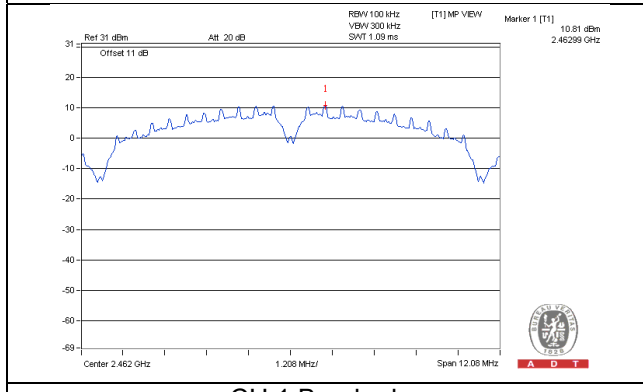

CH 1 Band edge

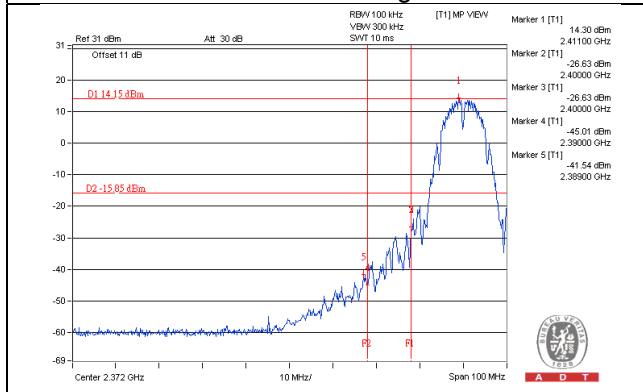

CH 11 Band edge

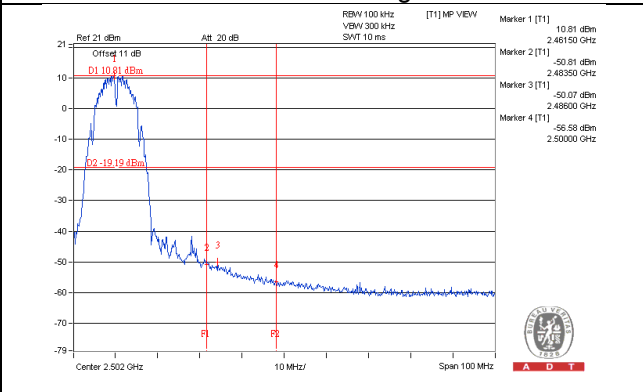

802.11g

CH 1

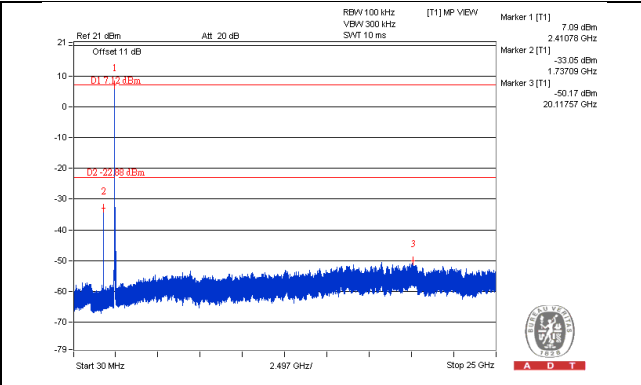
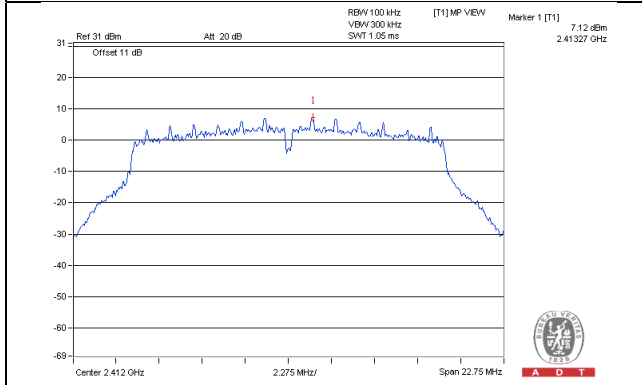

CH 6

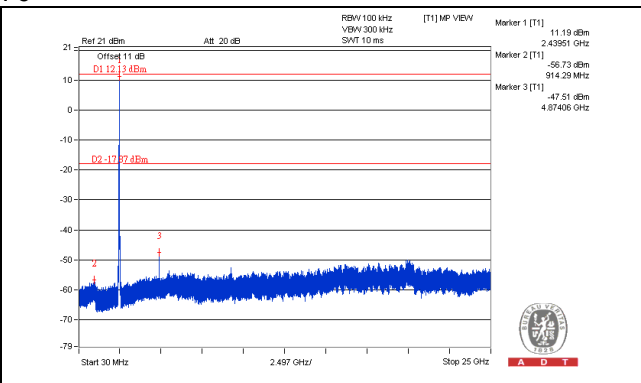
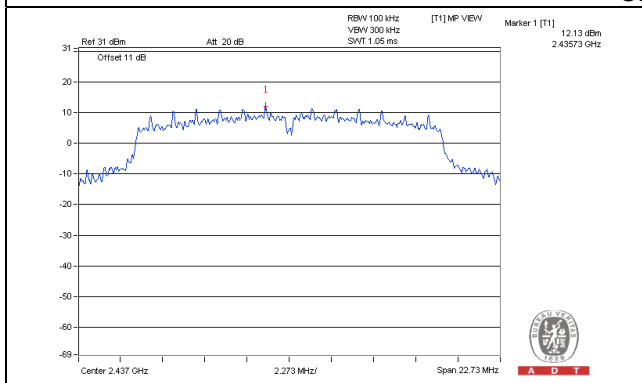

CH 11

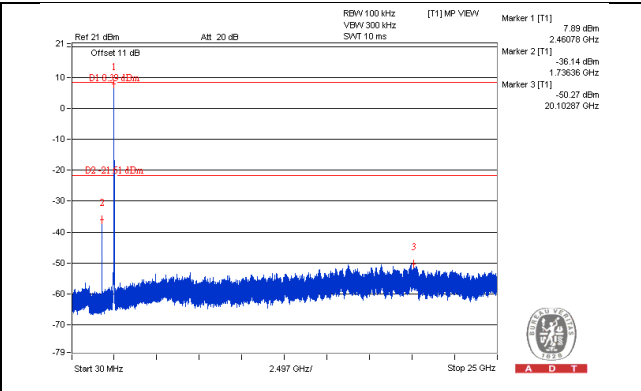
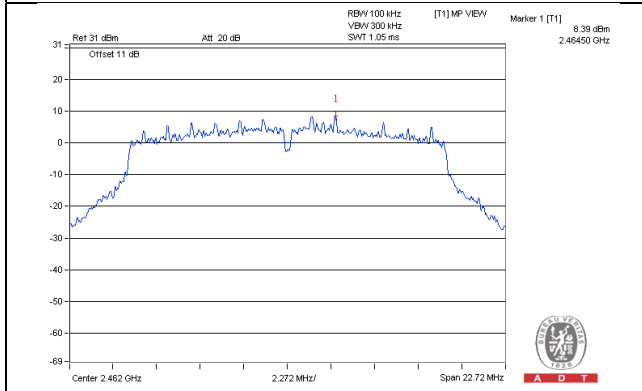

CH 1 Band edge

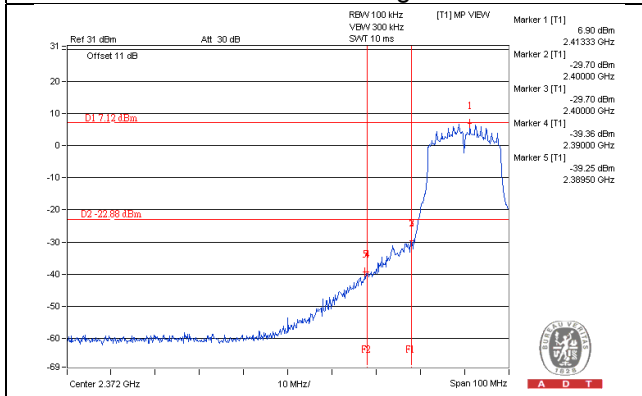

CH 11 Band edge

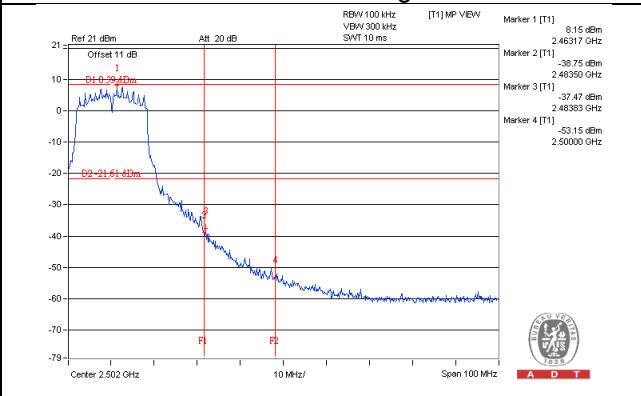

802.11n (HT20)

CH 1

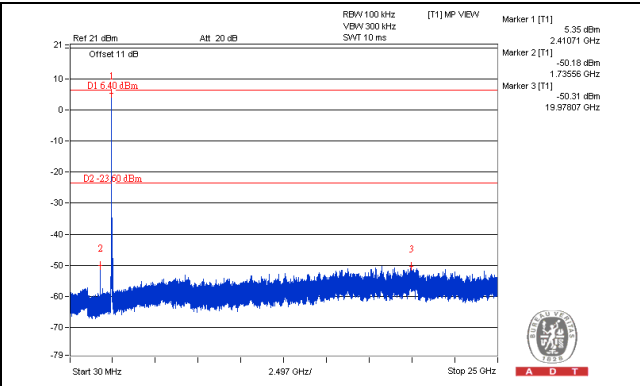
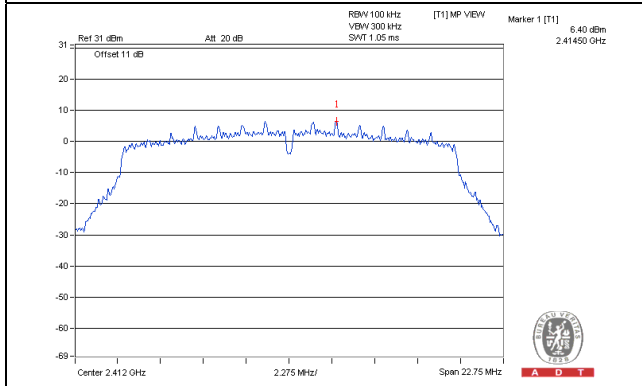

CH 6

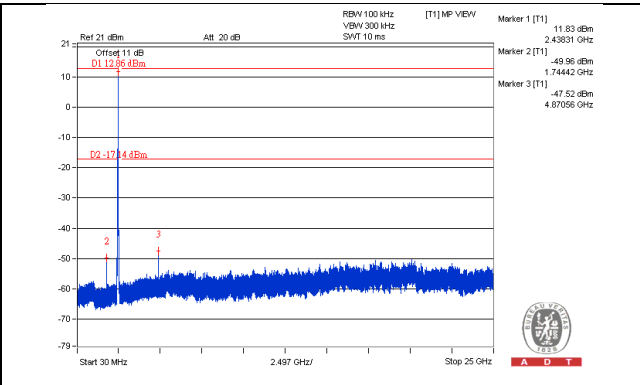
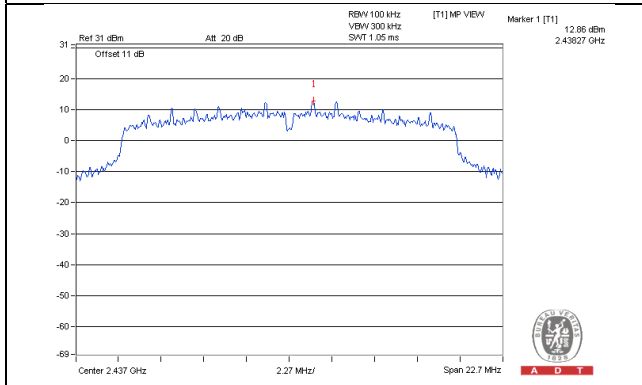

CH 11

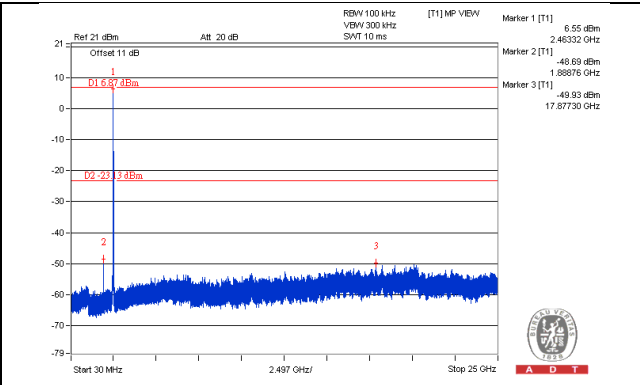
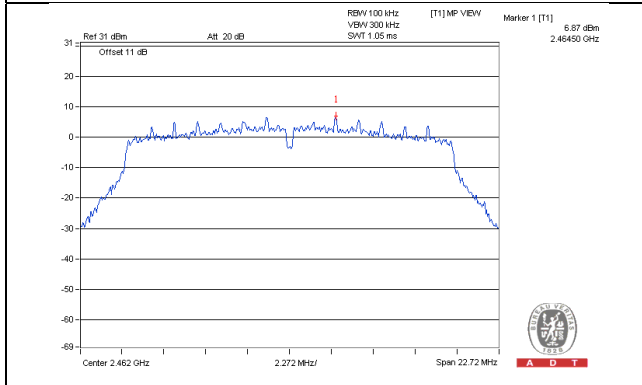

CH 1 Band edge

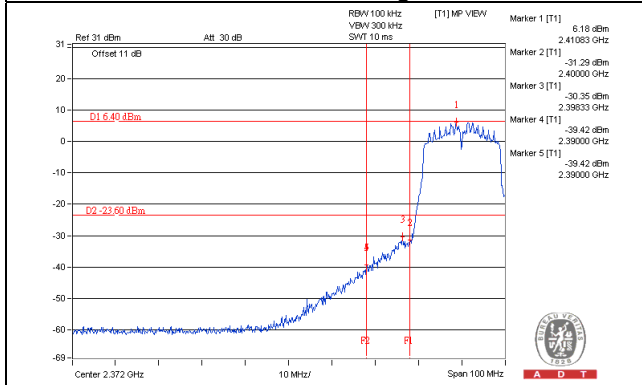

CH 11 Band edge

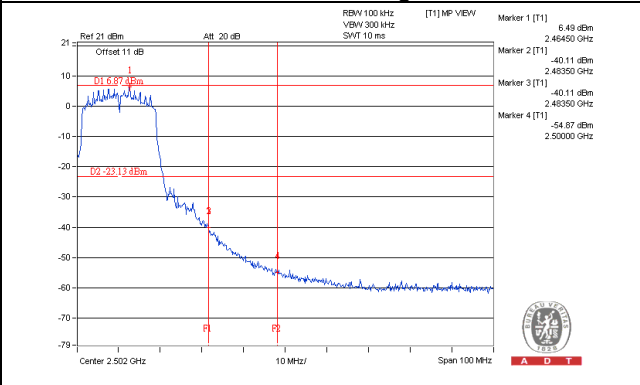

802.11n (HT40)

CH 3

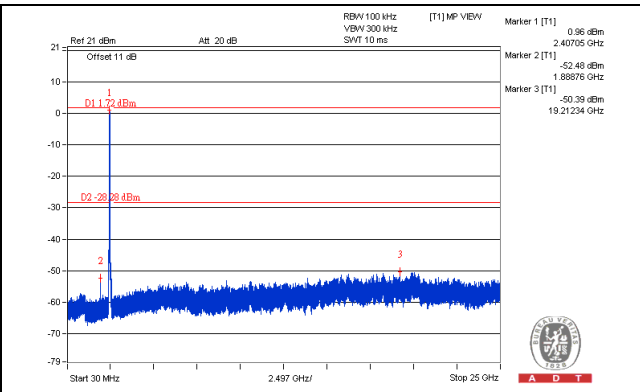
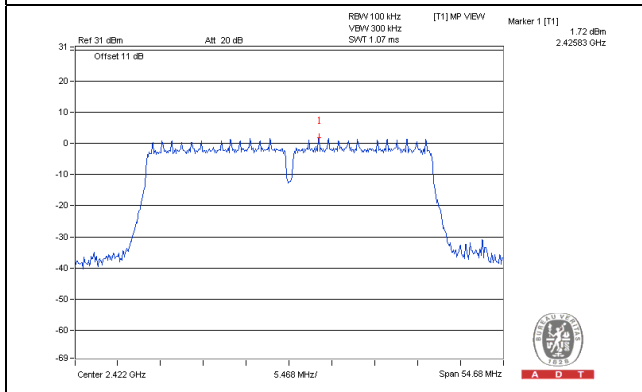

CH 6

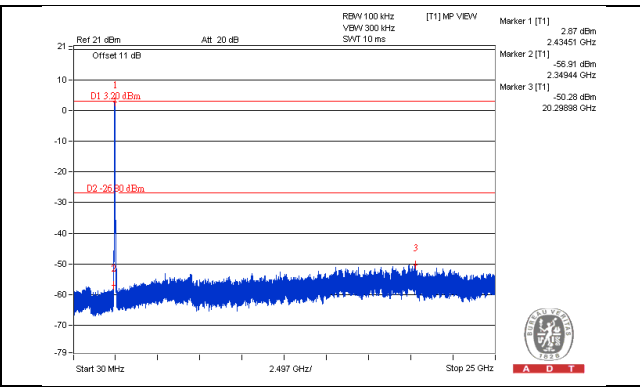
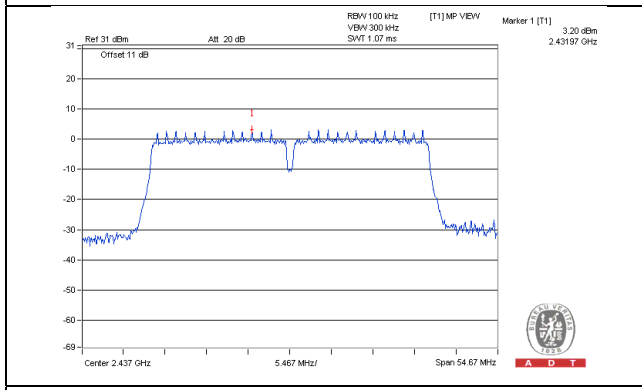

CH 9

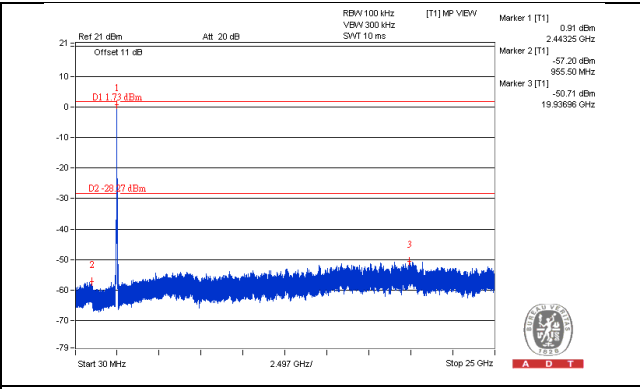
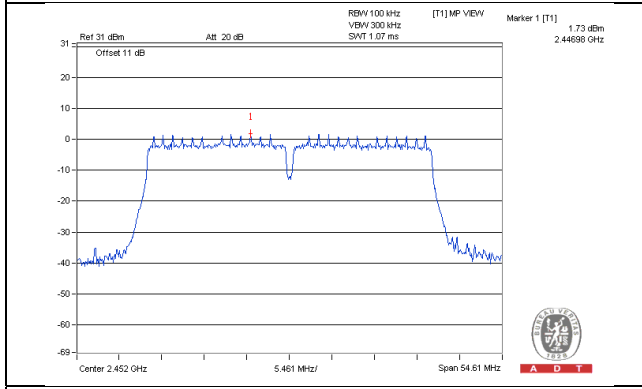

CH 3 Band edge

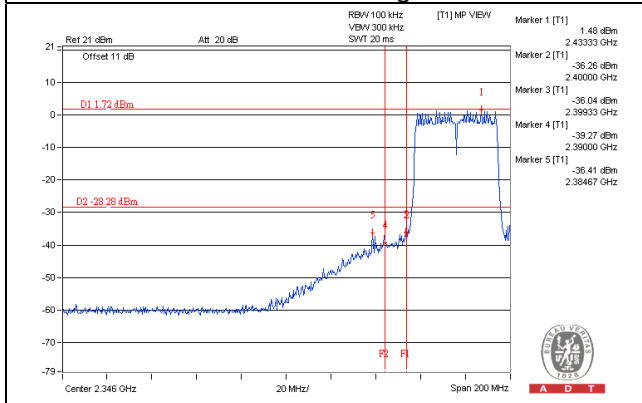

CH 9 Band edge

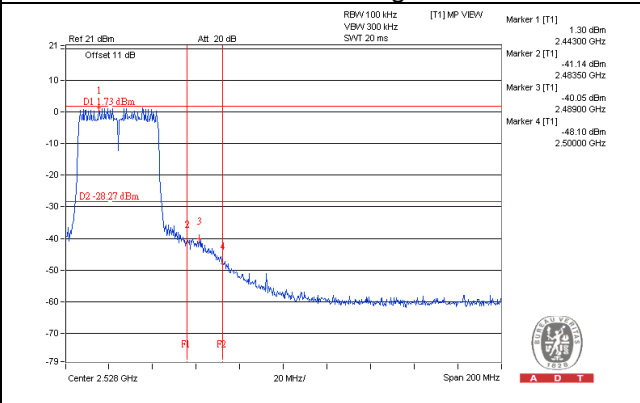

Test Mode A

2TX

802.11b_Chain 0

CH 1

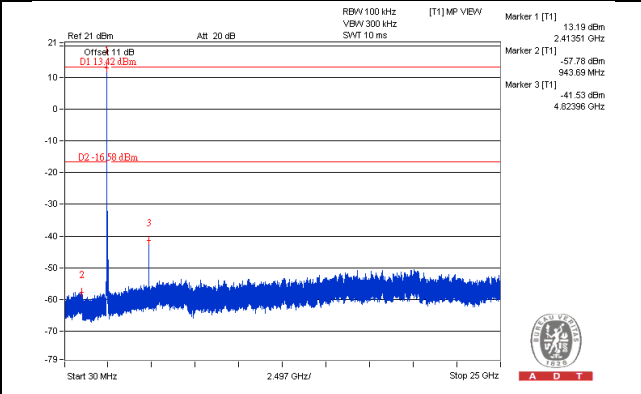
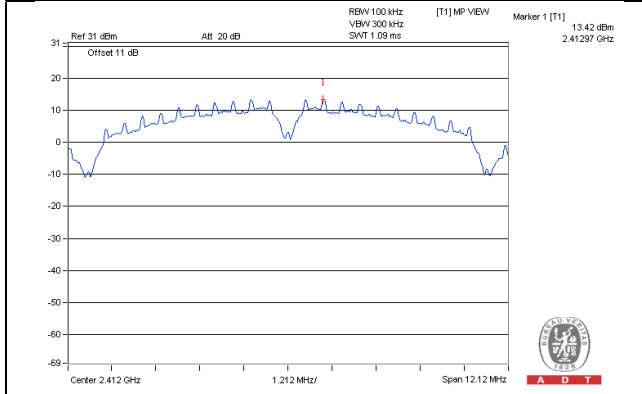

CH 6

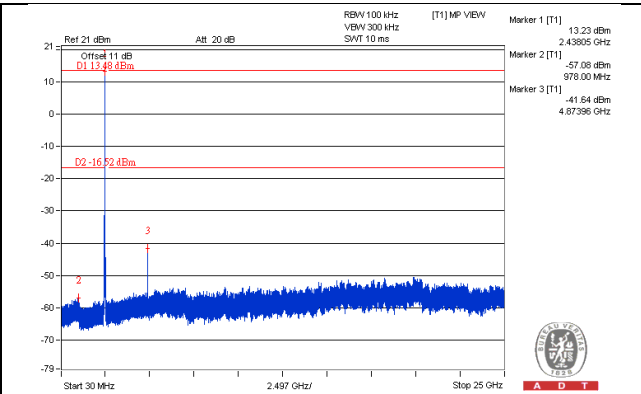
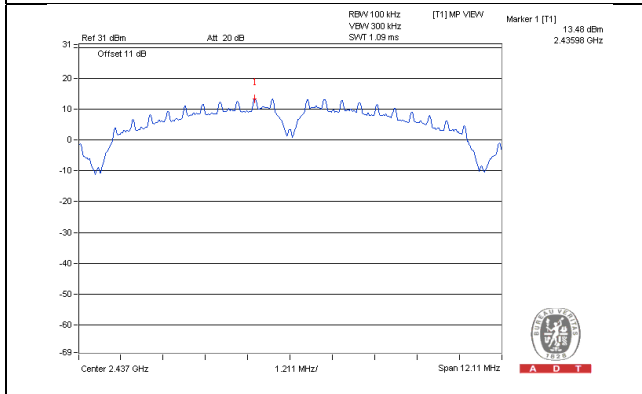

CH 11

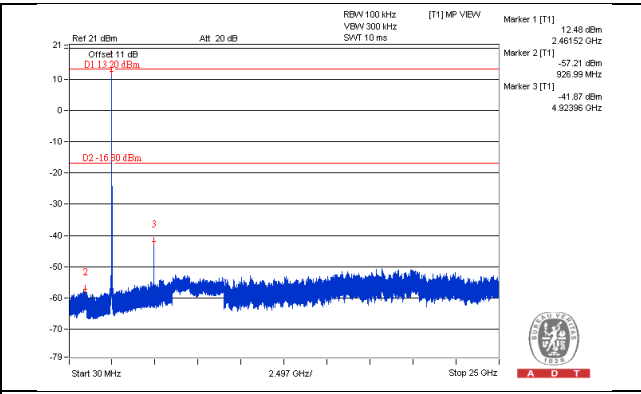
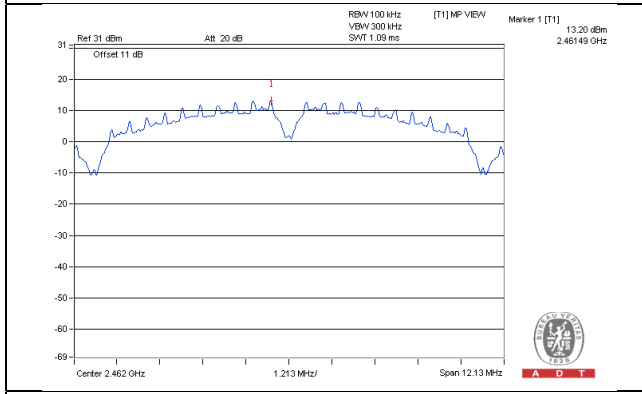

CH 1 Band edge

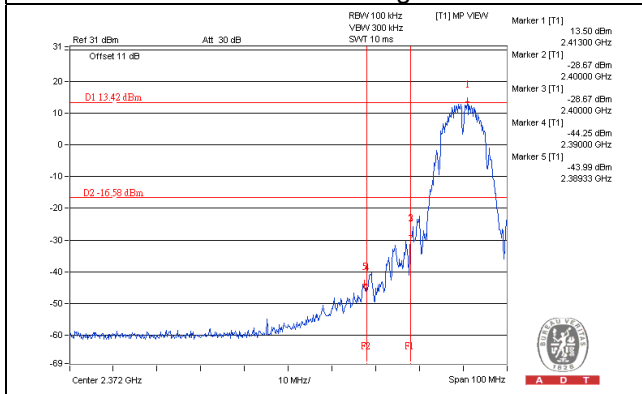

CH 11 Band edge

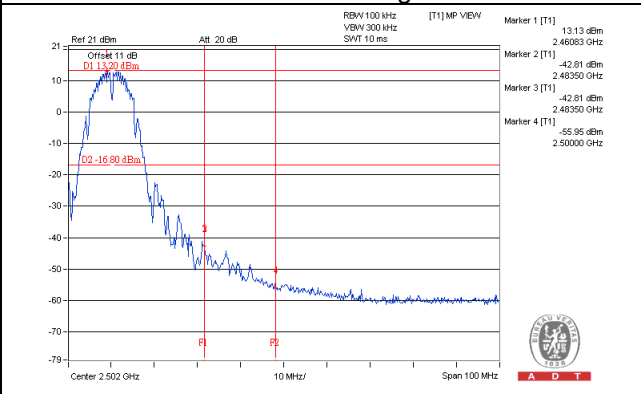

802.11b_Chain 1

CH 1

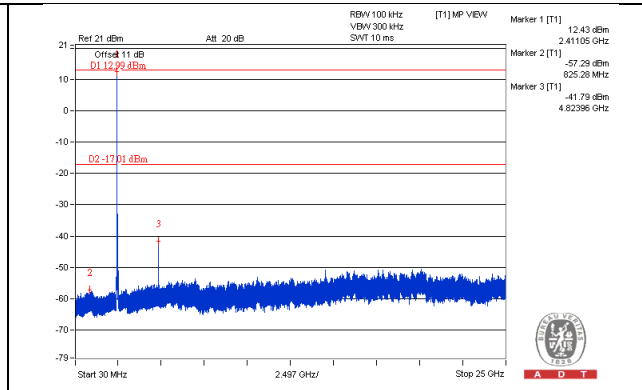
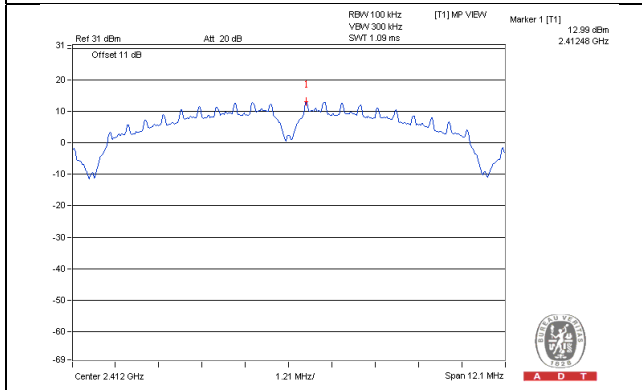

CH 6

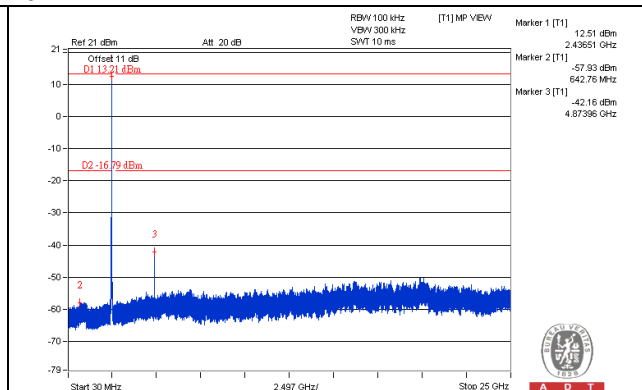
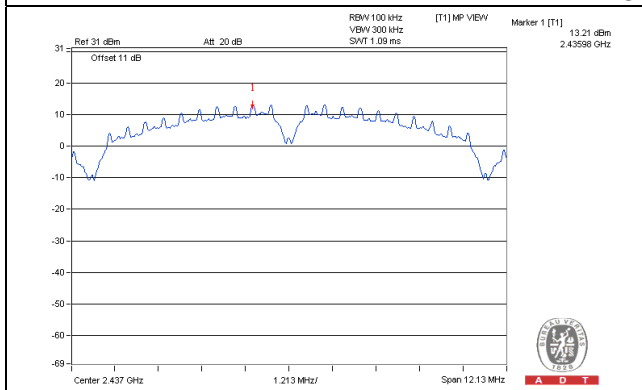

CH 11

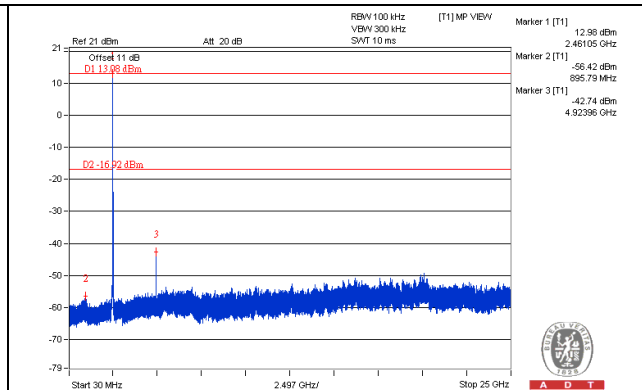
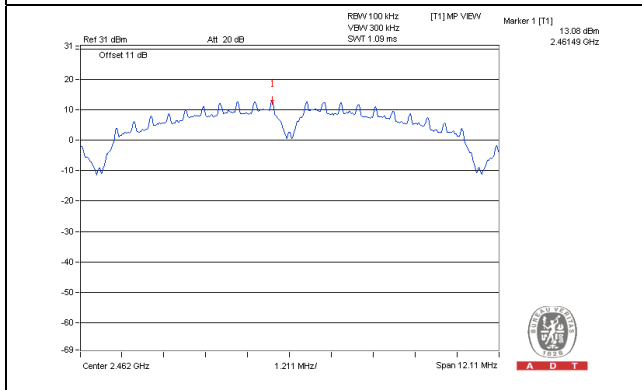

CH 1 Band edge

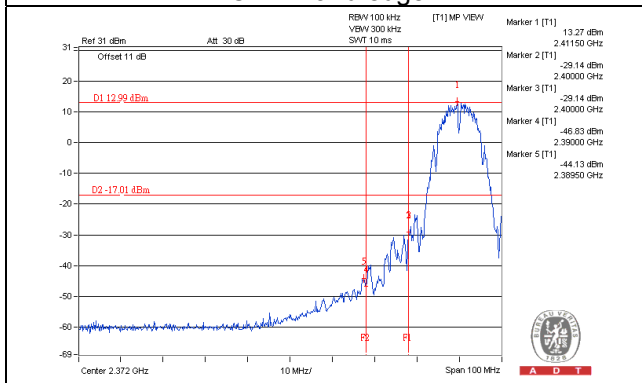

CH 11 Band edge

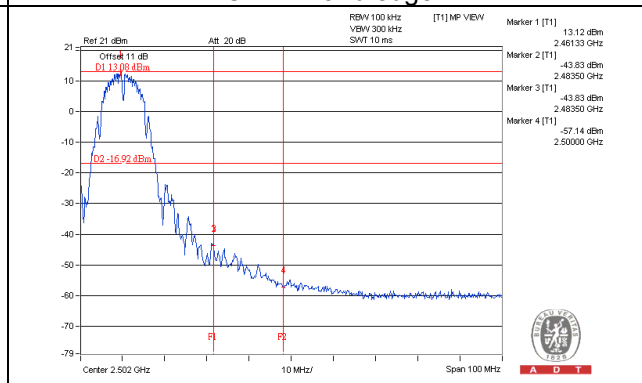

802.11g_Chain 0

CH 1

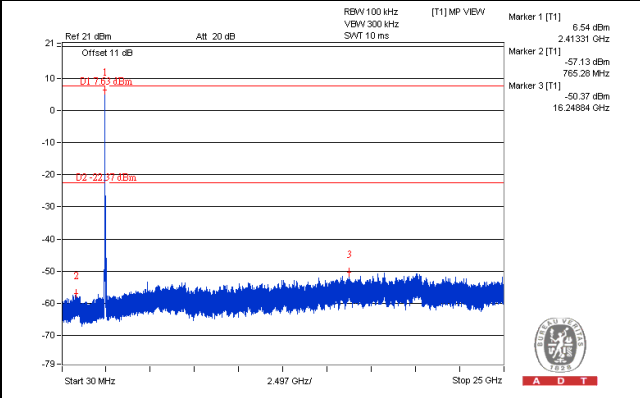
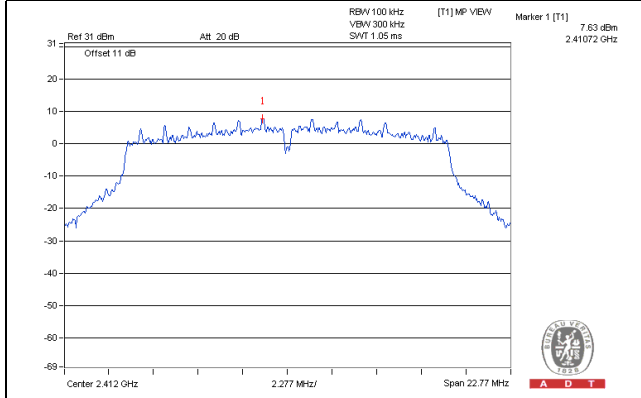

CH 6

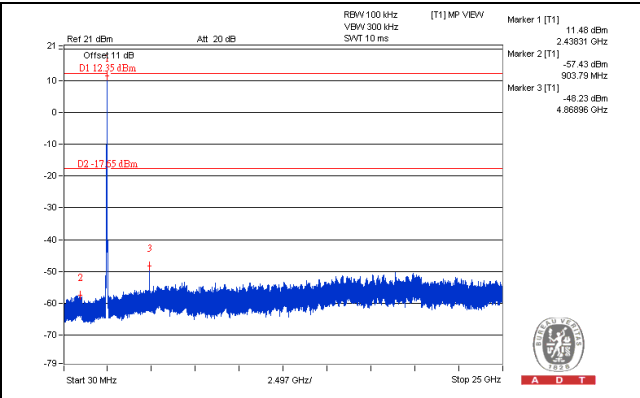
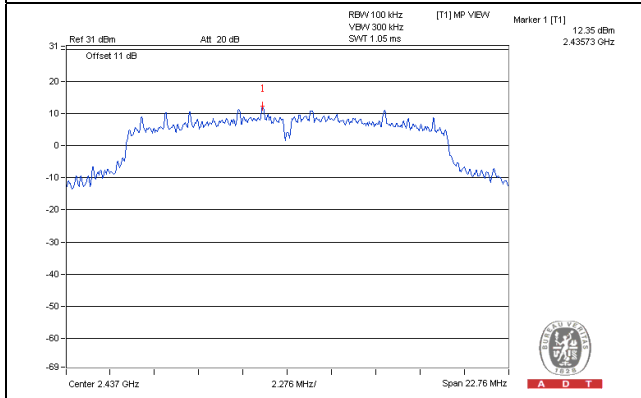

CH 11

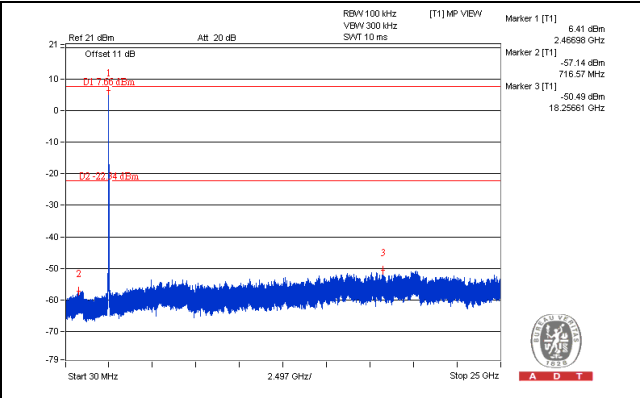
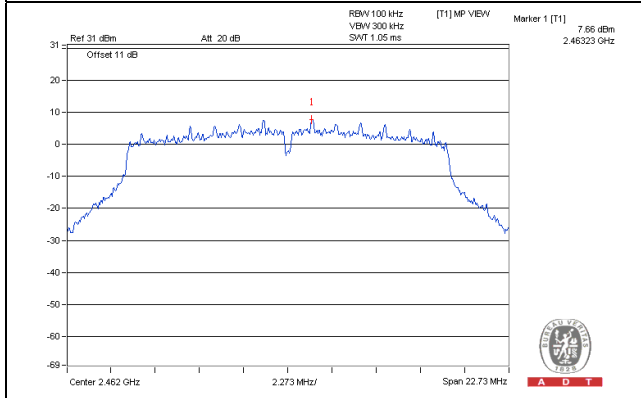

CH 1 Band edge

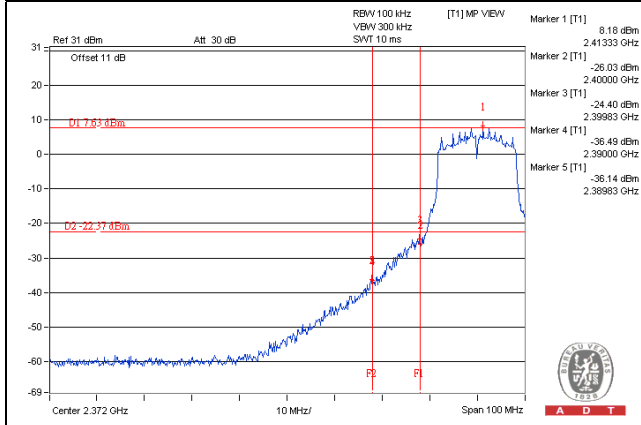

CH 11 Band edge

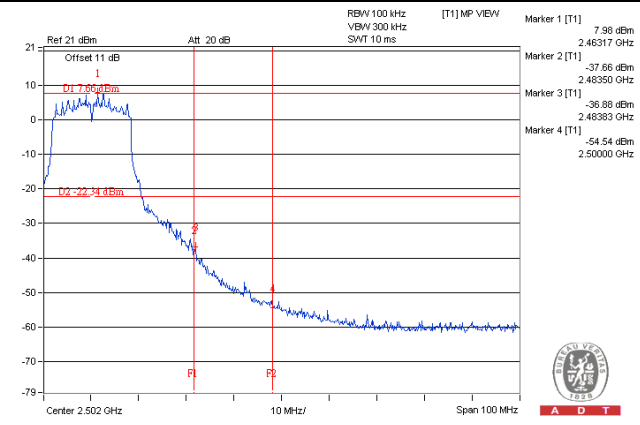

802.11g_Chain 1

CH 1

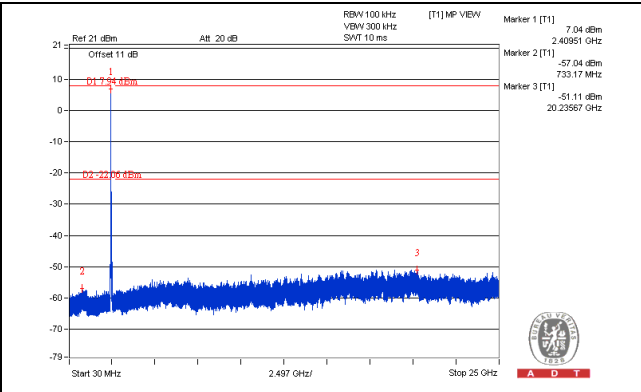
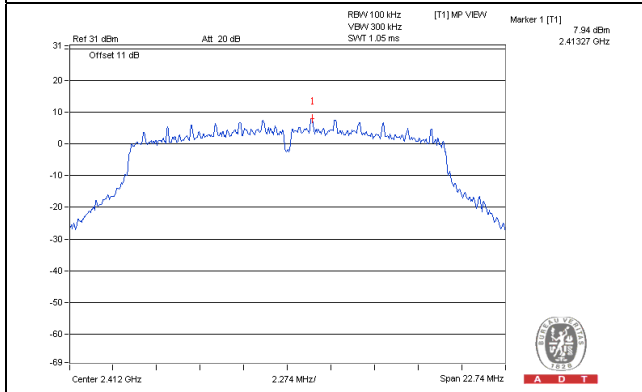

CH 6

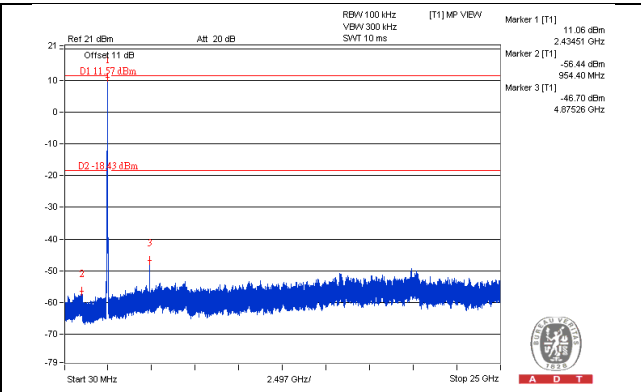
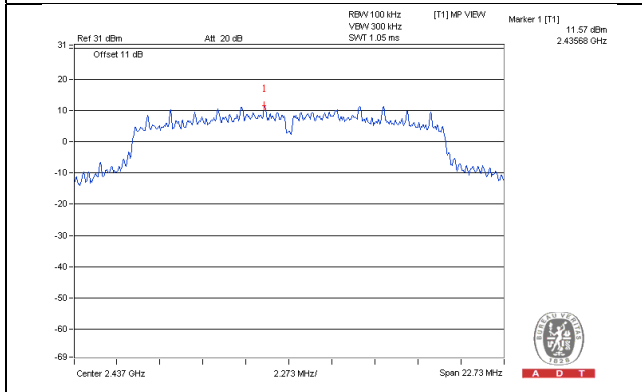

CH 11

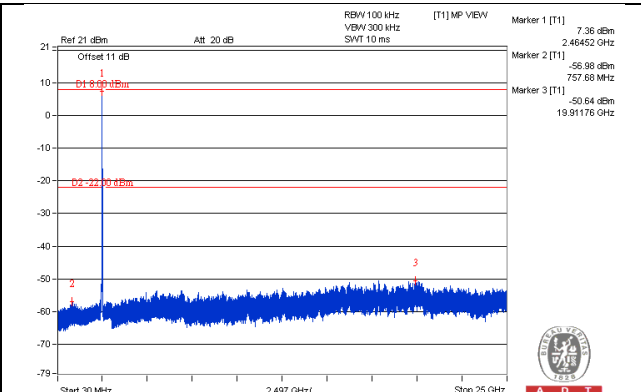
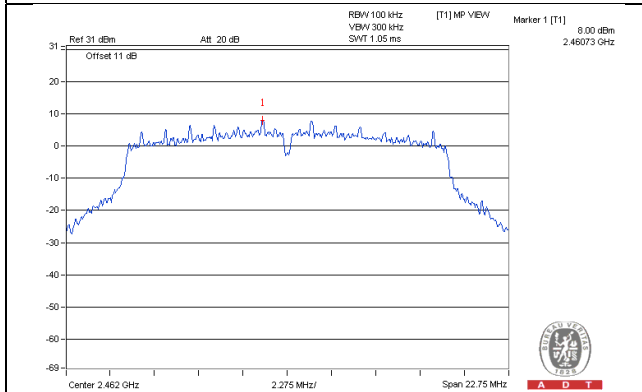

CH 1 Band edge

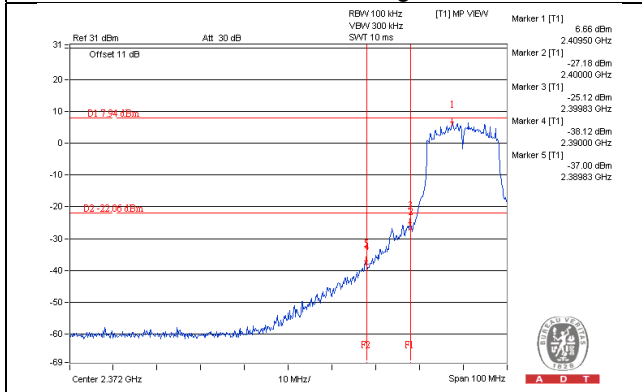

CH 11 Band edge

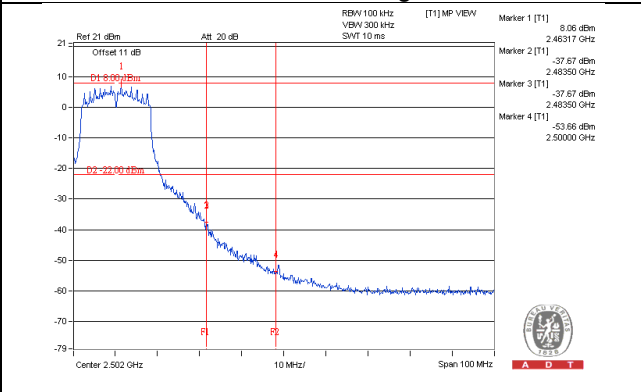

802.11n (HT20)_Chain 0

CH 1

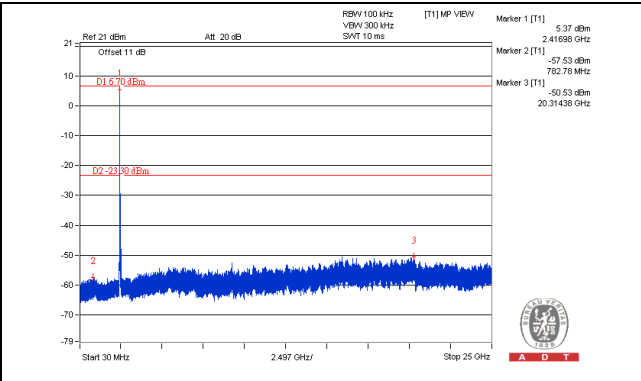
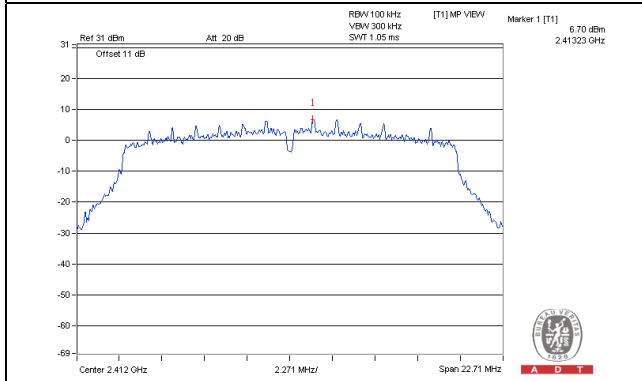

CH 6

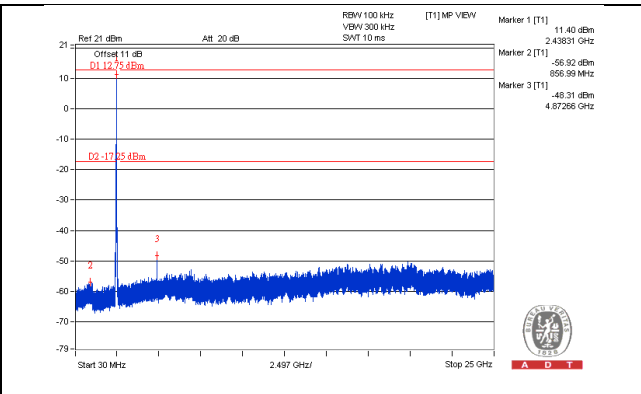
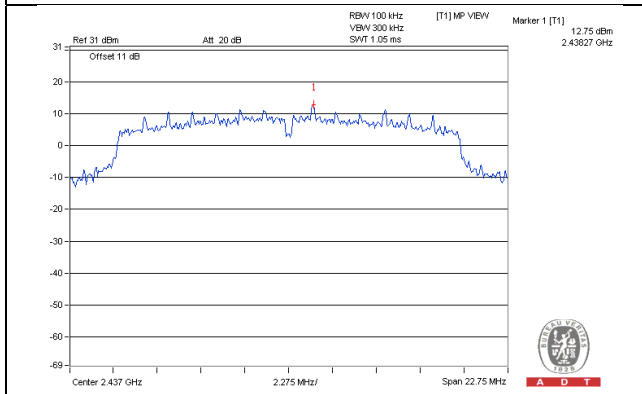

CH 11

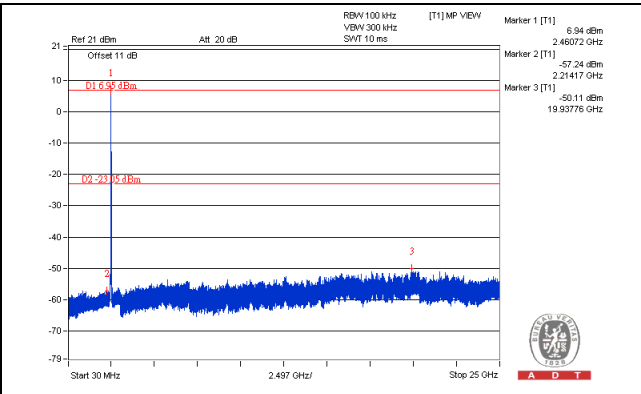
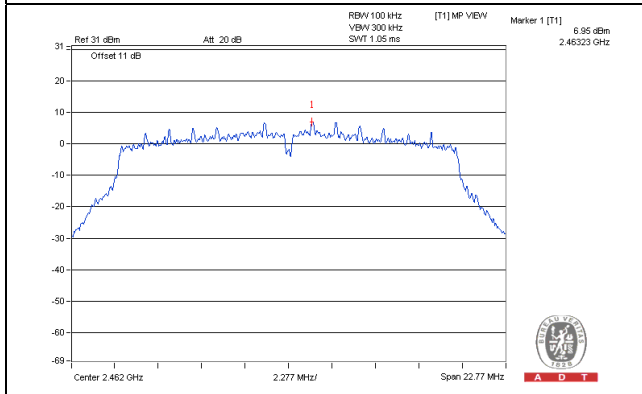

CH 1 Band edge

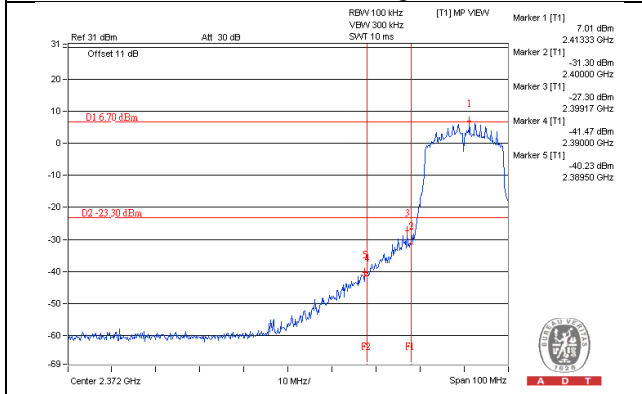

CH 11 Band edge

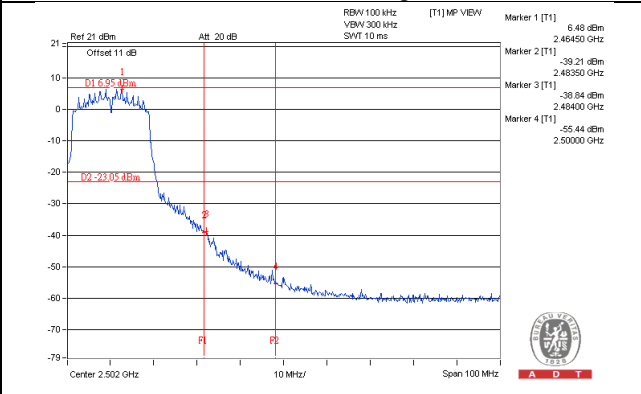

802.11n (HT20)_Chain 1

CH 1

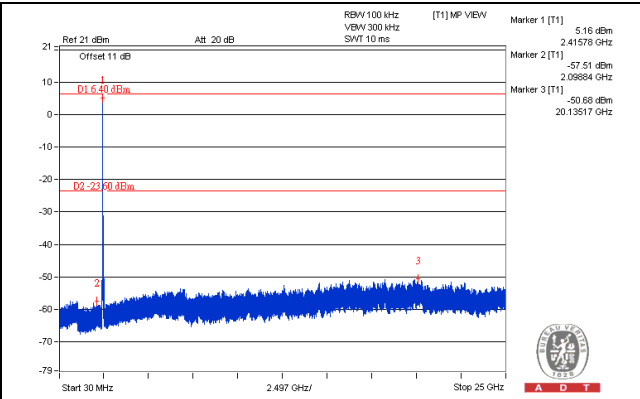
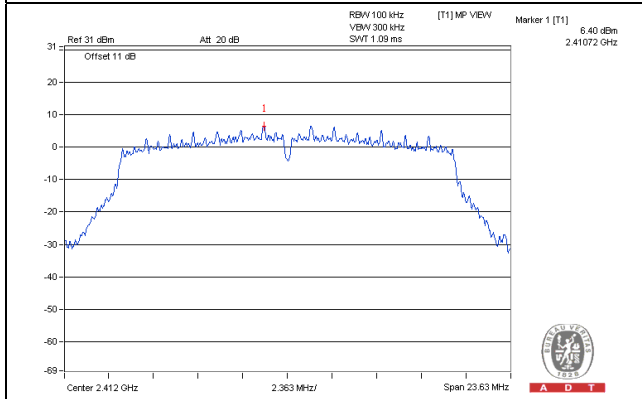

CH 6

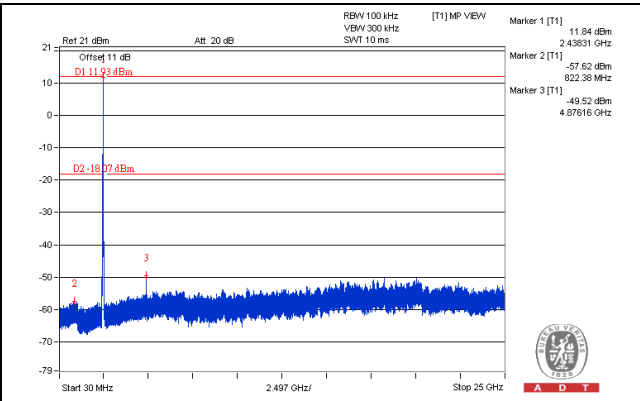
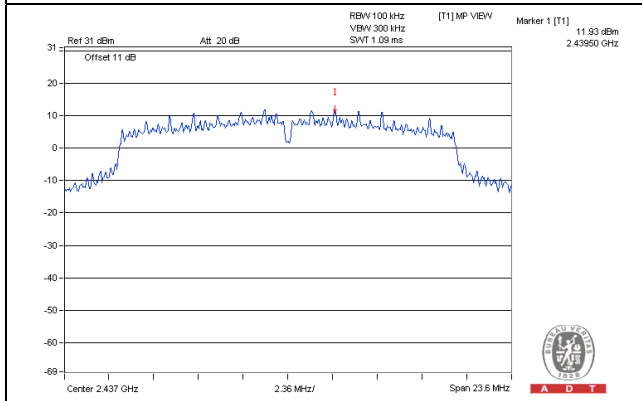

CH 11

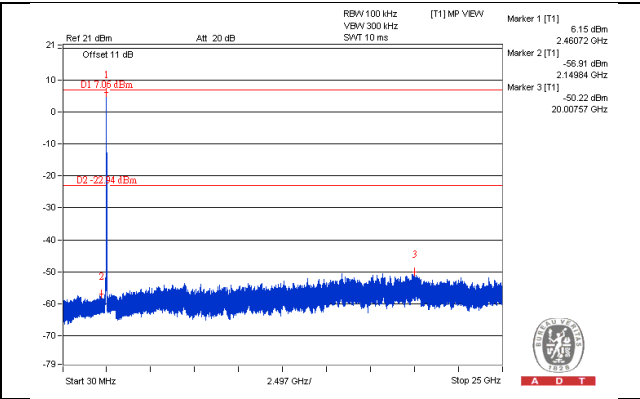
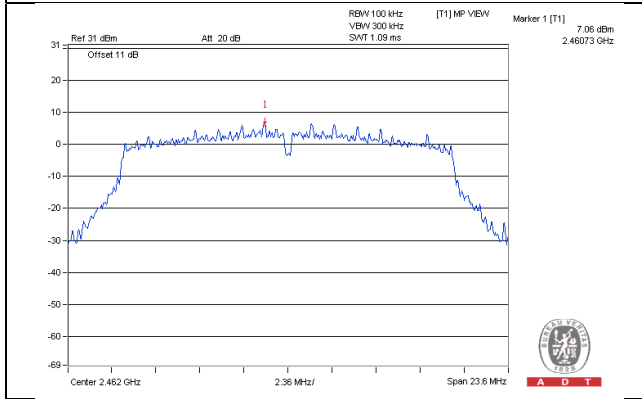

CH 1 Band edge

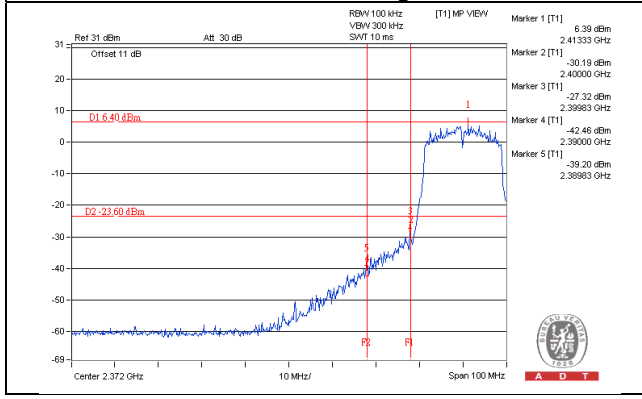

CH 11 Band edge

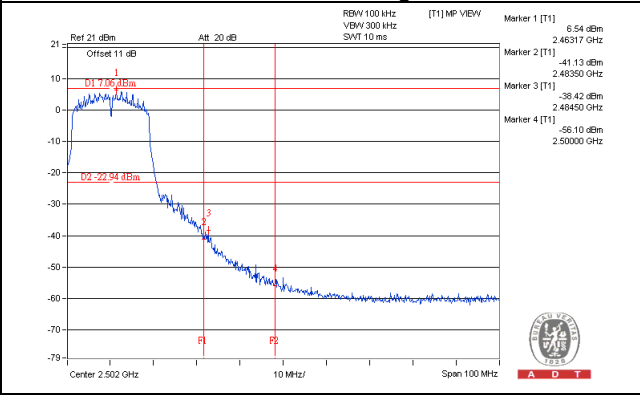

802.11n (HT40)_Chain 0

CH 3

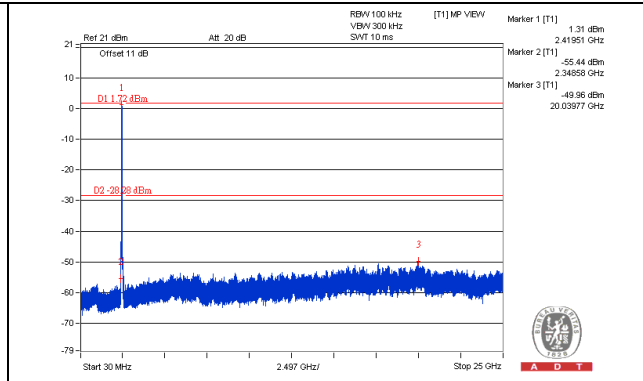
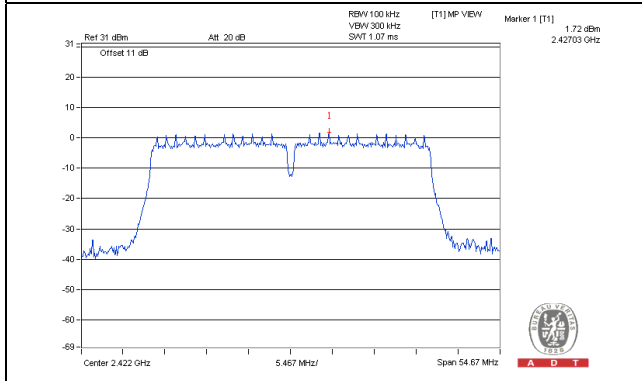

CH 6

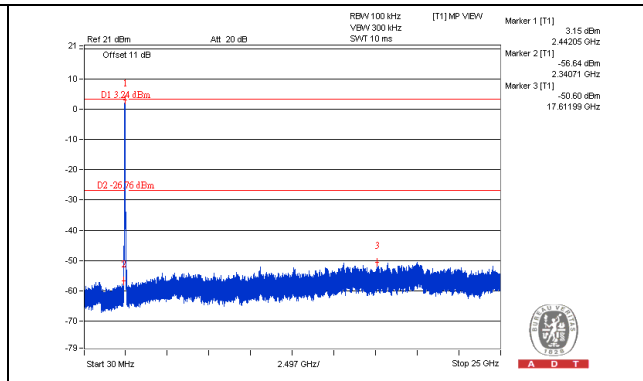
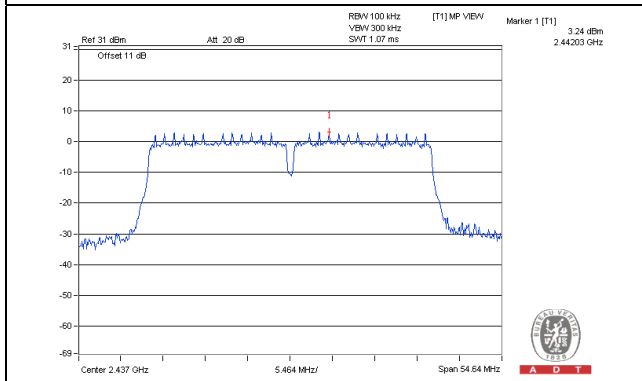

CH 9

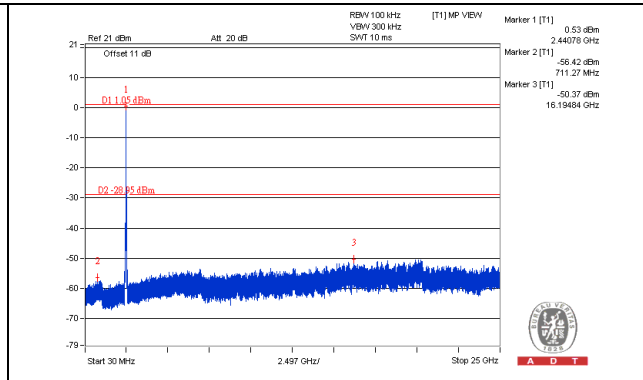
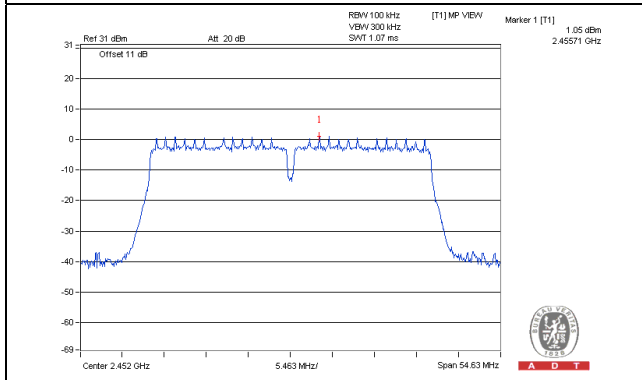

CH 3 Band edge

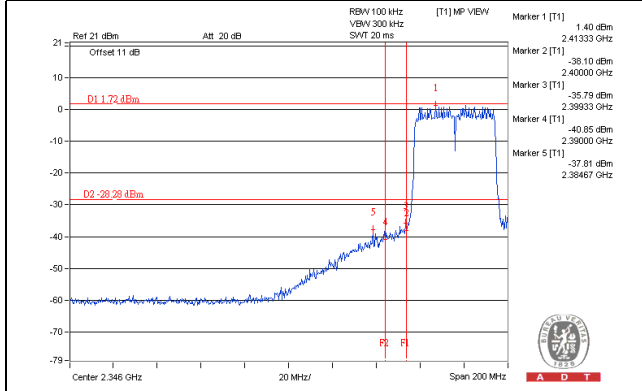

CH 9 Band edge

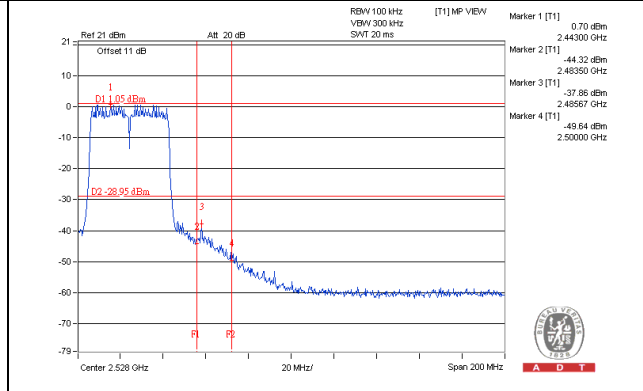

802.11n (HT40)_Chain 1

CH 3

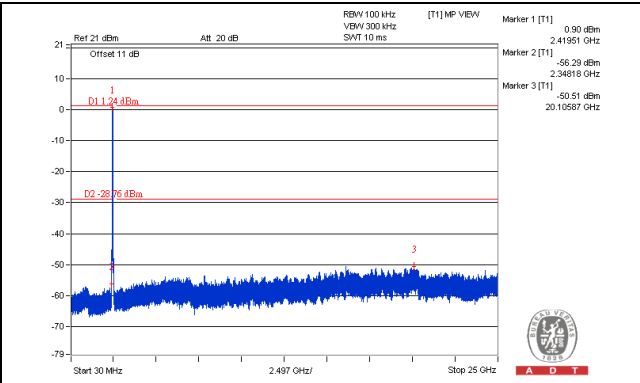
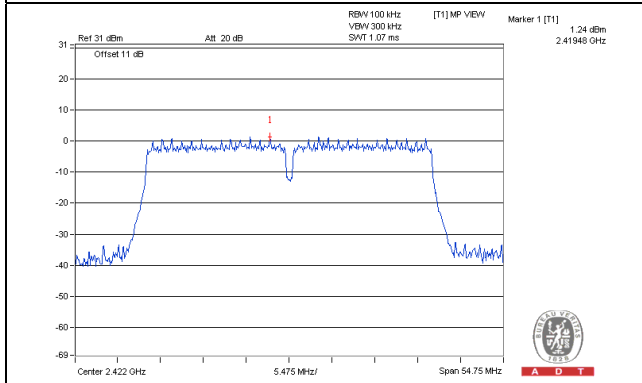

CH 6

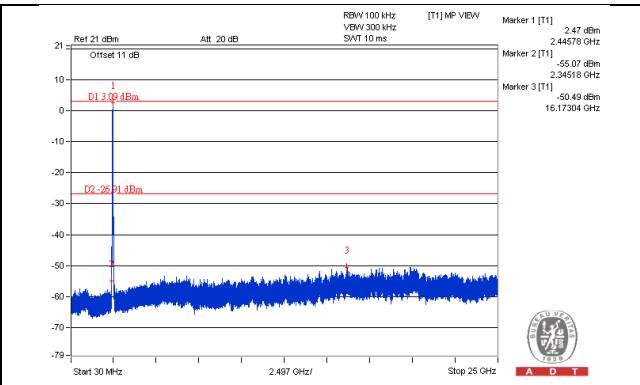
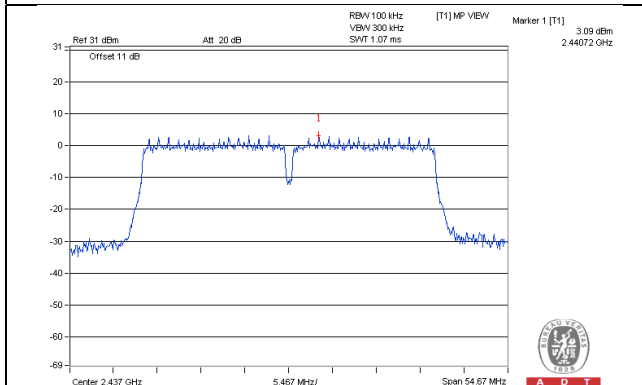

CH 9

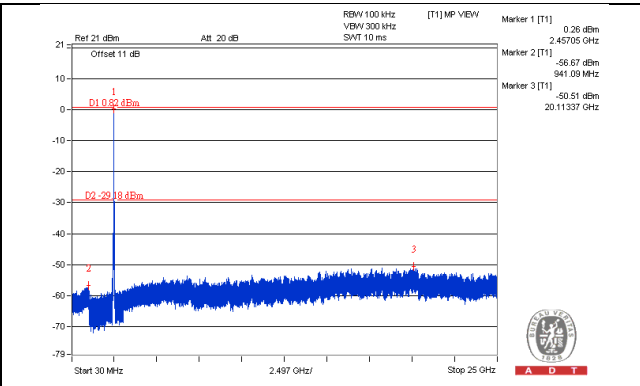
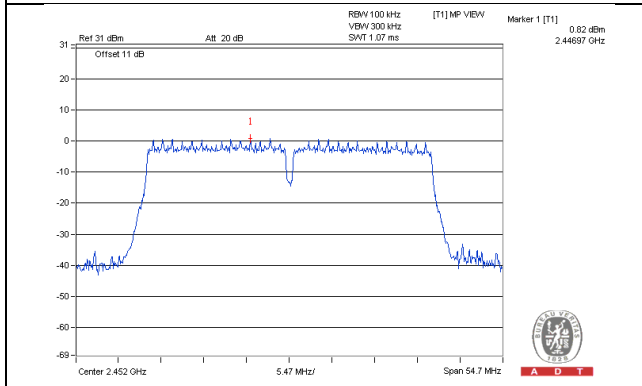

CH 3 Band edge

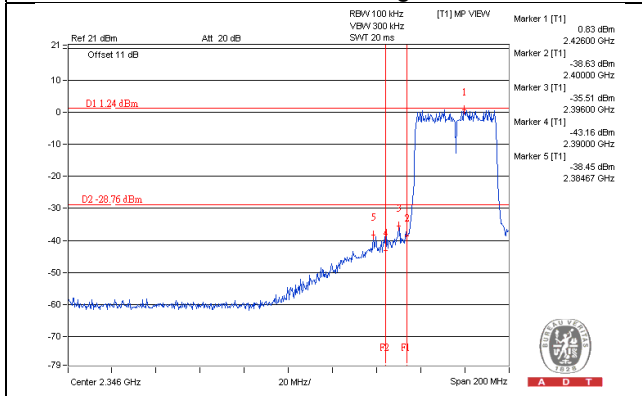

CH 9 Band edge

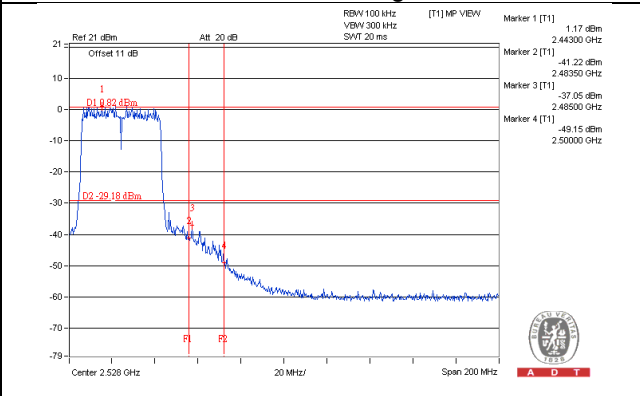

Test Mode A

3TX

802.11b_Chain 0

CH 1

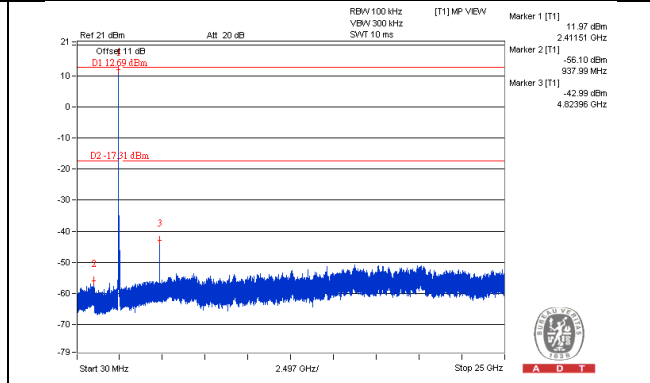
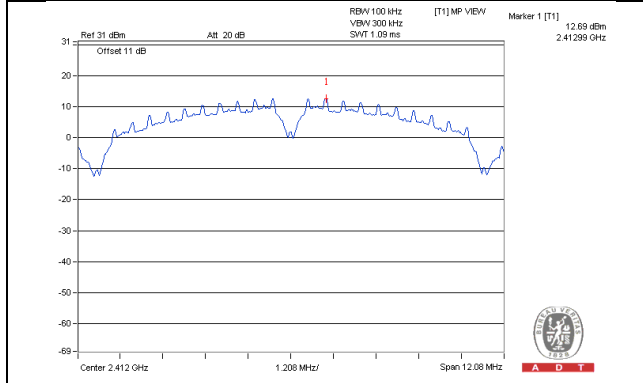

CH 6

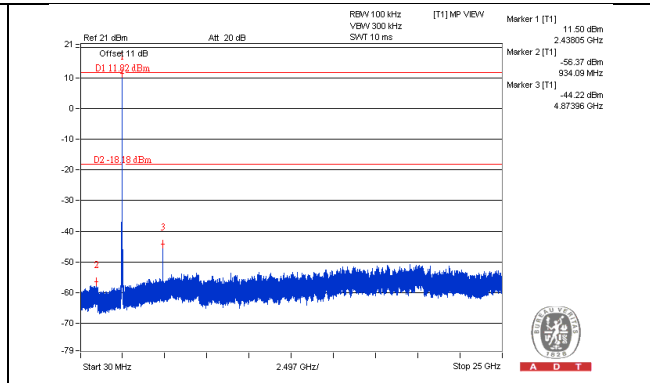
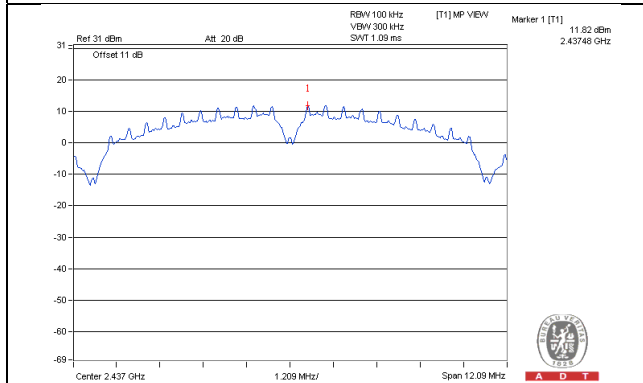

CH 11

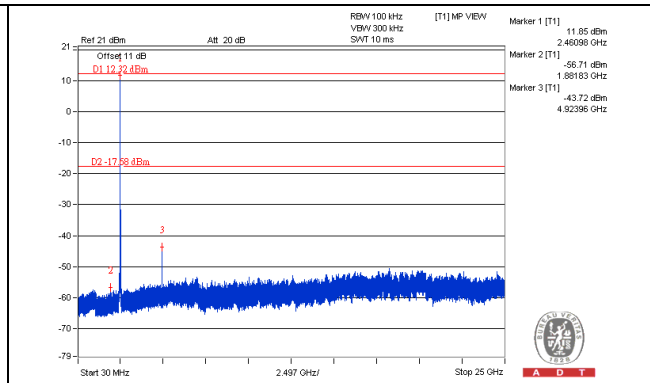
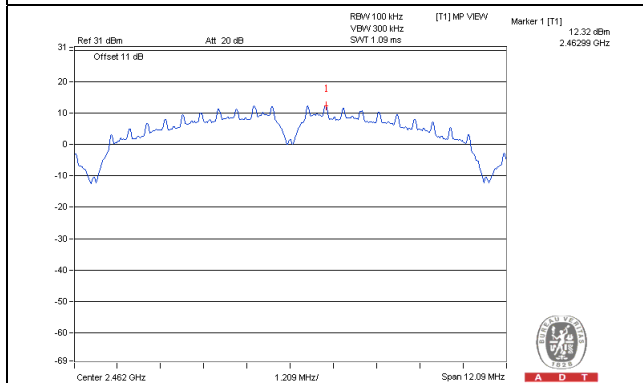

CH 1 Band edge

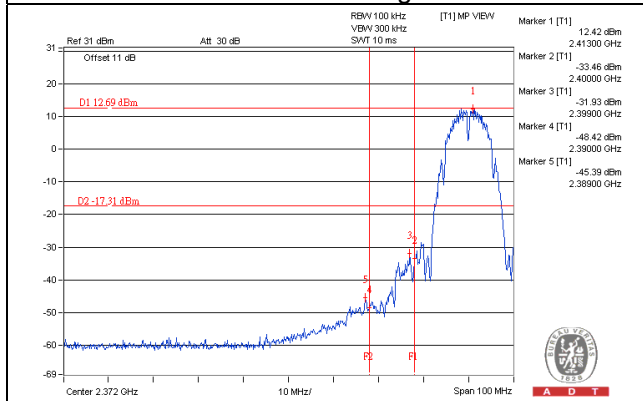

CH 11 Band edge

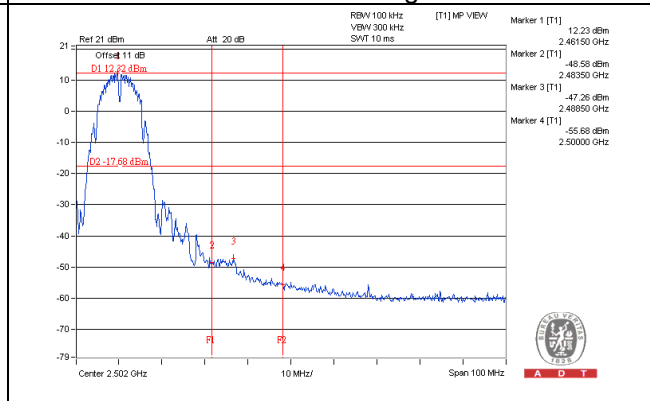

802.11b_Chain 1

CH 1

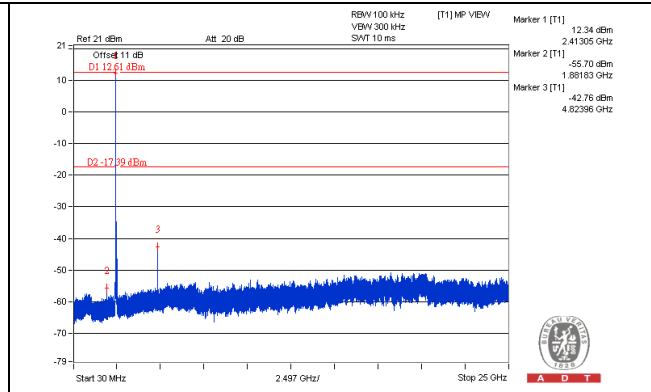
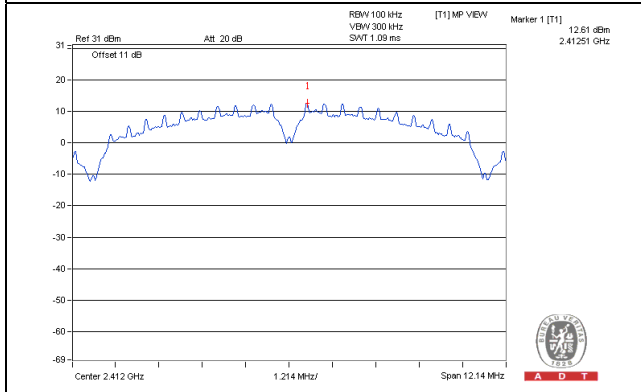

CH 6

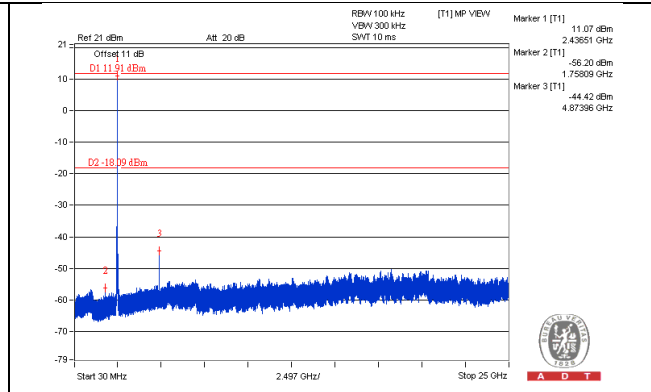
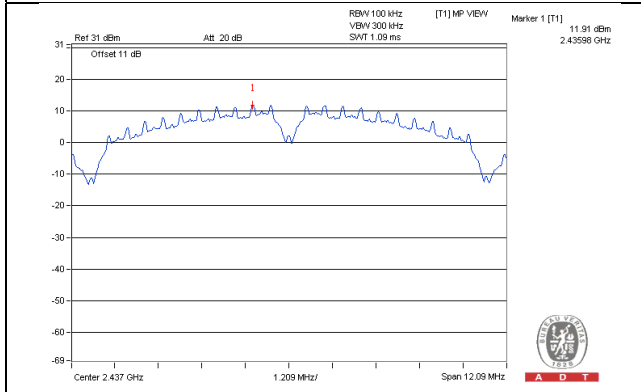

CH 11

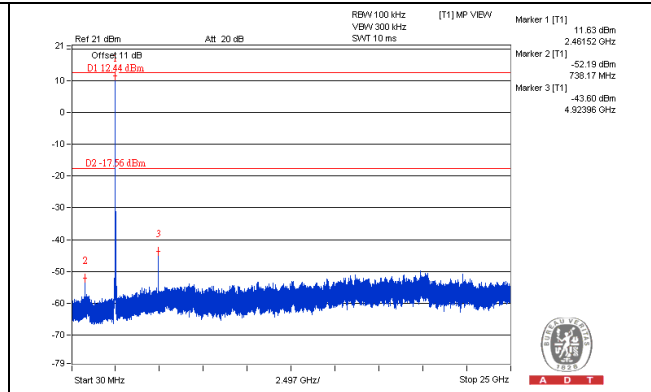
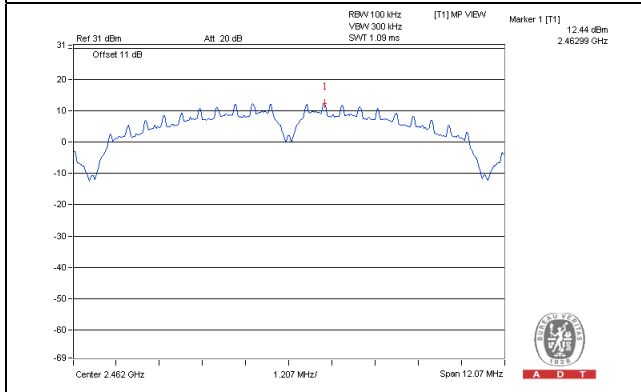

CH 1 Band edge

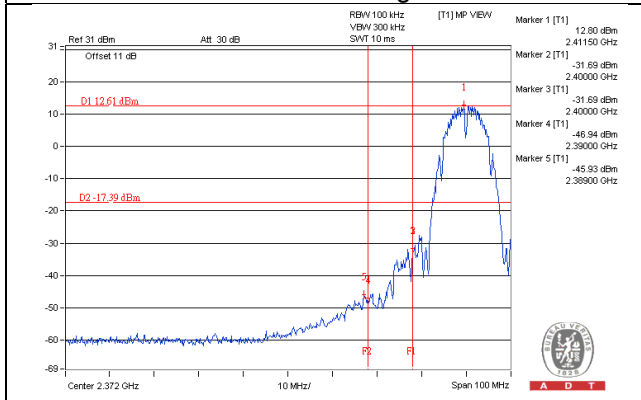

CH 11 Band edge

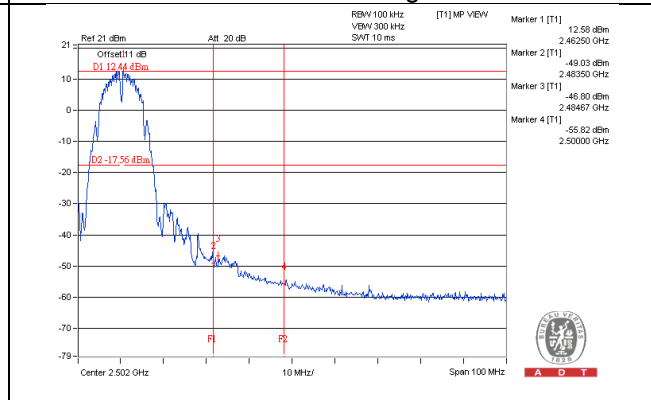

802.11b_Chain 2

CH 1

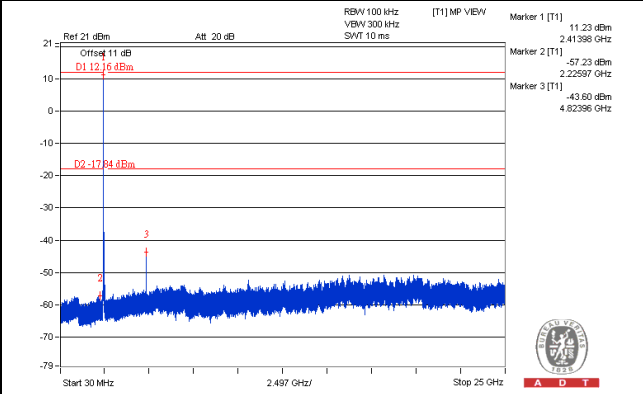
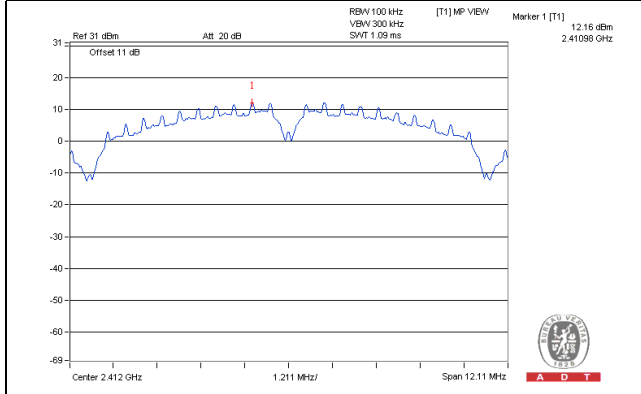

CH 6

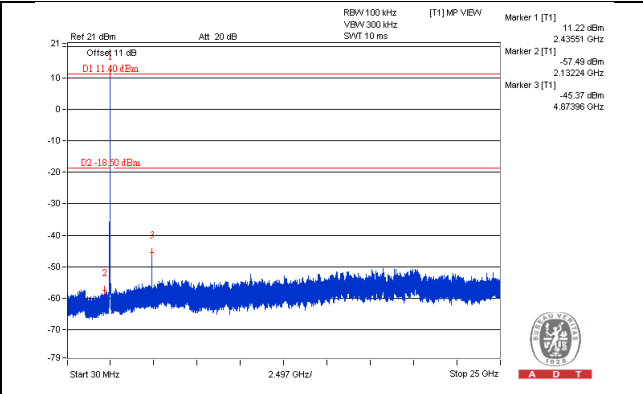
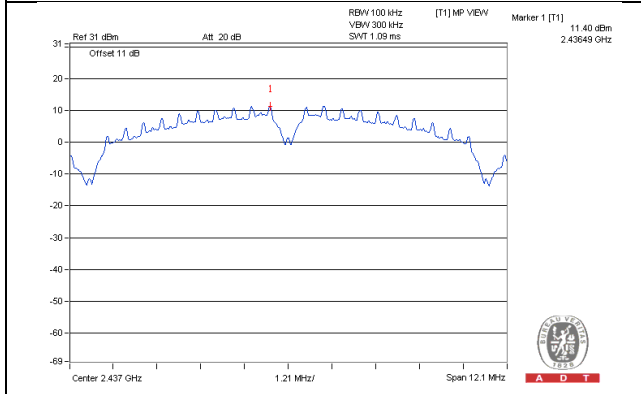

CH 11

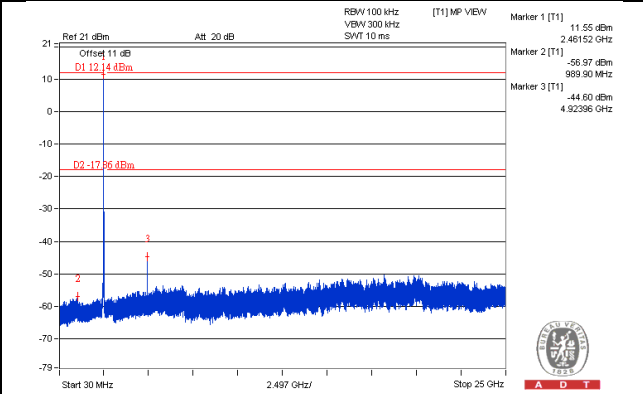
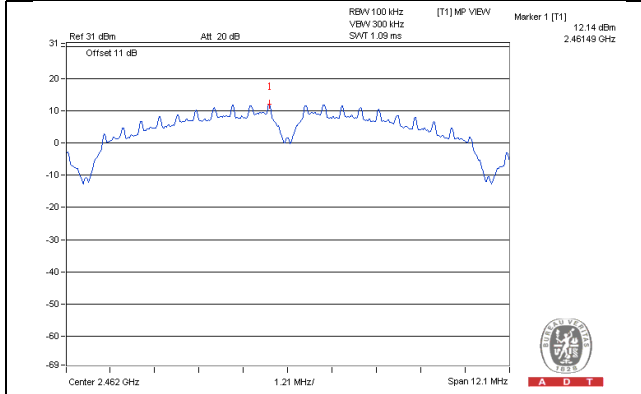

CH 1 Band edge

CH 11 Band edge

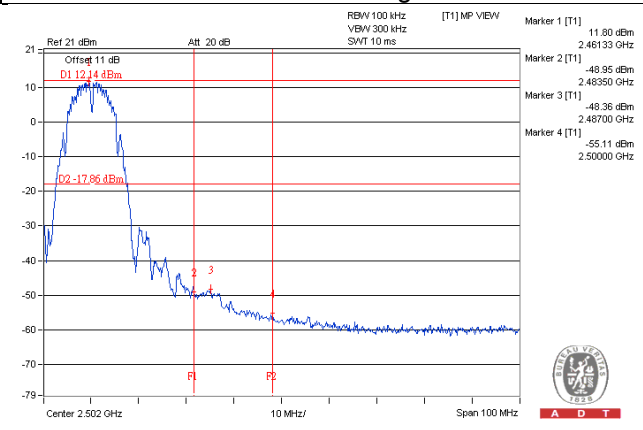
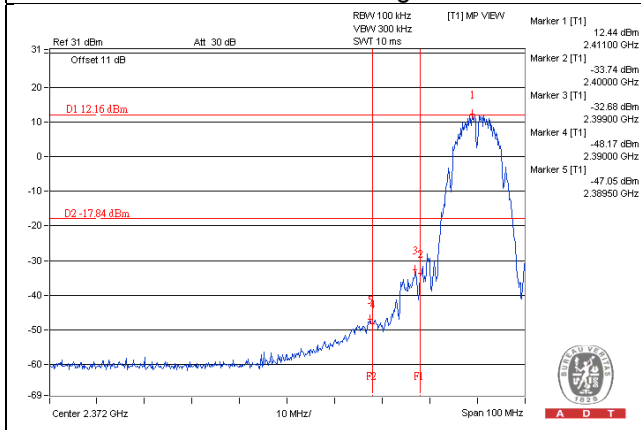

802.11g_Chain 0

CH 1

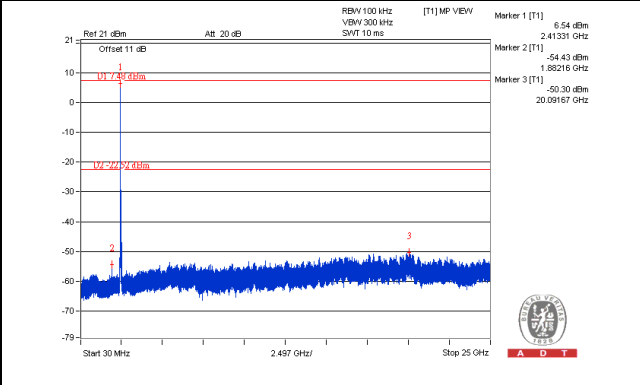
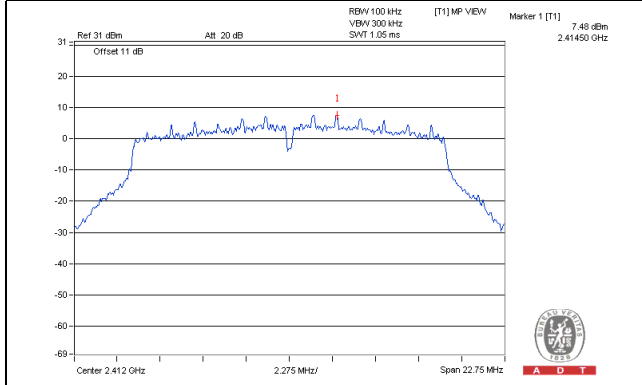

CH 6

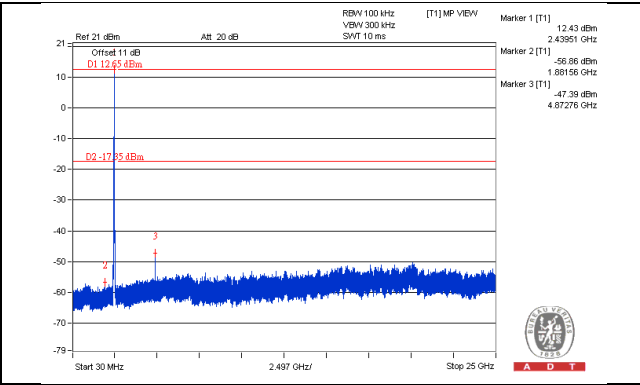
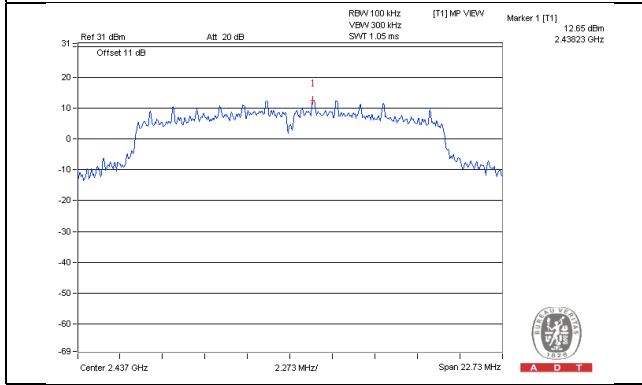

CH 11

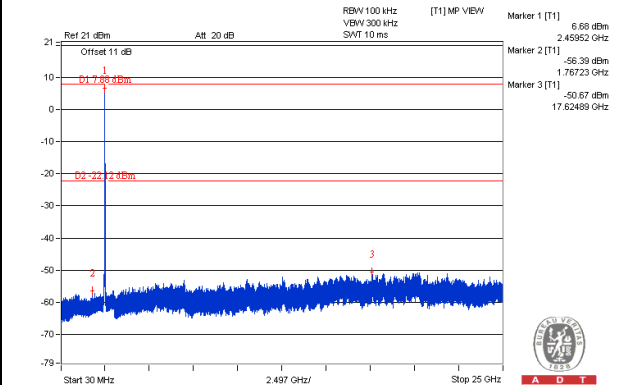
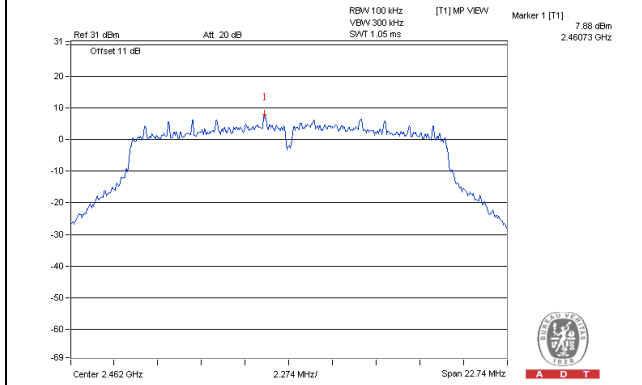

CH 1 Band edge

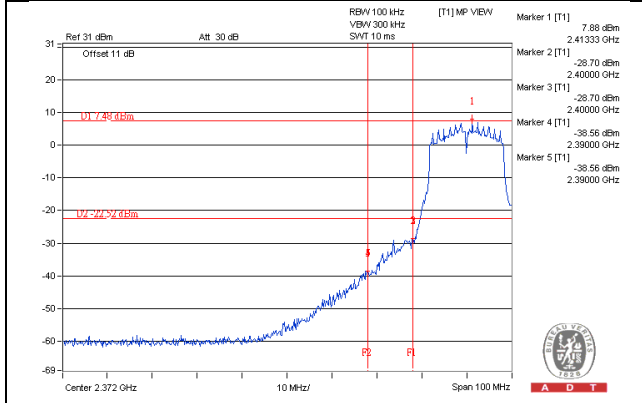

CH 11 Band edge

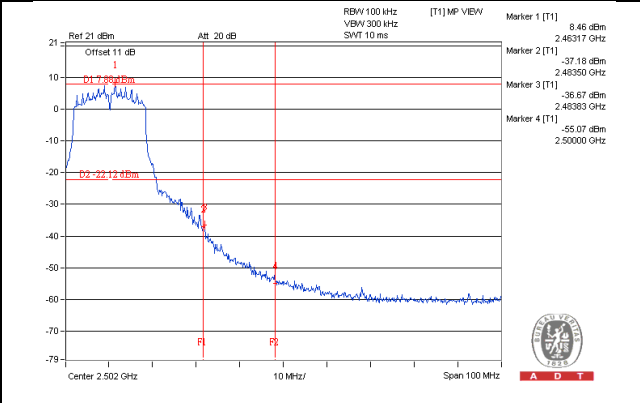

802.11g_Chain 1

CH 1

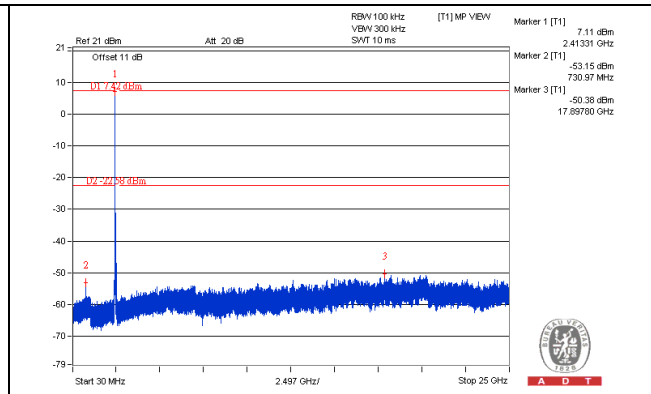
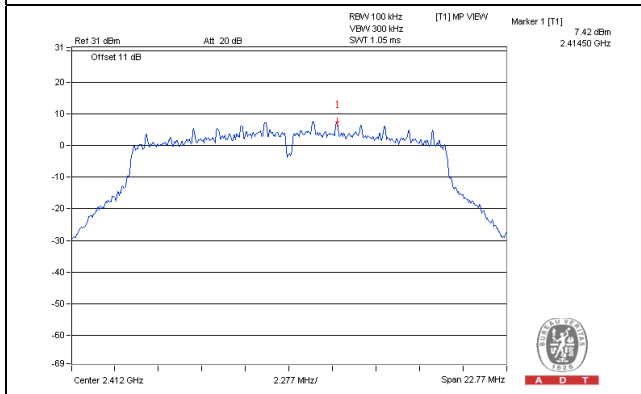

CH 6

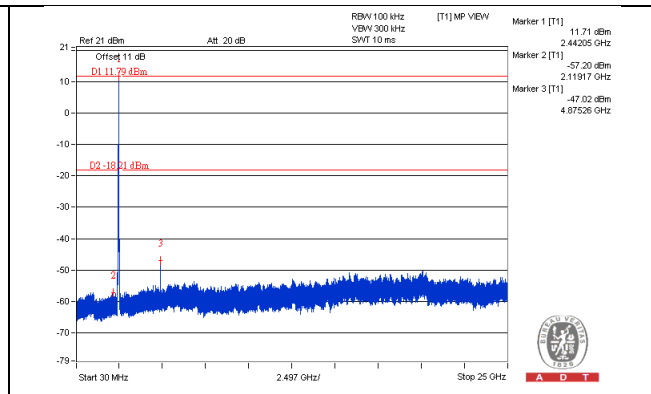
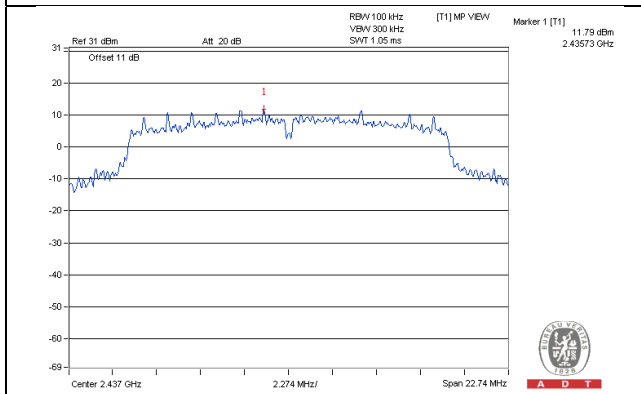

CH 11

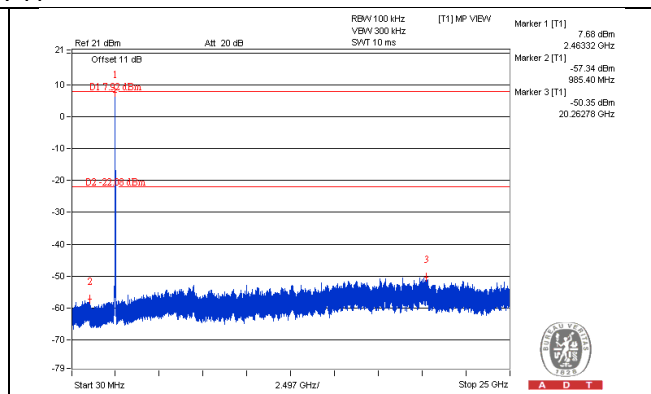
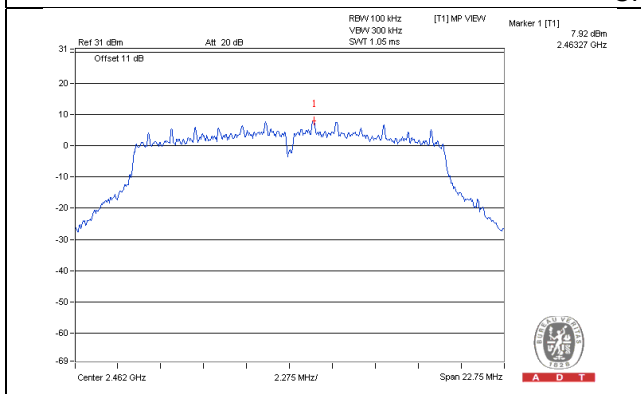

CH 1 Band edge

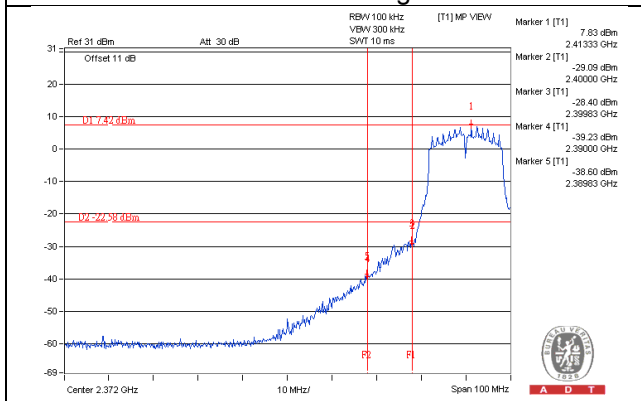

CH 11 Band edge

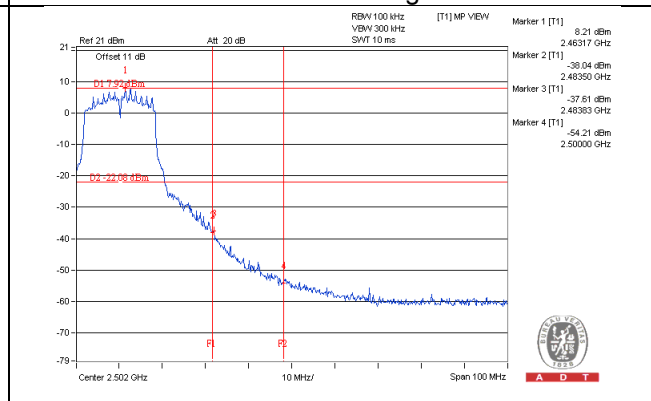

802.11g_Chain 2

CH 1

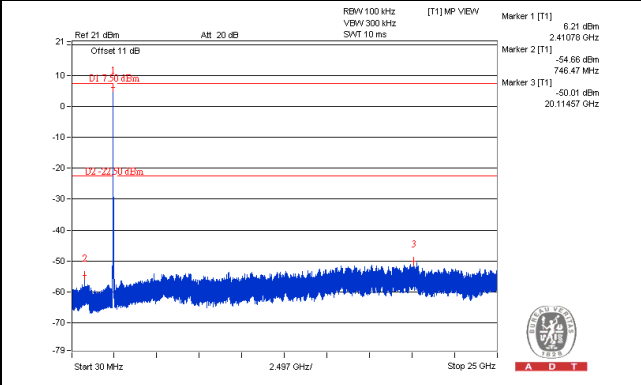
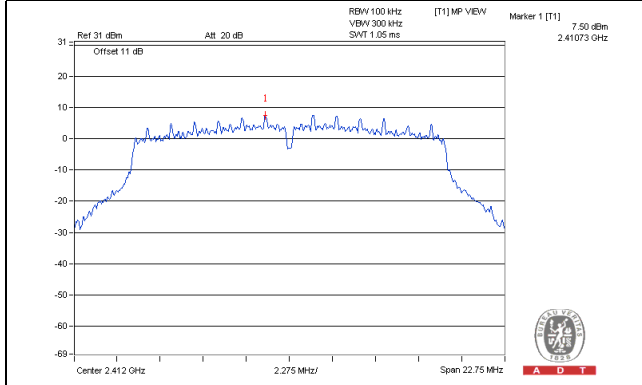

CH 6

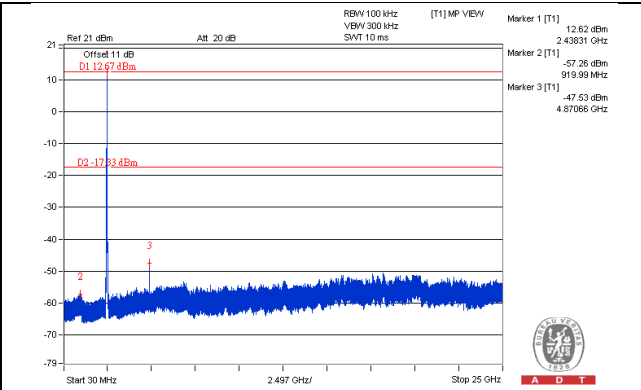
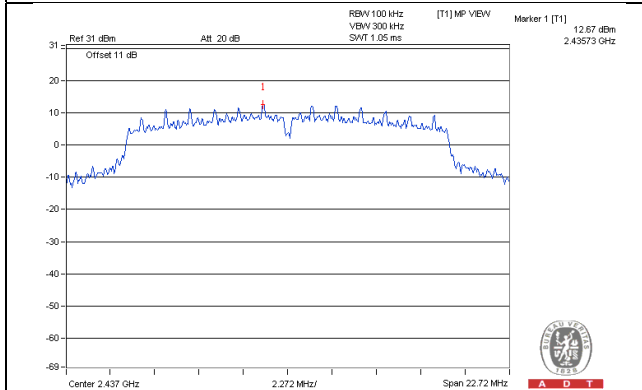

CH 11

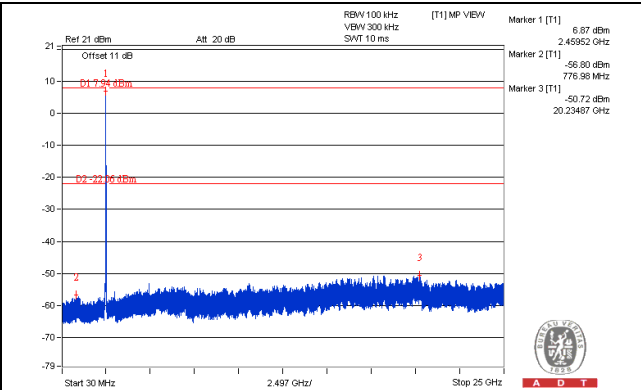
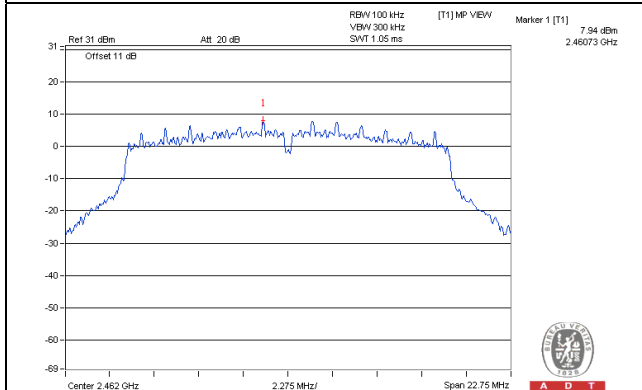

CH 1 Band edge

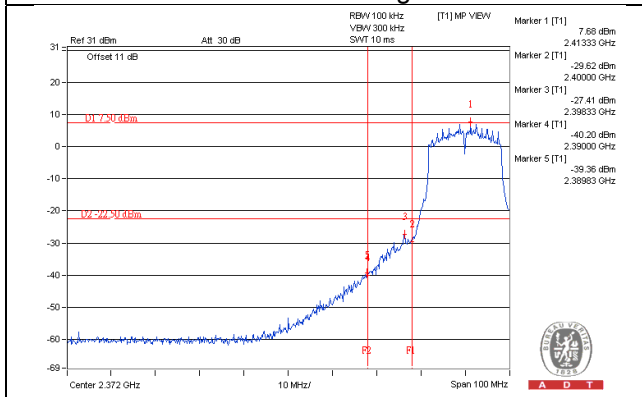

CH 11 Band edge

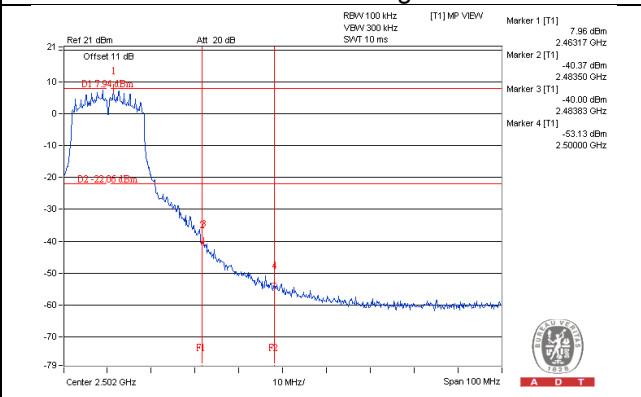

802.11n (HT20)_Chain 0

CH 1

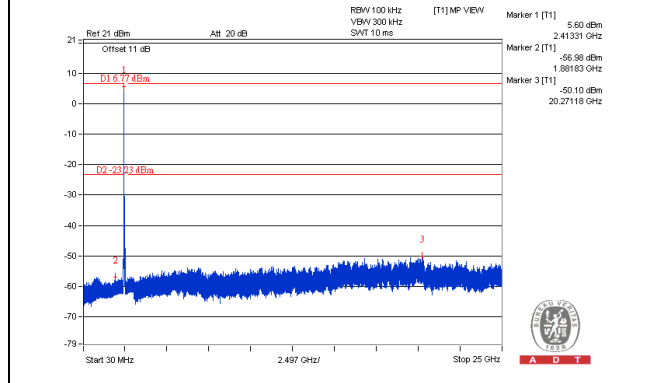
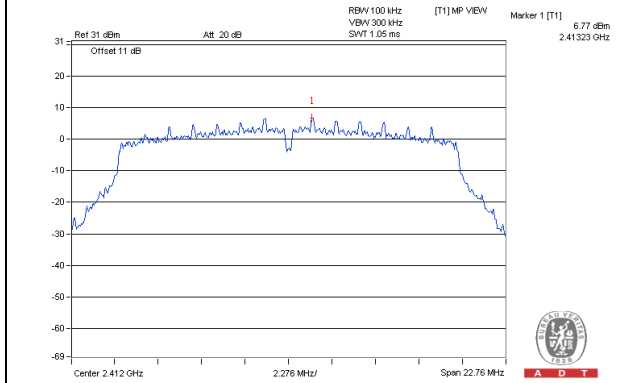

CH 6

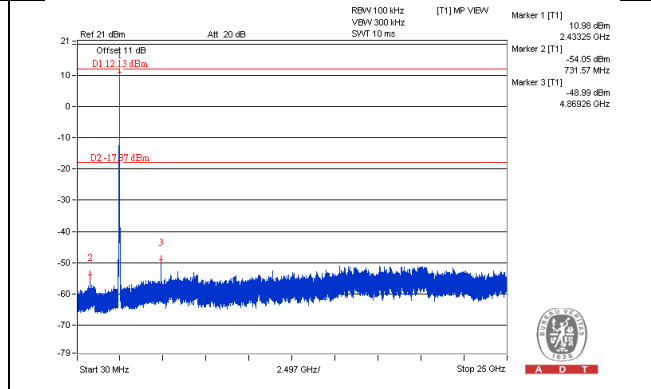
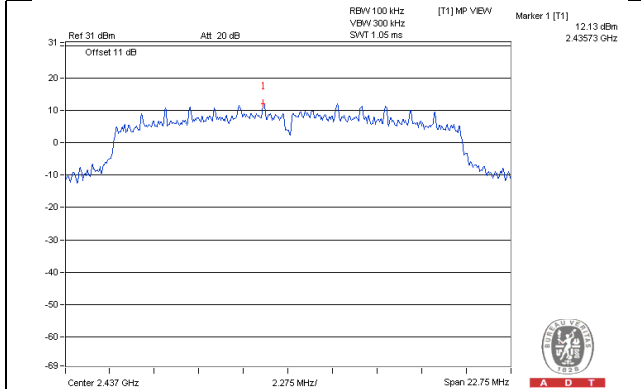

CH 11

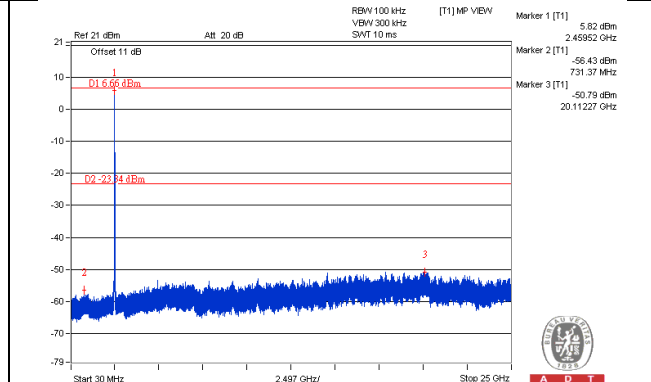
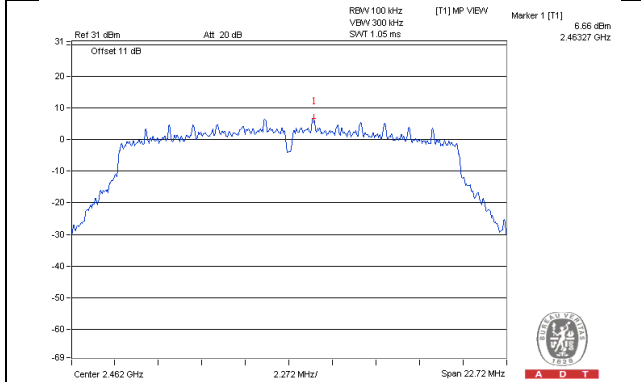

CH 1 Band edge

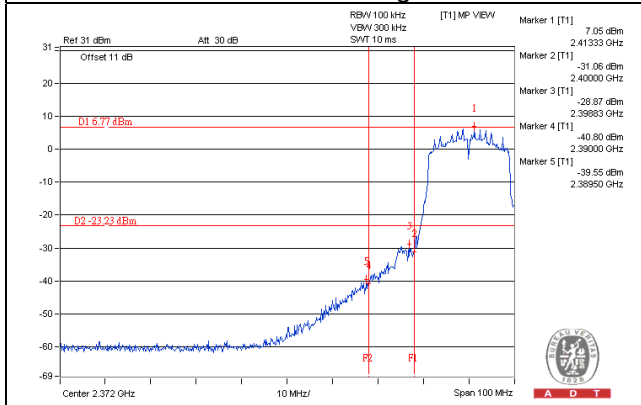

CH 11 Band edge

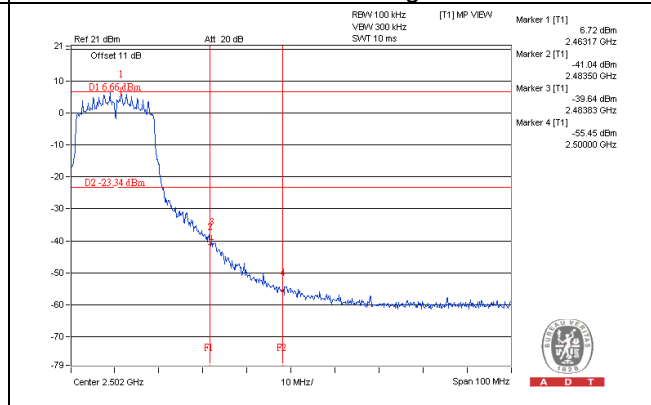

802.11n (HT20)_Chain 1

CH 1

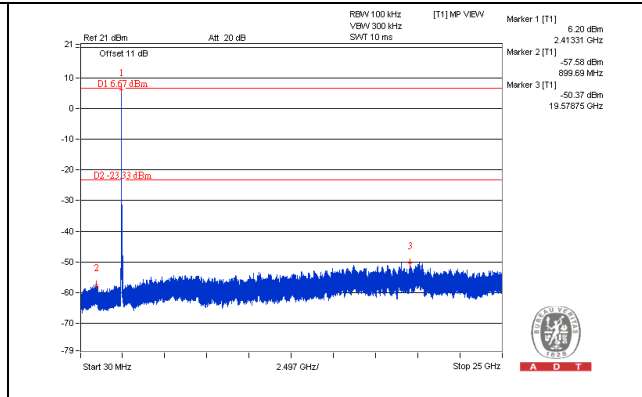
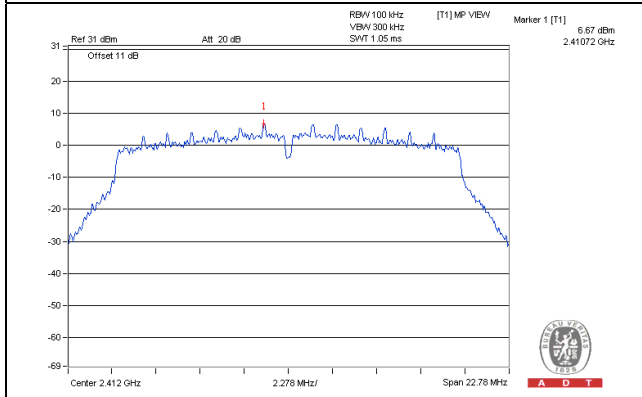

CH 6

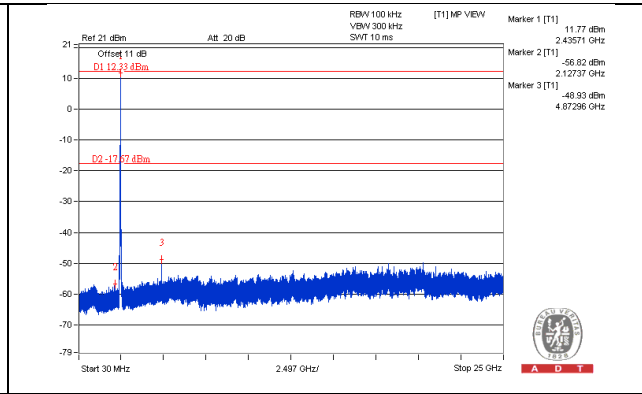
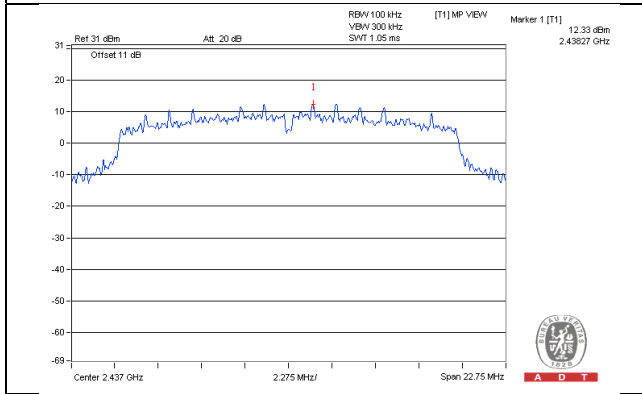

CH 11

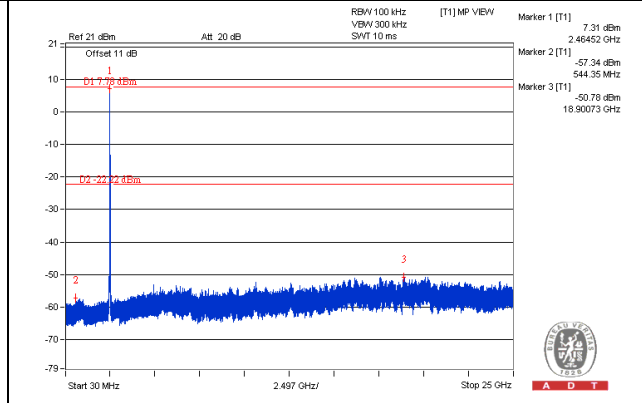
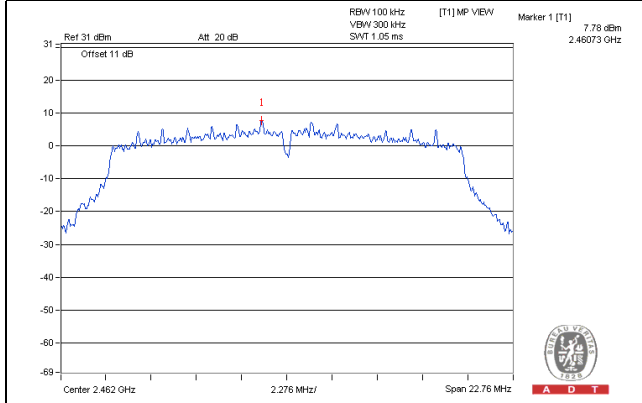

CH 1 Band edge

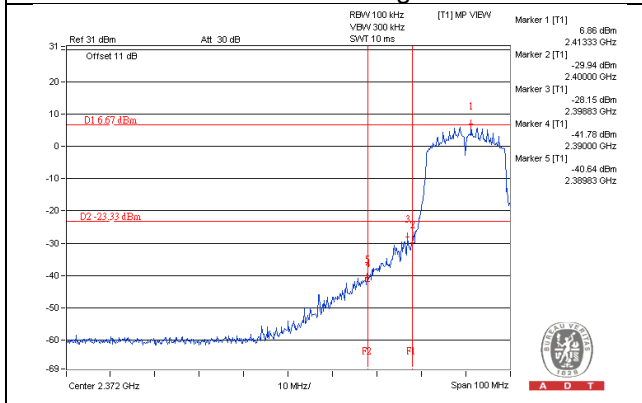

CH 11 Band edge

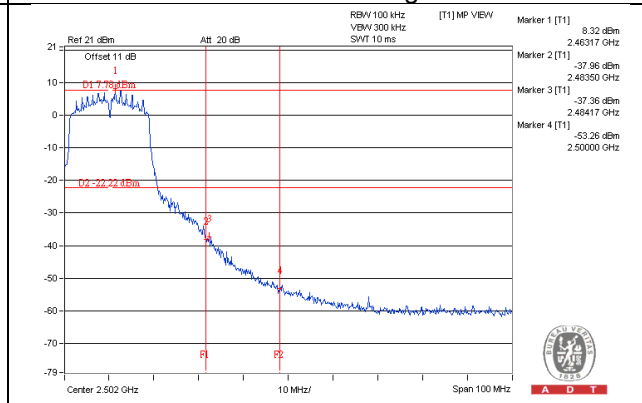

802.11n (HT20)_Chain 2

CH 1

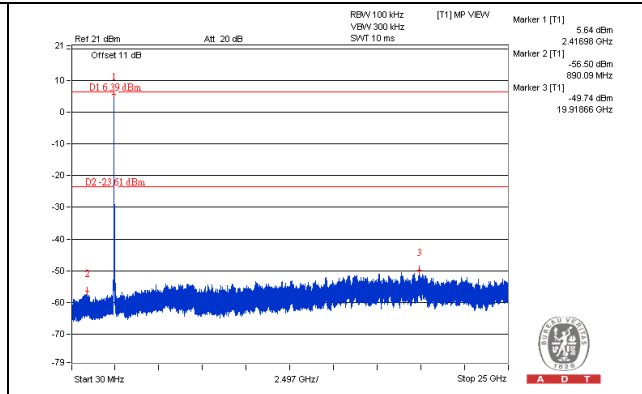
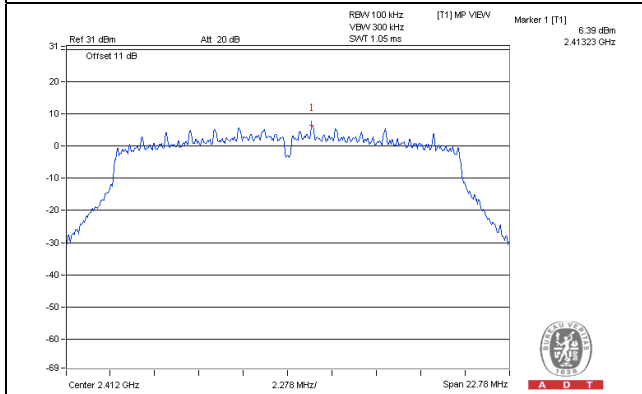

CH 6

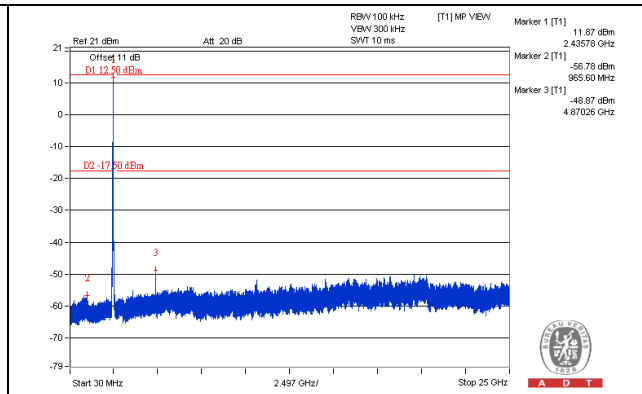
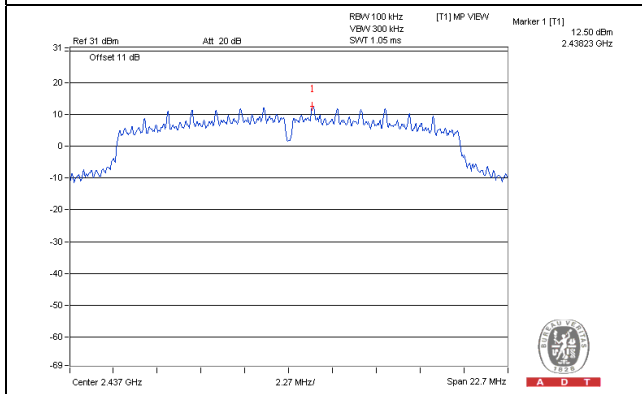

CH 11

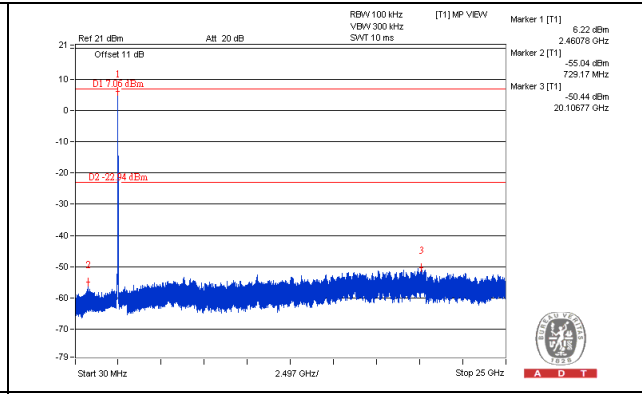
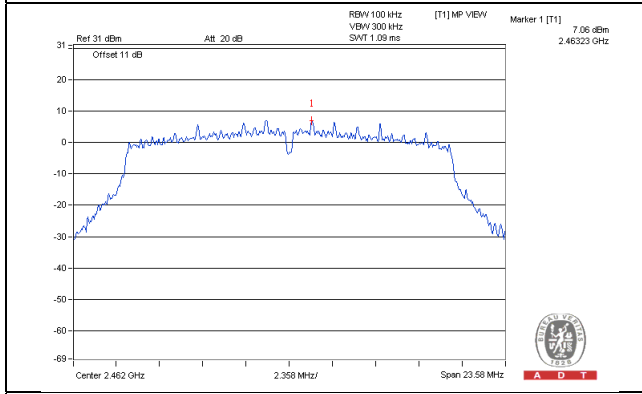

CH 1 Band edge

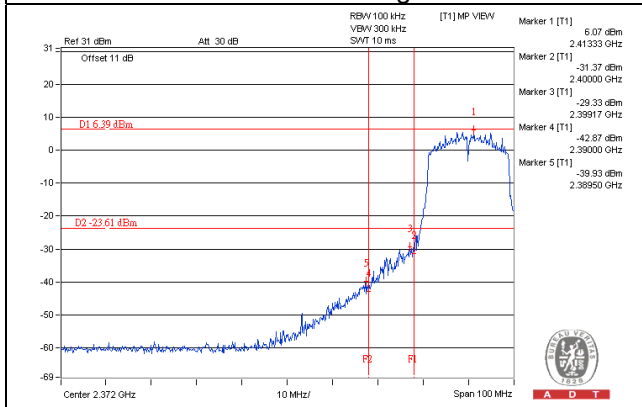

CH 11 Band edge

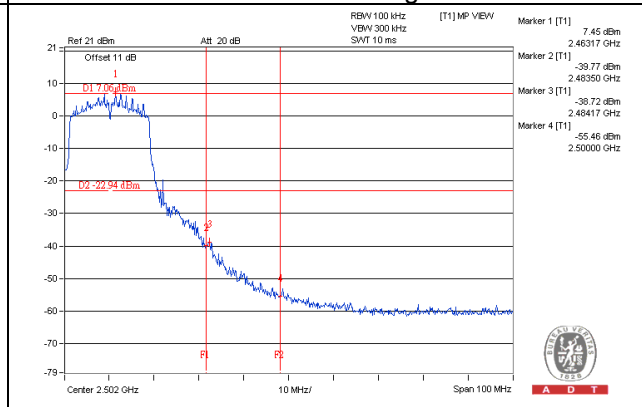

802.11n (HT40)_Chain 0

CH 3

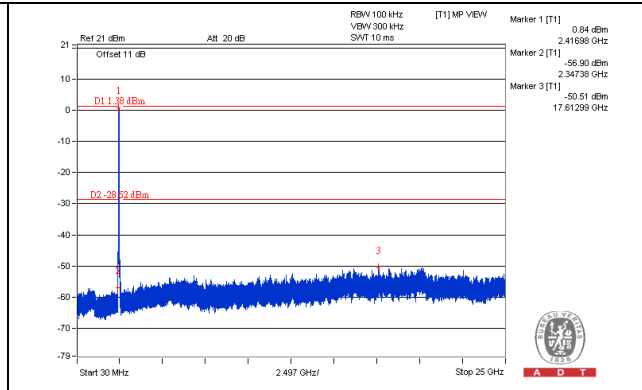
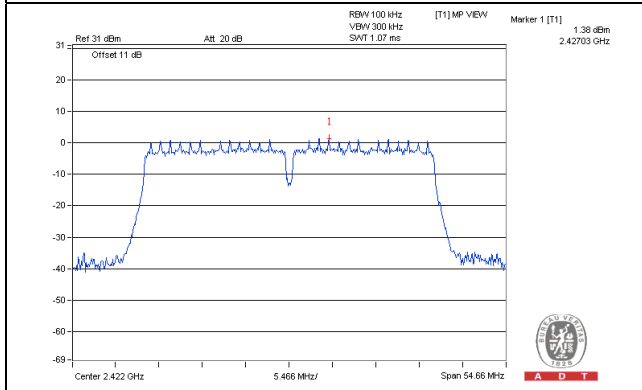

CH 6

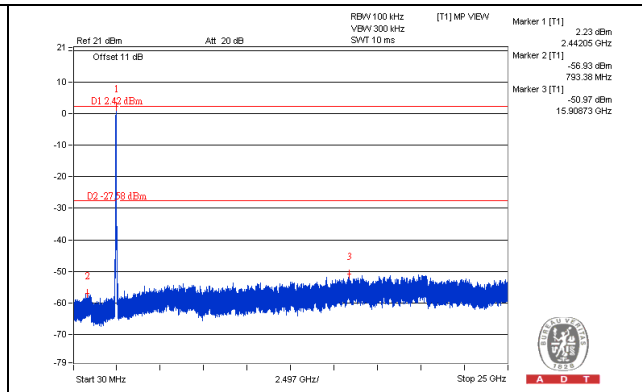
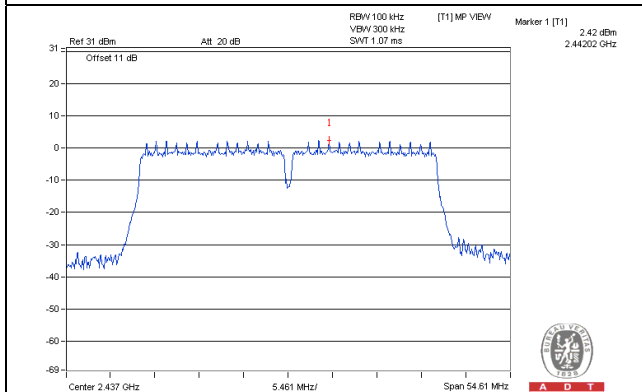

CH 9

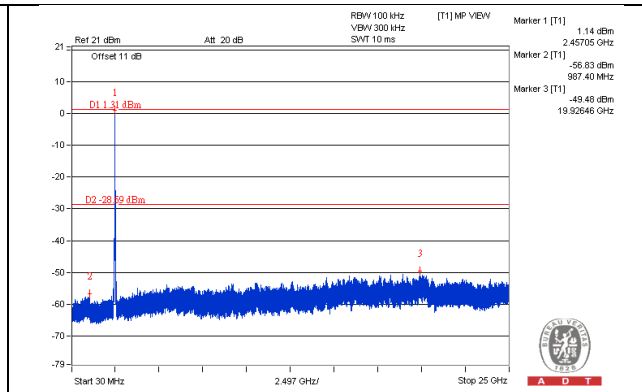
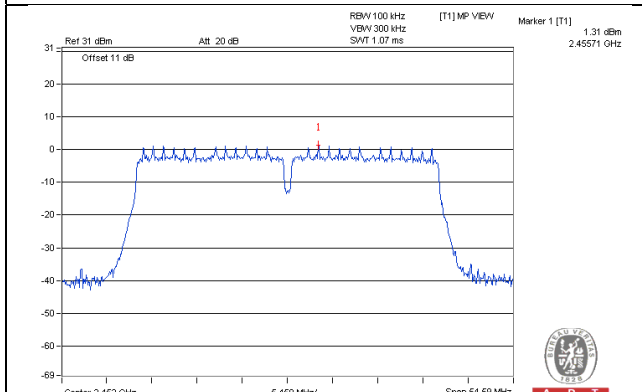

CH 3 Band edge

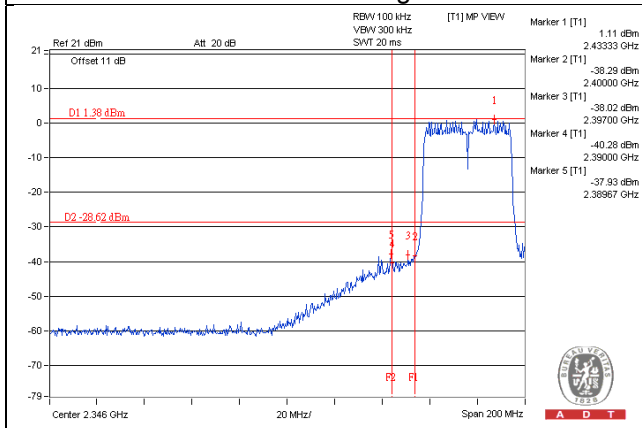

CH 9 Band edge

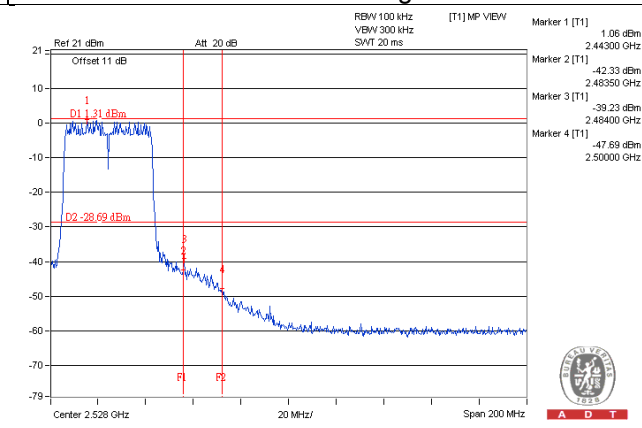

802.11n (HT40)_Chain 1

CH 3

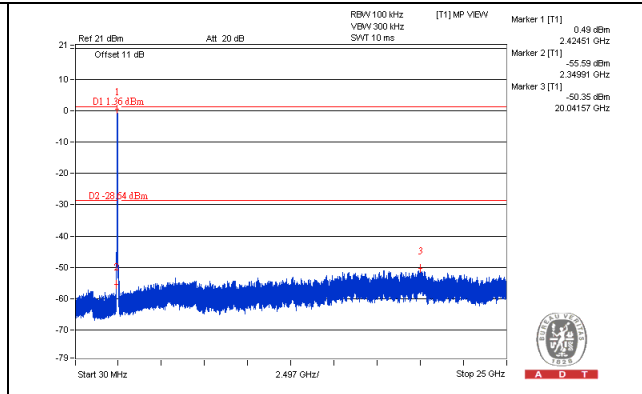
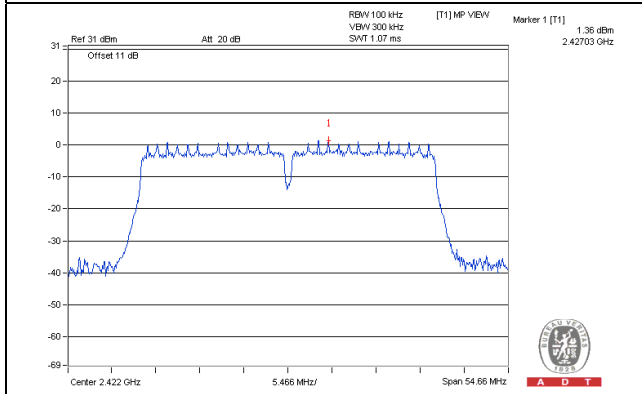

CH 6

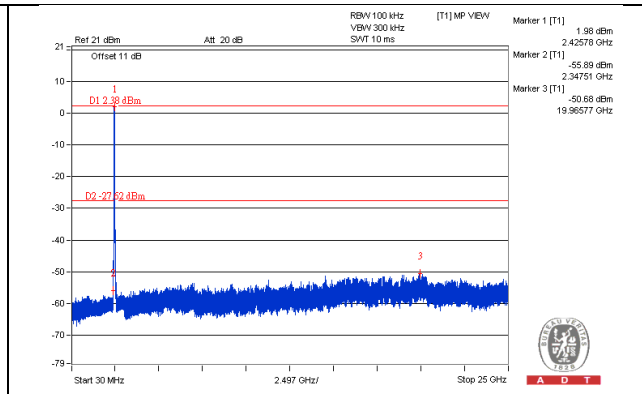
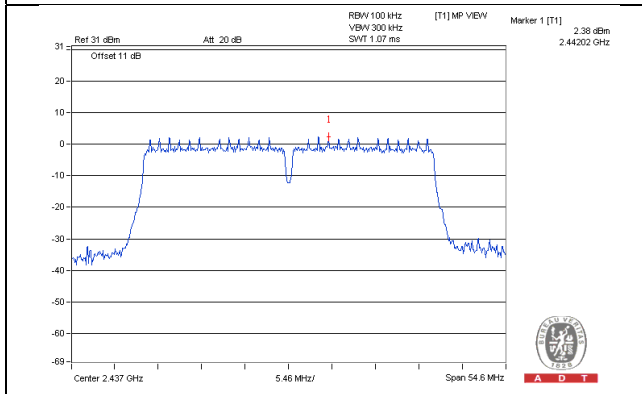

CH 9

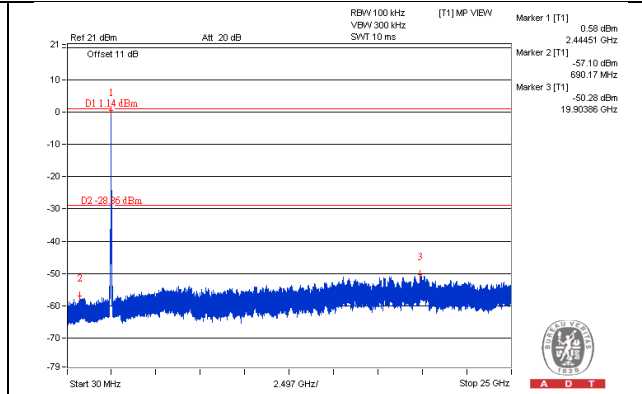
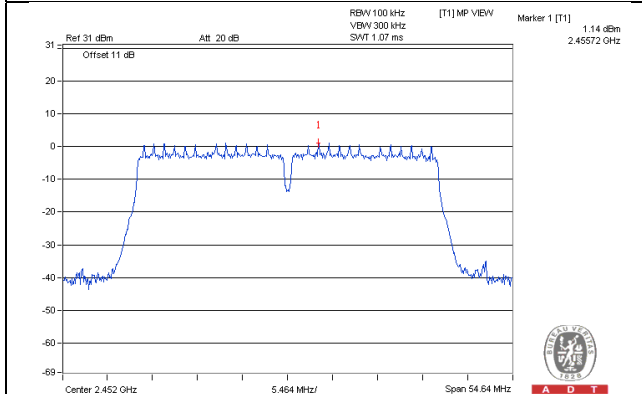

CH 3 Band edge

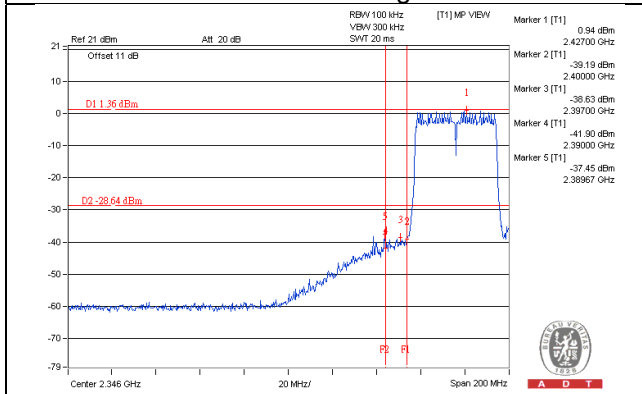

CH 9 Band edge

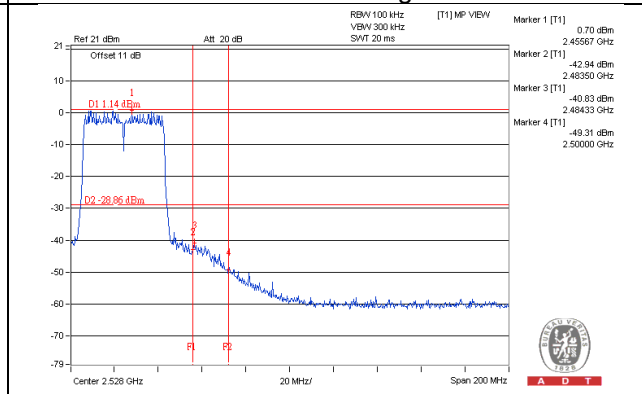

802.11n (HT40)_Chain 2

CH 3

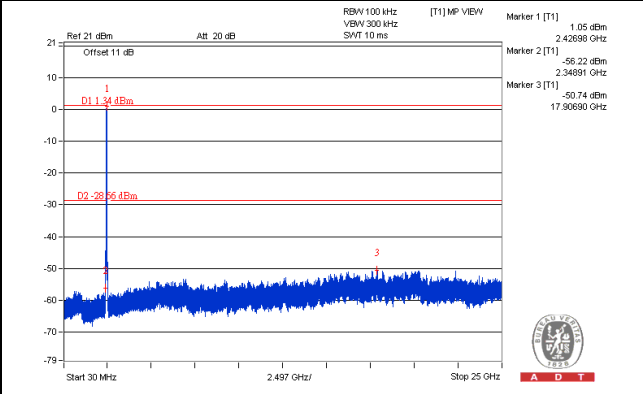
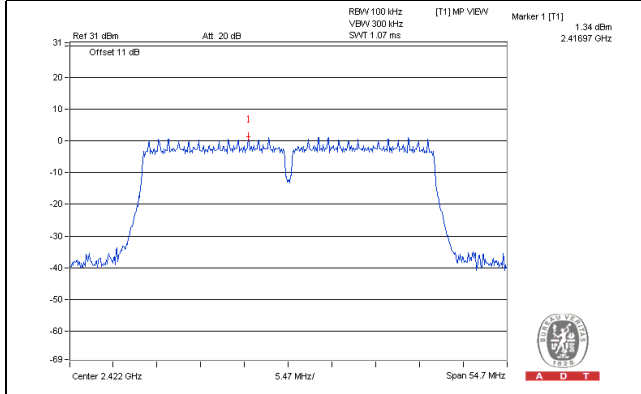

CH 6

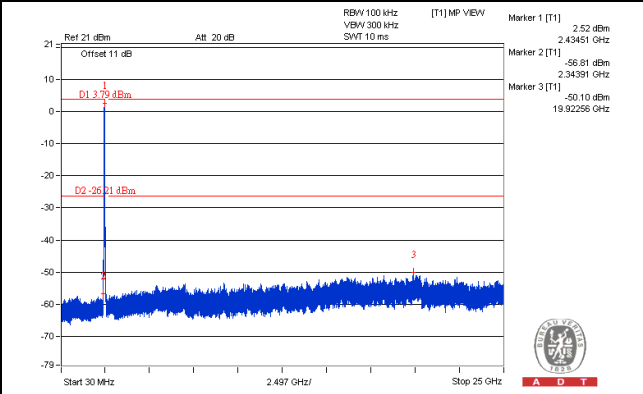
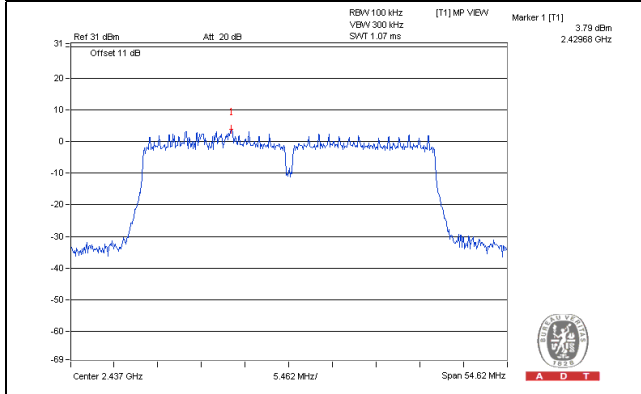

CH 9

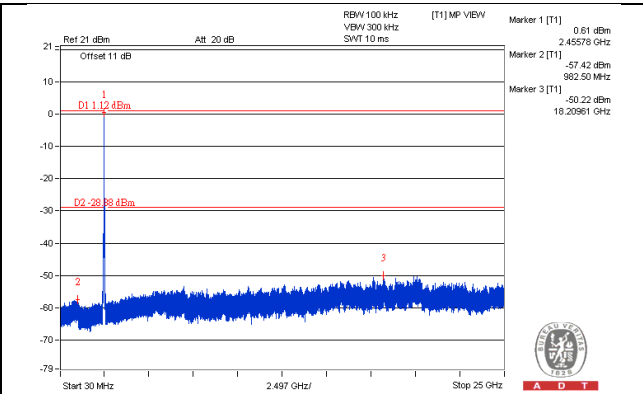
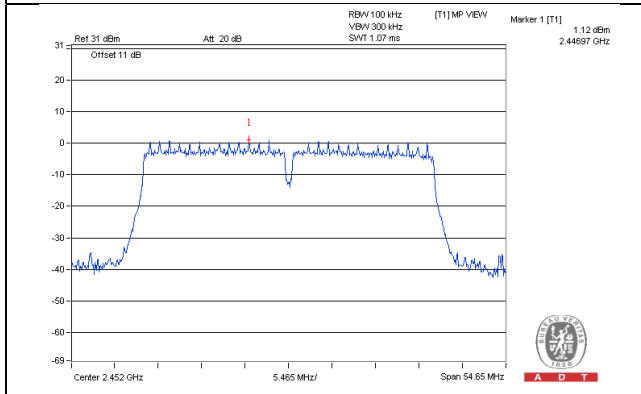

CH 3 Band edge

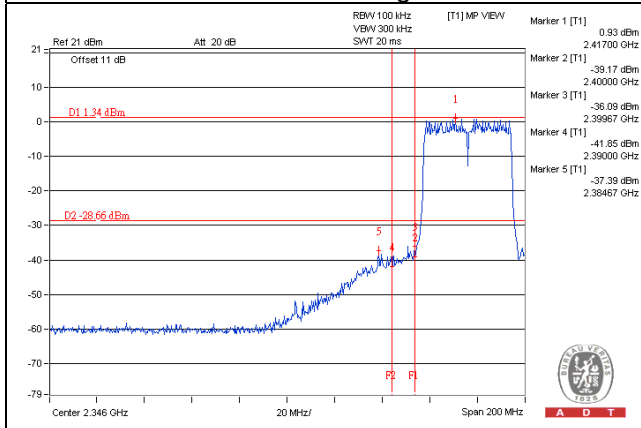

CH 9 Band edge

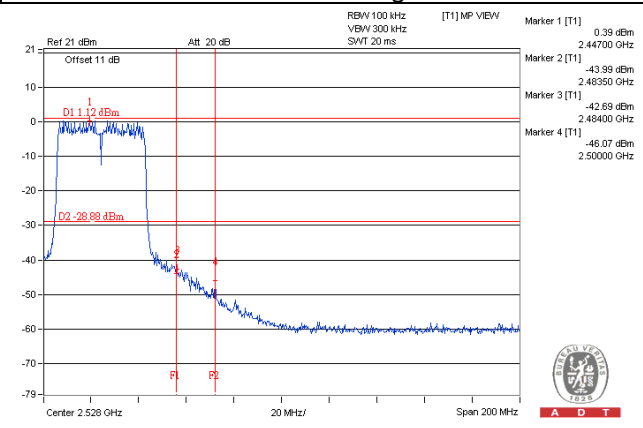

Test Mode A

4TX

802.11b_Chain 0

CH 1

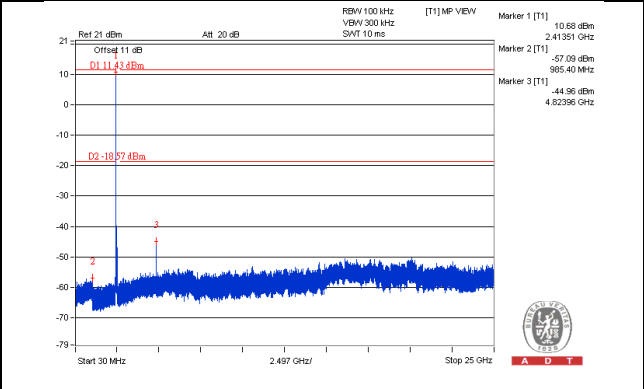
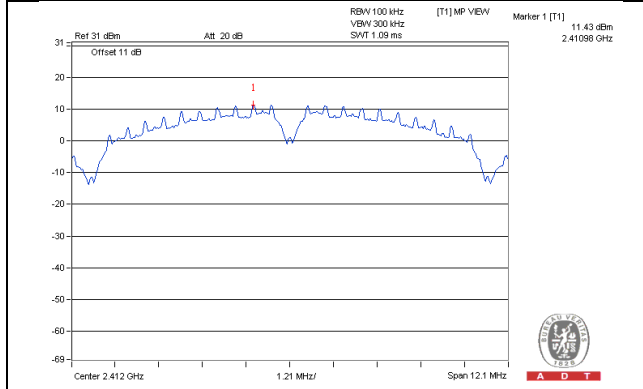

CH 6

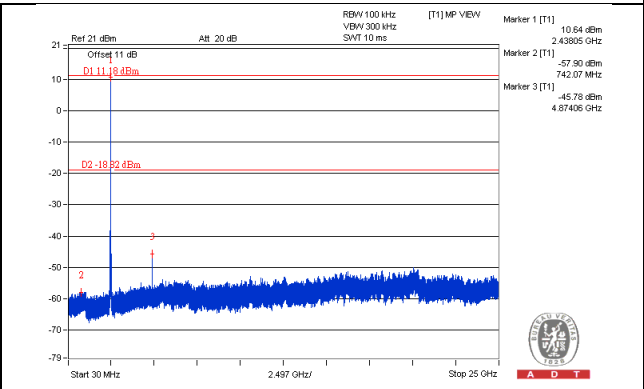
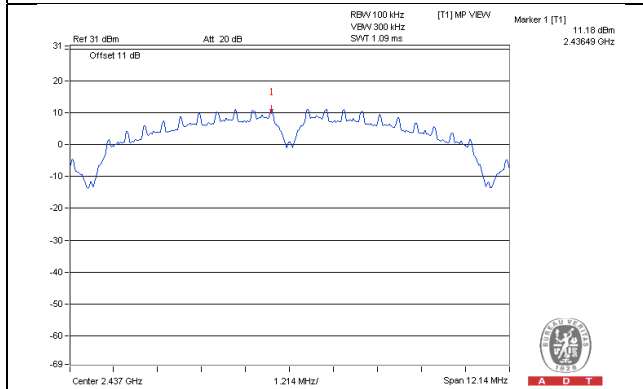

CH 11

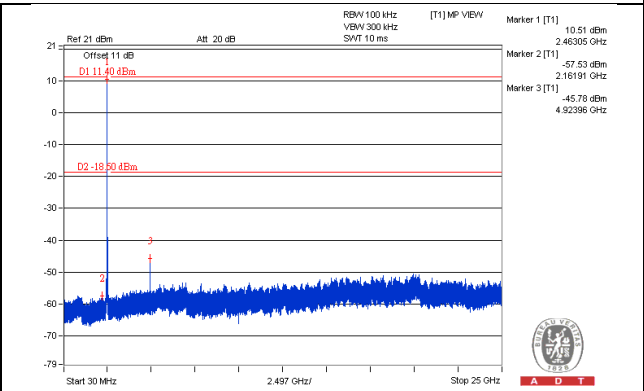
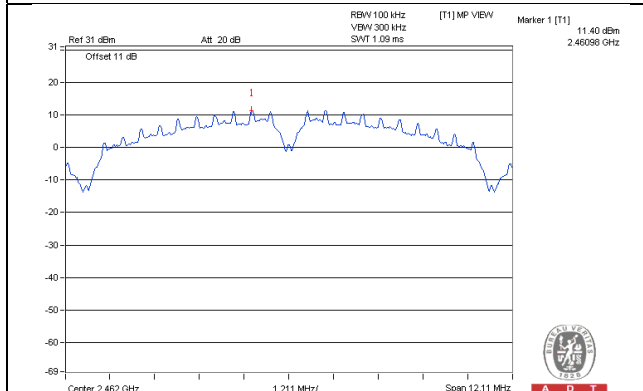

CH 1 Band edge

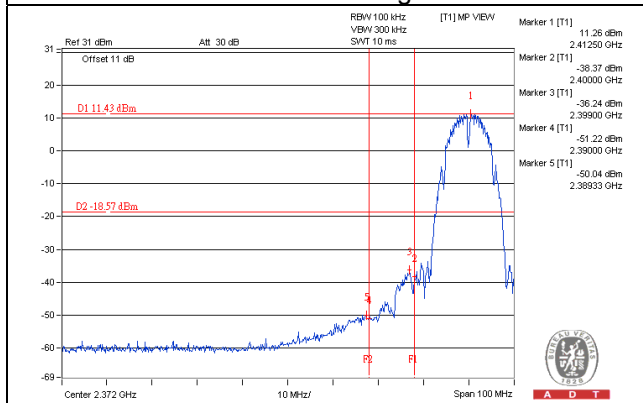

CH 11 Band edge

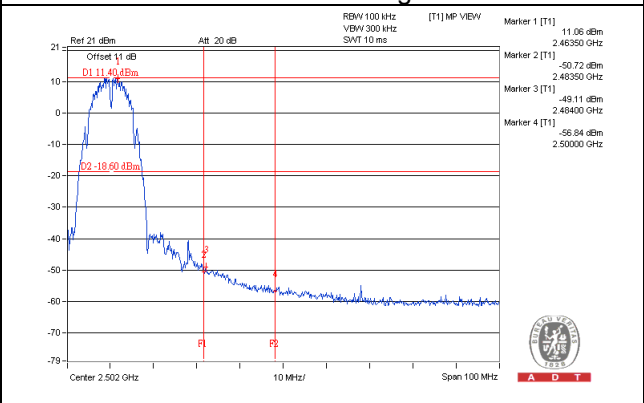

802.11b_Chain 1

CH 1

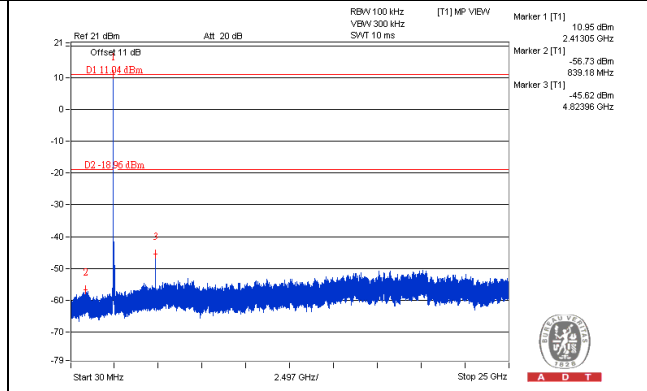
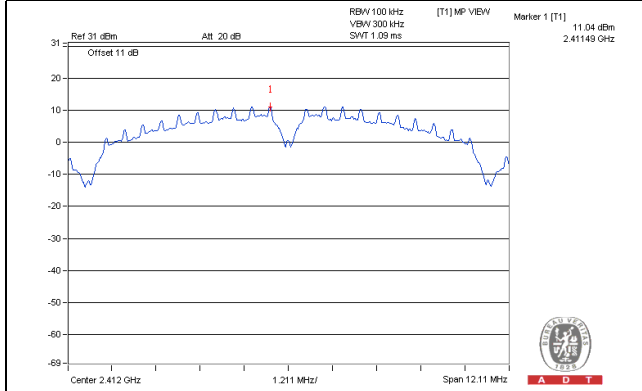

CH 6

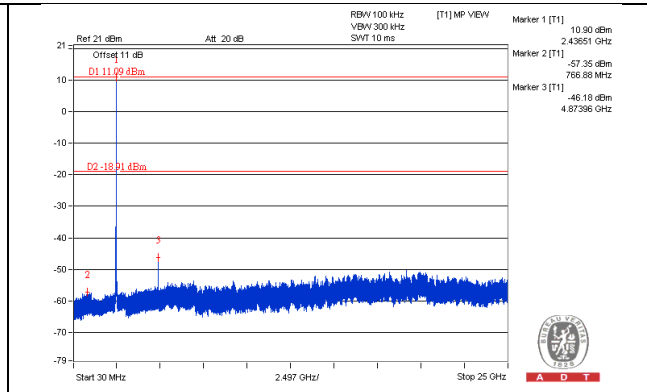
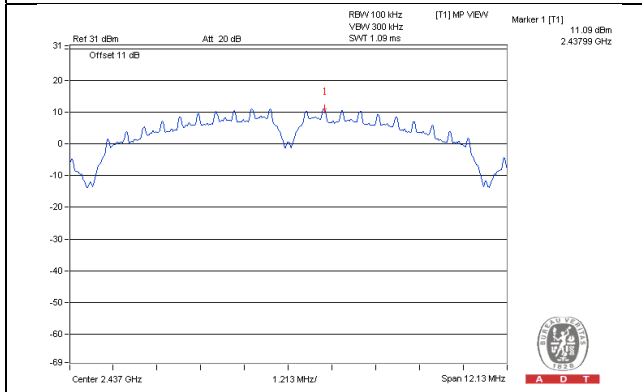

CH 11

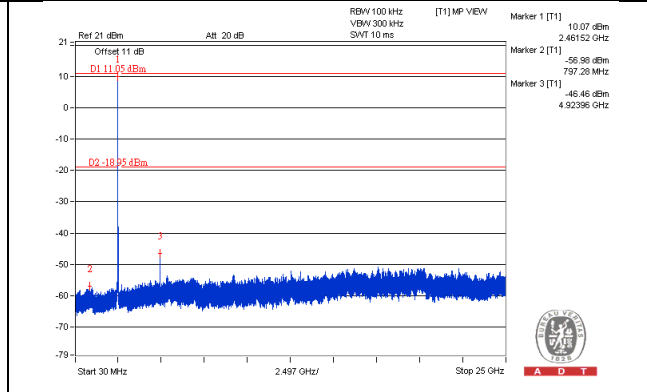
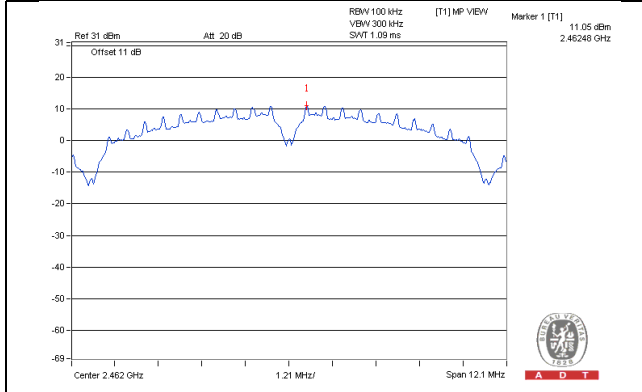

CH 1 Band edge

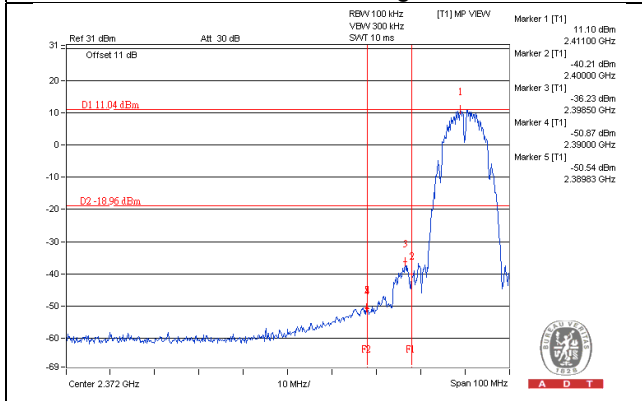

CH 11 Band edge

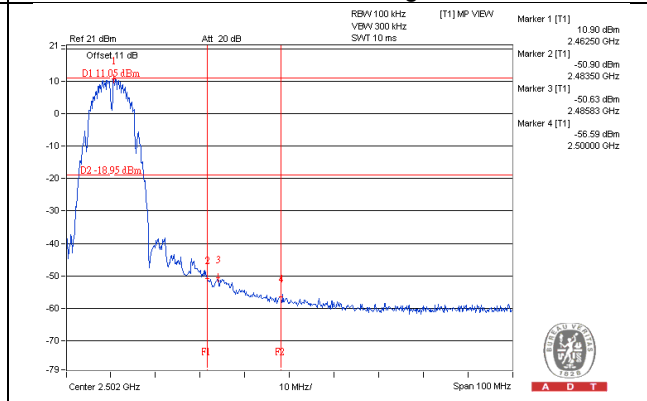

802.11b_Chain 2

CH 1

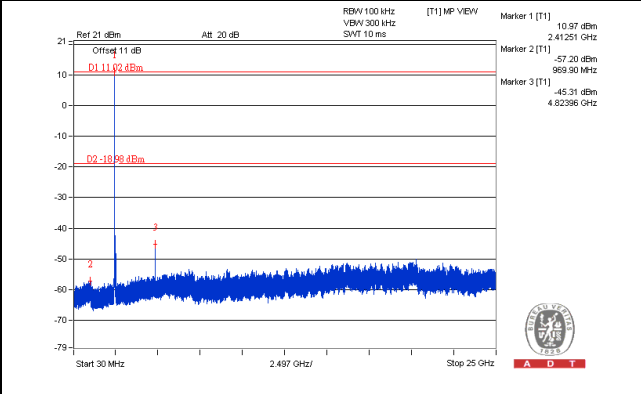
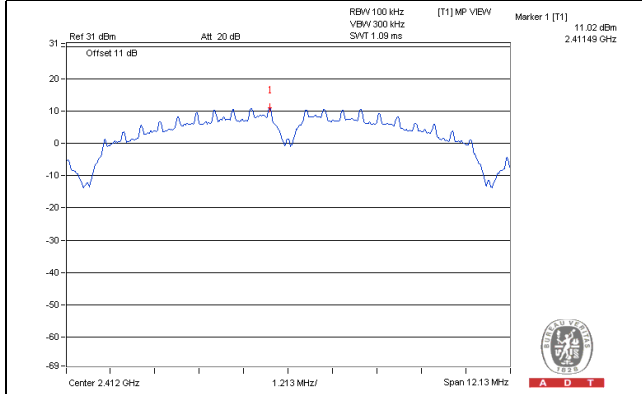

CH 6

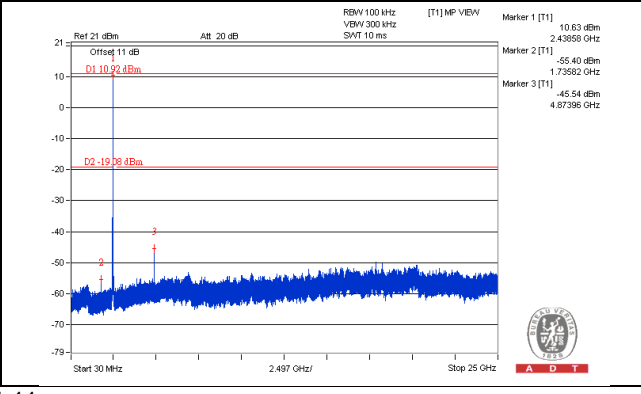
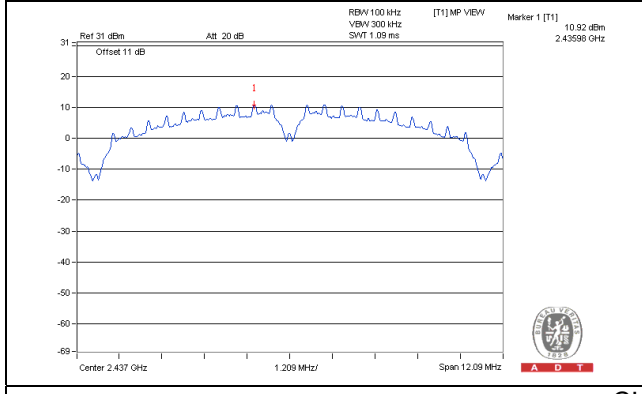

CH 11

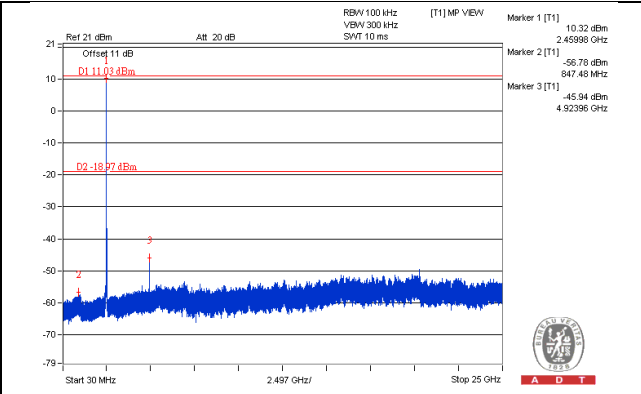
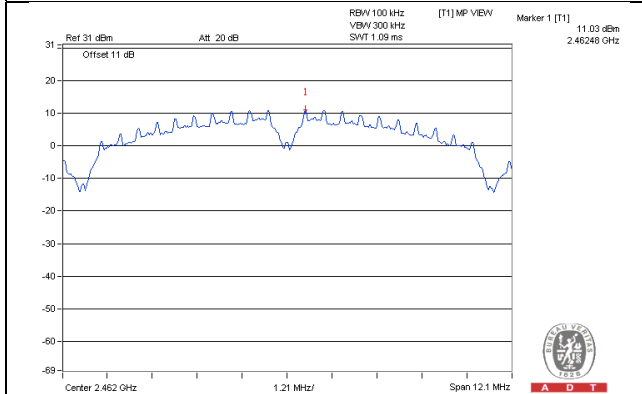

CH 1 Band edge

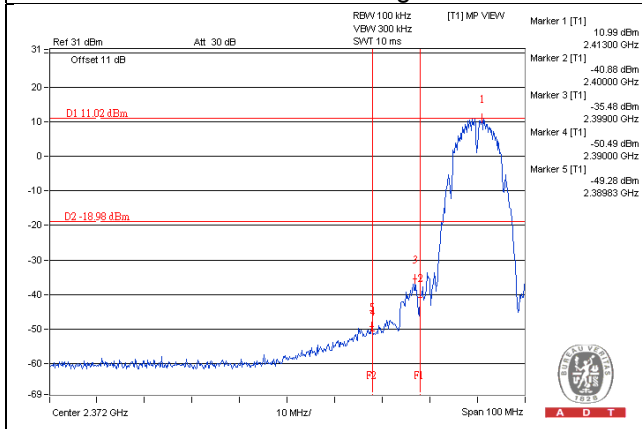

CH 11 Band edge

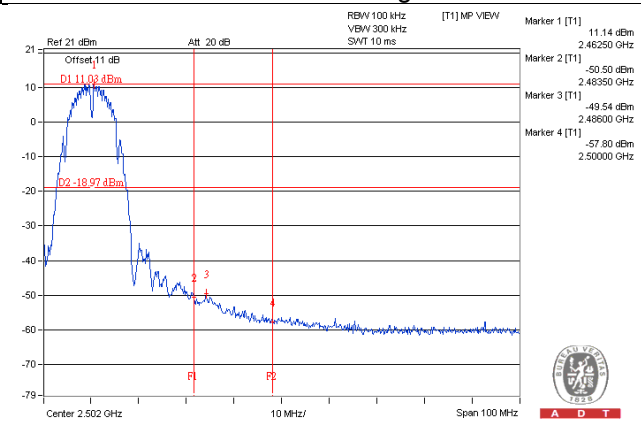

802.11b_Chain 3

CH 1

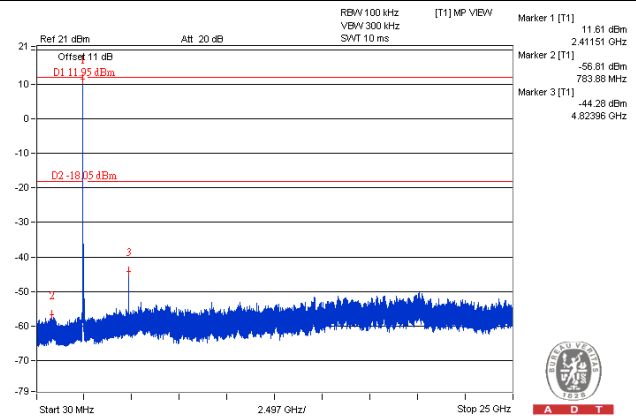
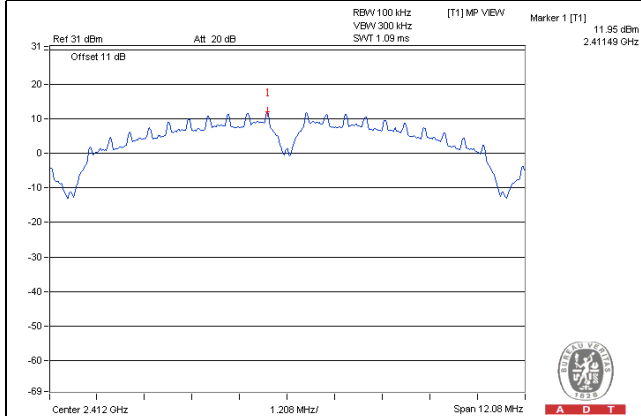

CH 6

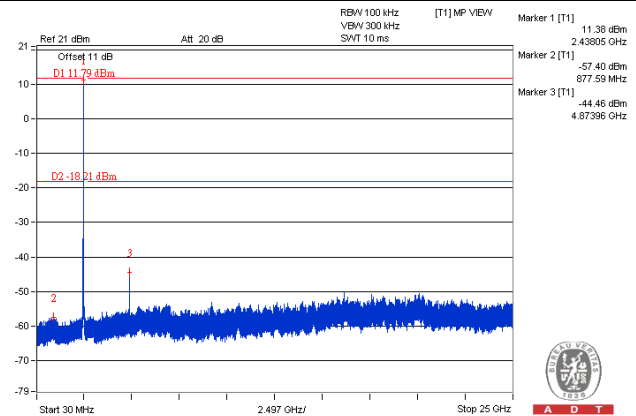
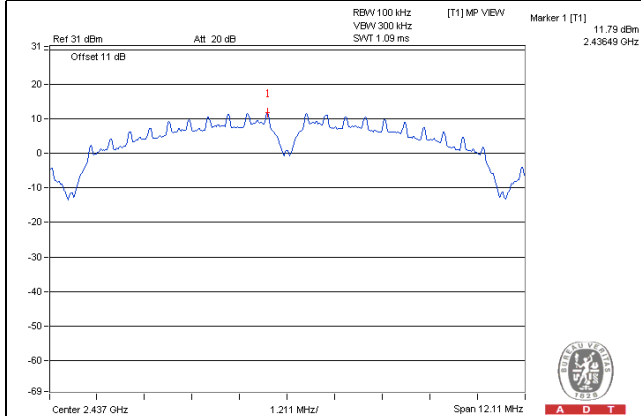

CH 11

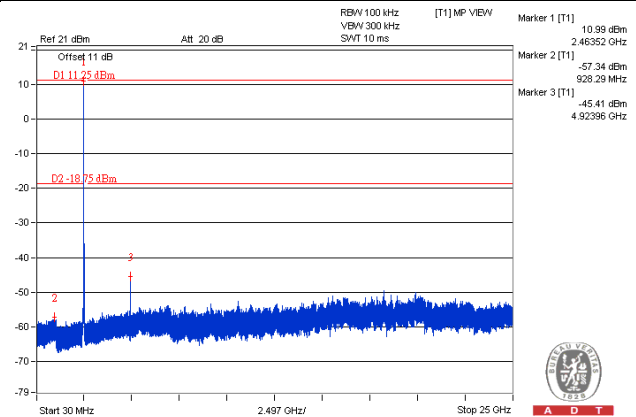
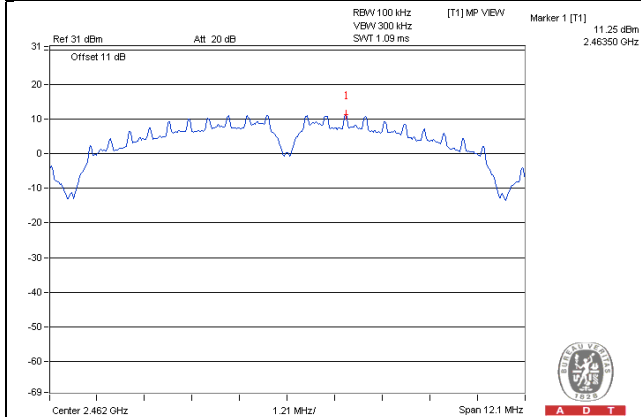

CH 1 Band edge

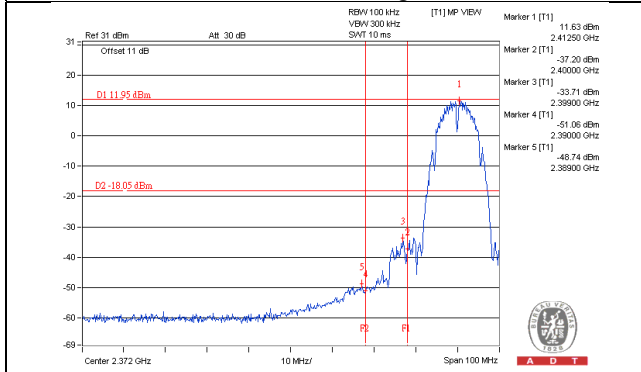

CH 11 Band edge

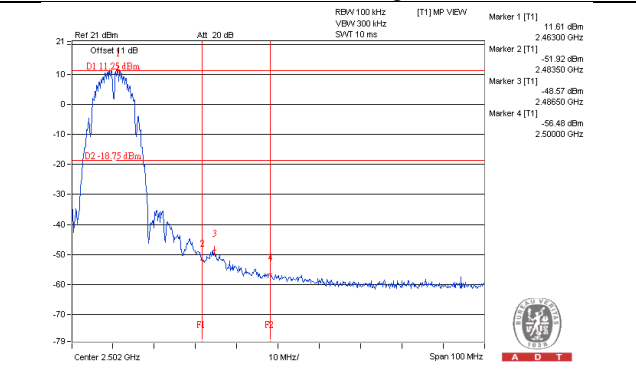

802.11g_Chain 0

CH 1

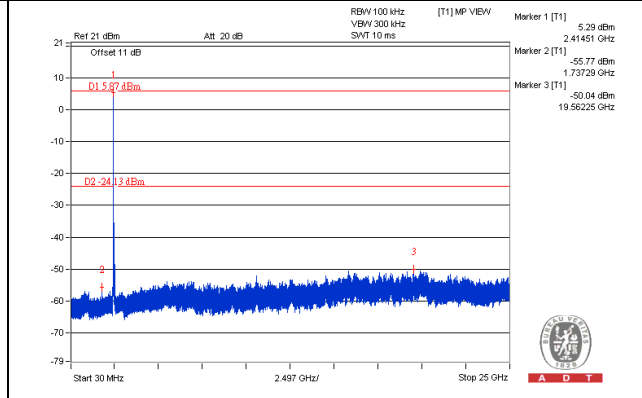
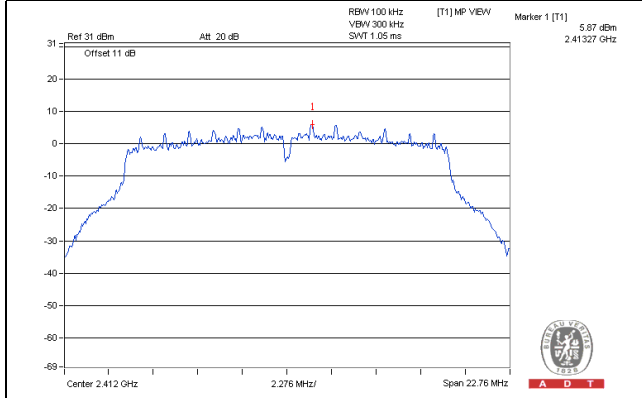

CH 6

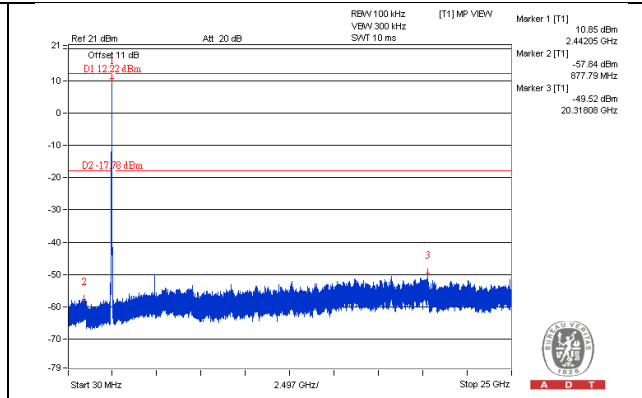
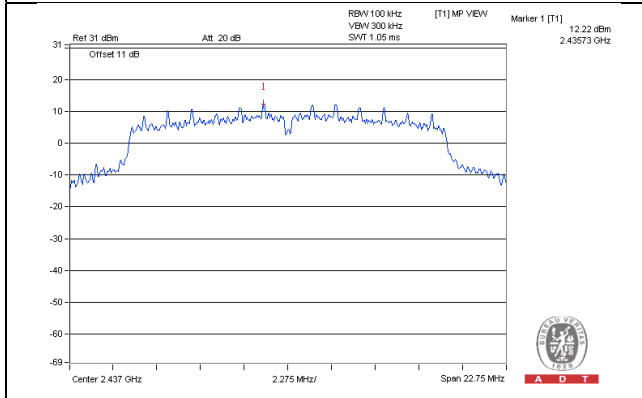

CH 11

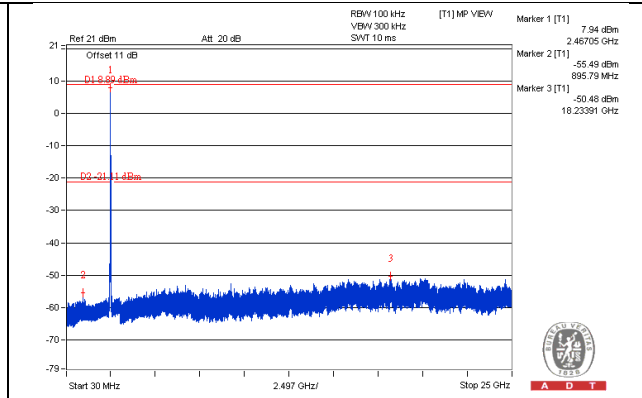
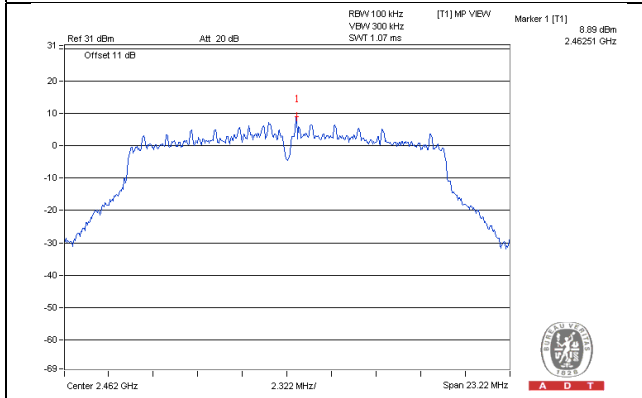

CH 1 Band edge

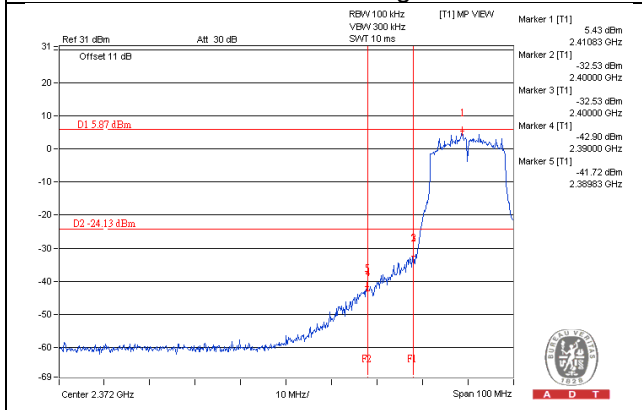

CH 11 Band edge

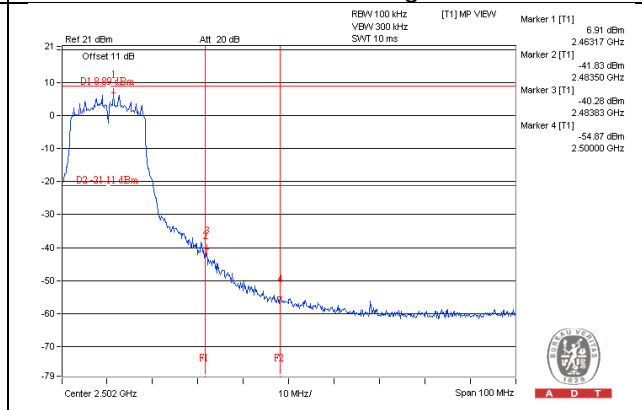

802.11g_Chain 1

CH 1

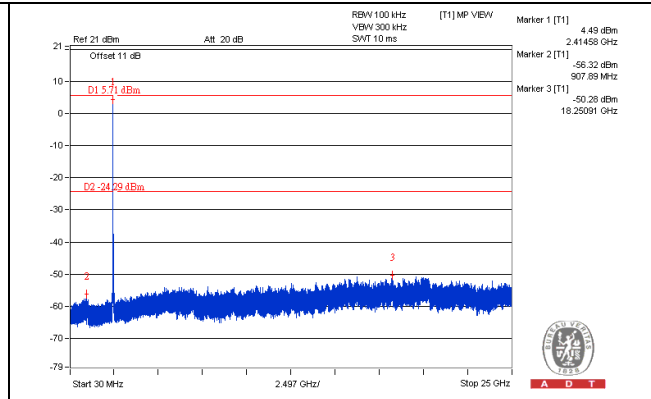
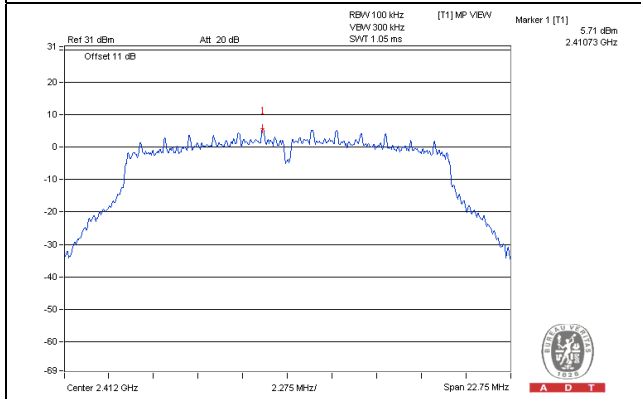

CH 6

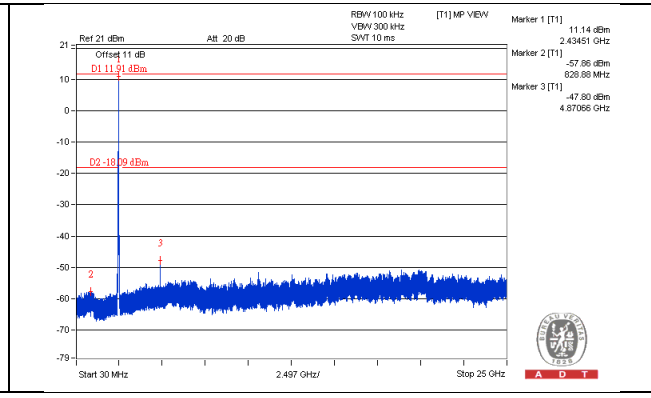
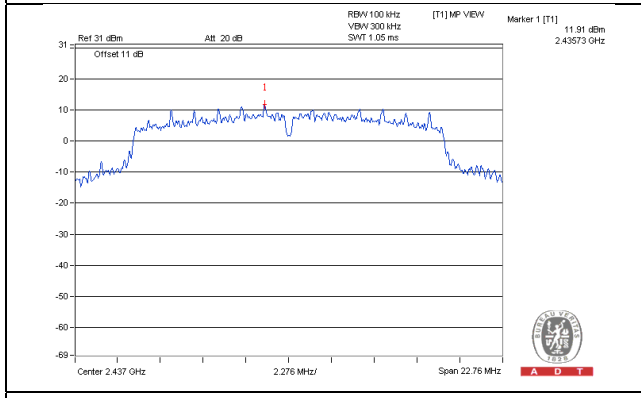

CH 11

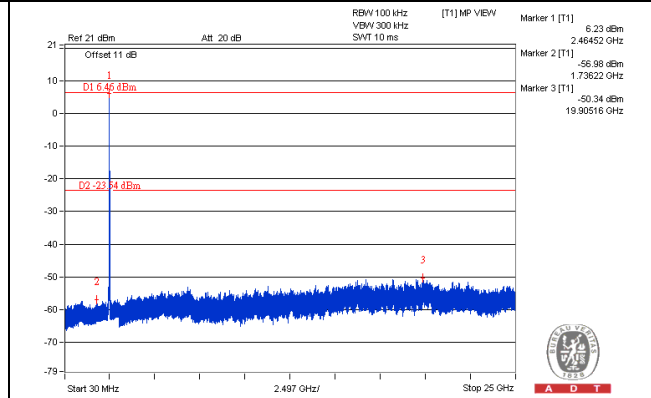
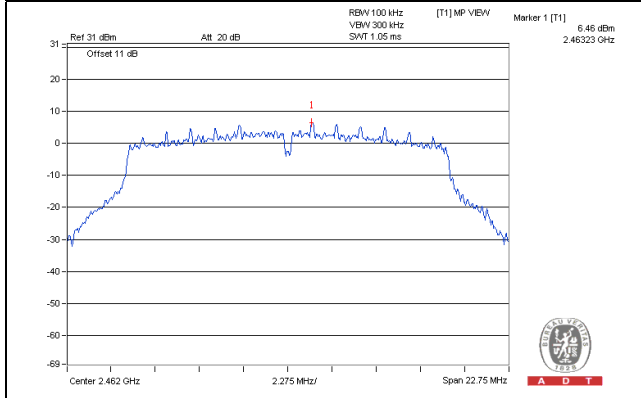

CH 1 Band edge

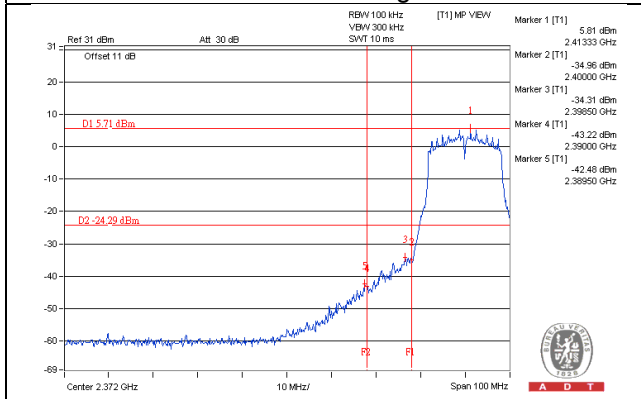

CH 11 Band edge

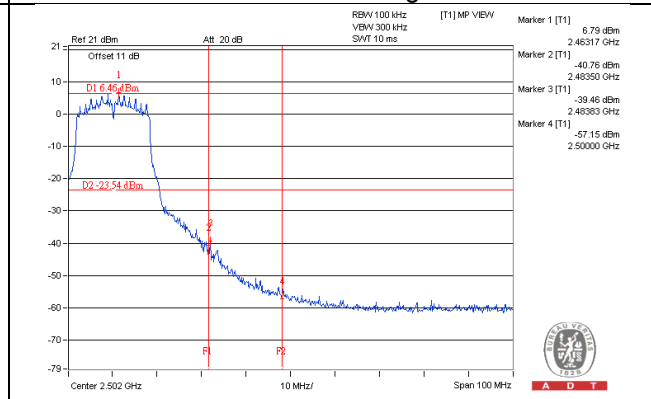

802.11g_Chain 2

CH 1

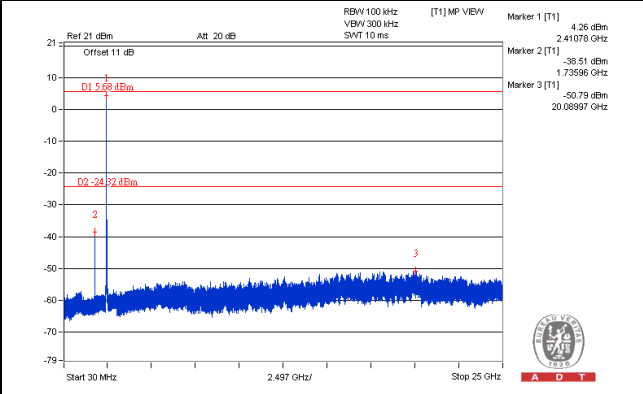
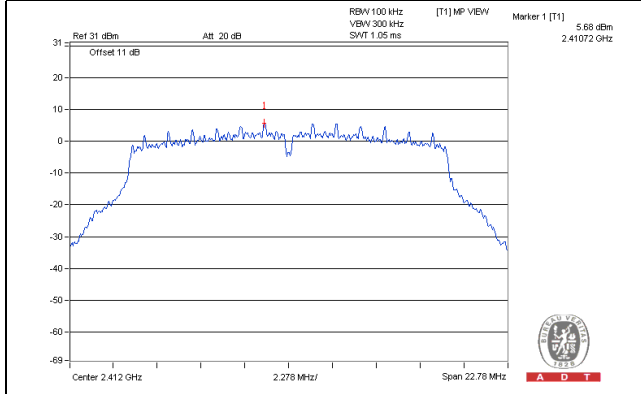

CH 6

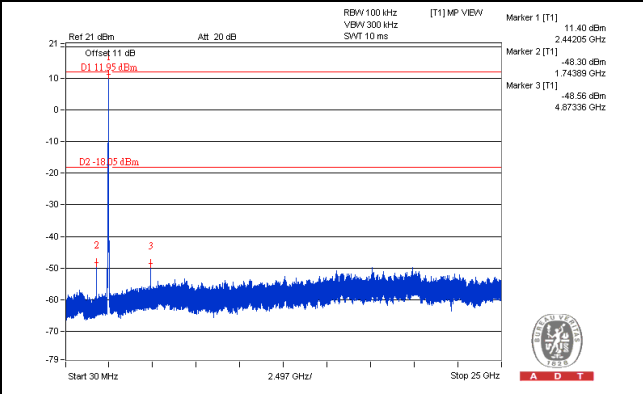
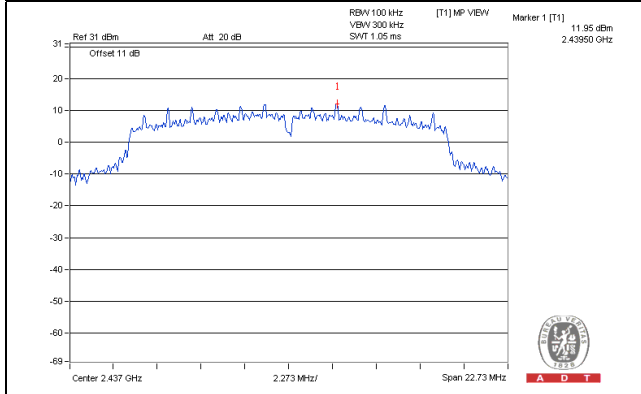

CH 11

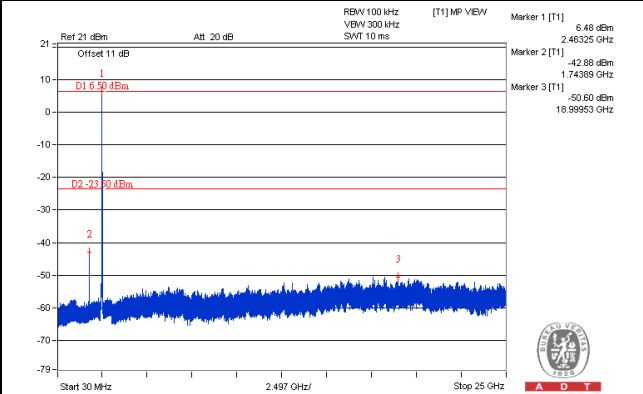
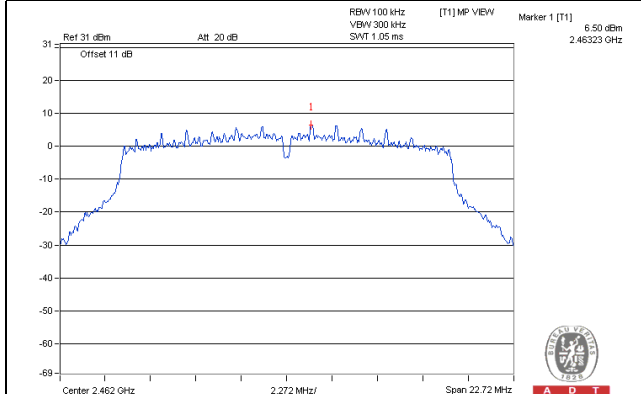

CH 1 Band edge

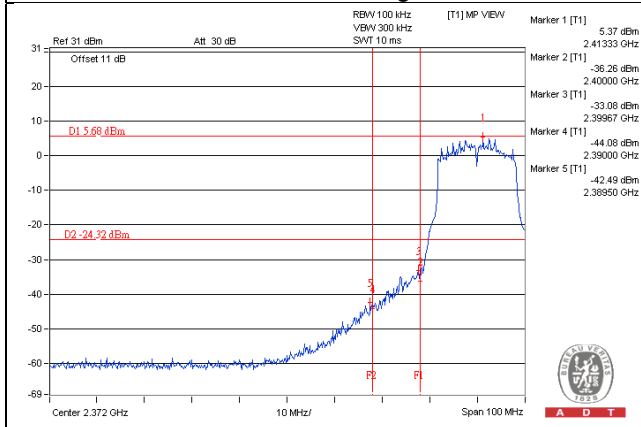

CH 11 Band edge

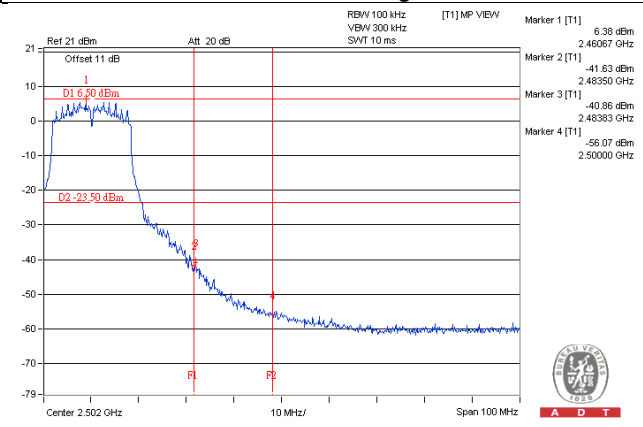

802.11g_Chain 3

CH 1

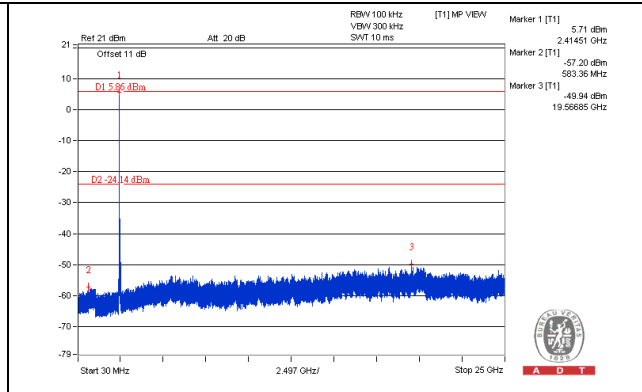
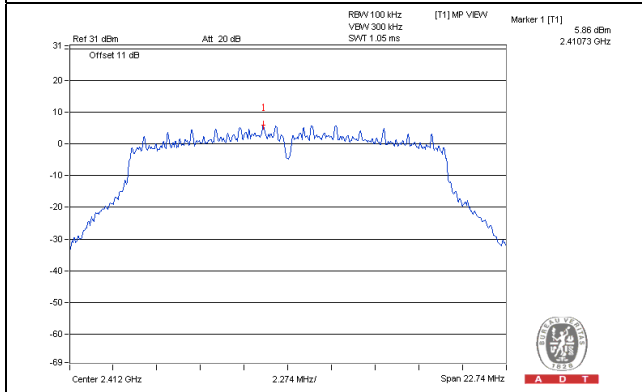

CH 6

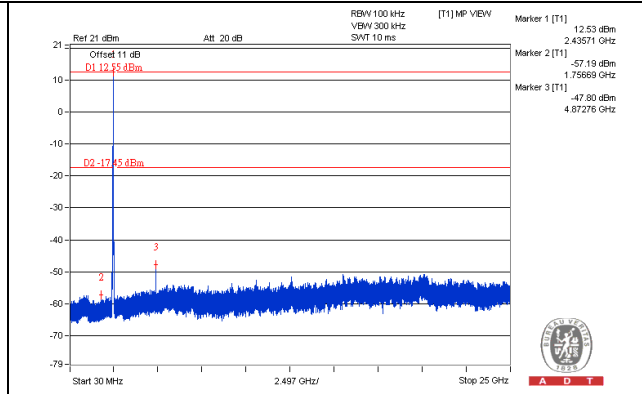
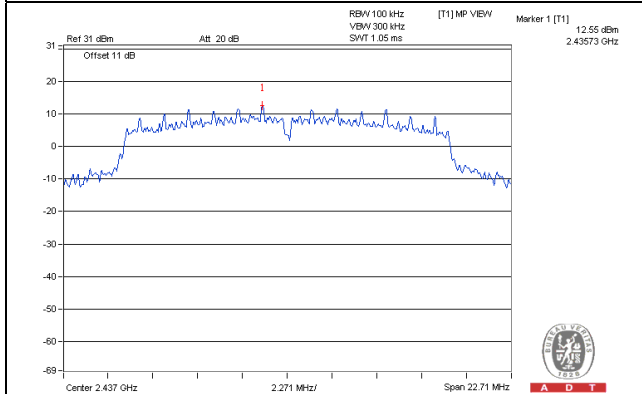

CH 11

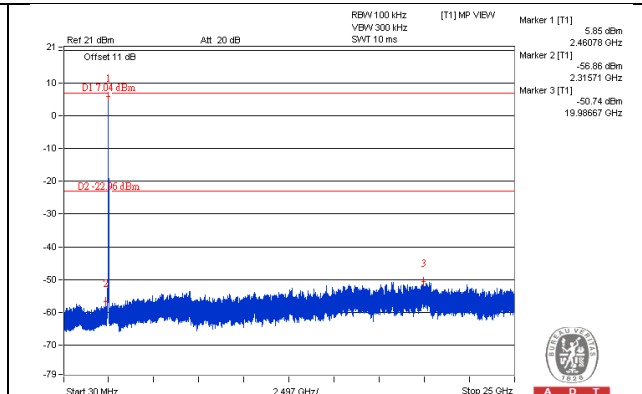
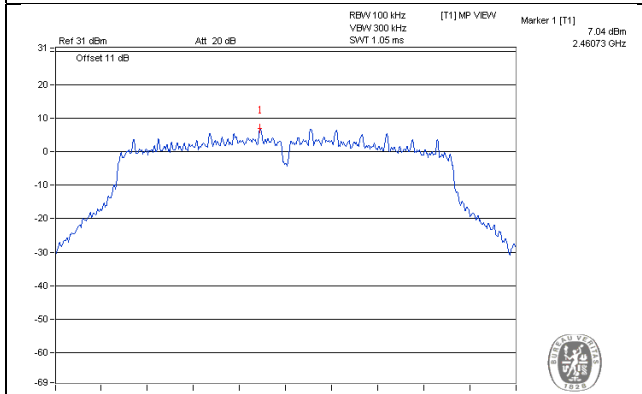

CH 1 Band edge

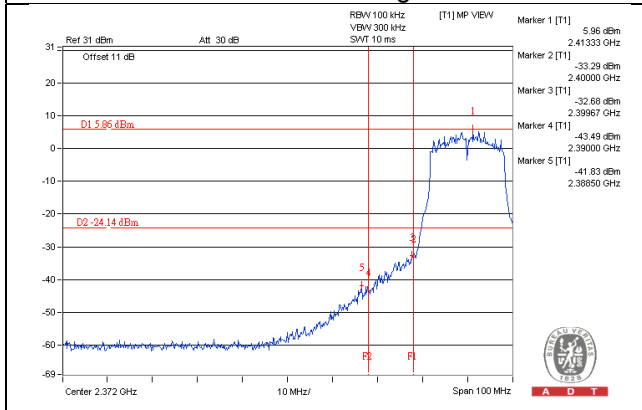

CH 11 Band edge

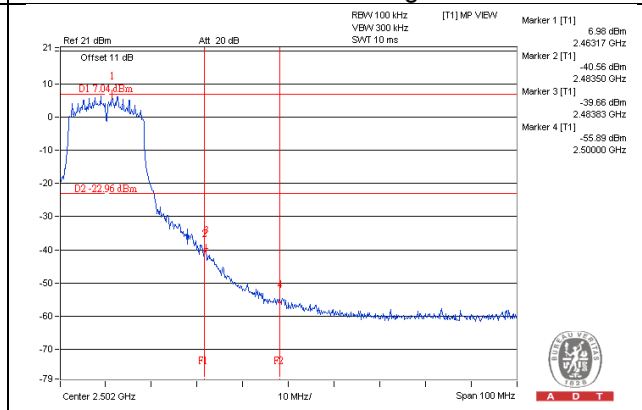

802.11n (HT20)_Chain 0

CH 1

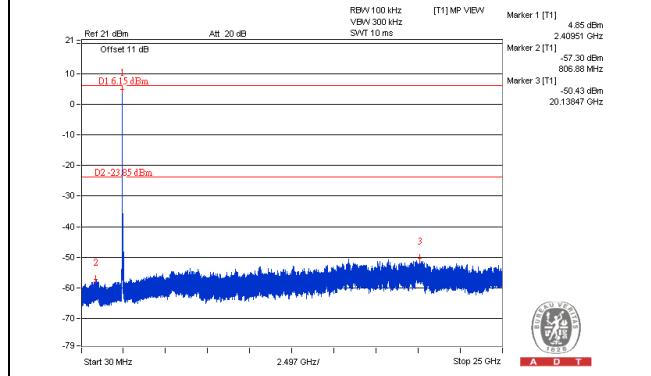
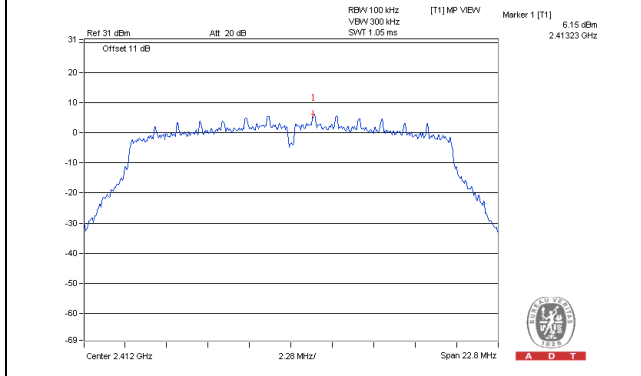

CH 6

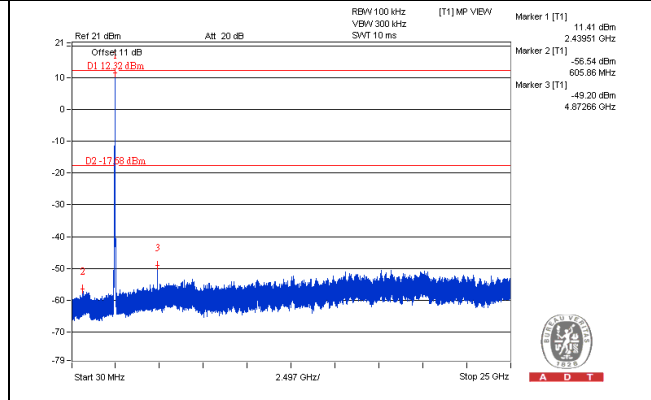
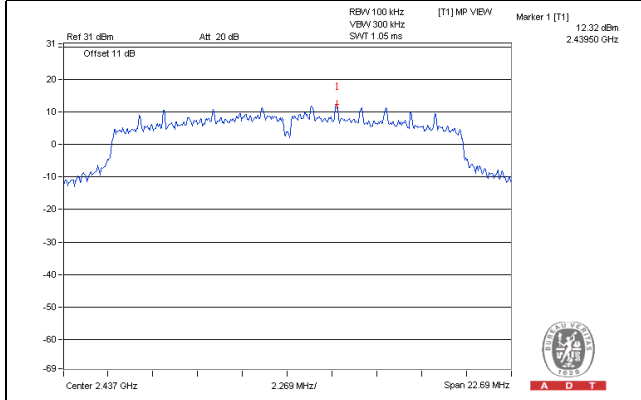

CH 11

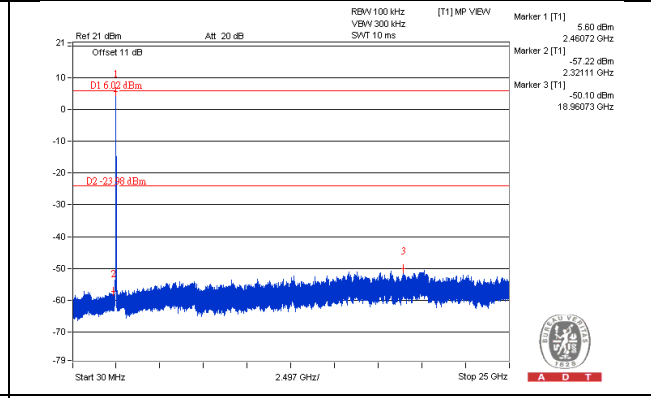
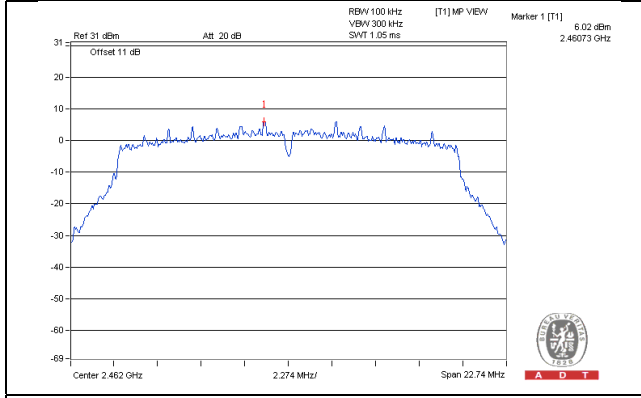

CH 1 Band edge

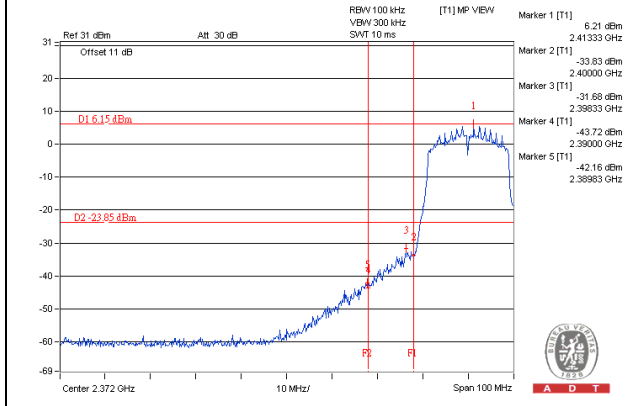

CH 11 Band edge

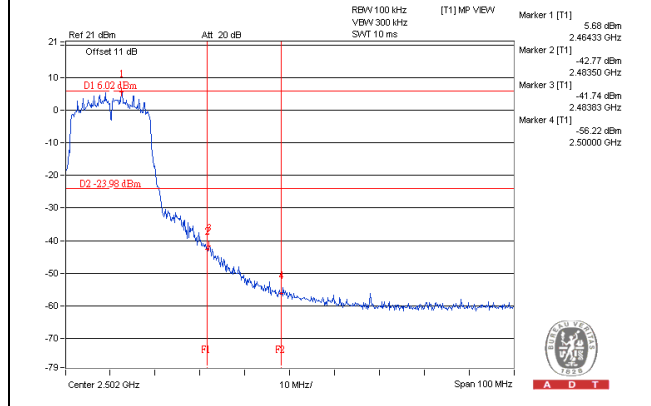

802.11n (HT20)_Chain 1

CH 1

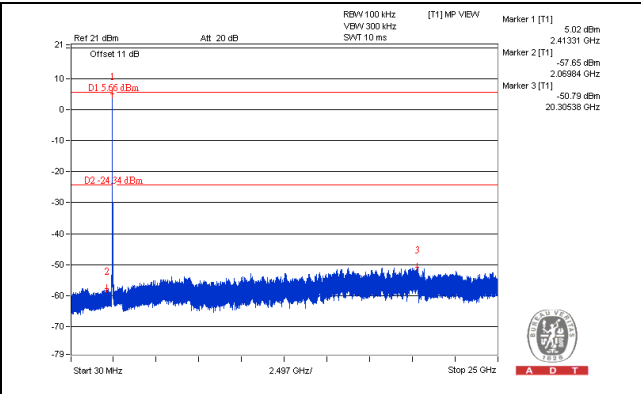
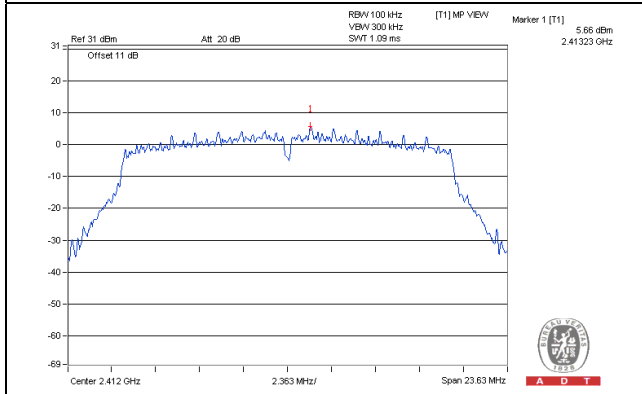

CH 6

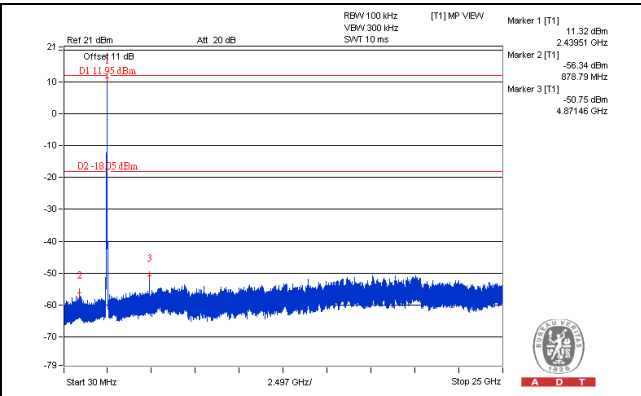
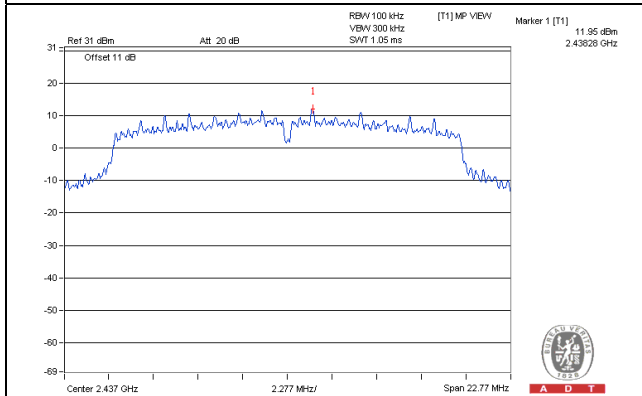

CH 11

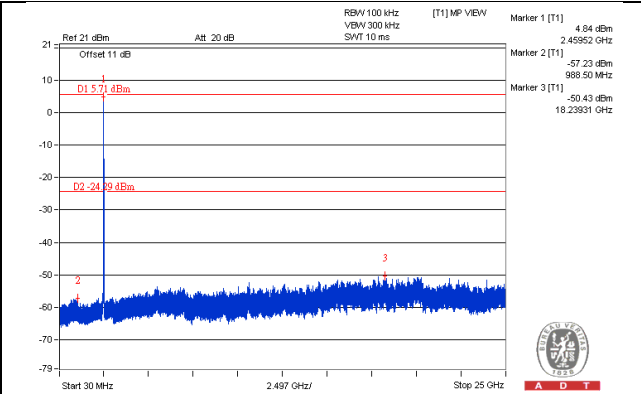
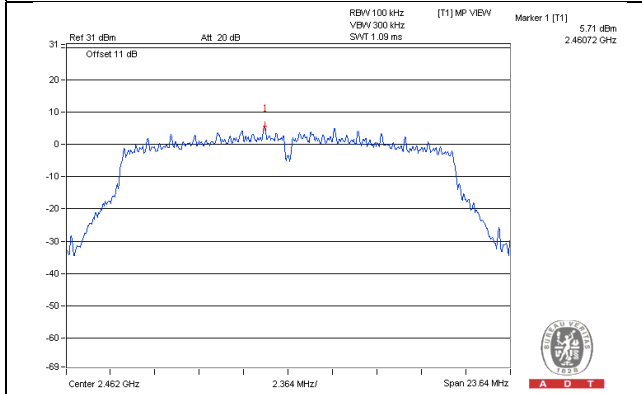

CH 1 Band edge

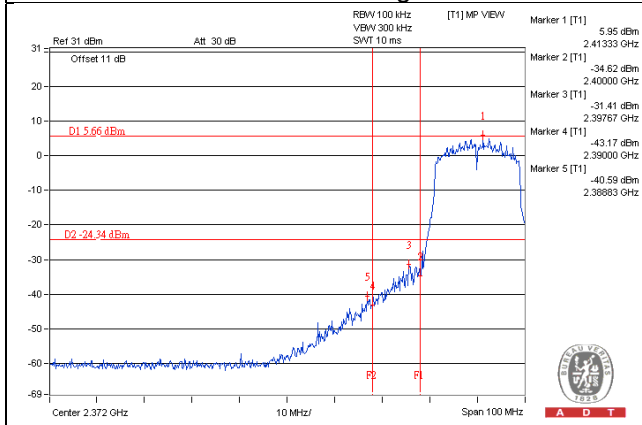

CH 11 Band edge

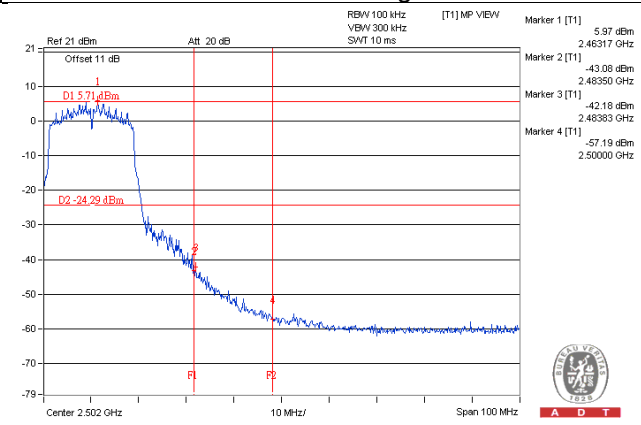

802.11n (HT20)_Chain 2

CH 1

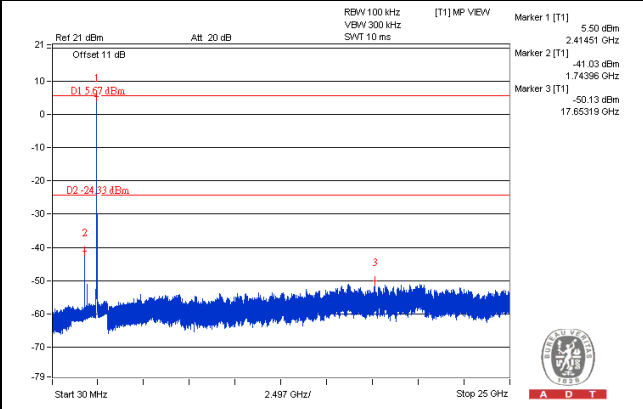
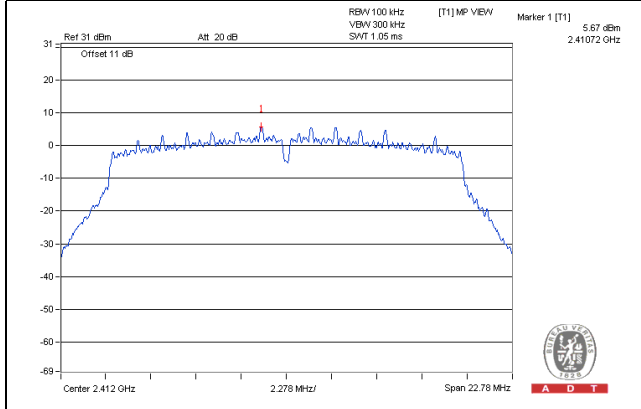

CH 6

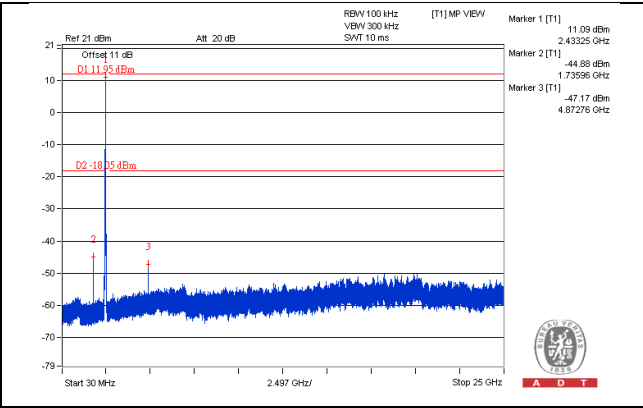
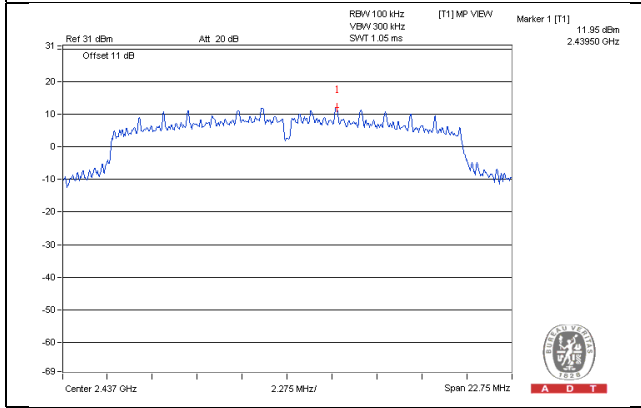

CH 11

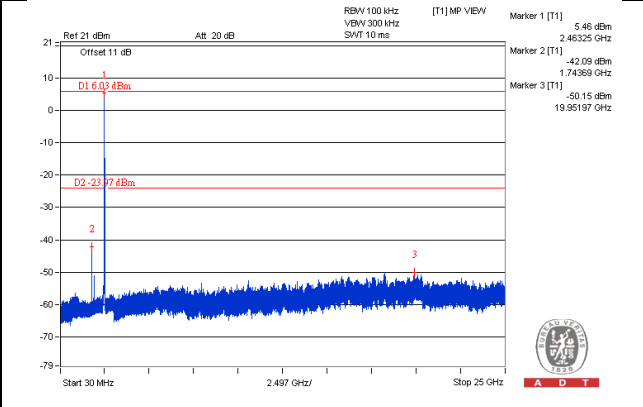
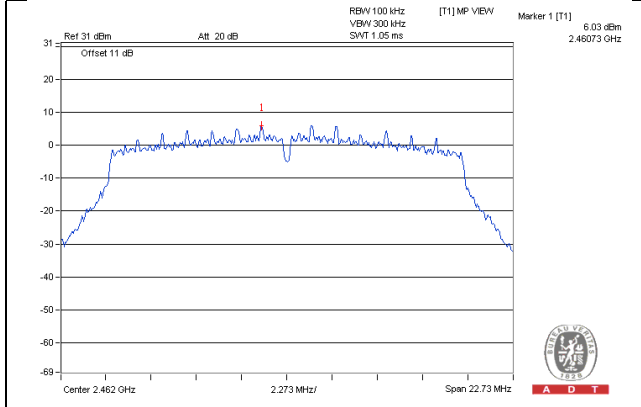

CH 1 Band edge

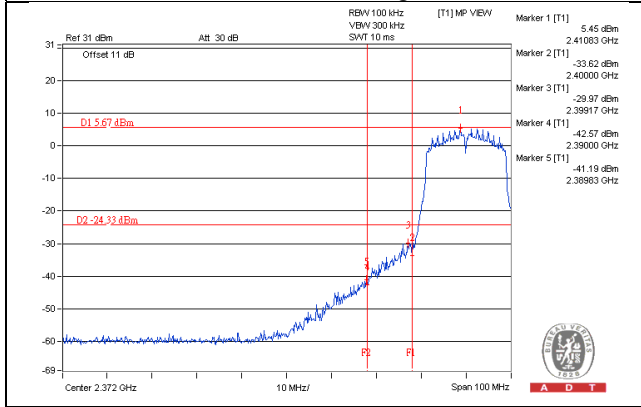

CH 11 Band edge

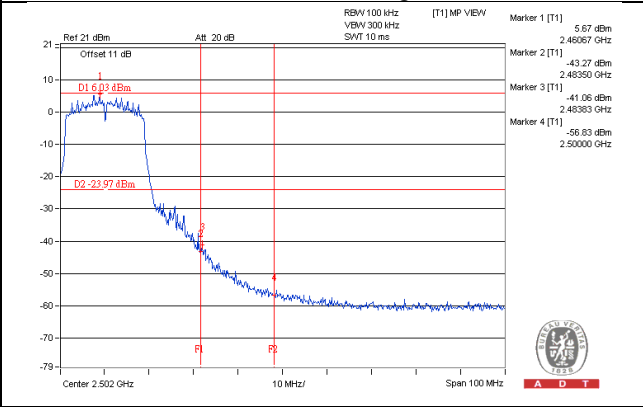

802.11n (HT20)_Chain 3

CH 1

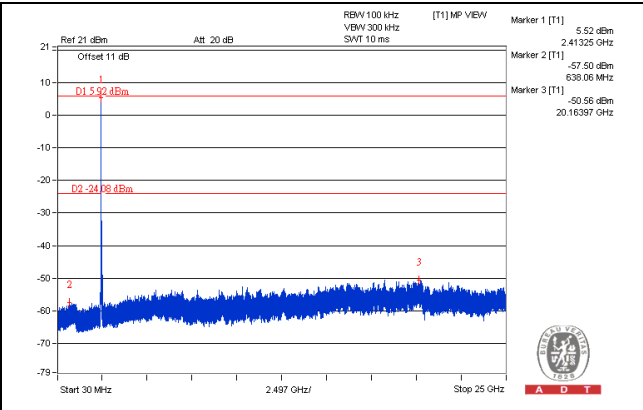
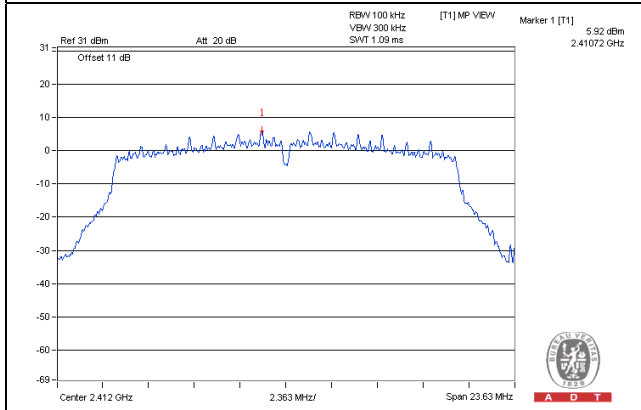

CH 6

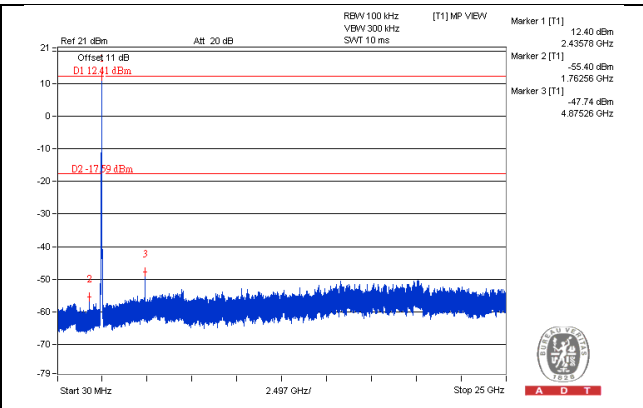
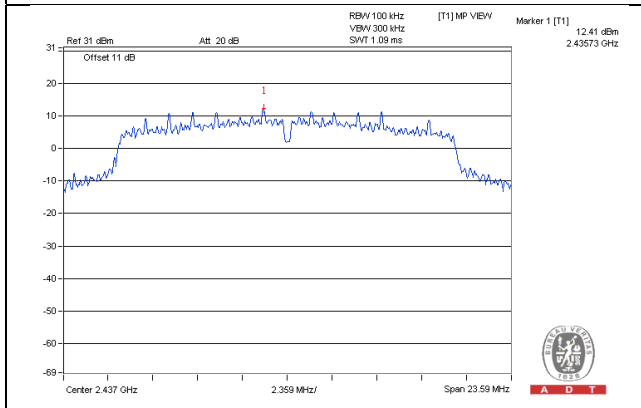

CH 11

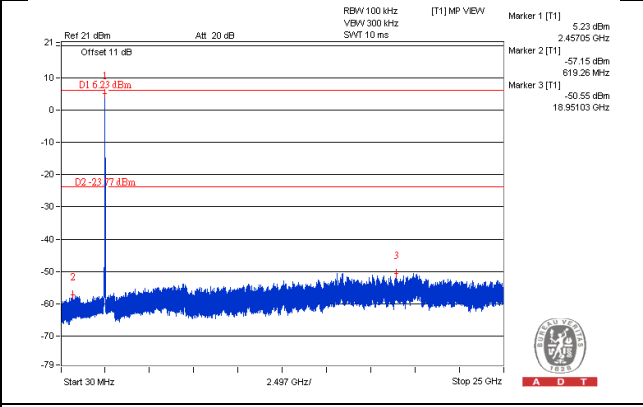
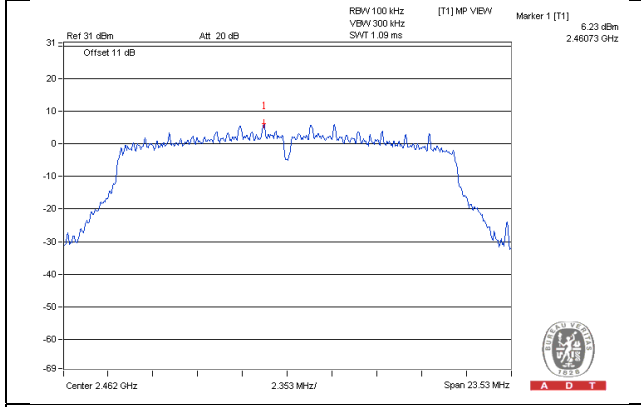

CH 1 Band edge

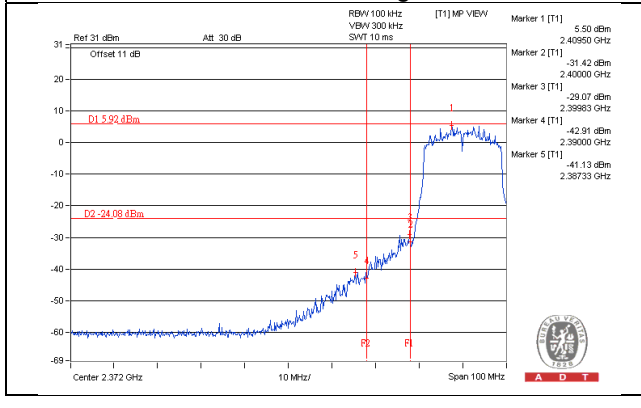

CH 11 Band edge

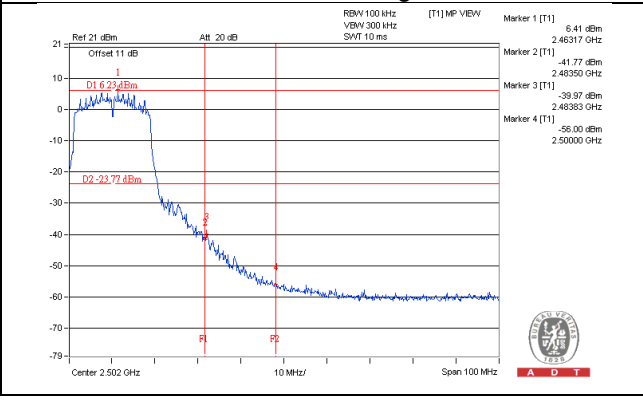

802.11n (HT40)_Chain 0

CH 3

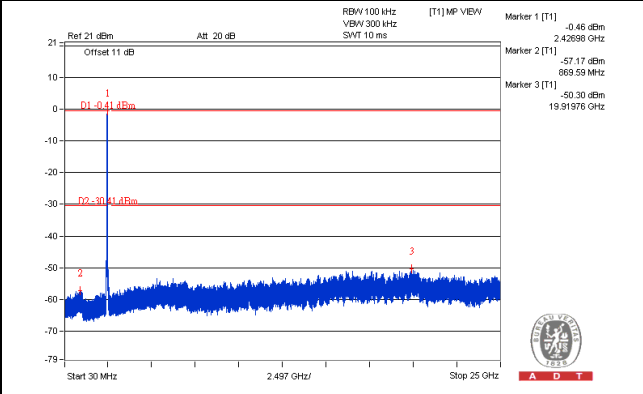
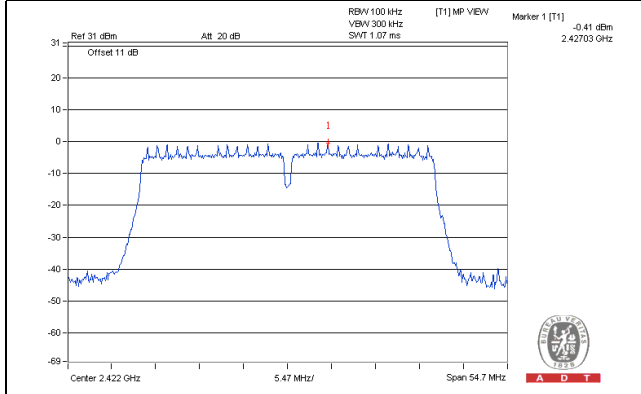

CH 6

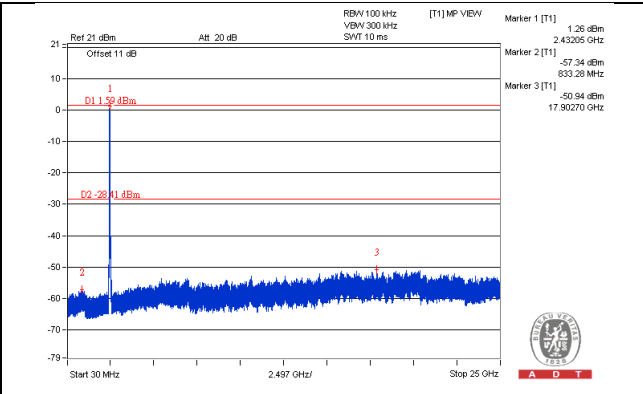
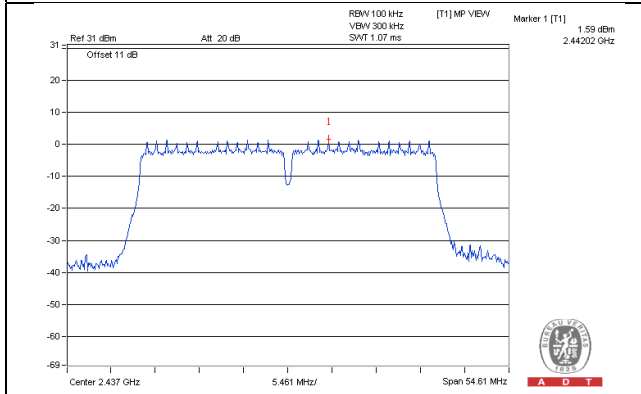

CH 9

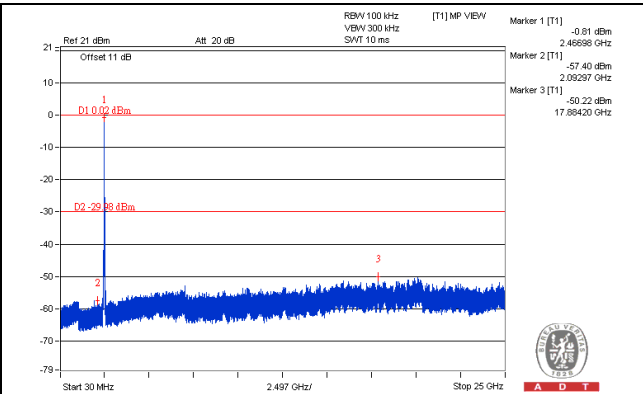
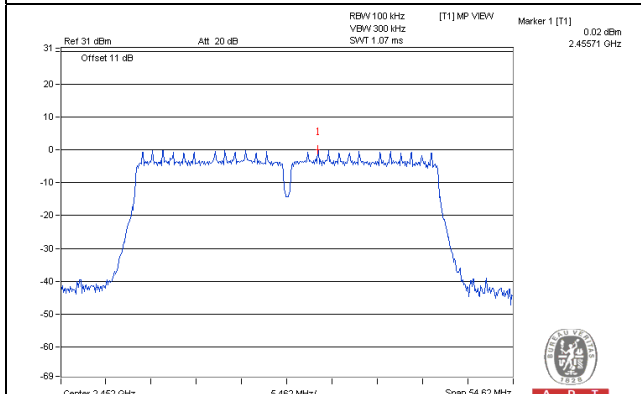

CH 3 Band edge

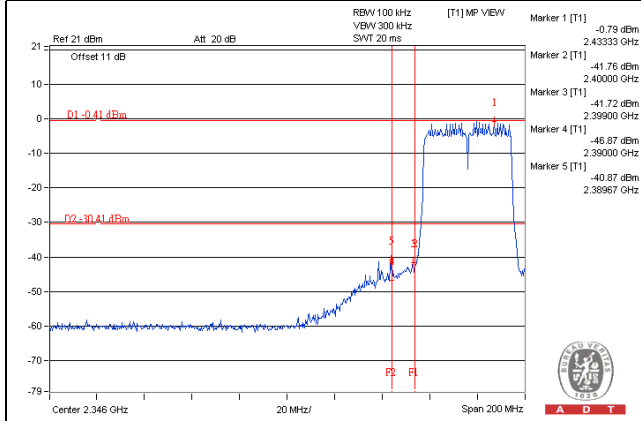

CH 9 Band edge

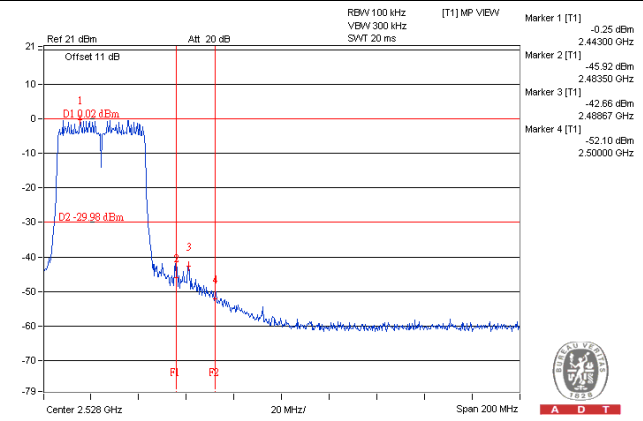

802.11n (HT40)_Chain 1

CH 3

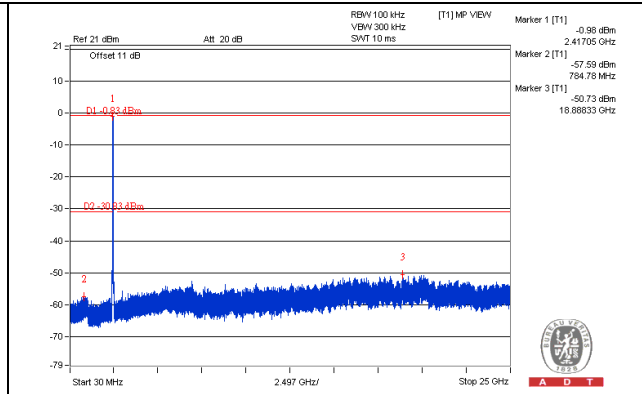
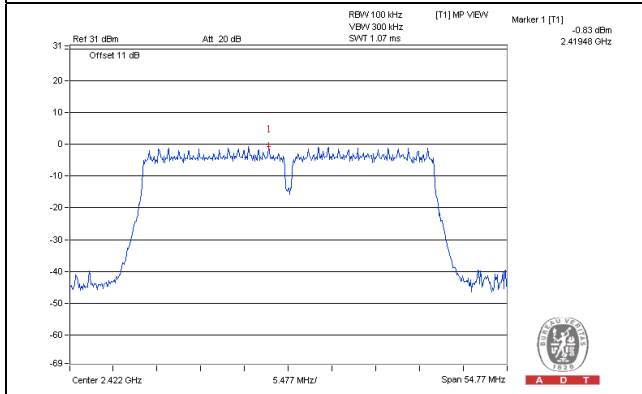

CH 6

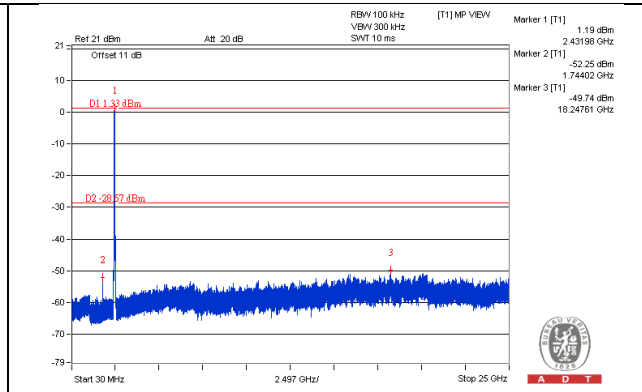
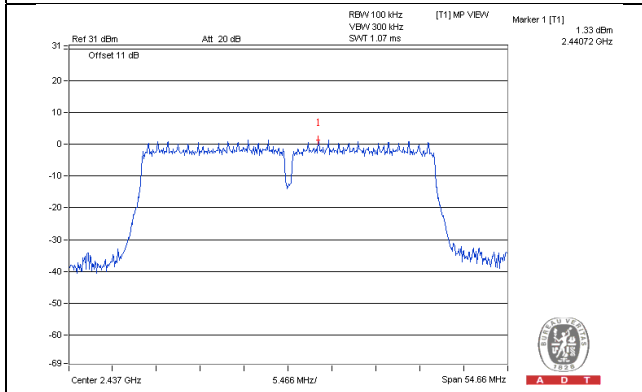

CH 9

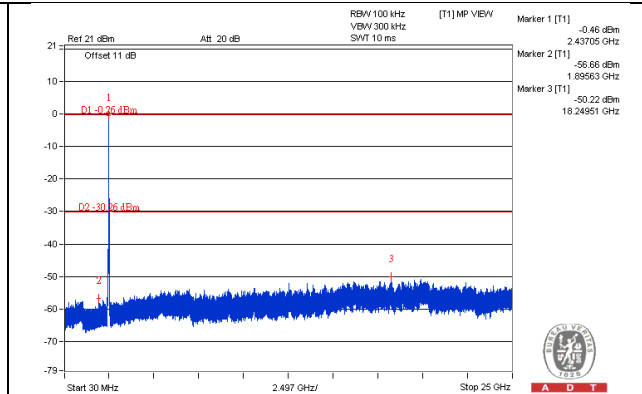
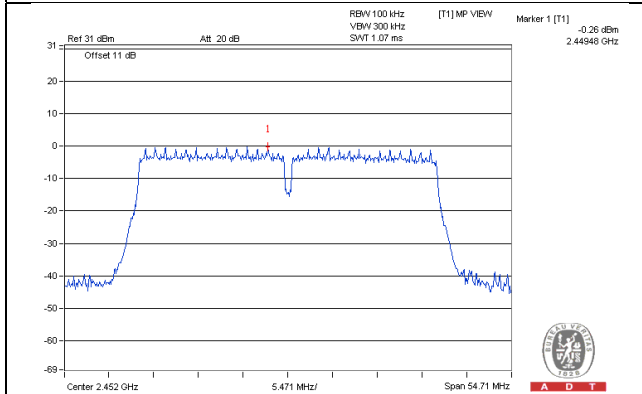

CH 3 Band edge

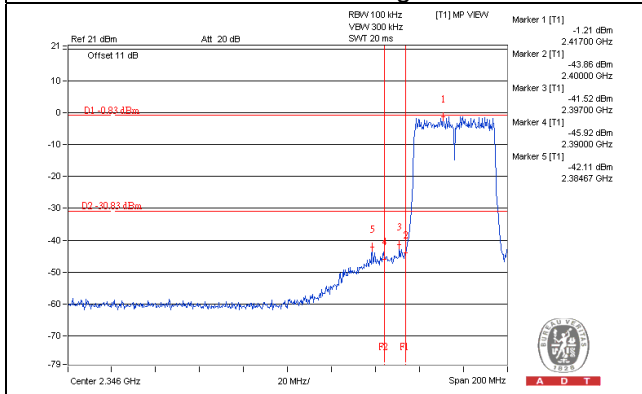

CH 9 Band edge

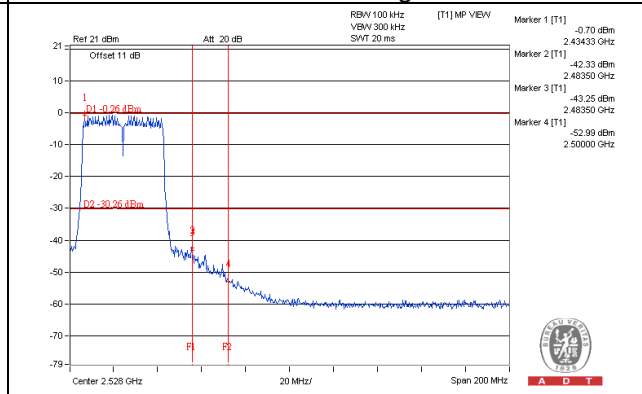

802.11n (HT40)_Chain 2

CH 3

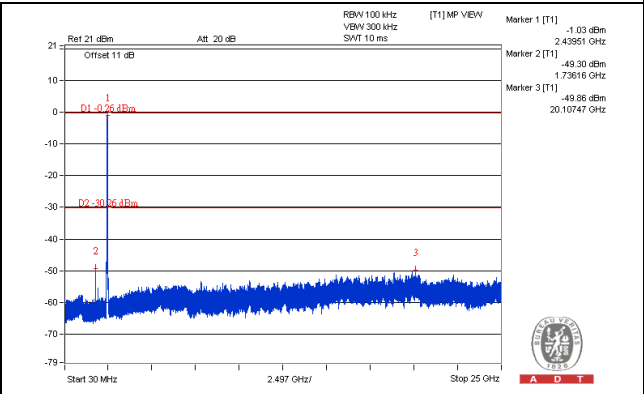
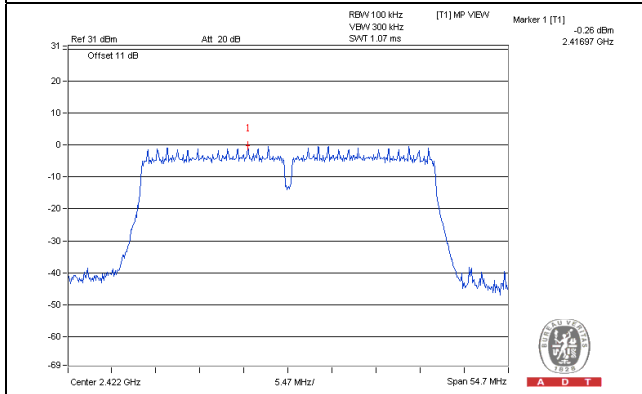

CH 6

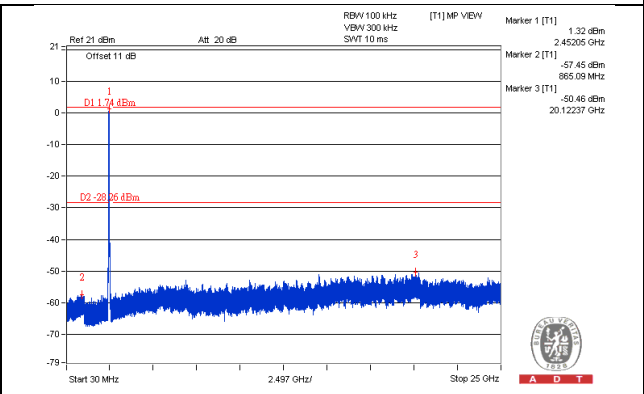
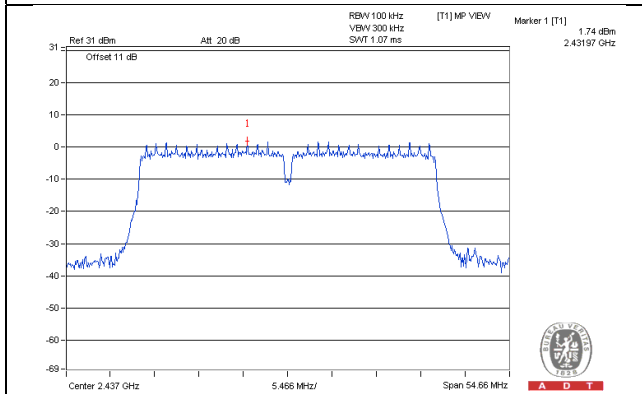

CH 9

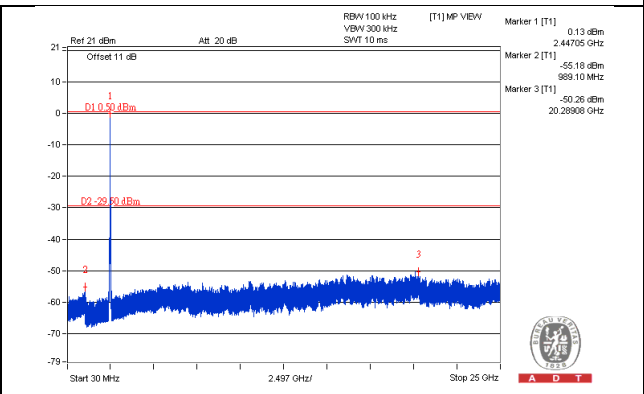
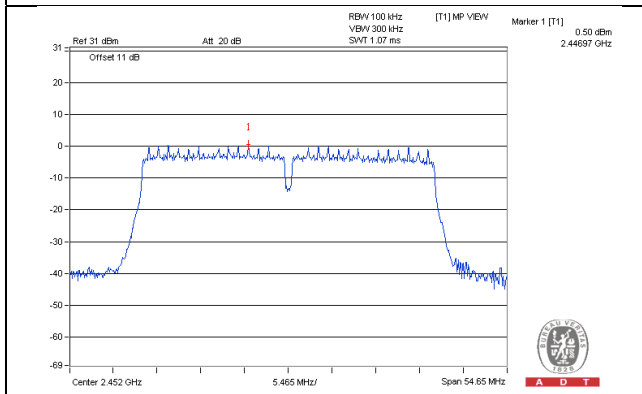

CH 3 Band edge

CH 9 Band edge

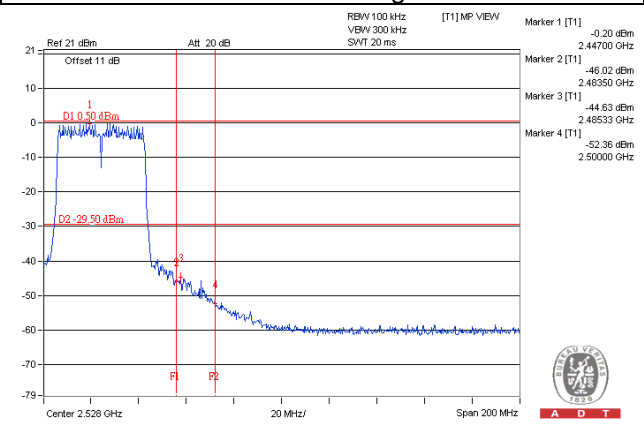
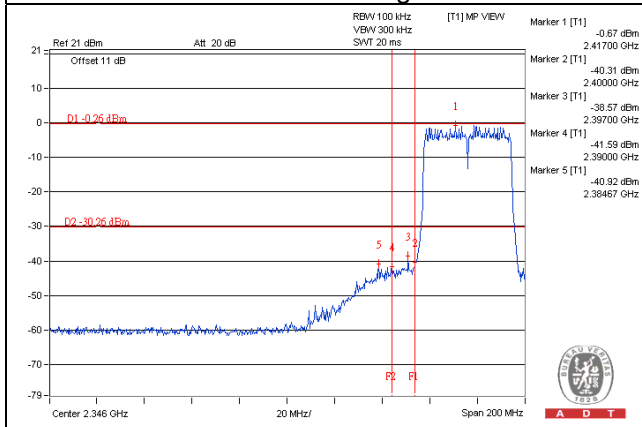

802.11n (HT40)_Chain 3

CH 3

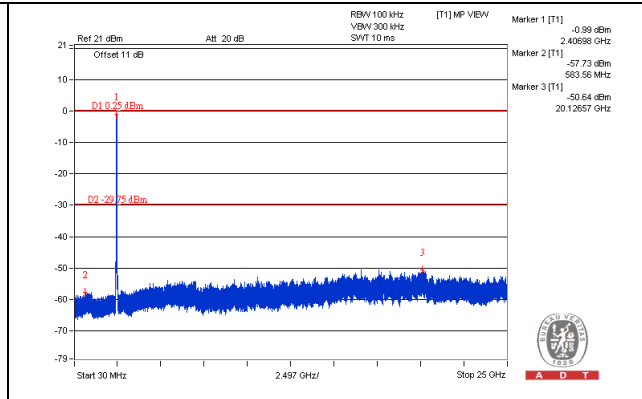
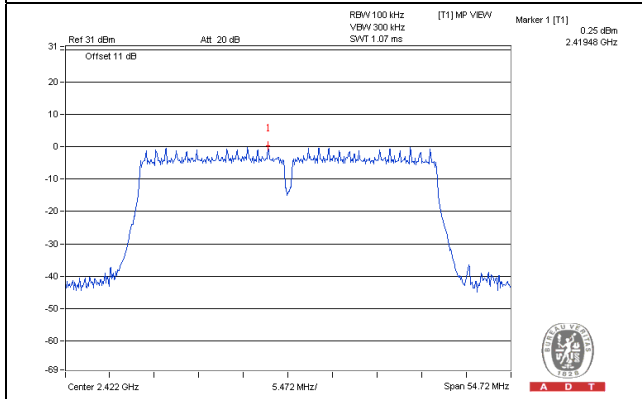

CH 6

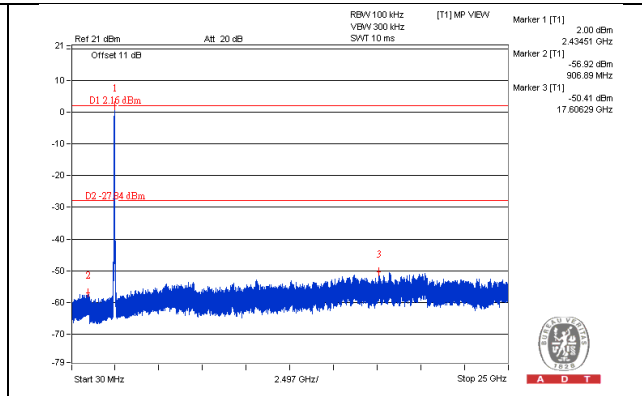
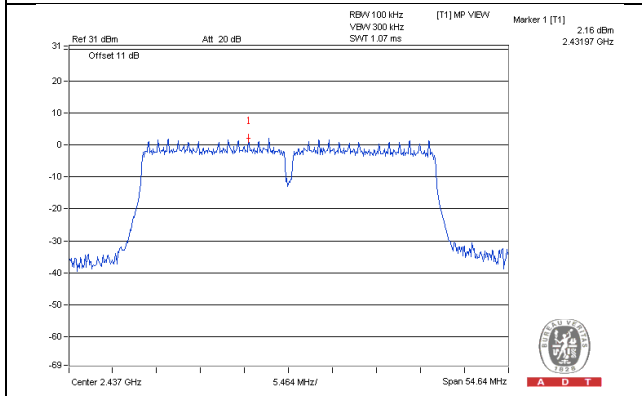

CH 9

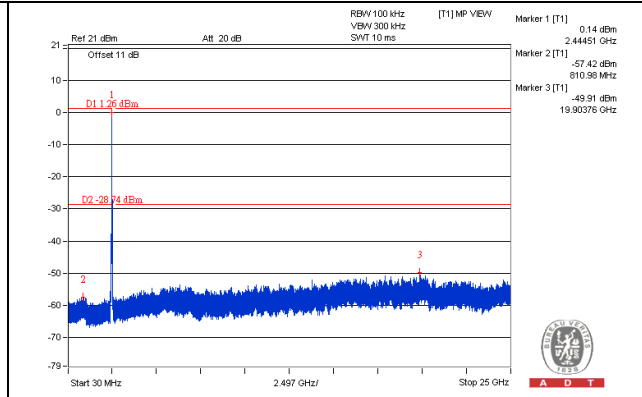
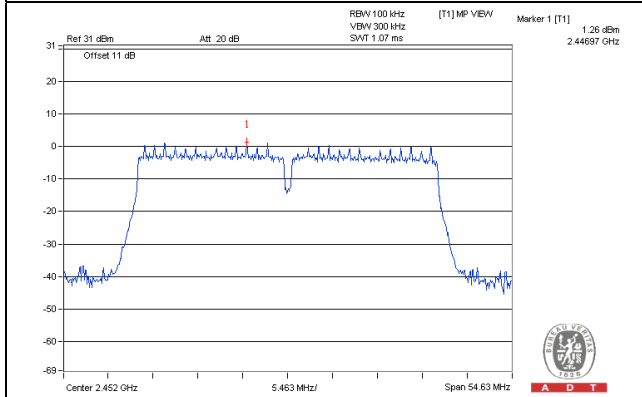

CH 3 Band edge

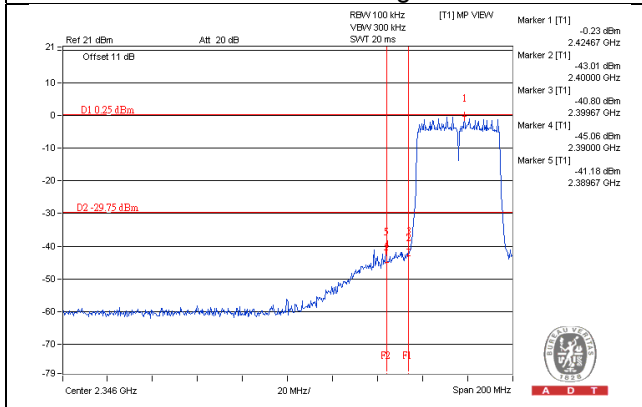

CH 9 Band edge

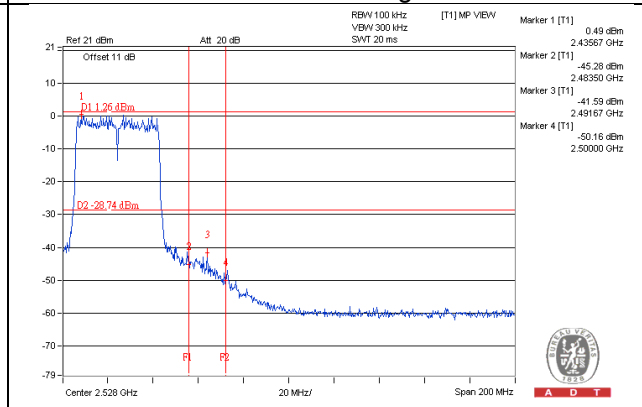

Test Mode C

1TX

802.11b

CH 1

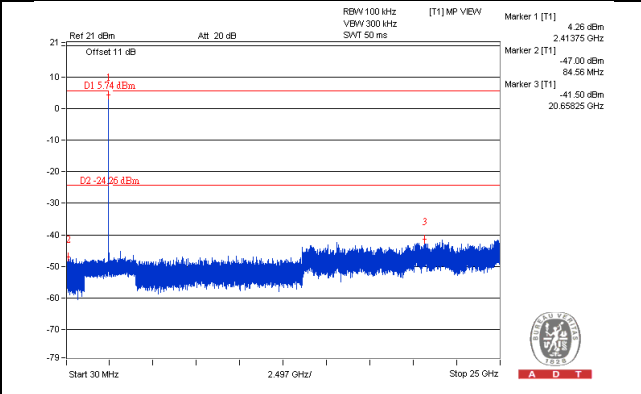
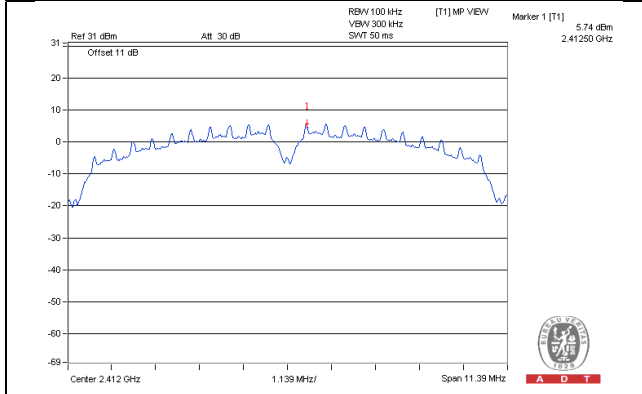

CH 6

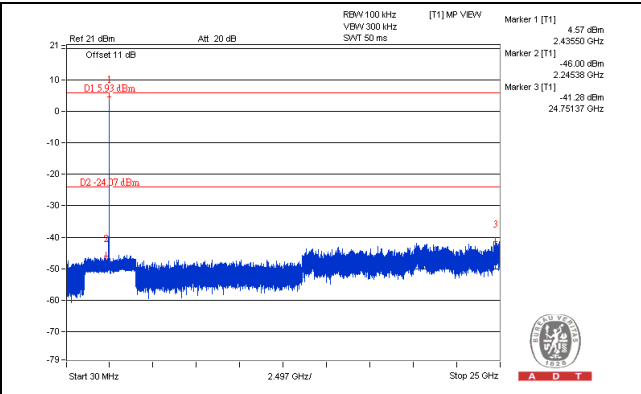
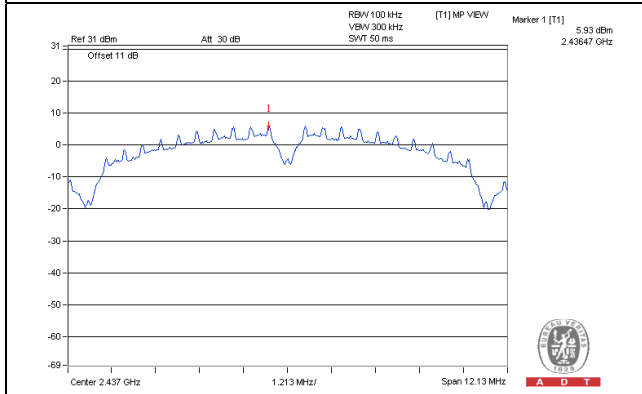

CH 11

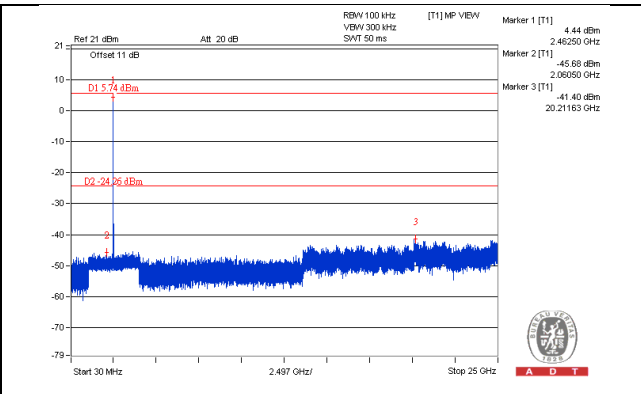
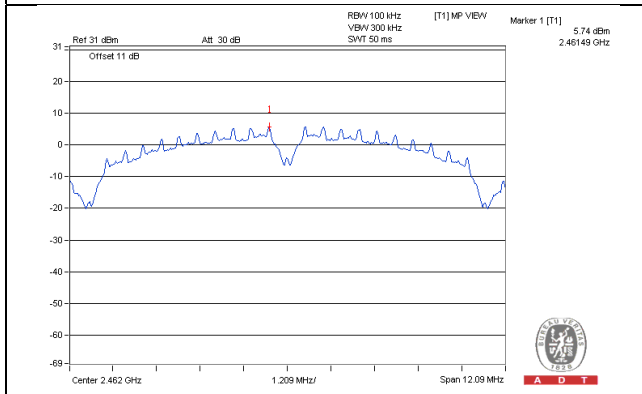

CH 1 Band edge

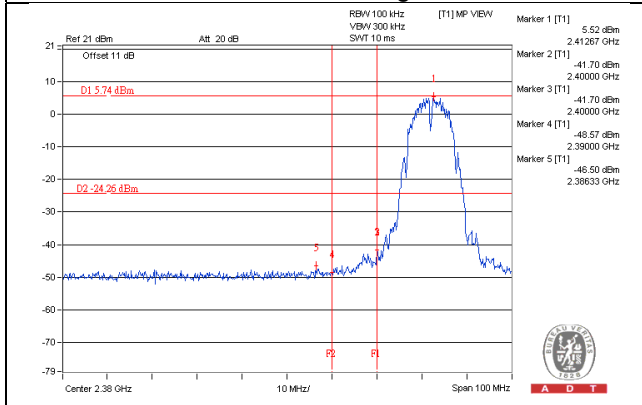

CH 11 Band edge

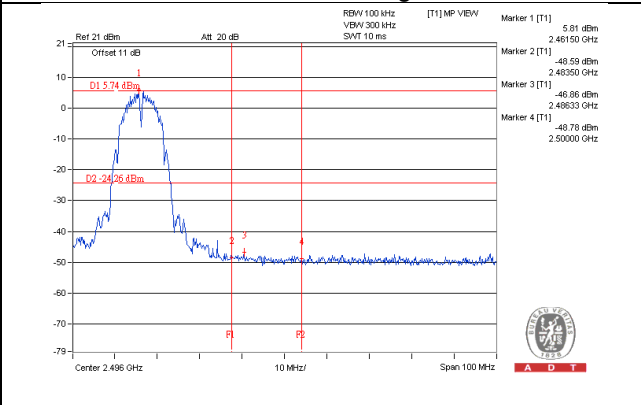

802.11g

CH 1

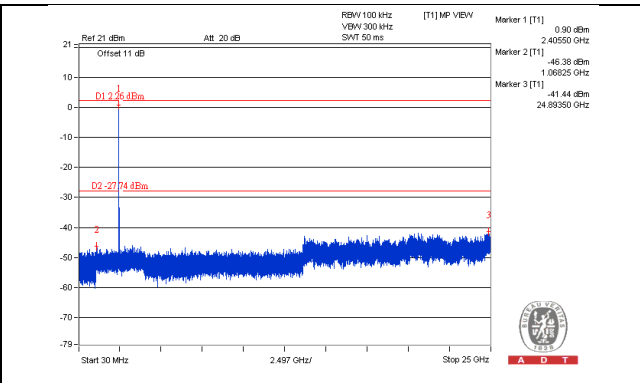
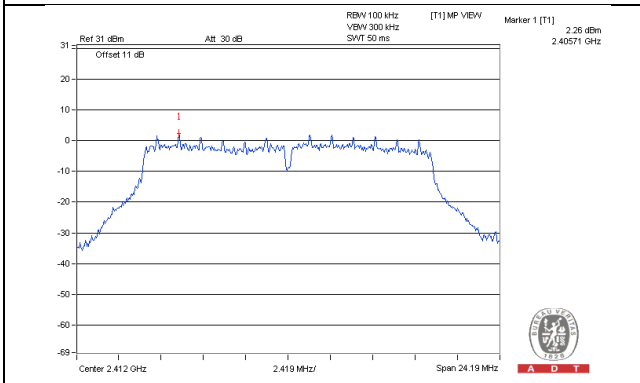

CH 6

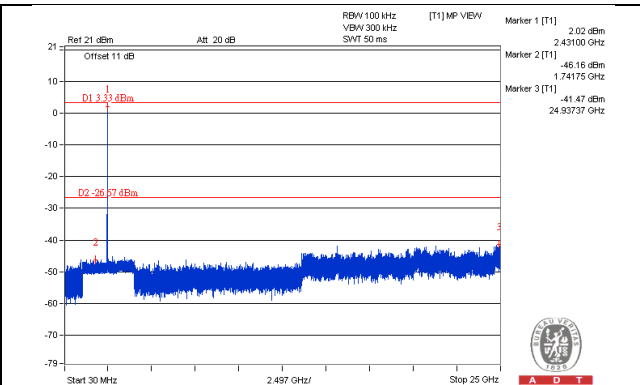
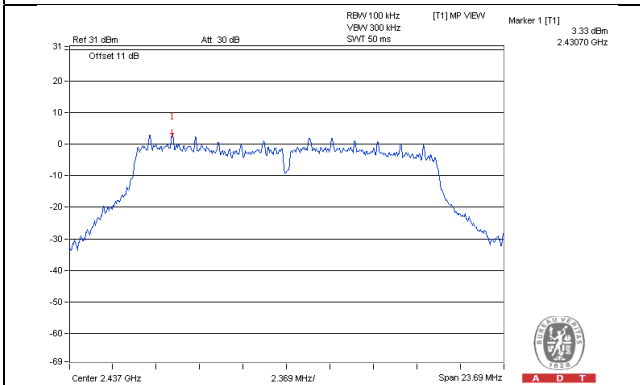

CH 11

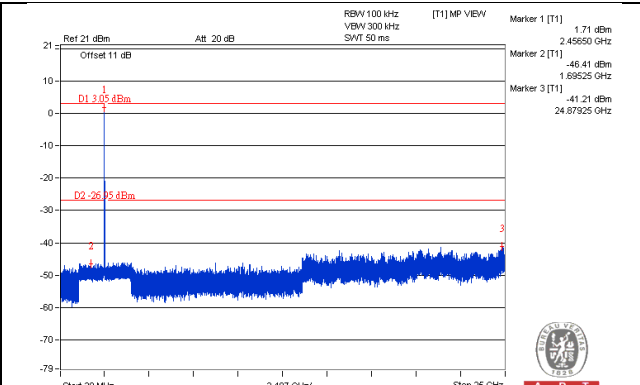
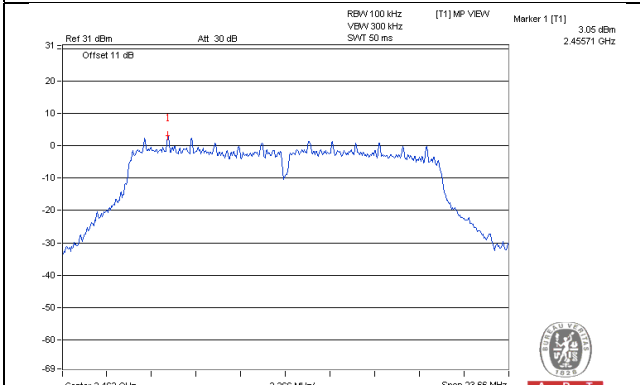

CH 1 Band edge

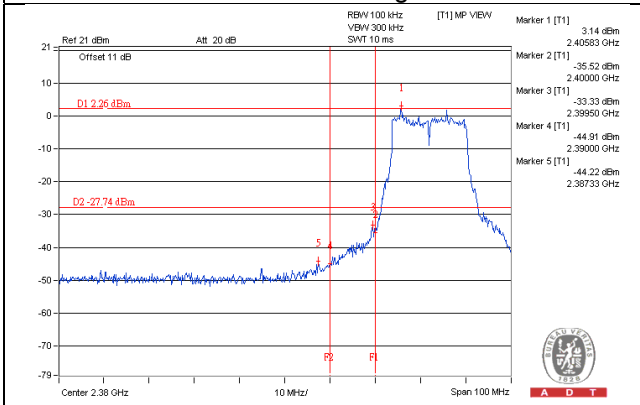

CH 11 Band edge

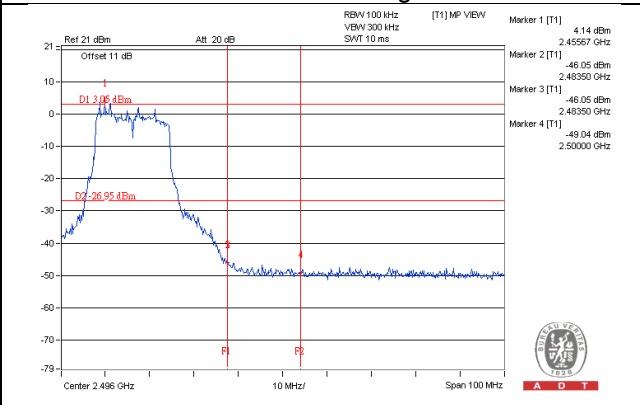

802.11n (HT20)

CH 1

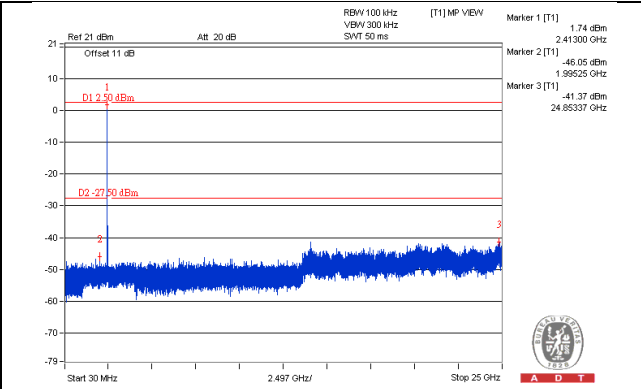
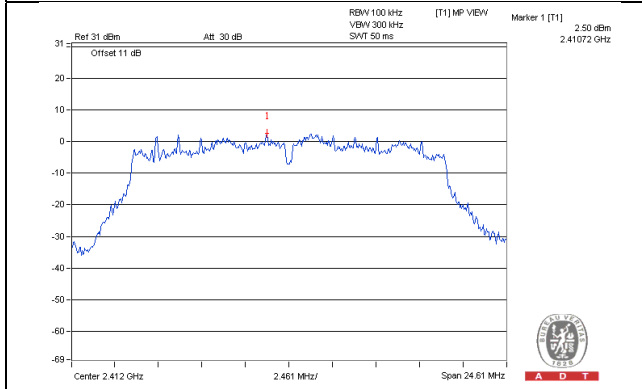

CH 6

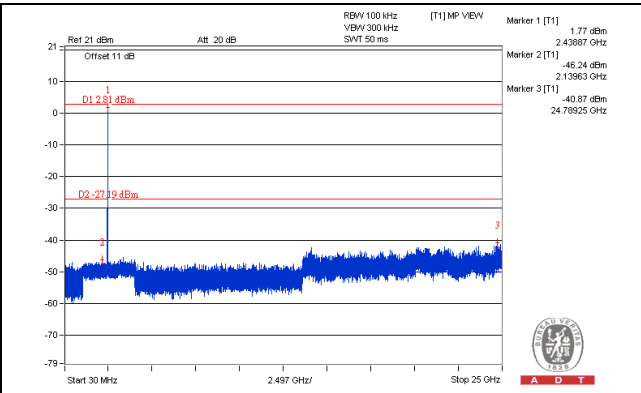
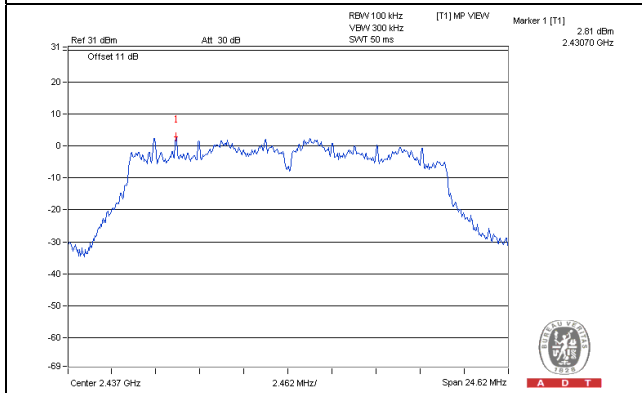

CH 11

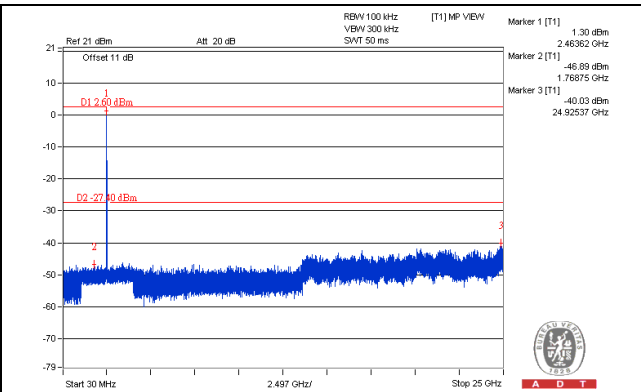
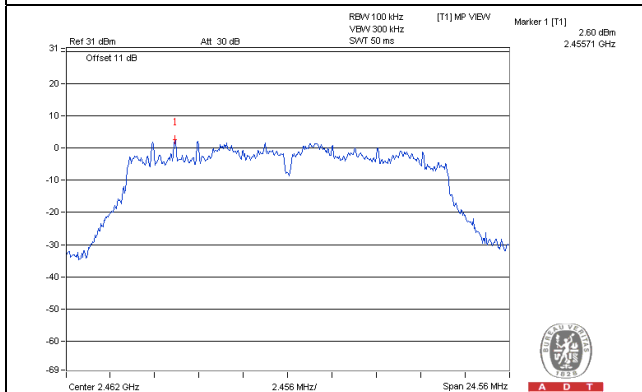

CH 1 Band edge

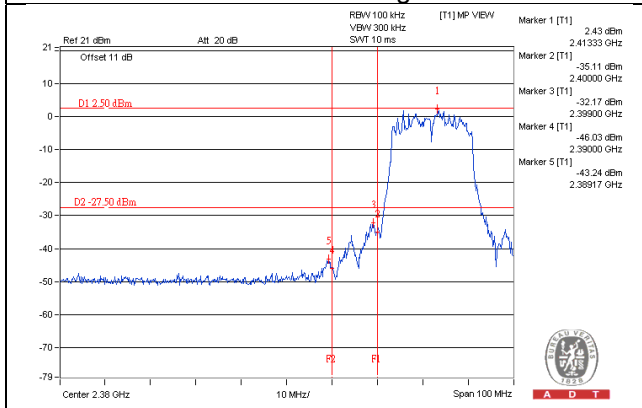

CH 11 Band edge

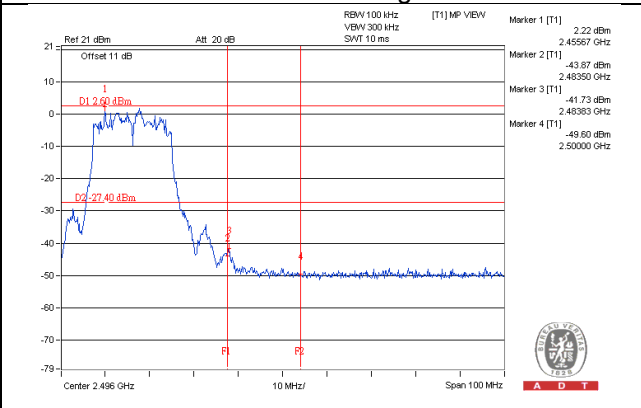

802.11n (HT40)

CH 3

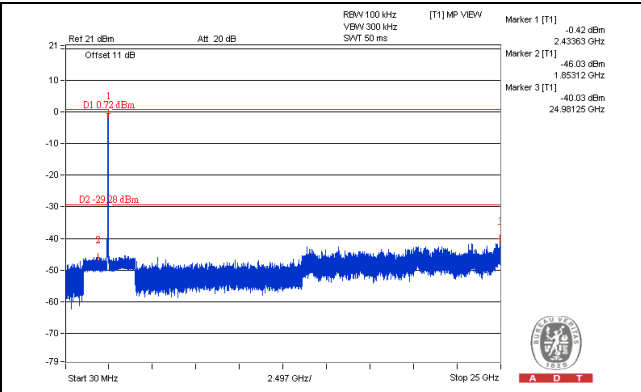
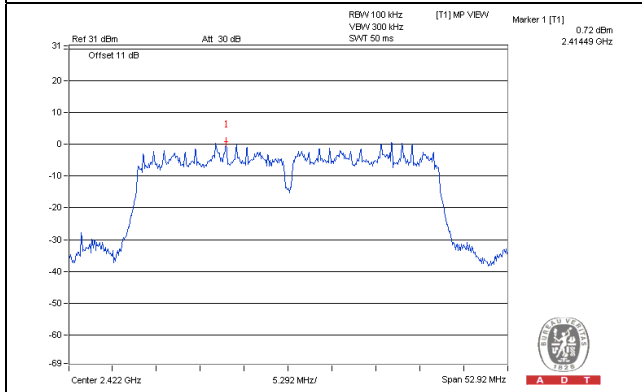

CH 6

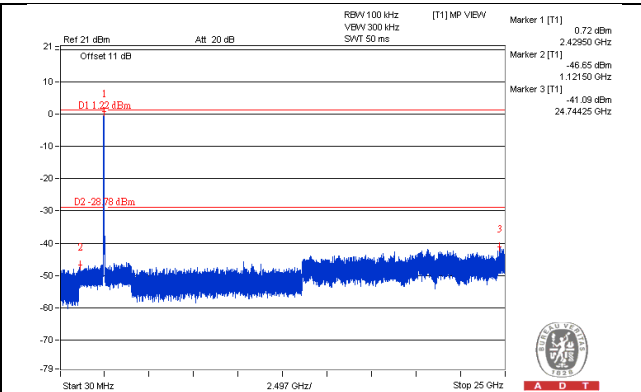
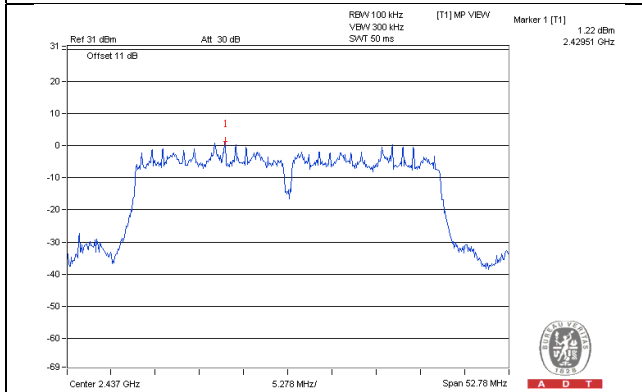

CH 9

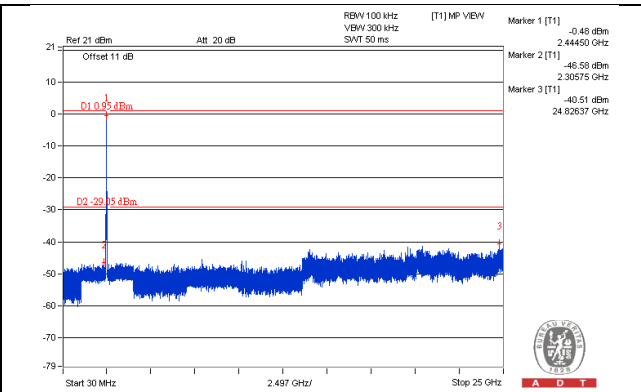
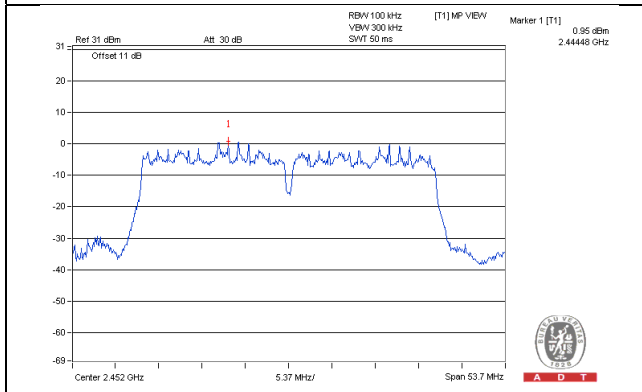

CH 3 Band edge

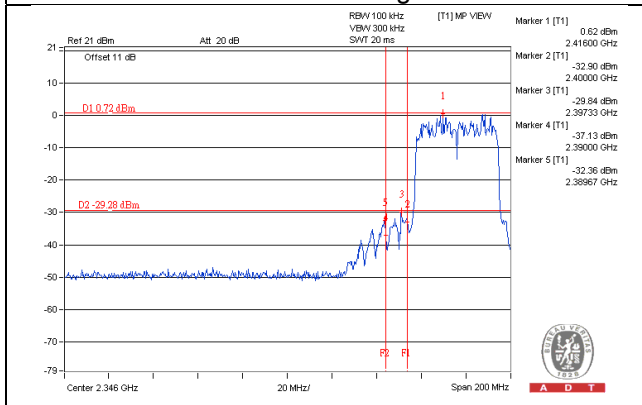

CH 9 Band edge

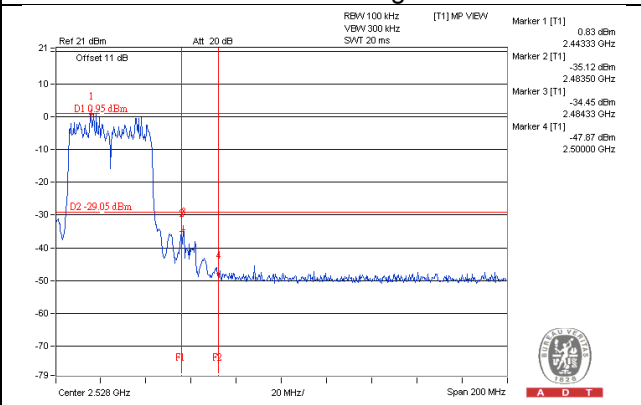

5 Pictures of Test Arrangements

Please refer to the attached file (Test Setup Photo).

Appendix – Information on the Testing Laboratories

We, Bureau Veritas Consumer Products Services (H.K.) Ltd., Taoyuan Branch, were founded in 1988 to provide our best service in EMC, Radio, Telecom and Safety consultation. Our laboratories are accredited and approved according to ISO/IEC 17025.

If you have any comments, please feel free to contact us at the following:

Linko EMC/RF Lab

Tel: 886-2-26052180

Fax: 886-2-26051924

Hsin Chu EMC/RF/Telecom Lab

Tel: 886-3-6668565

Fax: 886-3-6668323

Hwa Ya EMC/RF/Safety Lab

Tel: 886-3-3183232

Fax: 886-3-3270892

Email: service.adt@tw.bureauveritas.com

Web Site: www.bureauveritas-adt.com

The address and road map of all our labs can be found in our web site also.

--- END ---