

FCC Test Report

Report No.: RF170505C03-1

FCC ID: 2AHBN-AP21

Test Model: AP21

Received Date: May 05, 2017

Test Date: May 09 ~ Jun. 28, 2017

Issued Date: Jul. 13, 2017

Applicant: Mist Systems, Inc.

Address: 1601 South De Anza Blvd. Suite 248 Cupertino California United States
95014

Issued By: Bureau Veritas Consumer Products Services (H.K.) Ltd., Taoyuan Branch

Lab Address: No. 47-2, 14th Ling, Chia Pau Vil., Lin Kou Dist., New Taipei City, Taiwan
(R.O.C.)

Test Location: No. 19, Hwa Ya 2nd Rd., Wen Hwa Vil., Kwei Shan Dist., Taoyuan City
33383, TAIWAN (R.O.C.)



This report is for your exclusive use. Any copying or replication of this report to or for any other person or entity, or use of our name or trademark, is permitted only with our prior written permission. This report sets forth our findings solely with respect to the test samples identified herein. The results set forth in this report are not indicative or representative of the quality or characteristics of the lot from which a test sample was taken or any similar or identical product unless specifically and expressly noted. Our report includes all of the tests requested by you and the results thereof based upon the information that you provided to us. You have 60 days from date of issuance of this report to notify us of any material error or omission caused by our negligence, provided, however, that such notice shall be in writing and shall specifically address the issue you wish to raise. A failure to raise such issue within the prescribed time shall constitute your unqualified acceptance of the completeness of this report, the tests conducted and the correctness of the report contents. Unless specifically mentioned, the uncertainty of measurement has been explicitly taken into account to declare the compliance or non-compliance to the specification. The report must not be used by the client to claim product certification, approval, or endorsement by TAF or any government agencies.

Table of Contents

Release Control Record	4
1 Certificate of Conformity	5
2 Summary of Test Results	6
2.1 Measurement Uncertainty	6
2.2 Modification Record	6
3 General Information	7
3.1 General Description of EUT	7
3.2 Description of Test Modes	9
3.2.1 Test Mode Applicability and Tested Channel Detail.....	10
3.3 Duty Cycle of Test Signal	12
3.4 Description of Support Units	14
3.4.1 Configuration of System under Test	14
3.5 General Description of Applied Standards	15
4 Test Types and Results	16
4.1 Radiated Emission and Bandedge Measurement.....	16
4.1.1 Limits of Radiated Emission and Bandedge Measurement	16
4.1.2 Test Instruments	17
4.1.3 Test Procedures.....	18
4.1.4 Deviation from Test Standard	19
4.1.5 Test Setup.....	19
4.1.6 EUT Operating Conditions.....	20
4.1.7 Test Results	21
4.2 Conducted Emission Measurement	59
4.2.1 Limits of Conducted Emission Measurement	59
4.2.2 Test Instruments	59
4.2.3 Test Procedures.....	60
4.2.4 Deviation from Test Standard	60
4.2.5 Test Setup.....	60
4.2.6 EUT Operating Conditions.....	60
4.2.7 Test Results	61
4.3 Transmit Power Measurement	65
4.3.1 Limits of Transmit Power Measurement	65
4.3.2 Test Setup.....	65
4.3.3 Test Instruments	66
4.3.4 Test Procedure	66
4.3.5 Deviation from Test Standard	66
4.3.6 EUT Operating Conditions.....	66
4.3.7 Test Result.....	67
4.4 Occupied Bandwidth Measurement	74
4.4.1 Test Setup.....	74
4.4.2 Test Instruments	74
4.4.3 Test Procedure	74
4.4.4 Test Result.....	75
4.5 Peak Power Spectral Density Measurement	79
4.5.1 Limits of Peak Power Spectral Density Measurement	79
4.5.2 Test Setup.....	79
4.5.3 Test Instruments	79
4.5.4 Test Procedures.....	80
4.5.5 Deviation from Test Standard	80
4.5.6 EUT Operating Conditions.....	80
4.5.7 Test Results	81
4.6 Frequency Stability.....	90
4.6.1 Limits of Frequency Stability Measurement	90

4.6.2	Test Setup.....	90
4.6.3	Test Instruments	90
4.6.4	Test Procedure	90
4.6.5	Deviation from Test Standard	90
4.6.6	EUT Operating Condition	90
4.6.7	Test Results	91
4.7	6dB Bandwidth Measurement.....	93
4.7.1	Limits of 6dB Bandwidth Measurement.....	93
4.7.2	Test Setup.....	93
4.7.3	Test Instruments	93
4.7.4	Test Procedure	93
4.7.5	Deviation from Test Standard	93
4.7.6	EUT Operating Condition	93
4.7.7	Test Results	94
5	Pictures of Test Arrangements.....	98
	Annex A- Radiated Out of Band Emission (OOBE) Measurement (For U-NII-3 band).....	99
	Appendix – Information on the Testing Laboratories	105

Release Control Record

Issue No.	Description	Date Issued
RF170505C03-1	Original release.	Jul. 13, 2017

1 Certificate of Conformity

Product: Wi-Fi & BLE Array AP
Brand: Mist
Test Model: AP21
Sample Status: Engineering sample
Applicant: Mist Systems, Inc.
Test Date: May 09 ~ Jun. 28, 2017
Standards: 47 CFR FCC Part 15, Subpart E (Section 15.407)
ANSI C63.10:2013

The above equipment has been tested by **Bureau Veritas Consumer Products Services (H.K.) Ltd., Taoyuan Branch**, and found compliance with the requirement of the above standards. The test record, data evaluation & Equipment Under Test (EUT) configurations represented herein are true and accurate accounts of the measurements of the sample's EMC characteristics under the conditions specified in this report.

Prepared by : Polly Chien , **Date:** Jul. 13, 2017
Polly Chien / Specialist

Approved by : Ken Liu , **Date:** Jul. 13, 2017
Ken Liu / Senior Manager

2 Summary of Test Results

47 CFR FCC Part 15, Subpart E (Section 15.407)			
FCC Clause	Test Item	Result	Remarks
15.407(b)(6)	AC Power Conducted Emissions	Pass	Meet the requirement of limit. Minimum passing margin is -4.48dB at 16.91400MHz.
15.407(b)(1/2/3/4(i/ii)/6)	Radiated Emissions & Band Edge Measurement	Pass	Meet the requirement of limit. Minimum passing margin is -0.5dB at 5150.00MHz.
15.407(a)(1/2/3)	Max Average Transmit Power	Pass	Meet the requirement of limit.
---	Occupied Bandwidth Measurement	-	Reference only.
15.407(a)(1/2/3)	Peak Power Spectral Density	Pass	Meet the requirement of limit.
15.407(e)	6dB bandwidth	Pass	Meet the requirement of limit. (U-NII-3 Band only)
15.407(g)	Frequency Stability	Pass	Meet the requirement of limit.
15.203	Antenna Requirement	Pass	Antenna connector is IPEX not a standard connector.

*For U-NII-3 band compliance with rule part 15.407(b)(4)(i), the OOB test plots were recorded in Annex A.

2.1 Measurement Uncertainty

Where relevant, the following measurement uncertainty levels have been estimated for tests performed on the EUT as specified in CISPR 16-4-2:

Measurement	Frequency	Expanded Uncertainty (k=2) (\pm)
Conducted Emissions at mains ports	150kHz ~ 30MHz	2.94 dB
Radiated Emissions up to 1 GHz	30MHz ~ 200MHz	3.63 dB
	200MHz ~ 1000MHz	3.64 dB
Radiated Emissions above 1 GHz	1GHz ~ 18GHz	2.29 dB
	18GHz ~ 40GHz	2.29 dB

2.2 Modification Record

There were no modifications required for compliance.

3 General Information

3.1 General Description of EUT

Product	Wi-Fi & BLE Array AP
Brand	Mist
Test Model	AP21
Sample Status	Engineering sample
Power Supply Rating	12Vdc (adapter) 55Vdc (POE)
Modulation Type	256QAM, 64QAM, 16QAM, QPSK, BPSK
Modulation Technology	OFDM
Transfer Rate	802.11a: 54/48/36/24/18/12/9/6Mbps 802.11n: up to 300Mbps 802.11ac: up to 866.7Mbps
Operating Frequency	5180~5240MHz, 5745~5825MHz
Number of Channel	5180~5240MHz: 802.11a, 802.11n (HT20), 802.11ac (VHT20): 4 802.11n (HT40), 802.11n (HT40): 2 802.11ac (VHT80): 1 5745~5825MHz: 802.11a, 802.11n (HT20), 802.11ac (VHT20): 5 802.11n (HT40), 802.11n (HT40): 2 802.11ac (VHT80): 1
Output Power	CDD Mode, 1TX: 5180~5240MHz: 129.718mW 5745~5825MHz: 200.909mW CDD Mode, 2TX: 5180~5240MHz: 221.672mW 5745~5825MHz: 268.268mW Beamforming Mode: 5180~5240MHz: 211.879mW 5745~5825MHz: 250.317mW
Antenna Type	Refer to Note
Antenna Connector	Refer to Note
Accessory Device	NA
Cable Supplied	NA

Note:

1. The EUT incorporates a MIMO function. Physically, the EUT provides 2 completed transmitters and 2 receivers.

Modulation Mode	TX Function	Beamforming
802.11a	1TX, 2TX	Not Support
802.11n (HT20)	1TX, 2TX	Support
802.11n (HT40)	1TX, 2TX	Support
802.11ac (VHT20)	1TX, 2TX	Support
802.11ac (VHT40)	1TX, 2TX	Support
802.11ac (VHT80)	1TX, 2TX	Support

* The modulation and bandwidth are similar for 802.11n mode for 20MHz/40MHz and 802.11ac mode for 20MHz/40MHz, therefore investigated worst case to representative mode in test report. (Final test mode refer section 3.2.1)

* For 802.11n and 802.11ac, CDD mode and Beamforming mode are presented in power output test item. For other test items, Beamforming mode is the worst case for final tests after pretesting.

2. There are three radios for the EUT.

Radio	Antenna	Brand	Model	Function
Radio 1	WIFI Ant. 1	WNC	81EAAH15.GEP	WLAN 2.4G & 5G (RX only)
	WIFI Ant. 2	WNC	81EAAH15.GEQ	
Radio 2	WIFI Ant. 1	WNC	81EAAH15.GER	WLAN 5G
	WIFI Ant. 2	WNC	81EAAH15.GES	
Radio 3	BT-Omni Ant.	WNC	81EAAH15.GET	BT LE

3. The following antennas were provided to the EUT.

Antenna Type	PIFA			
Antenna Connector	IPEX			
Gain (dBi)	Frequency			
	2.4~2.5GHz	5.15GHz	5.55GHz	5.85GHz
Radio 1: WIFI Ant. 1	3.43	4.85	4.86	4.91
Radio 1: WIFI Ant. 2	3.63	3.61	4.45	4.95
Radio 2: WIFI Ant. 1	-	4.93	4.51	4.96
Radio 2: WIFI Ant. 2	-	4.78	4.62	4.96

4. The EUT uses following adapter & PoE. (Support unit only)

Adapter	
Brand	Channel Well Technology
Model	2ABN036F US
Input Power	100-240Vac~50/60Hz 1.0A
Output Power	12.0Vdc / 3.0A
Power Line	1.45m DC cable without core attached on adapter

PoE	
Brand	Microsemi
Model	PD-9001GR/AT/AC
Input Power	100-240Vac~50/60Hz 0.67A
Output Power	55Vdc / 0.6A

5. Spurious emission of the simultaneous operation (2.4GHz, 5GHz and BT) has been evaluated and no non-compliance was found.

3.2 Description of Test Modes

5180~5240MHz:

4 channels are provided for 802.11a, 802.11n (HT20), 802.11ac (VHT20):

Channel	Frequency	Channel	Frequency
36	5180 MHz	44	5220 MHz
40	5200 MHz	48	5240 MHz

2 channels are provided for 802.11n (HT40), 802.11ac (VHT40):

Channel	Frequency	Channel	Frequency
38	5190 MHz	46	5230 MHz

1 channel is provided for 802.11ac (VHT80):

Channel	Frequency
42	5210MHz

5745~5825MHz:

5 channels are provided for 802.11a, 802.11n (HT20), 802.11ac (VHT20):

Channel	Frequency	Channel	Frequency
149	5745MHz	161	5805MHz
153	5765MHz	165	5825MHz
157	5785MHz		

2 channels are provided for 802.11n (HT40), 802.11ac (VHT40):

Channel	Frequency	Channel	Frequency
151	5755MHz	159	5795MHz

1 channel is provided for 802.11ac (VHT80):

Channel	Frequency
155	5775MHz

3.2.1 Test Mode Applicability and Tested Channel Detail

EUT Configure Mode	Applicable to				Description
	RE \geq 1G	RE<1G	PLC	APCM	
A	√	√	√	√	Power from adapter
B	-	√	√	-	Power from PoE

Where RE \geq 1G: Radiated Emission above 1GHz & Bandedge Measurement
 RE<1G: Radiated Emission below 1GHz
 PLC: Power Line Conducted Emission
 APCM: Antenna Port Conducted Measurement

Note:

- The EUT had been pre-tested on the positioned of each 3 axis. The worst case was found when positioned on X-plane.
- "-" means no effect.

Radiated Emission Test (Above 1GHz):

- Pre-Scan has been conducted to determine the worst-case mode from all possible combinations between available modulations, data rates and antenna ports (if EUT with antenna diversity architecture).
- Following channel(s) was (were) selected for the final test as listed below.

EUT Configure Mode	Mode	Frequency Band (MHz)	Available Channel	Tested Channel	Modulation Technology	Data Rate (Mbps)	Remark
A	802.11a	5180-5240	36 to 48	36, 40, 48	OFDM	6.0	1TX / 2TX
	802.11n (HT20)		36 to 48	36, 40, 48	OFDM	6.5 / 7.2	1TX / 2TX
	802.11n (HT40)		38 to 46	38, 46	OFDM	13.5 / 15.0	1TX / 2TX
	802.11ac (VHT80)		42	42	OFDM	29.3 / 65.0	1TX / 2TX
A	802.11a	5745-5825	149 to 165	149, 157, 165	OFDM	6.0	1TX / 2TX
	802.11n (HT20)		149 to 165	149, 157, 165	OFDM	6.5 / 7.2	1TX / 2TX
	802.11n (HT40)		151 to 159	151, 159	OFDM	13.5 / 15.0	1TX / 2TX
	802.11ac (VHT80)		155	155	OFDM	29.3 / 65.0	1TX / 2TX

Radiated Emission Test (Below 1GHz):

- Pre-Scan has been conducted to determine the worst-case mode from all possible combinations between available modulations, data rates and antenna ports (if EUT with antenna diversity architecture).
- Following channel(s) was (were) selected for the final test as listed below.

EUT Configure Mode	Mode	Frequency Band (MHz)	Available Channel	Tested Channel	Modulation Technology	Data Rate (Mbps)	Remark
A, B	802.11a	5180-5240	36 to 48	149	OFDM	6.0	2TX
		5745-5825	149 to 165		OFDM	6.0	2TX

Power Line Conducted Emission Test:

- Pre-Scan has been conducted to determine the worst-case mode from all possible combinations between available modulations, data rates and antenna ports (if EUT with antenna diversity architecture).
- Following channel(s) was (were) selected for the final test as listed below.

EUT Configure Mode	Mode	Frequency Band (MHz)	Available Channel	Tested Channel	Modulation Technology	Data Rate (Mbps)	Remark
A, B	802.11a	5180-5240	36 to 48	149	OFDM	6.0	2TX
		5745-5825	149 to 165		OFDM	6.0	2TX

Antenna Port Conducted Measurement:

- This item includes all test value of each mode, but only includes spectrum plot of worst value of each mode.
- Pre-Scan has been conducted to determine the worst-case mode from all possible combinations between available modulations, data rates and antenna ports (if EUT with antenna diversity architecture).
- Following channel(s) was (were) selected for the final test as listed below.

EUT Configure Mode	Mode	Frequency Band (MHz)	Available Channel	Tested Channel	Modulation Technology	Data Rate (Mbps)	Remark
A	802.11a	5180-5240	36 to 48	36, 40, 48	OFDM	6.0	1TX / 2TX
	802.11n (HT20)		36 to 48	36, 40, 48	OFDM	6.5 / 7.2	1TX / 2TX
	802.11n (HT40)		38 to 46	38, 46	OFDM	13.5 / 15.0	1TX / 2TX
	802.11ac (VHT80)		42	42	OFDM	29.3 / 65.0	1TX / 2TX
A	802.11a	5745-5825	149 to 165	149, 157, 165	OFDM	6.0	1TX / 2TX
	802.11n (HT20)		149 to 165	149, 157, 165	OFDM	6.5 / 7.2	1TX / 2TX
	802.11n (HT40)		151 to 159	151, 159	OFDM	13.5 / 15.0	1TX / 2TX
	802.11ac (VHT80)		155	155	OFDM	29.3 / 65.0	1TX / 2TX

Test Condition:

Applicable to	Environmental Conditions	Input Power (System)	Tested by
RE \geq 1G	20 deg. C, 69% RH 25 deg. C, 70% RH	120Vac, 60Hz	Bayu Chen Bond Tseng
RE<1G	25 deg. C, 70% RH	120Vac, 60Hz 55Vdc	Matthew Yang
PLC	25 deg. C, 70% RH	120Vac, 60Hz 55Vdc	Matthew Yang
APCM	25 deg. C, 60% RH	120Vac, 60Hz	Ted Wu

3.3 Duty Cycle of Test Signal

Duty cycle of test signal is $\geq 98\%$, duty factor is not required.

Duty cycle of test signal is $< 98\%$, duty factor shall be considered.

1TX

802.11a: Duty cycle = $2.058/2.083 = 0.988$

802.11n (HT20): Duty cycle = $1.918/1.958 = 0.980$

802.11n (HT40): Duty cycle = $0.941/0.963 = 0.977$, Duty factor = $10 * \log(1/0.977) = 0.10$

802.11ac (VHT80): Duty cycle = $0.458/0.496 = 0.923$, Duty factor = $10 * \log(1/0.923) = 0.35$

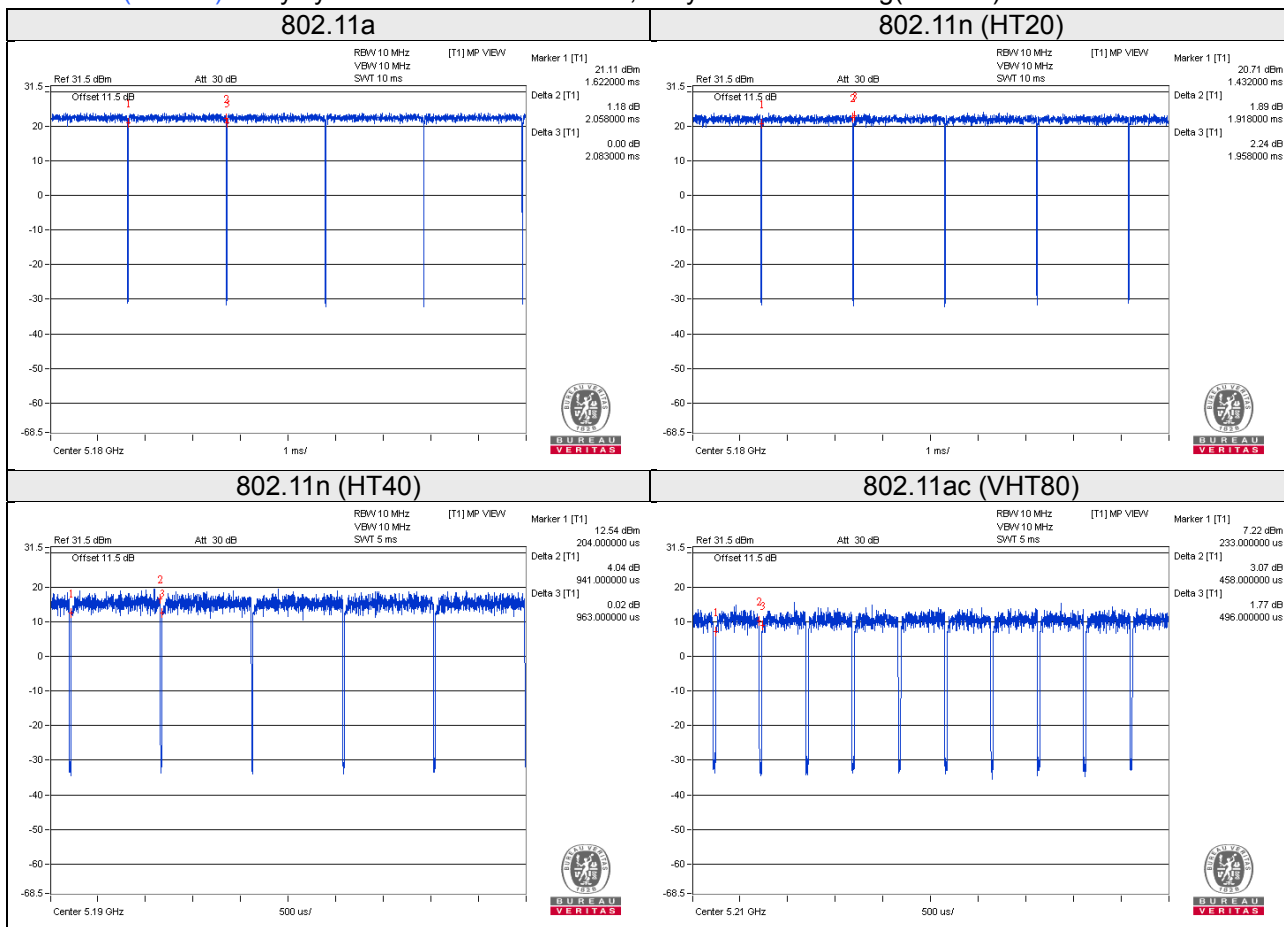

2TX

802.11a: Duty cycle = $2.062/2.082 = 0.990$

802.11n (HT20): Duty cycle = $1.918/1.958 = 0.980$

802.11n (HT40): Duty cycle = $0.942/0.970 = 0.971$, Duty factor = $10 * \log(1/0.971) = 0.13$

802.11ac (VHT80): Duty cycle = $0.460/0.491 = 0.937$, Duty factor = $10 * \log(1/0.937) = 0.28$

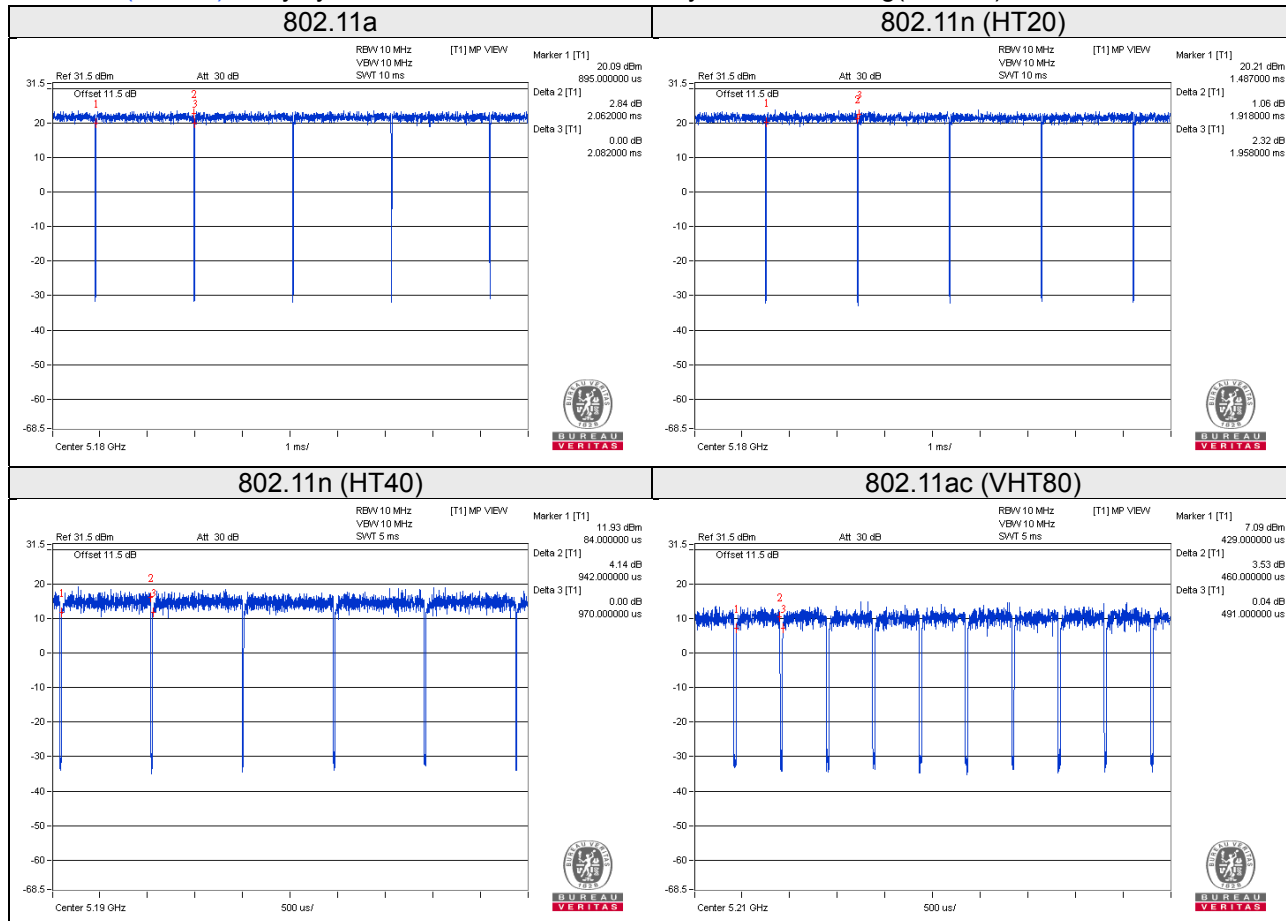

3.4 Description of Support Units

The EUT has been tested as an independent unit together with other necessary accessories or support units. The following support units or accessories were used to form a representative test configuration during the tests.

ID	Product	Brand	Model No.	Serial No.	FCC ID	Remarks
A.	Notebook	DELL	E5410	6RP2YM1	FCC DoC Approved	-
B.	Adapter	Channel Well Technology	2ABN036F US	N/A	N/A	Provided by client
C.	Load	N/A	N/A	N/A	N/A	-
D.	PoE	Microsemi	PD-9001GR/AT/AC	N/A	N/A	Provided by client

Note:

1. All power cords of the above support units are non-shielded (1.8m).
2. Item A acted as communication partner to transfer data.

ID	Descriptions	Qty.	Length (m)	Shielding (Yes/No)	Cores (Qty.)	Remarks
1.	RJ45 cable	1	10	N	0	-
2.	RJ45 cable	1	1.8	N	0	-
3.	DC cable	1	1.45	-	0	attached on adapter
4.	RJ45 cable	1	3	N	0	-

3.4.1 Configuration of System under Test

Test Mode A

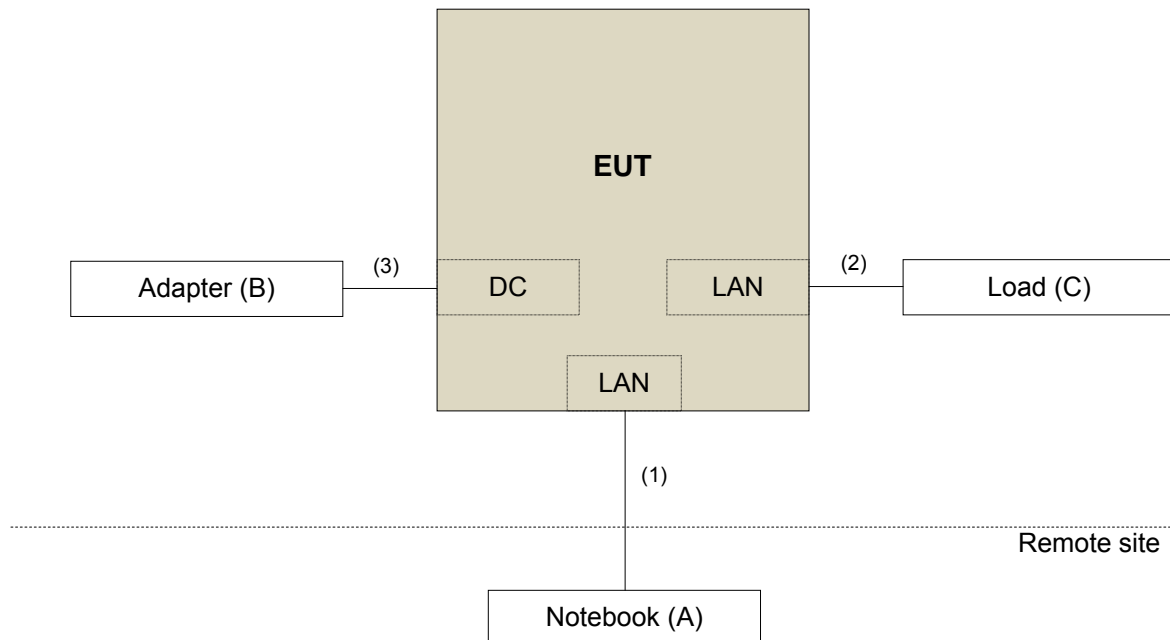

Test Mode B

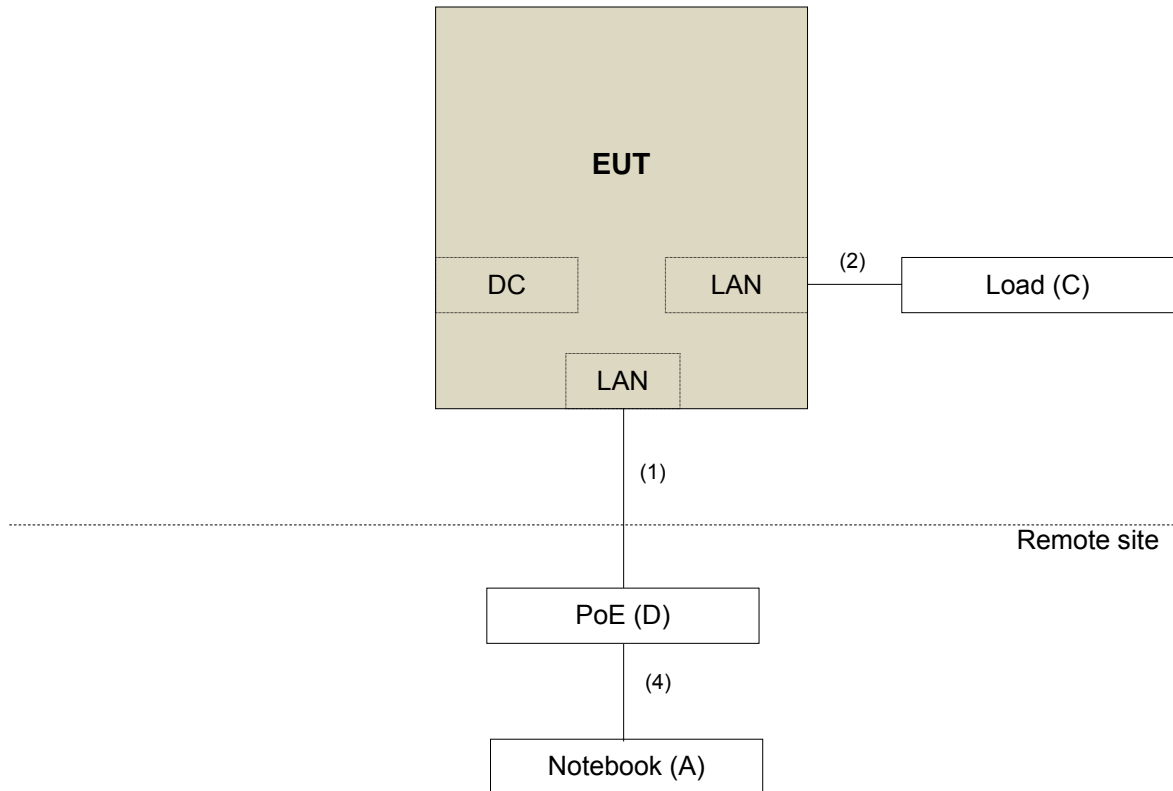

3.5 General Description of Applied Standards

The EUT is a RF Product. According to the specifications of the manufacturer, it must comply with the requirements of the following standards:

FCC Part 15, Subpart E (15.407)

KDB 789033 D02 General UNII Test Procedure New Rules v01r04

662911 D01 Multiple Transmitter Output v02r01

ANSI C63.10:2013

All test items have been performed and recorded as per the above standards.

Note: The EUT has been verified to comply with the requirements of FCC Part 15, Subpart B, Class B (DoC).
The test report has been issued separately.

4 Test Types and Results

4.1 Radiated Emission and Bandedge Measurement

4.1.1 Limits of Radiated Emission and Bandedge Measurement

Radiated emissions which fall in the restricted bands must comply with the radiated emission limits specified as below table.

Frequencies (MHz)	Field Strength (microvolts/meter)	Measurement Distance (meters)
0.009 ~ 0.490	2400/F(kHz)	300
0.490 ~ 1.705	24000/F(kHz)	30
1.705 ~ 30.0	30	30
30 ~ 88	100	3
88 ~ 216	150	3
216 ~ 960	200	3
Above 960	500	3

NOTE:

- The lower limit shall apply at the transition frequencies.
- Emission level (dBuV/m) = 20 log Emission level (uV/m).
- For frequencies above 1000MHz, the field strength limits are based on average detector, however, the peak field strength of any emission shall not exceed the maximum permitted average limits, specified above by more than 20dB under any condition of modulation.

Limits of unwanted emission out of the restricted bands

Applicable To		Limit	
789033 D02 General UNII Test Procedure New Rules v01r04		Field Strength at 3m	
		PK: 74 (dBµV/m)	AV: 54 (dBµV/m)
Frequency Band	Applicable To	EIRP Limit	Equivalent Field Strength at 3m
5150~5250 MHz	15.407(b)(1)	PK: -27 (dBm/MHz)	PK: 68.2(dBµV/m)
5250~5350 MHz	15.407(b)(2)		
5470~5725 MHz	15.407(b)(3)		
5725~5850 MHz	<input checked="" type="checkbox"/> 15.407(b)(4)(i)	PK: -27 (dBm/MHz) ^{*1} PK: 10 (dBm/MHz) ^{*2} PK: 15.6 (dBm/MHz) ^{*3} PK: 27 (dBm/MHz) ^{*4}	PK: 68.2(dBµV/m) ^{*1} PK: 105.2 (dBµV/m) ^{*2} PK: 110.8(dBµV/m) ^{*3} PK: 122.2 (dBµV/m) ^{*4}
	<input type="checkbox"/> 15.407(b)(4)(ii)	Emission limits in section 15.247(d)	
^{*1} beyond 75 MHz or more above of the band edge.		^{*2} below the band edge increasing linearly to 10 dBm/MHz at 25 MHz above.	
^{*3} below the band edge increasing linearly to a level of 15.6 dBm/MHz at 5 MHz above.		^{*4} from 5 MHz above or below the band edge increasing linearly to a level of 27 dBm/MHz at the band edge.	

Note: The following formula is used to convert the equipment isotropic radiated power (eirp) to field strength:

$$E = \frac{1000000 \sqrt{30 P}}{3} \mu\text{V/m, where P is the eirp (Watts).}$$

4.1.2 Test Instruments

Description & Manufacturer	Model No.	Serial No.	Cal. Date	Cal. Due
Test Receiver ROHDE & SCHWARZ	ESCI	100424	Oct. 24, 2016	Oct. 23, 2017
Spectrum Analyzer ROHDE & SCHWARZ	FSP40	100040	Aug. 16, 2016	Aug. 15, 2017
BILOG Antenna SCHWARZBECK	VULB9168	9168-155	Dec. 28, 2016	Dec. 27, 2017
HORN Antenna SCHWARZBECK	BBHA 9120D	9120D-1170	Dec. 15, 2016	Dec. 14, 2017
HORN Antenna SCHWARZBECK	BBHA 9170	BBHA9170241	Dec. 14, 2016	Dec. 13, 2017
Loop Antenna	EM-6879	269	Aug. 11, 2016	Aug. 10, 2017
Preamplifier Agilent	8449B	3008A01960	Aug. 09, 2016	Aug. 08, 2017
Preamplifier Agilent	8447D	2944A10631	Aug. 09, 2016	Aug. 08, 2017
RF signal cable HUBER+SUHNER	SUCOFLEX 104	MY 13380+295012/04	Aug. 09, 2016	Aug. 08, 2017
RF signal cable HUBER+SUHNER	SUCOFLEX 104	Cable-CH4-03 (250724)	Aug. 09, 2016	Aug. 08, 2017
Software BV ADT	ADT_Radiated_ V7.6.15.9.4	NA	NA	NA
Antenna Tower inn-co GmbH	MA 4000	010303	NA	NA
Antenna Tower Controller BV ADT	AT100	AT93021703	NA	NA
Turn Table BV ADT	TT100	TT93021703	NA	NA
Turn Table Controller BV ADT	SC100	SC93021703	NA	NA
26GHz ~ 40GHz Amplifier	EM26400	815221	Oct. 17, 2016	Oct. 16, 2017
High Speed Peak Power Meter	ML2495A	0824012	Aug. 11, 2016	Aug. 10, 2017
Power Sensor	MA2411B	0738171	Aug. 11, 2016	Aug. 10, 2017
WIT Standard Temperature And Humidity Chamber	TH-4S-C	W981030	Jun. 08, 2016	Jun. 07, 2017
			Jun. 07, 2017	Jun. 06, 2018

- Note: 1. The calibration interval of the above test instruments is 12 months and the calibrations are traceable to NML/ROC and NIST/USA.
 2. The test was performed in HwaYa Chamber 4.
 3. The horn antenna and preamplifier (model: 8449B) are used only for the measurement of emission frequency above 1GHz if tested.
 4. The FCC Site Registration No. is 460141.
 5. The IC Site Registration No. is IC7450F-4.

4.1.3 Test Procedures

For Radiated emission below 30MHz

- a. The EUT was placed on the top of a rotating table 0.8 meters above the ground at a 3 meter chamber room. The table was rotated 360 degrees to determine the position of the highest radiation.
- b. The EUT was set 3 meters away from the interference-receiving antenna, which was mounted on the top of a variable-height antenna tower.
- c. Both X and Y axes of the antenna are set to make the measurement.
- d. For each suspected emission, the EUT was arranged to its worst case and the rotatable table was turned from 0 degrees to 360 degrees to find the maximum reading.
- e. The test-receiver system was set to Quasi-Peak Detect Function and Specified Bandwidth with Maximum Hold Mode.

Note:

1. The resolution bandwidth and video bandwidth of test receiver/spectrum analyzer is 9kHz at frequency below 30MHz.

For Radiated emission above 30MHz

- a. The EUT was placed on the top of a rotating table 0.8 meters (for 30MHz ~ 1GHz) / 1.5 meters (for above 1GHz) above the ground at 3 meter chamber room for test. The table was rotated 360 degrees to determine the position of the highest radiation.
- b. The EUT was set 3 meters away from the interference-receiving antenna, which was mounted on the top of a variable-height antenna tower.
- c. The height of antenna is varied from one meter to four meters above the ground to determine the maximum value of the field strength. Both horizontal and vertical polarizations of the antenna are set to make the measurement.
- d. For each suspected emission, the EUT was arranged to its worst case and then the antenna was tuned to heights from 1 meter to 4 meters and the rotatable table was turned from 0 degrees to 360 degrees to find the maximum reading.
- e. The test-receiver system was set to quasi-peak detect function and specified bandwidth with maximum hold mode when the test frequency is below 1 GHz.
- f. The test-receiver system was set to peak and average detect function and specified bandwidth with maximum hold mode when the test frequency is above 1 GHz. If the peak reading value also meets average limit, measurement with the average detector is unnecessary.

Note:

1. The resolution bandwidth and video bandwidth of test receiver/spectrum analyzer is 120kHz for Quasi-peak detection (QP) at frequency below 1GHz.
2. The resolution bandwidth of test receiver/spectrum analyzer is 1 MHz and the video bandwidth is 3 MHz for Peak detection (PK) at frequency above 1GHz.
3. The resolution bandwidth of test receiver/spectrum analyzer is 1MHz and the video bandwidth is $\geq 1/T$ (Duty cycle < 98%) or 10Hz (Duty cycle $\geq 98\%$) for Average detection (AV) at frequency above 1GHz.
4. All modes of operation were investigated and the worst-case emissions are reported.

4.1.4 Deviation from Test Standard

No deviation.

4.1.5 Test Setup

For Radiated emission below 30MHz

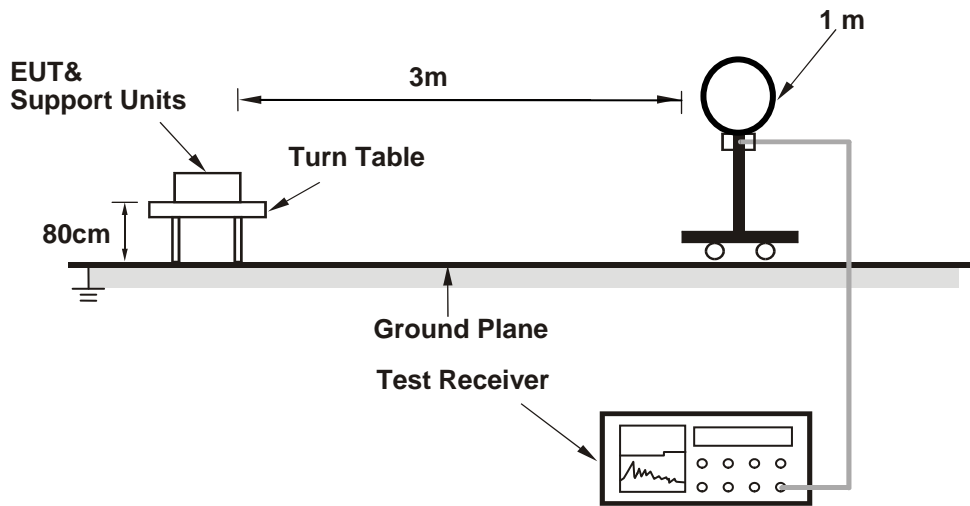

For Radiated emission 30MHz to 1GHz

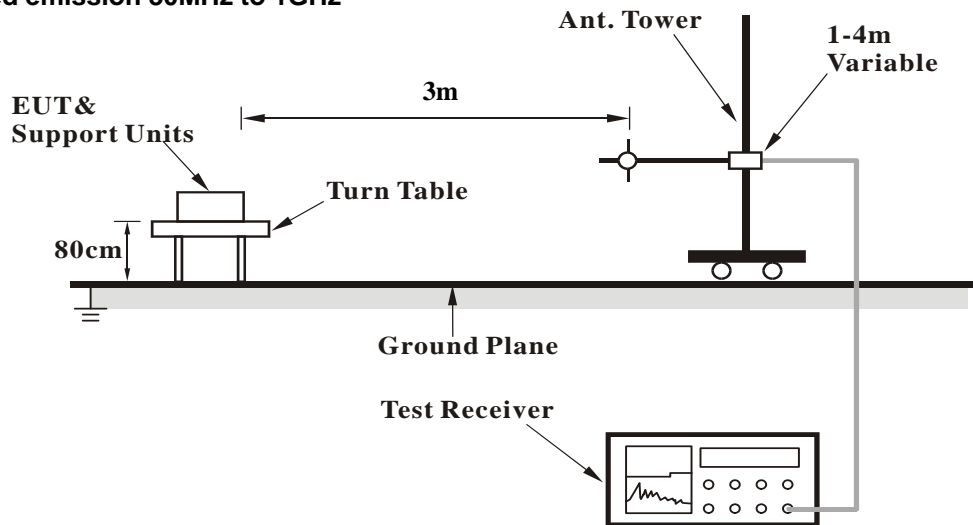

For Radiated emission above 1GHz

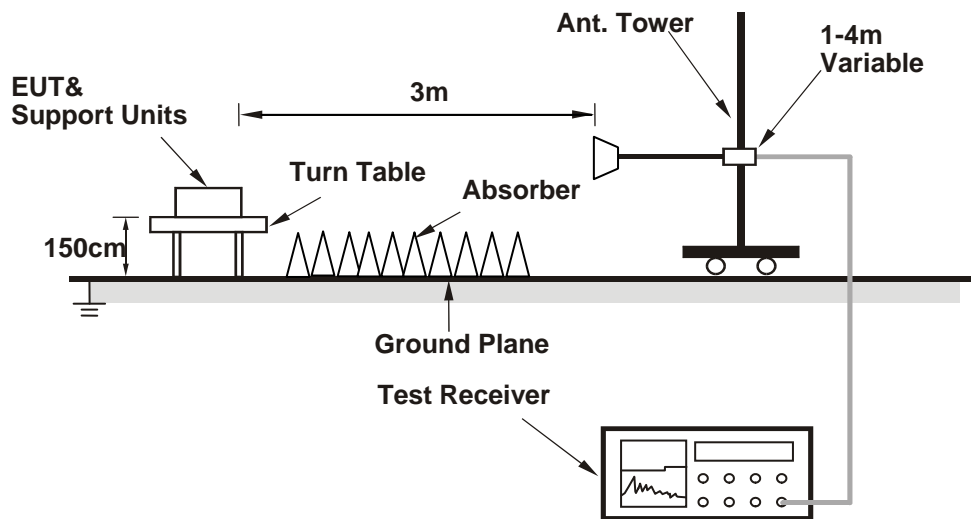

For the actual test configuration, please refer to the attached file (Test Setup Photo).

4.1.6 EUT Operating Conditions

- Placed the EUT on the testing table.
- Prepared a notebook to act as a communication partner and placed it outside of testing area.
- The communication partner connected with EUT via a RJ45 cable and ran a test program (provided by manufacturer) to enable EUT under transmission condition continuously at specific channel frequency.
- The communication partner sent data to EUT by command "PING".
- The necessary accessories enable the system in full functions.

4.1.7 Test Results

Above 1GHz data:

1TX

802.11a

CHANNEL	TX Channel 36	DETECTOR FUNCTION	Peak (PK)
FREQUENCY RANGE	1GHz ~ 40GHz		Average (AV)

ANTENNA POLARITY & TEST DISTANCE: HORIZONTAL AT 3 M								
NO.	FREQ. (MHz)	EMISSION LEVEL (dBuV/m)	LIMIT (dBuV/m)	MARGIN (dB)	ANTENNA HEIGHT (m)	TABLE ANGLE (Degree)	RAW VALUE (dBuV)	CORRECTION FACTOR (dB/m)
1	5080.00	62.5 PK	74.0	-11.5	1.59 H	222	60.50	2.00
2	5080.00	46.2 AV	54.0	-7.8	1.59 H	222	44.20	2.00
3	*5180.00	104.7 PK			1.66 H	205	65.80	38.90
4	*5180.00	95.5 AV			1.66 H	205	56.60	38.90
5	#10360.00	58.0 PK	74.0	-16.0	2.15 H	263	43.60	14.40
6	#10360.00	44.7 AV	54.0	-9.3	2.15 H	263	30.30	14.40
ANTENNA POLARITY & TEST DISTANCE: VERTICAL AT 3 M								
NO.	FREQ. (MHz)	EMISSION LEVEL (dBuV/m)	LIMIT (dBuV/m)	MARGIN (dB)	ANTENNA HEIGHT (m)	TABLE ANGLE (Degree)	RAW VALUE (dBuV)	CORRECTION FACTOR (dB/m)
1	5080.00	69.4 PK	74.0	-4.6	2.98 V	318	67.40	2.00
2	5080.00	53.3 AV	54.0	-0.7	2.98 V	318	51.30	2.00
3	*5180.00	113.1 PK			2.68 V	328	74.20	38.90
4	*5180.00	103.2 AV			2.68 V	328	64.30	38.90
5	#10360.00	59.1 PK	74.0	-14.9	1.78 V	352	44.70	14.40
6	#10360.00	46.9 AV	54.0	-7.1	1.78 V	352	32.50	14.40

Remarks:

1. Emission Level(dBuV/m) = Raw Value(dBuV) + Correction Factor(dB/m)
2. Correction Factor(dB/m) = Antenna Factor(dB/m) + Cable Factor(dB) – Pre-Amplifier Factor(dB)
3. The other emission levels were very low against the limit.
4. Margin value = Emission Level – Limit value
5. " * ": Fundamental frequency.
6. " # ": The radiated frequency is out of the restricted band.

CHANNEL	TX Channel 40	DETECTOR FUNCTION	Peak (PK)
FREQUENCY RANGE	1GHz ~ 40GHz		Average (AV)

ANTENNA POLARITY & TEST DISTANCE: HORIZONTAL AT 3 M								
NO.	FREQ. (MHz)	EMISSION LEVEL (dBuV/m)	LIMIT (dBuV/m)	MARGIN (dB)	ANTENNA HEIGHT (m)	TABLE ANGLE (Degree)	RAW VALUE (dBuV)	CORRECTION FACTOR (dB/m)
1	5080.00	58.8 PK	74.0	-15.2	2.24 H	145	56.80	2.00
2	5080.00	48.6 AV	54.0	-5.4	2.24 H	145	46.60	2.00
3	*5200.00	104.7 PK			2.18 H	162	65.70	39.00
4	*5200.00	94.6 AV			2.18 H	162	55.60	39.00
5	#10400.00	58.1 PK	74.0	-15.9	2.21 H	133	43.50	14.60
6	#10400.00	45.1 AV	54.0	-8.9	2.21 H	133	30.50	14.60
ANTENNA POLARITY & TEST DISTANCE: VERTICAL AT 3 M								
NO.	FREQ. (MHz)	EMISSION LEVEL (dBuV/m)	LIMIT (dBuV/m)	MARGIN (dB)	ANTENNA HEIGHT (m)	TABLE ANGLE (Degree)	RAW VALUE (dBuV)	CORRECTION FACTOR (dB/m)
1	5080.00	62.3 PK	74.0	-11.7	2.44 V	325	60.30	2.00
2	5080.00	52.0 AV	54.0	-2.0	2.44 V	325	50.00	2.00
3	*5200.00	112.8 PK			2.50 V	326	73.80	39.00
4	*5200.00	102.7 AV			2.50 V	326	63.70	39.00
5	#10400.00	59.5 PK	74.0	-14.5	1.85 V	95	44.90	14.60
6	#10400.00	47.2 AV	54.0	-6.8	1.85 V	95	32.60	14.60

Remarks:

1. Emission Level(dBuV/m) = Raw Value(dBuV) + Correction Factor(dB/m)
2. Correction Factor(dB/m) = Antenna Factor(dB/m) + Cable Factor(dB) – Pre-Amplifier Factor(dB)
3. The other emission levels were very low against the limit.
4. Margin value = Emission Level – Limit value
5. " * ": Fundamental frequency.
6. " # ": The radiated frequency is out of the restricted band.

CHANNEL	TX Channel 48	DETECTOR FUNCTION	Peak (PK)
FREQUENCY RANGE	1GHz ~ 40GHz		Average (AV)

ANTENNA POLARITY & TEST DISTANCE: HORIZONTAL AT 3 M

NO.	FREQ. (MHz)	EMISSION LEVEL (dBuV/m)	LIMIT (dBuV/m)	MARGIN (dB)	ANTENNA HEIGHT (m)	TABLE ANGLE (Degree)	RAW VALUE (dBuV)	CORRECTION FACTOR (dB/m)
1	*5240.00	106.7 PK			2.26 H	185	67.70	39.00
2	*5240.00	96.5 AV			2.26 H	185	57.50	39.00
3	5400.00	53.9 PK	74.0	-20.1	2.53 H	204	51.20	2.70
4	5400.00	45.0 AV	54.0	-9.0	2.53 H	204	42.30	2.70
5	#10480.00	57.8 PK	74.0	-16.2	2.46 H	33	43.60	14.20
6	#10480.00	44.6 AV	54.0	-9.4	2.46 H	33	30.40	14.20

ANTENNA POLARITY & TEST DISTANCE: VERTICAL AT 3 M

NO.	FREQ. (MHz)	EMISSION LEVEL (dBuV/m)	LIMIT (dBuV/m)	MARGIN (dB)	ANTENNA HEIGHT (m)	TABLE ANGLE (Degree)	RAW VALUE (dBuV)	CORRECTION FACTOR (dB/m)
1	*5240.00	112.4 PK			2.97 V	330	73.40	39.00
2	*5240.00	102.9 AV			2.97 V	330	63.90	39.00
3	5400.00	58.1 PK	74.0	-15.9	3.00 V	321	55.40	2.70
4	5400.00	47.6 AV	54.0	-6.4	3.00 V	321	44.90	2.70
5	#10480.00	58.8 PK	74.0	-15.2	2.33 V	169	44.60	14.20
6	#10480.00	46.5 AV	54.0	-7.5	2.33 V	169	32.30	14.20

Remarks:

1. Emission Level(dBuV/m) = Raw Value(dBuV) + Correction Factor(dB/m)
2. Correction Factor(dB/m) = Antenna Factor(dB/m) + Cable Factor(dB) – Pre-Amplifier Factor(dB)
3. The other emission levels were very low against the limit.
4. Margin value = Emission Level – Limit value
5. " * ": Fundamental frequency.
6. " # ": The radiated frequency is out of the restricted band.

CHANNEL	TX Channel 149	DETECTOR FUNCTION	Peak (PK)
FREQUENCY RANGE	1GHz ~ 40GHz		Average (AV)

ANTENNA POLARITY & TEST DISTANCE: HORIZONTAL AT 3 M

NO.	FREQ. (MHz)	EMISSION LEVEL (dBuV/m)	LIMIT (dBuV/m)	MARGIN (dB)	ANTENNA HEIGHT (m)	TABLE ANGLE (Degree)	RAW VALUE (dBuV)	CORRECTION FACTOR (dB/m)
1	#5640.80	55.1 PK	68.2	-13.1	2.46 H	315	52.20	2.90
2	*5745.00	109.4 PK			2.46 H	315	69.50	39.90
3	*5745.00	99.2 AV			2.46 H	315	59.30	39.90
4	#5945.60	56.0 PK	68.2	-12.2	2.46 H	315	52.80	3.20
5	11490.00	59.2 PK	74.0	-14.8	1.15 H	319	44.60	14.60
6	11490.00	48.0 AV	54.0	-6.0	1.15 H	319	33.40	14.60

ANTENNA POLARITY & TEST DISTANCE: VERTICAL AT 3 M

NO.	FREQ. (MHz)	EMISSION LEVEL (dBuV/m)	LIMIT (dBuV/m)	MARGIN (dB)	ANTENNA HEIGHT (m)	TABLE ANGLE (Degree)	RAW VALUE (dBuV)	CORRECTION FACTOR (dB/m)
1	#5647.20	56.4 PK	68.2	-11.8	1.24 V	262	53.50	2.90
2	*5745.00	111.6 PK			1.24 V	262	71.70	39.90
3	*5745.00	101.4 AV			1.24 V	262	61.50	39.90
4	#5949.60	57.5 PK	68.2	-10.7	1.24 V	262	54.20	3.30
5	11490.00	60.2 PK	74.0	-13.8	1.55 V	230	45.60	14.60
6	11490.00	50.4 AV	54.0	-3.6	1.55 V	230	35.80	14.60

Remarks:

1. Emission Level(dBuV/m) = Raw Value(dBuV) + Correction Factor(dB/m)
2. Correction Factor(dB/m) = Antenna Factor(dB/m) + Cable Factor(dB) – Pre-Amplifier Factor(dB)
3. The other emission levels were very low against the limit.
4. Margin value = Emission Level – Limit value
5. " * ": Fundamental frequency.
6. " # ": The radiated frequency is out of the restricted band.

CHANNEL	TX Channel 157	DETECTOR FUNCTION	Peak (PK)
FREQUENCY RANGE	1GHz ~ 40GHz		Average (AV)

ANTENNA POLARITY & TEST DISTANCE: HORIZONTAL AT 3 M

NO.	FREQ. (MHz)	EMISSION LEVEL (dBuV/m)	LIMIT (dBuV/m)	MARGIN (dB)	ANTENNA HEIGHT (m)	TABLE ANGLE (Degree)	RAW VALUE (dBuV)	CORRECTION FACTOR (dB/m)
1	#5606.40	55.7 PK	68.2	-12.5	2.43 H	314	52.80	2.90
2	*5785.00	109.8 PK			2.43 H	314	69.90	39.90
3	*5785.00	99.4 AV			2.43 H	314	59.50	39.90
4	#5956.00	56.3 PK	68.2	-11.9	2.43 H	314	53.00	3.30
5	11570.00	59.6 PK	74.0	-14.4	1.08 H	305	45.10	14.50
6	11570.00	48.6 AV	54.0	-5.4	1.08 H	305	34.10	14.50

ANTENNA POLARITY & TEST DISTANCE: VERTICAL AT 3 M

NO.	FREQ. (MHz)	EMISSION LEVEL (dBuV/m)	LIMIT (dBuV/m)	MARGIN (dB)	ANTENNA HEIGHT (m)	TABLE ANGLE (Degree)	RAW VALUE (dBuV)	CORRECTION FACTOR (dB/m)
1	#5648.80	56.0 PK	68.2	-12.2	1.32 V	260	53.10	2.90
2	*5785.00	111.8 PK			1.32 V	260	71.90	39.90
3	*5785.00	101.2 AV			1.32 V	260	61.30	39.90
4	#5982.40	56.2 PK	68.2	-12.0	1.32 V	260	52.90	3.30
5	11570.00	60.4 PK	74.0	-13.6	1.48 V	221	45.90	14.50
6	11570.00	50.5 AV	54.0	-3.5	1.48 V	221	36.00	14.50

Remarks:

1. Emission Level(dBuV/m) = Raw Value(dBuV) + Correction Factor(dB/m)
2. Correction Factor(dB/m) = Antenna Factor(dB/m) + Cable Factor(dB) – Pre-Amplifier Factor(dB)
3. The other emission levels were very low against the limit.
4. Margin value = Emission Level – Limit value
5. " * ": Fundamental frequency.
6. " # ": The radiated frequency is out of the restricted band.

CHANNEL	TX Channel 165	DETECTOR FUNCTION	Peak (PK)
FREQUENCY RANGE	1GHz ~ 40GHz		Average (AV)

ANTENNA POLARITY & TEST DISTANCE: HORIZONTAL AT 3 M								
NO.	FREQ. (MHz)	EMISSION LEVEL (dBuV/m)	LIMIT (dBuV/m)	MARGIN (dB)	ANTENNA HEIGHT (m)	TABLE ANGLE (Degree)	RAW VALUE (dBuV)	CORRECTION FACTOR (dB/m)
1	#5614.40	54.9 PK	68.2	-13.3	2.42 H	315	52.00	2.90
2	*5825.00	109.1 PK			2.42 H	315	69.10	40.00
3	*5825.00	98.7 AV			2.42 H	315	58.70	40.00
4	#5930.40	55.9 PK	68.2	-12.3	2.42 H	315	52.70	3.20
5	11650.00	60.1 PK	74.0	-13.9	1.21 H	324	45.40	14.70
6	11650.00	48.5 AV	54.0	-5.5	1.21 H	324	33.80	14.70
ANTENNA POLARITY & TEST DISTANCE: VERTICAL AT 3 M								
NO.	FREQ. (MHz)	EMISSION LEVEL (dBuV/m)	LIMIT (dBuV/m)	MARGIN (dB)	ANTENNA HEIGHT (m)	TABLE ANGLE (Degree)	RAW VALUE (dBuV)	CORRECTION FACTOR (dB/m)
1	#5620.00	55.7 PK	68.2	-12.5	1.36 V	261	52.80	2.90
2	*5825.00	112.1 PK			1.36 V	261	72.10	40.00
3	*5825.00	102.2 AV			1.36 V	261	62.20	40.00
4	#5942.40	56.7 PK	68.2	-11.5	1.36 V	261	53.50	3.20
5	11650.00	60.3 PK	74.0	-13.7	1.58 V	216	45.60	14.70
6	11650.00	50.5 AV	54.0	-3.5	1.58 V	216	35.80	14.70

Remarks:

1. Emission Level(dBuV/m) = Raw Value(dBuV) + Correction Factor(dB/m)
2. Correction Factor(dB/m) = Antenna Factor(dB/m) + Cable Factor(dB) – Pre-Amplifier Factor(dB)
3. The other emission levels were very low against the limit.
4. Margin value = Emission Level – Limit value
5. " * ": Fundamental frequency.
6. " # ": The radiated frequency is out of the restricted band.

802.11n (HT20)

CHANNEL	TX Channel 36	DETECTOR	Peak (PK)
FREQUENCY RANGE	1GHz ~ 40GHz	FUNCTION	Average (AV)

ANTENNA POLARITY & TEST DISTANCE: HORIZONTAL AT 3 M								
NO.	FREQ. (MHz)	EMISSION LEVEL (dBuV/m)	LIMIT (dBuV/m)	MARGIN (dB)	ANTENNA HEIGHT (m)	TABLE ANGLE (Degree)	RAW VALUE (dBuV)	CORRECTION FACTOR (dB/m)
1	5150.00	66.3 PK	74.0	-7.7	2.27 H	241	64.20	2.10
2	5150.00	48.4 AV	54.0	-5.6	2.27 H	241	46.30	2.10
3	*5180.00	104.2 PK			2.27 H	241	65.30	38.90
4	*5180.00	93.8 AV			2.27 H	241	54.90	38.90
5	#10360.00	57.8 PK	74.0	-16.2	1.26 H	332	43.40	14.40
6	#10360.00	45.1 AV	54.0	-8.9	1.26 H	332	30.70	14.40
ANTENNA POLARITY & TEST DISTANCE: VERTICAL AT 3 M								
NO.	FREQ. (MHz)	EMISSION LEVEL (dBuV/m)	LIMIT (dBuV/m)	MARGIN (dB)	ANTENNA HEIGHT (m)	TABLE ANGLE (Degree)	RAW VALUE (dBuV)	CORRECTION FACTOR (dB/m)
1	5150.00	73.0 PK	74.0	-1.0	3.19 V	318	70.90	2.10
2	5150.00	52.6 AV	54.0	-1.4	3.19 V	318	50.50	2.10
3	*5180.00	111.5 PK			3.19 V	318	72.60	38.90
4	*5180.00	101.2 AV			3.19 V	318	62.30	38.90
5	#10360.00	58.7 PK	74.0	-15.3	2.21 V	17	44.30	14.40
6	#10360.00	46.3 AV	54.0	-7.7	2.21 V	17	31.90	14.40

Remarks:

1. Emission Level(dBuV/m) = Raw Value(dBuV) + Correction Factor(dB/m)
2. Correction Factor(dB/m) = Antenna Factor(dB/m) + Cable Factor(dB) – Pre-Amplifier Factor(dB)
3. The other emission levels were very low against the limit.
4. Margin value = Emission Level – Limit value
5. " * ": Fundamental frequency.
6. " # ": The radiated frequency is out of the restricted band.

CHANNEL	TX Channel 40	DETECTOR FUNCTION	Peak (PK)
FREQUENCY RANGE	1GHz ~ 40GHz		Average (AV)

ANTENNA POLARITY & TEST DISTANCE: HORIZONTAL AT 3 M

NO.	FREQ. (MHz)	EMISSION LEVEL (dBuV/m)	LIMIT (dBuV/m)	MARGIN (dB)	ANTENNA HEIGHT (m)	TABLE ANGLE (Degree)	RAW VALUE (dBuV)	CORRECTION FACTOR (dB/m)
1	5080.00	56.5 PK	74.0	-17.5	2.25 H	249	54.50	2.00
2	5080.00	46.7 AV	54.0	-7.3	2.25 H	249	44.70	2.00
3	*5200.00	104.5 PK			2.30 H	256	65.50	39.00
4	*5200.00	94.4 AV			2.30 H	256	55.40	39.00
5	#10400.00	58.1 PK	74.0	-15.9	1.82 H	116	43.50	14.60
6	#10400.00	44.7 AV	54.0	-9.3	1.82 H	116	30.10	14.60

ANTENNA POLARITY & TEST DISTANCE: VERTICAL AT 3 M

NO.	FREQ. (MHz)	EMISSION LEVEL (dBuV/m)	LIMIT (dBuV/m)	MARGIN (dB)	ANTENNA HEIGHT (m)	TABLE ANGLE (Degree)	RAW VALUE (dBuV)	CORRECTION FACTOR (dB/m)
1	5080.00	60.8 PK	74.0	-13.2	3.04 V	313	58.80	2.00
2	5080.00	50.5 AV	54.0	-3.5	3.04 V	313	48.50	2.00
3	*5200.00	112.6 PK			3.04 V	321	73.60	39.00
4	*5200.00	102.6 AV			3.04 V	321	63.60	39.00
5	#10400.00	59.2 PK	74.0	-14.8	1.75 V	225	44.60	14.60
6	#10400.00	46.6 AV	54.0	-7.4	1.75 V	225	32.00	14.60

Remarks:

1. Emission Level(dBuV/m) = Raw Value(dBuV) + Correction Factor(dB/m)
2. Correction Factor(dB/m) = Antenna Factor(dB/m) + Cable Factor(dB) – Pre-Amplifier Factor(dB)
3. The other emission levels were very low against the limit.
4. Margin value = Emission Level – Limit value
5. " * ": Fundamental frequency.
6. " # ": The radiated frequency is out of the restricted band.

CHANNEL	TX Channel 48	DETECTOR FUNCTION	Peak (PK)
FREQUENCY RANGE	1GHz ~ 40GHz		Average (AV)

ANTENNA POLARITY & TEST DISTANCE: HORIZONTAL AT 3 M								
NO.	FREQ. (MHz)	EMISSION LEVEL (dBuV/m)	LIMIT (dBuV/m)	MARGIN (dB)	ANTENNA HEIGHT (m)	TABLE ANGLE (Degree)	RAW VALUE (dBuV)	CORRECTION FACTOR (dB/m)
1	*5240.00	104.3 PK			3.28 H	359	65.30	39.00
2	*5240.00	94.7 AV			3.28 H	359	55.70	39.00
3	5400.00	57.5 PK	74.0	-16.5	3.22 H	14	54.80	2.70
4	5400.00	46.3 AV	54.0	-7.7	3.22 H	14	43.60	2.70
5	#10480.00	57.9 PK	74.0	-16.1	2.24 H	18	43.70	14.20
6	#10480.00	44.7 AV	54.0	-9.3	2.24 H	18	30.50	14.20
ANTENNA POLARITY & TEST DISTANCE: VERTICAL AT 3 M								
NO.	FREQ. (MHz)	EMISSION LEVEL (dBuV/m)	LIMIT (dBuV/m)	MARGIN (dB)	ANTENNA HEIGHT (m)	TABLE ANGLE (Degree)	RAW VALUE (dBuV)	CORRECTION FACTOR (dB/m)
1	*5240.00	113.2 PK			2.90 V	327	74.20	39.00
2	*5240.00	102.9 AV			2.90 V	327	63.90	39.00
3	5400.00	60.1 PK	74.0	-13.9	2.98 V	338	57.40	2.70
4	5400.00	48.5 AV	54.0	-5.5	2.98 V	338	45.80	2.70
5	#10480.00	58.9 PK	74.0	-15.1	1.85 V	227	44.70	14.20
6	#10480.00	46.1 AV	54.0	-7.9	1.85 V	227	31.90	14.20

Remarks:

1. Emission Level(dBuV/m) = Raw Value(dBuV) + Correction Factor(dB/m)
2. Correction Factor(dB/m) = Antenna Factor(dB/m) + Cable Factor(dB) – Pre-Amplifier Factor(dB)
3. The other emission levels were very low against the limit.
4. Margin value = Emission Level – Limit value
5. " * ": Fundamental frequency.
6. " # ": The radiated frequency is out of the restricted band.

CHANNEL	TX Channel 149	DETECTOR FUNCTION	Peak (PK)
FREQUENCY RANGE	1GHz ~ 40GHz		Average (AV)

ANTENNA POLARITY & TEST DISTANCE: HORIZONTAL AT 3 M

NO.	FREQ. (MHz)	EMISSION LEVEL (dBuV/m)	LIMIT (dBuV/m)	MARGIN (dB)	ANTENNA HEIGHT (m)	TABLE ANGLE (Degree)	RAW VALUE (dBuV)	CORRECTION FACTOR (dB/m)
1	#5618.40	55.8 PK	68.2	-12.4	2.31 H	315	52.90	2.90
2	*5745.00	109.4 PK			2.31 H	315	69.50	39.90
3	*5745.00	98.8 AV			2.31 H	315	58.90	39.90
4	#5967.20	56.1 PK	68.2	-12.1	2.31 H	315	52.80	3.30
5	11490.00	60.2 PK	74.0	-13.8	1.16 H	319	45.60	14.60
6	11490.00	48.6 AV	54.0	-5.4	1.16 H	319	34.00	14.60

ANTENNA POLARITY & TEST DISTANCE: VERTICAL AT 3 M

NO.	FREQ. (MHz)	EMISSION LEVEL (dBuV/m)	LIMIT (dBuV/m)	MARGIN (dB)	ANTENNA HEIGHT (m)	TABLE ANGLE (Degree)	RAW VALUE (dBuV)	CORRECTION FACTOR (dB/m)
1	#5637.60	56.4 PK	68.2	-11.8	1.20 V	256	53.50	2.90
2	*5745.00	113.1 PK			1.20 V	256	73.20	39.90
3	*5745.00	101.6 AV			1.20 V	256	61.70	39.90
4	#5981.60	56.8 PK	68.2	-11.4	1.20 V	256	53.50	3.30
5	11490.00	60.8 PK	74.0	-13.2	1.60 V	224	46.20	14.60
6	11490.00	50.7 AV	54.0	-3.3	1.60 V	224	36.10	14.60

Remarks:

1. Emission Level(dBuV/m) = Raw Value(dBuV) + Correction Factor(dB/m)
2. Correction Factor(dB/m) = Antenna Factor(dB/m) + Cable Factor(dB) – Pre-Amplifier Factor(dB)
3. The other emission levels were very low against the limit.
4. Margin value = Emission Level – Limit value
5. " * ": Fundamental frequency.
6. " # ": The radiated frequency is out of the restricted band.

CHANNEL	TX Channel 157	DETECTOR FUNCTION	Peak (PK)
FREQUENCY RANGE	1GHz ~ 40GHz		Average (AV)

ANTENNA POLARITY & TEST DISTANCE: HORIZONTAL AT 3 M								
NO.	FREQ. (MHz)	EMISSION LEVEL (dBuV/m)	LIMIT (dBuV/m)	MARGIN (dB)	ANTENNA HEIGHT (m)	TABLE ANGLE (Degree)	RAW VALUE (dBuV)	CORRECTION FACTOR (dB/m)
1	#5610.40	55.8 PK	68.2	-12.4	2.44 H	315	52.90	2.90
2	*5785.00	109.3 PK			2.44 H	315	69.40	39.90
3	*5785.00	98.9 AV			2.44 H	315	59.00	39.90
4	#5980.00	56.4 PK	68.2	-11.8	2.44 H	315	53.10	3.30
5	11570.00	60.0 PK	74.0	-14.0	1.06 H	323	45.50	14.50
6	11570.00	49.1 AV	54.0	-4.9	1.06 H	323	34.60	14.50
ANTENNA POLARITY & TEST DISTANCE: VERTICAL AT 3 M								
NO.	FREQ. (MHz)	EMISSION LEVEL (dBuV/m)	LIMIT (dBuV/m)	MARGIN (dB)	ANTENNA HEIGHT (m)	TABLE ANGLE (Degree)	RAW VALUE (dBuV)	CORRECTION FACTOR (dB/m)
1	#5639.20	56.1 PK	68.2	-12.1	1.20 V	257	53.20	2.90
2	*5785.00	112.8 PK			1.20 V	257	72.90	39.90
3	*5785.00	101.7 AV			1.20 V	257	61.80	39.90
4	#5936.00	56.4 PK	68.2	-11.8	1.20 V	257	53.20	3.20
5	11570.00	60.8 PK	74.0	-13.2	1.68 V	234	46.30	14.50
6	11570.00	50.2 AV	54.0	-3.8	1.68 V	234	35.70	14.50

Remarks:

1. Emission Level(dBuV/m) = Raw Value(dBuV) + Correction Factor(dB/m)
2. Correction Factor(dB/m) = Antenna Factor(dB/m) + Cable Factor(dB) – Pre-Amplifier Factor(dB)
3. The other emission levels were very low against the limit.
4. Margin value = Emission Level – Limit value
5. " * ": Fundamental frequency.
6. " # ": The radiated frequency is out of the restricted band.

CHANNEL	TX Channel 165	DETECTOR FUNCTION	Peak (PK)
FREQUENCY RANGE	1GHz ~ 40GHz		Average (AV)

ANTENNA POLARITY & TEST DISTANCE: HORIZONTAL AT 3 M

NO.	FREQ. (MHz)	EMISSION LEVEL (dBuV/m)	LIMIT (dBuV/m)	MARGIN (dB)	ANTENNA HEIGHT (m)	TABLE ANGLE (Degree)	RAW VALUE (dBuV)	CORRECTION FACTOR (dB/m)
1	#5621.60	55.8 PK	68.2	-12.4	2.40 H	313	52.90	2.90
2	*5825.00	111.3 PK			2.40 H	313	71.30	40.00
3	*5825.00	100.2 AV			2.40 H	313	60.20	40.00
4	#5943.20	57.0 PK	68.2	-11.2	2.40 H	313	53.80	3.20
5	11650.00	60.4 PK	74.0	-13.6	1.00 H	316	45.70	14.70
6	11650.00	48.7 AV	54.0	-5.3	1.00 H	316	34.00	14.70

ANTENNA POLARITY & TEST DISTANCE: VERTICAL AT 3 M

NO.	FREQ. (MHz)	EMISSION LEVEL (dBuV/m)	LIMIT (dBuV/m)	MARGIN (dB)	ANTENNA HEIGHT (m)	TABLE ANGLE (Degree)	RAW VALUE (dBuV)	CORRECTION FACTOR (dB/m)
1	#5633.60	55.5 PK	68.2	-12.7	1.08 V	258	52.60	2.90
2	*5825.00	114.1 PK			1.08 V	258	74.10	40.00
3	*5825.00	103.1 AV			1.08 V	258	63.10	40.00
4	#5933.60	60.2 PK	68.2	-8.0	1.08 V	258	57.00	3.20
5	11650.00	61.0 PK	74.0	-13.0	1.53 V	212	46.30	14.70
6	11650.00	50.5 AV	54.0	-3.5	1.53 V	212	35.80	14.70

Remarks:

1. Emission Level(dBuV/m) = Raw Value(dBuV) + Correction Factor(dB/m)
2. Correction Factor(dB/m) = Antenna Factor(dB/m) + Cable Factor(dB) – Pre-Amplifier Factor(dB)
3. The other emission levels were very low against the limit.
4. Margin value = Emission Level – Limit value
5. " * ": Fundamental frequency.
6. " # ": The radiated frequency is out of the restricted band.

802.11n (HT40)

CHANNEL	TX Channel 38	DETECTOR	Peak (PK)
FREQUENCY RANGE	1GHz ~ 40GHz	FUNCTION	Average (AV)

ANTENNA POLARITY & TEST DISTANCE: HORIZONTAL AT 3 M								
NO.	FREQ. (MHz)	EMISSION LEVEL (dBuV/m)	LIMIT (dBuV/m)	MARGIN (dB)	ANTENNA HEIGHT (m)	TABLE ANGLE (Degree)	RAW VALUE (dBuV)	CORRECTION FACTOR (dB/m)
1	5150.00	60.8 PK	74.0	-13.2	1.80 H	207	58.70	2.10
2	5150.00	45.1 AV	54.0	-8.9	1.80 H	207	43.00	2.10
3	*5190.00	97.2 PK			1.80 H	207	58.20	39.00
4	*5190.00	87.2 AV			1.80 H	207	48.20	39.00
5	#10380.00	57.9 PK	74.0	-16.1	2.35 H	187	43.30	14.60
6	#10380.00	45.3 AV	54.0	-8.7	2.35 H	187	30.70	14.60
ANTENNA POLARITY & TEST DISTANCE: VERTICAL AT 3 M								
NO.	FREQ. (MHz)	EMISSION LEVEL (dBuV/m)	LIMIT (dBuV/m)	MARGIN (dB)	ANTENNA HEIGHT (m)	TABLE ANGLE (Degree)	RAW VALUE (dBuV)	CORRECTION FACTOR (dB/m)
1	5150.00	67.9 PK	74.0	-6.1	2.84 V	325	65.80	2.10
2	5150.00	53.2 AV	54.0	-0.8	2.84 V	325	51.10	2.10
3	*5190.00	104.7 PK			2.84 V	325	65.70	39.00
4	*5190.00	94.2 AV			2.84 V	325	55.20	39.00
5	#10380.00	58.9 PK	74.0	-15.1	1.99 V	265	44.30	14.60
6	#10380.00	46.5 AV	54.0	-7.5	1.99 V	265	31.90	14.60

Remarks:

1. Emission Level(dBuV/m) = Raw Value(dBuV) + Correction Factor(dB/m)
2. Correction Factor(dB/m) = Antenna Factor(dB/m) + Cable Factor(dB) – Pre-Amplifier Factor(dB)
3. The other emission levels were very low against the limit.
4. Margin value = Emission Level – Limit value
5. " * ": Fundamental frequency.
6. " # ": The radiated frequency is out of the restricted band.

CHANNEL	TX Channel 46	DETECTOR FUNCTION	Peak (PK)
FREQUENCY RANGE	1GHz ~ 40GHz		Average (AV)

ANTENNA POLARITY & TEST DISTANCE: HORIZONTAL AT 3 M								
NO.	FREQ. (MHz)	EMISSION LEVEL (dBuV/m)	LIMIT (dBuV/m)	MARGIN (dB)	ANTENNA HEIGHT (m)	TABLE ANGLE (Degree)	RAW VALUE (dBuV)	CORRECTION FACTOR (dB/m)
1	*5230.00	103.2 PK			1.95 H	211	64.20	39.00
2	*5230.00	93.8 AV			1.95 H	211	54.80	39.00
3	5350.00	57.8 PK	74.0	-16.2	1.95 H	211	55.20	2.60
4	5350.00	45.3 AV	54.0	-8.7	1.95 H	211	42.70	2.60
5	#10460.00	57.5 PK	74.0	-16.5	1.27 H	185	43.30	14.20
6	#10460.00	44.6 AV	54.0	-9.4	1.27 H	185	30.40	14.20
ANTENNA POLARITY & TEST DISTANCE: VERTICAL AT 3 M								
NO.	FREQ. (MHz)	EMISSION LEVEL (dBuV/m)	LIMIT (dBuV/m)	MARGIN (dB)	ANTENNA HEIGHT (m)	TABLE ANGLE (Degree)	RAW VALUE (dBuV)	CORRECTION FACTOR (dB/m)
1	*5230.00	110.3 PK			2.37 V	326	71.30	39.00
2	*5230.00	100.1 AV			2.37 V	326	61.10	39.00
3	5350.00	59.9 PK	74.0	-14.1	2.37 V	326	57.30	2.60
4	5350.00	47.9 AV	54.0	-6.1	2.37 V	326	45.30	2.60
5	#10460.00	58.8 PK	74.0	-15.2	2.28 V	325	44.60	14.20
6	#10460.00	46.1 AV	54.0	-7.9	2.28 V	325	31.90	14.20

Remarks:

1. Emission Level(dBuV/m) = Raw Value(dBuV) + Correction Factor(dB/m)
2. Correction Factor(dB/m) = Antenna Factor(dB/m) + Cable Factor(dB) – Pre-Amplifier Factor(dB)
3. The other emission levels were very low against the limit.
4. Margin value = Emission Level – Limit value
5. " * ": Fundamental frequency.
6. " # ": The radiated frequency is out of the restricted band.

CHANNEL	TX Channel 151	DETECTOR FUNCTION	Peak (PK)
FREQUENCY RANGE	1GHz ~ 40GHz		Average (AV)

ANTENNA POLARITY & TEST DISTANCE: HORIZONTAL AT 3 M								
NO.	FREQ. (MHz)	EMISSION LEVEL (dBuV/m)	LIMIT (dBuV/m)	MARGIN (dB)	ANTENNA HEIGHT (m)	TABLE ANGLE (Degree)	RAW VALUE (dBuV)	CORRECTION FACTOR (dB/m)
1	#5648.80	58.9 PK	68.2	-9.3	2.44 H	165	56.00	2.90
2	*5755.00	105.5 PK			2.44 H	165	65.60	39.90
3	*5755.00	94.8 AV			2.44 H	165	54.90	39.90
4	#5952.80	57.1 PK	68.2	-11.1	2.44 H	165	53.80	3.30
5	11510.00	58.3 PK	74.0	-15.7	2.69 H	67	43.80	14.50
6	11510.00	45.1 AV	54.0	-8.9	2.69 H	67	30.60	14.50
ANTENNA POLARITY & TEST DISTANCE: VERTICAL AT 3 M								
NO.	FREQ. (MHz)	EMISSION LEVEL (dBuV/m)	LIMIT (dBuV/m)	MARGIN (dB)	ANTENNA HEIGHT (m)	TABLE ANGLE (Degree)	RAW VALUE (dBuV)	CORRECTION FACTOR (dB/m)
1	#5648.00	61.2 PK	68.2	-7.0	2.78 V	335	58.30	2.90
2	*5755.00	110.8 PK			2.78 V	335	70.90	39.90
3	*5755.00	99.6 AV			2.78 V	335	59.70	39.90
4	#5931.20	56.7 PK	68.2	-11.5	2.78 V	335	53.50	3.20
5	11510.00	59.1 PK	74.0	-14.9	2.36 V	245	44.60	14.50
6	11510.00	46.4 AV	54.0	-7.6	2.36 V	245	31.90	14.50

Remarks:

1. Emission Level(dBuV/m) = Raw Value(dBuV) + Correction Factor(dB/m)
2. Correction Factor(dB/m) = Antenna Factor(dB/m) + Cable Factor(dB) – Pre-Amplifier Factor(dB)
3. The other emission levels were very low against the limit.
4. Margin value = Emission Level – Limit value
5. " * ": Fundamental frequency.
6. " # ": The radiated frequency is out of the restricted band.

CHANNEL	TX Channel 159	DETECTOR FUNCTION	Peak (PK)
FREQUENCY RANGE	1GHz ~ 40GHz		Average (AV)

ANTENNA POLARITY & TEST DISTANCE: HORIZONTAL AT 3 M								
NO.	FREQ. (MHz)	EMISSION LEVEL (dBuV/m)	LIMIT (dBuV/m)	MARGIN (dB)	ANTENNA HEIGHT (m)	TABLE ANGLE (Degree)	RAW VALUE (dBuV)	CORRECTION FACTOR (dB/m)
1	#5644.00	57.1 PK	68.2	-11.1	2.28 H	157	54.20	2.90
2	*5795.00	104.6 PK			2.28 H	157	64.70	39.90
3	*5795.00	94.1 AV			2.28 H	157	54.20	39.90
4	#5952.00	57.0 PK	68.2	-11.2	2.28 H	157	53.70	3.30
5	11590.00	58.2 PK	74.0	-15.8	1.89 H	242	43.80	14.40
6	11590.00	45.1 AV	54.0	-8.9	1.89 H	242	30.70	14.40
ANTENNA POLARITY & TEST DISTANCE: VERTICAL AT 3 M								
NO.	FREQ. (MHz)	EMISSION LEVEL (dBuV/m)	LIMIT (dBuV/m)	MARGIN (dB)	ANTENNA HEIGHT (m)	TABLE ANGLE (Degree)	RAW VALUE (dBuV)	CORRECTION FACTOR (dB/m)
1	#5630.40	56.9 PK	68.2	-11.3	2.66 V	213	54.00	2.90
2	*5795.00	109.0 PK			2.66 V	213	69.10	39.90
3	*5795.00	98.6 AV			2.66 V	213	58.70	39.90
4	#5928.00	59.0 PK	68.2	-9.2	2.66 V	213	55.80	3.20
5	11570.00	59.2 PK	74.0	-14.8	2.28 V	176	44.70	14.50
6	11570.00	46.8 AV	54.0	-7.2	2.28 V	176	32.30	14.50

Remarks:

1. Emission Level(dBuV/m) = Raw Value(dBuV) + Correction Factor(dB/m)
2. Correction Factor(dB/m) = Antenna Factor(dB/m) + Cable Factor(dB) – Pre-Amplifier Factor(dB)
3. The other emission levels were very low against the limit.
4. Margin value = Emission Level – Limit value
5. " * ": Fundamental frequency.
6. " # ": The radiated frequency is out of the restricted band.

802.11ac (VHT80)

CHANNEL	TX Channel 42	DETECTOR FUNCTION	Peak (PK)
FREQUENCY RANGE	1GHz ~ 40GHz		Average (AV)

ANTENNA POLARITY & TEST DISTANCE: HORIZONTAL AT 3 M								
NO.	FREQ. (MHz)	EMISSION LEVEL (dBuV/m)	LIMIT (dBuV/m)	MARGIN (dB)	ANTENNA HEIGHT (m)	TABLE ANGLE (Degree)	RAW VALUE (dBuV)	CORRECTION FACTOR (dB/m)
1	5150.00	59.1 PK	74.0	-14.9	1.99 H	221	57.00	2.10
2	5150.00	49.6 AV	54.0	-4.4	1.99 H	221	47.50	2.10
3	*5210.00	99.7 PK			1.99 H	221	60.70	39.00
4	*5210.00	89.4 AV			1.99 H	221	50.40	39.00
5	5350.00	55.8 PK	74.0	-18.2	1.99 H	221	53.20	2.60
6	5350.00	43.3 AV	54.0	-10.7	1.99 H	221	40.70	2.60
7	#10420.00	57.8 PK	74.0	-16.2	2.86 H	24	43.40	14.40
8	#10420.00	44.6 AV	54.0	-9.4	2.86 H	24	30.20	14.40

ANTENNA POLARITY & TEST DISTANCE: VERTICAL AT 3 M								
NO.	FREQ. (MHz)	EMISSION LEVEL (dBuV/m)	LIMIT (dBuV/m)	MARGIN (dB)	ANTENNA HEIGHT (m)	TABLE ANGLE (Degree)	RAW VALUE (dBuV)	CORRECTION FACTOR (dB/m)
1	5150.00	67.8 PK	74.0	-6.2	2.88 V	329	65.70	2.10
2	5150.00	53.0 AV	54.0	-1.0	2.88 V	329	50.90	2.10
3	*5210.00	102.3 PK			2.88 V	323	63.30	39.00
4	*5210.00	90.4 AV			2.88 V	323	51.40	39.00
5	5350.00	58.1 PK	74.0	-15.9	2.88 V	329	55.50	2.60
6	5350.00	43.8 AV	54.0	-10.2	2.88 V	329	41.20	2.60
7	#10420.00	58.8 PK	74.0	-15.2	2.56 V	225	44.40	14.40
8	#10420.00	46.6 AV	54.0	-7.4	2.56 V	225	32.20	14.40

Remarks:

1. Emission Level(dBuV/m) = Raw Value(dBuV) + Correction Factor(dB/m)
2. Correction Factor(dB/m) = Antenna Factor(dB/m) + Cable Factor(dB) – Pre-Amplifier Factor(dB)
3. The other emission levels were very low against the limit.
4. Margin value = Emission Level – Limit value
5. " * ": Fundamental frequency.
6. " # ": The radiated frequency is out of the restricted band.

CHANNEL	TX Channel 155	DETECTOR FUNCTION	Peak (PK)
FREQUENCY RANGE	1GHz ~ 40GHz		Average (AV)

ANTENNA POLARITY & TEST DISTANCE: HORIZONTAL AT 3 M								
NO.	FREQ. (MHz)	EMISSION LEVEL (dBuV/m)	LIMIT (dBuV/m)	MARGIN (dB)	ANTENNA HEIGHT (m)	TABLE ANGLE (Degree)	RAW VALUE (dBuV)	CORRECTION FACTOR (dB/m)
1	#5648.80	59.8 PK	68.2	-8.4	2.42 H	160	56.90	2.90
2	*5775.00	101.1 PK			2.42 H	160	61.20	39.90
3	*5775.00	89.6 AV			2.42 H	160	49.70	39.90
4	#5925.60	58.9 PK	68.2	-9.3	2.42 H	160	55.70	3.20
5	11550.00	58.0 PK	74.0	-16.0	1.34 H	78	43.50	14.50
6	11550.00	45.2 AV	54.0	-8.8	1.34 H	78	30.70	14.50

ANTENNA POLARITY & TEST DISTANCE: VERTICAL AT 3 M								
NO.	FREQ. (MHz)	EMISSION LEVEL (dBuV/m)	LIMIT (dBuV/m)	MARGIN (dB)	ANTENNA HEIGHT (m)	TABLE ANGLE (Degree)	RAW VALUE (dBuV)	CORRECTION FACTOR (dB/m)
1	#5646.40	67.4 PK	68.2	-0.8	2.60 V	223	64.50	2.90
2	*5775.00	104.6 PK			2.60 V	223	64.70	39.90
3	*5775.00	93.3 AV			2.60 V	223	53.40	39.90
4	#5925.60	66.2 PK	68.2	-2.0	2.60 V	223	63.00	3.20
5	11550.00	59.2 PK	74.0	-14.8	2.31 V	249	44.70	14.50
6	11550.00	47.0 AV	54.0	-7.0	2.31 V	249	32.50	14.50

Remarks:

1. Emission Level(dBuV/m) = Raw Value(dBuV) + Correction Factor(dB/m)
2. Correction Factor(dB/m) = Antenna Factor(dB/m) + Cable Factor(dB) – Pre-Amplifier Factor(dB)
3. The other emission levels were very low against the limit.
4. Margin value = Emission Level – Limit value
5. " * ": Fundamental frequency.
6. " # ": The radiated frequency is out of the restricted band.

2TX

802.11a

CHANNEL	TX Channel 36	DETECTOR FUNCTION	Peak (PK)
FREQUENCY RANGE	1GHz ~ 40GHz		Average (AV)

ANTENNA POLARITY & TEST DISTANCE: HORIZONTAL AT 3 M								
NO.	FREQ. (MHz)	EMISSION LEVEL (dBuV/m)	LIMIT (dBuV/m)	MARGIN (dB)	ANTENNA HEIGHT (m)	TABLE ANGLE (Degree)	RAW VALUE (dBuV)	CORRECTION FACTOR (dB/m)
1	5100.00	64.4 PK	74.0	-9.6	2.94 H	343	62.40	2.00
2	5100.00	50.4 AV	54.0	-3.6	2.94 H	343	48.40	2.00
3	*5180.00	108.4 PK			3.02 H	357	69.50	38.90
4	*5180.00	98.8 AV			3.02 H	357	59.90	38.90
5	#10360.00	59.6 PK	74.0	-14.4	1.40 H	248	45.20	14.40
6	#10360.00	46.0 AV	54.0	-8.0	1.40 H	248	31.60	14.40
ANTENNA POLARITY & TEST DISTANCE: VERTICAL AT 3 M								
NO.	FREQ. (MHz)	EMISSION LEVEL (dBuV/m)	LIMIT (dBuV/m)	MARGIN (dB)	ANTENNA HEIGHT (m)	TABLE ANGLE (Degree)	RAW VALUE (dBuV)	CORRECTION FACTOR (dB/m)
1	5100.00	67.4 PK	74.0	-6.6	3.21 V	135	65.40	2.00
2	5100.00	53.2 AV	54.0	-0.8	3.21 V	135	51.20	2.00
3	*5180.00	115.7 PK			3.27 V	135	76.80	38.90
4	*5180.00	105.9 AV			3.27 V	135	67.00	38.90
5	#10360.00	59.9 PK	74.0	-14.1	3.00 V	354	45.50	14.40
6	#10360.00	46.7 AV	54.0	-7.3	3.00 V	354	32.30	14.40

Remarks:

1. Emission Level(dBuV/m) = Raw Value(dBuV) + Correction Factor(dB/m)
2. Correction Factor(dB/m) = Antenna Factor(dB/m) + Cable Factor(dB) – Pre-Amplifier Factor(dB)
3. The other emission levels were very low against the limit.
4. Margin value = Emission Level – Limit value
5. " * ": Fundamental frequency.
6. " # ": The radiated frequency is out of the restricted band.

CHANNEL	TX Channel 40	DETECTOR FUNCTION	Peak (PK)
FREQUENCY RANGE	1GHz ~ 40GHz		Average (AV)

ANTENNA POLARITY & TEST DISTANCE: HORIZONTAL AT 3 M

NO.	FREQ. (MHz)	EMISSION LEVEL (dBuV/m)	LIMIT (dBuV/m)	MARGIN (dB)	ANTENNA HEIGHT (m)	TABLE ANGLE (Degree)	RAW VALUE (dBuV)	CORRECTION FACTOR (dB/m)
1	5120.00	60.7 PK	74.0	-13.3	2.94 H	3	58.70	2.00
2	5120.00	49.4 AV	54.0	-4.6	2.94 H	3	47.40	2.00
3	*5200.00	110.5 PK			2.97 H	351	71.50	39.00
4	*5200.00	101.1 AV			2.97 H	351	62.10	39.00
5	5360.00	59.7 PK	74.0	-14.3	3.16 H	128	57.10	2.60
6	5360.00	48.4 AV	54.0	-5.6	3.16 H	128	45.80	2.60
7	#10400.00	59.9 PK	74.0	-14.1	1.35 H	237	45.30	14.60
8	#10400.00	46.4 AV	54.0	-7.6	1.35 H	237	31.80	14.60

ANTENNA POLARITY & TEST DISTANCE: VERTICAL AT 3 M

NO.	FREQ. (MHz)	EMISSION LEVEL (dBuV/m)	LIMIT (dBuV/m)	MARGIN (dB)	ANTENNA HEIGHT (m)	TABLE ANGLE (Degree)	RAW VALUE (dBuV)	CORRECTION FACTOR (dB/m)
1	5120.00	65.0 PK	74.0	-9.0	3.30 V	132	63.00	2.00
2	5120.00	53.2 AV	54.0	-0.8	3.30 V	132	51.20	2.00
3	*5200.00	117.0 PK			3.26 V	135	78.00	39.00
4	*5200.00	107.0 AV			3.26 V	135	68.00	39.00
5	5360.00	61.6 PK	74.0	-12.4	3.30 V	134	59.00	2.60
6	5360.00	50.6 AV	54.0	-3.4	3.30 V	134	48.00	2.60
7	#10400.00	60.1 PK	74.0	-13.9	2.94 V	5	45.50	14.60
8	#10400.00	47.0 AV	54.0	-7.0	2.94 V	5	32.40	14.60

Remarks:

1. Emission Level(dBuV/m) = Raw Value(dBuV) + Correction Factor(dB/m)
2. Correction Factor(dB/m) = Antenna Factor(dB/m) + Cable Factor(dB) – Pre-Amplifier Factor(dB)
3. The other emission levels were very low against the limit.
4. Margin value = Emission Level – Limit value
5. " * ": Fundamental frequency.
6. " # ": The radiated frequency is out of the restricted band.

CHANNEL	TX Channel 48	DETECTOR FUNCTION	Peak (PK)
FREQUENCY RANGE	1GHz ~ 40GHz		Average (AV)

ANTENNA POLARITY & TEST DISTANCE: HORIZONTAL AT 3 M

NO.	FREQ. (MHz)	EMISSION LEVEL (dBuV/m)	LIMIT (dBuV/m)	MARGIN (dB)	ANTENNA HEIGHT (m)	TABLE ANGLE (Degree)	RAW VALUE (dBuV)	CORRECTION FACTOR (dB/m)
1	5080.00	56.6 PK	74.0	-17.4	3.05 H	347	54.60	2.00
2	5080.00	44.0 AV	54.0	-10.0	3.05 H	347	42.00	2.00
3	*5240.00	108.4 PK			3.00 H	356	69.40	39.00
4	*5240.00	98.5 AV			3.00 H	356	59.50	39.00
5	5400.00	59.3 PK	74.0	-14.7	3.05 H	342	56.60	2.70
6	5400.00	46.4 AV	54.0	-7.6	3.05 H	342	43.70	2.70
7	#10480.00	59.5 PK	74.0	-14.5	1.43 H	243	45.30	14.20
8	#10480.00	46.5 AV	54.0	-7.5	1.43 H	243	32.30	14.20

ANTENNA POLARITY & TEST DISTANCE: VERTICAL AT 3 M

NO.	FREQ. (MHz)	EMISSION LEVEL (dBuV/m)	LIMIT (dBuV/m)	MARGIN (dB)	ANTENNA HEIGHT (m)	TABLE ANGLE (Degree)	RAW VALUE (dBuV)	CORRECTION FACTOR (dB/m)
1	5080.00	58.5 PK	74.0	-15.5	3.56 V	317	56.50	2.00
2	5080.00	49.2 AV	54.0	-4.8	3.56 V	317	47.20	2.00
3	*5240.00	116.9 PK			3.81 V	163	77.90	39.00
4	*5240.00	105.8 AV			3.81 V	163	66.80	39.00
5	5400.00	63.2 PK	74.0	-10.8	3.08 V	324	60.50	2.70
6	5400.00	51.6 AV	54.0	-2.4	3.08 V	324	48.90	2.70
7	#10480.00	59.8 PK	74.0	-14.2	3.01 V	3	45.60	14.20
8	#10480.00	47.0 AV	54.0	-7.0	3.01 V	3	32.80	14.20

Remarks:

1. Emission Level(dBuV/m) = Raw Value(dBuV) + Correction Factor(dB/m)
2. Correction Factor(dB/m) = Antenna Factor(dB/m) + Cable Factor(dB) – Pre-Amplifier Factor(dB)
3. The other emission levels were very low against the limit.
4. Margin value = Emission Level – Limit value
5. " * ": Fundamental frequency.
6. " # ": The radiated frequency is out of the restricted band.

CHANNEL	TX Channel 149	DETECTOR FUNCTION	Peak (PK)
FREQUENCY RANGE	1GHz ~ 40GHz		Average (AV)

ANTENNA POLARITY & TEST DISTANCE: HORIZONTAL AT 3 M

NO.	FREQ. (MHz)	EMISSION LEVEL (dBuV/m)	LIMIT (dBuV/m)	MARGIN (dB)	ANTENNA HEIGHT (m)	TABLE ANGLE (Degree)	RAW VALUE (dBuV)	CORRECTION FACTOR (dB/m)
1	#5638.40	59.8 PK	68.2	-8.4	2.51 H	168	52.80	7.00
2	*5745.00	112.5 PK			2.51 H	168	70.90	41.60
3	*5745.00	102.7 AV			2.51 H	168	61.10	41.60
4	#5943.20	60.6 PK	68.2	-7.6	2.51 H	168	52.80	7.80
5	11490.00	62.8 PK	74.0	-11.2	3.11 H	188	42.50	20.30
6	11490.00	50.2 AV	54.0	-3.8	3.11 H	188	29.90	20.30

ANTENNA POLARITY & TEST DISTANCE: VERTICAL AT 3 M

NO.	FREQ. (MHz)	EMISSION LEVEL (dBuV/m)	LIMIT (dBuV/m)	MARGIN (dB)	ANTENNA HEIGHT (m)	TABLE ANGLE (Degree)	RAW VALUE (dBuV)	CORRECTION FACTOR (dB/m)
1	#5622.40	60.2 PK	68.2	-8.0	3.10 V	314	53.30	6.90
2	*5745.00	119.0 PK			3.10 V	314	77.40	41.60
3	*5745.00	109.3 AV			3.10 V	314	67.70	41.60
4	#5995.20	60.6 PK	68.2	-7.6	3.10 V	314	52.70	7.90
5	11490.00	63.3 PK	74.0	-10.7	1.27 V	295	43.00	20.30
6	11490.00	50.9 AV	54.0	-3.1	1.27 V	295	30.60	20.30

Remarks:

1. Emission Level(dBuV/m) = Raw Value(dBuV) + Correction Factor(dB/m)
2. Correction Factor(dB/m) = Antenna Factor(dB/m) + Cable Factor(dB) – Pre-Amplifier Factor(dB)
3. The other emission levels were very low against the limit.
4. Margin value = Emission Level – Limit value
5. " * ": Fundamental frequency.
6. " # ": The radiated frequency is out of the restricted band.

CHANNEL	TX Channel 157	DETECTOR FUNCTION	Peak (PK)
FREQUENCY RANGE	1GHz ~ 40GHz		Average (AV)

ANTENNA POLARITY & TEST DISTANCE: HORIZONTAL AT 3 M								
NO.	FREQ. (MHz)	EMISSION LEVEL (dBuV/m)	LIMIT (dBuV/m)	MARGIN (dB)	ANTENNA HEIGHT (m)	TABLE ANGLE (Degree)	RAW VALUE (dBuV)	CORRECTION FACTOR (dB/m)
1	#5632.00	60.6 PK	68.2	-7.6	3.31 H	327	53.60	7.00
2	*5785.00	112.0 PK			2.76 H	338	70.40	41.60
3	*5785.00	102.3 AV			2.76 H	338	60.70	41.60
4	#5942.40	61.9 PK	68.2	-6.3	3.31 H	327	54.10	7.80
5	11570.00	62.9 PK	74.0	-11.1	1.89 H	166	42.80	20.10
6	11570.00	50.0 AV	54.0	-4.0	1.89 H	166	29.90	20.10
ANTENNA POLARITY & TEST DISTANCE: VERTICAL AT 3 M								
NO.	FREQ. (MHz)	EMISSION LEVEL (dBuV/m)	LIMIT (dBuV/m)	MARGIN (dB)	ANTENNA HEIGHT (m)	TABLE ANGLE (Degree)	RAW VALUE (dBuV)	CORRECTION FACTOR (dB/m)
1	#5627.20	64.7 PK	68.2	-3.5	3.31 V	327	57.70	7.00
2	*5785.00	118.8 PK			3.31 V	327	77.20	41.60
3	*5785.00	109.0 AV			3.31 V	327	67.40	41.60
4	#5943.20	63.1 PK	68.2	-5.1	3.31 V	327	55.30	7.80
5	11570.00	63.2 PK	74.0	-10.8	2.24 V	126	43.10	20.10
6	11570.00	50.4 AV	54.0	-3.6	2.24 V	126	30.30	20.10

Remarks:

1. Emission Level(dBuV/m) = Raw Value(dBuV) + Correction Factor(dB/m)
2. Correction Factor(dB/m) = Antenna Factor(dB/m) + Cable Factor(dB) – Pre-Amplifier Factor(dB)
3. The other emission levels were very low against the limit.
4. Margin value = Emission Level – Limit value
5. " * ": Fundamental frequency.
6. " # ": The radiated frequency is out of the restricted band.

CHANNEL	TX Channel 165	DETECTOR FUNCTION	Peak (PK)
FREQUENCY RANGE	1GHz ~ 40GHz		Average (AV)

ANTENNA POLARITY & TEST DISTANCE: HORIZONTAL AT 3 M								
NO.	FREQ. (MHz)	EMISSION LEVEL (dBuV/m)	LIMIT (dBuV/m)	MARGIN (dB)	ANTENNA HEIGHT (m)	TABLE ANGLE (Degree)	RAW VALUE (dBuV)	CORRECTION FACTOR (dB/m)
1	#5605.60	59.9 PK	68.2	-8.3	1.91 H	335	53.00	6.90
2	*5825.00	111.8 PK			1.91 H	335	70.00	41.80
3	*5825.00	101.7 AV			1.91 H	335	59.90	41.80
4	#5959.20	61.4 PK	68.2	-6.8	1.91 H	335	53.50	7.90
5	11650.00	59.9 PK	74.0	-14.1	2.34 H	155	40.10	19.80
6	11650.00	49.5 AV	54.0	-4.5	2.34 H	155	29.70	19.80
ANTENNA POLARITY & TEST DISTANCE: VERTICAL AT 3 M								
NO.	FREQ. (MHz)	EMISSION LEVEL (dBuV/m)	LIMIT (dBuV/m)	MARGIN (dB)	ANTENNA HEIGHT (m)	TABLE ANGLE (Degree)	RAW VALUE (dBuV)	CORRECTION FACTOR (dB/m)
1	#5612.80	60.3 PK	68.2	-7.9	2.83 V	144	53.40	6.90
2	*5825.00	117.7 PK			2.83 V	144	75.90	41.80
3	*5825.00	108.3 AV			2.83 V	144	66.50	41.80
4	#5983.20	63.3 PK	68.2	-4.9	2.83 V	144	55.40	7.90
5	11650.00	60.5 PK	74.0	-13.5	2.01 V	154	40.70	19.80
6	11650.00	50.1 AV	54.0	-3.9	2.01 V	154	30.30	19.80

Remarks:

1. Emission Level(dBuV/m) = Raw Value(dBuV) + Correction Factor(dB/m)
2. Correction Factor(dB/m) = Antenna Factor(dB/m) + Cable Factor(dB) – Pre-Amplifier Factor(dB)
3. The other emission levels were very low against the limit.
4. Margin value = Emission Level – Limit value
5. " * ": Fundamental frequency.
6. " # ": The radiated frequency is out of the restricted band.

802.11n (HT20)

CHANNEL	TX Channel 36	DETECTOR	Peak (PK)
FREQUENCY RANGE	1GHz ~ 40GHz	FUNCTION	Average (AV)

ANTENNA POLARITY & TEST DISTANCE: HORIZONTAL AT 3 M								
NO.	FREQ. (MHz)	EMISSION LEVEL (dBuV/m)	LIMIT (dBuV/m)	MARGIN (dB)	ANTENNA HEIGHT (m)	TABLE ANGLE (Degree)	RAW VALUE (dBuV)	CORRECTION FACTOR (dB/m)
1	5100.00	59.8 PK	74.0	-14.2	2.97 H	356	57.80	2.00
2	5100.00	49.6 AV	54.0	-4.4	2.97 H	356	47.60	2.00
3	*5180.00	110.5 PK			2.85 H	332	71.60	38.90
4	*5180.00	98.9 AV			2.85 H	332	60.00	38.90
5	#10360.00	59.6 PK	74.0	-14.4	1.36 H	239	45.20	14.40
6	#10360.00	46.2 AV	54.0	-7.8	1.36 H	239	31.80	14.40
ANTENNA POLARITY & TEST DISTANCE: VERTICAL AT 3 M								
NO.	FREQ. (MHz)	EMISSION LEVEL (dBuV/m)	LIMIT (dBuV/m)	MARGIN (dB)	ANTENNA HEIGHT (m)	TABLE ANGLE (Degree)	RAW VALUE (dBuV)	CORRECTION FACTOR (dB/m)
1	5100.00	64.0 PK	74.0	-10.0	3.01 V	143	62.00	2.00
2	5100.00	53.0 AV	54.0	-1.0	3.01 V	143	51.00	2.00
3	*5180.00	117.0 PK			3.10 V	135	78.10	38.90
4	*5180.00	105.7 AV			3.10 V	135	66.80	38.90
5	#10360.00	60.2 PK	74.0	-13.8	2.78 V	342	45.80	14.40
6	#10360.00	46.7 AV	54.0	-7.3	2.78 V	342	32.30	14.40

Remarks:

1. Emission Level(dBuV/m) = Raw Value(dBuV) + Correction Factor(dB/m)
2. Correction Factor(dB/m) = Antenna Factor(dB/m) + Cable Factor(dB) – Pre-Amplifier Factor(dB)
3. The other emission levels were very low against the limit.
4. Margin value = Emission Level – Limit value
5. " * ": Fundamental frequency.
6. " # ": The radiated frequency is out of the restricted band.

CHANNEL	TX Channel 40	DETECTOR FUNCTION	Peak (PK)
FREQUENCY RANGE	1GHz ~ 40GHz		Average (AV)

ANTENNA POLARITY & TEST DISTANCE: HORIZONTAL AT 3 M

NO.	FREQ. (MHz)	EMISSION LEVEL (dBuV/m)	LIMIT (dBuV/m)	MARGIN (dB)	ANTENNA HEIGHT (m)	TABLE ANGLE (Degree)	RAW VALUE (dBuV)	CORRECTION FACTOR (dB/m)
1	5120.00	59.8 PK	74.0	-14.2	3.23 H	345	57.80	2.00
2	5120.00	48.9 AV	54.0	-5.1	3.23 H	345	46.90	2.00
3	*5200.00	110.9 PK			2.83 H	338	71.90	39.00
4	*5200.00	100.4 AV			2.83 H	338	61.40	39.00
5	5360.00	59.3 PK	74.0	-14.7	3.05 H	1	56.70	2.60
6	5360.00	48.1 AV	54.0	-5.9	3.05 H	1	45.50	2.60
7	#10400.00	59.8 PK	74.0	-14.2	1.19 H	253	45.20	14.60
8	#10400.00	46.4 AV	54.0	-7.6	1.19 H	253	31.80	14.60

ANTENNA POLARITY & TEST DISTANCE: VERTICAL AT 3 M

NO.	FREQ. (MHz)	EMISSION LEVEL (dBuV/m)	LIMIT (dBuV/m)	MARGIN (dB)	ANTENNA HEIGHT (m)	TABLE ANGLE (Degree)	RAW VALUE (dBuV)	CORRECTION FACTOR (dB/m)
1	5120.00	64.0 PK	74.0	-10.0	3.08 V	145	62.00	2.00
2	5120.00	53.0 AV	54.0	-1.0	3.08 V	145	51.00	2.00
3	*5200.00	117.5 PK			3.16 V	131	78.50	39.00
4	*5200.00	106.5 AV			3.16 V	131	67.50	39.00
5	5360.00	61.8 PK	74.0	-12.2	2.85 V	156	59.20	2.60
6	5360.00	50.2 AV	54.0	-3.8	2.85 V	156	47.60	2.60
7	#10400.00	59.9 PK	74.0	-14.1	3.11 V	8	45.30	14.60
8	#10400.00	46.8 AV	54.0	-7.2	3.11 V	8	32.20	14.60

Remarks:

1. Emission Level(dBuV/m) = Raw Value(dBuV) + Correction Factor(dB/m)
2. Correction Factor(dB/m) = Antenna Factor(dB/m) + Cable Factor(dB) – Pre-Amplifier Factor(dB)
3. The other emission levels were very low against the limit.
4. Margin value = Emission Level – Limit value
5. " * ": Fundamental frequency.
6. " # ": The radiated frequency is out of the restricted band.

CHANNEL	TX Channel 48	DETECTOR FUNCTION	Peak (PK)
FREQUENCY RANGE	1GHz ~ 40GHz		Average (AV)

ANTENNA POLARITY & TEST DISTANCE: HORIZONTAL AT 3 M								
NO.	FREQ. (MHz)	EMISSION LEVEL (dBuV/m)	LIMIT (dBuV/m)	MARGIN (dB)	ANTENNA HEIGHT (m)	TABLE ANGLE (Degree)	RAW VALUE (dBuV)	CORRECTION FACTOR (dB/m)
1	5080.00	56.3 PK	74.0	-17.7	2.83 H	2	54.30	2.00
2	5080.00	45.0 AV	54.0	-9.0	2.83 H	2	43.00	2.00
3	*5240.00	110.5 PK			3.00 H	356	71.50	39.00
4	*5240.00	99.8 AV			3.00 H	356	60.80	39.00
5	5400.00	59.6 PK	74.0	-14.4	3.12 H	338	56.90	2.70
6	5400.00	46.2 AV	54.0	-7.8	3.12 H	338	43.50	2.70
7	#10480.00	59.5 PK	74.0	-14.5	1.38 H	235	45.30	14.20
8	#10480.00	46.2 AV	54.0	-7.8	1.38 H	235	32.00	14.20

ANTENNA POLARITY & TEST DISTANCE: VERTICAL AT 3 M								
NO.	FREQ. (MHz)	EMISSION LEVEL (dBuV/m)	LIMIT (dBuV/m)	MARGIN (dB)	ANTENNA HEIGHT (m)	TABLE ANGLE (Degree)	RAW VALUE (dBuV)	CORRECTION FACTOR (dB/m)
1	5080.00	58.9 PK	74.0	-15.1	3.16 V	284	56.90	2.00
2	5080.00	47.3 AV	54.0	-6.7	3.16 V	284	45.30	2.00
3	*5240.00	116.2 PK			3.54 V	172	77.20	39.00
4	*5240.00	106.0 AV			3.54 V	172	67.00	39.00
5	5400.00	61.6 PK	74.0	-12.4	3.08 V	325	58.90	2.70
6	5400.00	50.7 AV	54.0	-3.3	3.08 V	325	48.00	2.70
7	#10480.00	60.2 PK	74.0	-13.8	2.94 V	343	46.00	14.20
8	#10480.00	46.8 AV	54.0	-7.2	2.94 V	343	32.60	14.20

Remarks:

1. Emission Level(dBuV/m) = Raw Value(dBuV) + Correction Factor(dB/m)
2. Correction Factor(dB/m) = Antenna Factor(dB/m) + Cable Factor(dB) – Pre-Amplifier Factor(dB)
3. The other emission levels were very low against the limit.
4. Margin value = Emission Level – Limit value
5. " * ": Fundamental frequency.
6. " # ": The radiated frequency is out of the restricted band.

CHANNEL	TX Channel 149	DETECTOR FUNCTION	Peak (PK)
FREQUENCY RANGE	1GHz ~ 40GHz		Average (AV)

ANTENNA POLARITY & TEST DISTANCE: HORIZONTAL AT 3 M

NO.	FREQ. (MHz)	EMISSION LEVEL (dBuV/m)	LIMIT (dBuV/m)	MARGIN (dB)	ANTENNA HEIGHT (m)	TABLE ANGLE (Degree)	RAW VALUE (dBuV)	CORRECTION FACTOR (dB/m)
1	#5620.00	60.2 PK	68.2	-8.0	2.36 H	336	53.30	6.90
2	*5745.00	112.1 PK			2.36 H	336	70.50	41.60
3	*5745.00	101.5 AV			2.36 H	336	59.90	41.60
4	#5946.40	60.5 PK	68.2	-7.7	2.36 H	336	52.70	7.80
5	11490.00	61.8 PK	74.0	-12.2	2.17 H	153	41.50	20.30
6	11490.00	49.7 AV	54.0	-4.3	2.17 H	153	29.40	20.30

ANTENNA POLARITY & TEST DISTANCE: VERTICAL AT 3 M

NO.	FREQ. (MHz)	EMISSION LEVEL (dBuV/m)	LIMIT (dBuV/m)	MARGIN (dB)	ANTENNA HEIGHT (m)	TABLE ANGLE (Degree)	RAW VALUE (dBuV)	CORRECTION FACTOR (dB/m)
1	#5608.80	60.3 PK	68.2	-7.9	3.11 V	146	53.40	6.90
2	*5745.00	118.4 PK			3.11 V	146	76.80	41.60
3	*5745.00	108.4 AV			3.11 V	146	66.80	41.60
4	#5987.20	61.8 PK	68.2	-6.4	3.11 V	146	53.90	7.90
5	11490.00	62.4 PK	74.0	-11.6	1.82 V	341	42.10	20.30
6	11490.00	50.0 AV	54.0	-4.0	1.82 V	341	29.70	20.30

Remarks:

1. Emission Level(dBuV/m) = Raw Value(dBuV) + Correction Factor(dB/m)
2. Correction Factor(dB/m) = Antenna Factor(dB/m) + Cable Factor(dB) – Pre-Amplifier Factor(dB)
3. The other emission levels were very low against the limit.
4. Margin value = Emission Level – Limit value
5. " * ": Fundamental frequency.
6. " # ": The radiated frequency is out of the restricted band.

CHANNEL	TX Channel 157	DETECTOR FUNCTION	Peak (PK)
FREQUENCY RANGE	1GHz ~ 40GHz		Average (AV)

ANTENNA POLARITY & TEST DISTANCE: HORIZONTAL AT 3 M

NO.	FREQ. (MHz)	EMISSION LEVEL (dBuV/m)	LIMIT (dBuV/m)	MARGIN (dB)	ANTENNA HEIGHT (m)	TABLE ANGLE (Degree)	RAW VALUE (dBuV)	CORRECTION FACTOR (dB/m)
1	#5609.60	59.8 PK	68.2	-8.4	2.39 H	351	52.90	6.90
2	*5785.00	111.7 PK			2.39 H	351	70.10	41.60
3	*5785.00	101.6 AV			2.39 H	351	60.00	41.60
4	#5940.00	60.4 PK	68.2	-7.8	2.39 H	351	52.60	7.80
5	11570.00	62.2 PK	74.0	-11.8	2.94 H	152	42.10	20.10
6	11570.00	50.0 AV	54.0	-4.0	2.94 H	152	29.90	20.10

ANTENNA POLARITY & TEST DISTANCE: VERTICAL AT 3 M

NO.	FREQ. (MHz)	EMISSION LEVEL (dBuV/m)	LIMIT (dBuV/m)	MARGIN (dB)	ANTENNA HEIGHT (m)	TABLE ANGLE (Degree)	RAW VALUE (dBuV)	CORRECTION FACTOR (dB/m)
1	#5626.40	63.8 PK	68.2	-4.4	3.50 V	328	56.80	7.00
2	*5785.00	118.1 PK			3.50 V	328	76.50	41.60
3	*5785.00	108.7 AV			3.50 V	328	67.10	41.60
4	#5941.60	63.2 PK	68.2	-5.0	3.50 V	328	55.40	7.80
5	11570.00	62.6 PK	74.0	-11.4	2.49 V	157	42.50	20.10
6	11570.00	50.5 AV	54.0	-3.5	2.49 V	157	30.40	20.10

Remarks:

1. Emission Level(dBuV/m) = Raw Value(dBuV) + Correction Factor(dB/m)
2. Correction Factor(dB/m) = Antenna Factor(dB/m) + Cable Factor(dB) – Pre-Amplifier Factor(dB)
3. The other emission levels were very low against the limit.
4. Margin value = Emission Level – Limit value
5. " * ": Fundamental frequency.
6. " # ": The radiated frequency is out of the restricted band.

CHANNEL	TX Channel 165	DETECTOR FUNCTION	Peak (PK)
FREQUENCY RANGE	1GHz ~ 40GHz		Average (AV)

ANTENNA POLARITY & TEST DISTANCE: HORIZONTAL AT 3 M

NO.	FREQ. (MHz)	EMISSION LEVEL (dBuV/m)	LIMIT (dBuV/m)	MARGIN (dB)	ANTENNA HEIGHT (m)	TABLE ANGLE (Degree)	RAW VALUE (dBuV)	CORRECTION FACTOR (dB/m)
1	#5615.20	58.2 PK	68.2	-10.0	2.52 H	337	51.30	6.90
2	*5825.00	110.9 PK			2.52 H	337	69.10	41.80
3	*5825.00	100.5 AV			2.52 H	337	58.70	41.80
4	#5984.80	59.2 PK	68.2	-9.0	2.52 H	337	51.30	7.90
5	11650.00	61.6 PK	74.0	-12.4	1.44 H	236	41.80	19.80
6	11650.00	49.5 AV	54.0	-4.5	1.44 H	236	29.70	19.80

ANTENNA POLARITY & TEST DISTANCE: VERTICAL AT 3 M

NO.	FREQ. (MHz)	EMISSION LEVEL (dBuV/m)	LIMIT (dBuV/m)	MARGIN (dB)	ANTENNA HEIGHT (m)	TABLE ANGLE (Degree)	RAW VALUE (dBuV)	CORRECTION FACTOR (dB/m)
1	#5626.40	59.9 PK	68.2	-8.3	3.53 V	324	52.90	7.00
2	*5825.00	118.0 PK			3.53 V	324	76.20	41.80
3	*5825.00	108.1 AV			3.53 V	324	66.30	41.80
4	#5988.00	63.5 PK	68.2	-4.7	3.53 V	324	55.60	7.90
5	11650.00	61.9 PK	74.0	-12.1	1.45 V	278	42.10	19.80
6	11650.00	50.2 AV	54.0	-3.8	1.45 V	278	30.40	19.80

Remarks:

1. Emission Level(dBuV/m) = Raw Value(dBuV) + Correction Factor(dB/m)
2. Correction Factor(dB/m) = Antenna Factor(dB/m) + Cable Factor(dB) – Pre-Amplifier Factor(dB)
3. The other emission levels were very low against the limit.
4. Margin value = Emission Level – Limit value
5. " * ": Fundamental frequency.
6. " # ": The radiated frequency is out of the restricted band.

802.11n (HT40)

CHANNEL	TX Channel 38	DETECTOR	Peak (PK)
FREQUENCY RANGE	1GHz ~ 40GHz	FUNCTION	Average (AV)

ANTENNA POLARITY & TEST DISTANCE: HORIZONTAL AT 3 M								
NO.	FREQ. (MHz)	EMISSION LEVEL (dBuV/m)	LIMIT (dBuV/m)	MARGIN (dB)	ANTENNA HEIGHT (m)	TABLE ANGLE (Degree)	RAW VALUE (dBuV)	CORRECTION FACTOR (dB/m)
1	5150.00	68.7 PK	74.0	-5.3	3.02 H	355	66.60	2.10
2	5150.00	49.3 AV	54.0	-4.7	3.02 H	355	47.20	2.10
3	*5190.00	94.8 PK			2.96 H	342	55.80	39.00
4	*5190.00	93.3 AV			2.96 H	342	54.30	39.00
5	#10380.00	59.8 PK	74.0	-14.2	1.29 H	243	45.20	14.60
6	#10380.00	46.0 AV	54.0	-8.0	1.29 H	243	31.40	14.60
ANTENNA POLARITY & TEST DISTANCE: VERTICAL AT 3 M								
NO.	FREQ. (MHz)	EMISSION LEVEL (dBuV/m)	LIMIT (dBuV/m)	MARGIN (dB)	ANTENNA HEIGHT (m)	TABLE ANGLE (Degree)	RAW VALUE (dBuV)	CORRECTION FACTOR (dB/m)
1	5150.00	73.3 PK	74.0	-0.7	2.98 V	144	71.20	2.10
2	5150.00	51.7 AV	54.0	-2.3	2.98 V	144	49.60	2.10
3	*5190.00	110.0 PK			3.24 V	152	71.00	39.00
4	*5190.00	99.1 AV			3.24 V	152	60.10	39.00
5	#10380.00	60.2 PK	74.0	-13.8	1.32 V	255	45.60	14.60
6	#10380.00	46.4 AV	54.0	-7.6	1.32 V	255	31.80	14.60

Remarks:

1. Emission Level(dBuV/m) = Raw Value(dBuV) + Correction Factor(dB/m)
2. Correction Factor(dB/m) = Antenna Factor(dB/m) + Cable Factor(dB) – Pre-Amplifier Factor(dB)
3. The other emission levels were very low against the limit.
4. Margin value = Emission Level – Limit value
5. " * ": Fundamental frequency.
6. " # ": The radiated frequency is out of the restricted band.

CHANNEL	TX Channel 46	DETECTOR FUNCTION	Peak (PK)
FREQUENCY RANGE	1GHz ~ 40GHz		Average (AV)

ANTENNA POLARITY & TEST DISTANCE: HORIZONTAL AT 3 M

NO.	FREQ. (MHz)	EMISSION LEVEL (dBuV/m)	LIMIT (dBuV/m)	MARGIN (dB)	ANTENNA HEIGHT (m)	TABLE ANGLE (Degree)	RAW VALUE (dBuV)	CORRECTION FACTOR (dB/m)
1	5150.00	62.1 PK	74.0	-11.9	2.81 H	347	60.00	2.10
2	5150.00	47.9 AV	54.0	-6.1	2.81 H	347	45.80	2.10
3	*5230.00	107.3 PK			3.08 H	354	68.30	39.00
4	*5230.00	97.5 AV			3.08 H	354	58.50	39.00
5	5390.00	57.1 PK	74.0	-16.9	2.94 H	338	54.50	2.60
6	5390.00	47.1 AV	54.0	-6.9	2.94 H	338	44.50	2.60
7	#10460.00	59.5 PK	74.0	-14.5	1.32 H	256	45.30	14.20
8	#10460.00	45.9 AV	54.0	-8.1	1.32 H	256	31.70	14.20

ANTENNA POLARITY & TEST DISTANCE: VERTICAL AT 3 M

NO.	FREQ. (MHz)	EMISSION LEVEL (dBuV/m)	LIMIT (dBuV/m)	MARGIN (dB)	ANTENNA HEIGHT (m)	TABLE ANGLE (Degree)	RAW VALUE (dBuV)	CORRECTION FACTOR (dB/m)
1	5150.00	67.0 PK	74.0	-7.0	2.99 V	141	64.90	2.10
2	5150.00	53.5 AV	54.0	-0.5	2.99 V	141	51.40	2.10
3	*5230.00	115.0 PK			3.12 V	126	76.00	39.00
4	*5230.00	103.7 AV			3.12 V	126	64.70	39.00
5	5390.00	59.5 PK	74.0	-14.5	3.06 V	132	56.90	2.60
6	5390.00	48.8 AV	54.0	-5.2	3.06 V	132	46.20	2.60
7	#10460.00	60.0 PK	74.0	-14.0	1.25 V	248	45.80	14.20
8	#10460.00	46.6 AV	54.0	-7.4	1.25 V	248	32.40	14.20

Remarks:

1. Emission Level(dBuV/m) = Raw Value(dBuV) + Correction Factor(dB/m)
2. Correction Factor(dB/m) = Antenna Factor(dB/m) + Cable Factor(dB) – Pre-Amplifier Factor(dB)
3. The other emission levels were very low against the limit.
4. Margin value = Emission Level – Limit value
5. " * ": Fundamental frequency.
6. " # ": The radiated frequency is out of the restricted band.

CHANNEL	TX Channel 151	DETECTOR FUNCTION	Peak (PK)
FREQUENCY RANGE	1GHz ~ 40GHz		Average (AV)

ANTENNA POLARITY & TEST DISTANCE: HORIZONTAL AT 3 M

NO.	FREQ. (MHz)	EMISSION LEVEL (dBuV/m)	LIMIT (dBuV/m)	MARGIN (dB)	ANTENNA HEIGHT (m)	TABLE ANGLE (Degree)	RAW VALUE (dBuV)	CORRECTION FACTOR (dB/m)
1	#5621.60	60.0 PK	68.2	-8.2	2.28 H	337	53.10	6.90
2	*5755.00	108.2 PK			2.28 H	337	66.60	41.60
3	*5755.00	98.2 AV			2.28 H	337	56.60	41.60
4	#5979.20	60.4 PK	68.2	-7.8	2.28 H	337	52.50	7.90
5	11510.00	61.7 PK	74.0	-12.3	1.99 H	201	41.50	20.20
6	11510.00	49.6 AV	54.0	-4.4	1.99 H	201	29.40	20.20

ANTENNA POLARITY & TEST DISTANCE: VERTICAL AT 3 M

NO.	FREQ. (MHz)	EMISSION LEVEL (dBuV/m)	LIMIT (dBuV/m)	MARGIN (dB)	ANTENNA HEIGHT (m)	TABLE ANGLE (Degree)	RAW VALUE (dBuV)	CORRECTION FACTOR (dB/m)
1	#5604.00	61.5 PK	68.2	-6.7	2.99 V	145	54.60	6.90
2	*5755.00	114.2 PK			2.99 V	145	72.60	41.60
3	*5755.00	104.1 AV			2.99 V	145	62.50	41.60
4	#5928.00	61.8 PK	68.2	-6.4	2.99 V	145	54.00	7.80
5	11510.00	62.4 PK	74.0	-11.6	1.69 V	283	42.20	20.20
6	11510.00	50.3 AV	54.0	-3.7	1.69 V	283	30.10	20.20

Remarks:

1. Emission Level(dBuV/m) = Raw Value(dBuV) + Correction Factor(dB/m)
2. Correction Factor(dB/m) = Antenna Factor(dB/m) + Cable Factor(dB) – Pre-Amplifier Factor(dB)
3. The other emission levels were very low against the limit.
4. Margin value = Emission Level – Limit value
5. " * ": Fundamental frequency.
6. " # ": The radiated frequency is out of the restricted band.

CHANNEL	TX Channel 159	DETECTOR FUNCTION	Peak (PK)
FREQUENCY RANGE	1GHz ~ 40GHz		Average (AV)

ANTENNA POLARITY & TEST DISTANCE: HORIZONTAL AT 3 M								
NO.	FREQ. (MHz)	EMISSION LEVEL (dBuV/m)	LIMIT (dBuV/m)	MARGIN (dB)	ANTENNA HEIGHT (m)	TABLE ANGLE (Degree)	RAW VALUE (dBuV)	CORRECTION FACTOR (dB/m)
1	#5637.60	60.2 PK	68.2	-8.0	3.19 H	184	53.20	7.00
2	*5795.00	106.9 PK			3.19 H	184	65.20	41.70
3	*5795.00	96.6 AV			3.19 H	184	54.90	41.70
4	#5940.80	61.5 PK	68.2	-6.7	3.19 H	184	53.70	7.80
5	11590.00	61.8 PK	74.0	-12.2	2.38 H	154	41.70	20.10
6	11590.00	49.9 AV	54.0	-4.1	2.38 H	154	29.80	20.10
ANTENNA POLARITY & TEST DISTANCE: VERTICAL AT 3 M								
NO.	FREQ. (MHz)	EMISSION LEVEL (dBuV/m)	LIMIT (dBuV/m)	MARGIN (dB)	ANTENNA HEIGHT (m)	TABLE ANGLE (Degree)	RAW VALUE (dBuV)	CORRECTION FACTOR (dB/m)
1	#5640.80	61.3 PK	68.2	-6.9	3.16 V	326	54.20	7.10
2	*5795.00	113.8 PK			3.16 V	326	72.10	41.70
3	*5795.00	104.2 AV			3.16 V	326	62.50	41.70
4	#5967.20	61.4 PK	68.2	-6.8	3.16 V	326	53.50	7.90
5	11590.00	62.6 PK	74.0	-11.4	1.88 V	275	42.50	20.10
6	11590.00	50.2 AV	54.0	-3.8	1.88 V	275	30.10	20.10

Remarks:

1. Emission Level(dBuV/m) = Raw Value(dBuV) + Correction Factor(dB/m)
2. Correction Factor(dB/m) = Antenna Factor(dB/m) + Cable Factor(dB) – Pre-Amplifier Factor(dB)
3. The other emission levels were very low against the limit.
4. Margin value = Emission Level – Limit value
5. " * ": Fundamental frequency.
6. " # ": The radiated frequency is out of the restricted band.

802.11ac (VHT80)

CHANNEL	TX Channel 42	DETECTOR FUNCTION	Peak (PK)
FREQUENCY RANGE	1GHz ~ 40GHz		Average (AV)

ANTENNA POLARITY & TEST DISTANCE: HORIZONTAL AT 3 M								
NO.	FREQ. (MHz)	EMISSION LEVEL (dBuV/m)	LIMIT (dBuV/m)	MARGIN (dB)	ANTENNA HEIGHT (m)	TABLE ANGLE (Degree)	RAW VALUE (dBuV)	CORRECTION FACTOR (dB/m)
1	5150.00	61.1 PK	74.0	-12.9	1.71 H	203	55.00	6.10
2	5150.00	46.6 AV	54.0	-7.4	1.71 H	203	40.50	6.10
3	*5210.00	97.2 PK			1.64 H	11	56.90	40.30
4	*5210.00	86.8 AV			1.64 H	11	46.50	40.30
5	5350.00	57.8 PK	74.0	-16.2	2.60 H	204	51.30	6.50
6	5350.00	45.1 AV	54.0	-8.9	2.60 H	204	38.60	6.50
7	#10420.00	61.0 PK	74.0	-13.0	1.84 H	199	42.90	18.10
8	#10420.00	48.2 AV	54.0	-5.8	1.84 H	199	30.10	18.10

ANTENNA POLARITY & TEST DISTANCE: VERTICAL AT 3 M								
NO.	FREQ. (MHz)	EMISSION LEVEL (dBuV/m)	LIMIT (dBuV/m)	MARGIN (dB)	ANTENNA HEIGHT (m)	TABLE ANGLE (Degree)	RAW VALUE (dBuV)	CORRECTION FACTOR (dB/m)
1	5150.00	69.7 PK	74.0	-4.3	3.81 V	338	63.60	6.10
2	5150.00	53.2 AV	54.0	-0.8	3.81 V	338	47.10	6.10
3	*5210.00	104.6 PK			4.00 V	129	64.30	40.30
4	*5210.00	94.2 AV			4.00 V	129	53.90	40.30
5	5350.00	58.4 PK	74.0	-15.6	1.38 V	326	51.90	6.50
6	5350.00	46.0 AV	54.0	-8.0	1.38 V	326	39.50	6.50
7	#10420.00	61.3 PK	74.0	-12.7	1.67 V	214	43.20	18.10
8	#10420.00	48.5 AV	54.0	-5.5	1.67 V	214	30.40	18.10

Remarks:

1. Emission Level(dBuV/m) = Raw Value(dBuV) + Correction Factor(dB/m)
2. Correction Factor(dB/m) = Antenna Factor(dB/m) + Cable Factor(dB) – Pre-Amplifier Factor(dB)
3. The other emission levels were very low against the limit.
4. Margin value = Emission Level – Limit value
5. " * ": Fundamental frequency.
6. " # ": The radiated frequency is out of the restricted band.

CHANNEL	TX Channel 155	DETECTOR FUNCTION	Peak (PK)
FREQUENCY RANGE	1GHz ~ 40GHz		Average (AV)

ANTENNA POLARITY & TEST DISTANCE: HORIZONTAL AT 3 M								
NO.	FREQ. (MHz)	EMISSION LEVEL (dBuV/m)	LIMIT (dBuV/m)	MARGIN (dB)	ANTENNA HEIGHT (m)	TABLE ANGLE (Degree)	RAW VALUE (dBuV)	CORRECTION FACTOR (dB/m)
1	#5646.40	61.9 PK	68.2	-6.3	2.51 H	334	54.80	7.10
2	*5775.00	104.0 PK			2.51 H	334	62.40	41.60
3	*5775.00	94.6 AV			2.51 H	334	53.00	41.60
4	#5924.80	61.1 PK	68.3	-7.2	2.51 H	334	53.30	7.80
5	11550.00	61.9 PK	74.0	-12.1	2.28 H	311	41.70	20.20
6	11550.00	50.3 AV	54.0	-3.7	2.28 H	311	30.10	20.20

ANTENNA POLARITY & TEST DISTANCE: VERTICAL AT 3 M								
NO.	FREQ. (MHz)	EMISSION LEVEL (dBuV/m)	LIMIT (dBuV/m)	MARGIN (dB)	ANTENNA HEIGHT (m)	TABLE ANGLE (Degree)	RAW VALUE (dBuV)	CORRECTION FACTOR (dB/m)
1	#5644.00	67.5 PK	68.2	-0.7	2.95 V	137	60.40	7.10
2	*5775.00	111.7 PK			2.95 V	137	70.10	41.60
3	*5775.00	100.5 AV			2.95 V	137	58.90	41.60
4	#5932.00	63.1 PK	68.2	-5.1	2.95 V	137	55.30	7.80
5	11550.00	62.3 PK	74.0	-11.7	2.15 V	167	42.10	20.20
6	11550.00	50.8 AV	54.0	-3.2	2.15 V	167	30.60	20.20

Remarks:

1. Emission Level(dBuV/m) = Raw Value(dBuV) + Correction Factor(dB/m)
2. Correction Factor(dB/m) = Antenna Factor(dB/m) + Cable Factor(dB) – Pre-Amplifier Factor(dB)
3. The other emission levels were very low against the limit.
4. Margin value = Emission Level – Limit value
5. " * ": Fundamental frequency.
6. " # ": The radiated frequency is out of the restricted band.

Below 1GHz Worst-Case Data: 802.11a

CHANNEL	TX Channel 149	DETECTOR FUNCTION	Quasi-Peak (QP)
FREQUENCY RANGE	9kHz ~ 1GHz	TEST MODE	A

ANTENNA POLARITY & TEST DISTANCE: HORIZONTAL AT 3 M

NO.	FREQ. (MHz)	EMISSION LEVEL (dBuV/m)	LIMIT (dBuV/m)	MARGIN (dB)	ANTENNA HEIGHT (m)	TABLE ANGLE (Degree)	RAW VALUE (dBuV)	CORRECTION FACTOR (dB/m)
1	51.34	28.0 QP	40.0	-12.0	1.01 H	183	41.90	-13.90
2	183.26	28.3 QP	43.5	-15.2	1.26 H	135	43.00	-14.70
3	289.96	28.6 QP	46.0	-17.4	1.01 H	126	40.00	-11.40
4	375.32	29.8 QP	46.0	-16.2	1.01 H	248	39.20	-9.40
5	625.58	36.1 QP	46.0	-9.9	1.26 H	55	39.10	-3.00
6	875.84	40.0 QP	46.0	-6.0	1.01 H	353	37.80	2.20

ANTENNA POLARITY & TEST DISTANCE: VERTICAL AT 3 M

NO.	FREQ. (MHz)	EMISSION LEVEL (dBuV/m)	LIMIT (dBuV/m)	MARGIN (dB)	ANTENNA HEIGHT (m)	TABLE ANGLE (Degree)	RAW VALUE (dBuV)	CORRECTION FACTOR (dB/m)
1	32.12	25.4 QP	40.0	-14.6	2.00 V	358	41.30	-15.90
2	61.04	32.3 QP	40.0	-7.7	1.24 V	5	46.90	-14.60
3	177.44	30.9 QP	43.5	-12.6	1.24 V	257	45.00	-14.10
4	291.90	25.9 QP	46.0	-20.1	1.50 V	342	37.30	-11.40
5	499.48	31.2 QP	46.0	-14.8	1.00 V	207	37.70	-6.50
6	625.58	31.8 QP	46.0	-14.2	1.50 V	8	34.80	-3.00

Remarks:

1. Emission Level(dBuV/m) = Raw Value(dBuV) + Correction Factor(dB/m)
2. Correction Factor(dB/m) = Antenna Factor(dB/m) + Cable Factor(dB) – Pre-Amplifier Factor(dB)
3. The other emission levels were very low against the limit.
4. Margin value = Emission Level – Limit value

CHANNEL	TX Channel 149	DETECTOR FUNCTION	Quasi-Peak (QP)
FREQUENCY RANGE	9kHz ~ 1GHz	TEST MODE	B

ANTENNA POLARITY & TEST DISTANCE: HORIZONTAL AT 3 M

NO.	FREQ. (MHz)	EMISSION LEVEL (dBuV/m)	LIMIT (dBuV/m)	MARGIN (dB)	ANTENNA HEIGHT (m)	TABLE ANGLE (Degree)	RAW VALUE (dBuV)	CORRECTION FACTOR (dB/m)
1	30.00	27.6 QP	40.0	-12.4	1.99 H	254	43.60	-16.00
2	72.68	28.6 QP	40.0	-11.4	1.24 H	242	44.70	-16.10
3	194.90	27.2 QP	43.5	-16.3	1.24 H	299	42.80	-15.60
4	289.96	31.1 QP	46.0	-14.9	1.00 H	229	42.50	-11.40
5	375.32	32.3 QP	46.0	-13.7	1.00 H	238	41.70	-9.40
6	625.58	39.1 QP	46.0	-6.9	1.24 H	278	42.10	-3.00

ANTENNA POLARITY & TEST DISTANCE: VERTICAL AT 3 M

NO.	FREQ. (MHz)	EMISSION LEVEL (dBuV/m)	LIMIT (dBuV/m)	MARGIN (dB)	ANTENNA HEIGHT (m)	TABLE ANGLE (Degree)	RAW VALUE (dBuV)	CORRECTION FACTOR (dB/m)
1	30.00	31.0 QP	40.0	-9.0	1.50 V	25	47.00	-16.00
2	50.61	36.0 QP	40.0	-4.0	1.00 V	24	49.90	-13.90
3	191.02	27.3 QP	43.5	-16.2	1.26 V	282	42.80	-15.50
4	289.96	27.4 QP	46.0	-18.6	1.50 V	317	38.80	-11.40
5	625.58	32.0 QP	46.0	-14.0	1.50 V	174	35.00	-3.00
6	895.24	36.7 QP	46.0	-9.3	1.01 V	108	34.20	2.50

Remarks:

1. Emission Level(dBuV/m) = Raw Value(dBuV) + Correction Factor(dB/m)
2. Correction Factor(dB/m) = Antenna Factor(dB/m) + Cable Factor(dB) – Pre-Amplifier Factor(dB)
3. The other emission levels were very low against the limit.
4. Margin value = Emission Level – Limit value

4.2 Conducted Emission Measurement

4.2.1 Limits of Conducted Emission Measurement

Frequency (MHz)	Conducted Limit (dBuV)	
	Quasi-peak	Average
0.15 - 0.5	66 - 56	56 - 46
0.50 - 5.0	56	46
5.0 - 30.0	60	50

Note: 1. The lower limit shall apply at the transition frequencies.

2. The limit decreases in line with the logarithm of the frequency in the range of 0.15 to 0.50MHz.

4.2.2 Test Instruments

Description & Manufacturer	Model No.	Serial No.	Cal. Date	Cal. Due
Test Receiver ROHDE & SCHWARZ	ESCI	100613	Nov. 21, 2016	Nov. 20, 2017
RF signal cable (with 10dB PAD) Woken	5D-FB	Cable-cond1-01	Dec. 22, 2016	Dec. 21, 2017
LISN ROHDE & SCHWARZ (EUT)	ESH3-Z5	835239/001	Mar. 10, 2017	Mar. 09, 2018
LISN ROHDE & SCHWARZ (Peripheral)	ESH3-Z5	100311	Jul. 28, 2016	Jul. 27, 2017
Software ADT	BV ADT_Cond_ V7.3.7.3	NA	NA	NA

Note: 1. The calibration interval of the above test instruments is 12 months and the calibrations are traceable to NML/ROC and NIST/USA.

2. The test was performed in HwaYa Shielded Room 1.

3. The VCCI Site Registration No. is C-2040.

4.2.3 Test Procedures

- The EUT was placed 0.4 meters from the conducting wall of the shielded room with EUT being connected to the power mains through a line impedance stabilization network (LISN). Other support units were connected to the power mains through another LISN. The two LISNs provide 50 ohm/ 50uH of coupling impedance for the measuring instrument.
- Both lines of the power mains connected to the EUT were checked for maximum conducted interference.
- The frequency range from 150kHz to 30MHz was searched. Emission levels under (Limit - 20dB) was not recorded.

NOTE: The resolution bandwidth and video bandwidth of test receiver is 9kHz for quasi-peak detection (QP) and average detection (AV) at frequency 0.15MHz-30MHz.

4.2.4 Deviation from Test Standard

No deviation.

4.2.5 Test Setup

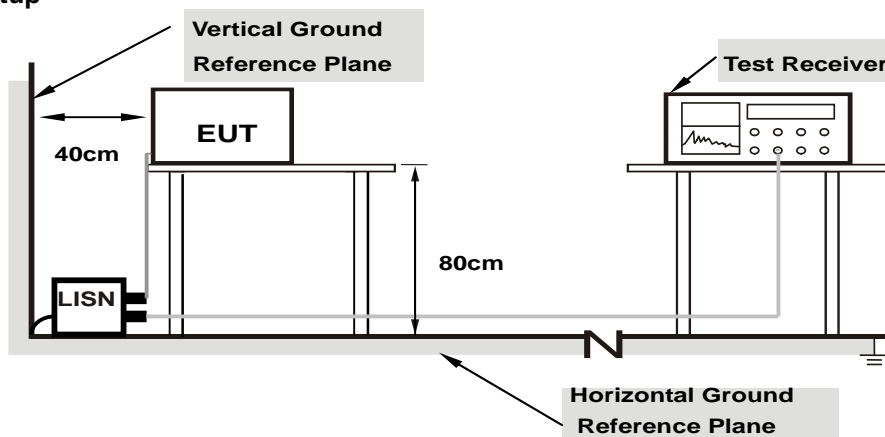

Note: 1.Support units were connected to second LISN.

For the actual test configuration, please refer to the attached file (Test Setup Photo).

4.2.6 EUT Operating Conditions

Same as 4.1.6.

4.2.7 Test Results

Worst-case data: 802.11a

Phase	Line (L)	Detector Function	Quasi-Peak (QP) / Average (AV)
Test Mode	A		

No	Freq. [MHz]	Corr. Factor (dB)	Reading Value		Emission Level		Limit		Margin	
			[dB (uV)]		[dB (uV)]		[dB (uV)]		(dB)	
			Q.P.	AV.	Q.P.	AV.	Q.P.	AV.	Q.P.	AV.
1	0.16233	10.41	37.16	23.46	47.57	33.87	65.34	55.34	-17.77	-21.47
2	0.18600	10.42	33.06	19.87	43.48	30.29	64.21	54.21	-20.73	-23.92
3	0.38117	10.50	35.24	26.42	45.74	36.92	58.25	48.25	-12.51	-11.33
4	1.17800	10.47	18.01	9.59	28.48	20.06	56.00	46.00	-27.52	-25.94
5	5.12200	10.70	14.08	5.94	24.78	16.64	60.00	50.00	-35.22	-33.36
6	11.86200	10.99	6.51	0.93	17.50	11.92	60.00	50.00	-42.50	-38.08

Remarks:

1. Q.P. and AV. are abbreviations of quasi-peak and average individually.
2. The emission levels of other frequencies were very low against the limit.
3. Margin value = Emission level - Limit value
4. Correction factor = Insertion loss + Cable loss
5. Emission Level = Correction Factor + Reading Value.

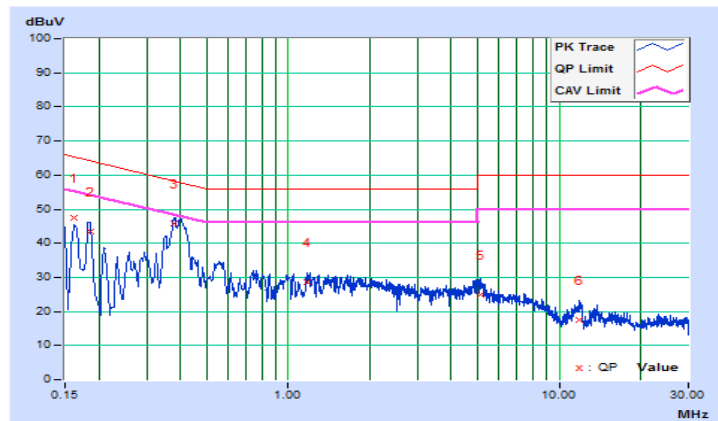

Phase	Neutral (N)	Detector Function	Quasi-Peak (QP) / Average (AV)
Test Mode	A		

No	Freq. [MHz]	Corr. Factor (dB)	Reading Value [dB (uV)]		Emission Level [dB (uV)]		Limit [dB (uV)]		Margin (dB)	
			Q.P.	AV.	Q.P.	AV.	Q.P.	AV.	Q.P.	AV.
			1	0.16600	10.17	33.75	19.92	43.92	30.09	65.16
2	0.20201	10.20	24.69	8.48	34.89	18.68	63.53	53.53	-28.64	-34.85
3	0.29400	10.21	27.59	19.37	37.80	29.58	60.41	50.41	-22.61	-20.83
4	0.38600	10.23	37.10	27.96	47.33	38.19	58.15	48.15	-10.82	-9.96
5	0.77000	10.24	21.38	13.13	31.62	23.37	56.00	46.00	-24.38	-22.63
6	3.65800	10.40	15.63	8.80	26.03	19.20	56.00	46.00	-29.97	-26.80

Remarks:

1. Q.P. and AV. are abbreviations of quasi-peak and average individually.
2. The emission levels of other frequencies were very low against the limit.
3. Margin value = Emission level - Limit value
4. Correction factor = Insertion loss + Cable loss
5. Emission Level = Correction Factor + Reading Value.

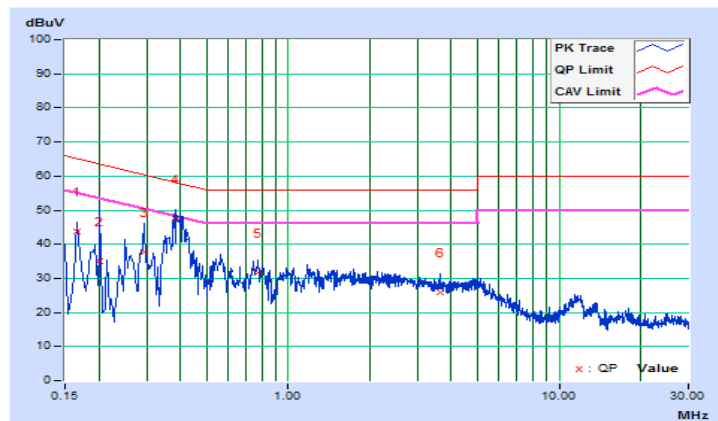

Phase	Line (L)	Detector Function	Quasi-Peak (QP) / Average (AV)
Test Mode	B		

No	Freq. [MHz]	Corr. Factor (dB)	Reading Value [dB (uV)]		Emission Level [dB (uV)]		Limit [dB (uV)]		Margin (dB)	
			Q.P.	AV.	Q.P.	AV.	Q.P.	AV.	Q.P.	AV.
			1	0.15000	10.40	32.68	16.05	43.08	26.45	66.00
2	0.18228	10.42	33.69	16.48	44.11	26.90	64.38	54.38	-20.27	-27.48
3	0.39863	10.51	21.65	13.87	32.16	24.38	57.88	47.88	-25.72	-23.50
4	0.98148	10.46	18.25	18.19	28.71	28.65	56.00	46.00	-27.29	-17.35
5	9.07400	10.86	19.04	18.12	29.90	28.98	60.00	50.00	-30.10	-21.02
6	16.91400	11.26	36.57	34.26	47.83	45.52	60.00	50.00	-12.17	-4.48

Remarks:

1. Q.P. and AV. are abbreviations of quasi-peak and average individually.
2. The emission levels of other frequencies were very low against the limit.
3. Margin value = Emission level - Limit value
4. Correction factor = Insertion loss + Cable loss
5. Emission Level = Correction Factor + Reading Value.

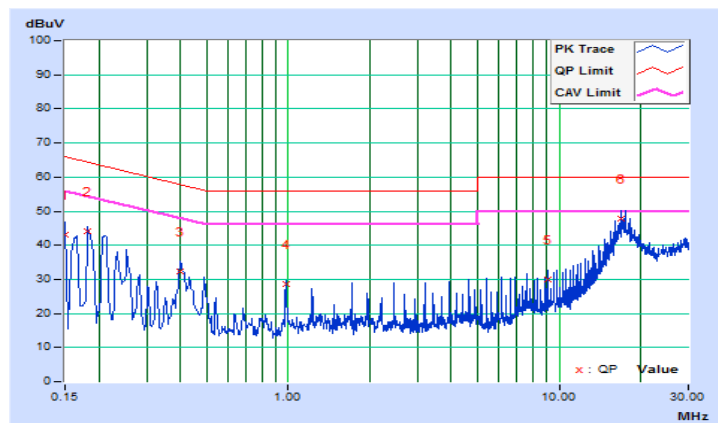

Phase	Neutral (N)	Detector Function	Quasi-Peak (QP) / Average (AV)
Test Mode	B		

No	Freq. [MHz]	Corr. Factor (dB)	Reading Value [dB (uV)]		Emission Level [dB (uV)]		Limit [dB (uV)]		Margin (dB)	
			Q.P.	AV.	Q.P.	AV.	Q.P.	AV.	Q.P.	AV.
			1	0.16600	10.17	34.07	17.41	44.24	27.58	65.16
2	0.21400	10.20	27.91	12.79	38.11	22.99	63.05	53.05	-24.94	-30.06
3	0.40498	10.23	20.65	14.30	30.88	24.53	57.75	47.75	-26.87	-23.22
4	0.98200	10.24	18.81	18.45	29.05	28.69	56.00	46.00	-26.95	-17.31
5	3.92200	10.42	18.81	17.98	29.23	28.40	56.00	46.00	-26.77	-17.60
6	17.65400	10.96	36.32	33.82	47.28	44.78	60.00	50.00	-12.72	-5.22

Remarks:

1. Q.P. and AV. are abbreviations of quasi-peak and average individually.
2. The emission levels of other frequencies were very low against the limit.
3. Margin value = Emission level - Limit value
4. Correction factor = Insertion loss + Cable loss
5. Emission Level = Correction Factor + Reading Value.

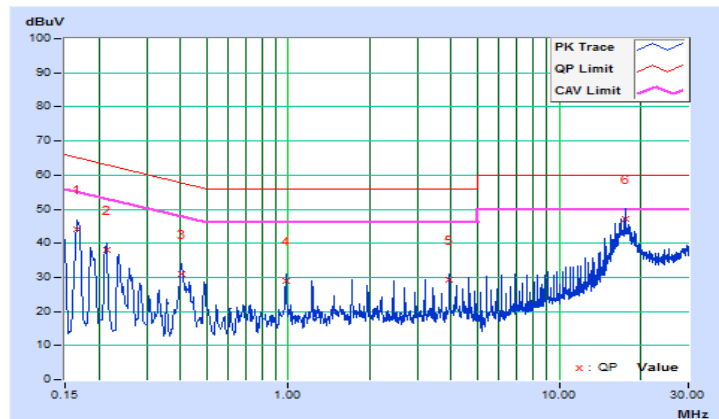

4.3 Transmit Power Measurement

4.3.1 Limits of Transmit Power Measurement

Operation Band	EUT Category		LIMIT
U-NII-1		Outdoor Access Point	1 Watt (30 dBm) (Max. e.i.r.p \leq 125mW(21 dBm) at any elevation angle above 30 degrees as measured from the horizon)
		Fixed point-to-point Access Point	1 Watt (30 dBm)
	√	Indoor Access Point	1 Watt (30 dBm)
		Mobile and Portable client device	250mW (24 dBm)
U-NII-2A	-		250mW (24 dBm) or 11 dBm+10 log B*
U-NII-2C	-		250mW (24 dBm) or 11 dBm+10 log B*
U-NII-3	√		1 Watt (30 dBm)

*B is the 26 dB emission bandwidth in megahertz

Per KDB 662911 Method of conducted output power measurement on IEEE 802.11 devices,

Array Gain = 0 dB (i.e., no array gain) for $N_{ANT} \leq 4$;

Array Gain = 0 dB (i.e., no array gain) for channel widths ≥ 40 MHz for any N_{ANT} ;

Array Gain = $5 \log(N_{ANT}/N_{SS})$ dB or 3 dB, whichever is less for 20-MHz channel widths with $N_{ANT} \geq 5$.

For power measurements on all other devices: Array Gain = $10 \log(N_{ANT}/N_{SS})$ dB.

4.3.2 Test Setup

For Power Output

802.11a, 802.11n (HT20), 802.11n (HT40)

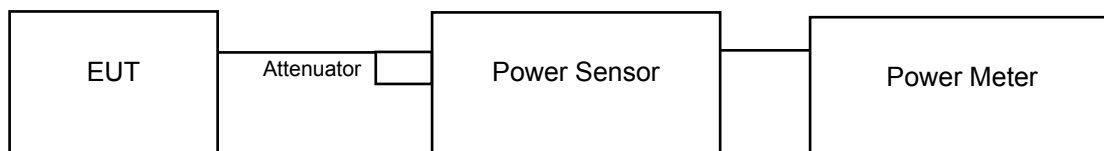

802.11ac (VHT80)

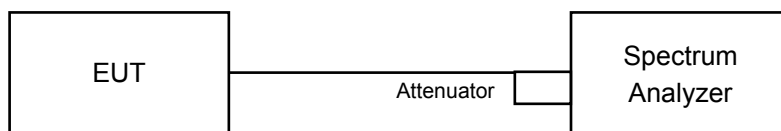

For Bandwidth

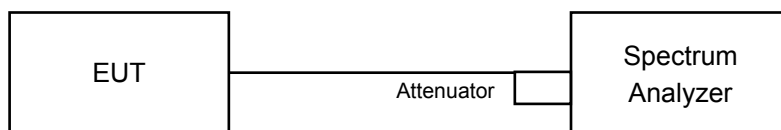

4.3.3 Test Instruments

Refer to section 4.1.2 to get information of above instrument.

4.3.4 Test Procedure

For Average Power Measurement

For 802.11a, 802.11n (HT20), 802.11n (HT40)

Method PM is used to perform output power measurement, trigger and gating function of wide band power meter is enabled to measure max output power of TX on burst. Duty factor is not added to measured value.

For 802.11ac (VHT80)

- 1) Set span to encompass the entire 26 dB EBW (or, alternatively, the entire 99% occupied bandwidth) of the signal.
- 2) Set sweep trigger to "free run".
- 3) Set RBW = 1 MHz.
- 4) Set VBW \geq 3 MHz.
- 5) Number of points in sweep \geq 2 Span / RBW.
- 6) Sweep time \leq (number of points in sweep) * T
- 7) Using emission bandwidth to determine the frequency span for integration the channel bandwidth.
- 8) Detector = RMS.
- 9) Trace mode = max hold.
- 10) Allow max hold to run for at least 60 seconds, or longer as needed to allow the trace to stabilize.
- 11) Compute power by integrating the spectrum across the EBW (or, alternatively, the entire 99% occupied bandwidth) of the signal using the instrument's band power measurement function with band limits set equal to the EBW (or occupied bandwidth) band edges. If the instrument does not have a band power function, sum the spectrum levels (in power units) at 1 MHz intervals extending across the EBW (or, alternatively, the entire 99% occupied bandwidth) of the spectrum.

For 26dB Bandwidth

- 1) Set RBW = approximately 1% of the emission bandwidth.
- 2) Set the VBW > RBW.
- 3) Detector = Peak.
- 4) Trace mode = max hold.
- 5) Measure the maximum width of the emission that is 26 dB down from the peak of the emission. Compare this with the RBW setting of the analyzer. Readjust RBW and repeat measurement as needed until the RBW/EBW ratio is approximately 1%.

4.3.5 Deviation from Test Standard

No deviation.

4.3.6 EUT Operating Conditions

The software provided by client to enable the EUT under transmission condition continuously at lowest, middle and highest channel frequencies individually.

4.3.7 Test Result

Power Output:

CDD Mode, 1TX

802.11a

Chan.	Freq. (MHz)	Maximum Conducted Power (mW)	Maximum Conducted Power (dBm)	Power Limit (dBm)	Pass / Fail
36	5180	118.850	20.75	30	Pass
40	5200	125.314	20.98	30	Pass
48	5240	124.165	20.94	30	Pass
149	5745	190.985	22.81	30	Pass
157	5785	182.390	22.61	30	Pass
165	5825	174.582	22.42	30	Pass

802.11n (HT20)

Chan.	Freq. (MHz)	Maximum Conducted Power (mW)	Maximum Conducted Power (dBm)	Power Limit (dBm)	Pass / Fail
36	5180	81.470	19.11	30	Pass
40	5200	128.233	21.08	30	Pass
48	5240	129.718	21.13	30	Pass
149	5745	191.867	22.83	30	Pass
157	5785	187.499	22.73	30	Pass
165	5825	176.604	22.47	30	Pass

802.11n (HT40)

Chan.	Freq. (MHz)	Maximum Conducted Power (mW)	Maximum Conducted Power (dBm)	Power Limit (dBm)	Pass / Fail
38	5190	31.550	14.99	30	Pass
46	5230	122.180	20.87	30	Pass
151	5755	200.909	23.03	30	Pass
159	5795	186.209	22.70	30	Pass

802.11ac (VHT80)

Chan.	Freq. (MHz)	Maximum Conducted Power (mW)	Maximum Conducted Power (dBm)	Power Limit (dBm)	Pass / Fail
42	5210	23.014	13.62	30	Pass
155	5775	112.980	20.53	30	Pass

CDD Mode, 2TX

802.11a

Chan.	Freq. (MHz)	Maximum Conducted Power (dBm)		Total Power (mW)	Total Power (dBm)	Power Limit (dBm)	Pass / Fail
		Chain 0	Chain 1				
36	5180	18.26	18.29	134.441	21.29	30	Pass
40	5200	18.99	18.22	145.624	21.63	30	Pass
48	5240	20.33	20.24	213.577	23.30	30	Pass
149	5745	21.72	20.78	268.268	24.29	30	Pass
157	5785	21.63	20.40	255.194	24.07	30	Pass
165	5825	21.69	20.58	261.859	24.18	30	Pass

802.11n (HT20)

Chan.	Freq. (MHz)	Maximum Conducted Power (dBm)		Total Power (mW)	Total Power (dBm)	Power Limit (dBm)	Pass / Fail
		Chain 0	Chain 1				
36	5180	17.89	17.87	122.753	20.89	30	Pass
40	5200	18.56	18.77	147.115	21.68	30	Pass
48	5240	20.14	20.17	207.268	23.17	30	Pass
149	5745	21.56	20.74	261.796	24.18	30	Pass
157	5785	21.60	20.62	259.889	24.15	30	Pass
165	5825	21.63	20.81	266.050	24.25	30	Pass

802.11n (HT40)

Chan.	Freq. (MHz)	Maximum Conducted Power (dBm)		Total Power (mW)	Total Power (dBm)	Power Limit (dBm)	Pass / Fail
		Chain 0	Chain 1				
38	5190	14.36	14.24	53.836	17.31	30	Pass
46	5230	20.57	20.32	221.672	23.46	30	Pass
151	5755	20.42	19.82	206.094	23.14	30	Pass
159	5795	20.42	19.64	202.199	23.06	30	Pass

802.11ac (VHT80)

Chan.	Freq. (MHz)	Maximum Conducted Power (dBm)		Total Power (mW)	Total Power (dBm)	Power Limit (dBm)	Pass / Fail
		Chain 0	Chain 1				
42	5210	13.28	13.55	43.927	16.43	30	Pass
155	5775	20.39	19.65	201.653	23.05	30	Pass

Beamforming Mode

802.11n (HT20)

Chan.	Freq. (MHz)	Maximum Conducted Power (dBm)		Total Power (mW)	Total Power (dBm)	Power Limit (dBm)	Pass / Fail
		Chain 0	Chain 1				
36	5180	17.89	17.87	122.753	20.89	28.13	Pass
40	5200	18.56	18.77	147.115	21.68	28.13	Pass
48	5240	20.14	20.17	207.268	23.17	28.13	Pass
149	5745	20.81	21.04	247.561	23.94	28.03	Pass
157	5785	20.55	21.30	248.397	23.95	28.03	Pass
165	5825	20.77	21.17	250.317	23.98	28.03	Pass

Note:

U-NII-1: Directional gain = $10 \log[(10^{G1/20} + 10^{G2/20} + \dots + 10^{GN/20})^2/N]$ = 7.87dBi > 6dBi, so the limit shall be reduced to $30-(7.87-6) = 28.13$ dBm.

U-NII-3: Directional gain = $10 \log[(10^{G1/20} + 10^{G2/20} + \dots + 10^{GN/20})^2/N]$ = 7.97dBi > 6dBi, so the limit shall be reduced to $30-(7.97-6) = 28.03$ dBm.

802.11n (HT40)

Chan.	Freq. (MHz)	Maximum Conducted Power (dBm)		Total Power (mW)	Total Power (dBm)	Power Limit (dBm)	Pass / Fail
		Chain 0	Chain 1				
38	5190	14.36	14.24	53.836	17.31	28.13	Pass
46	5230	20.32	20.18	211.879	23.26	28.13	Pass
151	5755	20.42	19.82	206.094	23.14	28.03	Pass
159	5795	20.42	19.64	202.199	23.06	28.03	Pass

Note:

U-NII-1: Directional gain = $10 \log[(10^{G1/20} + 10^{G2/20} + \dots + 10^{GN/20})^2/N]$ = 7.87dBi > 6dBi, so the limit shall be reduced to $30-(7.87-6) = 28.13$ dBm.

U-NII-3: Directional gain = $10 \log[(10^{G1/20} + 10^{G2/20} + \dots + 10^{GN/20})^2/N]$ = 7.97dBi > 6dBi, so the limit shall be reduced to $30-(7.97-6) = 28.03$ dBm.

802.11ac (VHT80)

Chan.	Freq. (MHz)	Maximum Conducted Power (dBm)		Total Power (mW)	Total Power (dBm)	Power Limit (dBm)	Pass / Fail
		Chain 0	Chain 1				
42	5210	13.28	13.55	43.927	16.43	28.13	Pass
155	5775	20.39	19.65	201.653	23.05	28.03	Pass

Note:

U-NII-1: Directional gain = $10 \log[(10^{G1/20} + 10^{G2/20} + \dots + 10^{GN/20})^2/N]$ = 7.87dBi > 6dBi, so the limit shall be reduced to $30-(7.87-6) = 28.13$ dBm.

U-NII-3: Directional gain = $10 \log[(10^{G1/20} + 10^{G2/20} + \dots + 10^{GN/20})^2/N]$ = 7.97dBi > 6dBi, so the limit shall be reduced to $30-(7.97-6) = 28.03$ dBm.

26dB Bandwidth:

1TX

802.11a

Channel	Frequency (MHz)	26dBc Bandwidth (MHz)
36	5180	34.13
40	5200	39.03
48	5240	39.05

802.11n (HT20)

Channel	Frequency (MHz)	26dBc Bandwidth (MHz)
36	5180	35.93
40	5200	44.64
48	5240	43.11

802.11n (HT40)

Channel	Frequency (MHz)	26dBc Bandwidth (MHz)
38	5190	45.24
46	5230	98.72

802.11ac (VHT80)

Channel	Frequency (MHz)	26dBc Bandwidth (MHz)
42	5210	83.17

Spectrum Plot of Worst Value

802.11a

802.11n (HT20)

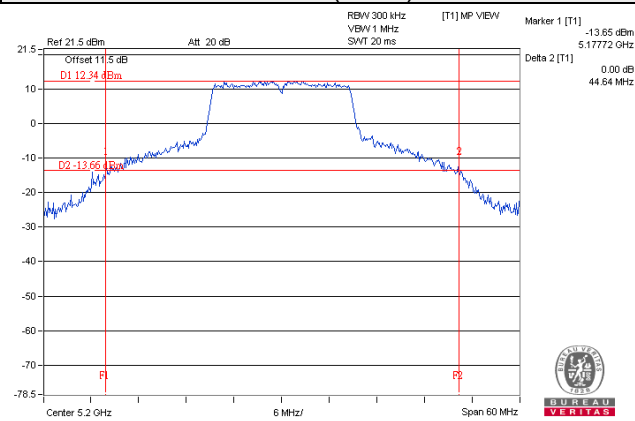
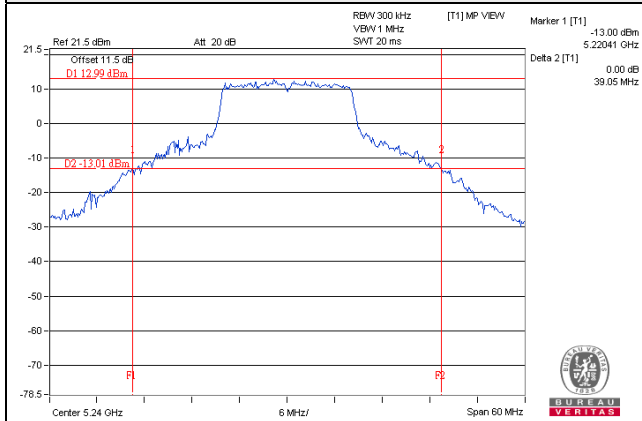

802.11n (HT40)

802.11ac (VHT80)

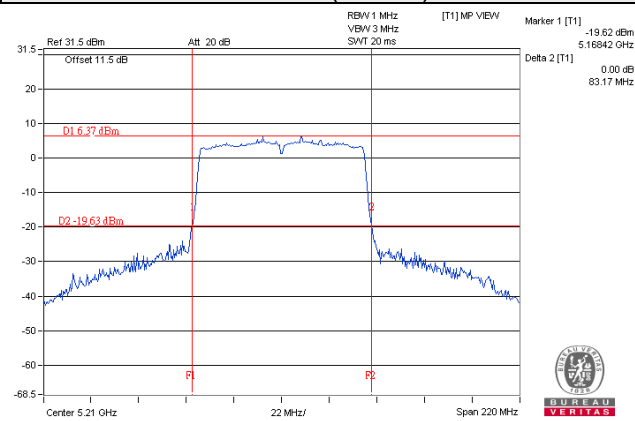
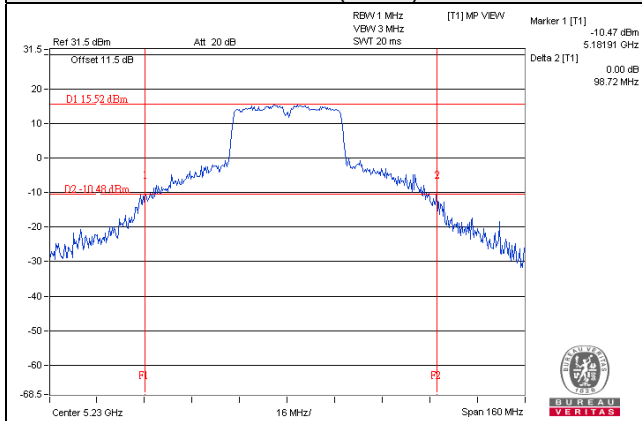

2TX

802.11a

Channel	Frequency (MHz)	26dBc Bandwidth (MHz)	
		Chain 0	Chain 1
36	5180	33.00	29.56
40	5200	33.36	30.53
48	5240	39.07	38.27

802.11n (HT20)

Channel	Frequency (MHz)	26dBc Bandwidth (MHz)	
		Chain 0	Chain 1
36	5180	35.85	29.78
40	5200	40.61	33.15
48	5240	45.18	40.92

802.11n (HT40)

Channel	Frequency (MHz)	26dBc Bandwidth (MHz)	
		Chain 0	Chain 1
38	5190	42.42	40.79
46	5230	94.95	92.32

802.11ac (VHT80)

Channel	Frequency (MHz)	26dBc Bandwidth (MHz)	
		Chain 0	Chain 1
42	5210	83.10	82.63

Spectrum Plot of Worst Value

802.11a

802.11n (HT20)

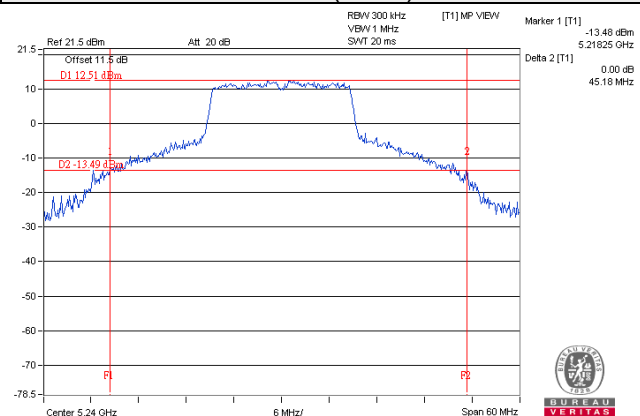
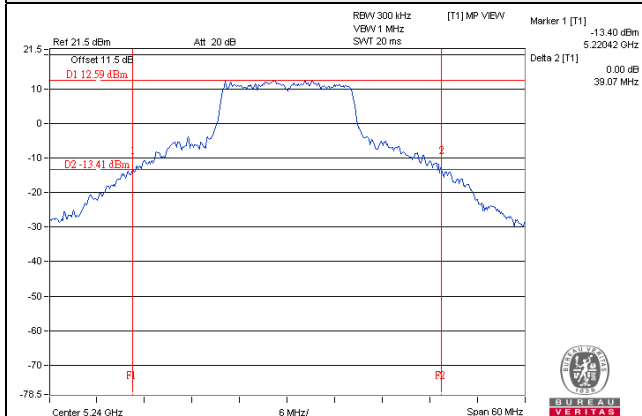

802.11n (HT40)

802.11ac (VHT80)

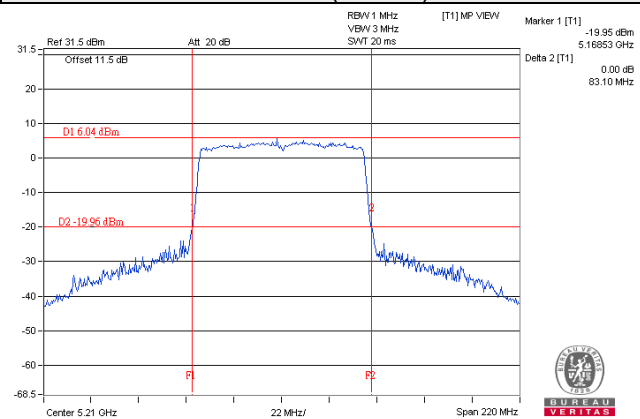
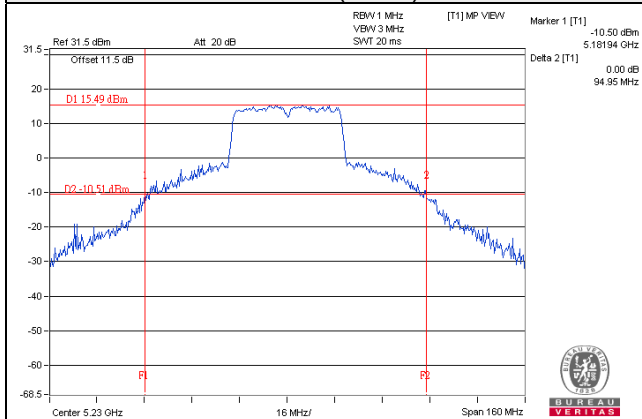

4.4 Occupied Bandwidth Measurement

4.4.1 Test Setup

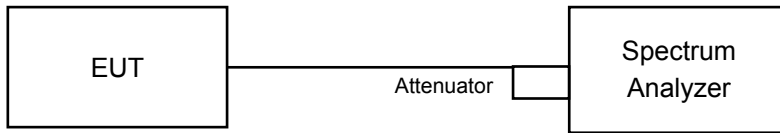

4.4.2 Test Instruments

Refer to section 4.1.2 to get information of above instrument.

4.4.3 Test Procedure

The transmitter output was connected to the spectrum analyzer through an attenuator. The bandwidth of the fundamental frequency was measured by spectrum analyzer with resolution bandwidth in the range of 1% to 5% of the anticipated emission bandwidth, and a video bandwidth at least 3x the resolution bandwidth and set the detector to sampling. The width of a frequency band such that, below the lower and above the upper frequency limits, the mean powers emitted are each equal to a specified percentage 0.5 %of the total mean power of a given emission.

4.4.4 Test Result

1TX

802.11a

Channel	Frequency (MHz)	Occupied Bandwidth (MHz)
36	5180	18.48
40	5200	23.52
48	5240	19.83
149	5745	31.47
157	5785	31.44
165	5825	30.60

802.11n (HT20)

Channel	Frequency (MHz)	Occupied Bandwidth (MHz)
36	5180	18.48
40	5200	24.24
48	5240	19.80
149	5745	33.60
157	5785	34.08
165	5825	32.76

802.11n (HT40)

Channel	Frequency (MHz)	Occupied Bandwidth (MHz)
38	5190	36.60
46	5230	39.61
151	5755	48.96
159	5795	48.60

802.11ac (VHT80)

Channel	Frequency (MHz)	Occupied Bandwidth (MHz)
42	5210	75.84
155	5775	77.28

Spectrum Plot of Worst Value

802.11a/Ch48

802.11n (HT20)/Ch48

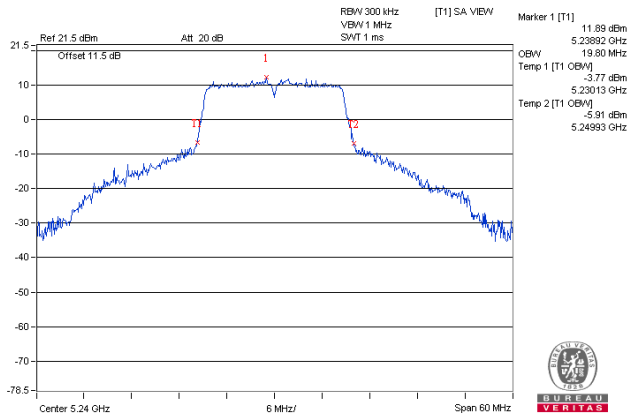
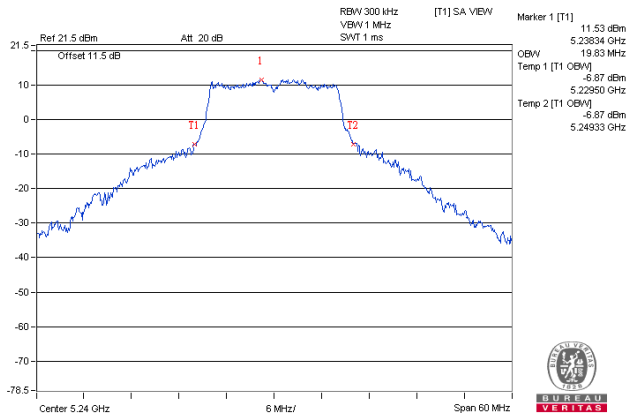

802.11a/Ch149

802.11n (HT20)/Ch157

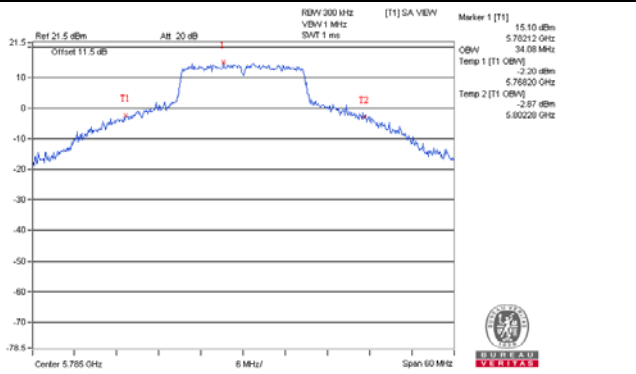
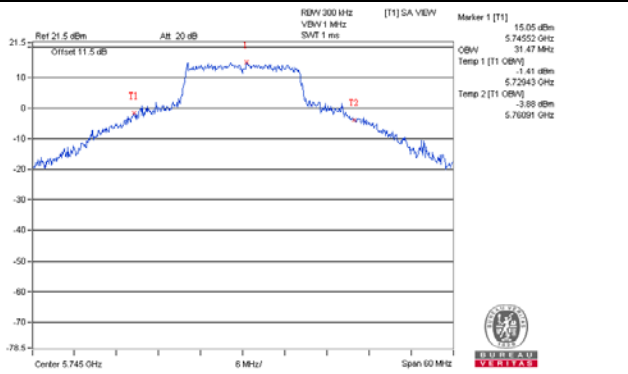

802.11n (HT40)/46

802.11ac (VHT80)/Ch155

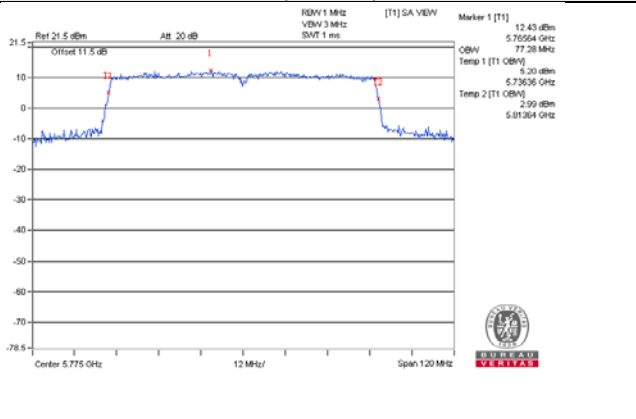
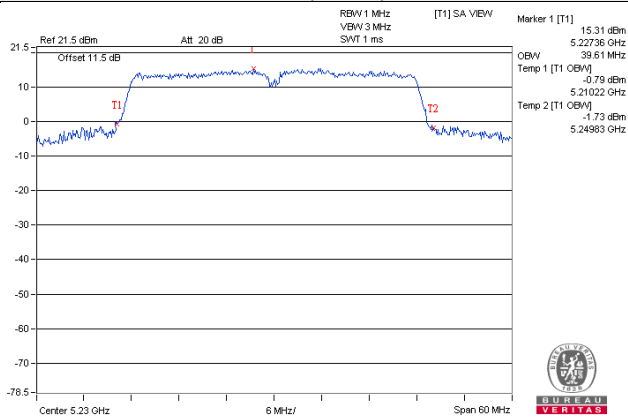

802.11n (HT40)/Ch151

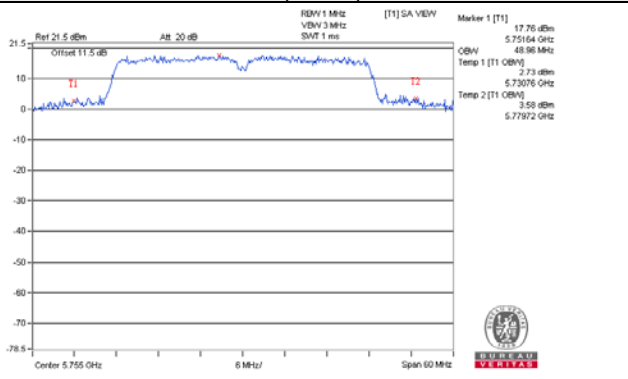

2TX

802.11a

Channel	Frequency (MHz)	Occupied Bandwidth (MHz)	
		Chain 0	Chain 1
36	5180	17.40	17.04
40	5200	17.88	17.28
48	5240	19.73	17.91
149	5745	25.56	22.78
157	5785	26.64	22.56
165	5825	25.68	22.08

802.11n (HT20)

Channel	Frequency (MHz)	Occupied Bandwidth (MHz)	
		Chain 0	Chain 1
36	5180	18.36	18.12
40	5200	18.60	18.12
48	5240	19.30	18.52
149	5745	27.00	23.04
157	5785	27.36	24.24
165	5825	27.60	23.40

802.11n (HT40)

Channel	Frequency (MHz)	Occupied Bandwidth (MHz)	
		Chain 0	Chain 1
38	5190	36.60	36.60
46	5230	38.52	37.47
151	5755	37.92	37.32
159	5795	38.04	37.32

802.11ac (VHT80)

Channel	Frequency (MHz)	Occupied Bandwidth (MHz)	
		Chain 0	Chain 1
42	5210	75.84	75.84
155	5775	76.80	76.32

Spectrum Plot of Worst Value

802.11a/Chain 0/CH48

802.11n (HT20) /Chain 0/CH48

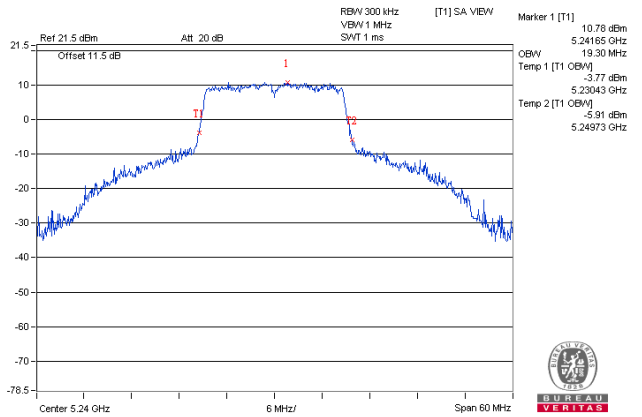
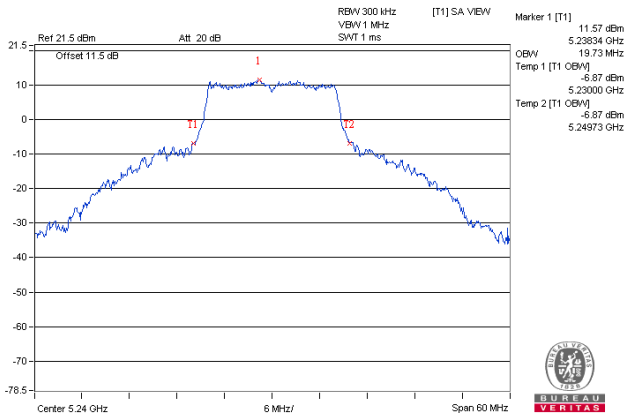

802.11a/Chain 0/CH157

802.11n (HT20) /Chain 0/CH165

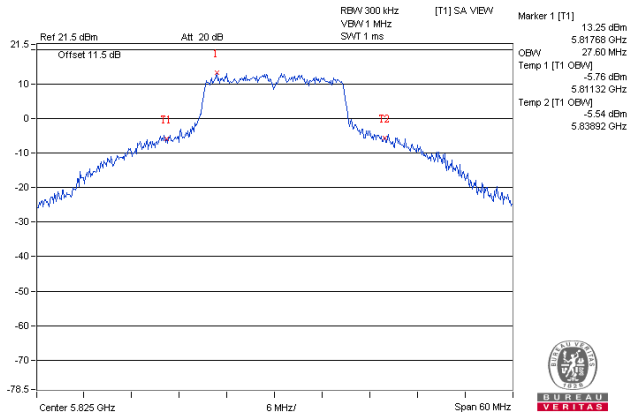
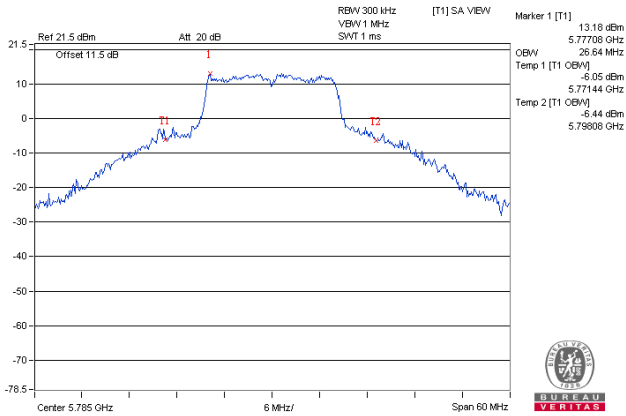

802.11n (HT40)/Chain 0/CH46

802.11ac (VHT80)/Chain 0/CH155

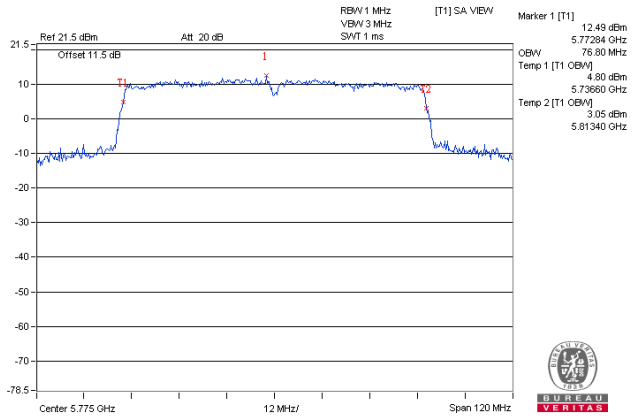
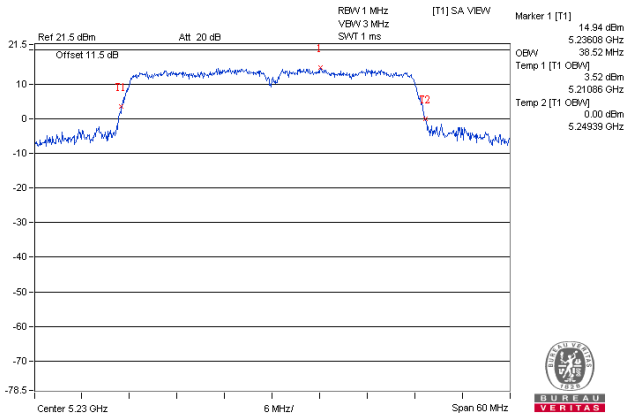

4.5 Peak Power Spectral Density Measurement

4.5.1 Limits of Peak Power Spectral Density Measurement

Operation Band	EUT Category		LIMIT
U-NII-1		Outdoor Access Point	17dBm/ MHz
		Fixed point-to-point Access Point	
	√	Indoor Access Point	
		Mobile and Portable client device	11dBm/ MHz
U-NII-2A	-		11dBm/ MHz
U-NII-2C	-		11dBm/ MHz
U-NII-3	√		30dBm/ 500kHz

4.5.2 Test Setup

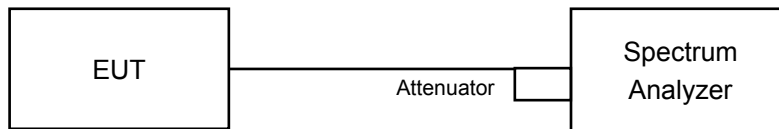

4.5.3 Test Instruments

Refer to section 4.1.2 to get information of above instrument.

4.5.4 Test Procedures

For U-NII-1 band:

Duty cycle of test signal is $\geq 98\%$

Using method SA-1

- 1) Set span to encompass the entire emission bandwidth (EBW) of the signal.
- 2) Set RBW = 1MHz, Set VBW ≥ 3 MHz, Detector = RMS
- 3) Set Channel power measure = 1MHz
- 4) Sweep time = auto, trigger set to "free run".
- 5) Trace average at least 100 traces in power averaging mode.
- 6) Record the max value

Duty cycle of test signal is $< 98\%$

Using method SA-2

- 1) Set span to encompass the entire emission bandwidth (EBW) of the signal.
- 2) Set RBW = 1MHz, Set VBW ≥ 3 MHz, Detector = RMS
- 3) Set Channel power measure = 1MHz
- 4) Sweep time = auto, trigger set to "free run".
- 5) Trace average at least 100 traces in power averaging mode.
- 6) Record the max value and add $10 \log (1/\text{duty cycle})$

For U-NII-3 band:

Duty cycle of test signal is $\geq 98\%$

Using method SA-1

- 1) Set span to encompass the entire emission bandwidth (EBW) of the signal.
- 2) Set RBW = 300 kHz, Set VBW ≥ 1 MHz, Detector = RMS.
- 3) Use the peak marker function to determine the maximum power level in any 300 kHz band segment within the fundamental EBW.
- 4) Scale the observed power level to an equivalent value in 500 kHz by adjusting (reducing) the measured power by a bandwidth correction factor (BWCF) where $BWCF = 10\log(500 \text{ kHz} / 300 \text{ kHz})$.
- 5) Sweep time = auto, trigger set to "free run".
- 6) Trace average at least 100 traces in power averaging mode.
- 7) Record the max value.

Duty cycle of test signal is $< 98\%$

- 1) Set span to encompass the entire emission bandwidth (EBW) of the signal.
- 2) Set RBW = 300 kHz, Set VBW ≥ 1 MHz, Detector = RMS
- 3) Use the peak marker function to determine the maximum power level in any 300 kHz band segment within the fundamental EBW.
- 4) Scale the observed power level to an equivalent value in 500 kHz by adjusting (reducing) the measured power by a bandwidth correction factor (BWCF) where $BWCF = 10\log(500 \text{ kHz} / 300 \text{ kHz})$
- 5) Sweep time = auto, trigger set to "free run".
- 6) Trace average at least 100 traces in power averaging mode.
- 7) Record the max value and add $10 \log (1/\text{duty cycle})$

4.5.5 Deviation from Test Standard

No deviation.

4.5.6 EUT Operating Conditions

Same as 4.3.6.

4.5.7 Test Results

For U-NII-1 band:

1TX

802.11a

Chan.	Freq. (MHz)	PSD (dBm/MHz)	Max. Limit (dBm/MHz)	Pass / Fail
36	5180	7.29	17.00	Pass
40	5200	8.34	17.00	Pass
48	5240	8.30	17.00	Pass

802.11n (HT20)

Chan.	Freq. (MHz)	PSD (dBm/MHz)	Max. Limit (dBm/MHz)	Pass / Fail
36	5180	6.56	17.00	Pass
40	5200	8.19	17.00	Pass
48	5240	8.22	17.00	Pass

802.11n (HT40)

Chan.	Freq. (MHz)	PSD W/O Duty Factor (dBm/MHz)	Duty Factor (dB)	PSD With Duty Factor (dBm/MHz)	Max. Limit (dBm/MHz)	Pass / Fail
38	5190	-0.54	0.10	-0.44	17.00	Pass
46	5230	5.05	0.10	5.15	17.00	Pass

Note:

1. Refer to section 3.3 for duty cycle spectrum plot.

802.11ac (VHT80)

Chan.	Freq. (MHz)	PSD W/O Duty Factor (dBm/MHz)	Duty Factor (dB)	PSD With Duty Factor (dBm/MHz)	Max. Limit (dBm/MHz)	Pass / Fail
42	5210	-5.12	0.35	-4.77	17.00	Pass

Note:

1. Refer to section 3.3 for duty cycle spectrum plot.

Spectrum Plot of Worst Value

802.11a / CH 40

802.11n (HT20) / CH 48

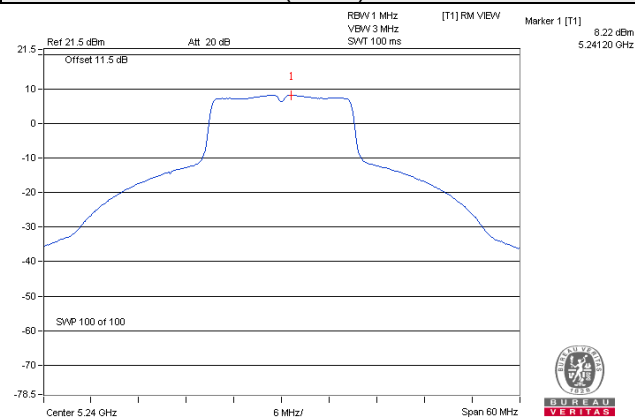
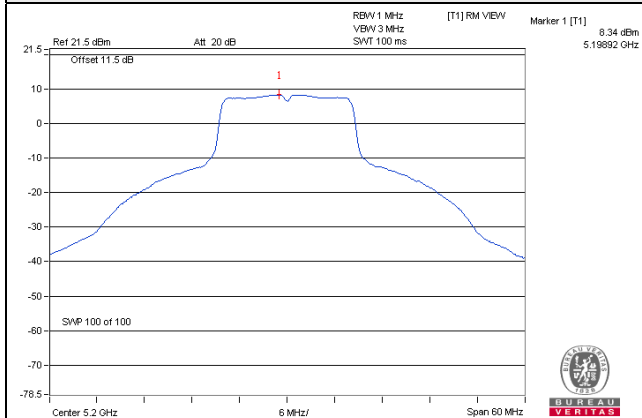

802.11n (HT40) / CH 46

802.11ac (VHT80) / CH 42

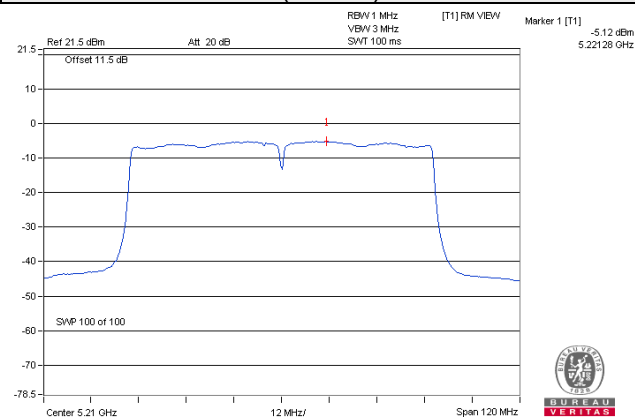
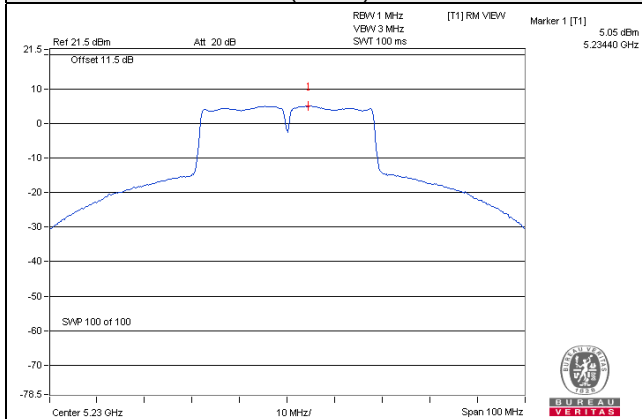

2TX

802.11a

Chan.	Freq. (MHz)	PSD (dBm/MHz)		Total PSD (dBm)	Max. Limit (dBm/MHz)	Pass / Fail
		Chain 0	Chain 1			
36	5180	6.07	6.43	9.26	15.13	Pass
40	5200	6.86	6.92	9.90	15.13	Pass
48	5240	7.45	7.39	10.43	15.13	Pass

Note:

- Method 1 of power density measurement of KDB 662911 is using for calculating total power density. Total power density is summing entire spectra across corresponding frequency bins on the various outputs by computer.
- Directional gain = $10 \log[(10^{G1/20} + 10^{G2/20} + \dots + 10^{GN/20})^2/N]$ = 7.87dBi > 6dBi, so the limit shall be reduced to $17-(7.87-6) = 15.13\text{dBm}$.

802.11n (HT20)

Chan.	Freq. (MHz)	PSD (dBm/MHz)		Total PSD (dBm)	Max. Limit (dBm/MHz)	Pass / Fail
		Chain 0	Chain 1			
36	5180	6.21	5.96	9.10	15.13	Pass
40	5200	6.70	6.51	9.62	15.13	Pass
48	5240	7.14	6.99	10.08	15.13	Pass

Note:

- Method 1 of power density measurement of KDB 662911 is using for calculating total power density. Total power density is summing entire spectra across corresponding frequency bins on the various outputs by computer.
- Directional gain = $10 \log[(10^{G1/20} + 10^{G2/20} + \dots + 10^{GN/20})^2/N]$ = 7.87dBi > 6dBi, so the limit shall be reduced to $17-(7.87-6) = 15.13\text{dBm}$.

802.11n (HT40)

Chan.	Freq. (MHz)	PSD W/O Duty Factor (dBm/MHz)		Duty Factor (dB)	Total PSD With Duty Factor (dBm/MHz)	Max. Limit (dBm/MHz)	Pass / Fail
		Chain 0	Chain 1				
38	5190	-1.09	-1.08	0.13	2.05	15.13	Pass
46	5230	4.90	4.61	0.13	7.90	15.13	Pass

Note:

- Method 1 of power density measurement of KDB 662911 is using for calculating total power density. Total power density is summing entire spectra across corresponding frequency bins on the various outputs by computer.
- Directional gain = $10 \log[(10^{G1/20} + 10^{G2/20} + \dots + 10^{GN/20})^2/N]$ = 7.87dBi > 6dBi, so the limit shall be reduced to $17-(7.87-6) = 15.13\text{dBm}$.
- Refer to section 3.3 for duty cycle spectrum plot.

802.11ac (VHT80)

Chan.	Freq. (MHz)	PSD W/O Duty Factor (dBm/MHz)		Duty Factor (dB)	Total PSD With Duty Factor (dBm/MHz)	Max. Limit (dBm/MHz)	Pass / Fail
		Chain 0	Chain 1				
42	5210	-5.28	-5.33	0.28	-2.01	15.13	Pass

Note:

1. Method 1 of power density measurement of KDB 662911 is using for calculating total power density. Total power density is summing entire spectra across corresponding frequency bins on the various outputs by computer.
2. Directional gain = $10 \log[(10^{G1/20} + 10^{G2/20} + \dots + 10^{GN/20})^2/N]$ = 7.87dBi > 6dBi, so the limit shall be reduced to 17-(7.87-6) = 15.13dBm.
3. Refer to section 3.3 for duty cycle spectrum plot.

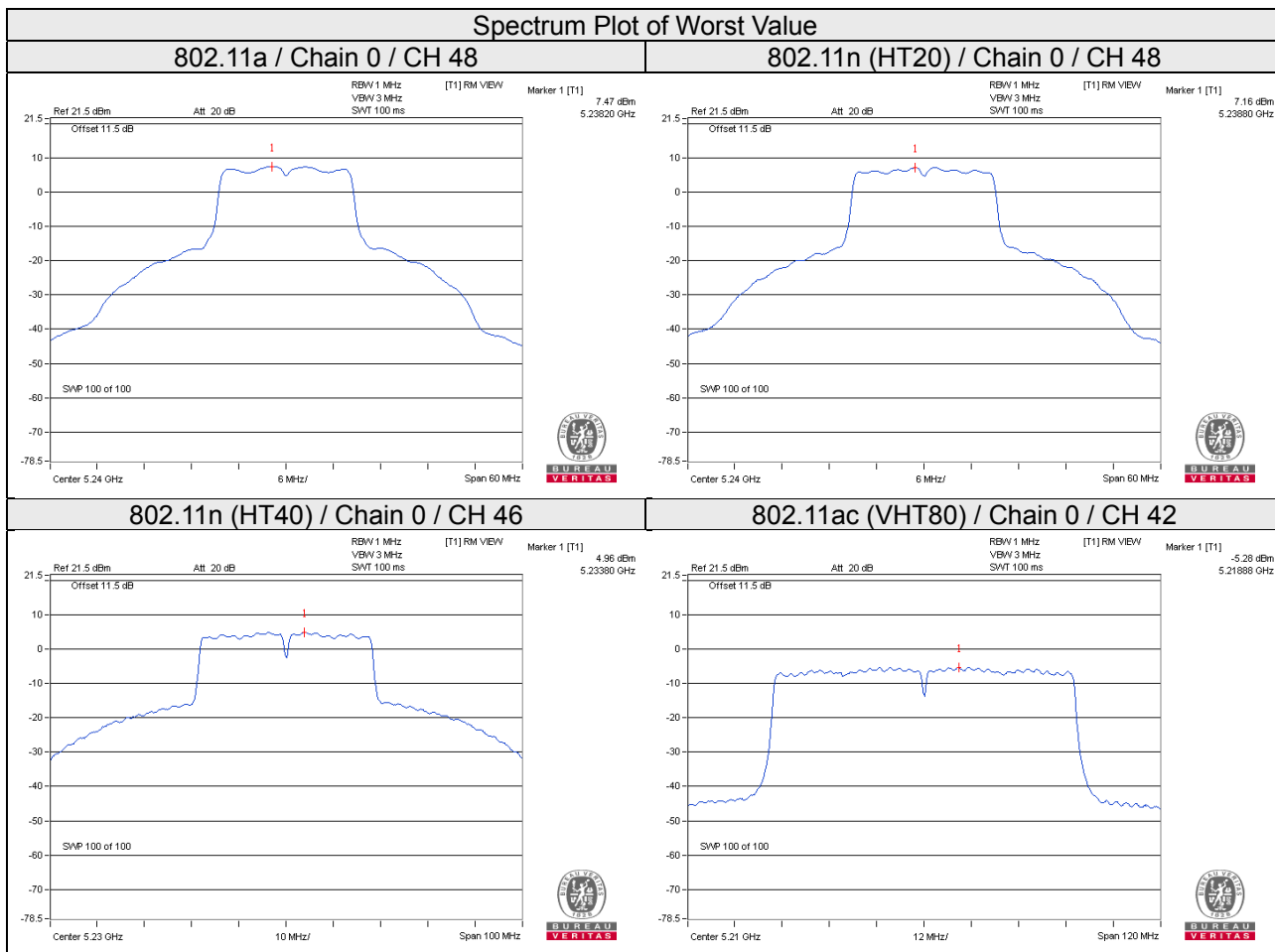

For U-NII-3 band:

1TX

802.11a

Chan.	Freq. (MHz)	PSD (dBm/300kHz)	PSD (dBm/500kHz)	Limit (dBm/500kHz)	Pass / Fail
149	5745	2.45	4.67	30.00	Pass
157	5785	2.36	4.58	30.00	Pass
165	5825	2.19	4.41	30.00	Pass

802.11n (HT20)

Chan.	Freq. (MHz)	PSD (dBm/300kHz)	PSD (dBm/500kHz)	Limit (dBm/500kHz)	Pass / Fail
149	5745	2.09	4.31	30.00	Pass
157	5785	2.05	4.27	30.00	Pass
165	5825	1.90	4.12	30.00	Pass

802.11n (HT40)

Chan.	Freq. (MHz)	PSD W/O Duty Factor		Duty Factor (dB)	Total PSD With Duty Factor (dBm/500kHz)	Limit (dBm/500kHz)	Pass / Fail
		(dBm/300kHz)	(dBm/500kHz)				
151	5755	-1.16	1.06	0.10	1.16	30	Pass
159	5795	-1.40	0.82	0.10	0.92	30	Pass

Note:

1. Refer to section 3.3 for duty cycle spectrum plot.

802.11ac (VHT80)

Chan.	Freq. (MHz)	PSD W/O Duty Factor		Duty Factor (dB)	Total PSD With Duty Factor (dBm/500kHz)	Limit (dBm/500kHz)	Pass / Fail
		(dBm/300kHz)	(dBm/500kHz)				
155	5775	-6.58	-4.36	0.35	-4.01	30	Pass

Note:

1. Refer to section 3.3 for duty cycle spectrum plot.

Spectrum Plot of Worst Value

802.11a

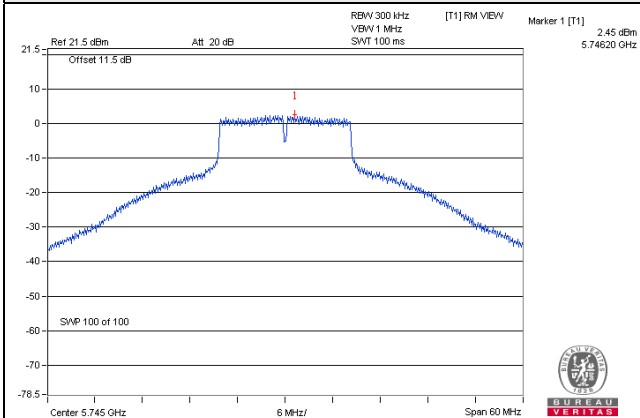

802.11n (HT20)

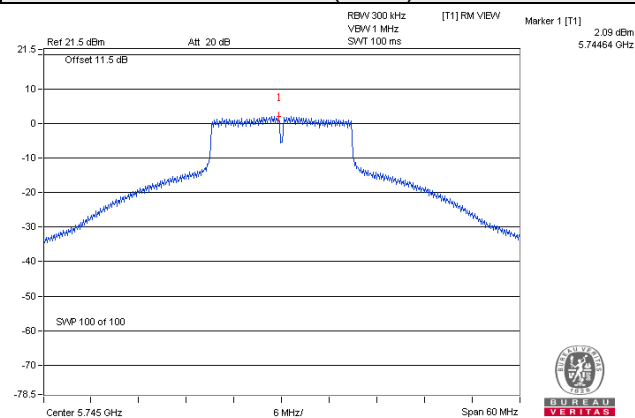

802.11n (HT40)

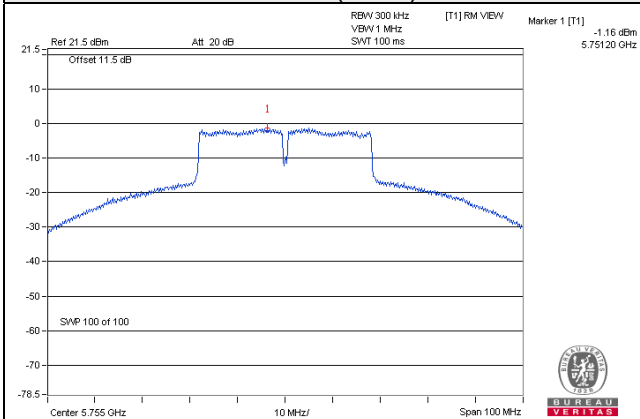

802.11ac (VHT80)

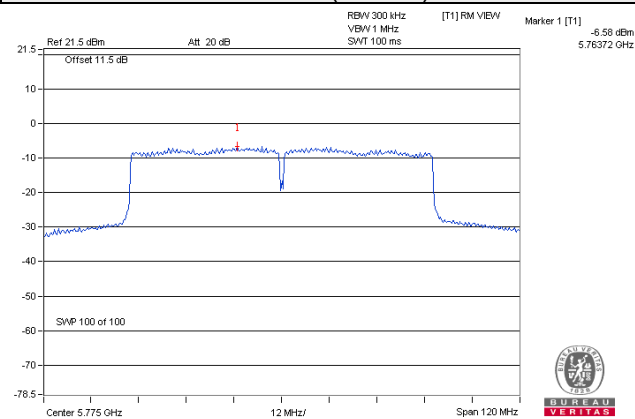

2TX

802.11a

TX chain	Channel	Freq. (MHz)	PSD (dBm/300kHz)	PSD (dBm/500kHz)	10 log (N=2) dB	Total PSD (dBm/500kHz)	Limit (dBm/500kHz)	Pass / Fail
0	149	5745	1.25	3.47	3.01	6.48	28.03	Pass
	157	5785	1.51	3.73	3.01	6.74	28.03	Pass
	165	5825	1.24	3.46	3.01	6.47	28.03	Pass
1	149	5745	0.35	2.57	3.01	5.58	28.03	Pass
	157	5785	0.33	2.55	3.01	5.56	28.03	Pass
	165	5825	0.40	2.62	3.01	5.63	28.03	Pass

Note:

- Method 1 of power density measurement of KDB 662911 is using for calculating total power density. Total power density is summing entire spectra across corresponding frequency bins on the various outputs by computer.
- Directional gain = $10 \log[(10^{G1/20} + 10^{G2/20} + \dots + 10^{GN/20})^2/N]$ = 7.97dBi > 6dBi, so the limit shall be reduced to $30-(7.97-6) = 28.03$ dBm.

802.11n (HT20)

TX chain	Channel	Freq. (MHz)	PSD (dBm/300kHz)	PSD (dBm/500kHz)	10 log (N=2) dB	Total PSD (dBm/500kHz)	Limit (dBm/500kHz)	Pass / Fail
0	149	5745	0.84	3.06	3.01	6.07	28.03	Pass
	157	5785	0.96	3.18	3.01	6.19	28.03	Pass
	165	5825	0.90	3.12	3.01	6.13	28.03	Pass
1	149	5745	-0.08	2.14	3.01	5.15	28.03	Pass
	157	5785	-0.05	2.17	3.01	5.18	28.03	Pass
	165	5825	-0.18	2.04	3.01	5.05	28.03	Pass

Note:

- Method 1 of power density measurement of KDB 662911 is using for calculating total power density. Total power density is summing entire spectra across corresponding frequency bins on the various outputs by computer.
- Directional gain = $10 \log[(10^{G1/20} + 10^{G2/20} + \dots + 10^{GN/20})^2/N]$ = 7.97dBi > 6dBi, so the limit shall be reduced to $30-(7.97-6) = 28.03$ dBm.

802.11n (HT40)

TX chain	Channel	Freq. (MHz)	PSD (dBm/300kHz)	PSD (dBm/500kHz)	10 log (N=2) dB	Duty factor	Total PSD (dBm/500kHz)	Limit (dBm/500kHz)	Pass / Fail
0	151	5755	-3.62	-1.40	3.01	0.13	1.74	28.03	Pass
	159	5795	-3.65	-1.43	3.01	0.13	1.71	28.03	Pass
1	151	5755	-4.52	-2.30	3.01	0.13	0.84	28.03	Pass
	159	5795	-4.39	-2.17	3.01	0.13	0.97	28.03	Pass

Note:

- Method 1 of power density measurement of KDB 662911 is using for calculating total power density. Total power density is summing entire spectra across corresponding frequency bins on the various outputs by computer.
- Directional gain = $10 \log[(10^{G1/20} + 10^{G2/20} + \dots + 10^{GN/20})^2/N]$ = 7.97dBi > 6dBi, so the limit shall be reduced to $30-(7.97-6) = 28.03$ dBm.
- Refer to section 3.3 for duty cycle spectrum plot.

802.11ac (VHT80)

TX chain	Channel	Freq. (MHz)	PSD (dBm/300kHz)	PSD (dBm/500kHz)	10 log (N=2) dB	Duty factor	Total PSD (dBm/500kHz)	Limit (dBm/500kHz)	Pass / Fail
0	155	5775	-7.12	-4.90	3.01	0.28	-1.61	28.03	Pass
1	155	5775	-7.76	-5.54	3.01	0.28	-2.25	28.03	Pass

Note:

- Method 1 of power density measurement of KDB 662911 is using for calculating total power density. Total power density is summing entire spectra across corresponding frequency bins on the various outputs by computer.
- Directional gain = $10 \log[(10^{G1/20} + 10^{G2/20} + \dots + 10^{GN/20})^2/N]$ = 7.97dBi > 6dBi, so the limit shall be reduced to 30-(7.97-6) = 28.03dBm.
- Refer to section 3.3 for duty cycle spectrum plot.

Spectrum Plot of Worst Value

802.11a

802.11n (HT20)

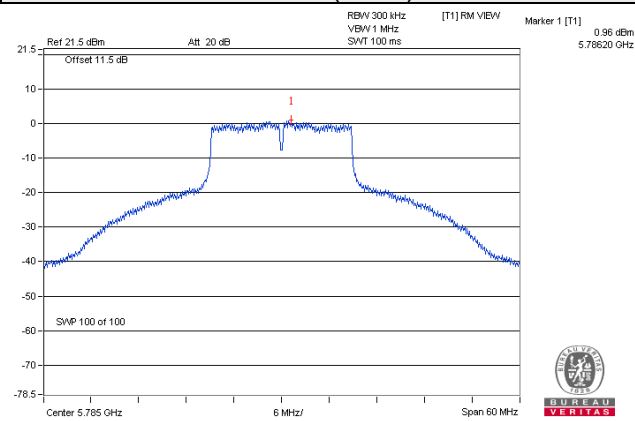
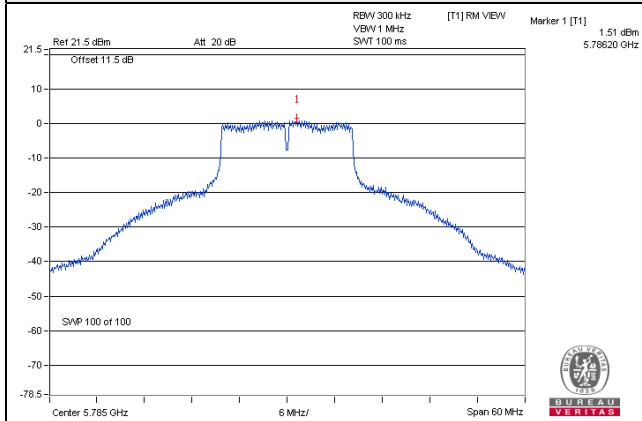

802.11n (HT40)

802.11ac (VHT80)

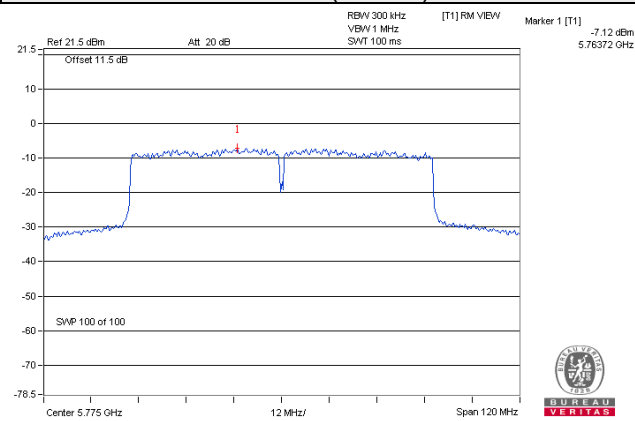
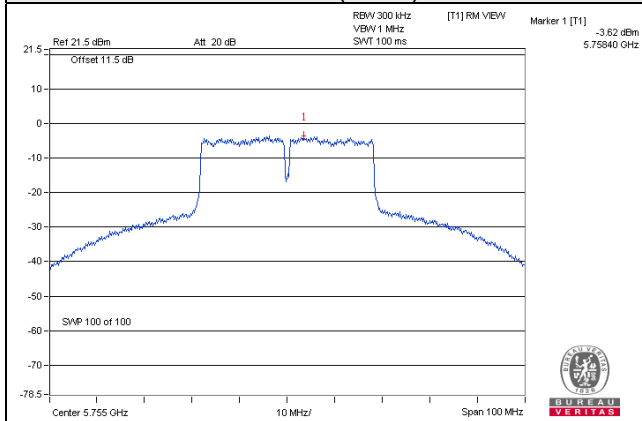

4.6 Frequency Stability

4.6.1 Limits of Frequency Stability Measurement

The frequency of the carrier signal shall be maintained within band of operation

4.6.2 Test Setup

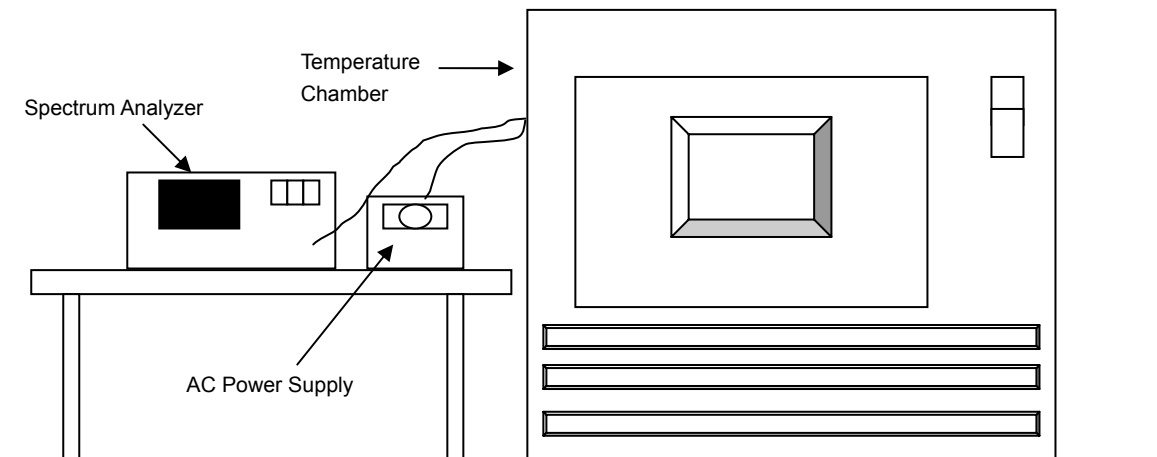

4.6.3 Test Instruments

Refer to section 4.1.2 to get information of above instrument.

4.6.4 Test Procedure

- The EUT was placed inside the environmental test chamber and powered by nominal AC voltage.
- Turn the EUT on and couple its output to a spectrum analyzer.
- Turn the EUT off and set the chamber to the highest temperature specified.
- Allow sufficient time (approximately 30 min) for the temperature of the chamber to stabilize, turn the EUT on and measure the operating frequency after 2, 5, and 10 minutes.
- Repeat step 2 and 3 with the temperature chamber set to the lowest temperature.
- The test chamber was allowed to stabilize at +20 degree C for a minimum of 30 minutes. The supply voltage was then adjusted on the EUT from 85% to 115% and the frequency record.

4.6.5 Deviation from Test Standard

No deviation.

4.6.6 EUT Operating Condition

Set the EUT transmit at un-modulation mode to test frequency stability.

4.6.7 Test Results

1TX

Frequency Stability Versus Temp.									
Operating Frequency: 5180MHz									
Temp. (°C)	Power Supply (Vac)	0 Minute		2 Minute		5 Minute		10 Minute	
		Measured Frequency (MHz)	Frequency Drift (%)	Measured Frequency (MHz)	Frequency Drift (%)	Measured Frequency (MHz)	Frequency Drift (%)	Measured Frequency (MHz)	Frequency Drift (%)
50	120	5180.0135	0.00026	5180.0158	0.00031	5180.0182	0.00035	5180.0179	0.00035
40	120	5179.9794	-0.00040	5179.9784	-0.00042	5179.9786	-0.00041	5179.9754	-0.00047
30	120	5180.0102	0.00020	5180.0088	0.00017	5180.0115	0.00022	5180.0088	0.00017
20	120	5180.0211	0.00041	5180.0208	0.00040	5180.0226	0.00044	5180.0224	0.00043
10	120	5179.9924	-0.00015	5179.992	-0.00015	5179.9949	-0.00010	5179.9947	-0.00010
0	120	5180.0123	0.00024	5180.0148	0.00029	5180.0119	0.00023	5180.0118	0.00023
-10	120	5179.9973	-0.00005	5179.9989	-0.00002	5179.9999	0.00000	5180.001	0.00002
-20	120	5179.9818	-0.00035	5179.9803	-0.00038	5179.9837	-0.00031	5179.9787	-0.00041
-30	120	5179.9995	-0.00001	5180.0023	0.00004	5180.0007	0.00001	5180.0042	0.00008

Frequency Stability Versus Voltage									
Operating Frequency: 5180MHz									
Temp. (°C)	Power Supply (Vac)	0 Minute		2 Minute		5 Minute		10 Minute	
		Measured Frequency (MHz)	Frequency Drift (%)	Measured Frequency (MHz)	Frequency Drift (%)	Measured Frequency (MHz)	Frequency Drift (%)	Measured Frequency (MHz)	Frequency Drift (%)
20	138	5180.0212	0.00041	5180.0204	0.00039	5180.0225	0.00043	5180.0234	0.00045
	120	5180.0211	0.00041	5180.0208	0.00040	5180.0226	0.00044	5180.0224	0.00043
	102	5180.0221	0.00043	5180.0199	0.00038	5180.0228	0.00044	5180.0215	0.00042

2TX

Frequency Stability Versus Temp.									
Operating Frequency: 5180MHz									
Temp. (°C)	Power Supply (Vac)	0 Minute		2 Minute		5 Minute		10 Minute	
		Measured Frequency (MHz)	Frequency Drift (%)	Measured Frequency (MHz)	Frequency Drift (%)	Measured Frequency (MHz)	Frequency Drift (%)	Measured Frequency (MHz)	Frequency Drift (%)
50	120	5179.9764	-0.00046	5179.9733	-0.00052	5179.9763	-0.00046	5179.9741	-0.00050
40	120	5179.9943	-0.00011	5179.9971	-0.00006	5179.9963	-0.00007	5179.9961	-0.00008
30	120	5179.9845	-0.00030	5179.9869	-0.00025	5179.9885	-0.00022	5179.989	-0.00021
20	120	5180.0209	0.00040	5180.0194	0.00037	5180.0195	0.00038	5180.0195	0.00038
10	120	5179.977	-0.00044	5179.9789	-0.00041	5179.975	-0.00048	5179.9748	-0.00049
0	120	5179.9784	-0.00042	5179.9758	-0.00047	5179.9777	-0.00043	5179.9788	-0.00041
-10	120	5179.9905	-0.00018	5179.99	-0.00019	5179.987	-0.00025	5179.9899	-0.00019
-20	120	5179.9851	-0.00029	5179.9834	-0.00032	5179.9824	-0.00034	5179.9857	-0.00028
-30	120	5179.999	-0.00002	5180.0002	0.00000	5179.9984	-0.00003	5179.9973	-0.00005

Frequency Stability Versus Voltage									
Operating Frequency: 5180MHz									
Temp. (°C)	Power Supply (Vac)	0 Minute		2 Minute		5 Minute		10 Minute	
		Measured Frequency (MHz)	Frequency Drift (%)	Measured Frequency (MHz)	Frequency Drift (%)	Measured Frequency (MHz)	Frequency Drift (%)	Measured Frequency (MHz)	Frequency Drift (%)
20	138	5180.0206	0.00040	5180.0188	0.00036	5180.02	0.00039	5180.019	0.00037
	120	5180.0209	0.00040	5180.0194	0.00037	5180.0195	0.00038	5180.0195	0.00038
	102	5180.0215	0.00042	5180.0199	0.00038	5180.0203	0.00039	5180.0196	0.00038

4.7 6dB Bandwidth Measurement

4.7.1 Limits of 6dB Bandwidth Measurement

The minimum of 6dB Bandwidth Measurement is 0.5MHz.

4.7.2 Test Setup

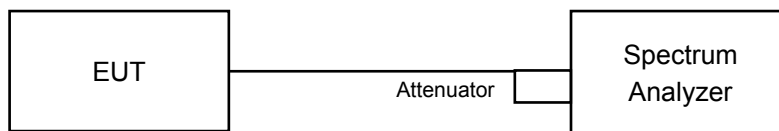

4.7.3 Test Instruments

Refer to section 4.1.2 to get information of above instrument.

4.7.4 Test Procedure

Measurement Procedure REF

- Set resolution bandwidth (RBW) = 100kHz
- Set the video bandwidth (VBW) $\geq 3 \times$ RBW, Detector = Peak.
- Trace mode = max hold.
- Sweep = auto couple.
- Measure the maximum width of the emission that is constrained by the frequencies associated with the two amplitude points (upper and lower) that are attenuated by 6 dB relative to the maximum level measured in the fundamental emission

4.7.5 Deviation from Test Standard

No deviation.

4.7.6 EUT Operating Condition

The software provided by client to enable the EUT under transmission condition continuously at lowest, middle and highest channel frequencies individually.

4.7.7 Test Results

1TX

802.11a

Channel	Frequency (MHz)	6dB Bandwidth (MHz)	Minimum Limit (MHz)	Pass / Fail
149	5745	16.38	0.5	Pass
157	5785	16.41	0.5	Pass
165	5825	16.42	0.5	Pass

802.11n (HT20)

Channel	Frequency (MHz)	6dB Bandwidth (MHz)	Minimum Limit (MHz)	Pass / Fail
149	5745	17.64	0.5	Pass
157	5785	17.64	0.5	Pass
165	5825	17.65	0.5	Pass

802.11n (HT40)

Channel	Frequency (MHz)	6dB Bandwidth (MHz)	Minimum Limit (MHz)	Pass / Fail
151	5755	36.44	0.5	Pass
159	5795	36.39	0.5	Pass

802.11ac (VHT80)

Channel	Frequency (MHz)	6dB Bandwidth (MHz)	Minimum Limit (MHz)	Pass / Fail
155	5775	75.57	0.5	Pass

Spectrum Plot of Worst Value

802.11a

802.11n (HT20)

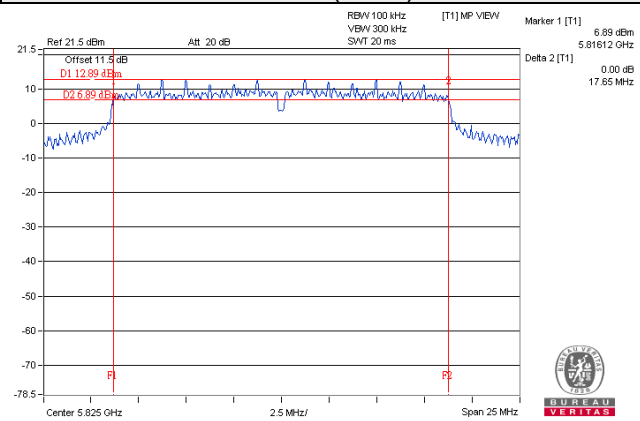
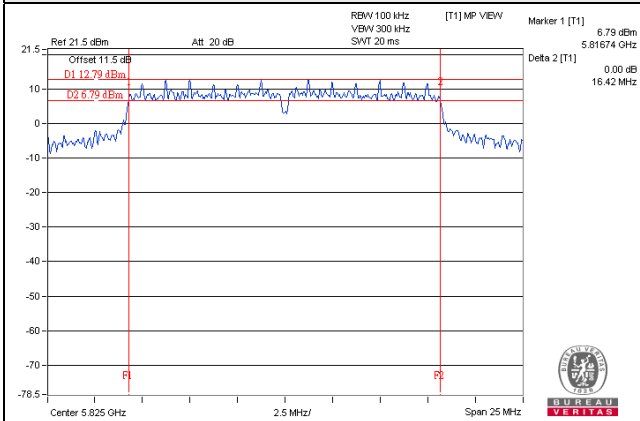

802.11n (HT40)

802.11ac (VHT80)

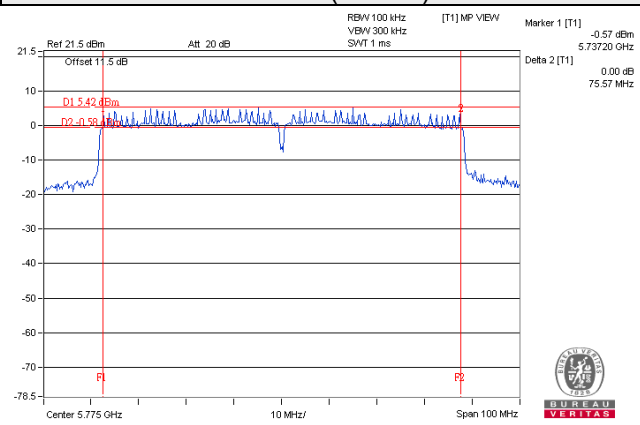
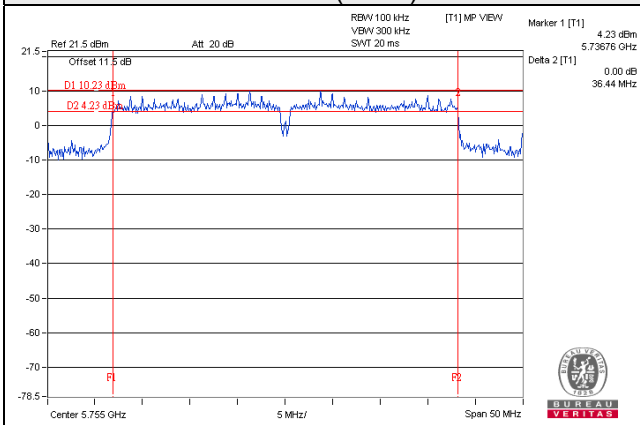

2TX

802.11a

Channel	Frequency (MHz)	6dB Bandwidth (MHz)		Minimum Limit (MHz)	Pass / Fail
		Chain 0	Chain 1		
149	5745	16.38	16.38	0.5	Pass
157	5785	16.38	16.42	0.5	Pass
165	5825	16.40	16.41	0.5	Pass

802.11n (HT20)

Channel	Frequency (MHz)	6dB Bandwidth (MHz)		Minimum Limit (MHz)	Pass / Fail
		Chain 0	Chain 1		
149	5745	17.61	17.64	0.5	Pass
157	5785	17.64	17.65	0.5	Pass
165	5825	17.64	17.65	0.5	Pass

802.11n (HT40)

Channel	Frequency (MHz)	6dB Bandwidth (MHz)		Minimum Limit (MHz)	Pass / Fail
		Chain 0	Chain 1		
151	5755	36.40	36.47	0.5	Pass
159	5795	36.38	36.45	0.5	Pass

802.11ac (VHT80)

Channel	Frequency (MHz)	6dB Bandwidth (MHz)		Minimum Limit (MHz)	Pass / Fail
		Chain 0	Chain 1		
155	5775	75.87	75.55	0.5	Pass

Spectrum Plot of Worst Value

802.11a

802.11n (HT20)

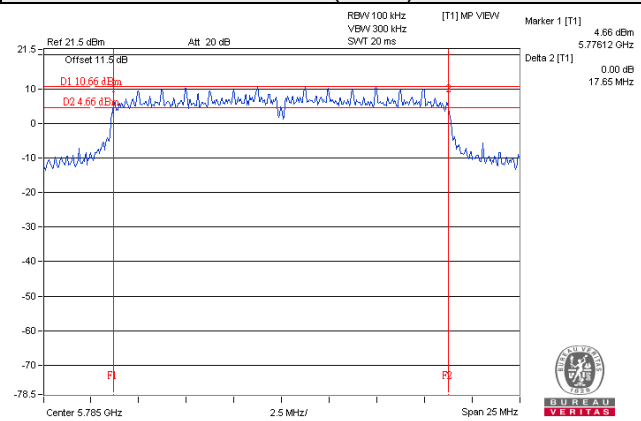
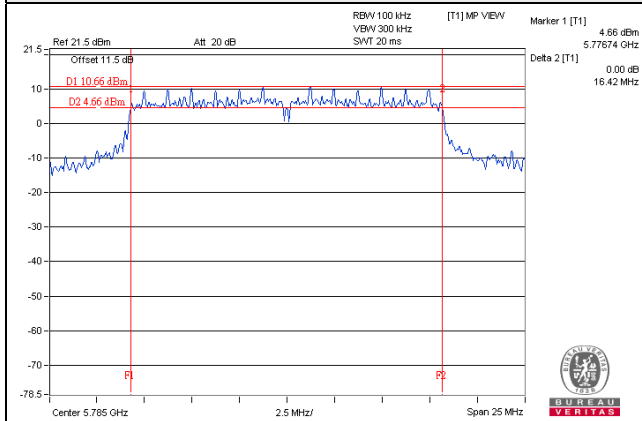

802.11n (HT40)

802.11ac (VHT80)

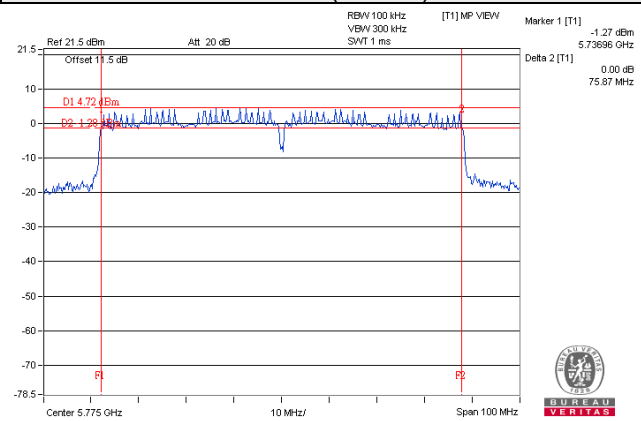
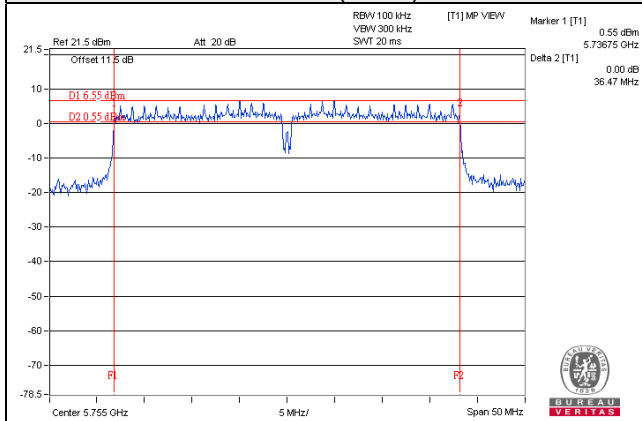

5 Pictures of Test Arrangements

Please refer to the attached file (Test Setup Photo).

Annex A- Radiated Out of Band Emission (OOBE) Measurement (For U-NII-3 band)

1TX

802.11a

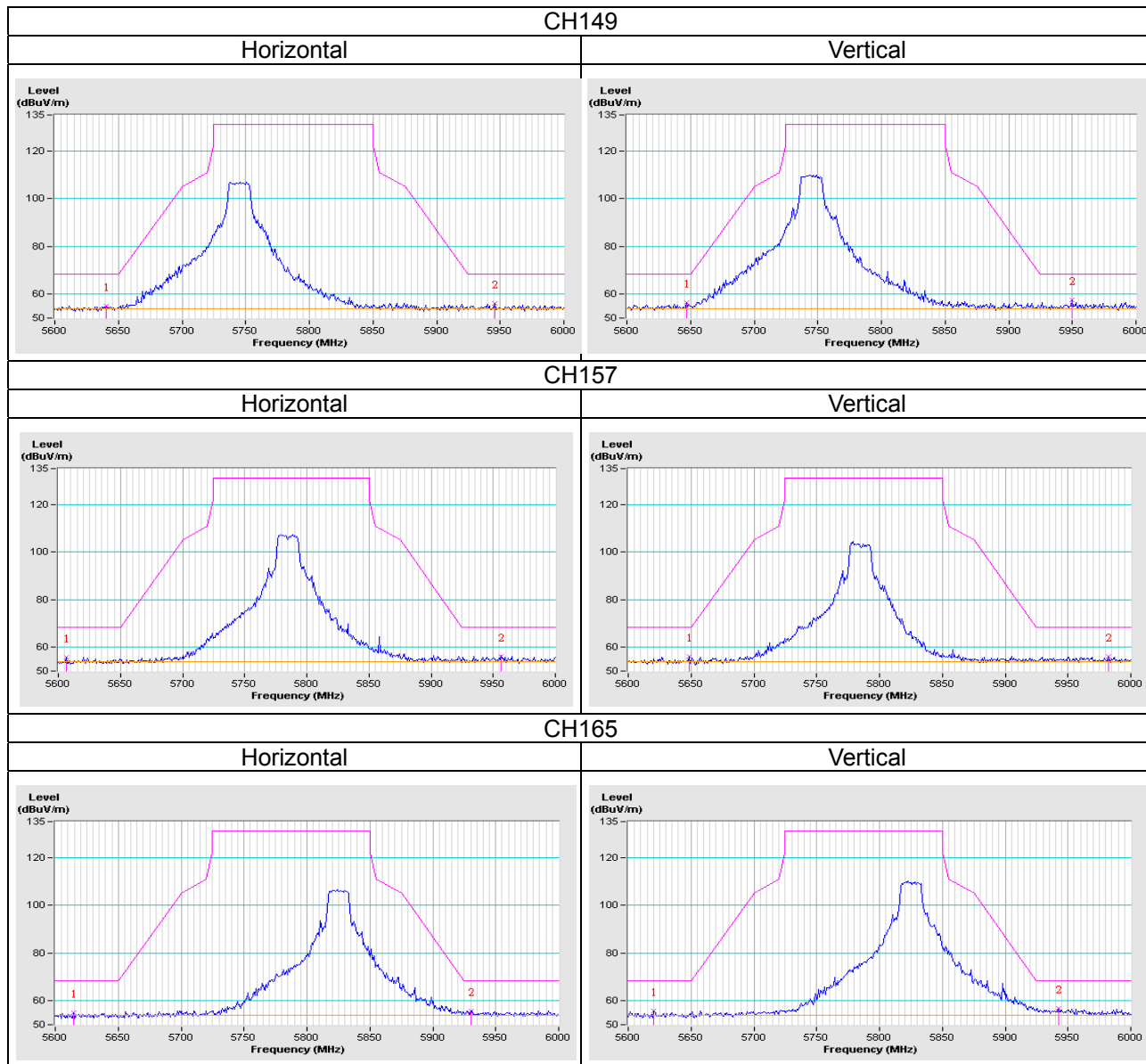

802.11n (HT20)

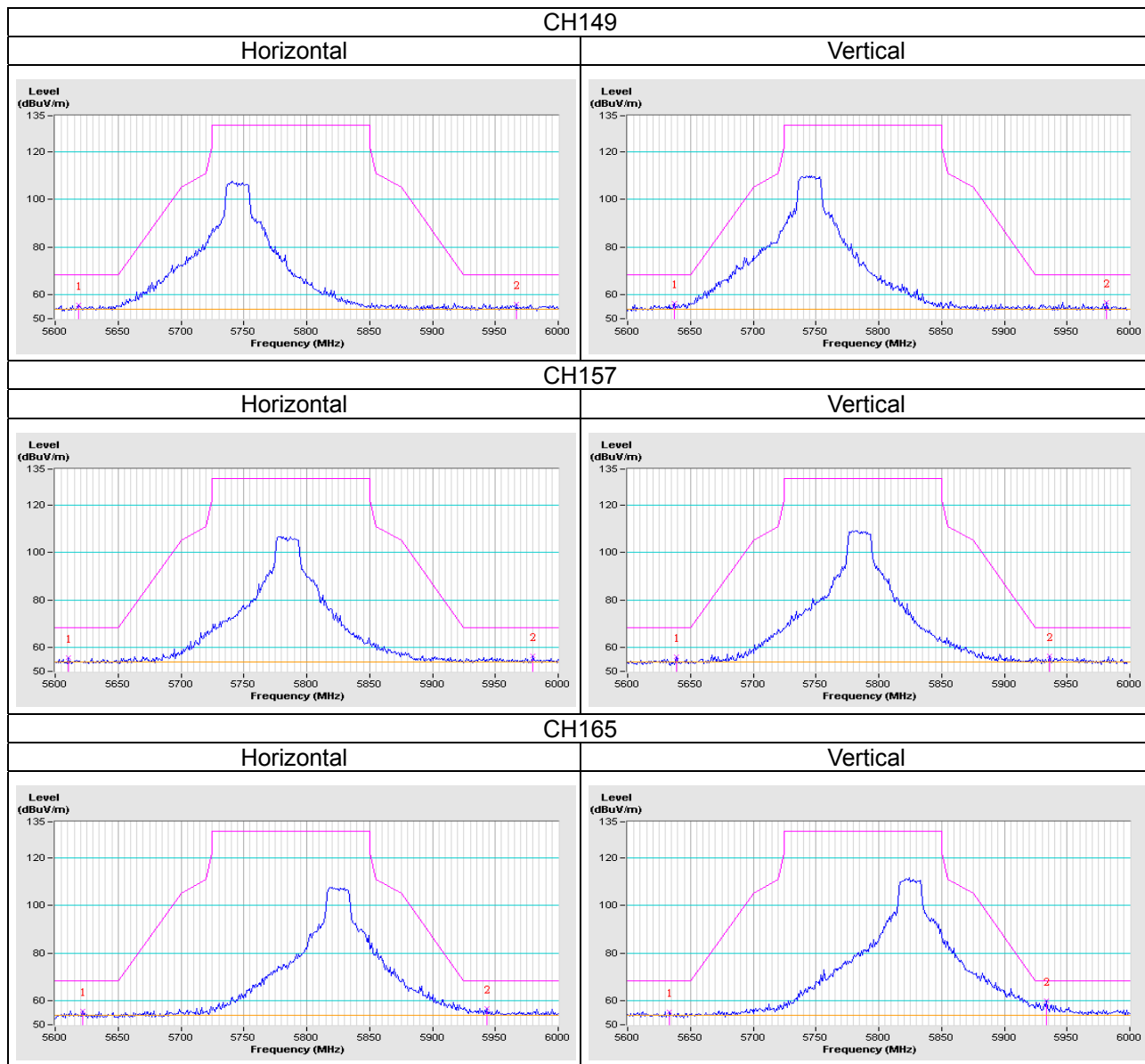

802.11n (HT40)

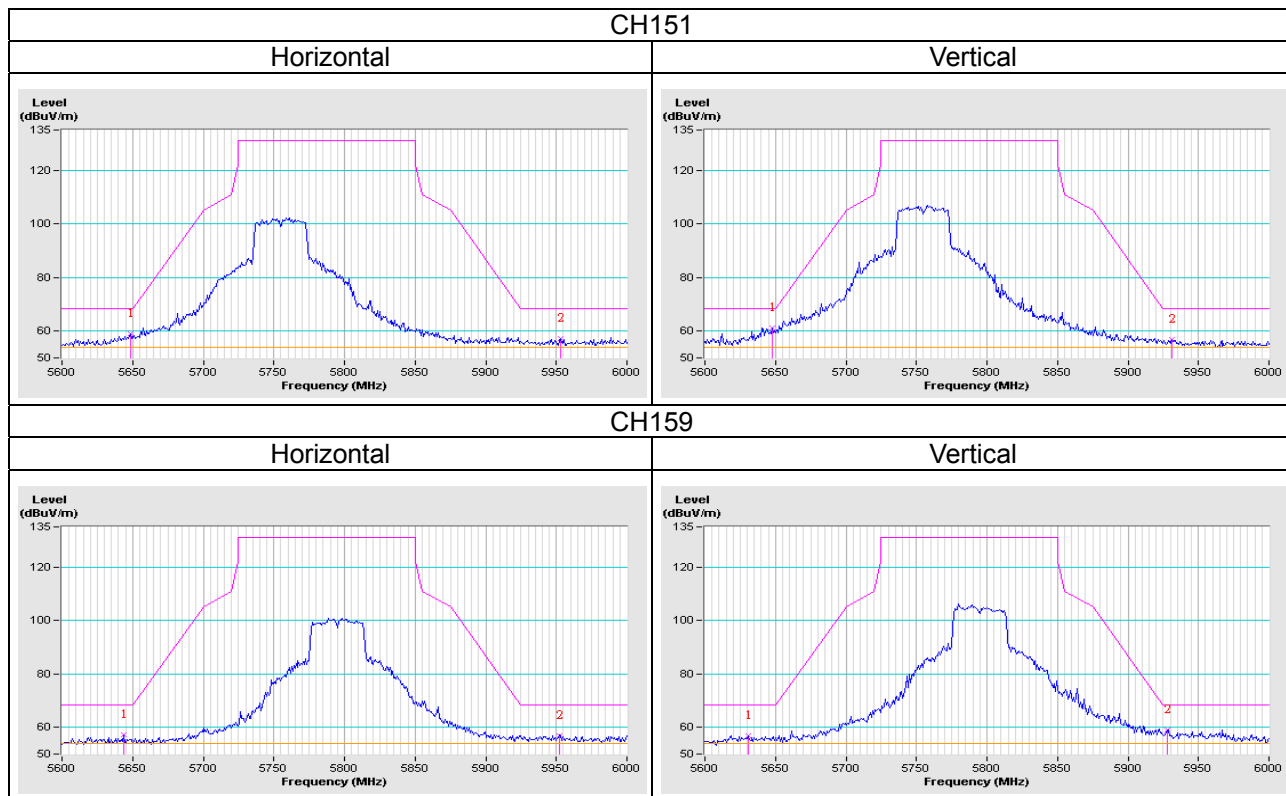

802.11ac (VHT80)

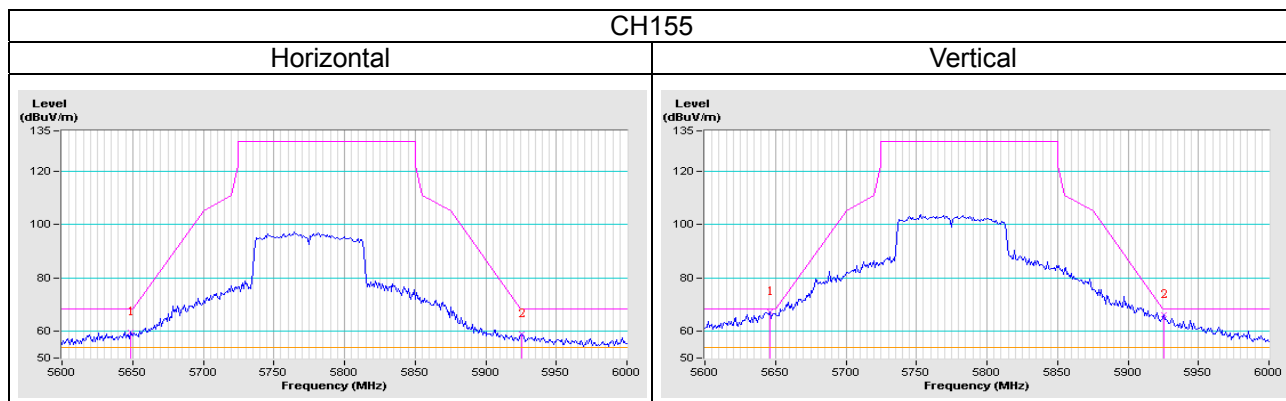

2TX
802.11a

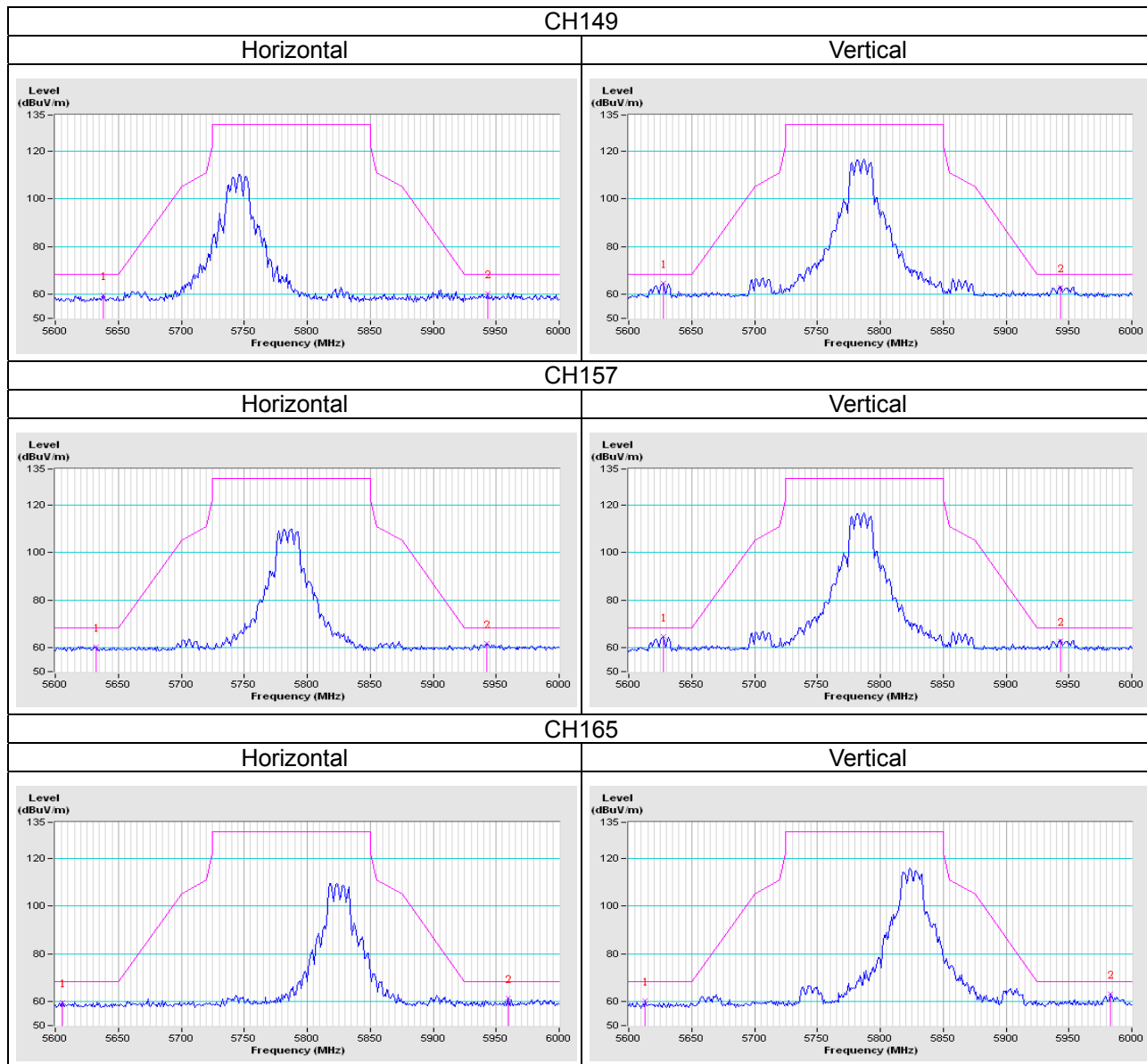

802.11n (HT20)

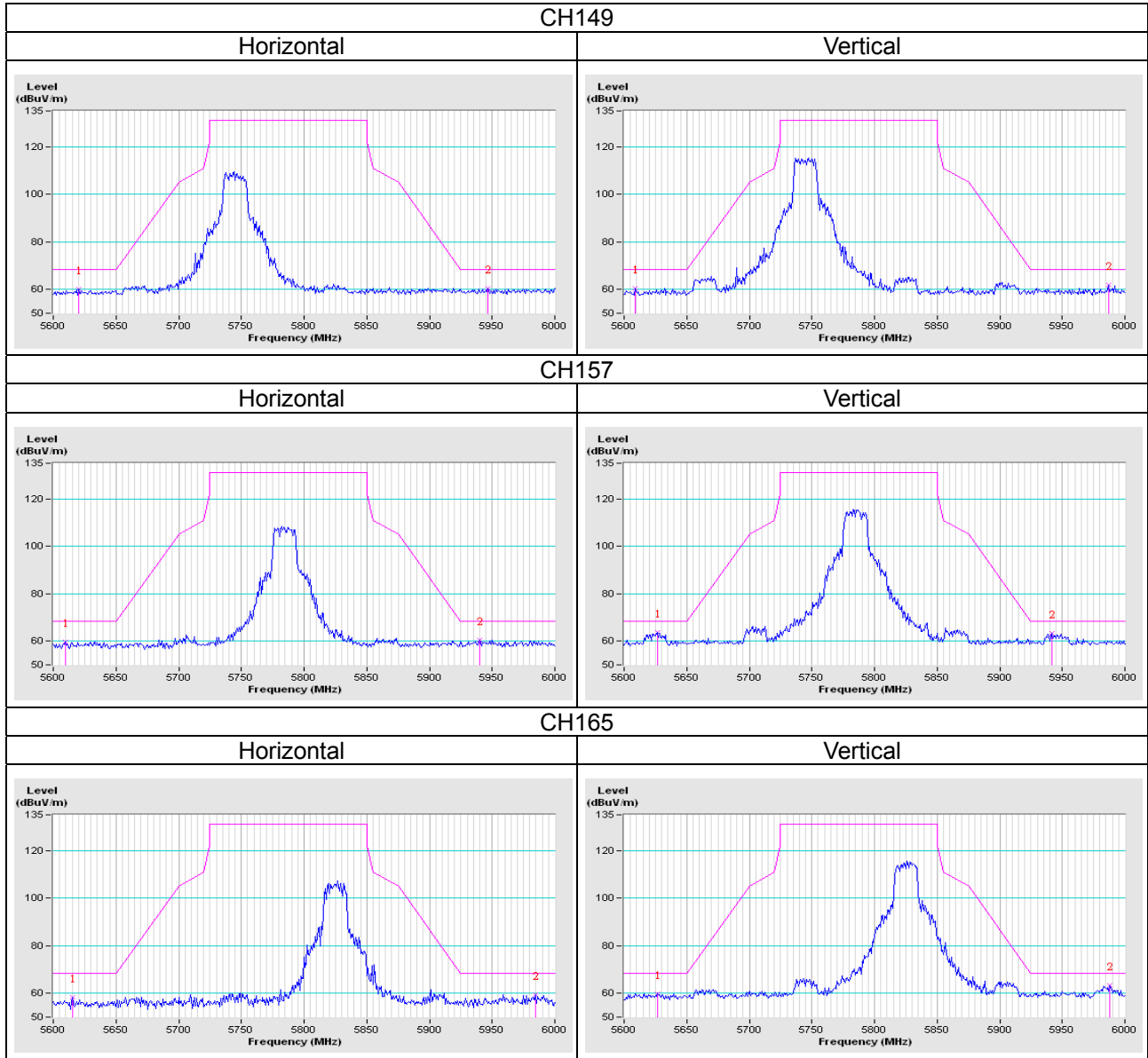

802.11n (HT40)

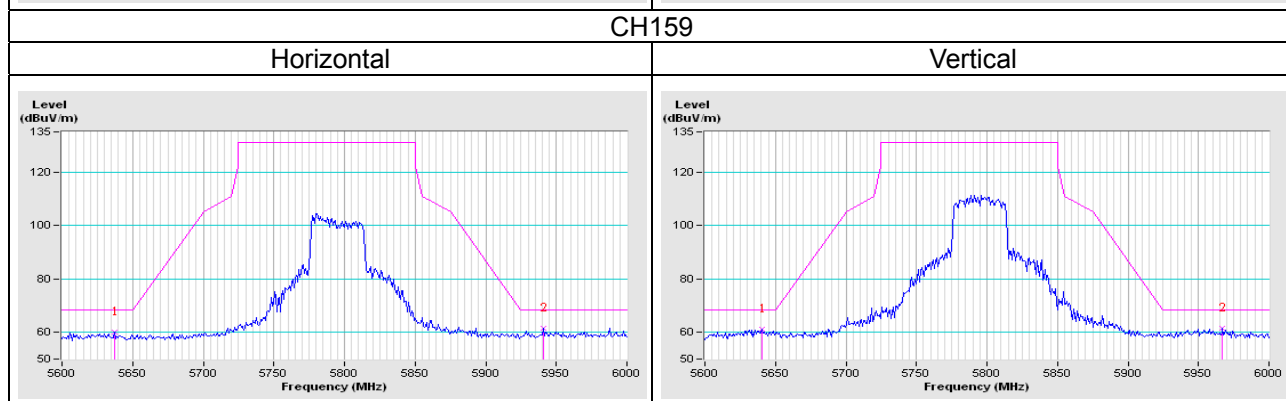
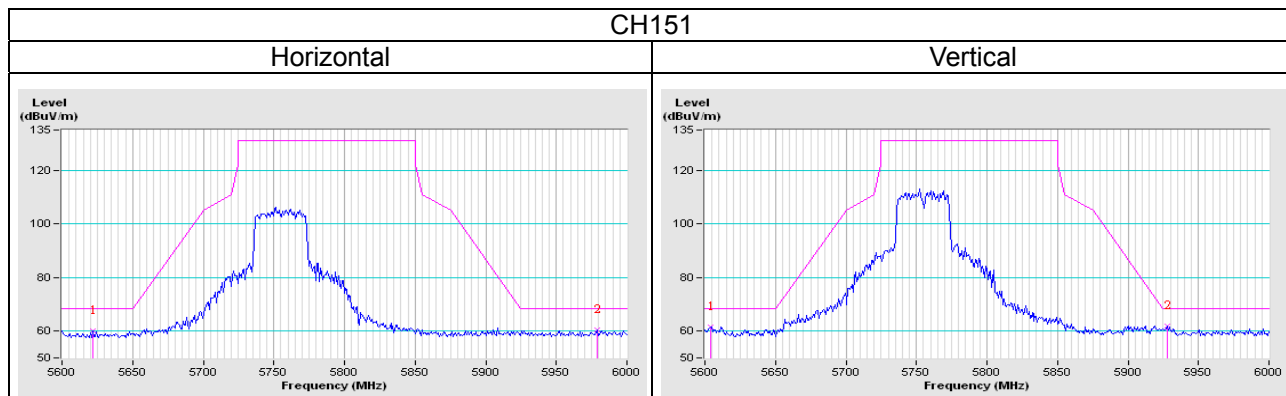

802.11ac (VHT80)

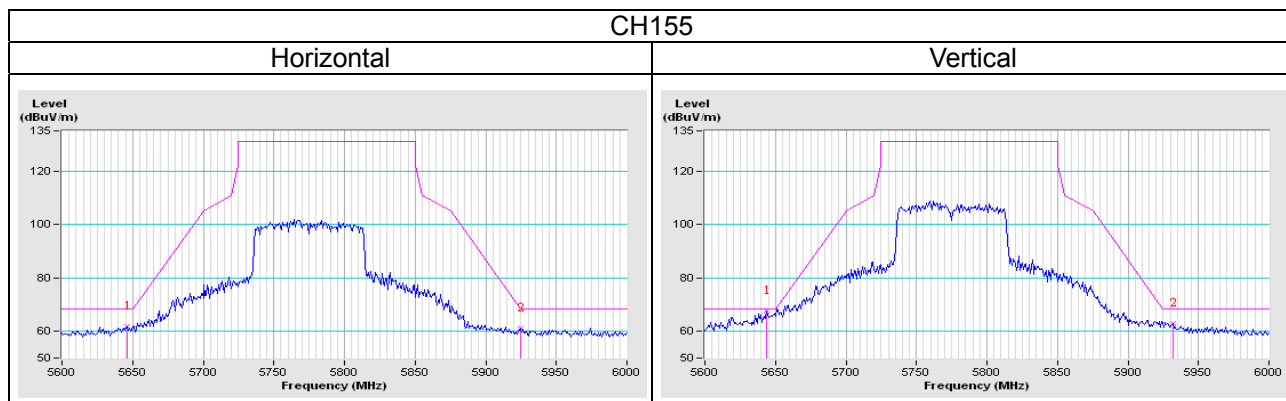

Appendix – Information on the Testing Laboratories

We, Bureau Veritas Consumer Products Services (H.K.) Ltd., Taoyuan Branch, were founded in 1988 to provide our best service in EMC, Radio, Telecom and Safety consultation. Our laboratories are accredited and approved according to ISO/IEC 17025.

If you have any comments, please feel free to contact us at the following:

Linko EMC/RF Lab

Tel: 886-2-26052180

Fax: 886-2-26051924

Hsin Chu EMC/RF/Telecom Lab

Tel: 886-3-6668565

Fax: 886-3-6668323

Hwa Ya EMC/RF/Safety

Tel: 886-3-3183232

Fax: 886-3-3270892

Email: service.adt@tw.bureauveritas.com

Web Site: www.bureauveritas-adt.com

The address and road map of all our labs can be found in our web site also.

--- END ---