

FCC Test Report

Report No.: RF170505C03

FCC ID: 2AHBN-AP21

Test Model: AP21

Received Date: May 05, 2017

Test Date: May 10 ~ Jun. 28, 2017

Issued Date: Jul. 13, 2017

Applicant: Mist Systems, Inc.

Address: 1601 South De Anza Blvd. Suite 248 Cupertino California United States
95014

Issued By: Bureau Veritas Consumer Products Services (H.K.) Ltd., Taoyuan Branch

Lab Address: No. 47-2, 14th Ling, Chia Pau Vil., Lin Kou Dist., New Taipei City, Taiwan
(R.O.C.)

Test Location: No. 19, Hwa Ya 2nd Rd., Wen Hwa Vil., Kwei Shan Dist., Taoyuan City
33383, TAIWAN (R.O.C.)



This report is for your exclusive use. Any copying or replication of this report to or for any other person or entity, or use of our name or trademark, is permitted only with our prior written permission. This report sets forth our findings solely with respect to the test samples identified herein. The results set forth in this report are not indicative or representative of the quality or characteristics of the lot from which a test sample was taken or any similar or identical product unless specifically and expressly noted. Our report includes all of the tests requested by you and the results thereof based upon the information that you provided to us. You have 60 days from date of issuance of this report to notify us of any material error or omission caused by our negligence, provided, however, that such notice shall be in writing and shall specifically address the issue you wish to raise. A failure to raise such issue within the prescribed time shall constitute your unqualified acceptance of the completeness of this report, the tests conducted and the correctness of the report contents. Unless specific mention, the uncertainty of measurement has been explicitly taken into account to declare the compliance or non-compliance to the specification. This report should not be used by the client to claim product certification, approval, or endorsement by TAF or any government agencies.

Table of Contents

Release Control Record	4
1 Certificate of Conformity	5
2 Summary of Test Results	6
2.1 Measurement Uncertainty.....	6
2.2 Modification Record.....	6
3 General Information	7
3.1 General Description of EUT.....	7
3.2 Description of Test Modes.....	9
3.2.1 Test Mode Applicability and Tested Channel Detail.....	10
3.3 Duty Cycle of Test Signal.....	12
3.4 Description of Support Units.....	14
3.4.1 Configuration of System under Test.....	14
3.5 General Description of Applied Standards.....	15
4 Test Types and Results	16
4.1 Radiated Emission and Bandedge Measurement.....	16
4.1.1 Limits of Radiated Emission and Bandedge Measurement.....	16
4.1.2 Test Instruments.....	17
4.1.3 Test Procedures.....	18
4.1.4 Deviation from Test Standard.....	18
4.1.5 Test Setup.....	19
4.1.6 EUT Operating Conditions.....	20
4.1.7 Test Results.....	21
4.2 Conducted Emission Measurement.....	47
4.2.1 Limits of Conducted Emission Measurement.....	47
4.2.2 Test Instruments.....	47
4.2.3 Test Procedures.....	48
4.2.4 Deviation from Test Standard.....	48
4.2.5 Test Setup.....	48
4.2.6 EUT Operating Conditions.....	48
4.2.7 Test Results.....	49
4.3 6dB Bandwidth Measurement.....	53
4.3.1 Limits of 6dB Bandwidth Measurement.....	53
4.3.2 Test Setup.....	53
4.3.3 Test Instruments.....	53
4.3.4 Test Procedure.....	53
4.3.5 Deviation from Test Standard.....	53
4.3.6 EUT Operating Conditions.....	53
4.3.7 Test Result.....	54
4.4 Conducted Output Power Measurement.....	58
4.4.1 Limits of Conducted Output Power Measurement.....	58
4.4.2 Test Setup.....	58
4.4.3 Test Instruments.....	58
4.4.4 Test Procedures.....	58
4.4.5 Deviation from Test Standard.....	58
4.4.6 EUT Operating Conditions.....	58
4.4.7 Test Results.....	59
4.5 Power Spectral Density Measurement.....	62
4.5.1 Limits of Power Spectral Density Measurement.....	62
4.5.2 Test Setup.....	62
4.5.3 Test Instruments.....	62
4.5.4 Test Procedure.....	62
4.5.5 Deviation from Test Standard.....	62
4.5.6 EUT Operating Condition.....	62

4.5.7 Test Results	63
4.6 Conducted Out of Band Emission Measurement.....	68
4.6.1 Limits of Conducted Out of Band Emission Measurement	68
4.6.2 Test Setup.....	68
4.6.3 Test Instruments	68
4.6.4 Test Procedure	68
4.6.5 Deviation from Test Standard	69
4.6.6 EUT Operating Condition	69
4.6.7 Test Results	69
5 Pictures of Test Arrangements.....	82
Appendix – Information on the Testing Laboratories	83

Release Control Record

Issue No.	Description	Date Issued
RF170505C03	Original release.	Jul. 13, 2017

1 Certificate of Conformity

Product: Wi-Fi & BLE Array AP

Brand: Mist

Test Model: AP21

Sample Status: Engineering sample

Applicant: Mist Systems, Inc.

Test Date: May 10 ~ Jun. 28, 2017

Standards: 47 CFR FCC Part 15, Subpart C (Section 15.247)
ANSI C63.10:2013

The above equipment has been tested by **Bureau Veritas Consumer Products Services (H.K.) Ltd., Taoyuan Branch**, and found compliance with the requirement of the above standards. The test record, data evaluation & Equipment Under Test (EUT) configurations represented herein are true and accurate accounts of the measurements of the sample's EMC characteristics under the conditions specified in this report.

Prepared by :  , **Date:** Jul. 13, 2017
Polly Chien / Specialist

Approved by :  , **Date:** Jul. 13, 2017
Ken Liu / Senior Manager

2 Summary of Test Results

47 CFR FCC Part 15, Subpart C (Section 15.247)			
FCC Clause	Test Item	Result	Remarks
15.207	AC Power Conducted Emission	Pass	Meet the requirement of limit. Minimum passing margin is -4.95dB at 16.91800MHz.
15.205 / 15.209 / 15.247(d)	Radiated Emissions and Band Edge Measurement	Pass	Meet the requirement of limit. Minimum passing margin is -0.5dB at 2483.50 & 2390.00MHz.
15.247(d)	Antenna Port Emission	Pass	Meet the requirement of limit.
15.247(a)(2)	6dB bandwidth	Pass	Meet the requirement of limit.
15.247(b)	Conducted power	Pass	Meet the requirement of limit.
15.247(e)	Power Spectral Density	Pass	Meet the requirement of limit.
15.203	Antenna Requirement	Pass	Antenna connector is IPEX not a standard connector.

2.1 Measurement Uncertainty

Where relevant, the following measurement uncertainty levels have been estimated for tests performed on the EUT as specified in CISPR 16-4-2:

Measurement	Frequency	Expanded Uncertainty (k=2) (\pm)
Conducted Emissions at mains ports	150kHz ~ 30MHz	2.94 dB
Radiated Emissions up to 1 GHz	30MHz ~ 200MHz	3.63 dB
	200MHz ~ 1000MHz	3.64 dB
Radiated Emissions above 1 GHz	1GHz ~ 18GHz	2.29 dB
	18GHz ~ 40GHz	2.29 dB

2.2 Modification Record

There were no modifications required for compliance.

3 General Information

3.1 General Description of EUT

Product	Wi-Fi & BLE Array AP
Brand	Mist
Test Model	AP21
Sample Status	Engineering sample
Power Supply Rating	12Vdc (adapter) 55Vdc (POE)
Modulation Type	CCK, DQPSK, DBPSK for DSSS 64QAM, 16QAM, QPSK, BPSK for OFDM
Modulation Technology	DSSS, OFDM
Transfer Rate	802.11b: 11/5.5/2/1Mbps 802.11g: 54/48/36/24/18/12/9/6Mbps 802.11n: up to 300Mbps
Operating Frequency	2412 ~ 2462MHz
Number of Channel	802.11b, 802.11g, 802.11n (HT20): 11 802.11n (HT40): 7
Output Power	CDD Mode, 1TX: 191.426mW CDD Mode, 2TX: 345.616mW Beamforming Mode, 2TX: 90.065mW
Antenna Type	Refer to Note
Antenna Connector	Refer to Note
Accessory Device	NA
Cable Supplied	NA

Note:

- The EUT incorporates a MIMO function. Physically, the EUT provides 2 completed transmitters and 2 receivers.

Modulation Mode	TX Function	Beamforming
802.11b	1TX/2TX	Not Support
802.11g	1TX/2TX	Not Support
802.11n (HT20)	1TX/2TX	Support
802.11n (HT40)	1TX/2TX	Support

- There are three radios for the EUT.

Radio	Antenna	Brand	Model	Function
Radio 1	WIFI Ant. 1	WNC	81EAAH15.GEP	WLAN 2.4G & 5G (RX only)
	WIFI Ant. 2	WNC	81EAAH15.GEQ	
Radio 2	WIFI Ant. 1	WNC	81EAAH15.GER	WLAN 5G
	WIFI Ant. 2	WNC	81EAAH15.GES	
Radio 3	BT-Omni Ant.	WNC	81EAAH15.GET	BT LE

3. The following antennas were provided to the EUT.

Antenna Type	PIFA			
Antenna Connector	IPEX			
Gain (dBi)	Frequency			
	2.4~2.5GHz	5.15GHz	5.55GHz	5.85GHz
Radio1: WIFI Ant. 1	3.43	4.85	4.86	4.91
Radio1: WIFI Ant. 2	3.63	3.61	4.45	4.95
Radio2: WIFI Ant. 1	-	4.93	4.51	4.96
Radio2: WIFI Ant. 2	-	4.78	4.62	4.96

4. The EUT uses following adapter & PoE. (Support unit only)

Adapter	
Brand	Channel Well Technology
Model	2ABN036F US
Input Power	100-240Vac~50/60Hz 1.0A
Output Power	12.0Vdc / 3.0A
Power Line	1.45m DC cable without core attached on adapter

PoE	
Brand	Microsemi
Model	PD-9001GR/AT/AC
Input Power	100-240Vac~50/60Hz 0.67A
Output Power	55Vdc / 0.6A

5. Spurious emission of the simultaneous operation (2.4GHz, 5GHz and BT) has been evaluated and no non-compliance was found.

3.2 Description of Test Modes

11 channels are provided for 802.11b, 802.11g and 802.11n (HT20):

Channel	Frequency	Channel	Frequency
1	2412MHz	7	2442MHz
2	2417MHz	8	2447MHz
3	2422MHz	9	2452MHz
4	2427MHz	10	2457MHz
5	2432MHz	11	2462MHz
6	2437MHz		

7 channels are provided for 802.11n (HT40):

Channel	Frequency	Channel	Frequency
3	2422MHz	7	2442MHz
4	2427MHz	8	2447MHz
5	2432MHz	9	2452MHz
6	2437MHz		

3.2.1 Test Mode Applicability and Tested Channel Detail

EUT Configure Mode	Applicable to				Description
	RE \geq 1G	RE<1G	PLC	APCM	
A	√	√	√	√	Power from adapter
B	-	√	√	-	Power from PoE

Where RE \geq 1G: Radiated Emission above 1GHz & Bandedge Measurement
 RE<1G: Radiated Emission below 1GHz
 PLC: Power Line Conducted Emission
 APCM: Antenna Port Conducted Measurement

Note:

- The antenna had been pre-tested on the positioned of each 3 axis. The worst cases were found when positioned on X-plane.
- "-" means no effect.

Radiated Emission Test (Above 1GHz):

- Pre-Scan has been conducted to determine the worst-case mode from all possible combinations between available modulations, data rates and antenna ports (if EUT with antenna diversity architecture).
- Following channel(s) was (were) selected for the final test as listed below.

EUT Configure Mode	Mode	Available Channel	Tested Channel	Modulation Technology	Modulation Type	Data Rate (Mbps)	Remark
A	802.11b	1 to 11	1, 6, 11	DSSS	DBPSK	1.0	1TX / 2TX
A	802.11g	1 to 11	1, 6, 11	OFDM	BPSK	6.0	1TX / 2TX
A	802.11n (HT20)	1 to 11	1, 6, 11	OFDM	BPSK	6.5 / 7.2	1TX / 2TX
A	802.11n (HT40)	3 to 9	3, 6, 9	OFDM	BPSK	13.5 / 15.0	1TX / 2TX

Radiated Emission Test (Below 1GHz):

- Pre-Scan has been conducted to determine the worst-case mode from all possible combinations between available modulations, data rates and antenna ports (if EUT with antenna diversity architecture).
- Following channel(s) was (were) selected for the final test as listed below.

EUT Configure Mode	Mode	Available Channel	Tested Channel	Modulation Technology	Modulation Type	Data Rate (Mbps)	Remark
A, B	802.11b	1 to 11	6	DSSS	DBPSK	1.0	2TX

Power Line Conducted Emission Test:

- Pre-Scan has been conducted to determine the worst-case mode from all possible combinations between available modulations, data rates and antenna ports (if EUT with antenna diversity architecture).
- Following channel(s) was (were) selected for the final test as listed below.

EUT Configure Mode	Mode	Available Channel	Tested Channel	Modulation Technology	Modulation Type	Data Rate (Mbps)	Remark
A, B	802.11b	1 to 11	6	DSSS	DBPSK	1.0	2TX

Antenna Port Conducted Measurement:

- This item includes all test value of each mode, but only includes spectrum plot of worst value of each mode.
- Pre-Scan has been conducted to determine the worst-case mode from all possible combinations between available modulations, data rates and antenna ports (if EUT with antenna diversity architecture).
- Following channel(s) was (were) selected for the final test as listed below.

EUT Configure Mode	Mode	Available Channel	Tested Channel	Modulation Technology	Modulation Type	Data Rate (Mbps)	Remark
A	802.11b	1 to 11	1, 6, 11	DSSS	DBPSK	1.0	1TX / 2TX
A	802.11g	1 to 11	1, 6, 11	OFDM	BPSK	6.0	1TX / 2TX
A	802.11n (HT20)	1 to 11	1, 6, 11	OFDM	BPSK	6.5 / 7.2	1TX / 2TX
A	802.11n (HT40)	3 to 9	3, 6, 9	OFDM	BPSK	13.5 / 15.0	1TX / 2TX

Test Condition:

Applicable to	Environmental Conditions	Input Power (System)	Tested by
RE \geq 1G	20 deg. C, 69% RH 25 deg. C, 69% RH	120Vac, 60Hz	Bond Tseng, Chris Lin
RE<1G	25 deg. C, 70% RH	120Vac, 60Hz 55Vdc	Matthew Yang
PLC	25 deg. C, 70% RH	120Vac, 60Hz 55Vdc	Matthew Yang
APCM	25 deg. C, 60% RH	120Vac, 60Hz	Ted Wu

3.3 Duty Cycle of Test Signal

Duty cycle of test signal is $\geq 98\%$, duty factor is not required.

Duty cycle of test signal is $< 98\%$, duty factor is required.

1TX

802.11b: Duty cycle = 100%

802.11g: Duty cycle = $1.417/1.452 = 0.976$, Duty factor = $10 * \log(1/0.976) = 0.11$

802.11n (HT20): Duty cycle = $1.325/1.368 = 0.969$, Duty factor = $10 * \log(1/0.969) = 0.14$

802.11n (HT40): Duty cycle = $0.655/0.695 = 0.942$, Duty factor = $10 * \log(1/0.942) = 0.26$

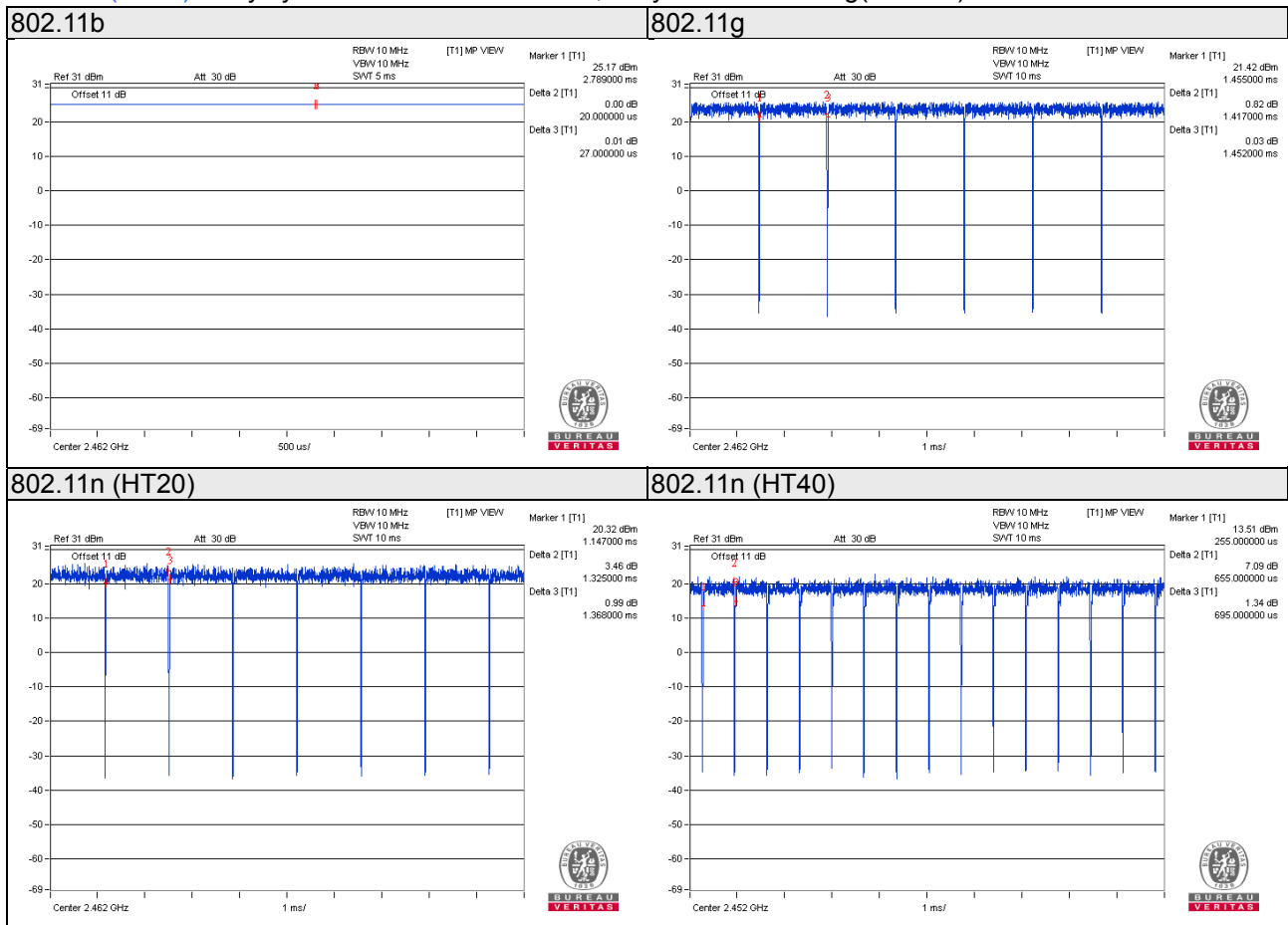

2TX

802.11b: Duty cycle = Duty cycle = 100%

802.11g: Duty cycle = $1.420/1.465 = 0.969$, Duty factor = $10 * \log(1/0.969) = 0.14$

802.11n (HT20): Duty cycle = $1.334/1.357 = 0.983$

802.11n (HT40): Duty cycle = $0.662/0.687 = 0.964$, Duty factor = $10 * \log(1/0.964) = 0.16$

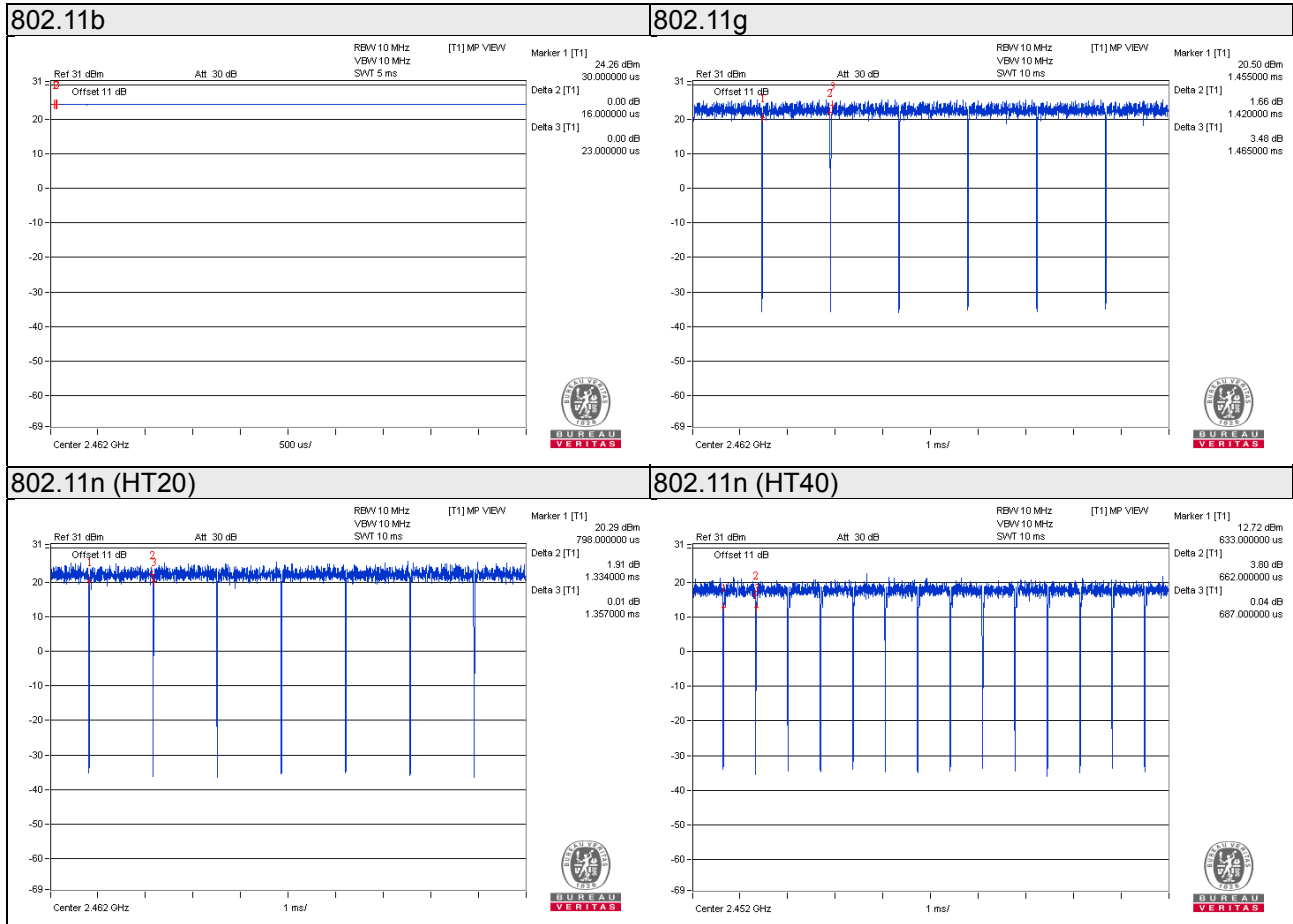

3.4 Description of Support Units

The EUT has been tested as an independent unit together with other necessary accessories or support units. The following support units or accessories were used to form a representative test configuration during the tests.

ID	Product	Brand	Model No.	Serial No.	FCC ID	Remarks
A.	Notebook	DELL	E5410	6RP2YM1	FCC DoC Approved	-
B.	Adapter	Channel Well Technology	2ABN036F US	N/A	N/A	Provided by client
C.	Load	N/A	N/A	N/A	N/A	-
D.	PoE	Microsemi	PD-9001GR/AT/AC	N/A	N/A	Provided by client

Note:

1. All power cords of the above support units are non-shielded (1.8m).
2. Item A acted as communication partner to transfer data.

ID	Descriptions	Qty.	Length (m)	Shielding (Yes/No)	Cores (Qty.)	Remarks
1.	RJ45 cable	1	10	N	0	-
2.	RJ45 cable	1	1.8	N	0	-
3.	DC cable	1	1.45	-	0	attached on adapter
4.	RJ45 cable	1	3	N	0	-

3.4.1 Configuration of System under Test

Test Mode A

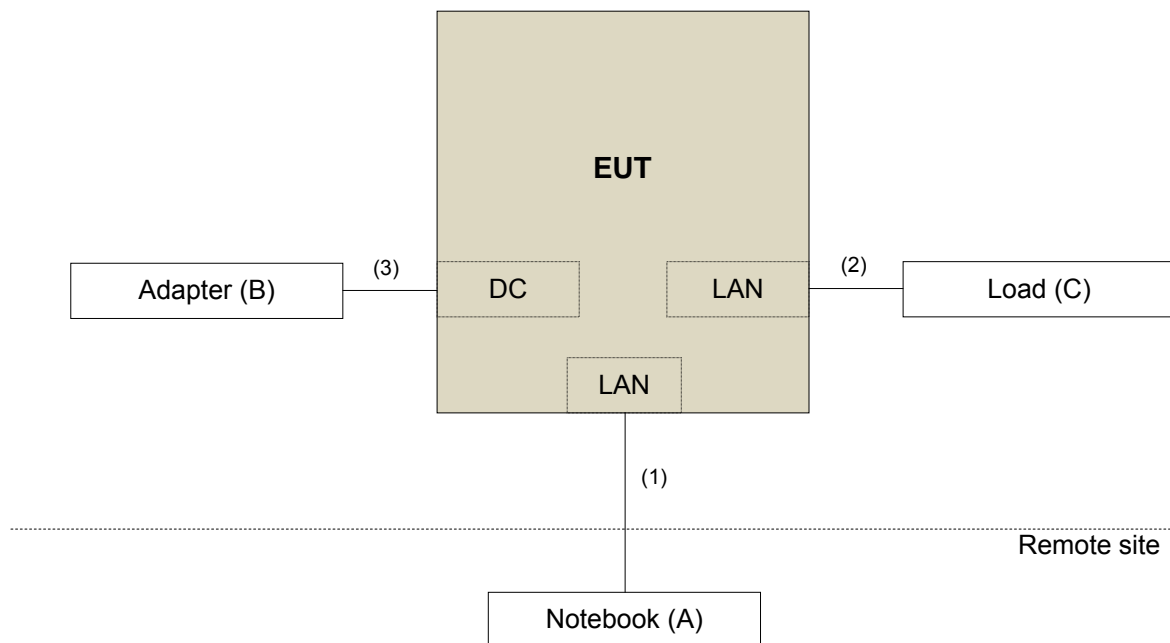

Test Mode B

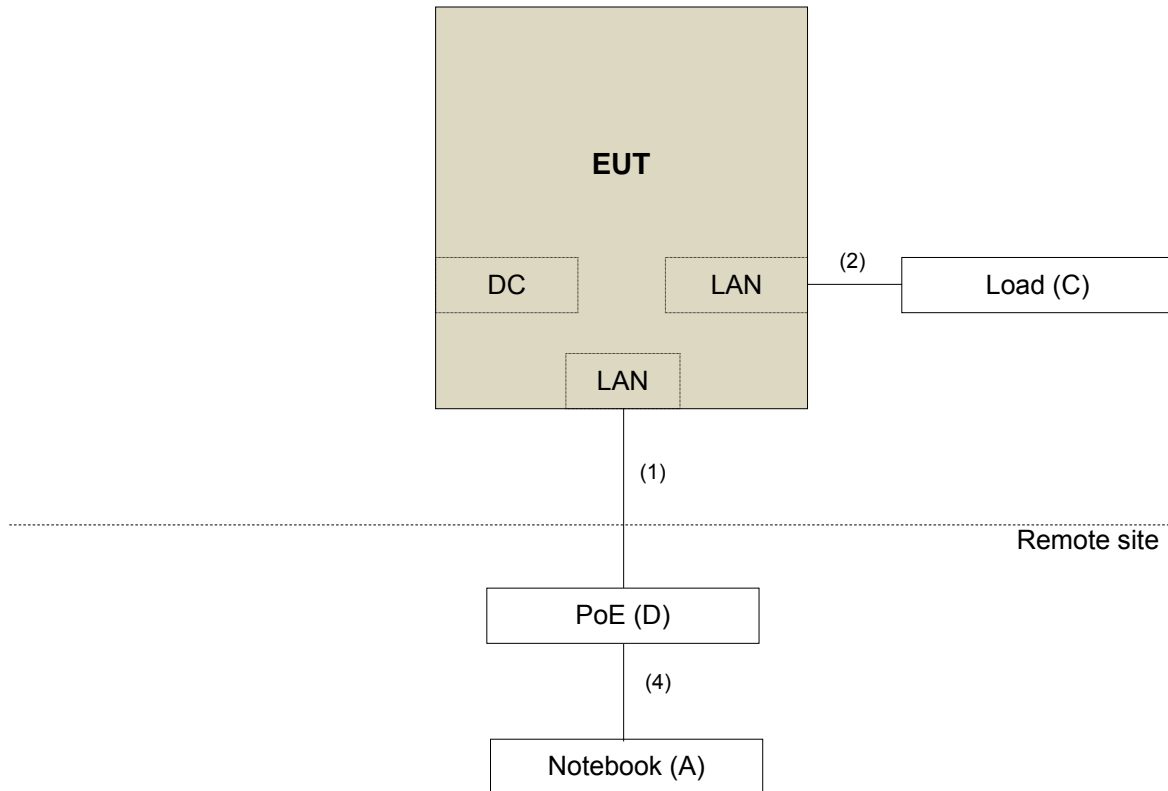

3.5 General Description of Applied Standards

The EUT is a RF Product. According to the specifications of the manufacturer, it must comply with the requirements of the following standards:

FCC Part 15, Subpart C (15.247)
KDB 558074 D01 DTS Meas Guidance v04
KDB 662911 D01 Multiple Transmitter Output v02r01
 ANSI C63.10-2013

All test items have been performed and recorded as per the above standards.

Note: The EUT has been verified to comply with the requirements of FCC Part 15, Subpart B, Class B (DoC).
 The test report has been issued separately.

4 Test Types and Results

4.1 Radiated Emission and Bandedge Measurement

4.1.1 Limits of Radiated Emission and Bandedge Measurement

Radiated emissions which fall in the restricted bands must comply with the radiated emission limits specified as below table. Other emissions shall be at least 30dB below the highest level of the desired power:

Frequencies (MHz)	Field Strength (microvolts/meter)	Measurement Distance (meters)
0.009 ~ 0.490	2400/F(kHz)	300
0.490 ~ 1.705	24000/F(kHz)	30
1.705 ~ 30.0	30	30
30 ~ 88	100	3
88 ~ 216	150	3
216 ~ 960	200	3
Above 960	500	3

Note:

1. The lower limit shall apply at the transition frequencies.
2. Emission level (dBuV/m) = 20 log Emission level (uV/m).
3. For frequencies above 1000MHz, the field strength limits are based on average detector, however, the peak field strength of any emission shall not exceed the maximum permitted average limits, specified above by more than 30dB under any condition of modulation.

4.1.2 Test Instruments

Description & Manufacturer	Model No.	Serial No.	Cal. Date	Cal. Due
Test Receiver ROHDE & SCHWARZ	ESCI	100424	Oct. 24, 2016	Oct. 23, 2017
Spectrum Analyzer ROHDE & SCHWARZ	FSP40	100040	Aug. 16, 2016	Aug. 15, 2017
BILOG Antenna SCHWARZBECK	VULB9168	9168-155	Dec. 28, 2016	Dec. 27, 2017
HORN Antenna SCHWARZBECK	BBHA 9120D	9120D-1170	Dec. 15, 2016	Dec. 14, 2017
HORN Antenna SCHWARZBECK	BBHA 9170	BBHA9170241	Dec. 14, 2016	Dec. 13, 2017
Loop Antenna	EM-6879	269	Aug. 11, 2016	Aug. 10, 2017
Preamplifier Agilent	8449B	3008A01960	Aug. 09, 2016	Aug. 08, 2017
Preamplifier Agilent	8447D	2944A10631	Aug. 09, 2016	Aug. 08, 2017
RF signal cable HUBER+SUHNER	SUCOFLEX 104	MY 13380+295012/04	Aug. 09, 2016	Aug. 08, 2017
RF signal cable HUBER+SUHNER	SUCOFLEX 104	Cable-CH4-03 (250724)	Aug. 09, 2016	Aug. 08, 2017
Software BV ADT	ADT_Radiated_ V7.6.15.9.4	NA	NA	NA
Antenna Tower inn-co GmbH	MA 4000	010303	NA	NA
Antenna Tower Controller BV ADT	AT100	AT93021703	NA	NA
Turn Table BV ADT	TT100	TT93021703	NA	NA
Turn Table Controller BV ADT	SC100	SC93021703	NA	NA
High Speed Peak Power Meter	ML2495A	0824012	Aug. 11, 2016	Aug. 10, 2017
Power Sensor	MA2411B	0738171	Aug. 11, 2016	Aug. 10, 2017

- Note:
1. The calibration interval of the above test instruments is 12 months and the calibrations are traceable to NML/ROC and NIST/USA.
 2. The test was performed in HwaYa Chamber 4.
 3. The horn antenna and preamplifier (model: 8449B) are used only for the measurement of emission frequency above 1GHz if tested.
 4. The FCC Site Registration No. is 460141.
 5. The IC Site Registration No. is IC7450F-4.

4.1.3 Test Procedures

For Radiated emission below 30MHz

- a. The EUT was placed on the top of a rotating table 0.8 meters above the ground at a 3 meter chamber room. The table was rotated 360 degrees to determine the position of the highest radiation.
- b. The EUT was set 3 meters away from the interference-receiving antenna, which was mounted on the top of a variable-height antenna tower.
- c. Both X and Y axes of the antenna are set to make the measurement.
- d. For each suspected emission, the EUT was arranged to its worst case and the rotatable table was turned from 0 degrees to 360 degrees to find the maximum reading.
- e. The test-receiver system was set to Quasi-Peak Detect Function and Specified Bandwidth with Maximum Hold Mode.

Note:

1. The resolution bandwidth and video bandwidth of test receiver/spectrum analyzer is 9kHz at frequency below 30MHz.

For Radiated emission above 30MHz

- a. The EUT was placed on the top of a rotating table 0.8 meters (for 30MHz ~ 1GHz) / 1.5 meters (for above 1GHz) above the ground at 3 meter chamber room for test. The table was rotated 360 degrees to determine the position of the highest radiation.
- b. The EUT was set 3 meters away from the interference-receiving antenna, which was mounted on the top of a variable-height antenna tower.
- c. The height of antenna is varied from one meter to four meters above the ground to determine the maximum value of the field strength. Both horizontal and vertical polarizations of the antenna are set to make the measurement.
- d. For each suspected emission, the EUT was arranged to its worst case and then the antenna was tuned to heights from 1 meter to 4 meters and the rotatable table was turned from 0 degrees to 360 degrees to find the maximum reading.
- e. The test-receiver system was set to quasi-peak detect function and specified bandwidth with maximum hold mode when the test frequency is below 1 GHz.
- f. The test-receiver system was set to peak and average detect function and specified bandwidth with maximum hold mode when the test frequency is above 1 GHz. If the peak reading value also meets average limit, measurement with the average detector is unnecessary.

Note:

1. The resolution bandwidth and video bandwidth of test receiver/spectrum analyzer is 120kHz for Quasi-peak detection (QP) at frequency below 1GHz.
2. The resolution bandwidth of test receiver/spectrum analyzer is 1 MHz and the video bandwidth is 3 MHz for Peak detection (PK) at frequency above 1GHz.
3. The resolution bandwidth of test receiver/spectrum analyzer is 1 MHz and the video bandwidth is $\geq 1/T$ (Duty cycle < 98%) or 3 x RBW (Duty cycle $\geq 98\%$) for Average detection (AV) at frequency above 1GHz.
4. All modes of operation were investigated and the worst-case emissions are reported.

4.1.4 Deviation from Test Standard

No deviation.

4.1.5 Test Setup

For Radiated emission below 30MHz

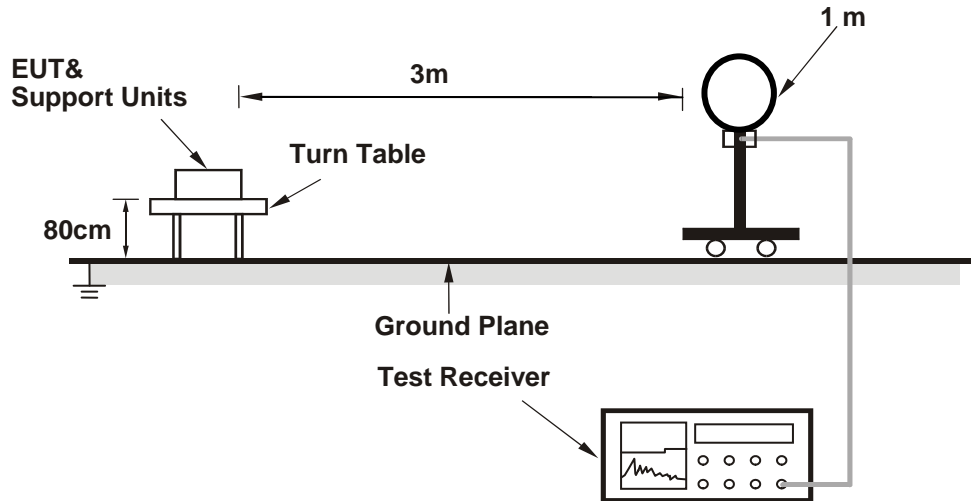

For Radiated emission 30MHz to 1GHz

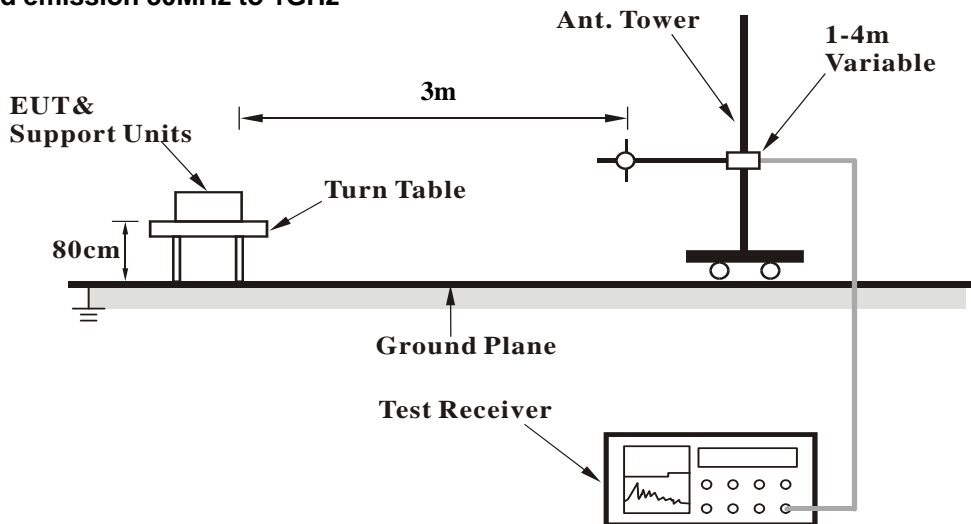

For Radiated emission above 1GHz

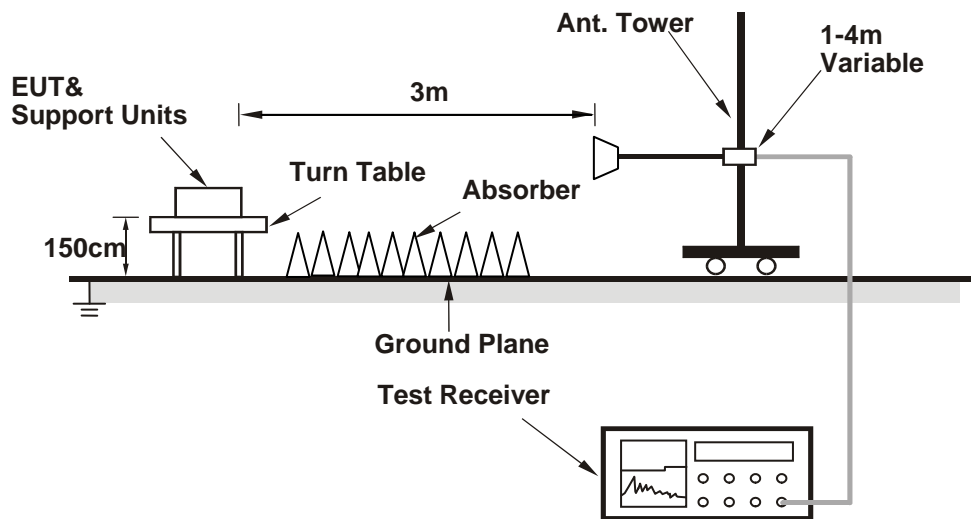

For the actual test configuration, please refer to the attached file (Test Setup Photo).

4.1.6 EUT Operating Conditions

- Placed the EUT on the testing table.
- Prepared a notebook to act as a communication partner and placed it outside of testing area.
- The communication partner connected with EUT via a RJ45 cable and ran a test program (provided by manufacturer) to enable EUT under transmission condition continuously at specific channel frequency.
- The communication partner sent data to EUT by command "PING".
- The necessary accessories enable the system in full functions.

4.1.7 Test Results

Above 1GHz worst-Case data:

1TX

802.11b

CHANNEL	TX Channel 1	DETECTOR FUNCTION	Peak (PK)
FREQUENCY RANGE	1GHz ~ 25GHz		Average (AV)

ANTENNA POLARITY & TEST DISTANCE: HORIZONTAL AT 3 M								
NO.	FREQ. (MHz)	EMISSION LEVEL (dBuV/m)	LIMIT (dBuV/m)	MARGIN (dB)	ANTENNA HEIGHT (m)	TABLE ANGLE (Degree)	RAW VALUE (dBuV)	CORRECTION FACTOR (dB/m)
1	2390.00	56.9 PK	74.0	-17.1	2.84 H	223	24.70	32.20
2	2390.00	47.9 AV	54.0	-6.1	2.84 H	223	15.70	32.20
3	*2412.00	105.2 PK			2.84 H	223	72.90	32.30
4	*2412.00	101.4 AV			2.84 H	223	69.10	32.30
5	4824.00	46.8 PK	74.0	-27.2	1.65 H	329	44.80	2.00
6	4824.00	37.4 AV	54.0	-16.6	1.65 H	329	35.40	2.00
7	#7236.00	55.6 PK	75.2	-19.6	2.59 H	298	47.60	8.00
8	#7236.00	48.0 AV	71.4	-23.4	2.59 H	298	40.00	8.00
ANTENNA POLARITY & TEST DISTANCE: VERTICAL AT 3 M								
NO.	FREQ. (MHz)	EMISSION LEVEL (dBuV/m)	LIMIT (dBuV/m)	MARGIN (dB)	ANTENNA HEIGHT (m)	TABLE ANGLE (Degree)	RAW VALUE (dBuV)	CORRECTION FACTOR (dB/m)
1	2390.00	59.3 PK	74.0	-14.7	3.02 V	222	27.10	32.20
2	2390.00	53.0 AV	54.0	-1.0	3.02 V	222	20.80	32.20
3	*2412.00	106.5 PK			3.02 V	222	74.20	32.30
4	*2412.00	103.3 AV			3.02 V	222	71.00	32.30
5	4824.00	47.8 PK	74.0	-26.2	3.38 V	226	45.80	2.00
6	4824.00	40.7 AV	54.0	-13.3	3.38 V	226	38.70	2.00
7	#7236.00	56.2 PK	76.5	-20.3	3.61 V	169	48.20	8.00
8	#7236.00	49.2 AV	73.3	-24.1	3.61 V	169	41.20	8.00

Remarks:

1. Emission Level(dBuV/m) = Raw Value(dBuV) + Correction Factor(dB/m)
2. Correction Factor(dB/m) = Antenna Factor(dB/m) + Cable Factor(dB) – Pre-Amplifier Factor(dB)
3. The other emission levels were very low against the limit.
4. Margin value = Emission Level – Limit value
5. " * ": Fundamental frequency.

CHANNEL	TX Channel 6	DETECTOR FUNCTION	Peak (PK)
FREQUENCY RANGE	1GHz ~ 25GHz		Average (AV)

ANTENNA POLARITY & TEST DISTANCE: HORIZONTAL AT 3 M

NO.	FREQ. (MHz)	EMISSION LEVEL (dBuV/m)	LIMIT (dBuV/m)	MARGIN (dB)	ANTENNA HEIGHT (m)	TABLE ANGLE (Degree)	RAW VALUE (dBuV)	CORRECTION FACTOR (dB/m)
1	*2437.00	105.0 PK			2.94 H	305	72.60	32.40
2	*2437.00	100.9 AV			2.94 H	305	68.50	32.40
3	4874.00	46.8 PK	74.0	-27.2	3.33 H	314	44.60	2.20
4	4874.00	40.4 AV	54.0	-13.6	3.33 H	314	38.20	2.20
5	7311.00	56.4 PK	74.0	-17.6	3.05 H	226	48.30	8.10
6	7311.00	49.8 AV	54.0	-4.2	3.05 H	226	41.70	8.10

ANTENNA POLARITY & TEST DISTANCE: VERTICAL AT 3 M

NO.	FREQ. (MHz)	EMISSION LEVEL (dBuV/m)	LIMIT (dBuV/m)	MARGIN (dB)	ANTENNA HEIGHT (m)	TABLE ANGLE (Degree)	RAW VALUE (dBuV)	CORRECTION FACTOR (dB/m)
1	*2437.00	106.9 PK			1.48 V	292	74.50	32.40
2	*2437.00	103.3 AV			1.48 V	292	70.90	32.40
3	4874.00	48.5 PK	74.0	-25.5	3.66 V	141	46.30	2.20
4	4874.00	42.4 AV	54.0	-11.6	3.66 V	141	40.20	2.20
5	7311.00	58.3 PK	74.0	-15.7	3.77 V	183	50.20	8.10
6	7311.00	51.6 AV	54.0	-2.4	3.77 V	183	43.50	8.10

Remarks:

1. Emission Level(dBuV/m) = Raw Value(dBuV) + Correction Factor(dB/m)
2. Correction Factor(dB/m) = Antenna Factor(dB/m) + Cable Factor(dB) – Pre-Amplifier Factor(dB)
3. The other emission levels were very low against the limit.
4. Margin value = Emission Level – Limit value
5. " * ": Fundamental frequency.

CHANNEL	TX Channel 11	DETECTOR FUNCTION	Peak (PK)
FREQUENCY RANGE	1GHz ~ 25GHz		Average (AV)

ANTENNA POLARITY & TEST DISTANCE: HORIZONTAL AT 3 M								
NO.	FREQ. (MHz)	EMISSION LEVEL (dBuV/m)	LIMIT (dBuV/m)	MARGIN (dB)	ANTENNA HEIGHT (m)	TABLE ANGLE (Degree)	RAW VALUE (dBuV)	CORRECTION FACTOR (dB/m)
1	*2462.00	107.0 PK			2.89 H	317	74.40	32.60
2	*2462.00	103.2 AV			2.89 H	317	70.60	32.60
3	2483.50	58.2 PK	74.0	-15.8	2.89 H	317	25.50	32.70
4	2483.50	48.2 AV	54.0	-5.8	2.89 H	317	15.50	32.70
5	4924.00	46.6 PK	74.0	-27.4	2.79 H	226	44.40	2.20
6	4924.00	40.6 AV	54.0	-13.4	2.79 H	226	38.40	2.20
7	7386.00	55.9 PK	74.0	-18.1	2.24 H	236	47.70	8.20
8	7386.00	49.0 AV	54.0	-5.0	2.24 H	236	40.80	8.20

ANTENNA POLARITY & TEST DISTANCE: VERTICAL AT 3 M								
NO.	FREQ. (MHz)	EMISSION LEVEL (dBuV/m)	LIMIT (dBuV/m)	MARGIN (dB)	ANTENNA HEIGHT (m)	TABLE ANGLE (Degree)	RAW VALUE (dBuV)	CORRECTION FACTOR (dB/m)
1	*2462.00	108.7 PK			4.00 V	290	76.10	32.60
2	*2462.00	105.1 AV			4.00 V	290	72.50	32.60
3	2483.50	60.0 PK	74.0	-14.0	4.00 V	290	27.30	32.70
4	2483.50	52.2 AV	54.0	-1.8	4.00 V	290	19.50	32.70
5	4924.00	48.3 PK	74.0	-25.7	3.73 V	140	46.10	2.20
6	4924.00	42.5 AV	54.0	-11.5	3.73 V	140	40.30	2.20
7	7386.00	57.2 PK	74.0	-16.8	3.69 V	178	49.00	8.20
8	7386.00	50.4 AV	54.0	-3.6	3.69 V	178	42.20	8.20

Remarks:

1. Emission Level(dBuV/m) = Raw Value(dBuV) + Correction Factor(dB/m)
2. Correction Factor(dB/m) = Antenna Factor(dB/m) + Cable Factor(dB) – Pre-Amplifier Factor(dB)
3. The other emission levels were very low against the limit.
4. Margin value = Emission Level – Limit value
5. " * ": Fundamental frequency.

802.11g

CHANNEL	TX Channel 1	DETECTOR FUNCTION	Peak (PK) Average (AV)
FREQUENCY RANGE	1GHz ~ 25GHz		

ANTENNA POLARITY & TEST DISTANCE: HORIZONTAL AT 3 M

NO.	FREQ. (MHz)	EMISSION LEVEL (dBuV/m)	LIMIT (dBuV/m)	MARGIN (dB)	ANTENNA HEIGHT (m)	TABLE ANGLE (Degree)	RAW VALUE (dBuV)	CORRECTION FACTOR (dB/m)
1	2390.00	67.9 PK	74.0	-6.1	2.14 H	354	35.70	32.20
2	2390.00	50.0 AV	54.0	-4.0	2.14 H	354	17.80	32.20
3	*2412.00	103.1 PK			2.14 H	354	70.80	32.30
4	*2412.00	94.0 AV			2.14 H	354	61.70	32.30
5	4824.00	45.8 PK	74.0	-28.2	2.25 H	45	43.80	2.00
6	4824.00	33.1 AV	54.0	-20.9	2.25 H	45	31.10	2.00

ANTENNA POLARITY & TEST DISTANCE: VERTICAL AT 3 M

NO.	FREQ. (MHz)	EMISSION LEVEL (dBuV/m)	LIMIT (dBuV/m)	MARGIN (dB)	ANTENNA HEIGHT (m)	TABLE ANGLE (Degree)	RAW VALUE (dBuV)	CORRECTION FACTOR (dB/m)
1	2390.00	65.8 PK	74.0	-8.2	3.71 V	103	33.6	32.2
2	2390.00	51.2 AV	54.0	-2.8	3.71 V	103	19.0	32.2
3	*2412.00	106.6 PK			3.71 V	103	74.3	32.3
4	*2412.00	96.4 AV			3.71 V	103	64.1	32.3
5	4824.00	51.7 PK	74.0	-22.3	1.43 V	348	49.7	2.0
6	4824.00	38.8 AV	54.0	-15.2	1.43 V	348	36.8	2.0

Remarks:

1. Emission Level(dBuV/m) = Raw Value(dBuV) + Correction Factor(dB/m)
2. Correction Factor(dB/m) = Antenna Factor(dB/m) + Cable Factor(dB) – Pre-Amplifier Factor(dB)
3. The other emission levels were very low against the limit.
4. Margin value = Emission Level – Limit value
5. " * ": Fundamental frequency.

CHANNEL	TX Channel 6	DETECTOR FUNCTION	Peak (PK)
FREQUENCY RANGE	1GHz ~ 25GHz		Average (AV)

ANTENNA POLARITY & TEST DISTANCE: HORIZONTAL AT 3 M

NO.	FREQ. (MHz)	EMISSION LEVEL (dBuV/m)	LIMIT (dBuV/m)	MARGIN (dB)	ANTENNA HEIGHT (m)	TABLE ANGLE (Degree)	RAW VALUE (dBuV)	CORRECTION FACTOR (dB/m)
1	2390.00	61.0 PK	74.0	-13.0	3.52 H	246	28.80	32.20
2	2390.00	50.1 AV	54.0	-3.9	3.52 H	246	17.90	32.20
3	*2437.00	106.9 PK			3.52 H	246	74.50	32.40
4	*2437.00	97.0 AV			3.52 H	246	64.60	32.40
5	4874.00	45.6 PK	74.0	-28.4	1.14 H	25	43.40	2.20
6	4874.00	33.1 AV	54.0	-20.9	1.14 H	25	30.90	2.20

ANTENNA POLARITY & TEST DISTANCE: VERTICAL AT 3 M

NO.	FREQ. (MHz)	EMISSION LEVEL (dBuV/m)	LIMIT (dBuV/m)	MARGIN (dB)	ANTENNA HEIGHT (m)	TABLE ANGLE (Degree)	RAW VALUE (dBuV)	CORRECTION FACTOR (dB/m)
1	2390.00	66.7 PK	74.0	-7.3	3.68 V	182	34.50	32.20
2	2390.00	53.1 AV	54.0	-0.9	3.68 V	182	20.90	32.20
3	*2437.00	108.5 PK			3.68 V	182	76.10	32.40
4	*2437.00	99.3 AV			3.68 V	182	66.90	32.40
5	4874.00	46.6 PK	74.0	-27.4	1.59 V	129	44.40	2.20
6	4874.00	34.5 AV	54.0	-19.5	1.59 V	129	32.30	2.20

Remarks:

1. Emission Level(dBuV/m) = Raw Value(dBuV) + Correction Factor(dB/m)
2. Correction Factor(dB/m) = Antenna Factor(dB/m) + Cable Factor(dB) – Pre-Amplifier Factor(dB)
3. The other emission levels were very low against the limit.
4. Margin value = Emission Level – Limit value
5. " * ": Fundamental frequency.

CHANNEL	TX Channel 11	DETECTOR FUNCTION	Peak (PK)
FREQUENCY RANGE	1GHz ~ 25GHz		Average (AV)

ANTENNA POLARITY & TEST DISTANCE: HORIZONTAL AT 3 M								
NO.	FREQ. (MHz)	EMISSION LEVEL (dBuV/m)	LIMIT (dBuV/m)	MARGIN (dB)	ANTENNA HEIGHT (m)	TABLE ANGLE (Degree)	RAW VALUE (dBuV)	CORRECTION FACTOR (dB/m)
1	*2462.00	106.4 PK			2.63 H	185	73.80	32.60
2	*2462.00	96.8 AV			2.63 H	185	64.20	32.60
3	2483.50	63.3 PK	74.0	-10.7	2.63 H	185	30.60	32.70
4	2483.50	49.5 AV	54.0	-4.5	2.63 H	185	16.80	32.70
5	4924.00	45.7 PK	74.0	-28.3	1.56 H	221	43.50	2.20
6	4924.00	33.3 AV	54.0	-20.7	1.56 H	221	31.10	2.20
ANTENNA POLARITY & TEST DISTANCE: VERTICAL AT 3 M								
NO.	FREQ. (MHz)	EMISSION LEVEL (dBuV/m)	LIMIT (dBuV/m)	MARGIN (dB)	ANTENNA HEIGHT (m)	TABLE ANGLE (Degree)	RAW VALUE (dBuV)	CORRECTION FACTOR (dB/m)
1	*2462.00	108.4 PK			4.00 V	290	75.80	32.60
2	*2462.00	99.4 AV			4.00 V	290	66.80	32.60
3	2483.50	69.1 PK	74.0	-4.9	4.00 V	290	36.40	32.70
4	2483.50	53.0 AV	54.0	-1.0	4.00 V	290	20.30	32.70
5	4924.00	46.5 PK	74.0	-27.5	2.62 V	189	44.30	2.20
6	4924.00	34.4 AV	54.0	-19.6	2.62 V	189	32.20	2.20

Remarks:

1. Emission Level(dBuV/m) = Raw Value(dBuV) + Correction Factor(dB/m)
2. Correction Factor(dB/m) = Antenna Factor(dB/m) + Cable Factor(dB) – Pre-Amplifier Factor(dB)
3. The other emission levels were very low against the limit.
4. Margin value = Emission Level – Limit value
5. " * ": Fundamental frequency.

802.11n (HT20)

CHANNEL	TX Channel 1	DETECTOR FUNCTION	Peak (PK)
FREQUENCY RANGE	1GHz ~ 25GHz		Average (AV)

ANTENNA POLARITY & TEST DISTANCE: HORIZONTAL AT 3 M

NO.	FREQ. (MHz)	EMISSION LEVEL (dBuV/m)	LIMIT (dBuV/m)	MARGIN (dB)	ANTENNA HEIGHT (m)	TABLE ANGLE (Degree)	RAW VALUE (dBuV)	CORRECTION FACTOR (dB/m)
1	2390.00	69.0 PK	74.0	-5.0	2.69 H	188	36.80	32.20
2	2390.00	45.8 AV	54.0	-8.2	2.69 H	188	13.60	32.20
3	*2412.00	103.8 PK			2.69 H	188	71.50	32.30
4	*2412.00	94.0 AV			2.69 H	188	61.70	32.30
5	4824.00	45.4 PK	74.0	-28.6	1.52 H	126	43.40	2.00
6	4824.00	33.1 AV	54.0	-20.9	1.52 H	126	31.10	2.00

ANTENNA POLARITY & TEST DISTANCE: VERTICAL AT 3 M

NO.	FREQ. (MHz)	EMISSION LEVEL (dBuV/m)	LIMIT (dBuV/m)	MARGIN (dB)	ANTENNA HEIGHT (m)	TABLE ANGLE (Degree)	RAW VALUE (dBuV)	CORRECTION FACTOR (dB/m)
1	2390.00	73.1 PK	74.0	-0.9	4.00 V	173	40.90	32.20
2	2390.00	46.6 AV	54.0	-7.4	4.00 V	173	14.40	32.20
3	*2412.00	105.1 PK			4.00 V	173	72.80	32.30
4	*2412.00	95.3 AV			4.00 V	173	63.00	32.30
5	4824.00	46.5 PK	74.0	-27.5	1.99 V	220	44.50	2.00
6	4824.00	34.4 AV	54.0	-19.6	1.99 V	220	32.40	2.00

Remarks:

1. Emission Level(dBuV/m) = Raw Value(dBuV) + Correction Factor(dB/m)
2. Correction Factor(dB/m) = Antenna Factor(dB/m) + Cable Factor(dB) – Pre-Amplifier Factor(dB)
3. The other emission levels were very low against the limit.
4. Margin value = Emission Level – Limit value
5. " * ": Fundamental frequency.

CHANNEL	TX Channel 6	DETECTOR FUNCTION	Peak (PK)
FREQUENCY RANGE	1GHz ~ 25GHz		Average (AV)

ANTENNA POLARITY & TEST DISTANCE: HORIZONTAL AT 3 M

NO.	FREQ. (MHz)	EMISSION LEVEL (dBuV/m)	LIMIT (dBuV/m)	MARGIN (dB)	ANTENNA HEIGHT (m)	TABLE ANGLE (Degree)	RAW VALUE (dBuV)	CORRECTION FACTOR (dB/m)
1	2390.00	60.5 PK	74.0	-13.5	2.87 H	174	28.30	32.20
2	2390.00	50.4 AV	54.0	-3.6	2.87 H	174	18.20	32.20
3	*2437.00	106.9 PK			2.87 H	174	74.50	32.40
4	*2437.00	96.6 AV			2.87 H	174	64.20	32.40
5	4874.00	45.8 PK	74.0	-28.2	1.95 H	332	43.60	2.20
6	4874.00	33.7 AV	54.0	-20.3	1.95 H	332	31.50	2.20

ANTENNA POLARITY & TEST DISTANCE: VERTICAL AT 3 M

NO.	FREQ. (MHz)	EMISSION LEVEL (dBuV/m)	LIMIT (dBuV/m)	MARGIN (dB)	ANTENNA HEIGHT (m)	TABLE ANGLE (Degree)	RAW VALUE (dBuV)	CORRECTION FACTOR (dB/m)
1	2390.00	64.7 PK	74.0	-9.3	4.00 V	274	32.50	32.20
2	2390.00	53.2 AV	54.0	-0.8	4.00 V	274	21.00	32.20
3	*2437.00	108.5 PK			4.00 V	274	76.10	32.40
4	*2437.00	99.1 AV			4.00 V	274	66.70	32.40
5	4874.00	47.1 PK	74.0	-26.9	2.36 V	228	44.90	2.20
6	4874.00	34.5 AV	54.0	-19.5	2.36 V	228	32.30	2.20

Remarks:

1. Emission Level(dBuV/m) = Raw Value(dBuV) + Correction Factor(dB/m)
2. Correction Factor(dB/m) = Antenna Factor(dB/m) + Cable Factor(dB) – Pre-Amplifier Factor(dB)
3. The other emission levels were very low against the limit.
4. Margin value = Emission Level – Limit value
5. " * ": Fundamental frequency.

CHANNEL	TX Channel 11	DETECTOR FUNCTION	Peak (PK)
FREQUENCY RANGE	1GHz ~ 25GHz		Average (AV)

ANTENNA POLARITY & TEST DISTANCE: HORIZONTAL AT 3 M								
NO.	FREQ. (MHz)	EMISSION LEVEL (dBuV/m)	LIMIT (dBuV/m)	MARGIN (dB)	ANTENNA HEIGHT (m)	TABLE ANGLE (Degree)	RAW VALUE (dBuV)	CORRECTION FACTOR (dB/m)
1	*2462.00	107.1 PK			2.85 H	249	74.50	32.60
2	*2462.00	96.9 AV			2.85 H	249	64.30	32.60
3	2483.50	67.2 PK	74.0	-6.8	2.85 H	249	34.50	32.70
4	2483.50	51.2 AV	54.0	-2.8	2.85 H	249	18.50	32.70
5	4924.00	45.6 PK	74.0	-28.4	2.21 H	123	43.40	2.20
6	4924.00	33.0 AV	54.0	-21.0	2.21 H	123	30.80	2.20
ANTENNA POLARITY & TEST DISTANCE: VERTICAL AT 3 M								
NO.	FREQ. (MHz)	EMISSION LEVEL (dBuV/m)	LIMIT (dBuV/m)	MARGIN (dB)	ANTENNA HEIGHT (m)	TABLE ANGLE (Degree)	RAW VALUE (dBuV)	CORRECTION FACTOR (dB/m)
1	*2462.00	109.2 PK			4.00 V	205	76.60	32.60
2	*2462.00	99.5 AV			4.00 V	205	66.90	32.60
3	2483.50	69.7 PK	74.0	-4.3	4.00 V	205	37.00	32.70
4	2483.50	53.5 AV	54.0	-0.5	4.00 V	205	20.80	32.70
5	4924.00	46.7 PK	74.0	-27.3	1.82 V	335	44.50	2.20
6	4924.00	34.4 AV	54.0	-19.6	1.82 V	335	32.20	2.20

Remarks:

1. Emission Level(dBuV/m) = Raw Value(dBuV) + Correction Factor(dB/m)
2. Correction Factor(dB/m) = Antenna Factor(dB/m) + Cable Factor(dB) – Pre-Amplifier Factor(dB)
3. The other emission levels were very low against the limit.
4. Margin value = Emission Level – Limit value
5. " * ": Fundamental frequency.

802.11n (HT40)

CHANNEL	TX Channel 3	DETECTOR	Peak (PK)
FREQUENCY RANGE	1GHz ~ 25GHz	FUNCTION	Average (AV)

ANTENNA POLARITY & TEST DISTANCE: HORIZONTAL AT 3 M

NO.	FREQ. (MHz)	EMISSION LEVEL (dBuV/m)	LIMIT (dBuV/m)	MARGIN (dB)	ANTENNA HEIGHT (m)	TABLE ANGLE (Degree)	RAW VALUE (dBuV)	CORRECTION FACTOR (dB/m)
1	2390.00	69.7 PK	74.0	-4.3	2.65 H	214	37.50	32.20
2	2390.00	48.5 AV	54.0	-5.5	2.65 H	214	16.30	32.20
3	*2422.00	102.5 PK			2.65 H	214	70.10	32.40
4	*2422.00	92.8 AV			2.65 H	214	60.40	32.40
5	4844.00	47.5 PK	74.0	-26.5	1.23 H	175	45.40	2.10
6	4844.00	33.5 AV	54.0	-20.5	1.23 H	175	31.40	2.10

ANTENNA POLARITY & TEST DISTANCE: VERTICAL AT 3 M

NO.	FREQ. (MHz)	EMISSION LEVEL (dBuV/m)	LIMIT (dBuV/m)	MARGIN (dB)	ANTENNA HEIGHT (m)	TABLE ANGLE (Degree)	RAW VALUE (dBuV)	CORRECTION FACTOR (dB/m)
1	2390.00	73.0 PK	74.0	-1.0	3.61 V	273	40.80	32.20
2	2390.00	50.8 AV	54.0	-3.2	3.61 V	273	18.60	32.20
3	*2422.00	104.7 PK			3.61 V	273	72.30	32.40
4	*2422.00	94.6 AV			3.61 V	273	62.20	32.40
5	4844.00	47.9 PK	74.0	-26.1	1.57 V	34	45.80	2.10
6	4844.00	34.1 AV	54.0	-19.9	1.57 V	34	32.00	2.10

Remarks:

1. Emission Level(dBuV/m) = Raw Value(dBuV) + Correction Factor(dB/m)
2. Correction Factor(dB/m) = Antenna Factor(dB/m) + Cable Factor(dB) – Pre-Amplifier Factor(dB)
3. The other emission levels were very low against the limit.
4. Margin value = Emission Level – Limit value
5. " * ": Fundamental frequency.

CHANNEL	TX Channel 6	DETECTOR FUNCTION	Peak (PK)
FREQUENCY RANGE	1GHz ~ 25GHz		Average (AV)

ANTENNA POLARITY & TEST DISTANCE: HORIZONTAL AT 3 M								
NO.	FREQ. (MHz)	EMISSION LEVEL (dBuV/m)	LIMIT (dBuV/m)	MARGIN (dB)	ANTENNA HEIGHT (m)	TABLE ANGLE (Degree)	RAW VALUE (dBuV)	CORRECTION FACTOR (dB/m)
1	2390.00	68.2 PK	74.0	-5.8	2.89 H	236	36.00	32.20
2	2390.00	51.6 AV	54.0	-2.4	2.89 H	236	19.40	32.20
3	*2437.00	105.2 PK			2.89 H	236	72.80	32.40
4	*2437.00	95.7 AV			2.89 H	236	63.30	32.40
5	2483.50	66.9 PK	74.0	-7.1	2.89 H	236	34.20	32.70
6	2483.50	50.9 AV	54.0	-3.1	2.89 H	236	18.20	32.70
7	4874.00	47.9 PK	74.0	-26.1	1.24 H	178	45.70	2.20
8	4874.00	33.5 AV	54.0	-20.5	1.24 H	178	31.30	2.20

ANTENNA POLARITY & TEST DISTANCE: VERTICAL AT 3 M								
NO.	FREQ. (MHz)	EMISSION LEVEL (dBuV/m)	LIMIT (dBuV/m)	MARGIN (dB)	ANTENNA HEIGHT (m)	TABLE ANGLE (Degree)	RAW VALUE (dBuV)	CORRECTION FACTOR (dB/m)
1	2390.00	69.5 PK	74.0	-4.5	3.59 V	282	37.30	32.20
2	2390.00	53.2 AV	54.0	-0.8	3.59 V	282	21.00	32.20
3	*2437.00	106.7 PK			3.59 V	282	74.30	32.40
4	*2437.00	96.4 AV			3.59 V	282	64.00	32.40
5	2483.50	67.9 PK	74.0	-6.1	3.59 V	282	35.20	32.70
6	2483.50	51.6 AV	54.0	-2.4	3.59 V	282	18.90	32.70
7	4874.00	48.3 PK	74.0	-25.7	1.72 V	34	46.10	2.20
8	4874.00	33.9 AV	54.0	-20.1	1.72 V	34	31.70	2.20

Remarks:

1. Emission Level(dBuV/m) = Raw Value(dBuV) + Correction Factor(dB/m)
2. Correction Factor(dB/m) = Antenna Factor(dB/m) + Cable Factor(dB) – Pre-Amplifier Factor(dB)
3. The other emission levels were very low against the limit.
4. Margin value = Emission Level – Limit value
5. " * ": Fundamental frequency.

CHANNEL	TX Channel 9	DETECTOR FUNCTION	Peak (PK)
FREQUENCY RANGE	1GHz ~ 25GHz		Average (AV)

ANTENNA POLARITY & TEST DISTANCE: HORIZONTAL AT 3 M

NO.	FREQ. (MHz)	EMISSION LEVEL (dBuV/m)	LIMIT (dBuV/m)	MARGIN (dB)	ANTENNA HEIGHT (m)	TABLE ANGLE (Degree)	RAW VALUE (dBuV)	CORRECTION FACTOR (dB/m)
1	*2452.00	100.9 PK			2.74 H	228	68.30	32.60
2	*2452.00	92.0 AV			2.74 H	228	59.40	32.60
3	2483.50	69.2 PK	74.0	-4.8	2.74 H	228	36.50	32.70
4	2483.50	49.0 AV	54.0	-5.0	2.74 H	228	16.30	32.70
5	4904.00	47.6 PK	74.0	-26.4	1.19 H	183	45.40	2.20
6	4904.00	33.7 AV	54.0	-20.3	1.19 H	183	31.50	2.20

ANTENNA POLARITY & TEST DISTANCE: VERTICAL AT 3 M

NO.	FREQ. (MHz)	EMISSION LEVEL (dBuV/m)	LIMIT (dBuV/m)	MARGIN (dB)	ANTENNA HEIGHT (m)	TABLE ANGLE (Degree)	RAW VALUE (dBuV)	CORRECTION FACTOR (dB/m)
1	*2452.00	103.9 PK			3.54 V	281	71.30	32.60
2	*2452.00	94.4 AV			3.54 V	281	61.80	32.60
3	2483.50	73.1 PK	74.0	-0.9	3.54 V	281	40.40	32.70
4	2483.50	50.5 AV	54.0	-3.5	3.54 V	281	17.80	32.70
5	4904.00	48.0 PK	74.0	-26.0	1.64 V	26	45.80	2.20
6	4904.00	34.0 AV	54.0	-20.0	1.64 V	26	31.80	2.20

Remarks:

1. Emission Level(dBuV/m) = Raw Value(dBuV) + Correction Factor(dB/m)
2. Correction Factor(dB/m) = Antenna Factor(dB/m) + Cable Factor(dB) – Pre-Amplifier Factor(dB)
3. The other emission levels were very low against the limit.
4. Margin value = Emission Level – Limit value
5. " * ": Fundamental frequency.

2TX

802.11b

CHANNEL	TX Channel 1	DETECTOR FUNCTION	Peak (PK)
FREQUENCY RANGE	1GHz ~ 25GHz		Average (AV)

ANTENNA POLARITY & TEST DISTANCE: HORIZONTAL AT 3 M								
NO.	FREQ. (MHz)	EMISSION LEVEL (dBuV/m)	LIMIT (dBuV/m)	MARGIN (dB)	ANTENNA HEIGHT (m)	TABLE ANGLE (Degree)	RAW VALUE (dBuV)	CORRECTION FACTOR (dB/m)
1	2390.00	57.9 PK	74.0	-16.1	1.60 H	0	25.00	32.90
2	2390.00	50.0 AV	54.0	-4.0	1.60 H	0	17.10	32.90
3	*2412.00	105.4 PK			2.43 H	0	72.50	32.90
4	*2412.00	101.7 AV			2.43 H	0	68.80	32.90
5	4824.00	50.8 PK	74.0	-23.2	1.00 H	175	44.10	6.70
6	4824.00	44.5 AV	54.0	-9.5	1.00 H	175	37.80	6.70
ANTENNA POLARITY & TEST DISTANCE: VERTICAL AT 3 M								
NO.	FREQ. (MHz)	EMISSION LEVEL (dBuV/m)	LIMIT (dBuV/m)	MARGIN (dB)	ANTENNA HEIGHT (m)	TABLE ANGLE (Degree)	RAW VALUE (dBuV)	CORRECTION FACTOR (dB/m)
1	2390.00	60.6 PK	74.0	-13.4	1.77 V	257	27.70	32.90
2	2390.00	53.5 AV	54.0	-0.5	1.77 V	257	20.60	32.90
3	*2412.00	107.0 PK			1.95 V	178	74.10	32.90
4	*2412.00	103.3 AV			1.95 V	178	70.40	32.90
5	4824.00	51.6 PK	74.0	-22.4	1.01 V	336	44.90	6.70
6	4824.00	45.4 AV	54.0	-8.6	1.01 V	336	38.70	6.70

Remarks:

1. Emission Level(dBuV/m) = Raw Value(dBuV) + Correction Factor(dB/m)
2. Correction Factor(dB/m) = Antenna Factor(dB/m) + Cable Factor(dB) – Pre-Amplifier Factor(dB)
3. The other emission levels were very low against the limit.
4. Margin value = Emission Level – Limit value
5. " * ": Fundamental frequency.

CHANNEL	TX Channel 6	DETECTOR FUNCTION	Peak (PK)
FREQUENCY RANGE	1GHz ~ 25GHz		Average (AV)

ANTENNA POLARITY & TEST DISTANCE: HORIZONTAL AT 3 M

NO.	FREQ. (MHz)	EMISSION LEVEL (dBuV/m)	LIMIT (dBuV/m)	MARGIN (dB)	ANTENNA HEIGHT (m)	TABLE ANGLE (Degree)	RAW VALUE (dBuV)	CORRECTION FACTOR (dB/m)
1	*2437.00	107.3 PK			1.05 H	0	74.20	33.10
2	*2437.00	105.2 AV			1.05 H	0	72.10	33.10
3	4874.00	50.6 PK	74.0	-23.4	1.57 H	85	43.80	6.80
4	4874.00	46.5 AV	54.0	-7.5	1.57 H	85	39.70	6.80

ANTENNA POLARITY & TEST DISTANCE: VERTICAL AT 3 M

NO.	FREQ. (MHz)	EMISSION LEVEL (dBuV/m)	LIMIT (dBuV/m)	MARGIN (dB)	ANTENNA HEIGHT (m)	TABLE ANGLE (Degree)	RAW VALUE (dBuV)	CORRECTION FACTOR (dB/m)
1	*2437.00	109.5 PK			1.71 V	282	76.40	33.10
2	*2437.00	105.8 AV			1.71 V	282	72.70	33.10
3	4874.00	51.3 PK	74.0	-22.7	1.25 V	63	44.50	6.80
4	4874.00	47.3 AV	54.0	-6.7	1.25 V	63	40.50	6.80

Remarks:

1. Emission Level(dBuV/m) = Raw Value(dBuV) + Correction Factor(dB/m)
2. Correction Factor(dB/m) = Antenna Factor(dB/m) + Cable Factor(dB) – Pre-Amplifier Factor(dB)
3. The other emission levels were very low against the limit.
4. Margin value = Emission Level – Limit value
5. " * ": Fundamental frequency.

CHANNEL	TX Channel 11	DETECTOR FUNCTION	Peak (PK)
FREQUENCY RANGE	1GHz ~ 25GHz		Average (AV)

ANTENNA POLARITY & TEST DISTANCE: HORIZONTAL AT 3 M								
NO.	FREQ. (MHz)	EMISSION LEVEL (dBuV/m)	LIMIT (dBuV/m)	MARGIN (dB)	ANTENNA HEIGHT (m)	TABLE ANGLE (Degree)	RAW VALUE (dBuV)	CORRECTION FACTOR (dB/m)
1	*2462.00	108.0 PK			1.49 H	1	74.80	33.20
2	*2462.00	104.5 AV			1.49 H	1	71.30	33.20
3	2483.50	60.0 PK	74.0	-14.0	1.56 H	10	26.70	33.30
4	2483.50	52.8 AV	54.0	-1.2	1.56 H	10	19.50	33.30
5	4924.00	51.2 PK	74.0	-22.8	1.47 H	85	44.30	6.90
6	4924.00	44.8 AV	54.0	-9.2	1.47 H	85	37.90	6.90
ANTENNA POLARITY & TEST DISTANCE: VERTICAL AT 3 M								
NO.	FREQ. (MHz)	EMISSION LEVEL (dBuV/m)	LIMIT (dBuV/m)	MARGIN (dB)	ANTENNA HEIGHT (m)	TABLE ANGLE (Degree)	RAW VALUE (dBuV)	CORRECTION FACTOR (dB/m)
1	*2462.00	110.0 PK			1.52 V	281	76.80	33.20
2	*2462.00	106.3 AV			1.52 V	281	73.10	33.20
3	2483.50	61.1 PK	74.0	-12.9	1.20 V	303	27.80	33.30
4	2483.50	53.3 AV	54.0	-0.7	1.20 V	303	20.00	33.30
5	4924.00	49.9 PK	74.0	-24.1	1.32 V	166	43.00	6.90
6	4924.00	45.5 AV	54.0	-8.5	1.32 V	166	38.60	6.90

Remarks:

1. Emission Level(dBuV/m) = Raw Value(dBuV) + Correction Factor(dB/m)
2. Correction Factor(dB/m) = Antenna Factor(dB/m) + Cable Factor(dB) – Pre-Amplifier Factor(dB)
3. The other emission levels were very low against the limit.
4. Margin value = Emission Level – Limit value
5. " * ": Fundamental frequency.

802.11g

CHANNEL	TX Channel 1	DETECTOR FUNCTION	Peak (PK)
FREQUENCY RANGE	1GHz ~ 25GHz		Average (AV)

ANTENNA POLARITY & TEST DISTANCE: HORIZONTAL AT 3 M

NO.	FREQ. (MHz)	EMISSION LEVEL (dBuV/m)	LIMIT (dBuV/m)	MARGIN (dB)	ANTENNA HEIGHT (m)	TABLE ANGLE (Degree)	RAW VALUE (dBuV)	CORRECTION FACTOR (dB/m)
1	2390.00	69.2 PK	74.0	-4.8	1.57 H	355	36.30	32.90
2	2390.00	52.1 AV	54.0	-1.9	1.57 H	355	19.20	32.90
3	*2412.00	100.9 PK			2.52 H	0	68.00	32.90
4	*2412.00	91.5 AV			2.52 H	0	58.60	32.90
5	4824.00	48.2 PK	74.0	-25.8	1.33 H	225	41.50	6.70
6	4824.00	36.3 AV	54.0	-17.7	1.33 H	225	29.60	6.70

ANTENNA POLARITY & TEST DISTANCE: VERTICAL AT 3 M

NO.	FREQ. (MHz)	EMISSION LEVEL (dBuV/m)	LIMIT (dBuV/m)	MARGIN (dB)	ANTENNA HEIGHT (m)	TABLE ANGLE (Degree)	RAW VALUE (dBuV)	CORRECTION FACTOR (dB/m)
1	2390.00	70.1 PK	74.0	-3.9	1.76 V	258	37.20	32.90
2	2390.00	53.5 AV	54.0	-0.5	1.76 V	258	20.60	32.90
3	*2412.00	105.8 PK			1.13 V	257	72.90	32.90
4	*2412.00	96.8 AV			1.13 V	257	63.90	32.90
5	4824.00	49.3 PK	74.0	-24.7	1.52 V	96	42.60	6.70
6	4824.00	36.8 AV	54.0	-17.2	1.52 V	96	30.10	6.70

Remarks:

1. Emission Level(dBuV/m) = Raw Value(dBuV) + Correction Factor(dB/m)
2. Correction Factor(dB/m) = Antenna Factor(dB/m) + Cable Factor(dB) – Pre-Amplifier Factor(dB)
3. The other emission levels were very low against the limit.
4. Margin value = Emission Level – Limit value
5. " * " : Fundamental frequency.

CHANNEL	TX Channel 6	DETECTOR FUNCTION	Peak (PK)
FREQUENCY RANGE	1GHz ~ 25GHz		Average (AV)

ANTENNA POLARITY & TEST DISTANCE: HORIZONTAL AT 3 M

NO.	FREQ. (MHz)	EMISSION LEVEL (dBuV/m)	LIMIT (dBuV/m)	MARGIN (dB)	ANTENNA HEIGHT (m)	TABLE ANGLE (Degree)	RAW VALUE (dBuV)	CORRECTION FACTOR (dB/m)
1	2390.00	63.5 PK	74.0	-10.5	2.85 H	6	30.60	32.90
2	2390.00	51.1 AV	54.0	-2.9	2.85 H	6	18.20	32.90
3	*2437.00	105.7 PK			2.65 H	18	72.60	33.10
4	*2437.00	95.7 AV			2.65 H	18	62.60	33.10
5	4874.00	48.5 PK	74.0	-25.5	1.65 H	188	41.70	6.80
6	4874.00	36.3 AV	54.0	-17.7	1.65 H	188	29.50	6.80

ANTENNA POLARITY & TEST DISTANCE: VERTICAL AT 3 M

NO.	FREQ. (MHz)	EMISSION LEVEL (dBuV/m)	LIMIT (dBuV/m)	MARGIN (dB)	ANTENNA HEIGHT (m)	TABLE ANGLE (Degree)	RAW VALUE (dBuV)	CORRECTION FACTOR (dB/m)
1	2390.00	68.5 PK	74.0	-5.5	1.60 V	277	35.60	32.90
2	2390.00	53.0 AV	54.0	-1.0	1.60 V	277	20.10	32.90
3	*2437.00	110.1 PK			1.59 V	288	77.00	33.10
4	*2437.00	101.0 AV			1.59 V	288	67.90	33.10
5	4874.00	49.6 PK	74.0	-24.4	1.56 V	78	42.80	6.80
6	4874.00	37.1 AV	54.0	-16.9	1.56 V	78	30.30	6.80

Remarks:

1. Emission Level(dBuV/m) = Raw Value(dBuV) + Correction Factor(dB/m)
2. Correction Factor(dB/m) = Antenna Factor(dB/m) + Cable Factor(dB) – Pre-Amplifier Factor(dB)
3. The other emission levels were very low against the limit.
4. Margin value = Emission Level – Limit value
5. " * ": Fundamental frequency.

CHANNEL	TX Channel 11	DETECTOR FUNCTION	Peak (PK)
FREQUENCY RANGE	1GHz ~ 25GHz		Average (AV)

ANTENNA POLARITY & TEST DISTANCE: HORIZONTAL AT 3 M								
NO.	FREQ. (MHz)	EMISSION LEVEL (dBuV/m)	LIMIT (dBuV/m)	MARGIN (dB)	ANTENNA HEIGHT (m)	TABLE ANGLE (Degree)	RAW VALUE (dBuV)	CORRECTION FACTOR (dB/m)
1	*2462.00	105.4 PK			2.72 H	9	72.20	33.20
2	*2462.00	95.7 AV			2.72 H	9	62.50	33.20
3	2483.50	64.6 PK	74.0	-9.4	2.13 H	358	31.30	33.30
4	2483.50	52.1 AV	54.0	-1.9	2.13 H	358	18.80	33.30
5	4924.00	49.4 PK	74.0	-24.6	1.13 H	268	42.50	6.90
6	4924.00	37.0 AV	54.0	-17.0	1.13 H	268	30.10	6.90

ANTENNA POLARITY & TEST DISTANCE: VERTICAL AT 3 M								
NO.	FREQ. (MHz)	EMISSION LEVEL (dBuV/m)	LIMIT (dBuV/m)	MARGIN (dB)	ANTENNA HEIGHT (m)	TABLE ANGLE (Degree)	RAW VALUE (dBuV)	CORRECTION FACTOR (dB/m)
1	*2462.00	108.9 PK			3.34 V	341	75.70	33.20
2	*2462.00	99.2 AV			3.34 V	341	66.00	33.20
3	2483.50	70.1 PK	74.0	-3.9	3.17 V	168	36.80	33.30
4	2483.50	53.4 AV	54.0	-0.6	3.17 V	168	20.10	33.30
5	4924.00	50.5 PK	74.0	-23.5	1.52 V	114	43.60	6.90
6	4924.00	38.1 AV	54.0	-15.9	1.52 V	114	31.20	6.90

Remarks:

1. Emission Level(dBuV/m) = Raw Value(dBuV) + Correction Factor(dB/m)
2. Correction Factor(dB/m) = Antenna Factor(dB/m) + Cable Factor(dB) – Pre-Amplifier Factor(dB)
3. The other emission levels were very low against the limit.
4. Margin value = Emission Level – Limit value
5. " * ": Fundamental frequency.

802.11n (HT20)

CHANNEL	TX Channel 1	DETECTOR FUNCTION	Peak (PK)
FREQUENCY RANGE	1GHz ~ 25GHz		Average (AV)

ANTENNA POLARITY & TEST DISTANCE: HORIZONTAL AT 3 M

NO.	FREQ. (MHz)	EMISSION LEVEL (dBuV/m)	LIMIT (dBuV/m)	MARGIN (dB)	ANTENNA HEIGHT (m)	TABLE ANGLE (Degree)	RAW VALUE (dBuV)	CORRECTION FACTOR (dB/m)
1	2390.00	69.3 PK	74.0	-4.7	2.58 H	224	36.40	32.90
2	2390.00	50.6 AV	54.0	-3.4	2.58 H	224	17.70	32.90
3	*2412.00	102.6 PK			2.61 H	253	69.70	32.90
4	*2412.00	92.3 AV			2.61 H	253	59.40	32.90
5	4824.00	49.0 PK	74.0	-25.0	1.95 H	113	42.30	6.70
6	4824.00	37.1 AV	54.0	-16.9	1.95 H	113	30.40	6.70

ANTENNA POLARITY & TEST DISTANCE: VERTICAL AT 3 M

NO.	FREQ. (MHz)	EMISSION LEVEL (dBuV/m)	LIMIT (dBuV/m)	MARGIN (dB)	ANTENNA HEIGHT (m)	TABLE ANGLE (Degree)	RAW VALUE (dBuV)	CORRECTION FACTOR (dB/m)
1	2390.00	73.0 PK	74.0	-1.0	2.58 V	278	40.10	32.90
2	2390.00	53.0 AV	54.0	-1.0	2.58 V	278	20.10	32.90
3	*2412.00	106.4 PK			2.56 V	112	73.50	32.90
4	*2412.00	97.1 AV			2.56 V	112	64.20	32.90
5	4824.00	50.4 PK	74.0	-23.6	1.20 V	138	43.70	6.70
6	4824.00	37.8 AV	54.0	-16.2	1.20 V	138	31.10	6.70

Remarks:

1. Emission Level(dBuV/m) = Raw Value(dBuV) + Correction Factor(dB/m)
2. Correction Factor(dB/m) = Antenna Factor(dB/m) + Cable Factor(dB) – Pre-Amplifier Factor(dB)
3. The other emission levels were very low against the limit.
4. Margin value = Emission Level – Limit value
5. " * ": Fundamental frequency.

CHANNEL	TX Channel 6	DETECTOR FUNCTION	Peak (PK)
FREQUENCY RANGE	1GHz ~ 25GHz		Average (AV)

ANTENNA POLARITY & TEST DISTANCE: HORIZONTAL AT 3 M

NO.	FREQ. (MHz)	EMISSION LEVEL (dBuV/m)	LIMIT (dBuV/m)	MARGIN (dB)	ANTENNA HEIGHT (m)	TABLE ANGLE (Degree)	RAW VALUE (dBuV)	CORRECTION FACTOR (dB/m)
1	2390.00	61.2 PK	74.0	-12.8	2.26 H	211	28.30	32.90
2	2390.00	50.1 AV	54.0	-3.9	2.26 H	211	17.20	32.90
3	*2437.00	107.5 PK			2.56 H	212	74.40	33.10
4	*2437.00	97.6 AV			2.56 H	212	64.50	33.10
5	4874.00	48.9 PK	74.0	-25.1	1.68 H	112	42.10	6.80
6	4874.00	37.2 AV	54.0	-16.8	1.68 H	112	30.40	6.80

ANTENNA POLARITY & TEST DISTANCE: VERTICAL AT 3 M

NO.	FREQ. (MHz)	EMISSION LEVEL (dBuV/m)	LIMIT (dBuV/m)	MARGIN (dB)	ANTENNA HEIGHT (m)	TABLE ANGLE (Degree)	RAW VALUE (dBuV)	CORRECTION FACTOR (dB/m)
1	2390.00	64.1 PK	74.0	-9.9	3.80 V	172	31.20	32.90
2	2390.00	53.2 AV	54.0	-0.8	3.80 V	172	20.30	32.90
3	*2437.00	111.8 PK			1.70 V	164	78.70	33.10
4	*2437.00	102.2 AV			1.70 V	164	69.10	33.10
5	4874.00	50.5 PK	74.0	-23.5	2.62 V	117	43.70	6.80
6	4874.00	38.2 AV	54.0	-15.8	2.62 V	117	31.40	6.80

Remarks:

1. Emission Level(dBuV/m) = Raw Value(dBuV) + Correction Factor(dB/m)
2. Correction Factor(dB/m) = Antenna Factor(dB/m) + Cable Factor(dB) – Pre-Amplifier Factor(dB)
3. The other emission levels were very low against the limit.
4. Margin value = Emission Level – Limit value
5. " * ": Fundamental frequency.

CHANNEL	TX Channel 11	DETECTOR FUNCTION	Peak (PK)
FREQUENCY RANGE	1GHz ~ 25GHz		Average (AV)

ANTENNA POLARITY & TEST DISTANCE: HORIZONTAL AT 3 M								
NO.	FREQ. (MHz)	EMISSION LEVEL (dBuV/m)	LIMIT (dBuV/m)	MARGIN (dB)	ANTENNA HEIGHT (m)	TABLE ANGLE (Degree)	RAW VALUE (dBuV)	CORRECTION FACTOR (dB/m)
1	*2462.00	102.9 PK			2.54 H	189	69.70	33.20
2	*2462.00	92.6 AV			2.54 H	189	59.40	33.20
3	2483.50	67.9 PK	74.0	-6.1	2.25 H	126	34.60	33.30
4	2483.50	51.1 AV	54.0	-2.9	2.25 H	126	17.80	33.30
5	4924.00	49.5 PK	74.0	-24.5	1.89 H	12	42.60	6.90
6	4924.00	37.0 AV	54.0	-17.0	1.89 H	12	30.10	6.90

ANTENNA POLARITY & TEST DISTANCE: VERTICAL AT 3 M								
NO.	FREQ. (MHz)	EMISSION LEVEL (dBuV/m)	LIMIT (dBuV/m)	MARGIN (dB)	ANTENNA HEIGHT (m)	TABLE ANGLE (Degree)	RAW VALUE (dBuV)	CORRECTION FACTOR (dB/m)
1	*2462.00	106.2 PK			2.47 V	317	73.00	33.20
2	*2462.00	96.6 AV			2.47 V	317	63.40	33.20
3	2483.50	70.8 PK	74.0	-3.2	1.68 V	283	37.50	33.30
4	2483.50	53.4 AV	54.0	-0.6	1.68 V	283	20.10	33.30
5	4924.00	50.5 PK	74.0	-23.5	1.86 V	114	43.60	6.90
6	4924.00	38.6 AV	54.0	-15.4	1.86 V	114	31.70	6.90

Remarks:

1. Emission Level(dBuV/m) = Raw Value(dBuV) + Correction Factor(dB/m)
2. Correction Factor(dB/m) = Antenna Factor(dB/m) + Cable Factor(dB) – Pre-Amplifier Factor(dB)
3. The other emission levels were very low against the limit.
4. Margin value = Emission Level – Limit value
5. " * ": Fundamental frequency.

802.11n (HT40)

CHANNEL	TX Channel 3	DETECTOR FUNCTION	Peak (PK)
FREQUENCY RANGE	1GHz ~ 25GHz		Average (AV)

ANTENNA POLARITY & TEST DISTANCE: HORIZONTAL AT 3 M								
NO.	FREQ. (MHz)	EMISSION LEVEL (dBuV/m)	LIMIT (dBuV/m)	MARGIN (dB)	ANTENNA HEIGHT (m)	TABLE ANGLE (Degree)	RAW VALUE (dBuV)	CORRECTION FACTOR (dB/m)
1	2390.00	70.3 PK	74.0	-3.7	2.42 H	213	38.10	32.20
2	2390.00	49.0 AV	54.0	-5.0	2.42 H	213	16.80	32.20
3	*2422.00	102.9 PK			2.36 H	200	70.50	32.40
4	*2422.00	92.4 AV			2.36 H	200	60.00	32.40
5	4844.00	47.2 PK	74.0	-26.8	3.65 H	143	45.10	2.10
6	4844.00	33.4 AV	54.0	-20.6	3.65 H	143	31.30	2.10
ANTENNA POLARITY & TEST DISTANCE: VERTICAL AT 3 M								
NO.	FREQ. (MHz)	EMISSION LEVEL (dBuV/m)	LIMIT (dBuV/m)	MARGIN (dB)	ANTENNA HEIGHT (m)	TABLE ANGLE (Degree)	RAW VALUE (dBuV)	CORRECTION FACTOR (dB/m)
1	2390.00	73.2 PK	74.0	-0.8	3.40 V	241	41.00	32.20
2	2390.00	50.9 AV	54.0	-3.1	3.40 V	241	18.70	32.20
3	*2422.00	104.8 PK			3.72 V	241	72.40	32.40
4	*2422.00	94.7 AV			3.72 V	241	62.30	32.40
5	4844.00	47.5 PK	74.0	-26.5	1.35 V	79	45.40	2.10
6	4844.00	33.6 AV	54.0	-20.4	1.35 V	79	31.50	2.10

Remarks:

1. Emission Level(dBuV/m) = Raw Value(dBuV) + Correction Factor(dB/m)
2. Correction Factor(dB/m) = Antenna Factor(dB/m) + Cable Factor(dB) – Pre-Amplifier Factor(dB)
3. The other emission levels were very low against the limit.
4. Margin value = Emission Level – Limit value
5. " * ": Fundamental frequency.

CHANNEL	TX Channel 6	DETECTOR FUNCTION	Peak (PK)
FREQUENCY RANGE	1GHz ~ 25GHz		Average (AV)

ANTENNA POLARITY & TEST DISTANCE: HORIZONTAL AT 3 M								
NO.	FREQ. (MHz)	EMISSION LEVEL (dBuV/m)	LIMIT (dBuV/m)	MARGIN (dB)	ANTENNA HEIGHT (m)	TABLE ANGLE (Degree)	RAW VALUE (dBuV)	CORRECTION FACTOR (dB/m)
1	2390.00	68.7 PK	74.0	-5.3	2.48 H	215	36.50	32.20
2	2390.00	50.8 AV	54.0	-3.2	2.48 H	215	18.60	32.20
3	*2437.00	105.1 PK			2.31 H	237	72.70	32.40
4	*2437.00	95.7 AV			2.31 H	237	63.30	32.40
5	2483.50	66.1 PK	74.0	-7.9	2.35 H	241	33.40	32.70
6	2483.50	49.4 AV	54.0	-4.6	2.35 H	241	16.70	32.70
7	4874.00	47.6 PK	74.0	-26.4	3.71 H	138	45.40	2.20
8	4874.00	33.6 AV	54.0	-20.4	3.71 H	138	31.40	2.20

ANTENNA POLARITY & TEST DISTANCE: VERTICAL AT 3 M								
NO.	FREQ. (MHz)	EMISSION LEVEL (dBuV/m)	LIMIT (dBuV/m)	MARGIN (dB)	ANTENNA HEIGHT (m)	TABLE ANGLE (Degree)	RAW VALUE (dBuV)	CORRECTION FACTOR (dB/m)
1	2390.00	72.3 PK	74.0	-1.7	3.30 V	266	40.10	32.20
2	2390.00	53.0 AV	54.0	-1.0	3.30 V	266	20.80	32.20
3	*2437.00	106.6 PK			3.71 V	215	74.20	32.40
4	*2437.00	96.5 AV			3.71 V	215	64.10	32.40
5	2483.50	68.6 PK	74.0	-5.4	3.86 V	224	35.90	32.70
6	2483.50	51.9 AV	54.0	-2.1	3.86 V	224	19.20	32.70
7	4874.00	47.8 PK	74.0	-26.2	1.43 V	84	45.60	2.20
8	4874.00	34.1 AV	54.0	-19.9	1.43 V	84	31.90	2.20

Remarks:

1. Emission Level(dBuV/m) = Raw Value(dBuV) + Correction Factor(dB/m)
2. Correction Factor(dB/m) = Antenna Factor(dB/m) + Cable Factor(dB) – Pre-Amplifier Factor(dB)
3. The other emission levels were very low against the limit.
4. Margin value = Emission Level – Limit value
5. " * ": Fundamental frequency.

CHANNEL	TX Channel 9	DETECTOR FUNCTION	Peak (PK)
FREQUENCY RANGE	1GHz ~ 25GHz		Average (AV)

ANTENNA POLARITY & TEST DISTANCE: HORIZONTAL AT 3 M								
NO.	FREQ. (MHz)	EMISSION LEVEL (dBuV/m)	LIMIT (dBuV/m)	MARGIN (dB)	ANTENNA HEIGHT (m)	TABLE ANGLE (Degree)	RAW VALUE (dBuV)	CORRECTION FACTOR (dB/m)
1	*2452.00	102.9 PK			2.43 H	212	70.30	32.60
2	*2452.00	92.4 AV			2.43 H	212	59.80	32.60
3	2483.50	70.3 PK	74.0	-3.7	2.58 H	236	37.60	32.70
4	2483.50	49.9 AV	54.0	-4.1	2.58 H	236	17.20	32.70
5	4904.00	47.5 PK	74.0	-26.5	3.54 H	146	45.30	2.20
6	4904.00	33.7 AV	54.0	-20.3	3.54 H	146	31.50	2.20
ANTENNA POLARITY & TEST DISTANCE: VERTICAL AT 3 M								
NO.	FREQ. (MHz)	EMISSION LEVEL (dBuV/m)	LIMIT (dBuV/m)	MARGIN (dB)	ANTENNA HEIGHT (m)	TABLE ANGLE (Degree)	RAW VALUE (dBuV)	CORRECTION FACTOR (dB/m)
1	*2452.00	105.5 PK			3.50 V	218	72.90	32.60
2	*2452.00	94.8 AV			3.50 V	218	62.20	32.60
3	2483.50	73.0 PK	74.0	-1.0	3.49 V	217	40.30	32.70
4	2483.50	51.3 AV	54.0	-2.7	3.49 V	217	18.60	32.70
5	4904.00	47.7 PK	74.0	-26.3	1.37 V	91	45.50	2.20
6	4904.00	33.9 AV	54.0	-20.1	1.37 V	91	31.70	2.20

Remarks:

1. Emission Level(dBuV/m) = Raw Value(dBuV) + Correction Factor(dB/m)
2. Correction Factor(dB/m) = Antenna Factor(dB/m) + Cable Factor(dB) – Pre-Amplifier Factor(dB)
3. The other emission levels were very low against the limit.
4. Margin value = Emission Level – Limit value
5. " * ": Fundamental frequency.

Below 1GHz worst-case data: 802.11b

CHANNEL	TX Channel 6	DETECTOR FUNCTION	Quasi-Peak (QP)
FREQUENCY RANGE	9kHz ~ 1GHz	TEST MODE	A

ANTENNA POLARITY & TEST DISTANCE: HORIZONTAL AT 3 M								
NO.	FREQ. (MHz)	EMISSION LEVEL (dBuV/m)	LIMIT (dBuV/m)	MARGIN (dB)	ANTENNA HEIGHT (m)	TABLE ANGLE (Degree)	RAW VALUE (dBuV)	CORRECTION FACTOR (dB/m)
1	30.00	27.7 QP	40.0	-12.3	1.99 H	12	43.70	-16.00
2	80.44	26.5 QP	40.0	-13.5	1.50 H	15	44.70	-18.20
3	175.50	29.4 QP	43.5	-14.1	1.24 H	135	43.30	-13.90
4	288.02	28.1 QP	46.0	-17.9	1.00 H	310	39.50	-11.40
5	375.32	29.8 QP	46.0	-16.2	1.00 H	223	39.20	-9.40
6	625.58	36.1 QP	46.0	-9.9	1.24 H	49	39.10	-3.00
ANTENNA POLARITY & TEST DISTANCE: VERTICAL AT 3 M								
NO.	FREQ. (MHz)	EMISSION LEVEL (dBuV/m)	LIMIT (dBuV/m)	MARGIN (dB)	ANTENNA HEIGHT (m)	TABLE ANGLE (Degree)	RAW VALUE (dBuV)	CORRECTION FACTOR (dB/m)
1	31.94	33.6 QP	40.0	-6.4	1.00 V	325	49.60	-16.00
2	111.48	33.8 QP	43.5	-9.7	1.00 V	184	50.50	-16.70
3	134.76	35.3 QP	43.5	-8.2	1.24 V	231	49.70	-14.40
4	175.50	31.0 QP	43.5	-12.5	1.00 V	269	44.90	-13.90
5	499.48	31.3 QP	46.0	-14.7	1.00 V	213	37.80	-6.50
6	875.84	37.5 QP	46.0	-8.5	1.50 V	154	35.30	2.20

Remarks:

1. Emission Level(dBuV/m) = Raw Value(dBuV) + Correction Factor(dB/m)
2. Correction Factor(dB/m) = Antenna Factor(dB/m) + Cable Factor(dB) – Pre-Amplifier Factor(dB)
3. The other emission levels were very low against the limit.
4. Margin value = Emission Level – Limit value

CHANNEL	TX Channel 6	DETECTOR FUNCTION	Quasi-Peak (QP)
FREQUENCY RANGE	9kHz ~ 1GHz	TEST MODE	B

ANTENNA POLARITY & TEST DISTANCE: HORIZONTAL AT 3 M

NO.	FREQ. (MHz)	EMISSION LEVEL (dBuV/m)	LIMIT (dBuV/m)	MARGIN (dB)	ANTENNA HEIGHT (m)	TABLE ANGLE (Degree)	RAW VALUE (dBuV)	CORRECTION FACTOR (dB/m)
1	30.00	28.5 QP	40.0	-11.5	1.01 H	231	44.50	-16.00
2	64.92	31.7 QP	40.0	-8.3	1.51 H	206	46.70	-15.00
3	194.90	29.0 QP	43.5	-14.5	1.51 H	272	44.60	-15.60
4	289.96	30.2 QP	46.0	-15.8	1.01 H	235	41.60	-11.40
5	375.32	32.0 QP	46.0	-14.0	1.01 H	225	41.40	-9.40
6	625.58	38.6 QP	46.0	-7.4	1.26 H	268	41.60	-3.00

ANTENNA POLARITY & TEST DISTANCE: VERTICAL AT 3 M

NO.	FREQ. (MHz)	EMISSION LEVEL (dBuV/m)	LIMIT (dBuV/m)	MARGIN (dB)	ANTENNA HEIGHT (m)	TABLE ANGLE (Degree)	RAW VALUE (dBuV)	CORRECTION FACTOR (dB/m)
1	31.94	38.8 QP	40.0	-1.2	1.99 V	187	54.80	-16.00
2	49.40	38.8 QP	40.0	-1.2	1.00 V	65	52.80	-14.00
3	105.66	26.4 QP	43.5	-17.1	1.00 V	305	43.90	-17.50
4	191.02	27.9 QP	43.5	-15.6	1.24 V	286	43.40	-15.50
5	288.02	27.3 QP	46.0	-18.7	1.99 V	311	38.70	-11.40
6	625.58	30.9 QP	46.0	-15.1	1.00 V	173	33.90	-3.00

Remarks:

1. Emission Level(dBuV/m) = Raw Value(dBuV) + Correction Factor(dB/m)
2. Correction Factor(dB/m) = Antenna Factor(dB/m) + Cable Factor(dB) – Pre-Amplifier Factor(dB)
3. The other emission levels were very low against the limit.
4. Margin value = Emission Level – Limit value

4.2 Conducted Emission Measurement

4.2.1 Limits of Conducted Emission Measurement

Frequency (MHz)	Conducted Limit (dBuV)	
	Quasi-peak	Average
0.15 - 0.5	66 - 56	56 - 46
0.50 - 5.0	56	46
5.0 - 30.0	60	50

- Note:** 1. The lower limit shall apply at the transition frequencies.
 2. The limit decreases in line with the logarithm of the frequency in the range of 0.15 to 0.50MHz.

4.2.2 Test Instruments

Description & Manufacturer	Model No.	Serial No.	Cal. Date	Cal. Due
Test Receiver ROHDE & SCHWARZ	ESCI	100613	Nov. 21, 2016	Nov. 20, 2017
RF signal cable (with 10dB PAD) Woken	5D-FB	Cable-cond1-01	Dec. 22, 2016	Dec. 21, 2017
LISN ROHDE & SCHWARZ (EUT)	ESH3-Z5	835239/001	Mar. 10, 2017	Mar. 09, 2018
LISN ROHDE & SCHWARZ (Peripheral)	ESH3-Z5	100311	Jul. 28, 2016	Jul. 27, 2017
Software ADT	BV ADT_Cond_ V7.3.7.3	NA	NA	NA

- Note:** 1. The calibration interval of the above test instruments is 12 months and the calibrations are traceable to NML/ROC and NIST/USA.
 2. The test was performed in HwaYa Shielded Room 1.
 3. The VCCI Site Registration No. is C-2040.

4.2.3 Test Procedures

- The EUT was placed 0.4 meters from the conducting wall of the shielded room with EUT being connected to the power mains through a line impedance stabilization network (LISN). Other support units were connected to the power mains through another LISN. The two LISNs provide 50 ohm/ 50uH of coupling impedance for the measuring instrument.
- Both lines of the power mains connected to the EUT were checked for maximum conducted interference.
- The frequency range from 150kHz to 30MHz was searched. Emission levels under (Limit - 20dB) was not recorded.

Note: The resolution bandwidth and video bandwidth of test receiver is 9kHz for quasi-peak detection (QP) and average detection (AV) at frequency 0.15MHz-30MHz.

4.2.4 Deviation from Test Standard

No deviation.

4.2.5 Test Setup

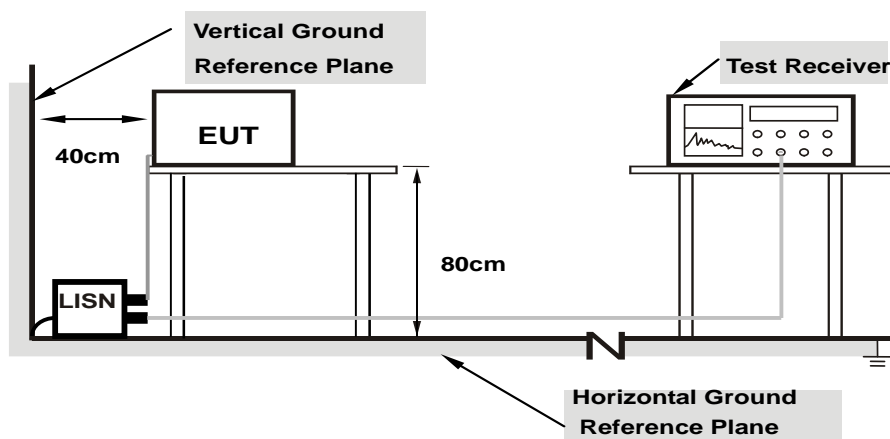

Note: 1.Support units were connected to second LISN.

For the actual test configuration, please refer to the attached file (Test Setup Photo).

4.2.6 EUT Operating Conditions

Same as 4.1.6.

4.2.7 Test Results

Worst-case data: 802.11b

Phase	Line (L)	Detector Function	Quasi-Peak (QP) / Average (AV)
Test Mode	A		

No	Freq. [MHz]	Corr. Factor (dB)	Reading Value		Emission Level		Limit		Margin	
			[dB (uV)]		[dB (uV)]		[dB (uV)]		(dB)	
			Q.P.	AV.	Q.P.	AV.	Q.P.	AV.	Q.P.	AV.
1	0.15800	10.41	38.25	22.69	48.66	33.10	65.57	55.57	-16.91	-22.47
2	0.20600	10.43	27.33	11.45	37.76	21.88	63.37	53.37	-25.61	-31.49
3	0.38200	10.50	35.26	26.24	45.76	36.74	58.24	48.24	-12.48	-11.50
4	0.57000	10.50	22.49	13.43	32.99	23.93	56.00	46.00	-23.01	-22.07
5	1.59400	10.50	17.31	9.24	27.81	19.74	56.00	46.00	-28.19	-26.26
6	5.23000	10.71	13.53	5.83	24.24	16.54	60.00	50.00	-35.76	-33.46

Remarks:

1. Q.P. and AV. are abbreviations of quasi-peak and average individually.
2. The emission levels of other frequencies were very low against the limit.
3. Margin value = Emission level - Limit value
4. Correction factor = Insertion loss + Cable loss
5. Emission Level = Correction Factor + Reading Value.

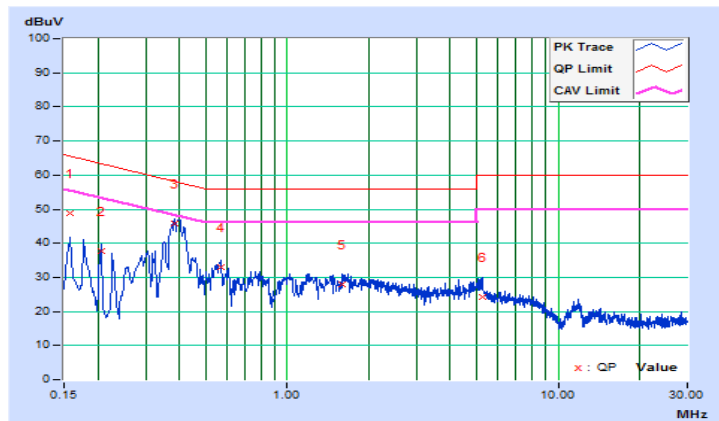

Phase	Neutral (N)	Detector Function	Quasi-Peak (QP) / Average (AV)
Test Mode	A		

No	Freq. [MHz]	Corr. Factor (dB)	Reading Value [dB (uV)]		Emission Level [dB (uV)]		Limit [dB (uV)]		Margin (dB)	
			Q.P.	AV.	Q.P.	AV.	Q.P.	AV.	Q.P.	AV.
			1	0.15000	10.15	36.23	22.08	46.38	32.23	66.00
2	0.16623	10.17	35.15	20.24	45.32	30.41	65.15	55.15	-19.83	-24.74
3	0.39400	10.23	36.63	29.64	46.86	39.87	57.98	47.98	-11.12	-8.11
4	0.57342	10.23	23.29	13.54	33.52	23.77	56.00	46.00	-22.48	-22.23
5	0.77800	10.24	20.23	11.89	30.47	22.13	56.00	46.00	-25.53	-23.87
6	4.47800	10.44	14.83	8.14	25.27	18.58	56.00	46.00	-30.73	-27.42

Remarks:

1. Q.P. and AV. are abbreviations of quasi-peak and average individually.
2. The emission levels of other frequencies were very low against the limit.
3. Margin value = Emission level - Limit value
4. Correction factor = Insertion loss + Cable loss
5. Emission Level = Correction Factor + Reading Value.

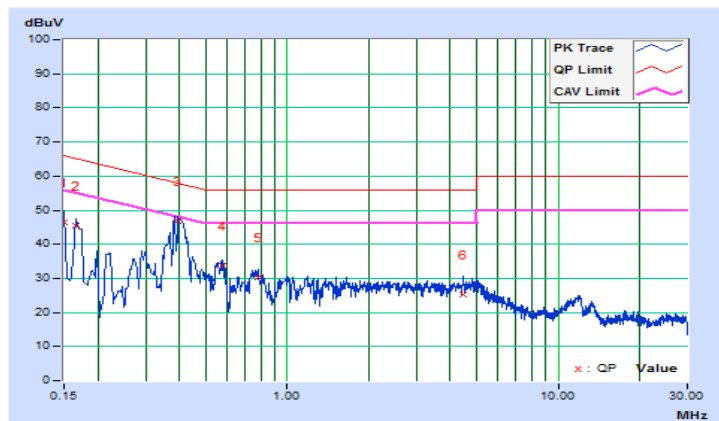

Phase	Line (L)	Detector Function	Quasi-Peak (QP) / Average (AV)
Test Mode	B		

No	Freq. [MHz]	Corr. Factor (dB)	Reading Value [dB (uV)]		Emission Level [dB (uV)]		Limit [dB (uV)]		Margin (dB)	
			Q.P.	AV.	Q.P.	AV.	Q.P.	AV.	Q.P.	AV.
			1	0.17022	10.42	37.73	23.83	48.15	34.25	64.95
2	0.23412	10.44	27.98	14.29	38.42	24.73	62.30	52.30	-23.88	-27.57
3	0.40820	10.51	23.36	16.12	33.87	26.63	57.68	47.68	-23.81	-21.05
4	0.98148	10.46	18.21	18.15	28.67	28.61	56.00	46.00	-27.33	-17.39
5	2.45400	10.55	16.89	16.48	27.44	27.03	56.00	46.00	-28.56	-18.97
6	17.16600	11.27	33.02	28.80	44.29	40.07	60.00	50.00	-15.71	-9.93

Remarks:

1. Q.P. and AV. are abbreviations of quasi-peak and average individually.
2. The emission levels of other frequencies were very low against the limit.
3. Margin value = Emission level - Limit value
4. Correction factor = Insertion loss + Cable loss
5. Emission Level = Correction Factor + Reading Value.

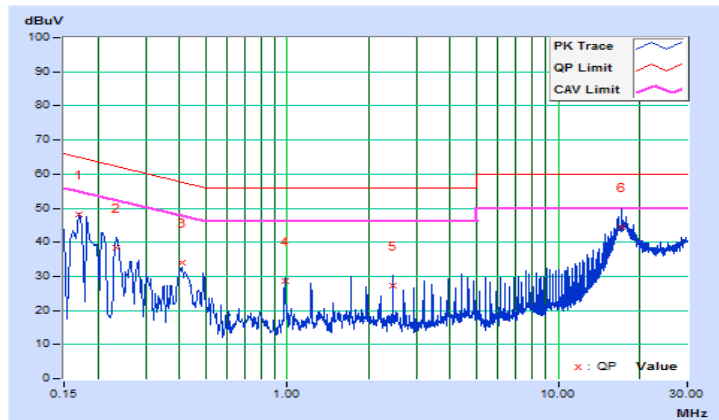

Phase	Neutral (N)	Detector Function	Quasi-Peak (QP) / Average (AV)
Test Mode	B		

No	Freq. [MHz]	Corr. Factor (dB)	Reading Value [dB (uV)]		Emission Level [dB (uV)]		Limit [dB (uV)]		Margin (dB)	
			Q.P.	AV.	Q.P.	AV.	Q.P.	AV.	Q.P.	AV.
			1	0.17430	10.18	33.56	20.51	43.74	30.69	64.75
2	0.25800	10.21	16.02	3.21	26.23	13.42	61.50	51.50	-35.27	-38.08
3	0.42200	10.23	15.37	8.24	25.60	18.47	57.41	47.41	-31.81	-28.94
4	0.56600	10.23	1.30	-3.20	11.53	7.03	56.00	46.00	-44.47	-38.97
5	1.35000	10.26	2.86	-1.15	13.12	9.11	56.00	46.00	-42.88	-36.89
6	16.91800	10.92	36.05	34.13	46.97	45.05	60.00	50.00	-13.03	-4.95

Remarks:

1. Q.P. and AV. are abbreviations of quasi-peak and average individually.
2. The emission levels of other frequencies were very low against the limit.
3. Margin value = Emission level - Limit value
4. Correction factor = Insertion loss + Cable loss
5. Emission Level = Correction Factor + Reading Value.

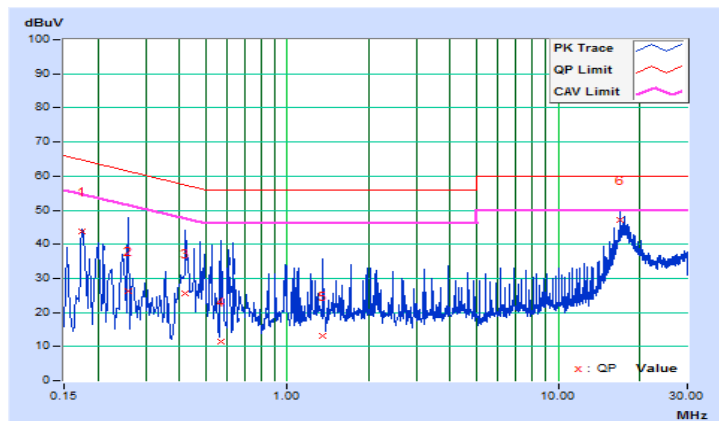

4.3 6dB Bandwidth Measurement

4.3.1 Limits of 6dB Bandwidth Measurement

The minimum of 6dB Bandwidth Measurement is 0.5 MHz.

4.3.2 Test Setup

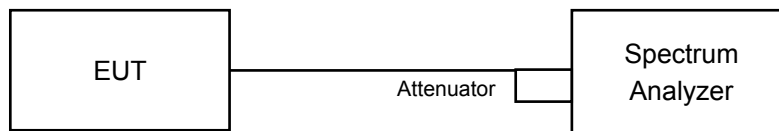

4.3.3 Test Instruments

Refer to section 4.1.2 to get information of above instrument.

4.3.4 Test Procedure

- Set resolution bandwidth (RBW) = 100kHz.
- Set the video bandwidth (VBW) $\geq 3 \times$ RBW, Detector = average.
- Trace mode = max hold.
- Sweep = auto couple.
- Measure the maximum width of the emission that is constrained by the frequencies associated with the two amplitude points (upper and lower) that are attenuated by 6 dB relative to the maximum level measured in the fundamental emission.

4.3.5 Deviation from Test Standard

No deviation.

4.3.6 EUT Operating Conditions

The software provided by client to enable the EUT under transmission condition continuously at lowest, middle and highest channel frequencies individually.

4.3.7 Test Result

1TX

802.11b

Channel	Frequency (MHz)	6dB Bandwidth (MHz)	Minimum Limit (MHz)	Pass / Fail
1	2412	7.55	0.5	Pass
6	2437	8.55	0.5	Pass
11	2462	8.07	0.5	Pass

802.11g

Channel	Frequency (MHz)	6dB Bandwidth (MHz)	Minimum Limit (MHz)	Pass / Fail
1	2412	15.26	0.5	Pass
6	2437	15.22	0.5	Pass
11	2462	15.22	0.5	Pass

802.11n (HT20)

Channel	Frequency (MHz)	6dB Bandwidth (MHz)	Minimum Limit (MHz)	Pass / Fail
1	2412	15.25	0.5	Pass
6	2437	15.23	0.5	Pass
11	2462	15.22	0.5	Pass

802.11n (HT40)

Channel	Frequency (MHz)	6dB Bandwidth (MHz)	Minimum Limit (MHz)	Pass / Fail
3	2422	35.34	0.5	Pass
6	2437	35.28	0.5	Pass
9	2452	35.28	0.5	Pass

Spectrum Plot of Worst Value

802.11b

802.11g

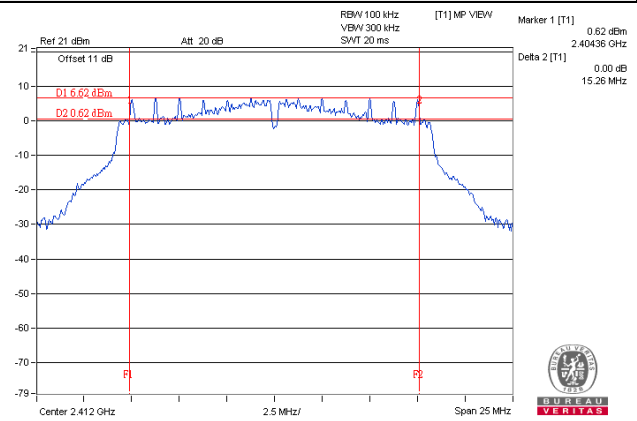
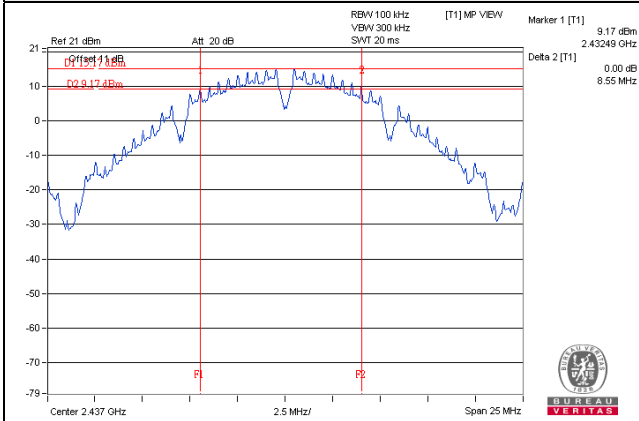

802.11n (HT20)

802.11n (HT40)

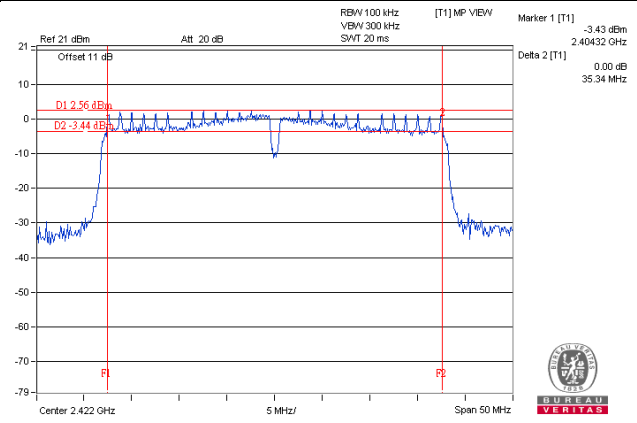
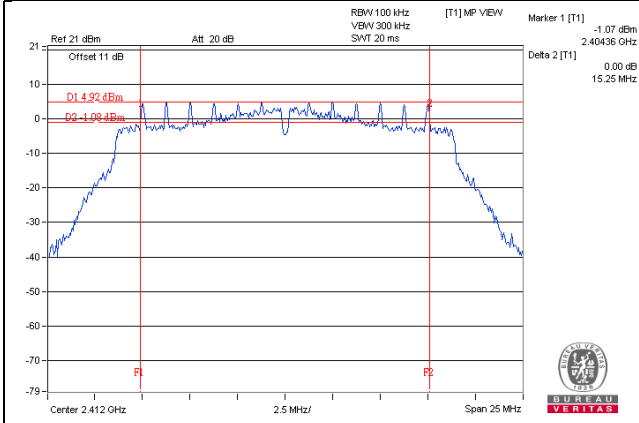

2TX

802.11b

Channel	Frequency (MHz)	6dB Bandwidth (MHz)		Minimum Limit (MHz)	Pass / Fail
		Chain 0	Chain 1		
1	2412	7.54	7.57	0.5	Pass
6	2437	8.04	8.07	0.5	Pass
11	2462	7.60	7.57	0.5	Pass

802.11g

Channel	Frequency (MHz)	6dB Bandwidth (MHz)		Minimum Limit (MHz)	Pass / Fail
		Chain 0	Chain 1		
1	2412	15.26	15.25	0.5	Pass
6	2437	15.23	15.78	0.5	Pass
11	2462	15.22	15.77	0.5	Pass

802.11n (HT20)

Channel	Frequency (MHz)	6dB Bandwidth (MHz)		Minimum Limit (MHz)	Pass / Fail
		Chain 0	Chain 1		
1	2412	15.25	15.76	0.5	Pass
6	2437	15.24	15.23	0.5	Pass
11	2462	15.24	15.23	0.5	Pass

802.11n (HT40)

Channel	Frequency (MHz)	6dB Bandwidth (MHz)		Minimum Limit (MHz)	Pass / Fail
		Chain 0	Chain 1		
3	2422	35.34	35.33	0.5	Pass
6	2437	35.28	35.29	0.5	Pass
9	2452	35.28	35.29	0.5	Pass

Spectrum Plot of Worst Value

802.11b

802.11g

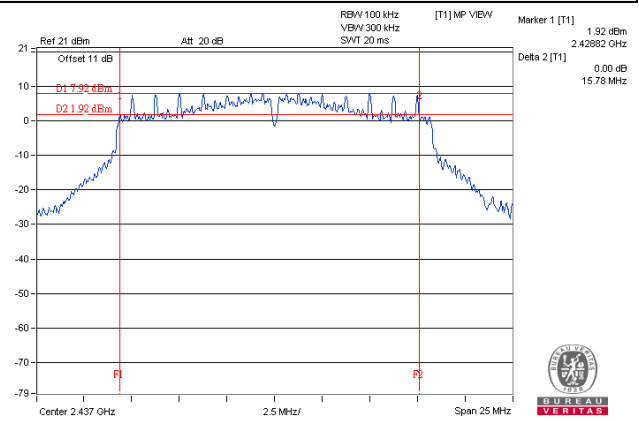
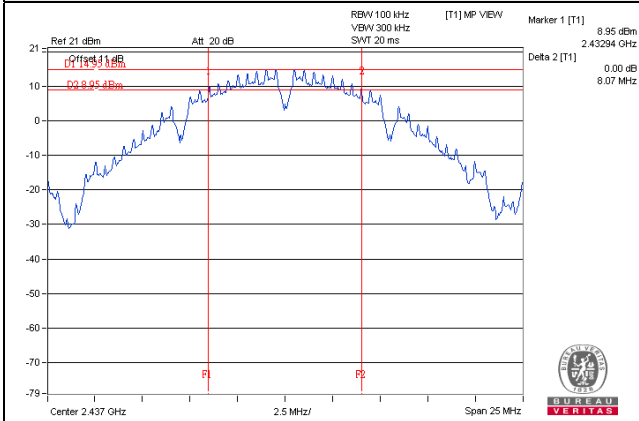

802.11n (HT20)

802.11n (HT40)

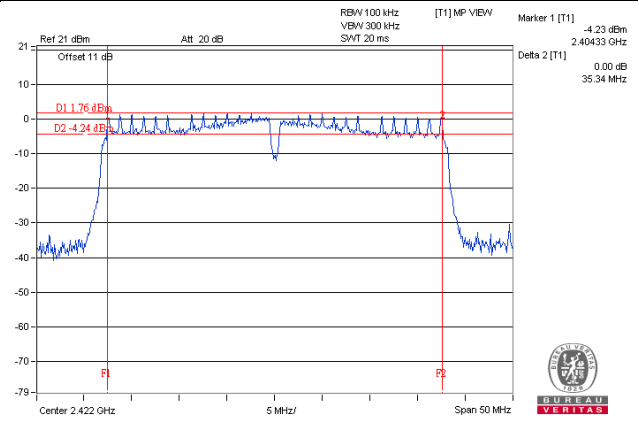
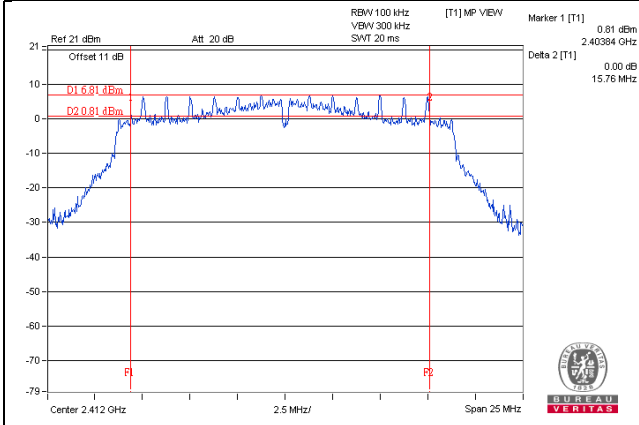

4.4 Conducted Output Power Measurement

4.4.1 Limits of Conducted Output Power Measurement

For systems using digital modulation in the 2400–2483.5 MHz bands: 1 Watt (30dBm)

Per KDB 662911 D01 Multiple Transmitter Output Method of conducted output power measurement on IEEE 802.11 devices,

Array Gain = 0 dB (i.e., no array gain) for $N_{ANT} \leq 4$;

Array Gain = 0 dB (i.e., no array gain) for channel widths ≥ 40 MHz for any N_{ANT} ;

Array Gain = $5 \log(N_{ANT}/N_{SS})$ dB or 3 dB, whichever is less for 20-MHz channel widths with $N_{ANT} \geq 5$.

For power measurements on all other devices: Array Gain = $10 \log(N_{ANT}/N_{SS})$ dB.

4.4.2 Test Setup

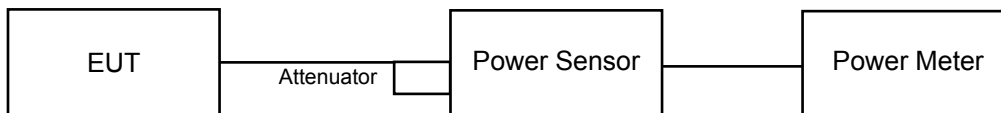

4.4.3 Test Instruments

Refer to section 4.1.2 to get information of above instrument.

4.4.4 Test Procedures

An average power sensor was used on the output port of the EUT. A power meter was used to read the response of the average power sensor. Record the power level.

4.4.5 Deviation from Test Standard

No deviation.

4.4.6 EUT Operating Conditions

Same as item 4.3.6.

4.4.7 Test Results

CDD Mode, 1TX

802.11b

Channel	Frequency (MHz)	Average Power (dBm)	Total Power (mW)	Total Power (dBm)	Limit (dBm)	Pass / Fail
1	2412	19.38	86.696	19.38	30	Pass
6	2437	22.57	180.717	22.57	30	Pass
11	2462	22.22	166.725	22.22	30	Pass

802.11g

Channel	Frequency (MHz)	Average Power (dBm)	Total Power (mW)	Total Power (dBm)	Limit (dBm)	Pass / Fail
1	2412	17.39	54.828	17.39	30	Pass
6	2437	18.63	72.946	18.63	30	Pass
11	2462	18.93	78.163	18.93	30	Pass

802.11n (HT20)

Channel	Frequency (MHz)	Average Power (dBm)	Total Power (mW)	Total Power (dBm)	Limit (dBm)	Pass / Fail
1	2412	15.04	31.915	15.04	30	Pass
6	2437	20.14	103.276	20.14	30	Pass
11	2462	18.00	63.096	18.00	30	Pass

802.11n (HT40)

Channel	Frequency (MHz)	Average Power (dBm)	Total Power (mW)	Total Power (dBm)	Limit (dBm)	Pass / Fail
3	2422	16.70	46.774	16.70	30	Pass
6	2437	22.82	191.426	22.82	30	Pass
9	2452	16.80	47.863	16.80	30	Pass

CDD Mode, 2TX

802.11b

Channel	Frequency (MHz)	Average Power (dBm)		Total Power (mW)	Total Power (dBm)	Limit (dBm)	Pass / Fail
		Chain 0	Chain 1				
1	2412	19.66	19.62	184.092	22.65	30	Pass
6	2437	22.30	22.45	345.616	25.39	30	Pass
11	2462	21.43	21.20	270.821	24.33	30	Pass

802.11g

Channel	Frequency (MHz)	Average Power (dBm)		Total Power (mW)	Total Power (dBm)	Limit (dBm)	Pass / Fail
		Chain 0	Chain 1				
1	2412	16.74	17.68	105.820	20.25	30	Pass
6	2437	18.39	18.81	145.057	21.62	30	Pass
11	2462	18.09	18.79	140.100	21.46	30	Pass

802.11n (HT20)

Channel	Frequency (MHz)	Average Power (dBm)		Total Power (mW)	Total Power (dBm)	Limit (dBm)	Pass / Fail
		Chain 0	Chain 1				
1	2412	17.22	16.68	99.282	19.97	30	Pass
6	2437	19.93	20.08	200.260	23.02	30	Pass
11	2462	17.63	17.97	120.604	20.81	30	Pass

802.11n (HT40)

Channel	Frequency (MHz)	Average Power (dBm)		Total Power (mW)	Total Power (dBm)	Limit (dBm)	Pass / Fail
		Chain 0	Chain 1				
3	2422	15.56	15.87	74.612	18.73	30	Pass
6	2437	17.95	17.35	116.698	20.67	30	Pass
9	2452	15.65	15.94	75.992	18.81	30	Pass

Beamforming Mode

802.11n (HT20)

Channel	Frequency (MHz)	Average Power (dBm)		Total Power (mW)	Total Power (dBm)	Limit (dBm)	Pass / Fail
		Chain 0	Chain 1				
1	2412	13.52	13.92	47.151	16.73	29.46	Pass
6	2437	16.58	16.49	90.065	19.55	29.46	Pass
11	2462	14.11	14.82	56.1020	17.49	29.46	Pass

Note: Directional gain = $10 \log[(10^{G1/20} + 10^{G2/20} + \dots + 10^{GN/20})^2/N]$ = 6.54dBi > 6dBi, so the power limit shall be reduced to $30-(6.54-6) = 29.46$ dBm.

802.11n (HT40)

Channel	Frequency (MHz)	Average Power (dBm)		Total Power (mW)	Total Power (dBm)	Limit (dBm)	Pass / Fail
		Chain 0	Chain 1				
3	2422	13.88	13.52	46.925	16.71	29.46	Pass
6	2437	14.77	14.69	59.436	17.74	29.46	Pass
9	2452	13.73	13.62	46.619	16.69	29.46	Pass

Note: Directional gain = $10 \log[(10^{G1/20} + 10^{G2/20} + \dots + 10^{GN/20})^2/N]$ = 6.54dBi > 6dBi, so the power limit shall be reduced to $30-(6.54-6) = 29.46$ dBm.

4.5 Power Spectral Density Measurement

4.5.1 Limits of Power Spectral Density Measurement

The Maximum of Power Spectral Density Measurement is 8dBm.

4.5.2 Test Setup

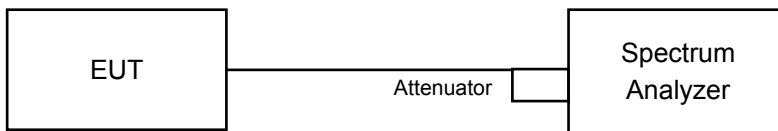

4.5.3 Test Instruments

Refer to section 4.1.2 to get information of above instrument.

4.5.4 Test Procedure

For Average Power (Duty cycle $\geq 98\%$)

- a. Set instrument center frequency to DTS channel center frequency.
- b. Set span to at least 1.5 times the OBW.
- c. Set RBW to: $3 \text{ kHz} \leq \text{RBW} \leq 100 \text{ kHz}$.
- d. Set VBW $\geq 3 \times \text{RBW}$.
- e. Detector = power averaging (RMS) or sample detector (when RMS not available).
- f. Ensure that the number of measurement points in the sweep $\geq 2 \times \text{span}/\text{RBW}$.
- g. Sweep time = auto couple.
- h. Employ trace averaging (RMS) mode over a minimum of 100 traces.
- i. Use the peak marker function to determine the maximum amplitude level.

For Average Power (Duty cycle $< 98\%$)

- a. Measure the duty cycle (x).
- b. Set instrument center frequency to DTS channel center frequency.
- c. Set span to at least 1.5 times the OBW.
- d. Set RBW to: $3 \text{ kHz} \leq \text{RBW} \leq 100 \text{ kHz}$.
- e. Set VBW $\geq 3 \times \text{RBW}$.
- f. Detector = power averaging (RMS) or sample detector (when RMS not available).
- g. Ensure that the number of measurement points in the sweep $\geq 2 \times \text{span}/\text{RBW}$.
- h. Sweep time = auto couple.
- i. Do not use sweep triggering. Allow sweep to "free run".
- j. Employ trace averaging (RMS) mode over a minimum of 100 traces.
- k. Use the peak marker function to determine the maximum amplitude level.
- l. Add $10 \log (1/x)$, where x is the duty cycle measured in step (a), to the measured PSD to compute the average PSD during the actual transmission time.

4.5.5 Deviation from Test Standard

No deviation.

4.5.6 EUT Operating Condition

Same as item 4.3.6

4.5.7 Test Results

1TX

802.11b

Channel	Freq. (MHz)	PSD (dBm/10kHz)	Limit (dBm/3kHz)	Pass /Fail
1	2412	-7.24	8	Pass
6	2437	-4.57	8	Pass
11	2462	-5.00	8	Pass

802.11g

Channel	Freq. (MHz)	PSD W/O Duty Factor (dBm/10kHz)	Duty Factor (dB)	Total PSD With Duty Factor (dBm/10kHz)	Limit (dBm/3kHz)	Pass/Fail
1	2412	-8.38	0.11	-8.27	8	Pass
6	2437	-7.25	0.11	-7.14	8	Pass
11	2462	-7.49	0.11	-7.38	8	Pass

802.11n (HT20)

Channel	Freq. (MHz)	PSD W/O Duty Factor (dBm/10kHz)	Duty Factor (dB)	Total PSD With Duty Factor (dBm/10kHz)	Limit (dBm/3kHz)	Pass/Fail
1	2412	-13.65	0.14	-13.51	8	Pass
6	2437	-8.44	0.14	-8.30	8	Pass
11	2462	-10.34	0.14	-10.20	8	Pass

802.11n (HT40)

Channel	Freq. (MHz)	PSD W/O Duty Factor (dBm/10kHz)	Duty Factor (dB)	Total PSD With Duty Factor (dBm/10kHz)	Limit (dBm/3kHz)	Pass/Fail
3	2422	-14.66	0.26	-14.40	8	Pass
6	2437	-12.52	0.26	-12.26	8	Pass
9	2452	-14.52	0.26	-14.26	8	Pass

Spectrum Plot of Worst Value

802.11b

802.11g

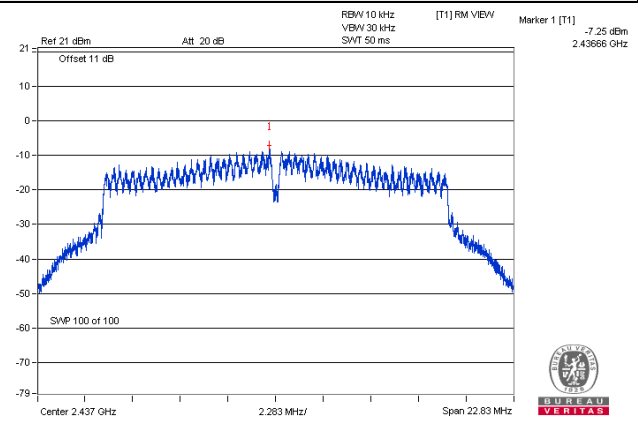
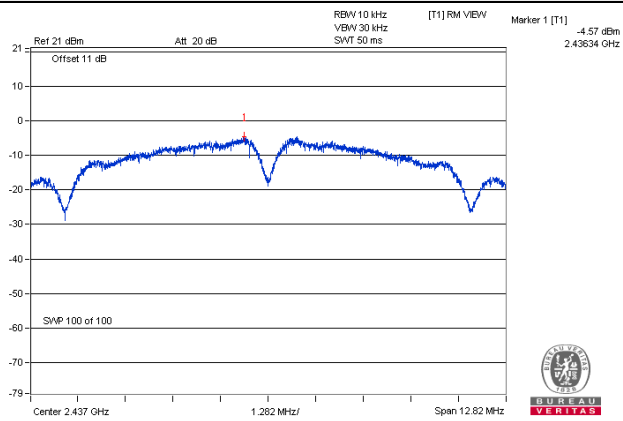

802.11n (HT20)

802.11n (HT40)

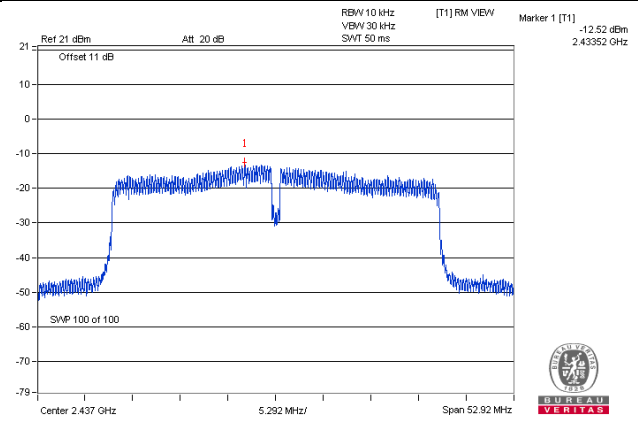
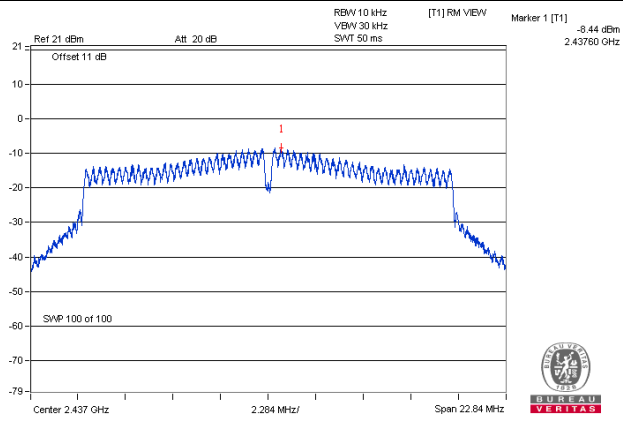

2TX

802.11b

TX chain	Channel	Freq. (MHz)	PSD (dBm/10kHz)	10 log (N=2) dB	Total PSD (dBm/10kHz)	Limit (dBm/3kHz)	Pass /Fail
0	1	2412	-7.55	3.01	-4.54	7.46	Pass
	6	2437	-4.77	3.01	-1.76	7.46	Pass
	11	2462	-5.79	3.01	-2.78	7.46	Pass
1	1	2412	-7.71	3.01	-4.70	7.46	Pass
	6	2437	-4.61	3.01	-1.60	7.46	Pass
	11	2462	-5.72	3.01	-2.71	7.46	Pass

Note:

- Method 1 of power density measurement of KDB 662911 is using for calculating total power density. Total power density is summing entire spectra across corresponding frequency bins on the various outputs by computer.
- Directional gain = $10 \log[(10^{G1/20} + 10^{G2/20} + \dots + 10^{GN/20})^2/N]$ = 6.54dBi > 6dBi, so the power density limit shall be reduced to $8-(6.54-6) = 7.46$ dBm.

802.11g

TX chain	Channel	Freq. (MHz)	PSD W/O Duty Factor (dBm/10kHz)	10 log (N=2) dB	Duty Factor (dB)	Total PSD With Duty Factor (dBm/10kHz)	Limit (dBm/3kHz)	Pass /Fail
0	1	2412	-9.50	3.01	0.14	-6.35	7.46	Pass
	6	2437	-7.89	3.01	0.14	-4.74	7.46	Pass
	11	2462	-8.08	3.01	0.14	-4.93	7.46	Pass
1	1	2412	-9.28	3.01	0.14	-6.13	7.46	Pass
	6	2437	-6.73	3.01	0.14	-3.58	7.46	Pass
	11	2462	-7.89	3.01	0.14	-4.74	7.46	Pass

Note:

- Method 1 of power density measurement of KDB 662911 is using for calculating total power density. Total power density is summing entire spectra across corresponding frequency bins on the various outputs by computer.
- Directional gain = $10 \log[(10^{G1/20} + 10^{G2/20} + \dots + 10^{GN/20})^2/N]$ = 6.54dBi > 6dBi, so the power density limit shall be reduced to $8-(6.54-6) = 7.46$ dBm.
- Refer to section 3.3 for duty cycle spectrum plot.

802.11n (HT20)

TX chain	Channel	Freq. (MHz)	PSD (dBm/10kHz)	10 log (N=2) dB	Total PSD (dBm/10kHz)	Limit (dBm/3kHz)	Pass /Fail
0	1	2412	-11.99	3.01	-8.98	7.46	Pass
	6	2437	-8.07	3.01	-5.06	7.46	Pass
	11	2462	-10.59	3.01	-7.58	7.46	Pass
1	1	2412	-11.24	3.01	-8.23	7.46	Pass
	6	2437	-8.37	3.01	-5.36	7.46	Pass
	11	2462	-10.35	3.01	-7.34	7.46	Pass

Note:

- Method 1 of power density measurement of KDB 662911 is using for calculating total power density. Total power density is summing entire spectra across corresponding frequency bins on the various outputs by computer.
- Directional gain = $10 \log[(10^{G1/20} + 10^{G2/20} + \dots + 10^{GN/20})^2/N]$ = 6.54dBi > 6dBi, so the power density limit shall be reduced to $8-(6.54-6) = 7.46$ dBm.

802.11n (HT40)

TX chain	Channel	Freq. (MHz)	PSD W/O Duty Factor (dBm/10kHz)	10 log (N=2) dB	Duty Factor (dB)	Total PSD With Duty Factor (dBm/10kHz)	Limit (dBm/3kHz)	Pass /Fail
0	3	2422	-15.45	3.01	0.16	-12.28	7.46	Pass
	6	2437	-13.23	3.01	0.16	-10.06	7.46	Pass
	9	2452	-15.52	3.01	0.16	-12.35	7.46	Pass
1	3	2422	-15.91	3.01	0.16	-12.74	7.46	Pass
	6	2437	-13.85	3.01	0.16	-10.68	7.46	Pass
	9	2452	-15.37	3.01	0.16	-12.20	7.46	Pass

Note:

- Method 1 of power density measurement of KDB 662911 is using for calculating total power density. Total power density is summing entire spectra across corresponding frequency bins on the various outputs by computer.
- Directional gain = $10 \log[(10^{G1/20} + 10^{G2/20} + \dots + 10^{GN/20})^2/N]$ = 6.54dBi > 6dBi, so the power density limit shall be reduced to $8-(6.54-6) = 7.46$ dBm.
- Refer to section 3.3 for duty cycle spectrum plot.

Spectrum Plot of Worst Value

802.11b

802.11g

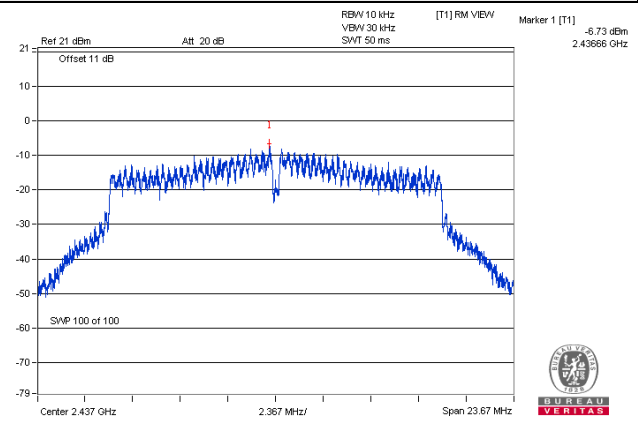
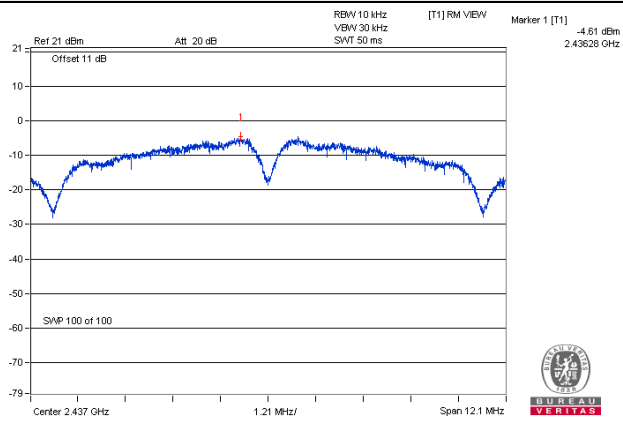

802.11n (HT20)

802.11n (HT40)

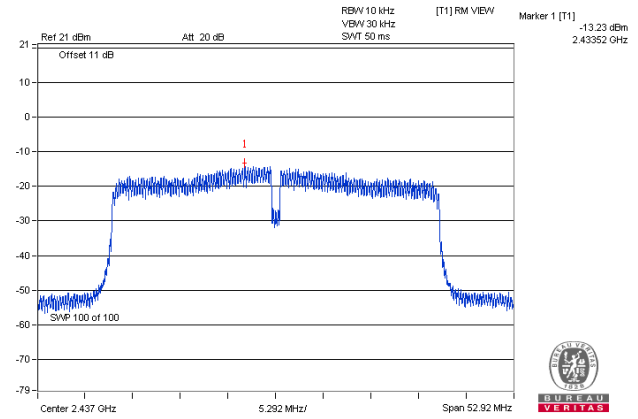
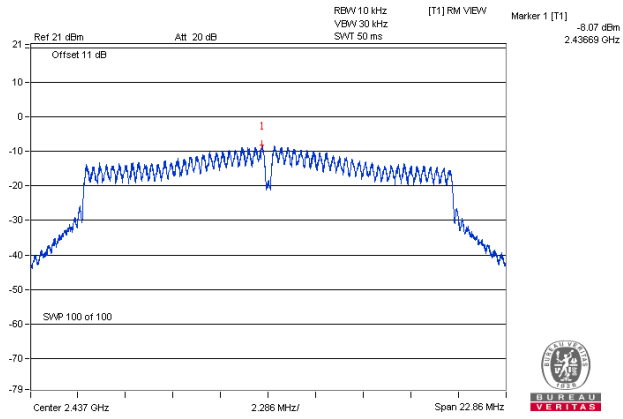

4.6 Conducted Out of Band Emission Measurement

4.6.1 Limits of Conducted Out of Band Emission Measurement

Below 30dB of the highest emission level of operating band (in 100kHz Resolution Bandwidth).

4.6.2 Test Setup

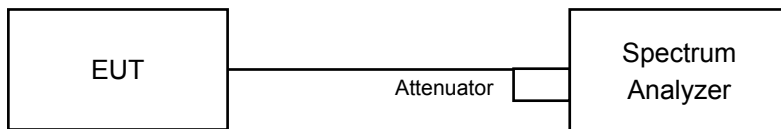

4.6.3 Test Instruments

Refer to section 4.1.2 to get information of above instrument.

4.6.4 Test Procedure

MEASUREMENT PROCEDURE REF

1. Set the RBW = 100 kHz.
2. Set the VBW \geq 300 kHz.
3. Detector = peak.
4. Sweep time = auto couple.
5. Trace mode = max hold.
6. Allow trace to fully stabilize.
7. Use the peak marker function to determine the maximum power level in any 100 kHz band segment within the fundamental EBW.

MEASUREMENT PROCEDURE OOB

1. Set RBW = 100 kHz.
2. Set VBW \geq 300 kHz.
3. Detector = peak.
4. Sweep = auto couple.
5. Trace Mode = max hold.
6. Allow trace to fully stabilize.
7. Use the peak marker function to determine the maximum amplitude level.

4.6.5 Deviation from Test Standard

No deviation.

4.6.6 EUT Operating Condition

Same as item 4.3.6

4.6.7 Test Results

The conducted emission test is performed on each TX port of operating mode without summing or adding $10\log(N)$ since the limit is relative emission limit.

The spectrum plots are attached on the following pages. D1 line indicates the highest level, and D2 line indicates the 30dB offset below D1. It shows compliance with the requirement.

1TX
802.11b

CH 1

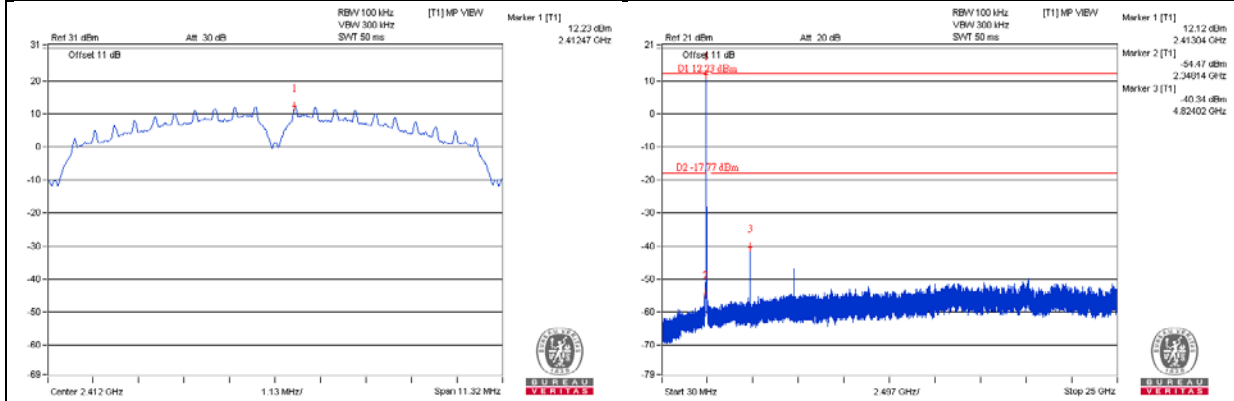

CH 6

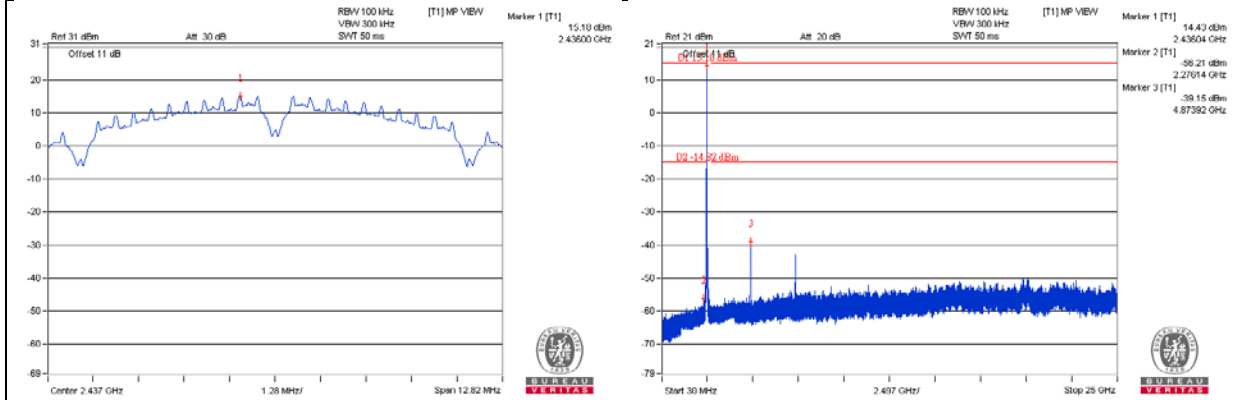

CH 11

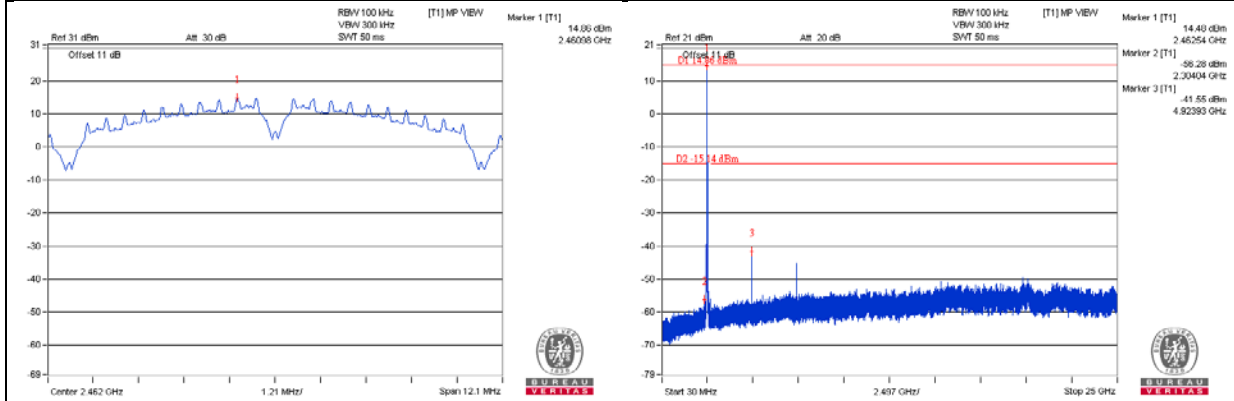

CH 1 Band edge

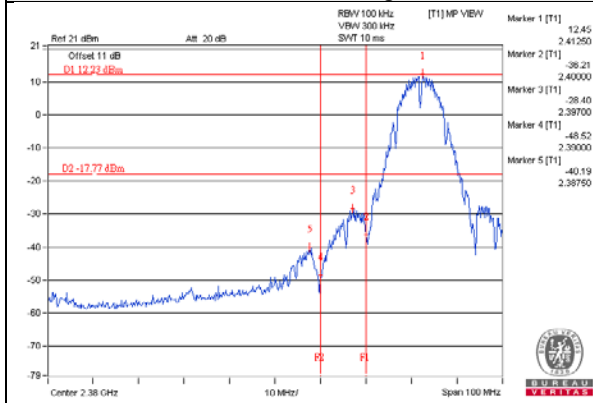

CH 11 Band edge

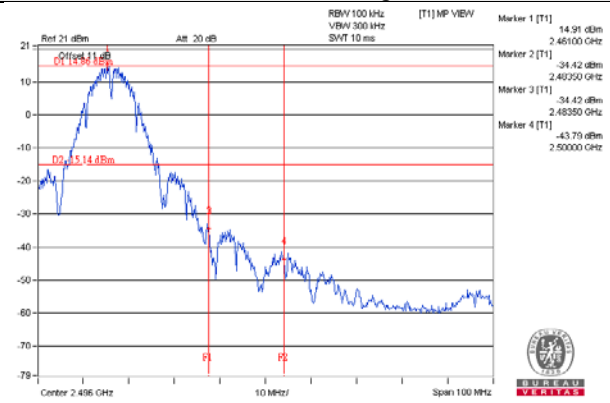

802.11g

CH 1

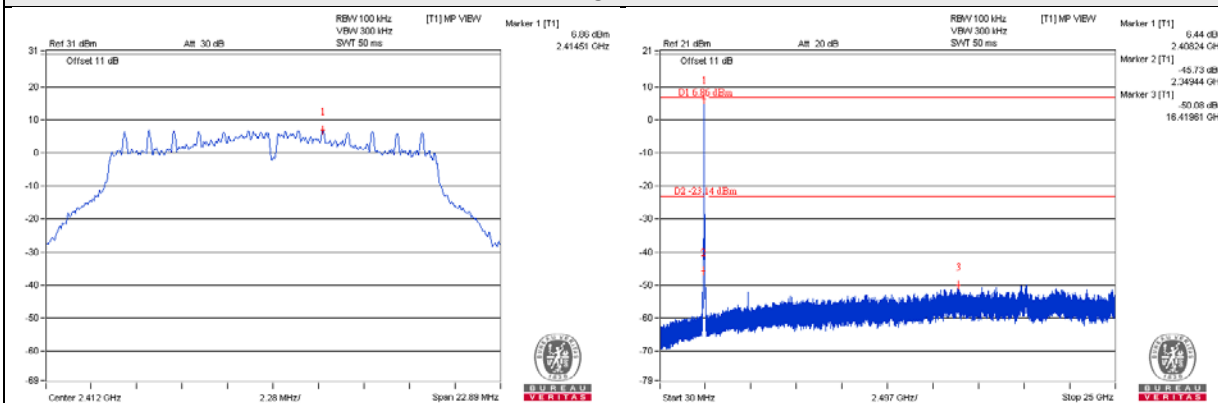

CH 6

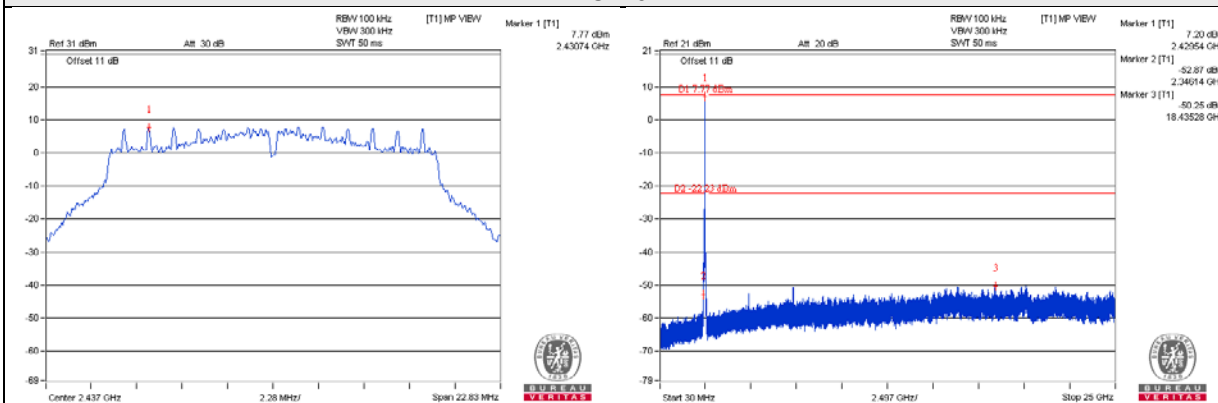

CH 11

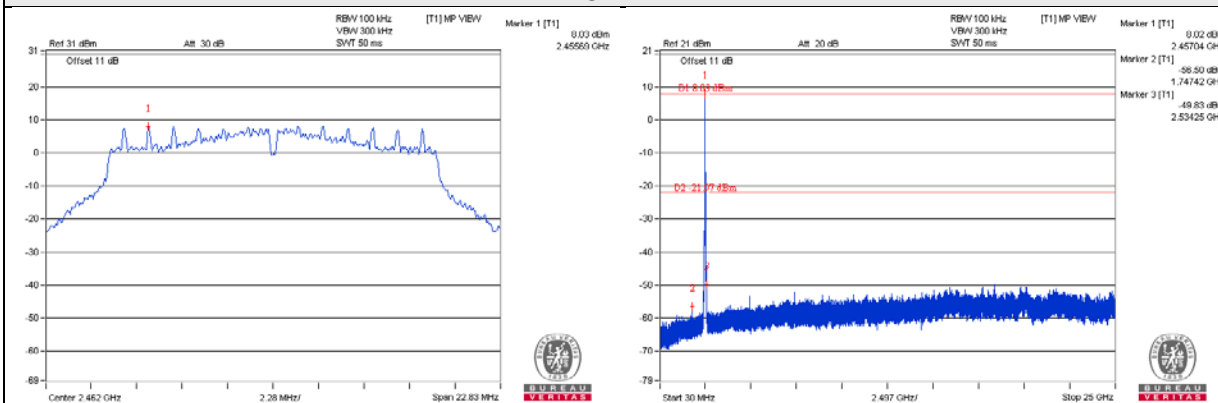

CH 1 Band edge

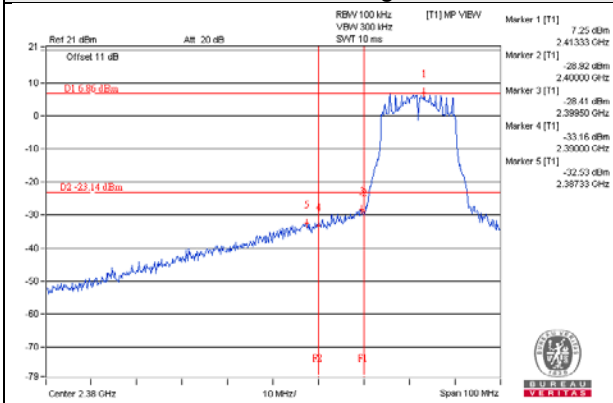

CH 11 Band edge

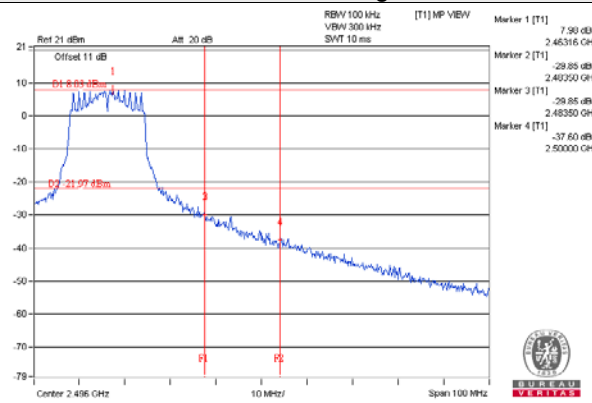

802.11n (HT20)

CH 1

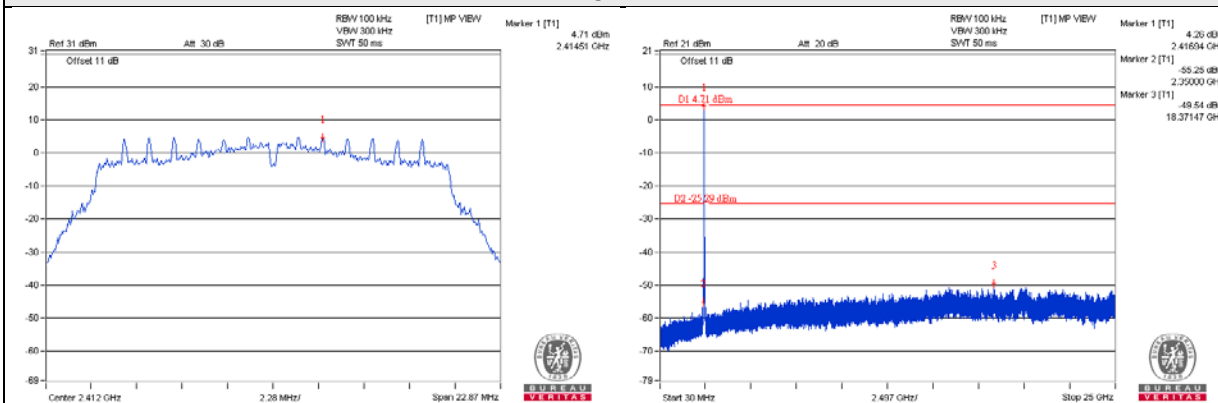

CH 6

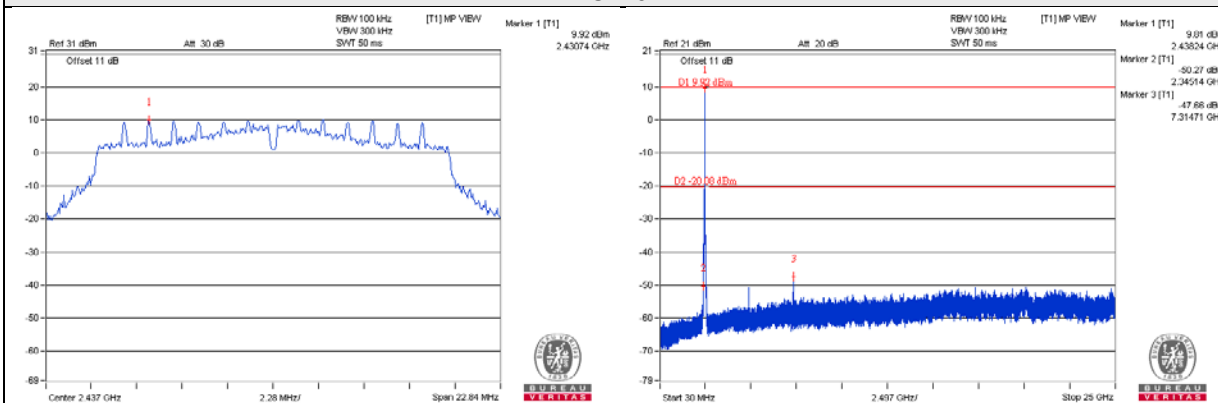

CH 11

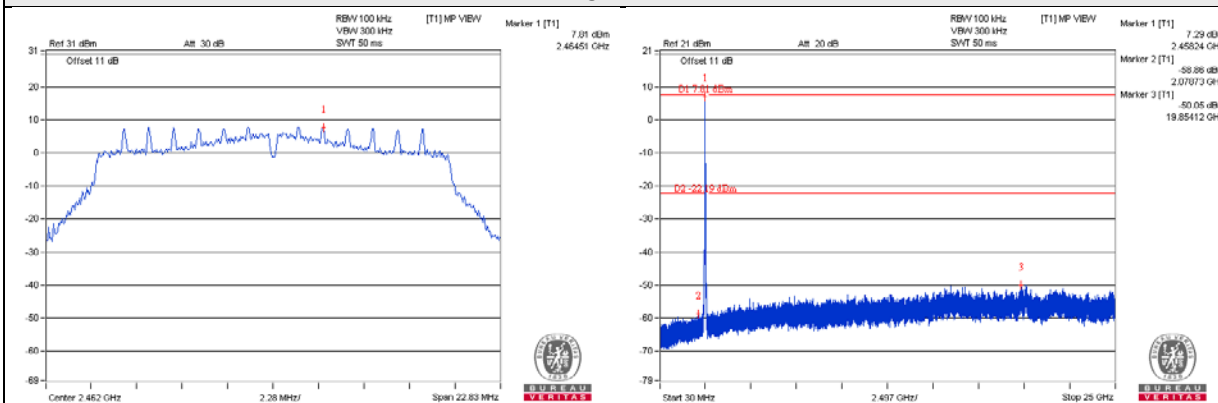

CH 1 Band edge

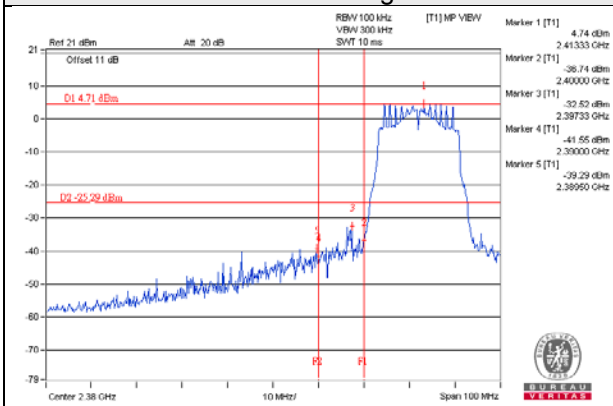

CH 11 Band edge

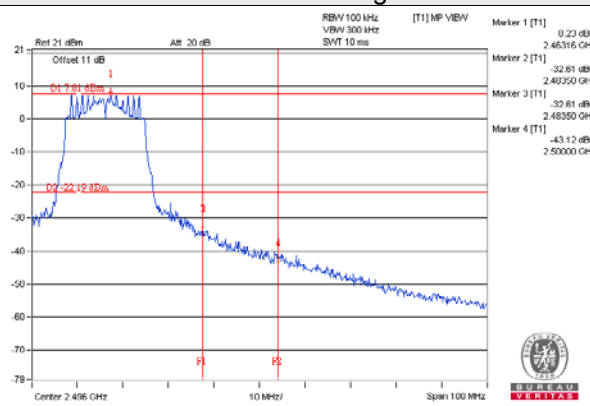

802.11n (HT40)

CH 3

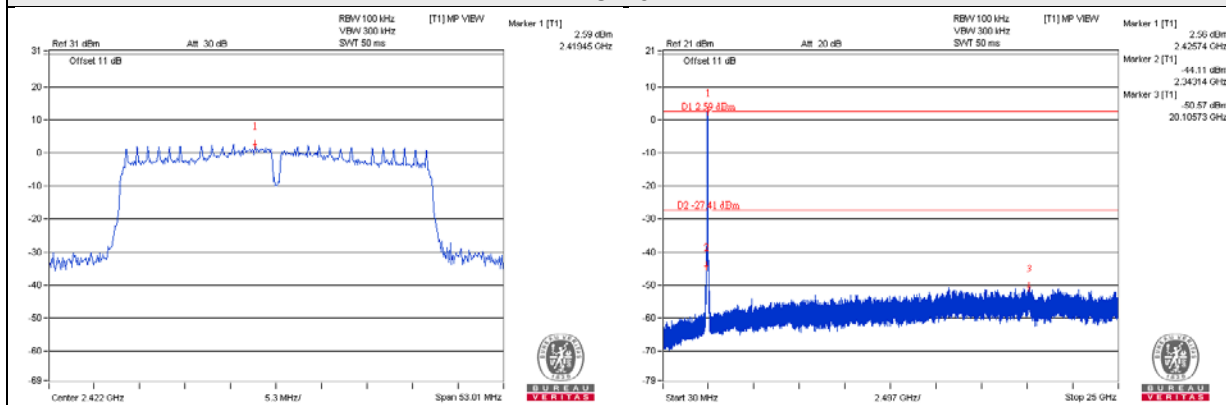

CH 6

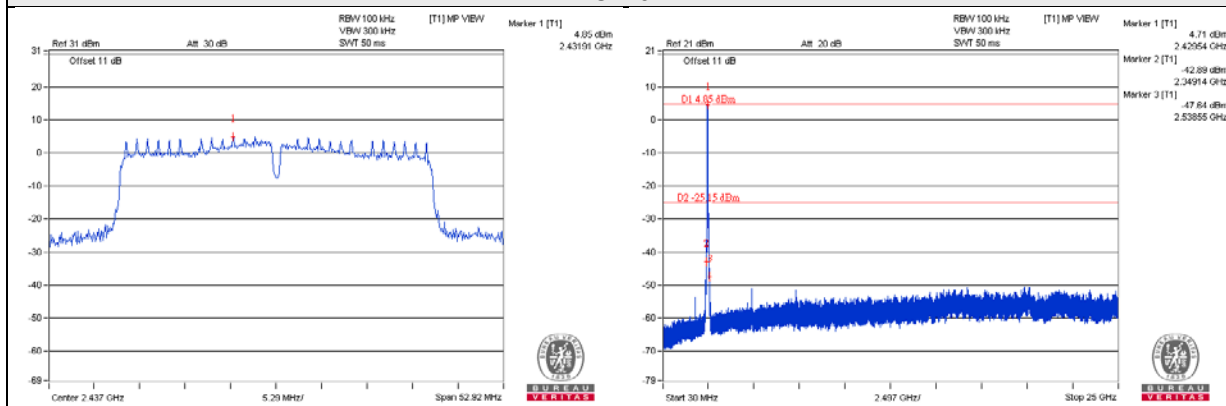

CH 9

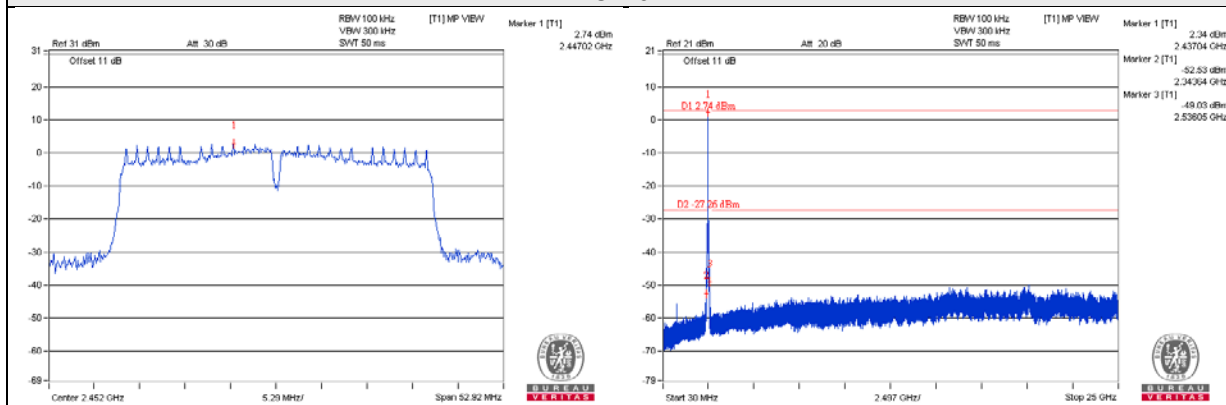

CH 3 Band edge

CH 9 Band edge

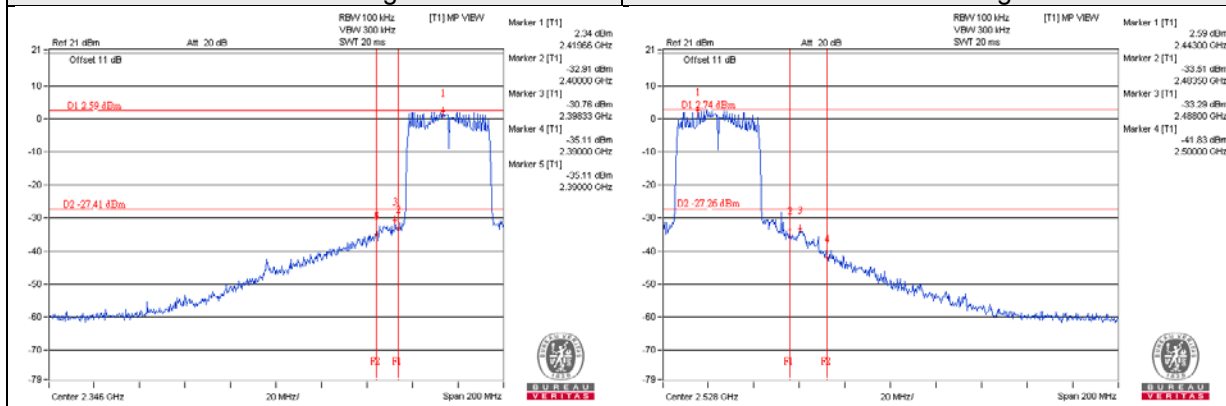

2TX
802.11b_Chain 0

CH 1

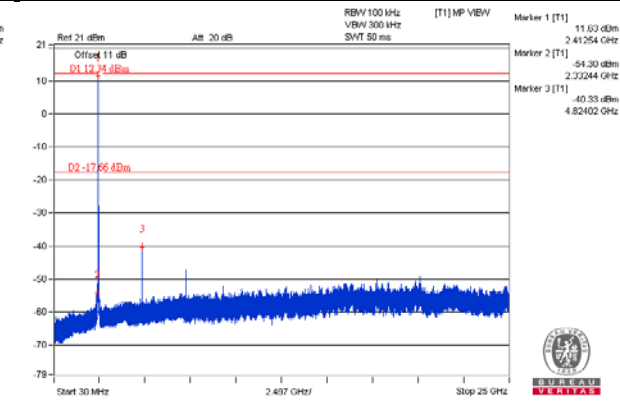
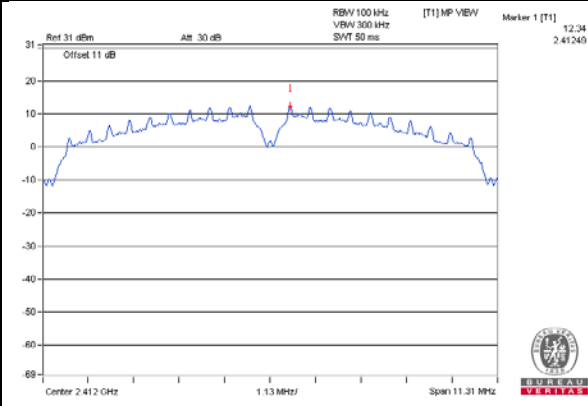

CH 6

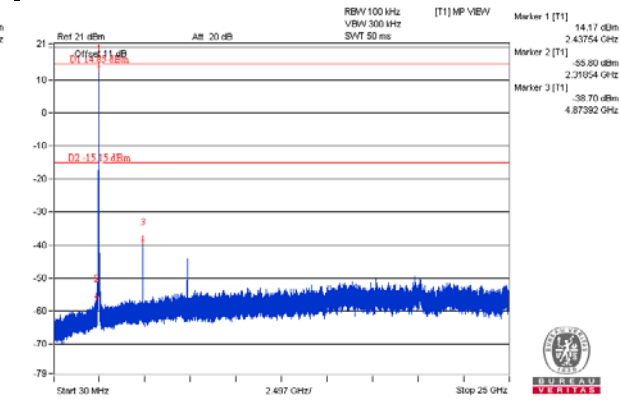
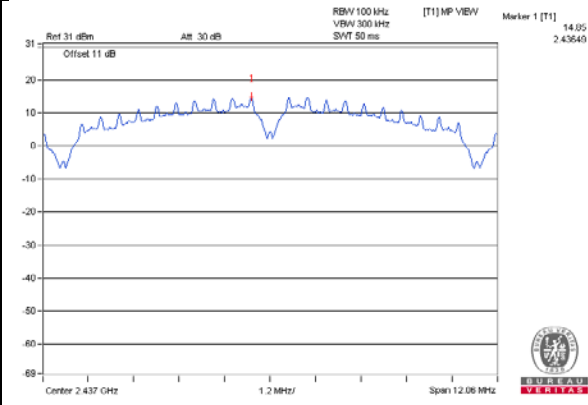

CH 11

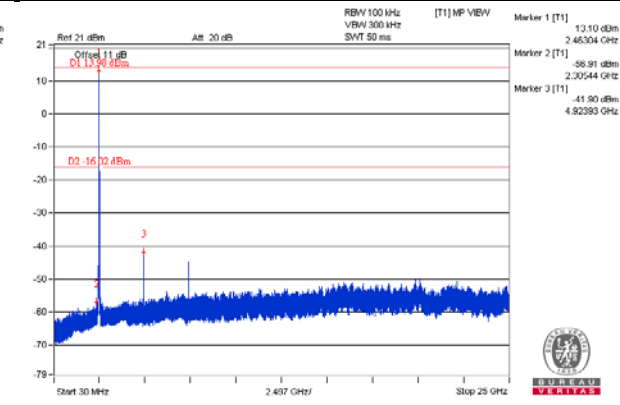
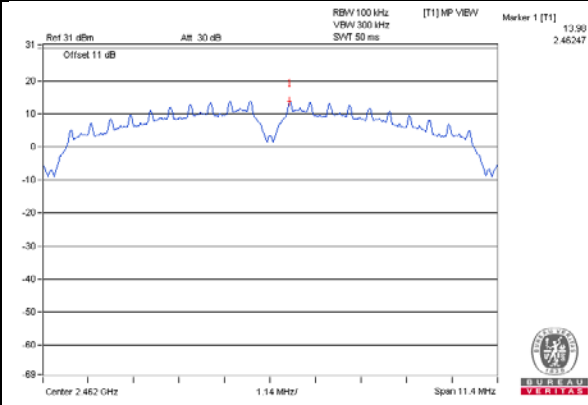

CH 1 Band edge

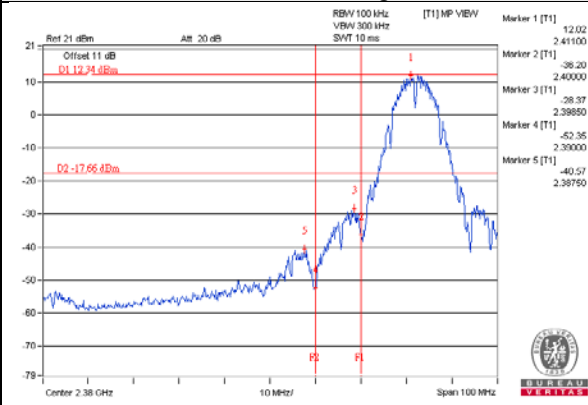

CH 11 Band edge

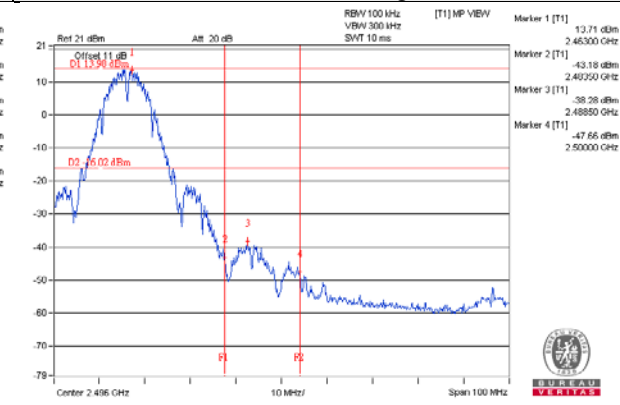

802.11b_Chain 1

CH 1

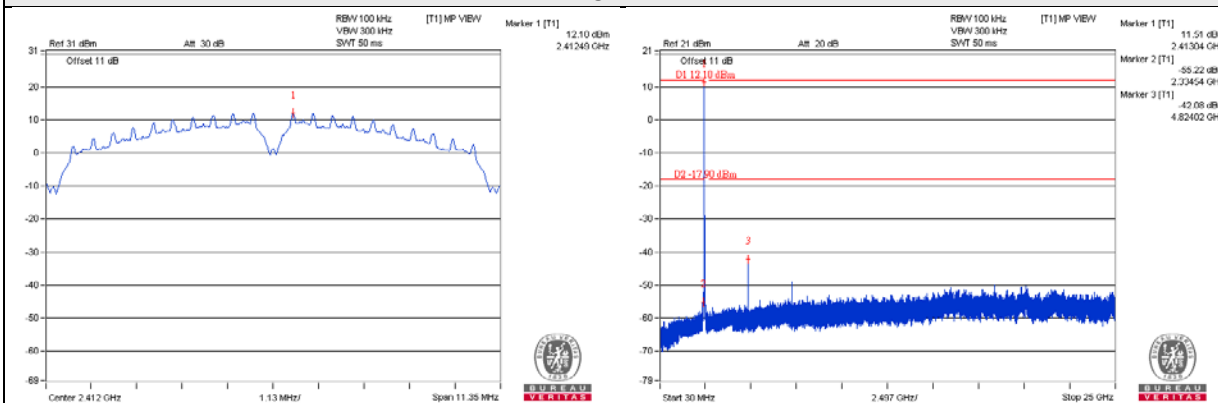

CH 6

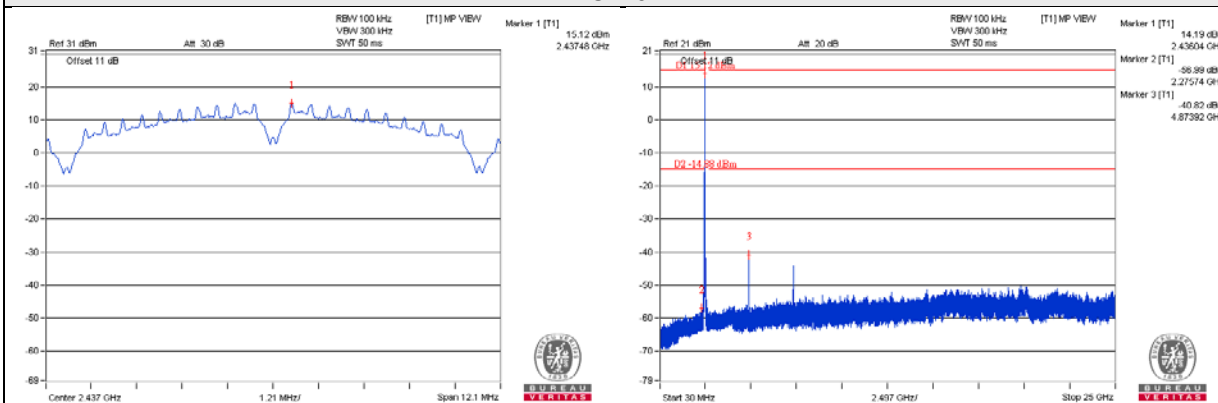

CH 11

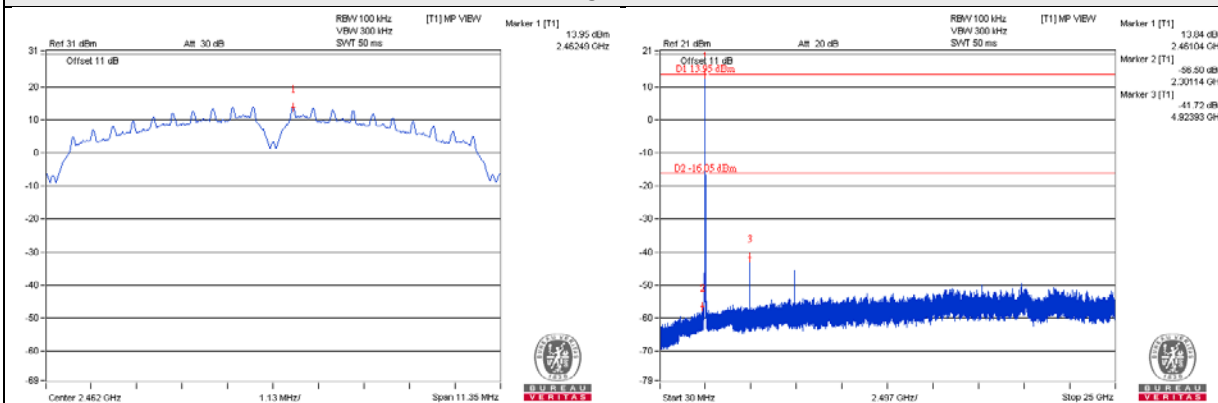

CH 1 Band edge

CH 11 Band edge

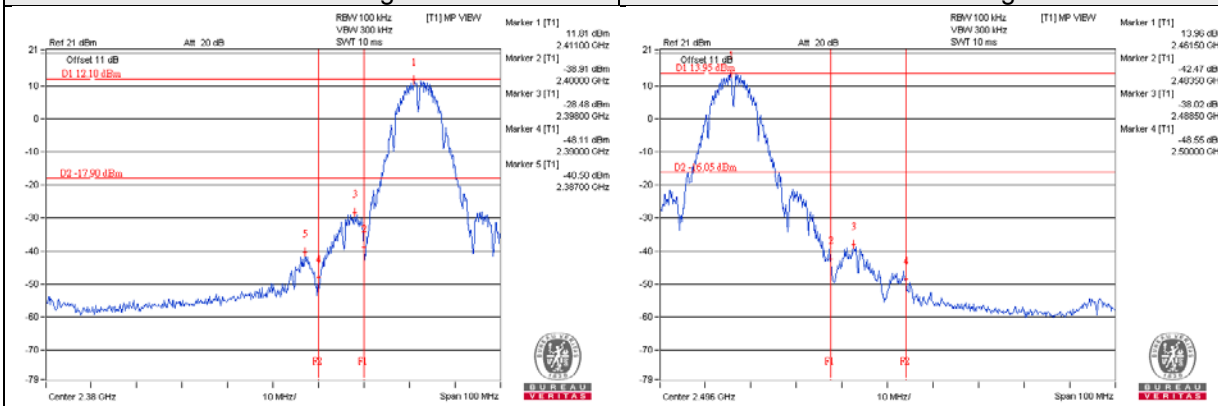

802.11g_Chain 0

CH 1

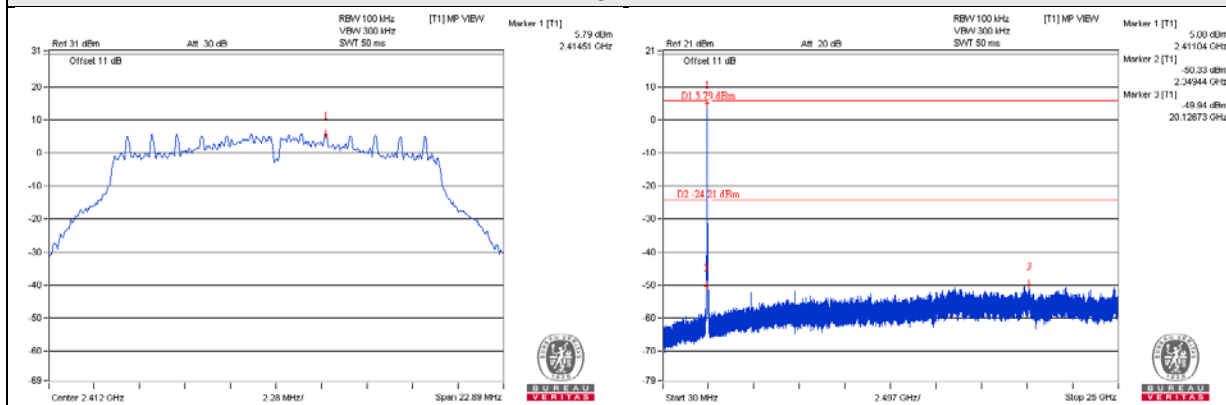

CH 6

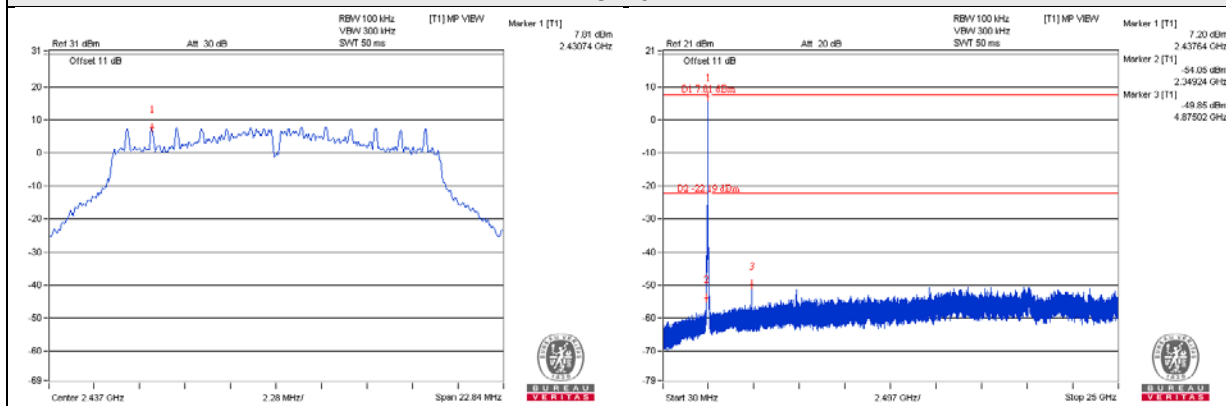

CH 11

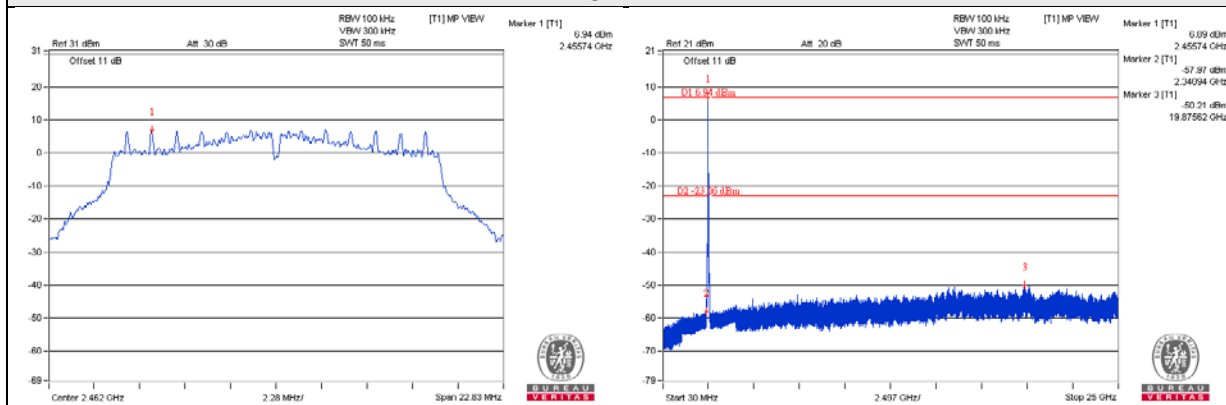

CH 1 Band edge

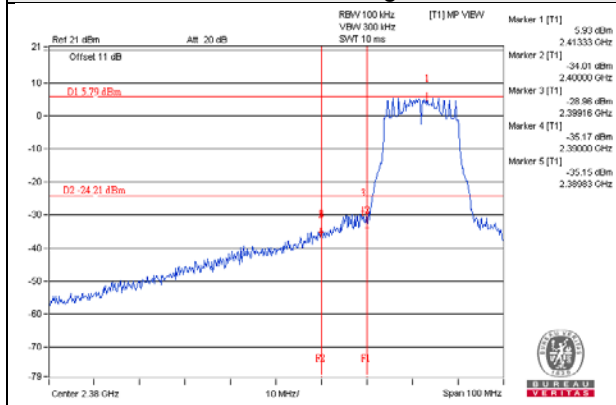

CH 11 Band edge

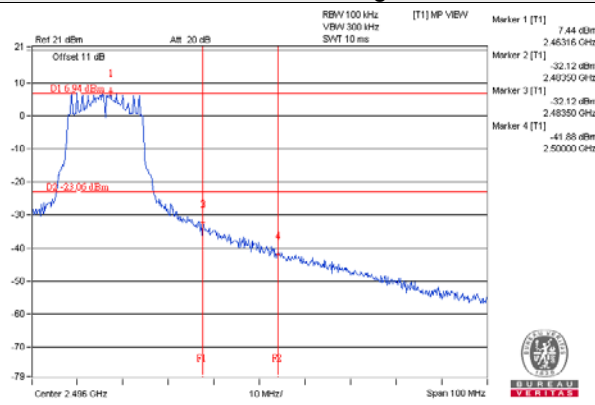

802.11g_Chain 1

CH 1

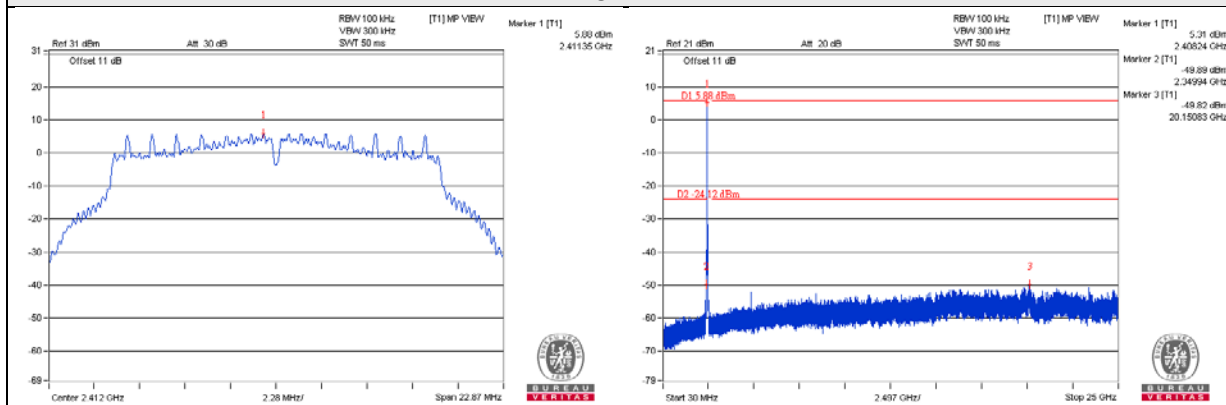

CH 6

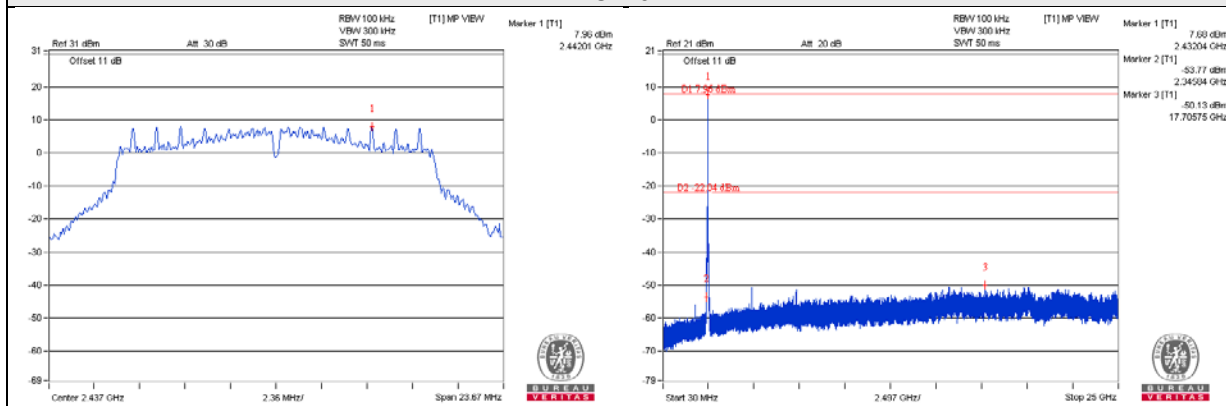

CH 11

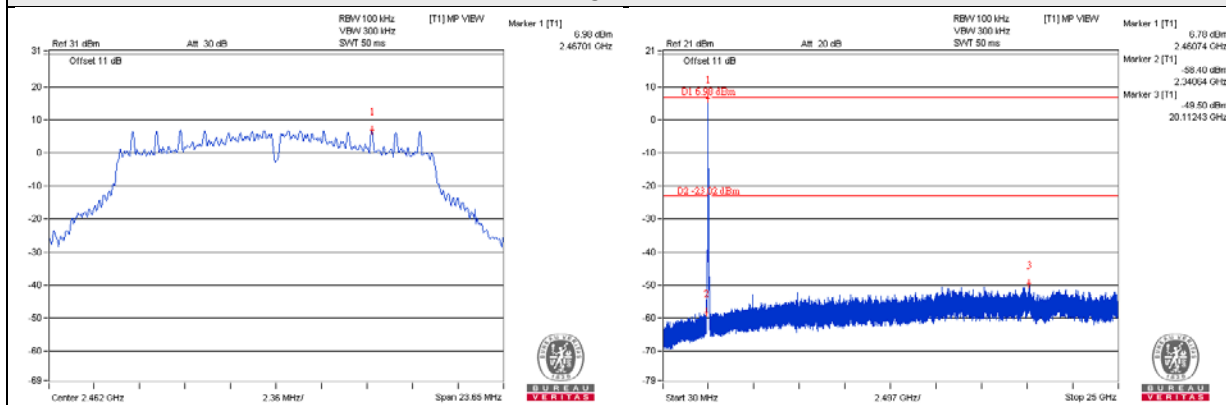

CH 1 Band edge

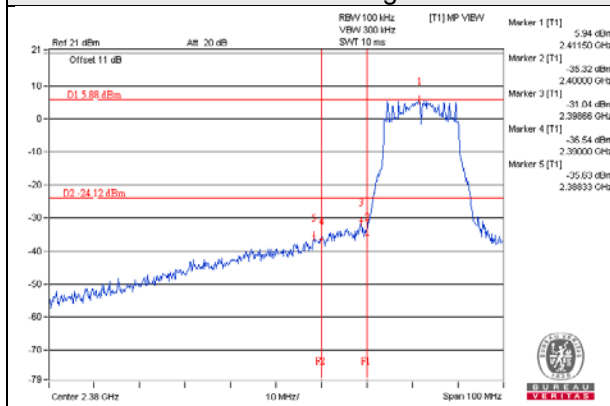

CH 11 Band edge

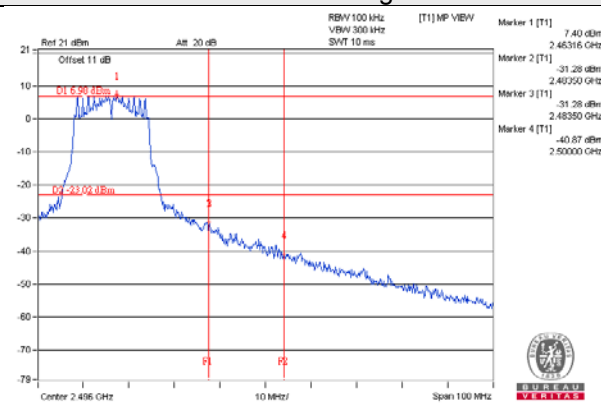

802.11n (HT20)_Chain 0

CH 1

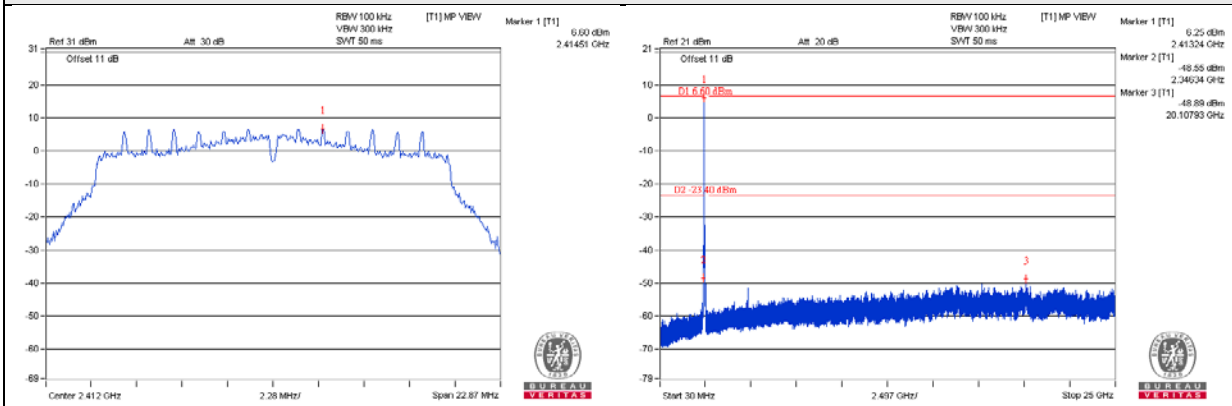

CH 6

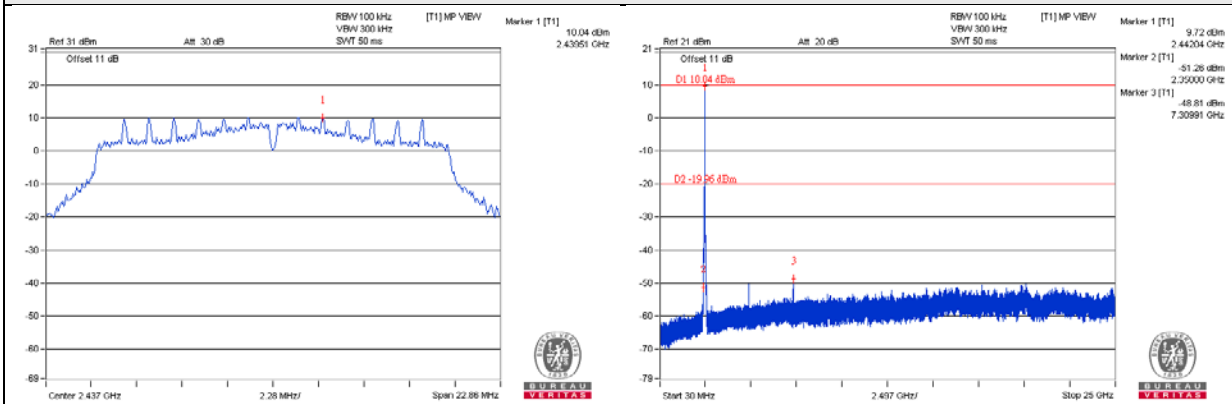

CH 11

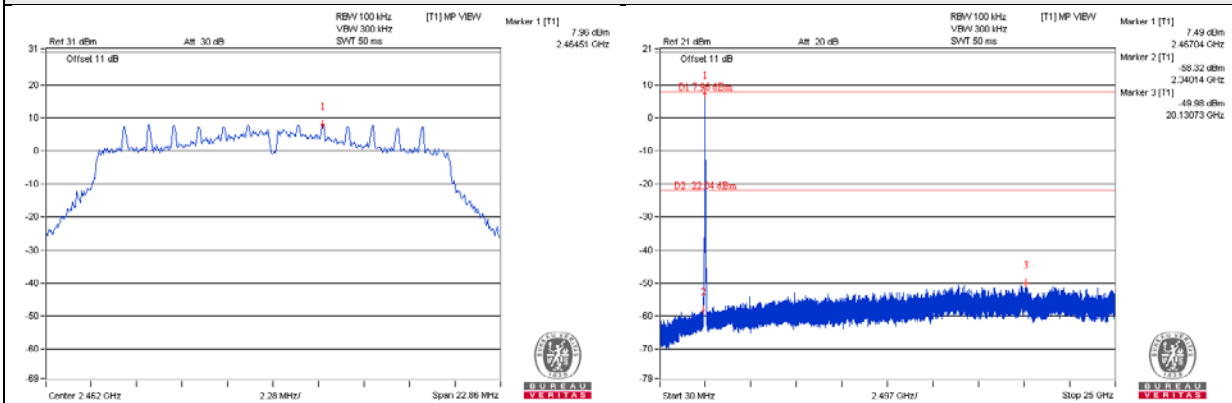

CH 1 Band edge

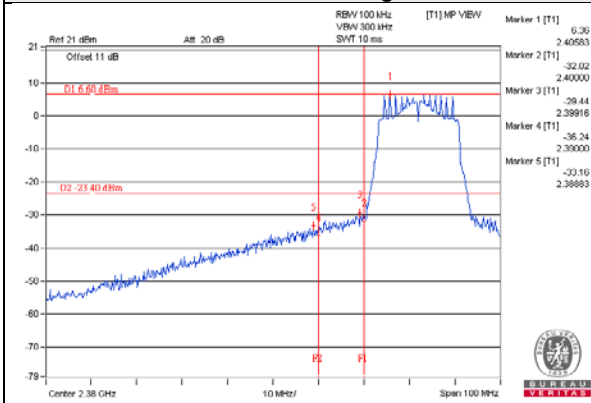

CH 11 Band edge

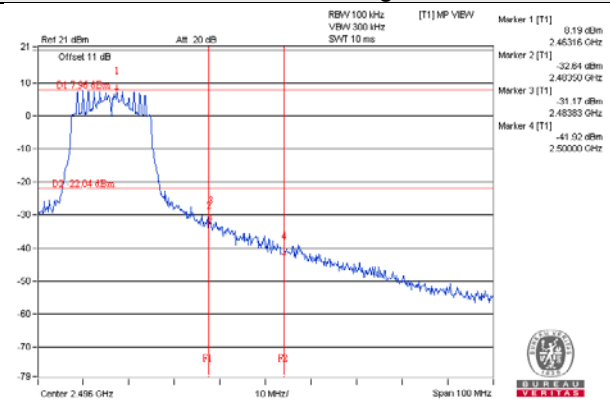

802.11n (HT20)_Chain 1

CH 1

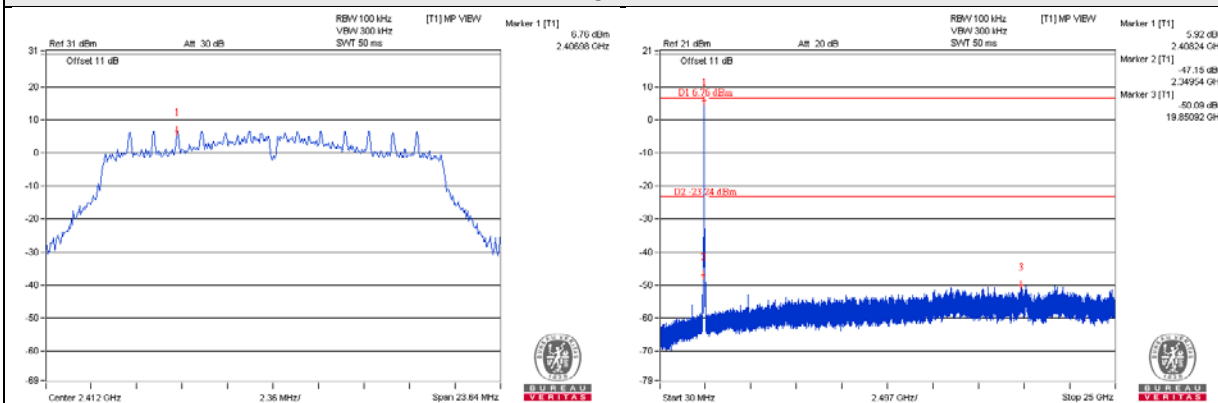

CH 6

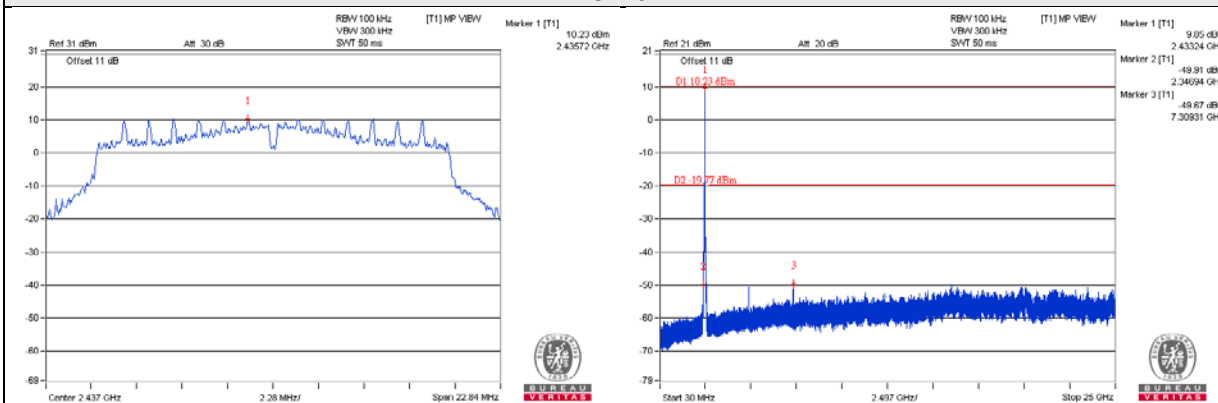

CH 11

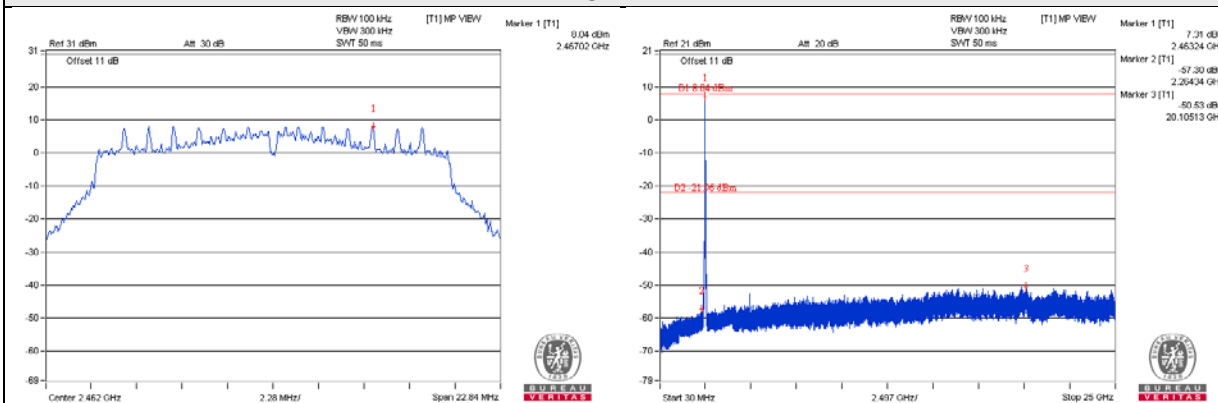

CH 1 Band edge

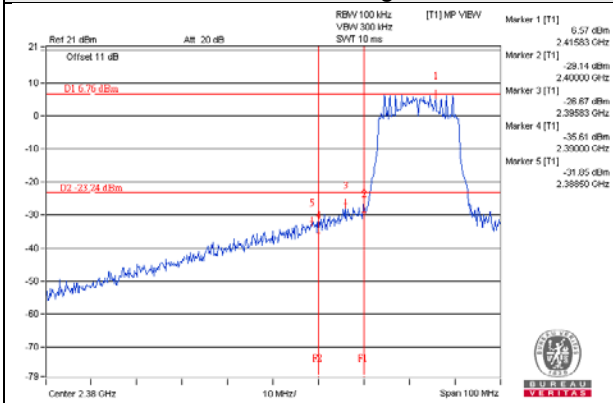

CH 11 Band edge

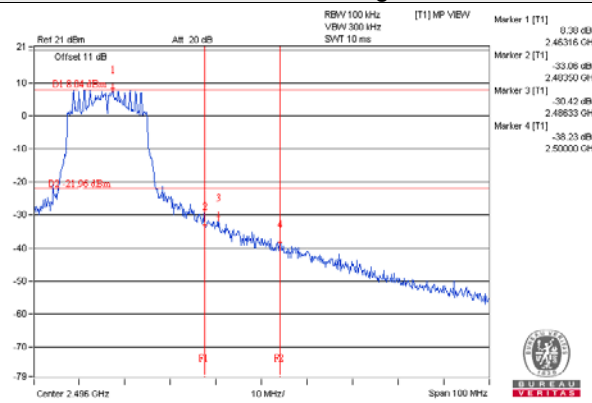

802.11n (HT40)_Chain 0

CH 3

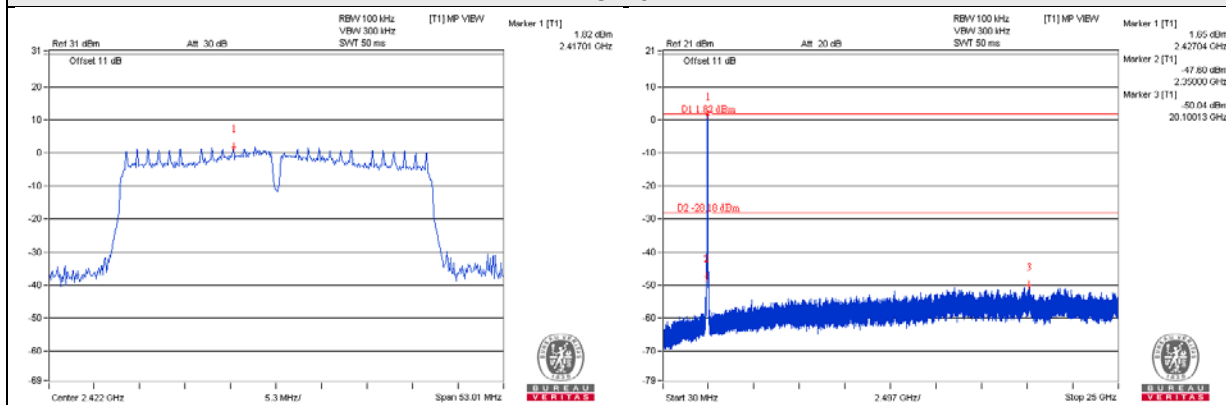

CH 6

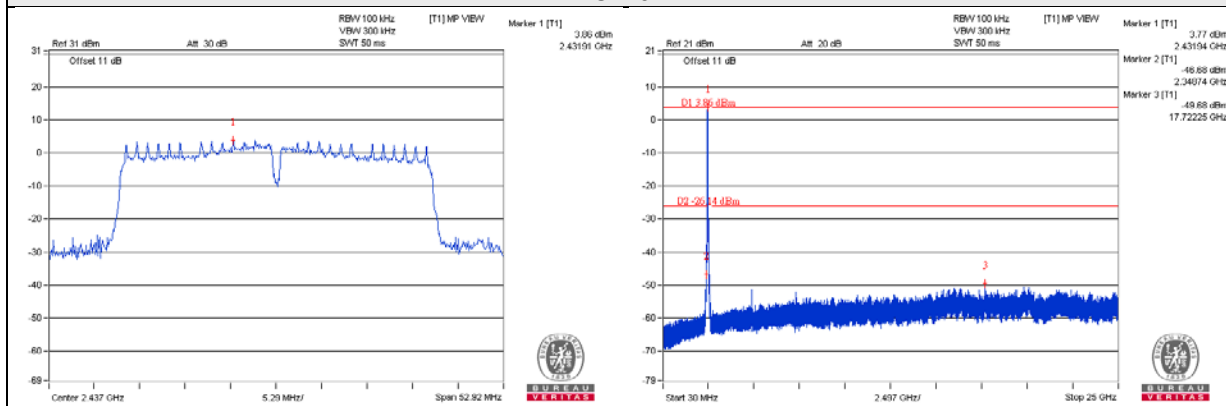

CH 9

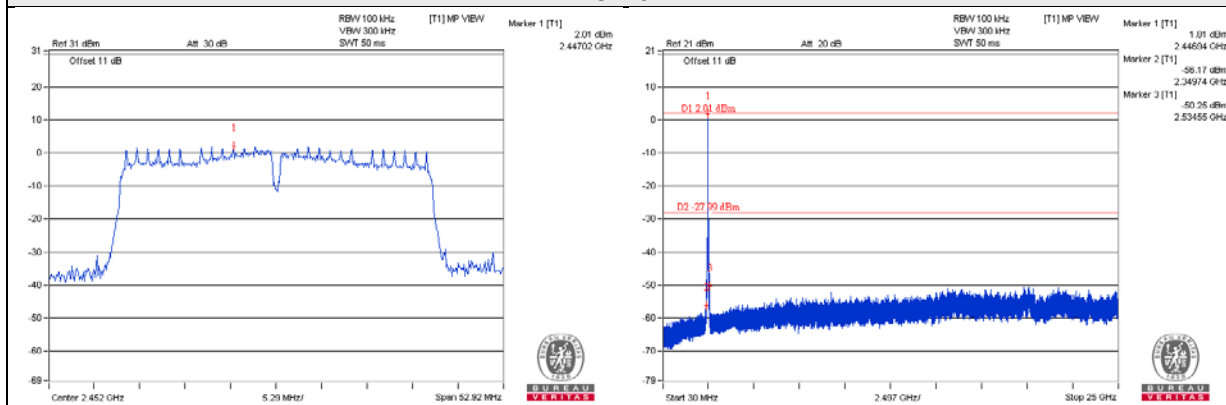

CH 3 Band edge

CH 9 Band edge

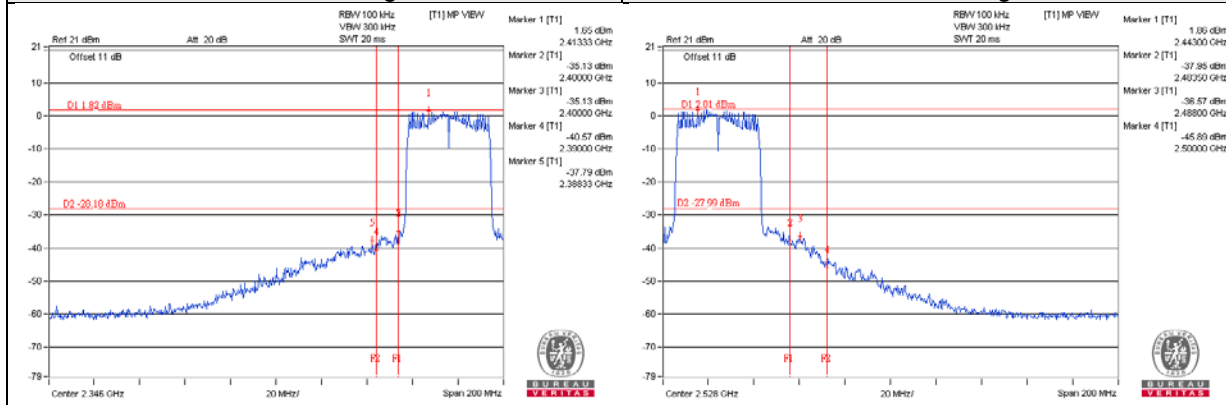

802.11n (HT40)_Chain 1

CH 3

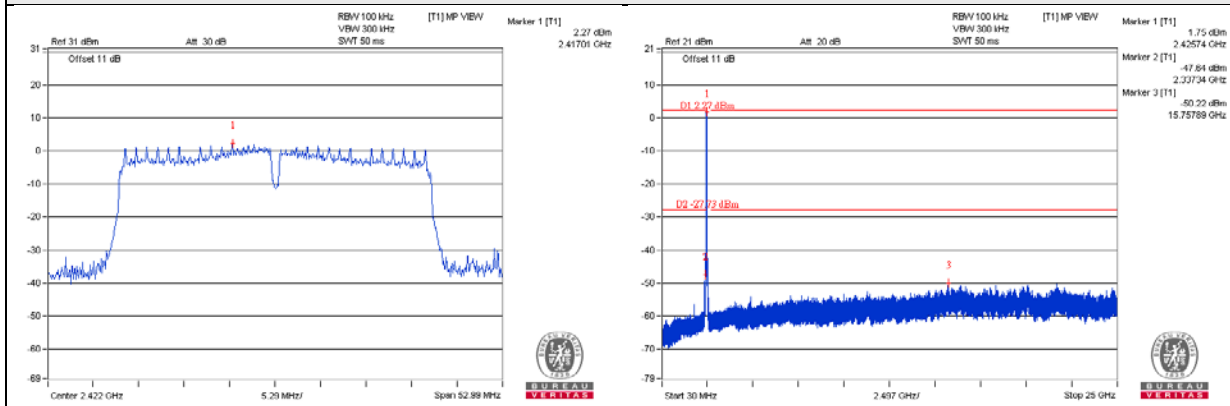

CH 6

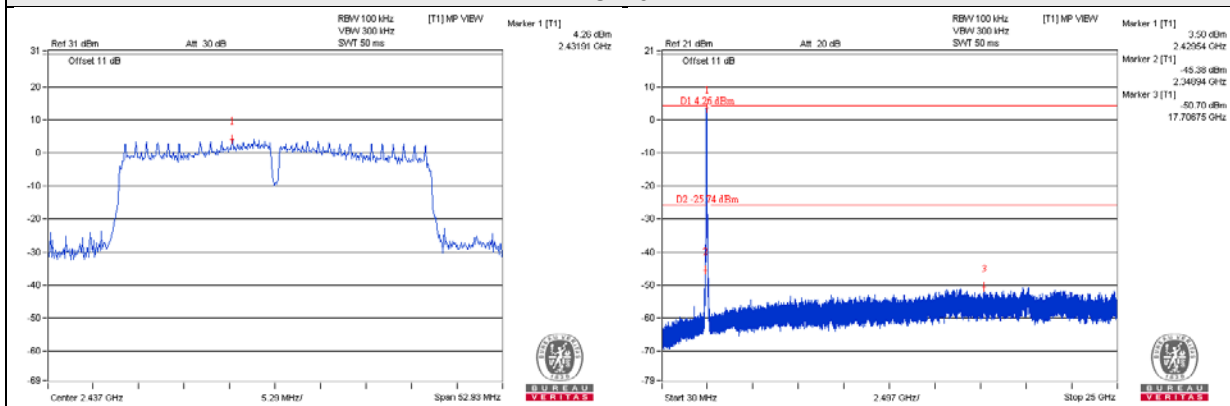

CH 9

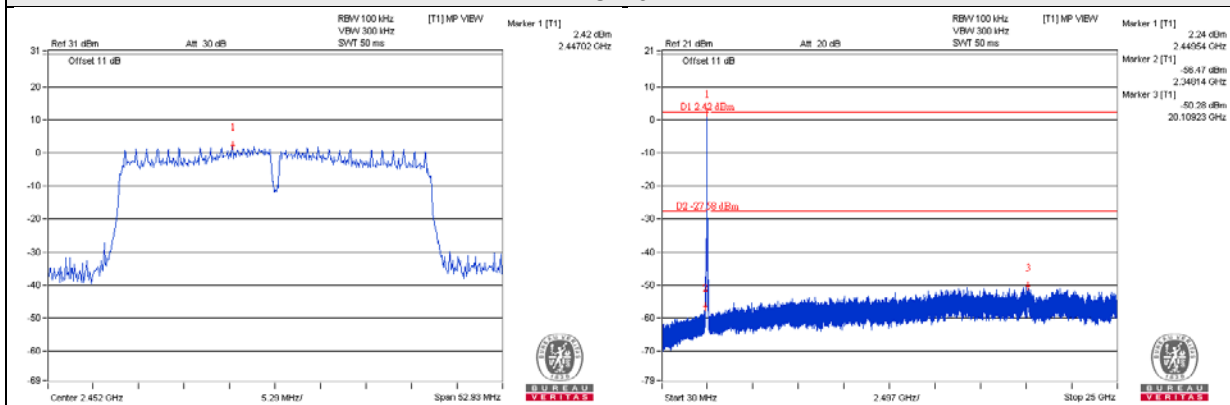

CH 3 Band edge

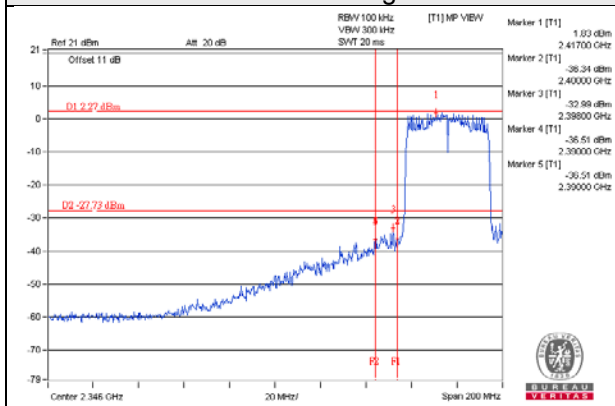

CH 9 Band edge

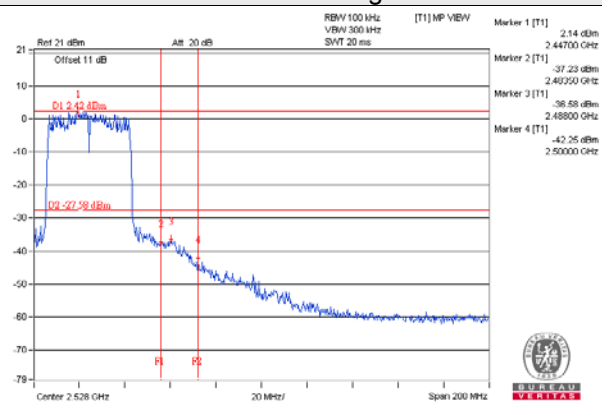

5 Pictures of Test Arrangements

Please refer to the attached file (Test Setup Photo).

Appendix – Information on the Testing Laboratories

We, Bureau Veritas Consumer Products Services (H.K.) Ltd., Taoyuan Branch, were founded in 1988 to provide our best service in EMC, Radio, Telecom and Safety consultation. Our laboratories are accredited and approved according to ISO/IEC 17025.

If you have any comments, please feel free to contact us at the following:

Linko EMC/RF Lab

Tel: 886-2-26052180

Fax: 886-2-26051924

Hsin Chu EMC/RF/Telecom Lab

Tel: 886-3-6668565

Fax: 886-3-6668323

Hwa Ya EMC/RF/Safety Lab

Tel: 886-3-3183232

Fax: 886-3-3270892

Email: service.adt@tw.bureauveritas.com

Web Site: www.bureauveritas-adt.com

The address and road map of all our labs can be found in our web site also.

--- END ---