

FCC Test Report

Report No.: RF200511E13A

FCC ID: 2AHBN-AP12

Test Model: AP12

Received Date: May 11, 2020

Test Date: Jul. 08 ~ Aug. 18, 2020

Issued Date: Aug. 28, 2020

Applicant: Juniper Networks, Inc.

Address: 1133 Innovation Way Sunnyvale, CA 94089 USA

Issued By: Bureau Veritas Consumer Products Services (H.K.) Ltd., Taoyuan Branch
Lin Kou Laboratories

Lab Address: No. 47-2, 14th Ling, Chia Pau Vil., Lin Kou Dist., New Taipei City, Taiwan

Test Location (1): No.19, Hwa Ya 2nd Rd., Wen Hwa Vil., Kwei Shan Dist., Taoyuan City
33383, Taiwan

Test Location (2): B2F., No.215, Sec. 3, Beixin Rd., Xindian Dist., New Taipei City 231,
Taiwan

FCC Registration / 788550 / TW0003

Designation Number: 427177 / TW0011



This report is for your exclusive use. Any copying or replication of this report to or for any other person or entity, or use of our name or trademark, is permitted only with our prior written permission. This report sets forth our findings solely with respect to the test samples identified herein. The results set forth in this report are not indicative or representative of the quality or characteristics of the lot from which a test sample was taken or any similar or identical product unless specifically and expressly noted. Our report includes all of the tests requested by you and the results thereof based upon the information that you provided to us. You have 60 days from date of issuance of this report to notify us of any material error or omission caused by our negligence, provided, however, that such notice shall be in writing and shall specifically address the issue you wish to raise. A failure to raise such issue within the prescribed time shall constitute your unqualified acceptance of the completeness of this report, the tests conducted and the correctness of the report contents. Unless specific mention, the uncertainty of measurement has been explicitly taken into account to declare the compliance or non-compliance to the specification.

Table of Contents

Release Control Record	4
1 Certificate of Conformity	5
2 Summary of Test Results	6
2.1 Measurement Uncertainty	6
2.2 Modification Record	6
3 General Information	7
3.1 General Description of EUT	7
3.2 Description of Test Modes	10
3.2.1 Test Mode Applicability and Tested Channel Detail	11
3.3 Duty Cycle of Test Signal	13
3.4 Description of Support Units	15
3.4.1 Configuration of System under Test	15
3.5 General Description of Applied Standards and References	16
4 Test Types and Results	17
4.1 Radiated Emission and Bandedge Measurement	17
4.1.1 Limits of Radiated Emission and Bandedge Measurement	17
4.1.2 Test Instruments	19
4.1.3 Test Procedures	20
4.1.4 Deviation from Test Standard	20
4.1.5 Test Setup	21
4.1.6 EUT Operating Conditions	22
4.1.7 Test Results	23
4.2 Conducted Emission Measurement	67
4.2.1 Limits of Conducted Emission Measurement	67
4.2.2 Test Instruments	67
4.2.3 Test Procedures	68
4.2.4 Deviation from Test Standard	68
4.2.5 Test Setup	68
4.2.6 EUT Operating Conditions	68
4.2.7 Test Results	69
4.3 Transmit Power Measurement	73
4.3.1 Limits of Transmit Power Measurement	73
4.3.2 Test Setup	73
4.3.3 Test Instruments	74
4.3.4 Test Procedure	74
4.3.5 Deviation from Test Standard	74
4.3.6 EUT Operating Conditions	74
4.3.7 Test Results	75
4.4 Occupied Bandwidth Measurement	86
4.4.1 Test Setup	86
4.4.2 Test Instruments	86
4.4.3 Test Procedure	86
4.4.4 Test Results	87
4.5 Peak Power Spectral Density Measurement	91
4.5.1 Limits of Peak Power Spectral Density Measurement	91
4.5.2 Test Setup	91
4.5.3 Test Instruments	91
4.5.4 Test Procedures	91
4.5.5 Deviation from Test Standard	91
4.5.6 EUT Operating Conditions	91
4.5.7 Test Results	92
4.6 Frequency Stability	97
4.6.1 Limit of Frequency Stability Measurement	97

4.6.2 Test Setup	97
4.6.3 Test Instruments	97
4.6.4 Test Procedure	97
4.6.5 Deviation from Test Standard	97
4.6.6 EUT Operating Condition	97
4.6.7 Test Results	98
5 Pictures of Test Arrangements.....	100
Annex A- Band-edge measurement (For U-NII-2A, U-NII-2C band)	101
Appendix – Information of the Testing Laboratories	141

Release Control Record

Issue No.	Description	Date Issued
RF200511E13A	Original Release	Aug. 28, 2020

1 Certificate of Conformity

Product: 802.11ax Wallplate AP
Brand: Mist
Test Model: AP12
Sample Status: Engineering Sample
Applicant: Juniper Networks, Inc.
Test Date: Jul. 08 ~ Aug. 18, 2020
Standards: 47 CFR FCC Part 15, Subpart E (Section 15.407)
ANSI C63.10:2013

The above equipment has been tested by **Bureau Veritas Consumer Products Services (H.K.) Ltd., Taoyuan Branch**, and found compliance with the requirement of the above standards. The test record, data evaluation & Equipment Under Test (EUT) configurations represented herein are true and accurate accounts of the measurements of the sample's RF characteristics under the conditions specified in this report.

Prepared by :  , Date: Aug. 28, 2020
Lena Wang / Specialist

Approved by :  , Date: Aug. 28, 2020
Dylan Chiou / Senior Project Engineer

2 Summary of Test Results

47 CFR FCC Part 15, Subpart E (Section 15.407)			
FCC Clause	Test Item	Result	Remarks
15.407(b)(6)	AC Power Conducted Emissions	Pass	Meet the requirement of limit. Minimum passing margin is -9.44 dB at 0.41325 MHz.
15.407(b) (1/2/3/4(i/ii)/6)	Radiated Emissions & Band Edge Measurement	Pass	Meet the requirement of limit. Minimum passing margin is -0.01 dB at 5470.00 MHz.
15.407(a)(1/2/3)	Max Average Transmit Power	Pass	Meet the requirement of limit.
---	Occupied Bandwidth Measurement	-	Reference only
15.407(a)(1/2/3)	Peak Power Spectral Density	Pass	Meet the requirement of limit.
15.407(g)	Frequency Stability	Pass	Meet the requirement of limit.
15.203	Antenna Requirement	Pass	Antenna connector is i-pex(MHF).

Note:

- For U-NII-2A, U-NII-2C band compliance with rule 15.407(b) of the band-edge items, the test plots were recorded in Annex A. Test Procedures refer to report 4.1.3.
- Determining compliance based on the results of the compliance measurement, not taking into account measurement instrumentation uncertainty.

2.1 Measurement Uncertainty

Where relevant, the following measurement uncertainty levels have been estimated for tests performed on the EUT as specified in CISPR 16-4-2:

Measurement	Frequency	Expanded Uncertainty (k=2) (±)
Conducted Emissions at mains ports	150 kHz ~ 30 MHz	2.79 dB
Radiated Emissions up to 1 GHz	9 kHz ~ 30 MHz	3.04 dB
	30 MHz ~ 200 MHz	2.0153 dB
	200 MHz ~ 1000 MHz	2.0224 dB
Radiated Emissions above 1 GHz	1 GHz ~ 18 GHz	1.0121 dB
	18 GHz ~ 40 GHz	1.1508 dB

2.2 Modification Record

There were no modifications required for compliance.

3 General Information

3.1 General Description of EUT

Product	802.11ax Wallplate AP
Brand	Mist
Test Model	AP12
Status of EUT	Engineering Sample
Power Supply Rating	55.0 Vdc
Modulation Type	256QAM, 64QAM, 16QAM, QPSK, BPSK 1024QAM for OFDMA
Modulation Technology	OFDM, OFDMA
Transfer Rate	802.11a: 54.0/ 48.0/ 36.0/ 24.0/ 18.0/ 12.0/ 9.0/ 6.0 Mbps 802.11n: up to 300.0 Mbps 802.11ac: up to 866.7 Mbps 802.11ax: up to 2402.0 Mbps
Operating Frequency	5260 ~ 5320 MHz, 5500 ~ 5700 MHz
Number of Channel	5260 ~ 5320 MHz: 4 for 802.11a, 802.11n (HT20), 802.11ac (VHT20), 802.11ax (HE20) 2 for 802.11n (HT40), 802.11ac (VHT40), 802.11ax (HE40) 1 for 802.11ac (VHT80), 802.11ax (HE80) 5500 ~ 5700 MHz: 11 for 802.11a, 802.11n (HT20), 802.11ac (VHT20), 802.11ax (HE20) 5 for 802.11n (HT40), 802.11ac (VHT40), 802.11ax (HE40) 2 for 802.11ac (VHT80), 802.11ax (HE80)
Output Power	CDD Mode Mode A (2TX) 230.73 mW for 5260 ~ 5320 MHz 235.544 mW for 5500 ~ 5700 MHz Mode B (1TX) 87.7 mW for 5260 ~ 5320 MHz 86.099 mW for 5500 ~ 5700 MHz Beamforming Mode Mode A (2TX) 131.391 mW for 5260 ~ 5320 MHz 131.242 mW for 5500 ~ 5700 MHz
Antenna Type	Refer to Note as below
Antenna Connector	Refer to Note as below
Accessory Device	Refer to Note as below
Data Cable Supplied	Refer to Note as below

Note:

1. This report is for FCC Class II Permissive Change application. The difference compared with original report is for adding DFS bands <5.26~5.32GHz, 5.5~5.70GHz> by software enabling.
2. There are three radios for the EUT.

Radio	Brand	Model	Function
Radio 1(WL0)	WLAN 2.4G	TX/RX	Radio 1(WL0)
Radio 2(WL1) Scanning	WLAN 2.4G & 5G	TX/RX	Radio 2(WL1) Scanning
Radio 3(WL2)	WLAN 5G	TX/RX	Radio 3(WL2)
Radio 4	BT5.0	TX/RX	Radio 4

3. The EUT incorporates a MIMO function. Physically, the EUT provides 2 completed transmitters and 2 receivers.

Modulation Mode	TX Function	Beamforming
Radio 1		
802.11b	2TX	Not Support
802.11g	2TX	Not Support
802.11n (HT20)	2TX	Support
802.11n (HT40)	2TX	Support
802.11ac (VHT20)	2TX	Support
802.11ac (VHT40)	2TX	Support
802.11ax (HE20)	2TX	Support
802.11ax (HE40)	2TX	Support
Radio 2		
802.11b	1TX	Not Support
802.11g	1TX	Not Support
802.11n (HT20)	1TX	Not Support
802.11n (HT40)	1TX	Not Support
802.11ac (VHT20)	1TX	Not Support
802.11ac (VHT40)	1TX	Not Support
802.11ax (HE20)	1TX	Not Support
802.11ax (HE40)	1TX	Not Support
802.11a	1TX	Not Support
802.11n (HT20)	1TX	Not Support
802.11n (HT40)	1TX	Not Support
802.11ac (VHT20)	1TX	Not Support
802.11ac (VHT40)	1TX	Not Support
802.11ac (VHT80)	1TX	Not Support
802.11ax (HE20)	1TX	Not Support
802.11ax (HE40)	1TX	Not Support
802.11ax (HE80)	1TX	Not Support
Radio 3		
802.11a	2TX	Not Support
802.11n (HT20)	2TX	Support
802.11n (HT40)	2TX	Support
802.11ac (VHT20)	2TX	Support
802.11ac (VHT40)	2TX	Support
802.11ac (VHT80)	2TX	Support
802.11ax (HE20)	2TX	Support
802.11ax (HE40)	2TX	Support
802.11ax (HE80)	2TX	Support

Radio 4		
BT5.0	1TX	Not Support

*The modulation and bandwidth are similar for 802.11n mode for HT20 / HT40 ,802.11ac mode for VHT20 / VHT40 / VHT80 and 802.11ax HE20 / HE40 / HE80, therefore investigated worst case to representative mode in test report. (Final test mode refer section 3.2.1)

*The worst case of Radio 3 is beamforming on mode for the final tests.

*The worst configuration is as below.

Mode	Chain
Radio 1 / 2TX	Chain 0 + 1
Radio 2 / 1TX	Chain 0
Radio 3 / 2TX	Chain 0 + 1
Radio 4 / 1TX	Chain 0

*After estimating, 2TX is the worst case for the final tests.

4. The EUT contains following accessory devices. (Support unit only)

Product	Brand	Model	Description
POE	Microsemi	PD-9001GR/AC	I/P: 100-240 Vac, 50/60 Hz, 0.67 A O/P: 55 Vdc, 0.6 A

5. The following antennas were provided to the EUT.

Antenna Type	PIFA	
Antenna Connector	IPEX	
Gain (dBi)	Frequency	
	2.4~2.4835GHz	5.15~5.85GHz
Int. WIFI Ant. 1	2.7	5.5
Int. WIFI Ant. 2	2.9	5.7
Scanning Radio Ant.	2.1	5

*Int. WIFI Ant. 1~2 (2.4G) were for Radio 1 and Int. WIFI Ant. 1~2 (5G) were for Radio 3.

*Scanning Radio Ant. was for Radio 2

6. The above Antenna information is declared by manufacturer and for more detailed features description, please refer to the manufacturer's specifications, the laboratory shall not be held responsible.

7. The above EUT information is declared by manufacturer and for more detailed features description, please refers to the manufacturer's specifications or user's manual.

3.2 Description of Test Modes

For 5260 ~ 5320 MHz

4 channels are provided for 802.11a, 802.11n (HT20), 802.11ac (VHT20), 802.11ax (HE20):

Channel	Frequency (MHz)	Channel	Frequency (MHz)
52	5260	60	5300
56	5280	64	5320

2 channels are provided for 802.11n (HT40), 802.11ac (VHT40), 802.11ax (HE40):

Channel	Frequency (MHz)	Channel	Frequency (MHz)
54	5270	62	5310

1 channel is provided for 802.11ac (VHT80):

Channel	Frequency (MHz)
58	5290

For 5500 ~ 5700 MHz

11 channels are provided for 802.11a, 802.11n (HT20), 802.11ac (VHT20), 802.11ax (HE20):

Channel	Frequency (MHz)	Channel	Frequency (MHz)
100	5500	124	5620
104	5520	128	5640
108	5540	132	5660
112	5560	136	5680
116	5580	140	5700
120	5600		

5 channels are provided for 802.11n (HT40), 802.11ac (VHT40), 802.11ax (HE40):

Channel	Frequency (MHz)	Channel	Frequency (MHz)
102	5510	126	5630
110	5550	134	5670
118	5590		

2 channels are provided for 802.11ac (VHT80):

Channel	Frequency (MHz)	Channel	Frequency (MHz)
106	5530	122	5610

3.2.1 Test Mode Applicability and Tested Channel Detail

EUT Configure Mode	Applicable To				Description
	RE \geq 1G	RE $<$ 1G	PLC	APCM	
A	√	√	√	√	Radio 3 (WL2)
B	√	√	√	√	Radio 2(WL1) Scanning

Where **RE \geq 1G**: Radiated Emission above 1 GHz **RE $<$ 1G**: Radiated Emission below 1 GHz
PLC: Power Line Conducted Emission **APCM**: Antenna Port Conducted Measurement

Note:

1. The EUT had been pre-tested on the positioned of each 3 axis. The worst case was found when positioned on **Z-plane**.
2. "-" means no effect.

Radiated Emission Test (Above 1 GHz):

- Pre-Scan has been conducted to determine the worst-case mode from all possible combinations between available modulations, data rates and antenna ports (if EUT with antenna diversity architecture).
- Following channel(s) was (were) selected for the final test as listed below.

EUT Configure Mode	Frequency Band (MHz)	Mode	Available Channel	Tested Channel	Modulation Technology	Modulation Type	Data Rate (Mbps)
A, B	5260-5320	802.11a	52 to 64	52, 60, 64	OFDM	BPSK	6.0
		802.11ax (HE20)	52 to 64	52, 60, 64	OFDMA	BPSK	MCS0
		802.11ax (HE40)	54 to 62	54, 62	OFDMA	BPSK	MCS0
		802.11ax (HE80)	58	58	OFDMA	BPSK	MCS0
	5500-5700	802.11a	100 to 140	100, 116, 140	OFDM	BPSK	6.0
		802.11ax (HE20)	100 to 140	100, 116, 140	OFDMA	BPSK	MCS0
		802.11ax (HE40)	102 to 134	102, 110, 134	OFDMA	BPSK	MCS0
		802.11ax (HE80)	106 to 122	106, 122	OFDMA	BPSK	MCS0

Radiated Emission Test (Below 1 GHz):

- Pre-Scan has been conducted to determine the worst-case mode from all possible combinations between available modulations, data rates and antenna ports (if EUT with antenna diversity architecture).
- Following channel(s) was (were) selected for the final test as listed below.

EUT Configure Mode	Frequency Band (MHz)	Mode	Available Channel	Tested Channel	Modulation Technology	Modulation Type	Data Rate (Mbps)
A	5500-5700	802.11ax (HE40)	102 to 134	102	OFDMA	BPSK	MCS0
B	5500-5700	802.11ax (HE80)	106 to 122	122	OFDMA	BPSK	MCS0

Power Line Conducted Emission Test:

- Pre-Scan has been conducted to determine the worst-case mode from all possible combinations between available modulations, data rates and antenna ports (if EUT with antenna diversity architecture).
- Following channel(s) was (were) selected for the final test as listed below.

EUT Configure Mode	Frequency Band (MHz)	Mode	Available Channel	Tested Channel	Modulation Technology	Modulation Type	Data Rate (Mbps)
A	5500-5700	802.11ax (HE40)	102 to 134	102	OFDM	BPSK	MCS0
B	5500-5700	802.11ax (HE80)	106 to 122	122	OFDM	BPSK	MCS0

Antenna Port Conducted Measurement:

- This item includes all test value of each mode, but only includes spectrum plot of worst value of each mode.
- Pre-Scan has been conducted to determine the worst-case mode from all possible combinations between available modulations, data rates and antenna ports (if EUT with antenna diversity architecture).
- Following channel(s) was (were) selected for the final test as listed below.

EUT Configure Mode	Frequency Band (MHz)	Mode	Available Channel	Tested Channel	Modulation Technology	Modulation Type	Data Rate (Mbps)
A, B	5260-5320	802.11a	52 to 64	52, 60, 64	OFDM	BPSK	6.0
		802.11ax (HE20)	52 to 64	52, 60, 64	OFDMA	BPSK	MCS0
		802.11ax (HE40)	54 to 62	54, 62	OFDMA	BPSK	MCS0
		802.11ax (HE80)	58	58	OFDMA	BPSK	MCS0
	5500-5700	802.11a	100 to 140	100, 116, 140	OFDM	BPSK	6.0
		802.11ax (HE20)	100 to 140	100, 116, 140	OFDMA	BPSK	MCS0
		802.11ax (HE40)	102 to 134	102, 110, 134	OFDMA	BPSK	MCS0
		802.11ax (HE80)	106 to 122	106, 122	OFDMA	BPSK	MCS0

Test Condition:

Applicable To	Environmental Conditions	Input Power	Tested by
RE \geq 1G	25 deg. C, 65 % RH	120 Vac, 60 Hz	Karl Lee, Charles Hsiao
RE<1G	25 deg. C, 65 % RH	120 Vac, 60 Hz	Karl Lee
PLC	25 deg. C, 65 % RH	120 Vac, 60 Hz	Jisyong Wang
APCM	25 deg. C, 65 % RH	120 Vac, 60 Hz	Gavin Wu

3.3 Duty Cycle of Test Signal

Duty cycle of test signal is < 98 %, duty factor is required.

Mode A

802.11a: Duty cycle = $2.062/2.171 = 0.95$, Duty factor = $10 * \log(1/0.95) = 0.22$

802.11ax (HE20): Duty cycle = $1.486/1.519 = 0.978$, Duty factor = $10 * \log(1/0.978) = 0.10$

802.11ax (HE40): Duty cycle = $0.943/0.989 = 0.953$, Duty factor = $10 * \log(1/0.953) = 0.21$

802.11ax (HE80): Duty cycle = $0.401/0.435 = 0.922$, Duty factor = $10 * \log(1/0.922) = 0.35$

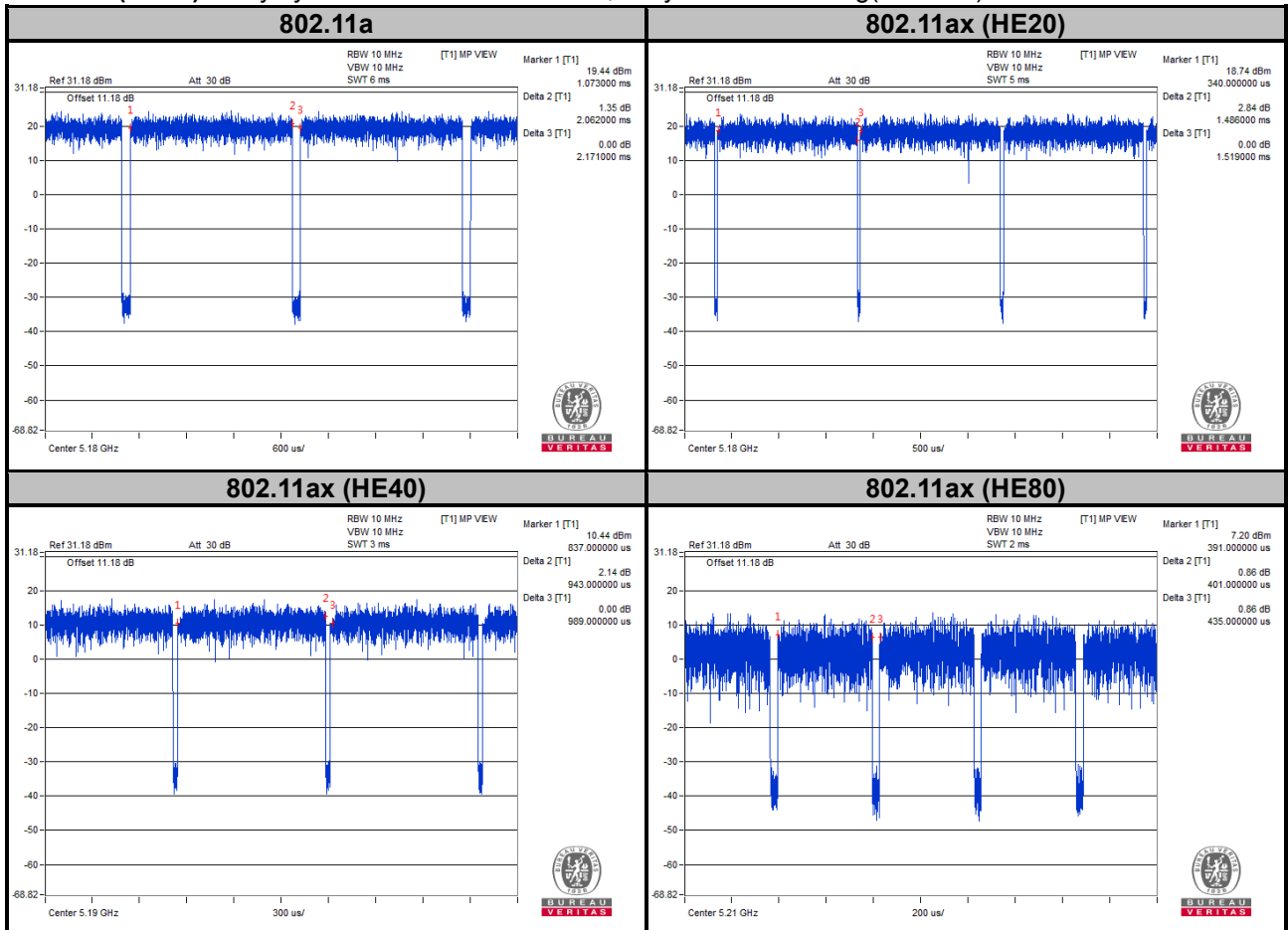

Mode B

802.11a: Duty cycle = $2.064/2.172 = 0.95$, Duty factor = $10 * \log(1/0.95) = 0.22$

802.11ax (HE20): Duty cycle = $1.486/1.52 = 0.978$, Duty factor = $10 * \log(1/0.978) = 0.10$

802.11ax (HE40): Duty cycle = $0.772/0.804 = 0.96$, Duty factor = $10 * \log(1/0.96) = 0.18$

802.11ax (HE80): Duty cycle = $0.4/0.436 = 0.917$, Duty factor = $10 * \log(1/0.917) = 0.37$

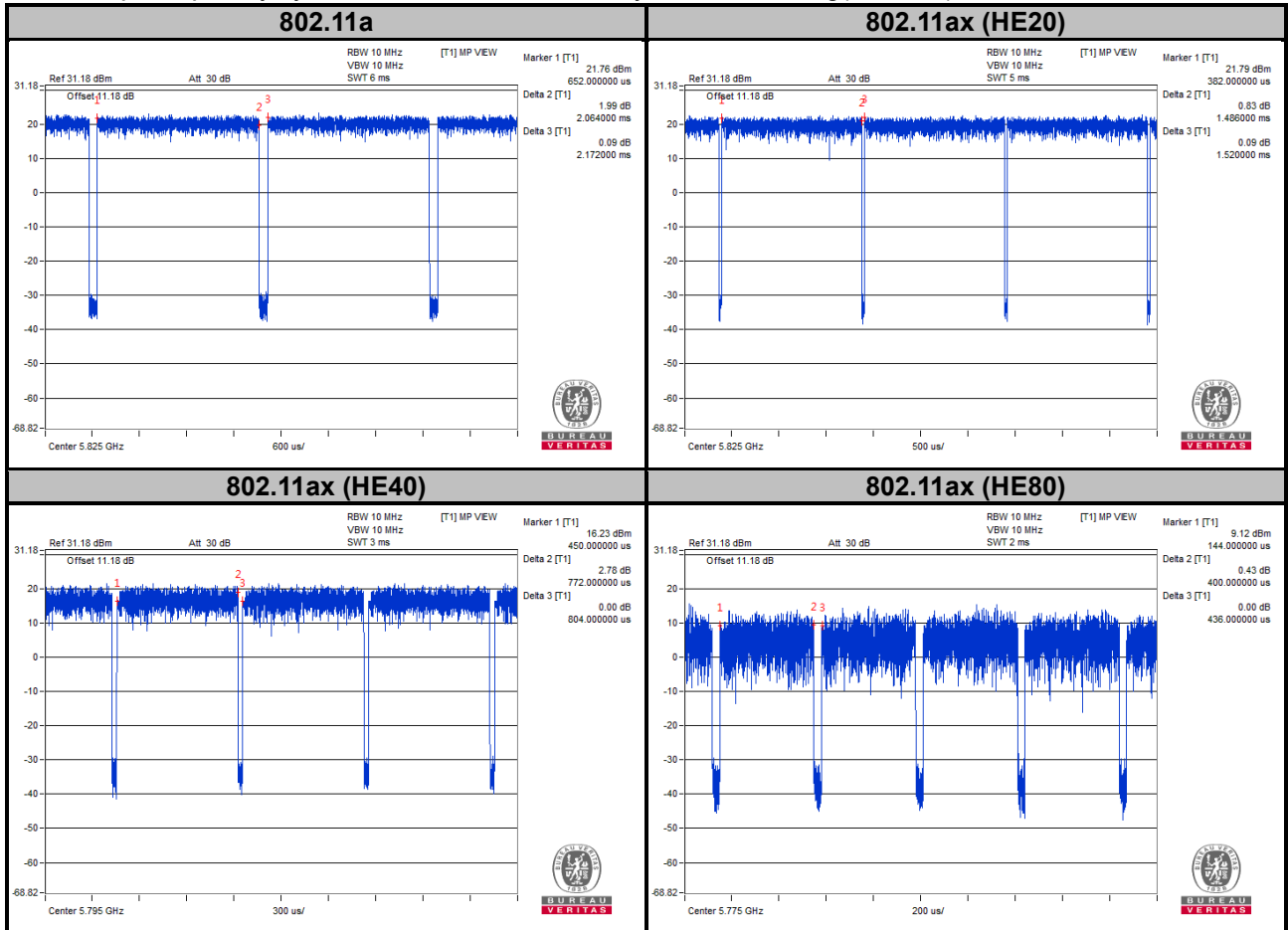

3.4 Description of Support Units

The EUT has been tested as an independent unit together with other necessary accessories or support units. The following support units or accessories were used to form a representative test configuration during the tests.

No.	Product	Brand	Model No.	Serial No.	FCC ID
A	Notebook	DELL	E6420	D3T96R1	FCC DoC Approved

ID	Cable Descriptions	Qty.	Length (m)	Shielding (Yes/No)	Cores (Qty.)	Remarks
1.	RJ45 Cable	1	1	N	0	Cat5e
2.	RJ45 Cable	1	1	N	0	Cat5e

Note:

1. All power cords of the above support units are non-shielded (1.8m).
2. Items A acted as communication partners to transfer data.

3.4.1 Configuration of System under Test

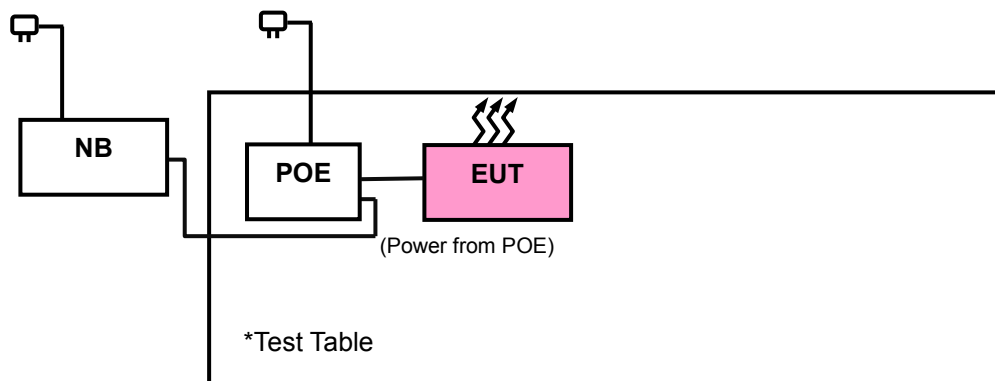

3.5 General Description of Applied Standards and References

The EUT is a RF Product. According to the specifications of the manufacturer, it must comply with the requirements of the following standards and references:

Test Standard:

FCC Part 15, Subpart E (15.407)

ANSI C63.10-2013

All test items have been performed and recorded as per the above standards.

References Test Guidance:

KDB 789033 D02 General UNII Test Procedures New Rules v02r01

KDB 662911 D01 Multiple Transmitter Output v02r01

All test items have been performed as a reference to the above KDB test guidance.

4 Test Types and Results

4.1 Radiated Emission and Bandedge Measurement

4.1.1 Limits of Radiated Emission and Bandedge Measurement

Radiated emissions which fall in the restricted bands must comply with the radiated emission limits specified as below table.

Frequencies (MHz)	Field Strength (microvolts/meter)	Measurement Distance (meters)
0.009 ~ 0.490	2400/F (kHz)	300
0.490 ~ 1.705	24000/F (kHz)	30
1.705 ~ 30.0	30	30
30 ~ 88	100	3
88 ~ 216	150	3
216 ~ 960	200	3
Above 960	500	3

Note:

1. The lower limit shall apply at the transition frequencies.
2. Emission level (dBuV/m) = 20 log Emission level (uV/m).
3. For frequencies above 1000 MHz, the field strength limits are based on average detector, however, the peak field strength of any emission shall not exceed the maximum permitted average limits, specified above by more than 20 dB under any condition of modulation.

Limits of Unwanted Emission Out of the Restricted Bands

Applicable To		Limit	
789033 D02 General UNII Test Procedures New Rules v02r01		Field Strength at 3 m	
		PK: 74 (dBµV/m)	AV: 54 (dBµV/m)
Frequency Band	Applicable To	EIRP Limit	Equivalent Field Strength at 3 m
5150~5250 MHz	15.407(b)(1)	PK: -27 (dBm/MHz)	PK: 68.2 (dBµV/m)
5250~5350 MHz	15.407(b)(2)		
5470~5725 MHz	15.407(b)(3)		
5725~5850 MHz	<input checked="" type="checkbox"/> 15.407(b)(4)(i)	PK:-27 (dBm/MHz) * ¹ PK:10 (dBm/MHz) * ² PK:15.6 (dBm/MHz) * ³ PK:27 (dBm/MHz) * ⁴	PK: 68.2 (dBµV/m) * ¹ PK:105.2 (dBµV/m) * ² PK: 110.8 (dBµV/m) * ³ PK:122.2 (dBµV/m) * ⁴
	<input type="checkbox"/> 15.407(b)(4)(ii)	Emission limits in section 15.247(d)	
<p>*¹ beyond 75 MHz or more above of the band edge.</p> <p>*² below the band edge increasing linearly to 10 dBm/MHz at 25 MHz above.</p> <p>*³ below the band edge increasing linearly to a level of 15.6 dBm/MHz at 5 MHz above.</p> <p>*⁴ from 5 MHz above or below the band edge increasing linearly to a level of 27 dBm/MHz at the band edge.</p>			

Note:

The following formula is used to convert the equipment isotropic radiated power (eirp) to field strength:

$$E = \frac{1000000\sqrt{30P}}{3} \mu\text{V/m, where } P \text{ is the eirp (Watts).}$$

4.1.2 Test Instruments

Description & Manufacturer	Model No.	Serial No.	Date of Calibration	Due Date of Calibration
Test Receiver Agilent Technologies	N9038A	MY52260177	Aug. 26, 2019	Aug. 25, 2020
Spectrum Analyzer ROHDE & SCHWARZ	FSU43	101261	Apr. 16, 2020	Apr. 15, 2021
BILOG Antenna SCHWARZBECK	VULB 9168	9168-616	Nov. 12, 2019	Nov. 11, 2020
HORN Antenna ETS-Lindgren	3117	00143293	Nov. 24, 2019	Nov. 23, 2020
HORN Antenna SCHWARZBECK	BBHA 9170	9170-480	Nov. 24, 2019	Nov. 23, 2020
Fixed Attenuator Mini-Circuits	MDCS18N-10	MDCS18N-10-01	Apr. 14, 2020	Apr. 13, 2021
Loop Antenna	HLA 6121	45745	Jul. 06, 2020	Jul. 05, 2021
Preamplifier Agilent	310N	187226	Jun. 17, 2020	Jun. 16, 2021
Preamplifier Agilent	83017A	MY39501357	Jun. 17, 2020	Jun. 16, 2021
Power Meter Anritsu	ML2495A	1012010	Sep. 04, 2019	Sep. 03, 2020
Power Sensor Anritsu	MA2411B	1315050	Sep. 04, 2019	Sep. 03, 2020
RF signal cable ETS-LINDGREN	5D-FB	Cable-CH1-01(RFC-SMS-100-SMS-120+RFC-SMS-100-SMS-400)	Jun. 17, 2020	Jun. 16, 2021
RF signal cable ETS-LINDGREN	8D-FB	Cable-CH1-02(RFC-SMS-100-SMS-24)	Jun. 17, 2020	Jun. 17, 2021
Software BV ADT	E3 8.130425b	NA	NA	NA
Antenna Tower MF	NA	NA	NA	NA
Turn Table MF	NA	NA	NA	NA
Antenna Tower & Turn Table Controller MF	MF-7802	NA	NA	NA

- Note: 1. The calibration interval of the above test instruments is 12 / 24 months and the calibrations are traceable to NML/ROC and NIST/USA.
2. The test was performed in HsinTien Chamber 1.

4.1.3 Test Procedures

For Radiated Emission below 30 MHz

- a. The EUT was placed on the top of a rotating table 0.8 meters above the ground at a 3 meter chamber room. The table was rotated 360 degrees to determine the position of the highest radiation.
- b. The EUT was set 3 meters away from the interference-receiving antenna, which was mounted on the top of a variable-height antenna tower.
- c. Parallel, perpendicular, and ground-parallel orientations of the antenna are set to make the measurement.
- d. For each suspected emission, the EUT was arranged to its worst case and the rotatable table was turned from 0 degrees to 360 degrees to find the maximum reading.
- e. The test-receiver system was set to Quasi-Peak Detect Function and Specified Bandwidth with Maximum Hold Mode.

Note:

1. The resolution bandwidth and video bandwidth of test receiver/spectrum analyzer is 9 kHz at frequency below 30 MHz.

For Radiated Emission above 30 MHz

- a. The EUT was placed on the top of a rotating table 0.8 meters (for 30 MHz ~ 1 GHz) / 1.5 meters (for above 1 GHz) above the ground at 3 meter chamber room for test. The table was rotated 360 degrees to determine the position of the highest radiation.
- b. The EUT was set 3 meters away from the interference-receiving antenna, which was mounted on the top of a variable-height antenna tower.
- c. The height of antenna is varied from one meter to four meters above the ground to determine the maximum value of the field strength. Both horizontal and vertical polarizations of the antenna are set to make the measurement.
- d. For each suspected emission, the EUT was arranged to its worst case and then the antenna was tuned to heights from 1 meter to 4 meters and the rotatable table was turned from 0 degrees to 360 degrees to find the maximum reading.
- e. The test-receiver system was set to quasi-peak detect function and specified bandwidth with maximum hold mode when the test frequency is below 1 GHz.
- f. The test-receiver system was set to peak and average detected function and specified bandwidth with maximum hold mode when the test frequency is above 1 GHz. If the peak reading value also meets average limit, measurement with the average detector is unnecessary.

Note:

1. The resolution bandwidth and video bandwidth of test receiver/spectrum analyzer is 120 kHz for Quasi-peak detection (QP) or Peak detection (PK) at frequency below 1 GHz.
2. The resolution bandwidth of test receiver/spectrum analyzer is 1 MHz and the video bandwidth is 3 MHz for Peak detection (PK) at frequency above 1 GHz.
3. The resolution bandwidth of test receiver/spectrum analyzer is 1 MHz and the video bandwidth is $\geq 1/T$ (Duty cycle < 98 %) or 10 Hz (Duty cycle ≥ 98 %) for Average detection (AV) at frequency above 1 GHz.
(11a: RBW = 1 MHz, VBW = 510 Hz ; 11ax (HE20): RBW = 1 MHz, VBW = 1 kHz ;
11ax (HE40): RBW = 1 MHz, VBW = 2 kHz ; 11ax (HE80): RBW = 1 MHz, VBW = 3 kHz)
4. All modes of operation were investigated and the worst-case emissions are reported.

4.1.4 Deviation from Test Standard

No deviation.

4.1.5 Test Setup

<Radiated Emission below 30 MHz>

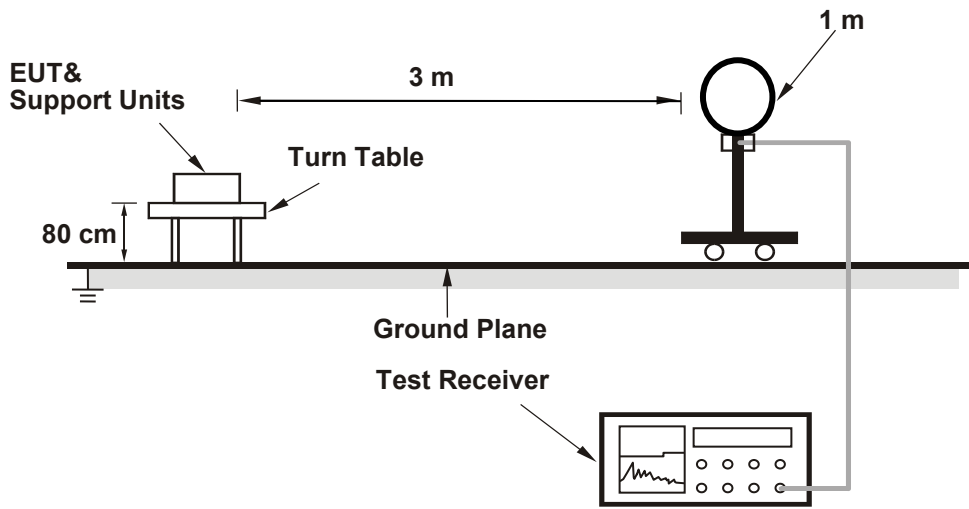

<Radiated Emission 30 MHz to 1 GHz>

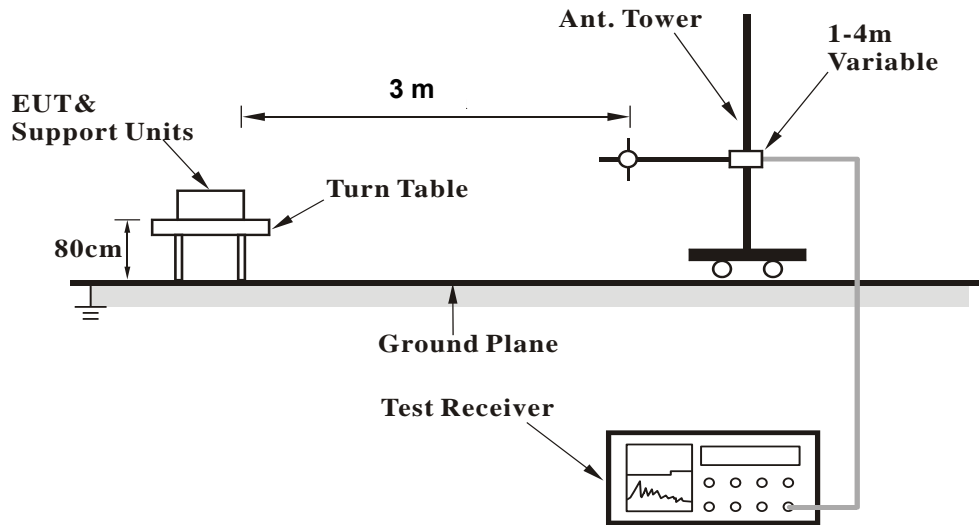

<Radiated Emission above 1 GHz>

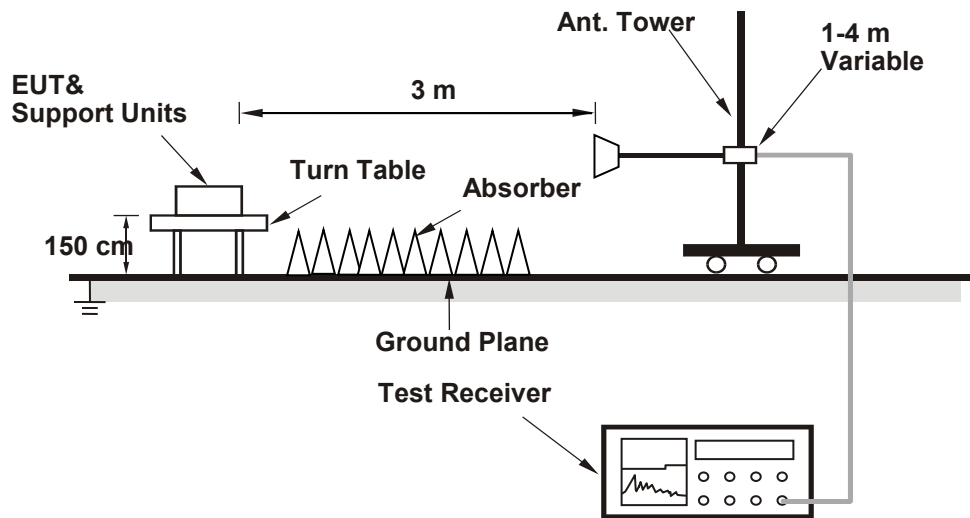

For the actual test configuration, please refer to the attached file (Test Setup Photo).

4.1.6 EUT Operating Conditions

- a. Placed the EUT on a testing table.
- b. Use the software to control the EUT under transmission condition continuously at specific channel frequency.

4.1.7 Test Results
Above 1 GHz Data :
Mode A
802.11a

EUT Test Condition		Measurement Detail	
Channel	Channel 52	Frequency Range	1 GHz ~ 40 GHz
Input Power	120 Vac, 60 Hz	Detector Function	Peak (PK) Average (AV)
Environmental Conditions	25 deg. C, 65 % RH	Tested By	Charles Hsiao

Antenna Polarity & Test Distance: Horizontal at 3 m								
Frequency (MHz)	Emission Level (dBuV/m)	Read Level (dBuV)	Factor (dB/m)	Limit (dBuV/m)	Margin (dB)	Antenna Height (cm)	Table Angle (Degree)	Remark
5150	50.7	40.65	10.05	54	-3.3	200	356	Average
5150	65.08	55.03	10.05	74	-8.92	200	356	Peak
5260	111.64	101.52	10.12			200	356	Average
5260	118.18	108.06	10.12			200	356	Peak
5350	53.81	43.58	10.23	54	-0.19	203	356	Average
5350	66.69	56.46	10.23	74	-7.31	203	356	Peak
*10520	56.25	40.37	15.88	68.2	-11.95	128	44	Peak

Antenna Polarity & Test Distance: Vertical at 3 m								
Frequency (MHz)	Emission Level (dBuV/m)	Read Level (dBuV)	Factor (dB/m)	Limit (dBuV/m)	Margin (dB)	Antenna Height (cm)	Table Angle (Degree)	Remark
5150	44.02	33.97	10.05	54	-9.98	233	52	Average
5150	54.49	44.44	10.05	74	-19.51	233	52	Peak
5260	104.45	94.33	10.12			233	52	Average
5260	111.62	101.5	10.12			233	52	Peak
5350	43.07	32.84	10.23	54	-10.93	233	52	Average
5350	53.64	43.41	10.23	74	-20.36	233	52	Peak
*10520	55.36	39.48	15.88	68.2	-12.84	161	29	Peak

Remarks:

- Emission Level = Read Level + Factor
Margin value = Emission level – Limit value
- 5260 MHz: Fundamental Frequency
- *: Out of Restricted Band
- The emission levels of other frequencies were very low against the limit

EUT Test Condition		Measurement Detail	
Channel	Channel 60	Frequency Range	1 GHz ~ 40 GHz
Input Power	120 Vac, 60 Hz	Detector Function	Peak (PK) Average (AV)
Environmental Conditions	25 deg. C, 65 % RH	Tested By	Charles Hsiao

Antenna Polarity & Test Distance: Horizontal at 3 m								
Frequency (MHz)	Emission Level (dBuV/m)	Read Level (dBuV)	Factor (dB/m)	Limit (dBuV/m)	Margin (dB)	Antenna Height (cm)	Table Angle (Degree)	Remark
5150	47.98	37.93	10.05	54	-6.02	200	356	Average
5150	58.22	48.17	10.05	74	-15.78	200	356	Peak
5300	110.24	100.18	10.06			200	356	Average
5300	117.03	106.97	10.06			200	356	Peak
5350	53.86	43.63	10.23	54	-0.14	202	356	Average
5350	70.11	59.88	10.23	74	-3.89	202	356	Peak
10600	46.47	30.71	15.76	54	-7.53	162	113	Average
10600	56.07	40.31	15.76	74	-17.93	162	113	Peak

Antenna Polarity & Test Distance: Vertical at 3 m								
Frequency (MHz)	Emission Level (dBuV/m)	Read Level (dBuV)	Factor (dB/m)	Limit (dBuV/m)	Margin (dB)	Antenna Height (cm)	Table Angle (Degree)	Remark
5150	43.57	33.52	10.05	54	-10.43	224	24	Average
5150	53.85	43.8	10.05	74	-20.15	224	24	Peak
5300	103.37	93.31	10.06			224	24	Average
5300	110.76	100.7	10.06			224	24	Peak
5350	44.19	33.96	10.23	54	-9.81	224	24	Average
5350	58.09	47.86	10.23	74	-15.91	224	24	Peak
10600	45.69	29.93	15.76	54	-8.31	185	112	Average
10600	55.16	39.4	15.76	74	-18.84	185	112	Peak

Remarks:

- Emission Level = Read Level + Factor
Margin value = Emission level – Limit value
- 5300 MHz: Fundamental Frequency
- *: Out of Restricted Band
- The emission levels of other frequencies were very low against the limit

EUT Test Condition		Measurement Detail	
Channel	Channel 64	Frequency Range	1 GHz ~ 40 GHz
Input Power	120 Vac, 60 Hz	Detector Function	Peak (PK) Average (AV)
Environmental Conditions	25 deg. C, 65 % RH	Tested By	Karl Lee

Antenna Polarity & Test Distance: Horizontal at 3 m								
Frequency (MHz)	Emission Level (dBuV/m)	Read Level (dBuV)	Factor (dB/m)	Limit (dBuV/m)	Margin (dB)	Antenna Height (cm)	Table Angle (Degree)	Remark
5320	110.1	100.01	10.09			192	317	Average
5320	118.32	108.23	10.09			192	317	Peak
5350	53.72	43.49	10.23	54	-0.28	186	314	Average
5350	69.47	59.24	10.23	74	-4.53	186	314	Peak
10640	45.72	29.73	15.99	54	-8.28	125	176	Average
10640	55.5	39.51	15.99	74	-18.5	125	176	Peak

Antenna Polarity & Test Distance: Vertical at 3 m								
Frequency (MHz)	Emission Level (dBuV/m)	Read Level (dBuV)	Factor (dB/m)	Limit (dBuV/m)	Margin (dB)	Antenna Height (cm)	Table Angle (Degree)	Remark
5320	102.57	92.48	10.09			217	6	Average
5320	110.38	100.29	10.09			217	6	Peak
5350	48.91	38.68	10.23	54	-5.09	217	14	Average
5350	65.26	55.03	10.23	74	-8.74	217	14	Peak
10640	45.43	29.44	15.99	54	-8.57	115	146	Average
10640	55.12	39.13	15.99	74	-18.88	115	146	Peak

Remarks:

- Emission Level = Read Level + Factor
Margin value = Emission level – Limit value
- 5320 MHz: Fundamental Frequency
- *: Out of Restricted Band
- The emission levels of other frequencies were very low against the limit

EUT Test Condition		Measurement Detail	
Channel	Channel 100	Frequency Range	1 GHz ~ 40 GHz
Input Power	120 Vac, 60 Hz	Detector Function	Peak (PK) Average (AV)
Environmental Conditions	25 deg. C, 65 % RH	Tested By	Karl Lee

Antenna Polarity & Test Distance: Horizontal at 3 m								
Frequency (MHz)	Emission Level (dBuV/m)	Read Level (dBuV)	Factor (dB/m)	Limit (dBuV/m)	Margin (dB)	Antenna Height (cm)	Table Angle (Degree)	Remark
5460	46.49	35.98	10.51	54	-7.51	201	298	Average
5460	56.5	45.99	10.51	74	-17.5	201	298	Peak
*5470	67.95	57.42	10.53	68.2	-0.25	201	298	Peak
5500	105.68	95.08	10.6			206	301	Average
5500	113.1	102.5	10.6			206	301	Peak
11000	47.36	31.23	16.13	54	-6.64	184	127	Average
11000	56.95	40.82	16.13	74	-17.05	184	127	Peak

Antenna Polarity & Test Distance: Vertical at 3 m								
Frequency (MHz)	Emission Level (dBuV/m)	Read Level (dBuV)	Factor (dB/m)	Limit (dBuV/m)	Margin (dB)	Antenna Height (cm)	Table Angle (Degree)	Remark
5460	44.11	33.6	10.51	54	-9.89	216	3	Average
5460	55.41	44.9	10.51	74	-18.59	216	3	Peak
*5470	58.62	48.09	10.53	68.2	-9.58	216	3	Peak
5500	99.42	88.82	10.6			209	2	Average
5500	105.53	94.93	10.6			209	2	Peak
11000	46.21	30.08	16.13	54	-7.79	124	163	Average
11000	55.82	39.69	16.13	74	-18.18	124	163	Peak

Remarks:

- Emission Level = Read Level + Factor
Margin value = Emission level – Limit value
- 5500 MHz: Fundamental Frequency
- *: Out of Restricted Band
- The emission levels of other frequencies were very low against the limit

EUT Test Condition		Measurement Detail	
Channel	Channel 116	Frequency Range	1 GHz ~ 40 GHz
Input Power	120 Vac, 60 Hz	Detector Function	Peak (PK) Average (AV)
Environmental Conditions	25 deg. C, 65 % RH	Tested By	Charles Hsiao

Antenna Polarity & Test Distance: Horizontal at 3 m								
Frequency (MHz)	Emission Level (dBuV/m)	Read Level (dBuV)	Factor (dB/m)	Limit (dBuV/m)	Margin (dB)	Antenna Height (cm)	Table Angle (Degree)	Remark
5460	53.61	43.1	10.51	54	-0.39	212	301	Average
5460	66.66	56.15	10.51	74	-7.34	212	301	Peak
*5470	67.43	56.9	10.53	68.2	-0.77	212	301	Peak
5580	115.25	104.54	10.71			206	301	Average
5580	121.06	110.35	10.71			206	301	Peak
*5725	62.24	51.32	10.92	68.2	-5.96	206	301	Peak
11160	47.22	30.86	16.36	54	-6.78	156	248	Average
11160	56.74	40.38	16.36	74	-17.26	156	248	Peak

Antenna Polarity & Test Distance: Vertical at 3 m								
Frequency (MHz)	Emission Level (dBuV/m)	Read Level (dBuV)	Factor (dB/m)	Limit (dBuV/m)	Margin (dB)	Antenna Height (cm)	Table Angle (Degree)	Remark
5460	47.72	37.21	10.51	54	-6.28	216	3	Average
5460	58	47.49	10.51	74	-16	216	3	Peak
*5470	60.5	49.97	10.53	68.2	-7.7	216	3	Peak
5580	109.58	98.87	10.71			216	3	Average
5580	116.08	105.37	10.71			216	3	Peak
*5725	55.22	44.3	10.92	68.2	-12.98	216	3	Peak
11160	47.16	30.8	16.36	54	-6.84	165	124	Average
11160	56.63	40.27	16.36	74	-17.37	165	124	Peak

Remarks:

- Emission Level = Read Level + Factor
Margin value = Emission level – Limit value
- 5580 MHz: Fundamental Frequency
- *: Out of Restricted Band
- The emission levels of other frequencies were very low against the limit

EUT Test Condition		Measurement Detail	
Channel	Channel 140	Frequency Range	1 GHz ~ 40 GHz
Input Power	120 Vac, 60 Hz	Detector Function	Peak (PK) Average (AV)
Environmental Conditions	25 deg. C, 65 % RH	Tested By	Charles Hsiao

Antenna Polarity & Test Distance: Horizontal at 3 m								
Frequency (MHz)	Emission Level (dBuV/m)	Read Level (dBuV)	Factor (dB/m)	Limit (dBuV/m)	Margin (dB)	Antenna Height (cm)	Table Angle (Degree)	Remark
5700	104.57	93.62	10.95			206	301	Average
5700	111.3	100.35	10.95			206	301	Peak
*5725	67.91	56.99	10.92	68.2	-0.29	214	301	Peak
11400	46.31	30.12	16.19	54	-7.69	128	191	Average
11400	55.76	39.57	16.19	74	-18.24	128	191	Peak

Antenna Polarity & Test Distance: Vertical at 3 m								
Frequency (MHz)	Emission Level (dBuV/m)	Read Level (dBuV)	Factor (dB/m)	Limit (dBuV/m)	Margin (dB)	Antenna Height (cm)	Table Angle (Degree)	Remark
5700	98.59	87.64	10.95			216	3	Average
5700	105.21	94.26	10.95			216	3	Peak
*5725	60.61	49.69	10.92	68.2	-7.59	216	3	Peak
11400	46.45	30.26	16.19	54	-7.55	134	175	Average
11400	56.05	39.86	16.19	74	-17.95	134	175	Peak

Remarks:

- Emission Level = Read Level + Factor
Margin value = Emission level – Limit value
- 5700 MHz: Fundamental Frequency
- *: Out of Restricted Band
- The emission levels of other frequencies were very low against the limit

802.11ax (HE20)

EUT Test Condition		Measurement Detail	
Channel	Channel 52	Frequency Range	1 GHz ~ 40 GHz
Input Power	120 Vac, 60 Hz	Detector Function	Peak (PK) Average (AV)
Environmental Conditions	25 deg. C, 65 % RH	Tested By	Charles Hsiao

Antenna Polarity & Test Distance: Horizontal at 3 m								
Frequency (MHz)	Emission Level (dBuV/m)	Read Level (dBuV)	Factor (dB/m)	Limit (dBuV/m)	Margin (dB)	Antenna Height (cm)	Table Angle (Degree)	Remark
5150	47.58	37.53	10.05	54	-6.42	200	356	Average
5150	61.78	51.73	10.05	74	-12.22	200	356	Peak
5260	109.54	99.42	10.12			200	356	Average
5260	116.02	105.9	10.12			200	356	Peak
5350	53.34	43.11	10.23	54	-0.66	202	344	Average
5350	66.61	56.38	10.23	74	-7.39	202	344	Peak
*10520	55.57	39.69	15.88	68.2	-12.63	154	151	Peak

Antenna Polarity & Test Distance: Vertical at 3 m								
Frequency (MHz)	Emission Level (dBuV/m)	Read Level (dBuV)	Factor (dB/m)	Limit (dBuV/m)	Margin (dB)	Antenna Height (cm)	Table Angle (Degree)	Remark
5150	44.87	34.82	10.05	54	-9.13	224	24	Average
5150	56.07	46.02	10.05	74	-17.93	224	24	Peak
5260	105.74	95.62	10.12			224	24	Average
5260	112.3	102.18	10.12			224	24	Peak
5350	41.87	31.64	10.23	54	-12.13	224	24	Average
5350	59.73	49.5	10.23	74	-14.27	224	24	Peak
*10520	55.15	39.27	15.88	68.2	-13.05	180	61	Peak

Remarks:

- Emission Level = Read Level + Factor
Margin value = Emission level – Limit value
- 5260 MHz: Fundamental Frequency
- *: Out of Restricted Band
- The emission levels of other frequencies were very low against the limit

EUT Test Condition		Measurement Detail	
Channel	Channel 60	Frequency Range	1 GHz ~ 40 GHz
Input Power	120 Vac, 60 Hz	Detector Function	Peak (PK) Average (AV)
Environmental Conditions	25 deg. C, 65 % RH	Tested By	Charles Hsiao

Antenna Polarity & Test Distance: Horizontal at 3 m								
Frequency (MHz)	Emission Level (dBuV/m)	Read Level (dBuV)	Factor (dB/m)	Limit (dBuV/m)	Margin (dB)	Antenna Height (cm)	Table Angle (Degree)	Remark
5150	44.75	34.7	10.05	54	-9.25	200	356	Average
5150	54.67	44.62	10.05	74	-19.33	200	356	Peak
5300	108.58	98.52	10.06			200	356	Average
5300	115.58	105.52	10.06			200	356	Peak
5350	53.54	43.31	10.23	54	-0.46	202	356	Average
5350	66.29	56.06	10.23	74	-7.71	202	356	Peak
10600	45.68	29.92	15.76	54	-8.32	117	281	Average
10600	55.35	39.59	15.76	74	-18.65	117	281	Peak

Antenna Polarity & Test Distance: Vertical at 3 m								
Frequency (MHz)	Emission Level (dBuV/m)	Read Level (dBuV)	Factor (dB/m)	Limit (dBuV/m)	Margin (dB)	Antenna Height (cm)	Table Angle (Degree)	Remark
5150	43.24	33.19	10.05	54	-10.76	224	24	Average
5150	53.88	43.83	10.05	74	-20.12	224	24	Peak
5300	103.63	93.57	10.06			224	24	Average
5300	110.03	99.97	10.06			224	24	Peak
5350	46.83	36.6	10.23	54	-7.17	224	24	Average
5350	52.89	42.66	10.23	74	-21.11	224	24	Peak
10600	45.92	30.16	15.76	54	-8.08	126	72	Average
10600	55.68	39.92	15.76	74	-18.32	126	72	Peak

Remarks:

- Emission Level = Read Level + Factor
Margin value = Emission level – Limit value
- 5300 MHz: Fundamental Frequency
- *: Out of Restricted Band
- The emission levels of other frequencies were very low against the limit

EUT Test Condition		Measurement Detail	
Channel	Channel 64	Frequency Range	1 GHz ~ 40 GHz
Input Power	120 Vac, 60 Hz	Detector Function	Peak (PK) Average (AV)
Environmental Conditions	25 deg. C, 65 % RH	Tested By	Karl Lee

Antenna Polarity & Test Distance: Horizontal at 3 m								
Frequency (MHz)	Emission Level (dBuV/m)	Read Level (dBuV)	Factor (dB/m)	Limit (dBuV/m)	Margin (dB)	Antenna Height (cm)	Table Angle (Degree)	Remark
5320	103.6	93.51	10.09			191	316	Average
5320	113.27	103.18	10.09			191	316	Peak
5350	53.83	43.6	10.23	54	-0.17	186	321	Average
5350	66.24	56.01	10.23	74	-7.76	186	321	Peak
10640	46.11	30.12	15.99	54	-7.89	156	276	Average
10640	55.73	39.74	15.99	74	-18.27	156	276	Peak
Antenna Polarity & Test Distance: Vertical at 3 m								
Frequency (MHz)	Emission Level (dBuV/m)	Read Level (dBuV)	Factor (dB/m)	Limit (dBuV/m)	Margin (dB)	Antenna Height (cm)	Table Angle (Degree)	Remark
5320	97.63	87.54	10.09			217	6	Average
5320	107.45	97.36	10.09			217	6	Peak
5350	45.67	35.44	10.23	54	-8.33	217	6	Average
5350	56.21	45.98	10.23	74	-17.79	217	6	Peak
10640	45.36	29.37	15.99	54	-8.64	115	86	Average
10640	54.9	38.91	15.99	74	-19.1	115	86	Peak

Remarks:

- Emission Level = Read Level + Factor
Margin value = Emission level – Limit value
- 5320 MHz: Fundamental Frequency
- *: Out of Restricted Band
- The emission levels of other frequencies were very low against the limit

EUT Test Condition		Measurement Detail	
Channel	Channel 100	Frequency Range	1 GHz ~ 40 GHz
Input Power	120 Vac, 60 Hz	Detector Function	Peak (PK) Average (AV)
Environmental Conditions	25 deg. C, 65 % RH	Tested By	Karl Lee

Antenna Polarity & Test Distance: Horizontal at 3 m								
Frequency (MHz)	Emission Level (dBuV/m)	Read Level (dBuV)	Factor (dB/m)	Limit (dBuV/m)	Margin (dB)	Antenna Height (cm)	Table Angle (Degree)	Remark
5460	46.94	36.43	10.51	54	-7.06	211	294	Average
5460	60.06	49.55	10.51	74	-13.94	211	294	Peak
*5470	67.99	57.46	10.53	68.2	-0.21	211	294	Peak
5500	105.32	94.72	10.6			206	301	Average
5500	114.21	103.61	10.6			206	301	Peak
11000	46.22	30.09	16.13	54	-7.78	112	164	Average
11000	55.91	39.78	16.13	74	-18.09	112	164	Peak

Antenna Polarity & Test Distance: Vertical at 3 m								
Frequency (MHz)	Emission Level (dBuV/m)	Read Level (dBuV)	Factor (dB/m)	Limit (dBuV/m)	Margin (dB)	Antenna Height (cm)	Table Angle (Degree)	Remark
5460	43.93	33.42	10.51	54	-10.07	179	6	Average
5460	53.68	43.17	10.51	74	-20.32	179	6	Peak
*5470	56.86	46.33	10.53	68.2	-11.34	179	6	Peak
5500	98.99	88.39	10.6			209	2	Average
5500	108.43	97.83	10.6			209	2	Peak
11000	45.66	29.53	16.13	54	-8.34	142	115	Average
11000	55.34	39.21	16.13	74	-18.66	142	115	Peak

Remarks:

- Emission Level = Read Level + Factor
Margin value = Emission level – Limit value
- 5500 MHz: Fundamental Frequency
- *: Out of Restricted Band
- The emission levels of other frequencies were very low against the limit

EUT Test Condition		Measurement Detail	
Channel	Channel 116	Frequency Range	1 GHz ~ 40 GHz
Input Power	120 Vac, 60 Hz	Detector Function	Peak (PK) Average (AV)
Environmental Conditions	25 deg. C, 65 % RH	Tested By	Charles Hsiao

Antenna Polarity & Test Distance: Horizontal at 3 m								
Frequency (MHz)	Emission Level (dBuV/m)	Read Level (dBuV)	Factor (dB/m)	Limit (dBuV/m)	Margin (dB)	Antenna Height (cm)	Table Angle (Degree)	Remark
5460	53.69	43.18	10.51	54	-0.31	212	301	Average
5460	64.19	53.68	10.51	74	-9.81	212	301	Peak
*5470	66.9	56.37	10.53	68.2	-1.3	212	301	Peak
5580	112.25	101.54	10.71			206	301	Average
5580	119.24	108.53	10.71			206	301	Peak
*5725	63.36	52.44	10.92	68.2	-4.84	206	301	Peak
11160	47.37	31.01	16.36	54	-6.63	150	129	Average
11160	57.07	40.71	16.36	74	-16.93	150	129	Peak

Antenna Polarity & Test Distance: Vertical at 3 m								
Frequency (MHz)	Emission Level (dBuV/m)	Read Level (dBuV)	Factor (dB/m)	Limit (dBuV/m)	Margin (dB)	Antenna Height (cm)	Table Angle (Degree)	Remark
5460	45.57	35.06	10.51	54	-8.43	216	3	Average
5460	59.95	49.44	10.51	74	-14.05	216	3	Peak
*5470	57.9	47.37	10.53	68.2	-10.3	216	3	Peak
5580	107.41	96.7	10.71			216	3	Average
5580	114.48	103.77	10.71			216	3	Peak
*5725	51.46	40.54	10.92	68.2	-16.74	216	3	Peak
11160	47.29	30.93	16.36	54	-6.71	127	166	Average
11160	56.87	40.51	16.36	74	-17.13	127	166	Peak

Remarks:

- Emission Level = Read Level + Factor
Margin value = Emission level – Limit value
- 5580 MHz: Fundamental Frequency
- *: Out of Restricted Band
- The emission levels of other frequencies were very low against the limit

EUT Test Condition		Measurement Detail	
Channel	Channel 140	Frequency Range	1 GHz ~ 40 GHz
Input Power	120 Vac, 60 Hz	Detector Function	Peak (PK) Average (AV)
Environmental Conditions	25 deg. C, 65 % RH	Tested By	Charles Hsiao

Antenna Polarity & Test Distance: Horizontal at 3 m								
Frequency (MHz)	Emission Level (dBuV/m)	Read Level (dBuV)	Factor (dB/m)	Limit (dBuV/m)	Margin (dB)	Antenna Height (cm)	Table Angle (Degree)	Remark
5700	104.63	93.68	10.95			206	301	Average
5700	111.3	100.35	10.95			206	301	Peak
*5725	67.84	56.92	10.92	68.2	-0.36	214	301	Peak
11400	46.35	30.16	16.19	54	-7.65	125	137	Average
11400	55.79	39.6	16.19	74	-18.21	125	137	Peak
Antenna Polarity & Test Distance: Vertical at 3 m								
Frequency (MHz)	Emission Level (dBuV/m)	Read Level (dBuV)	Factor (dB/m)	Limit (dBuV/m)	Margin (dB)	Antenna Height (cm)	Table Angle (Degree)	Remark
5700	97.41	86.46	10.95			216	3	Average
5700	104.94	93.99	10.95			216	3	Peak
*5725	57.98	47.06	10.92	68.2	-10.22	216	3	Peak
11400	46.39	30.2	16.19	54	-7.61	104	137	Average
11400	55.98	39.79	16.19	74	-18.02	104	137	Peak

Remarks:

- Emission Level = Read Level + Factor
Margin value = Emission level – Limit value
- 5700 MHz: Fundamental Frequency
- *: Out of Restricted Band
- The emission levels of other frequencies were very low against the limit

802.11ax (HE40)

EUT Test Condition		Measurement Detail	
Channel	Channel 54	Frequency Range	1 GHz ~ 40 GHz
Input Power	120 Vac, 60 Hz	Detector Function	Peak (PK) Average (AV)
Environmental Conditions	25 deg. C, 65 % RH	Tested By	Charles Hsiao

Antenna Polarity & Test Distance: Horizontal at 3 m								
Frequency (MHz)	Emission Level (dBuV/m)	Read Level (dBuV)	Factor (dB/m)	Limit (dBuV/m)	Margin (dB)	Antenna Height (cm)	Table Angle (Degree)	Remark
5150	45.78	35.73	10.05	54	-8.22	200	356	Average
5150	56.18	46.13	10.05	74	-17.82	200	356	Peak
5270	105.58	95.46	10.12			200	356	Average
5270	112.1	101.98	10.12			200	356	Peak
5350	53.58	43.35	10.23	54	-0.42	202	344	Average
5350	64.62	54.39	10.23	74	-9.38	202	344	Peak
*10540	55.45	39.62	15.83	68.2	-12.75	135	312	Peak

Antenna Polarity & Test Distance: Vertical at 3 m								
Frequency (MHz)	Emission Level (dBuV/m)	Read Level (dBuV)	Factor (dB/m)	Limit (dBuV/m)	Margin (dB)	Antenna Height (cm)	Table Angle (Degree)	Remark
5150	43.56	33.51	10.05	54	-10.44	224	24	Average
5150	55.05	45	10.05	74	-18.95	224	24	Peak
5270	99.64	89.52	10.12			224	24	Average
5270	106.37	96.25	10.12			224	24	Peak
5350	47.02	36.79	10.23	54	-6.98	224	24	Average
5350	59.35	49.12	10.23	74	-14.65	224	24	Peak
*10540	54.75	38.92	15.83	68.2	-13.45	181	26	Peak

Remarks:

- Emission Level = Read Level + Factor
Margin value = Emission level – Limit value
- 5270 MHz: Fundamental Frequency
- *: Out of Restricted Band
- The emission levels of other frequencies were very low against the limit

EUT Test Condition		Measurement Detail	
Channel	Channel 62	Frequency Range	1 GHz ~ 40 GHz
Input Power	120 Vac, 60 Hz	Detector Function	Peak (PK) Average (AV)
Environmental Conditions	25 deg. C, 65 % RH	Tested By	Karl Lee

Antenna Polarity & Test Distance: Horizontal at 3 m								
Frequency (MHz)	Emission Level (dBuV/m)	Read Level (dBuV)	Factor (dB/m)	Limit (dBuV/m)	Margin (dB)	Antenna Height (cm)	Table Angle (Degree)	Remark
5150	44.65	34.6	10.05	54	-9.35	186	318	Average
5150	54.12	44.07	10.05	74	-19.88	186	318	Peak
5310	97.99	87.9	10.09			182	307	Average
5310	106.08	95.99	10.09			182	307	Peak
5350	53.53	43.3	10.23	54	-0.47	186	318	Average
5350	64.69	54.46	10.23	74	-9.31	186	318	Peak
10620	45.23	29.35	15.88	54	-8.77	163	239	Average
10620	54.74	38.86	15.88	74	-19.26	163	239	Peak

Antenna Polarity & Test Distance: Vertical at 3 m								
Frequency (MHz)	Emission Level (dBuV/m)	Read Level (dBuV)	Factor (dB/m)	Limit (dBuV/m)	Margin (dB)	Antenna Height (cm)	Table Angle (Degree)	Remark
5150	43.12	33.07	10.05	54	-10.88	221	4	Average
5150	53.56	43.51	10.05	74	-20.44	221	4	Peak
5310	91.05	80.96	10.09			217	6	Average
5310	99.94	89.85	10.09			217	6	Peak
5350	46.23	36	10.23	54	-7.77	217	11	Average
5350	54.53	44.3	10.23	74	-19.47	217	11	Peak
10620	45.9	30.02	15.88	54	-8.1	175	121	Average
10620	54.59	38.71	15.88	74	-19.41	175	121	Peak

Remarks:

- Emission Level = Read Level + Factor
Margin value = Emission level – Limit value
- 5310 MHz: Fundamental Frequency
- *: Out of Restricted Band
- The emission levels of other frequencies were very low against the limit

EUT Test Condition		Measurement Detail	
Channel	Channel 102	Frequency Range	1 GHz ~ 40 GHz
Input Power	120 Vac, 60 Hz	Detector Function	Peak (PK) Average (AV)
Environmental Conditions	25 deg. C, 65 % RH	Tested By	Karl Lee

Antenna Polarity & Test Distance: Horizontal at 3 m								
Frequency (MHz)	Emission Level (dBuV/m)	Read Level (dBuV)	Factor (dB/m)	Limit (dBuV/m)	Margin (dB)	Antenna Height (cm)	Table Angle (Degree)	Remark
5460	51.84	41.33	10.51	54	-2.16	198	304	Average
5460	63.03	52.52	10.51	74	-10.97	198	304	Peak
*5470	68.19	57.66	10.53	68.2	-0.01	198	304	Peak
5510	102.47	91.87	10.6			206	302	Average
5510	111.81	101.21	10.6			206	302	Peak
*5725	54.59	43.67	10.92	68.2	-13.61	206	302	Peak
11020	46.39	30.23	16.16	54	-7.61	121	175	Average
11020	55.82	39.66	16.16	74	-18.18	121	175	Peak

Antenna Polarity & Test Distance: Vertical at 3 m								
Frequency (MHz)	Emission Level (dBuV/m)	Read Level (dBuV)	Factor (dB/m)	Limit (dBuV/m)	Margin (dB)	Antenna Height (cm)	Table Angle (Degree)	Remark
5460	46.91	36.4	10.51	54	-7.09	199	11	Average
5460	56.44	45.93	10.51	74	-17.56	199	11	Peak
*5470	60.39	49.86	10.53	68.2	-7.81	199	11	Peak
5510	95.68	85.08	10.6			209	2	Average
5510	104.78	94.18	10.6			209	2	Peak
*5725	51.84	40.92	10.92	68.2	-16.36	199	11	Peak
11020	46.34	30.18	16.16	54	-7.66	182	134	Average
11020	55.82	39.66	16.16	74	-18.18	182	134	Peak

Remarks:

- Emission Level = Read Level + Factor
Margin value = Emission level – Limit value
- 5510 MHz: Fundamental Frequency
- *: Out of Restricted Band
- The emission levels of other frequencies were very low against the limit

EUT Test Condition		Measurement Detail	
Channel	Channel 110	Frequency Range	1 GHz ~ 40 GHz
Input Power	120 Vac, 60 Hz	Detector Function	Peak (PK) Average (AV)
Environmental Conditions	25 deg. C, 65 % RH	Tested By	Charles Hsiao

Antenna Polarity & Test Distance: Horizontal at 3 m								
Frequency (MHz)	Emission Level (dBuV/m)	Read Level (dBuV)	Factor (dB/m)	Limit (dBuV/m)	Margin (dB)	Antenna Height (cm)	Table Angle (Degree)	Remark
5460	53.58	43.07	10.51	54	-0.42	207	301	Average
5460	62.99	52.48	10.51	74	-11.01	207	301	Peak
*5470	66.76	56.23	10.53	68.2	-1.44	207	301	Peak
5550	108.57	97.89	10.68			206	301	Average
5550	115.36	104.68	10.68			206	301	Peak
*5725	57.27	46.35	10.92	68.2	-10.93	206	301	Peak
11100	46.35	30.08	16.27	54	-7.65	125	137	Average
11100	55.9	39.63	16.27	74	-18.1	125	137	Peak

Antenna Polarity & Test Distance: Vertical at 3 m								
Frequency (MHz)	Emission Level (dBuV/m)	Read Level (dBuV)	Factor (dB/m)	Limit (dBuV/m)	Margin (dB)	Antenna Height (cm)	Table Angle (Degree)	Remark
5460	46.01	35.5	10.51	54	-7.99	216	3	Average
5460	56.53	46.02	10.51	74	-17.47	216	3	Peak
*5470	55.77	45.24	10.53	68.2	-12.43	216	3	Peak
5550	102.36	91.68	10.68			216	3	Average
5550	109.22	98.54	10.68			216	3	Peak
*5725	52.57	41.65	10.92	68.2	-15.63	216	3	Peak
11100	45.61	29.34	16.27	54	-8.39	105	83	Average
11100	55.18	38.91	16.27	74	-18.82	105	83	Peak

Remarks:

- Emission Level = Read Level + Factor
Margin value = Emission level – Limit value
- 5550 MHz: Fundamental Frequency
- *: Out of Restricted Band
- The emission levels of other frequencies were very low against the limit

EUT Test Condition		Measurement Detail	
Channel	Channel 134	Frequency Range	1 GHz ~ 40 GHz
Input Power	120 Vac, 60 Hz	Detector Function	Peak (PK) Average (AV)
Environmental Conditions	25 deg. C, 65 % RH	Tested By	Charles Hsiao

Antenna Polarity & Test Distance: Horizontal at 3 m								
Frequency (MHz)	Emission Level (dBuV/m)	Read Level (dBuV)	Factor (dB/m)	Limit (dBuV/m)	Margin (dB)	Antenna Height (cm)	Table Angle (Degree)	Remark
5460	45.3	34.79	10.51	54	-8.7	206	301	Average
5460	55.79	45.28	10.51	74	-18.21	206	301	Peak
*5470	53.59	43.06	10.53	68.2	-14.61	206	301	Peak
5670	106.65	95.75	10.9			206	301	Average
5670	113.05	102.15	10.9			206	301	Peak
*5725	68.05	57.13	10.92	68.2	-0.15	214	301	Peak
11340	45.94	29.52	16.42	54	-8.06	128	336	Average
11340	55.63	39.21	16.42	74	-18.37	128	336	Peak

Antenna Polarity & Test Distance: Vertical at 3 m								
Frequency (MHz)	Emission Level (dBuV/m)	Read Level (dBuV)	Factor (dB/m)	Limit (dBuV/m)	Margin (dB)	Antenna Height (cm)	Table Angle (Degree)	Remark
5460	43.07	32.56	10.51	54	-10.93	202	2	Average
5460	54.13	43.62	10.51	74	-19.87	202	2	Peak
*5470	51.33	40.8	10.53	68.2	-16.87	202	2	Peak
5670	99.62	88.72	10.9			202	2	Average
5670	106.6	95.7	10.9			202	2	Peak
*5725	60.1	49.18	10.92	68.2	-8.1	202	2	Peak
11340	47.46	31.04	16.42	54	-6.54	151	23	Average
11340	57.1	40.68	16.42	74	-16.9	151	23	Peak

Remarks:

- Emission Level = Read Level + Factor
Margin value = Emission level – Limit value
- 5670 MHz: Fundamental Frequency
- *: Out of Restricted Band
- The emission levels of other frequencies were very low against the limit

802.11ax (HE80)

EUT Test Condition		Measurement Detail	
Channel	Channel 58	Frequency Range	1 GHz ~ 40 GHz
Input Power	120 Vac, 60 Hz	Detector Function	Peak (PK) Average (AV)
Environmental Conditions	25 deg. C, 65 % RH	Tested By	Charles Hsiao

Antenna Polarity & Test Distance: Horizontal at 3 m

Frequency (MHz)	Emission Level (dBuV/m)	Read Level (dBuV)	Factor (dB/m)	Limit (dBuV/m)	Margin (dB)	Antenna Height (cm)	Table Angle (Degree)	Remark
5150	43.55	33.5	10.05	54	-10.45	200	356	Average
5150	54.46	44.41	10.05	74	-19.54	200	356	Peak
5290	95.82	85.72	10.1			200	356	Average
5290	102.6	92.5	10.1			200	356	Peak
5350	53.49	43.26	10.23	54	-0.51	202	344	Average
5350	62.16	51.93	10.23	74	-11.84	202	344	Peak
*10580	54.18	38.47	15.71	68.2	-14.02	164	131	Peak

Antenna Polarity & Test Distance: Vertical at 3 m

Frequency (MHz)	Emission Level (dBuV/m)	Read Level (dBuV)	Factor (dB/m)	Limit (dBuV/m)	Margin (dB)	Antenna Height (cm)	Table Angle (Degree)	Remark
5150	42.73	32.68	10.05	54	-11.27	224	24	Average
5150	53.15	43.1	10.05	74	-20.85	224	24	Peak
5290	89.76	79.66	10.1			224	24	Average
5290	96.92	86.82	10.1			224	24	Peak
5350	47.06	36.83	10.23	54	-6.94	224	24	Average
5350	57.15	46.92	10.23	74	-16.85	224	24	Peak
*10580	55.03	39.32	15.71	68.2	-13.17	125	267	Peak

Remarks:

- Emission Level = Read Level + Factor
Margin value = Emission level – Limit value
- 5290 MHz: Fundamental Frequency
- *: Out of Restricted Band
- The emission levels of other frequencies were very low against the limit

EUT Test Condition		Measurement Detail	
Channel	Channel 106	Frequency Range	1 GHz ~ 40 GHz
Input Power	120 Vac, 60 Hz	Detector Function	Peak (PK) Average (AV)
Environmental Conditions	25 deg. C, 65 % RH	Tested By	Charles Hsiao

Antenna Polarity & Test Distance: Horizontal at 3 m								
Frequency (MHz)	Emission Level (dBuV/m)	Read Level (dBuV)	Factor (dB/m)	Limit (dBuV/m)	Margin (dB)	Antenna Height (cm)	Table Angle (Degree)	Remark
5460	53.68	43.17	10.51	54	-0.32	219	304	Average
5460	61.25	50.74	10.51	74	-12.75	219	304	Peak
*5470	65.37	54.84	10.53	68.2	-2.83	219	304	Peak
5530	98.56	87.93	10.63			206	304	Average
5530	105.82	95.19	10.63			206	304	Peak
*5725	53.17	42.25	10.92	68.2	-15.03	206	304	Peak
11060	45.88	29.65	16.23	54	-8.12	182	206	Average
11060	55.53	39.3	16.23	74	-18.47	182	206	Peak

Antenna Polarity & Test Distance: Vertical at 3 m								
Frequency (MHz)	Emission Level (dBuV/m)	Read Level (dBuV)	Factor (dB/m)	Limit (dBuV/m)	Margin (dB)	Antenna Height (cm)	Table Angle (Degree)	Remark
5460	47.71	37.2	10.51	54	-6.29	202	2	Average
5460	55.25	44.74	10.51	74	-18.75	202	2	Peak
*5470	54.04	43.51	10.53	68.2	-14.16	202	2	Peak
5530	92.71	82.08	10.63			202	2	Average
5530	99.61	88.98	10.63			202	2	Peak
*5725	52.27	41.35	10.92	68.2	-15.93	202	2	Peak
11060	46.39	30.16	16.23	54	-7.61	147	124	Average
11060	55.99	39.76	16.23	74	-18.01	147	124	Peak

Remarks:

- Emission Level = Read Level + Factor
Margin value = Emission level – Limit value
- 5530 MHz: Fundamental Frequency
- *: Out of Restricted Band
- The emission levels of other frequencies were very low against the limit

EUT Test Condition		Measurement Detail	
Channel	Channel 122	Frequency Range	1 GHz ~ 40 GHz
Input Power	120 Vac, 60 Hz	Detector Function	Peak (PK) Average (AV)
Environmental Conditions	25 deg. C, 65 % RH	Tested By	Charles Hsiao

Antenna Polarity & Test Distance: Horizontal at 3 m								
Frequency (MHz)	Emission Level (dBuV/m)	Read Level (dBuV)	Factor (dB/m)	Limit (dBuV/m)	Margin (dB)	Antenna Height (cm)	Table Angle (Degree)	Remark
5460	51.83	41.32	10.51	54	-2.17	218	301	Average
5460	62.66	52.15	10.51	74	-11.34	218	301	Peak
*5470	63.82	53.29	10.53	68.2	-4.38	218	301	Peak
5610	103.33	92.56	10.77			206	301	Average
5610	110.19	99.42	10.77			206	301	Peak
*5725	68.08	57.16	10.92	68.2	-0.12	218	301	Peak
11220	47.02	30.6	16.42	54	-6.98	138	294	Average
11220	56.66	40.24	16.42	74	-17.34	138	294	Peak

Antenna Polarity & Test Distance: Vertical at 3 m								
Frequency (MHz)	Emission Level (dBuV/m)	Read Level (dBuV)	Factor (dB/m)	Limit (dBuV/m)	Margin (dB)	Antenna Height (cm)	Table Angle (Degree)	Remark
5460	44.94	34.43	10.51	54	-9.06	220	2	Average
5460	56.47	45.96	10.51	74	-17.53	220	2	Peak
*5470	53.37	42.84	10.53	68.2	-14.83	220	2	Peak
5610	97.66	86.89	10.77			220	2	Average
5610	104.72	93.95	10.77			220	2	Peak
*5725	65.07	54.15	10.92	68.2	-3.13	220	2	Peak
11220	46.89	30.47	16.42	54	-7.11	155	84	Average
11220	56.47	40.05	16.42	74	-17.53	155	84	Peak

Remarks:

- Emission Level = Read Level + Factor
Margin value = Emission level – Limit value
- 5610 MHz: Fundamental Frequency
- *: Out of Restricted Band
- The emission levels of other frequencies were very low against the limit

Mode B
802.11a

EUT Test Condition		Measurement Detail	
Channel	Channel 52	Frequency Range	1 GHz ~ 40 GHz
Input Power	120 Vac, 60 Hz	Detector Function	Peak (PK) Average (AV)
Environmental Conditions	25 deg. C, 65 % RH	Tested By	Charles Hsiao

Antenna Polarity & Test Distance: Horizontal at 3 m								
Frequency (MHz)	Emission Level (dBuV/m)	Read Level (dBuV)	Factor (dB/m)	Limit (dBuV/m)	Margin (dB)	Antenna Height (cm)	Table Angle (Degree)	Remark
5150	44.61	34.56	10.05	54	-9.39	263	339	Average
5150	56.34	46.29	10.05	74	-17.66	263	339	Peak
5260	100.57	90.45	10.12			263	339	Average
5260	107.06	96.94	10.12			263	339	Peak
*10520	52.9	37.02	15.88	68.2	-15.3	15	216	Peak
Antenna Polarity & Test Distance: Vertical at 3 m								
Frequency (MHz)	Emission Level (dBuV/m)	Read Level (dBuV)	Factor (dB/m)	Limit (dBuV/m)	Margin (dB)	Antenna Height (cm)	Table Angle (Degree)	Remark
5150	44.32	34.27	10.05	54	-9.68	130	5	Average
5150	57.09	47.04	10.05	74	-16.91	130	5	Peak
5260	101.24	91.12	10.12			130	5	Average
5260	108.47	98.35	10.12			130	5	Peak
*10520	52.91	37.03	15.88	68.2	-15.29	157	77	Peak

Remarks:

- Emission Level = Read Level + Factor
Margin value = Emission level – Limit value
- 5260 MHz: Fundamental Frequency
- *: Out of Restricted Band
- The emission levels of other frequencies were very low against the limit

EUT Test Condition		Measurement Detail	
Channel	Channel 60	Frequency Range	1 GHz ~ 40 GHz
Input Power	120 Vac, 60 Hz	Detector Function	Peak (PK) Average (AV)
Environmental Conditions	25 deg. C, 65 % RH	Tested By	Karl Lee

Antenna Polarity & Test Distance: Horizontal at 3 m								
Frequency (MHz)	Emission Level (dBuV/m)	Read Level (dBuV)	Factor (dB/m)	Limit (dBuV/m)	Margin (dB)	Antenna Height (cm)	Table Angle (Degree)	Remark
5150	43.44	33.39	10.05	54	-10.56	263	339	Average
5150	53.05	43	10.05	74	-20.95	263	339	Peak
5300	100.46	90.4	10.06			263	339	Average
5300	106.14	96.08	10.06			263	339	Peak
5350	50.87	40.64	10.23	54	-3.13	263	339	Average
5350	62.47	52.24	10.23	74	-11.53	263	339	Peak
10600	47.15	31.39	15.76	54	-6.85	130	326	Average
10600	50.13	34.37	15.76	74	-23.87	130	326	Peak

Antenna Polarity & Test Distance: Vertical at 3 m								
Frequency (MHz)	Emission Level (dBuV/m)	Read Level (dBuV)	Factor (dB/m)	Limit (dBuV/m)	Margin (dB)	Antenna Height (cm)	Table Angle (Degree)	Remark
5150	43.16	33.11	10.05	54	-10.84	130	5	Average
5150	52.89	42.84	10.05	74	-21.11	130	5	Peak
5300	102.09	92.03	10.06			130	5	Average
5300	107.99	97.93	10.06			130	5	Peak
5350	52.91	42.68	10.23	54	-1.09	130	5	Average
5350	64.08	53.85	10.23	74	-9.92	130	5	Peak
10600	47.01	31.25	15.76	54	-6.99	156	33	Average
10600	51.36	35.6	15.76	74	-22.64	156	33	Peak

Remarks:

- Emission Level = Read Level + Factor
Margin value = Emission level – Limit value
- 5300 MHz: Fundamental Frequency
- *: Out of Restricted Band
- The emission levels of other frequencies were very low against the limit

EUT Test Condition		Measurement Detail	
Channel	Channel 64	Frequency Range	1 GHz ~ 40 GHz
Input Power	120 Vac, 60 Hz	Detector Function	Peak (PK) Average (AV)
Environmental Conditions	25 deg. C, 65 % RH	Tested By	Karl Lee

Antenna Polarity & Test Distance: Horizontal at 3 m								
Frequency (MHz)	Emission Level (dBuV/m)	Read Level (dBuV)	Factor (dB/m)	Limit (dBuV/m)	Margin (dB)	Antenna Height (cm)	Table Angle (Degree)	Remark
5320	98.64	88.55	10.09			255	339	Average
5320	103.91	93.82	10.09			255	339	Peak
5350	51.49	41.26	10.23	54	-2.51	255	339	Average
5350	68.33	58.1	10.23	74	-5.67	255	339	Peak
10640	47.4	31.41	15.99	54	-6.6	136	330	Average
10640	51.87	35.88	15.99	74	-22.13	136	330	Peak
Antenna Polarity & Test Distance: Vertical at 3 m								
Frequency (MHz)	Emission Level (dBuV/m)	Read Level (dBuV)	Factor (dB/m)	Limit (dBuV/m)	Margin (dB)	Antenna Height (cm)	Table Angle (Degree)	Remark
5320	99.99	89.9	10.09			144	5	Average
5320	105.64	95.55	10.09			144	5	Peak
5350	52.92	42.69	10.23	54	-1.08	144	5	Average
5350	70.38	60.15	10.23	74	-3.62	144	5	Peak
10640	47.41	31.42	15.99	54	-6.59	125	247	Average
10640	50.55	34.56	15.99	74	-23.45	125	247	Peak

Remarks:

- Emission Level = Read Level + Factor
Margin value = Emission level – Limit value
- 5320 MHz: Fundamental Frequency
- *: Out of Restricted Band
- The emission levels of other frequencies were very low against the limit

EUT Test Condition		Measurement Detail	
Channel	Channel 100	Frequency Range	1 GHz ~ 40 GHz
Input Power	120 Vac, 60 Hz	Detector Function	Peak (PK) Average (AV)
Environmental Conditions	25 deg. C, 65 % RH	Tested By	Charles Hsiao

Antenna Polarity & Test Distance: Horizontal at 3 m								
Frequency (MHz)	Emission Level (dBuV/m)	Read Level (dBuV)	Factor (dB/m)	Limit (dBuV/m)	Margin (dB)	Antenna Height (cm)	Table Angle (Degree)	Remark
5460	48.05	37.54	10.51	54	-5.95	200	43	Average
5460	64.25	53.74	10.51	74	-9.75	200	43	Peak
*5470	67.43	56.9	10.53	68.2	-0.77	200	43	Peak
5500	99.68	89.08	10.6			200	43	Average
5500	106.36	95.76	10.6			200	43	Peak
11000	47.45	31.32	16.13	54	-6.55	126	150	Average
11000	57.11	40.98	16.13	74	-16.89	126	150	Peak

Antenna Polarity & Test Distance: Vertical at 3 m								
Frequency (MHz)	Emission Level (dBuV/m)	Read Level (dBuV)	Factor (dB/m)	Limit (dBuV/m)	Margin (dB)	Antenna Height (cm)	Table Angle (Degree)	Remark
5460	43.93	33.42	10.51	54	-10.07	200	12	Average
5460	61.83	51.32	10.51	74	-12.17	200	12	Peak
*5470	59.51	48.98	10.53	68.2	-8.69	200	12	Peak
5500	96.56	85.96	10.6			200	12	Average
5500	103.38	92.78	10.6			200	12	Peak
11000	46.92	30.79	16.13	54	-7.08	116	183	Average
11000	56.55	40.42	16.13	74	-17.45	116	183	Peak

Remarks:

- Emission Level = Read Level + Factor
Margin value = Emission level – Limit value
- 5500 MHz: Fundamental Frequency
- *: Out of Restricted Band
- The emission levels of other frequencies were very low against the limit

EUT Test Condition		Measurement Detail	
Channel	Channel 116	Frequency Range	1 GHz ~ 40 GHz
Input Power	120 Vac, 60 Hz	Detector Function	Peak (PK) Average (AV)
Environmental Conditions	25 deg. C, 65 % RH	Tested By	Charles Hsiao

Antenna Polarity & Test Distance: Horizontal at 3 m								
Frequency (MHz)	Emission Level (dBuV/m)	Read Level (dBuV)	Factor (dB/m)	Limit (dBuV/m)	Margin (dB)	Antenna Height (cm)	Table Angle (Degree)	Remark
5460	46.72	36.21	10.51	54	-7.28	200	43	Average
5460	58.56	48.05	10.51	74	-15.44	200	43	Peak
*5470	58.05	47.52	10.53	68.2	-10.15	200	43	Peak
5580	103.6	92.89	10.71			200	43	Average
5580	110.61	99.9	10.71			200	43	Peak
*5725	54.93	44.01	10.92	68.2	-13.27	200	43	Peak
11160	47.74	31.38	16.36	54	-6.26	163	206	Average
11160	57.33	40.97	16.36	74	-16.67	163	206	Peak

Antenna Polarity & Test Distance: Vertical at 3 m								
Frequency (MHz)	Emission Level (dBuV/m)	Read Level (dBuV)	Factor (dB/m)	Limit (dBuV/m)	Margin (dB)	Antenna Height (cm)	Table Angle (Degree)	Remark
5460	44.86	34.35	10.51	54	-9.14	200	12	Average
5460	56.78	46.27	10.51	74	-17.22	200	12	Peak
*5470	57.07	46.54	10.53	68.2	-11.13	200	12	Peak
5580	99.84	89.13	10.71			200	12	Average
5580	106.79	96.08	10.71			200	12	Peak
*5725	53.48	42.56	10.92	68.2	-14.72	200	12	Peak
11160	47.14	30.78	16.36	54	-6.86	154	101	Average
11160	56.81	40.45	16.36	74	-17.19	154	101	Peak

Remarks:

- Emission Level = Read Level + Factor
Margin value = Emission level – Limit value
- 5580 MHz: Fundamental Frequency
- *: Out of Restricted Band
- The emission levels of other frequencies were very low against the limit

EUT Test Condition		Measurement Detail	
Channel	Channel 140	Frequency Range	1 GHz ~ 40 GHz
Input Power	120 Vac, 60 Hz	Detector Function	Peak (PK) Average (AV)
Environmental Conditions	25 deg. C, 65 % RH	Tested By	Charles Hsiao

Antenna Polarity & Test Distance: Horizontal at 3 m								
Frequency (MHz)	Emission Level (dBuV/m)	Read Level (dBuV)	Factor (dB/m)	Limit (dBuV/m)	Margin (dB)	Antenna Height (cm)	Table Angle (Degree)	Remark
5700	99.74	88.79	10.95			200	43	Average
5700	106.35	95.4	10.95			200	43	Peak
*5725	67.85	56.93	10.92	68.2	-0.35	200	43	Peak
11400	47.06	30.87	16.19	54	-6.94	182	13	Average
11400	56.63	40.44	16.19	74	-17.37	182	13	Peak
Antenna Polarity & Test Distance: Vertical at 3 m								
Frequency (MHz)	Emission Level (dBuV/m)	Read Level (dBuV)	Factor (dB/m)	Limit (dBuV/m)	Margin (dB)	Antenna Height (cm)	Table Angle (Degree)	Remark
5700	96.14	85.19	10.95			200	10	Average
5700	103	92.05	10.95			200	10	Peak
*5725	63.95	53.03	10.92	68.2	-4.25	200	10	Peak
11400	47.25	31.06	16.19	54	-6.75	104	121	Average
11400	56.91	40.72	16.19	74	-17.09	104	121	Peak

Remarks:

- Emission Level = Read Level + Factor
Margin value = Emission level – Limit value
- 5700 MHz: Fundamental Frequency
- *: Out of Restricted Band
- The emission levels of other frequencies were very low against the limit

802.11ax (HE20)

EUT Test Condition		Measurement Detail	
Channel	Channel 52	Frequency Range	1 GHz ~ 40 GHz
Input Power	120 Vac, 60 Hz	Detector Function	Peak (PK) Average (AV)
Environmental Conditions	25 deg. C, 65 % RH	Tested By	Charles Hsiao

Antenna Polarity & Test Distance: Horizontal at 3 m

Frequency (MHz)	Emission Level (dBuV/m)	Read Level (dBuV)	Factor (dB/m)	Limit (dBuV/m)	Margin (dB)	Antenna Height (cm)	Table Angle (Degree)	Remark
5150	45.94	35.89	10.05	54	-8.06	263	339	Average
5150	57.52	47.47	10.05	74	-16.48	263	339	Peak
5260	100.14	90.02	10.12			263	339	Average
5260	107.15	97.03	10.12			263	339	Peak
*10520	51.39	35.51	15.88	68.2	-16.81	185	222	Peak

Antenna Polarity & Test Distance: Vertical at 3 m

Frequency (MHz)	Emission Level (dBuV/m)	Read Level (dBuV)	Factor (dB/m)	Limit (dBuV/m)	Margin (dB)	Antenna Height (cm)	Table Angle (Degree)	Remark
5150	45.46	35.41	10.05	54	-8.54	130	5	Average
5150	56.92	46.87	10.05	74	-17.08	130	5	Peak
5260	101.62	91.5	10.12			130	5	Average
5260	108.85	98.73	10.12			130	5	Peak
*10520	51.33	35.45	15.88	68.2	-16.87	123	2	Peak

Remarks:

- Emission Level = Read Level + Factor
Margin value = Emission level – Limit value
- 5260 MHz: Fundamental Frequency
- *: Out of Restricted Band
- The emission levels of other frequencies were very low against the limit

EUT Test Condition		Measurement Detail	
Channel	Channel 60	Frequency Range	1 GHz ~ 40 GHz
Input Power	120 Vac, 60 Hz	Detector Function	Peak (PK) Average (AV)
Environmental Conditions	25 deg. C, 65 % RH	Tested By	Karl Lee

Antenna Polarity & Test Distance: Horizontal at 3 m								
Frequency (MHz)	Emission Level (dBuV/m)	Read Level (dBuV)	Factor (dB/m)	Limit (dBuV/m)	Margin (dB)	Antenna Height (cm)	Table Angle (Degree)	Remark
5150	43.66	33.61	10.05	54	-10.34	227	339	Average
5150	53.24	43.19	10.05	74	-20.76	227	339	Peak
5300	100.11	90.05	10.06			227	339	Average
5300	107.42	97.36	10.06			227	339	Peak
5350	51.55	41.32	10.23	54	-2.45	227	339	Average
5350	62.97	52.74	10.23	74	-11.03	227	339	Peak
10600	47.17	31.41	15.76	54	-6.83	152	282	Average
10600	50.65	34.89	15.76	74	-23.35	152	282	Peak

Antenna Polarity & Test Distance: Vertical at 3 m								
Frequency (MHz)	Emission Level (dBuV/m)	Read Level (dBuV)	Factor (dB/m)	Limit (dBuV/m)	Margin (dB)	Antenna Height (cm)	Table Angle (Degree)	Remark
5150	43.21	33.16	10.05	54	-10.79	130	5	Average
5150	53.19	43.14	10.05	74	-20.81	130	5	Peak
5300	101.28	91.22	10.06			130	5	Average
5300	108.44	98.38	10.06			130	5	Peak
5350	53.96	43.73	10.23	54	-0.04	130	5	Average
5350	64.83	54.6	10.23	74	-9.17	130	5	Peak
10600	47.2	31.44	15.76	54	-6.8	185	54	Average
10600	50.52	34.76	15.76	74	-23.48	185	54	Peak

Remarks:

- Emission Level = Read Level + Factor
Margin value = Emission level – Limit value
- 5300 MHz: Fundamental Frequency
- *: Out of Restricted Band
- The emission levels of other frequencies were very low against the limit

EUT Test Condition		Measurement Detail	
Channel	Channel 64	Frequency Range	1 GHz ~ 40 GHz
Input Power	120 Vac, 60 Hz	Detector Function	Peak (PK) Average (AV)
Environmental Conditions	25 deg. C, 65 % RH	Tested By	Karl Lee

Antenna Polarity & Test Distance: Horizontal at 3 m								
Frequency (MHz)	Emission Level (dBuV/m)	Read Level (dBuV)	Factor (dB/m)	Limit (dBuV/m)	Margin (dB)	Antenna Height (cm)	Table Angle (Degree)	Remark
5320	97.22	87.13	10.09			255	339	Average
5320	105.28	95.19	10.09			255	339	Peak
5350	51.96	41.73	10.23	54	-2.04	255	339	Average
5350	67.69	57.46	10.23	74	-6.31	255	339	Peak
10640	47.42	31.43	15.99	54	-6.58	126	321	Average
10640	51.28	35.29	15.99	74	-22.72	126	321	Peak
Antenna Polarity & Test Distance: Vertical at 3 m								
Frequency (MHz)	Emission Level (dBuV/m)	Read Level (dBuV)	Factor (dB/m)	Limit (dBuV/m)	Margin (dB)	Antenna Height (cm)	Table Angle (Degree)	Remark
5320	98.57	88.48	10.09			144	5	Average
5320	107.19	97.1	10.09			144	5	Peak
5350	53.04	42.81	10.23	54	-0.96	144	5	Average
5350	68.87	58.64	10.23	74	-5.13	144	5	Peak
10640	47.44	31.45	15.99	54	-6.56	158	5	Average
10640	51.35	35.36	15.99	74	-22.65	158	5	Peak

Remarks:

5. Emission Level = Read Level + Factor
Margin value = Emission level – Limit value
6. 5320 MHz: Fundamental Frequency
7. *: Out of Restricted Band
8. The emission levels of other frequencies were very low against the limit

EUT Test Condition		Measurement Detail	
Channel	Channel 100	Frequency Range	1 GHz ~ 40 GHz
Input Power	120 Vac, 60 Hz	Detector Function	Peak (PK) Average (AV)
Environmental Conditions	25 deg. C, 65 % RH	Tested By	Charles Hsiao

Antenna Polarity & Test Distance: Horizontal at 3 m								
Frequency (MHz)	Emission Level (dBuV/m)	Read Level (dBuV)	Factor (dB/m)	Limit (dBuV/m)	Margin (dB)	Antenna Height (cm)	Table Angle (Degree)	Remark
5460	50.3	39.79	10.51	54	-3.7	200	43	Average
5460	65.53	55.02	10.51	74	-8.47	200	43	Peak
*5470	67.51	56.98	10.53	68.2	-0.69	200	43	Peak
5500	100.37	89.77	10.6			200	43	Average
5500	107.87	97.27	10.6			200	43	Peak
11000	46.12	29.99	16.13	54	-7.88	115	97	Average
11000	55.78	39.65	16.13	74	-18.22	115	97	Peak
Antenna Polarity & Test Distance: Vertical at 3 m								
Frequency (MHz)	Emission Level (dBuV/m)	Read Level (dBuV)	Factor (dB/m)	Limit (dBuV/m)	Margin (dB)	Antenna Height (cm)	Table Angle (Degree)	Remark
5460	45.69	35.18	10.51	54	-8.31	200	12	Average
5460	62.08	51.57	10.51	74	-11.92	200	12	Peak
*5470	63.17	52.64	10.53	68.2	-5.03	200	12	Peak
5500	97.84	87.24	10.6			200	12	Average
5500	104.47	93.87	10.6			200	12	Peak
11000	47.84	31.71	16.13	54	-6.16	129	135	Average
11000	57.43	41.3	16.13	74	-16.57	129	135	Peak

Remarks:

- Emission Level = Read Level + Factor
Margin value = Emission level – Limit value
- 5500 MHz: Fundamental Frequency
- *: Out of Restricted Band
- The emission levels of other frequencies were very low against the limit

EUT Test Condition		Measurement Detail	
Channel	Channel 116	Frequency Range	1 GHz ~ 40 GHz
Input Power	120 Vac, 60 Hz	Detector Function	Peak (PK) Average (AV)
Environmental Conditions	25 deg. C, 65 % RH	Tested By	Charles Hsiao

Antenna Polarity & Test Distance: Horizontal at 3 m								
Frequency (MHz)	Emission Level (dBuV/m)	Read Level (dBuV)	Factor (dB/m)	Limit (dBuV/m)	Margin (dB)	Antenna Height (cm)	Table Angle (Degree)	Remark
5460	47.68	37.17	10.51	54	-6.32	200	43	Average
5460	58.65	48.14	10.51	74	-15.35	200	43	Peak
*5470	59.28	48.75	10.53	68.2	-8.92	200	43	Peak
5580	104.57	93.86	10.71			200	43	Average
5580	111.8	101.09	10.71			200	43	Peak
*5725	56.22	45.3	10.92	68.2	-11.98	200	43	Peak
11160	47.76	31.4	16.36	54	-6.24	122	252	Average
11160	56.89	40.53	16.36	74	-17.11	122	252	Peak

Antenna Polarity & Test Distance: Vertical at 3 m								
Frequency (MHz)	Emission Level (dBuV/m)	Read Level (dBuV)	Factor (dB/m)	Limit (dBuV/m)	Margin (dB)	Antenna Height (cm)	Table Angle (Degree)	Remark
5460	45.74	35.23	10.51	54	-8.26	200	12	Average
5460	56.53	46.02	10.51	74	-17.47	200	12	Peak
*5470	56.34	45.81	10.53	68.2	-11.86	200	12	Peak
5580	100.34	89.63	10.71			200	12	Average
5580	107	96.29	10.71			200	12	Peak
*5725	53.69	42.77	10.92	68.2	-14.51	200	12	Peak
11160	47.75	31.39	16.36	54	-6.25	124	216	Average
11160	57.57	41.21	16.36	74	-16.43	124	216	Peak

Remarks:

- Emission Level = Read Level + Factor
Margin value = Emission level – Limit value
- 5580 MHz: Fundamental Frequency
- *: Out of Restricted Band
- The emission levels of other frequencies were very low against the limit

EUT Test Condition		Measurement Detail	
Channel	Channel 140	Frequency Range	1 GHz ~ 40 GHz
Input Power	120 Vac, 60 Hz	Detector Function	Peak (PK) Average (AV)
Environmental Conditions	25 deg. C, 65 % RH	Tested By	Charles Hsiao

Antenna Polarity & Test Distance: Horizontal at 3 m								
Frequency (MHz)	Emission Level (dBuV/m)	Read Level (dBuV)	Factor (dB/m)	Limit (dBuV/m)	Margin (dB)	Antenna Height (cm)	Table Angle (Degree)	Remark
5700	99.74	88.79	10.95			200	43	Average
5700	106.17	95.22	10.95			200	43	Peak
*5725	67.96	57.04	10.92	68.2	-0.24	200	43	Peak
11400	47.64	31.45	16.19	54	-6.36	187	77	Average
11400	57.45	41.26	16.19	74	-16.55	187	77	Peak
Antenna Polarity & Test Distance: Vertical at 3 m								
Frequency (MHz)	Emission Level (dBuV/m)	Read Level (dBuV)	Factor (dB/m)	Limit (dBuV/m)	Margin (dB)	Antenna Height (cm)	Table Angle (Degree)	Remark
5700	95.42	84.47	10.95			200	2	Average
5700	102.77	91.82	10.95			200	2	Peak
*5725	64.81	53.89	10.92	68.2	-3.39	200	2	Peak
11400	47.47	31.28	16.19	54	-6.53	122	255	Average
11400	57.5	41.31	16.19	74	-16.5	122	255	Peak

Remarks:

- Emission Level = Read Level + Factor
Margin value = Emission level – Limit value
- 5700 MHz: Fundamental Frequency
- *: Out of Restricted Band
- The emission levels of other frequencies were very low against the limit

802.11ax (HE40)

EUT Test Condition		Measurement Detail	
Channel	Channel 54	Frequency Range	1 GHz ~ 40 GHz
Input Power	120 Vac, 60 Hz	Detector Function	Peak (PK) Average (AV)
Environmental Conditions	25 deg. C, 65 % RH	Tested By	Charles Hsiao

Antenna Polarity & Test Distance: Horizontal at 3 m								
Frequency (MHz)	Emission Level (dBuV/m)	Read Level (dBuV)	Factor (dB/m)	Limit (dBuV/m)	Margin (dB)	Antenna Height (cm)	Table Angle (Degree)	Remark
5150	46.09	36.04	10.05	54	-7.91	263	339	Average
5150	57.68	47.63	10.05	74	-16.32	263	339	Peak
5270	97.44	87.32	10.12			263	339	Average
5270	104.18	94.06	10.12			263	339	Peak
5350	50.31	40.08	10.23	54	-3.69	263	339	Average
5350	62.03	51.8	10.23	74	-11.97	263	339	Peak
*10540	51.74	35.91	15.83	68.2	-16.46	118	246	Peak

Antenna Polarity & Test Distance: Vertical at 3 m								
Frequency (MHz)	Emission Level (dBuV/m)	Read Level (dBuV)	Factor (dB/m)	Limit (dBuV/m)	Margin (dB)	Antenna Height (cm)	Table Angle (Degree)	Remark
5150	45.66	35.61	10.05	54	-8.34	130	5	Average
5150	57.17	47.12	10.05	74	-16.83	130	5	Peak
5270	98.67	88.55	10.12			130	5	Average
5270	105.54	95.42	10.12			130	5	Peak
5350	53.47	43.24	10.23	54	-0.53	130	5	Average
5350	62.61	52.38	10.23	74	-11.39	130	5	Peak
*10540	51.2	35.37	15.83	68.2	-17	154	274	Peak

Remarks:

- Emission Level = Read Level + Factor
Margin value = Emission level – Limit value
- 5270 MHz: Fundamental Frequency
- *: Out of Restricted Band
- The emission levels of other frequencies were very low against the limit

EUT Test Condition		Measurement Detail	
Channel	Channel 62	Frequency Range	1 GHz ~ 40 GHz
Input Power	120 Vac, 60 Hz	Detector Function	Peak (PK) Average (AV)
Environmental Conditions	25 deg. C, 65 % RH	Tested By	Karl Lee

Antenna Polarity & Test Distance: Horizontal at 3 m								
Frequency (MHz)	Emission Level (dBuV/m)	Read Level (dBuV)	Factor (dB/m)	Limit (dBuV/m)	Margin (dB)	Antenna Height (cm)	Table Angle (Degree)	Remark
5150	43.18	33.13	10.05	54	-10.82	255	339	Average
5150	52.45	42.4	10.05	74	-21.55	255	339	Peak
5310	92.09	82	10.09			255	339	Average
5310	99.98	89.89	10.09			255	339	Peak
5350	52.7	42.47	10.23	54	-1.3	255	339	Average
5350	64.26	54.03	10.23	74	-9.74	255	339	Peak
10620	47.51	31.63	15.88	54	-6.49	195	55	Average
10620	50.9	35.02	15.88	74	-23.1	195	55	Peak

Antenna Polarity & Test Distance: Vertical at 3 m								
Frequency (MHz)	Emission Level (dBuV/m)	Read Level (dBuV)	Factor (dB/m)	Limit (dBuV/m)	Margin (dB)	Antenna Height (cm)	Table Angle (Degree)	Remark
5150	42.74	32.69	10.05	54	-11.26	144	5	Average
5150	52.52	42.47	10.05	74	-21.48	144	5	Peak
5310	93.48	83.39	10.09			144	5	Average
5310	101.12	91.03	10.09			144	5	Peak
5350	53.68	43.45	10.23	54	-0.32	144	5	Average
5350	65.64	55.41	10.23	74	-8.36	144	5	Peak
10620	47.32	31.44	15.88	54	-6.68	127	119	Average
10620	51.06	35.18	15.88	74	-22.94	127	119	Peak

Remarks:

- Emission Level = Read Level + Factor
Margin value = Emission level – Limit value
- 5310 MHz: Fundamental Frequency
- *: Out of Restricted Band
- The emission levels of other frequencies were very low against the limit

EUT Test Condition		Measurement Detail	
Channel	Channel 102	Frequency Range	1 GHz ~ 40 GHz
Input Power	120 Vac, 60 Hz	Detector Function	Peak (PK) Average (AV)
Environmental Conditions	25 deg. C, 65 % RH	Tested By	Charles Hsiao

Antenna Polarity & Test Distance: Horizontal at 3 m								
Frequency (MHz)	Emission Level (dBuV/m)	Read Level (dBuV)	Factor (dB/m)	Limit (dBuV/m)	Margin (dB)	Antenna Height (cm)	Table Angle (Degree)	Remark
5460	49.24	38.73	10.51	54	-4.76	200	43	Average
5460	60.86	50.35	10.51	74	-13.14	200	43	Peak
*5470	67.16	56.63	10.53	68.2	-1.04	200	43	Peak
5510	96.59	85.99	10.6			200	43	Average
5510	103.63	93.03	10.6			200	43	Peak
*5725	51.73	40.81	10.92	68.2	-16.47	200	43	Peak
11020	47.4	31.24	16.16	54	-6.6	136	66	Average
11020	57.13	40.97	16.16	74	-16.87	136	66	Peak

Antenna Polarity & Test Distance: Vertical at 3 m								
Frequency (MHz)	Emission Level (dBuV/m)	Read Level (dBuV)	Factor (dB/m)	Limit (dBuV/m)	Margin (dB)	Antenna Height (cm)	Table Angle (Degree)	Remark
5460	44.73	34.22	10.51	54	-9.27	200	12	Average
5460	55.64	45.13	10.51	74	-18.36	200	12	Peak
*5470	62.35	51.82	10.53	68.2	-5.85	200	12	Peak
5510	92.39	81.79	10.6			200	12	Average
5510	99.03	88.43	10.6			200	12	Peak
*5725	51.26	40.34	10.92	68.2	-16.94	200	12	Peak
11020	47.69	31.53	16.16	54	-6.31	116	142	Average
11020	57.18	41.02	16.16	74	-16.82	116	142	Peak

Remarks:

- Emission Level = Read Level + Factor
Margin value = Emission level – Limit value
- 5510 MHz: Fundamental Frequency
- *: Out of Restricted Band
- The emission levels of other frequencies were very low against the limit

EUT Test Condition		Measurement Detail	
Channel	Channel 110	Frequency Range	1 GHz ~ 40 GHz
Input Power	120 Vac, 60 Hz	Detector Function	Peak (PK) Average (AV)
Environmental Conditions	25 deg. C, 65 % RH	Tested By	Karl Lee

Antenna Polarity & Test Distance: Horizontal at 3 m								
Frequency (MHz)	Emission Level (dBuV/m)	Read Level (dBuV)	Factor (dB/m)	Limit (dBuV/m)	Margin (dB)	Antenna Height (cm)	Table Angle (Degree)	Remark
5460	53.69	43.18	10.51	54	-0.31	178	32	Average
5460	63.99	53.48	10.51	74	-10.01	178	32	Peak
*5470	65.68	55.15	10.53	68.2	-2.52	178	32	Peak
5550	100.07	89.39	10.68			178	32	Average
5550	109.69	99.01	10.68			178	32	Peak
*5725	59.28	48.36	10.92	68.2	-8.92	178	32	Peak
11100	47.55	31.28	16.27	54	-6.45	118	152	Average
11100	56.12	39.85	16.27	74	-17.88	118	152	Peak

Antenna Polarity & Test Distance: Vertical at 3 m								
Frequency (MHz)	Emission Level (dBuV/m)	Read Level (dBuV)	Factor (dB/m)	Limit (dBuV/m)	Margin (dB)	Antenna Height (cm)	Table Angle (Degree)	Remark
5460	51.78	41.27	10.51	54	-2.22	200	15	Average
5460	61.69	51.18	10.51	74	-12.31	200	15	Peak
*5470	63.7	53.17	10.53	68.2	-4.5	200	15	Peak
5550	97	86.32	10.68			200	15	Average
5550	105.82	95.14	10.68			200	15	Peak
*5725	55.83	44.91	10.92	68.2	-12.37	200	15	Peak
11100	47.64	31.37	16.27	54	-6.36	136	66	Average
11100	55.78	39.51	16.27	74	-18.22	136	66	Peak

Remarks:

- Emission Level = Read Level + Factor
Margin value = Emission level – Limit value
- 5550 MHz: Fundamental Frequency
- *: Out of Restricted Band
- The emission levels of other frequencies were very low against the limit

EUT Test Condition		Measurement Detail	
Channel	Channel 134	Frequency Range	1 GHz ~ 40 GHz
Input Power	120 Vac, 60 Hz	Detector Function	Peak (PK) Average (AV)
Environmental Conditions	25 deg. C, 65 % RH	Tested By	Karl Lee

Antenna Polarity & Test Distance: Horizontal at 3 m								
Frequency (MHz)	Emission Level (dBuV/m)	Read Level (dBuV)	Factor (dB/m)	Limit (dBuV/m)	Margin (dB)	Antenna Height (cm)	Table Angle (Degree)	Remark
5460	44.47	33.96	10.51	54	-9.53	194	32	Average
5460	54.52	44.01	10.51	74	-19.48	194	32	Peak
*5470	53.09	42.56	10.53	68.2	-15.11	194	32	Peak
5670	99.45	88.55	10.9			194	32	Average
5670	108.05	97.15	10.9			194	32	Peak
*5725	67.97	57.05	10.92	68.2	-0.23	194	32	Peak
11340	47.68	31.26	16.42	54	-6.32	135	52	Average
11340	57.02	40.6	16.42	74	-16.98	135	52	Peak

Antenna Polarity & Test Distance: Vertical at 3 m								
Frequency (MHz)	Emission Level (dBuV/m)	Read Level (dBuV)	Factor (dB/m)	Limit (dBuV/m)	Margin (dB)	Antenna Height (cm)	Table Angle (Degree)	Remark
5460	44.15	33.64	10.51	54	-9.85	191	15	Average
5460	53.89	43.38	10.51	74	-20.11	191	15	Peak
*5470	53.92	43.39	10.53	68.2	-14.28	191	15	Peak
5670	94.79	83.89	10.9			191	15	Average
5670	103.89	92.99	10.9			191	15	Peak
*5725	60.97	50.05	10.92	68.2	-7.23	191	15	Peak
11340	47.88	31.46	16.42	54	-6.12	159	285	Average
11340	58.3	41.88	16.42	74	-15.7	159	285	Peak

Remarks:

- Emission Level = Read Level + Factor
Margin value = Emission level – Limit value
- 5670 MHz: Fundamental Frequency
- *: Out of Restricted Band
- The emission levels of other frequencies were very low against the limit

802.11ax (HE80)

EUT Test Condition		Measurement Detail	
Channel	Channel 58	Frequency Range	1 GHz ~ 40 GHz
Input Power	120 Vac, 60 Hz	Detector Function	Peak (PK) Average (AV)
Environmental Conditions	25 deg. C, 65 % RH	Tested By	Karl Lee

Antenna Polarity & Test Distance: Horizontal at 3 m								
Frequency (MHz)	Emission Level (dBuV/m)	Read Level (dBuV)	Factor (dB/m)	Limit (dBuV/m)	Margin (dB)	Antenna Height (cm)	Table Angle (Degree)	Remark
5150	44	33.95	10.05	54	-10	227	348	Average
5150	53.31	43.26	10.05	74	-20.69	227	348	Peak
5290	88.7	78.6	10.1			227	348	Average
5290	95.99	85.89	10.1			227	348	Peak
5350	51.36	41.13	10.23	54	-2.64	227	348	Average
5350	62.99	52.76	10.23	74	-11.01	227	348	Peak
*10580	51.17	35.46	15.71	68.2	-17.03	119	324	Peak

Antenna Polarity & Test Distance: Vertical at 3 m								
Frequency (MHz)	Emission Level (dBuV/m)	Read Level (dBuV)	Factor (dB/m)	Limit (dBuV/m)	Margin (dB)	Antenna Height (cm)	Table Angle (Degree)	Remark
5150	43.05	33	10.05	54	-10.95	130	5	Average
5150	54.15	44.1	10.05	74	-19.85	130	5	Peak
5290	89.22	79.12	10.1			130	5	Average
5290	97.02	86.92	10.1			130	5	Peak
5350	53.17	42.94	10.23	54	-0.83	130	5	Average
5350	66.08	55.85	10.23	74	-7.92	130	5	Peak
*10580	51.6	35.89	15.71	68.2	-16.6	128	244	Peak

Remarks:

- Emission Level = Read Level + Factor
Margin value = Emission level – Limit value
- 5290 MHz: Fundamental Frequency
- *: Out of Restricted Band
- The emission levels of other frequencies were very low against the limit

EUT Test Condition		Measurement Detail	
Channel	Channel 106	Frequency Range	1 GHz ~ 40 GHz
Input Power	120 Vac, 60 Hz	Detector Function	Peak (PK) Average (AV)
Environmental Conditions	25 deg. C, 65 % RH	Tested By	Karl Lee

Antenna Polarity & Test Distance: Horizontal at 3 m								
Frequency (MHz)	Emission Level (dBuV/m)	Read Level (dBuV)	Factor (dB/m)	Limit (dBuV/m)	Margin (dB)	Antenna Height (cm)	Table Angle (Degree)	Remark
5460	53.14	42.63	10.51	54	-0.86	204	53	Average
5460	63.96	53.45	10.51	74	-10.04	204	53	Peak
*5470	66.6	56.07	10.53	68.2	-1.6	204	53	Peak
5530	92.25	81.62	10.63			204	53	Average
5530	101.18	90.55	10.63			204	53	Peak
*5725	53.97	43.05	10.92	68.2	-14.23	204	53	Peak
11060	47.49	31.26	16.23	54	-6.51	115	241	Average
11060	57.55	41.32	16.23	74	-16.45	115	241	Peak

Antenna Polarity & Test Distance: Vertical at 3 m								
Frequency (MHz)	Emission Level (dBuV/m)	Read Level (dBuV)	Factor (dB/m)	Limit (dBuV/m)	Margin (dB)	Antenna Height (cm)	Table Angle (Degree)	Remark
5460	50.63	40.12	10.51	54	-3.37	203	15	Average
5460	64.06	53.55	10.51	74	-9.94	203	15	Peak
*5470	65.8	55.27	10.53	68.2	-2.4	203	15	Peak
5530	88.99	78.36	10.63			203	15	Average
5530	97.94	87.31	10.63			203	15	Peak
*5725	52.31	41.39	10.92	68.2	-15.89	203	15	Peak
11060	47.73	31.5	16.23	54	-6.27	135	256	Average
11060	55.86	39.63	16.23	74	-18.14	135	256	Peak

Remarks:

- Emission Level = Read Level + Factor
Margin value = Emission level – Limit value
- 5530 MHz: Fundamental Frequency
- *: Out of Restricted Band
- The emission levels of other frequencies were very low against the limit

EUT Test Condition		Measurement Detail	
Channel	Channel 122	Frequency Range	1 GHz ~ 40 GHz
Input Power	120 Vac, 60 Hz	Detector Function	Peak (PK) Average (AV)
Environmental Conditions	25 deg. C, 65 % RH	Tested By	Karl Lee

Antenna Polarity & Test Distance: Horizontal at 3 m								
Frequency (MHz)	Emission Level (dBuV/m)	Read Level (dBuV)	Factor (dB/m)	Limit (dBuV/m)	Margin (dB)	Antenna Height (cm)	Table Angle (Degree)	Remark
5460	53.97	43.46	10.51	54	-0.03	177	32	Average
5460	63.99	53.48	10.51	74	-10.01	177	32	Peak
*5470	65.04	54.51	10.53	68.2	-3.16	177	32	Peak
5610	97.32	86.55	10.77			177	32	Average
5610	105.35	94.58	10.77			177	32	Peak
*5725	64.42	53.5	10.92	68.2	-3.78	177	32	Peak
11220	47.68	31.26	16.42	54	-6.32	140	274	Average
11220	56.97	40.55	16.42	74	-17.03	140	274	Peak

Antenna Polarity & Test Distance: Vertical at 3 m								
Frequency (MHz)	Emission Level (dBuV/m)	Read Level (dBuV)	Factor (dB/m)	Limit (dBuV/m)	Margin (dB)	Antenna Height (cm)	Table Angle (Degree)	Remark
5460	51.35	40.84	10.51	54	-2.65	197	15	Average
5460	61.54	51.03	10.51	74	-12.46	197	15	Peak
*5470	62.52	51.99	10.53	68.2	-5.68	197	15	Peak
5610	92.41	81.64	10.77			197	15	Average
5610	101.23	90.46	10.77			197	15	Peak
*5725	59.09	48.17	10.92	68.2	-9.11	197	15	Peak
11220	47.79	31.37	16.42	54	-6.21	137	77	Average
11220	57.52	41.1	16.42	74	-16.48	137	77	Peak

Remarks:

- Emission Level = Read Level + Factor
Margin value = Emission level – Limit value
- 5610 MHz: Fundamental Frequency
- *: Out of Restricted Band
- The emission levels of other frequencies were very low against the limit

9 kHz ~ 30 MHz Data:

The amplitude of spurious emissions attenuated more than 20 dB below the permissible value is not required to be report.

30 MHz ~ 1 GHz Worst-Case Data:

Mode A

802.11ax (HE40)

EUT Test Condition		Measurement Detail	
Channel	Channel 102	Frequency Range	30 MHz ~ 1 GHz
Input Power	120 Vac, 60 Hz	Detector Function	Peak (PK)
Environmental Conditions	25 deg. C, 65 % RH	Tested By	Karl Lee

Horizontal

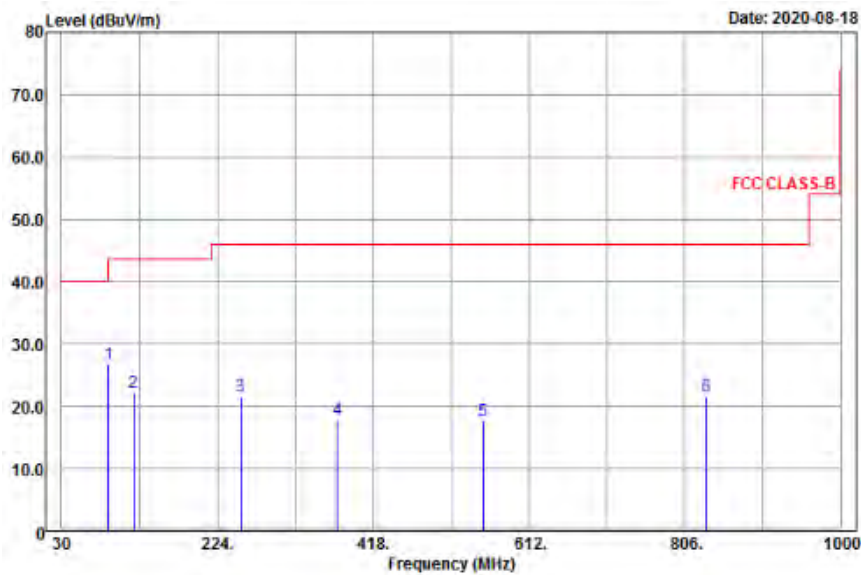

Vertical

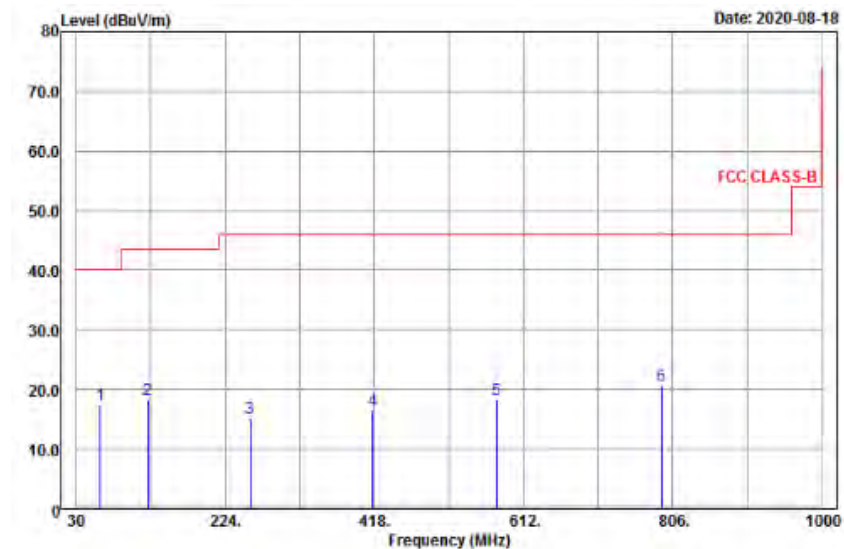

Antenna Polarity & Test Distance: Horizontal at 3 m

Frequency (MHz)	Emission Level (dBuV/m)	Read Level (dBuV)	Factor (dB/m)	Limit (dBuV/m)	Margin (dB)	Antenna Height (cm)	Table Angle (Degree)	Remark
88.32	26.77	46.33	-19.56	43.5	-16.73	115	172	Peak
120.18	22.22	41.66	-19.44	43.5	-21.28	120	168	Peak
253.29	21.52	38.32	-16.8	46	-24.48	169	236	Peak
373.5	17.78	32.13	-14.35	46	-28.22	105	139	Peak
554.8	17.67	29.16	-11.49	46	-28.33	125	117	Peak
832.7	21.51	28.53	-7.02	46	-24.49	102	47	Peak

Antenna Polarity & Test Distance: Vertical at 3 m

Frequency (MHz)	Emission Level (dBuV/m)	Read Level (dBuV)	Factor (dB/m)	Limit (dBuV/m)	Margin (dB)	Antenna Height (cm)	Table Angle (Degree)	Remark
61.32	17.45	33.87	-16.42	40	-22.55	111	76	Peak
123.15	18.24	38.01	-19.77	43.5	-25.26	195	23	Peak
256.8	15.36	32.07	-16.71	46	-30.64	125	68	Peak
416.2	16.49	30.14	-13.65	46	-29.51	158	335	Peak
577.2	18.22	29.22	-11	46	-27.78	165	223	Peak
791.4	20.8	28.62	-7.82	46	-25.2	120	145	Peak

Remarks:

- Emission Level = Read Level + Factor
Margin value = Emission level – Limit value
- The emission levels of other frequencies were very low against the limit

Mode B

802.11ax (HE80)

EUT Test Condition		Measurement Detail	
Channel	Channel 122	Frequency Range	30 MHz ~ 1 GHz
Input Power	120 Vac, 60 Hz	Detector Function	Peak (PK)
Environmental Conditions	25 deg. C, 65 % RH	Tested By	Karl Lee

Horizontal

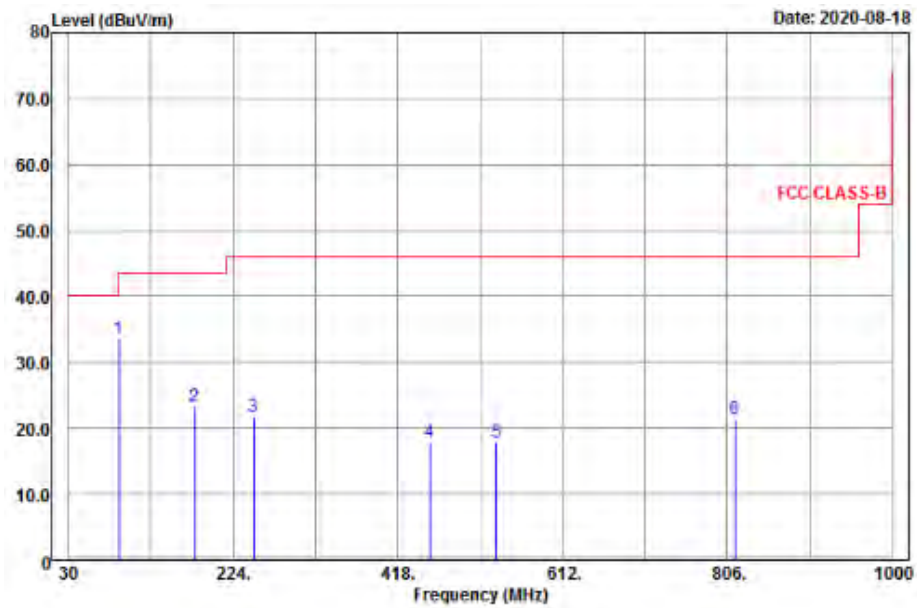

Vertical

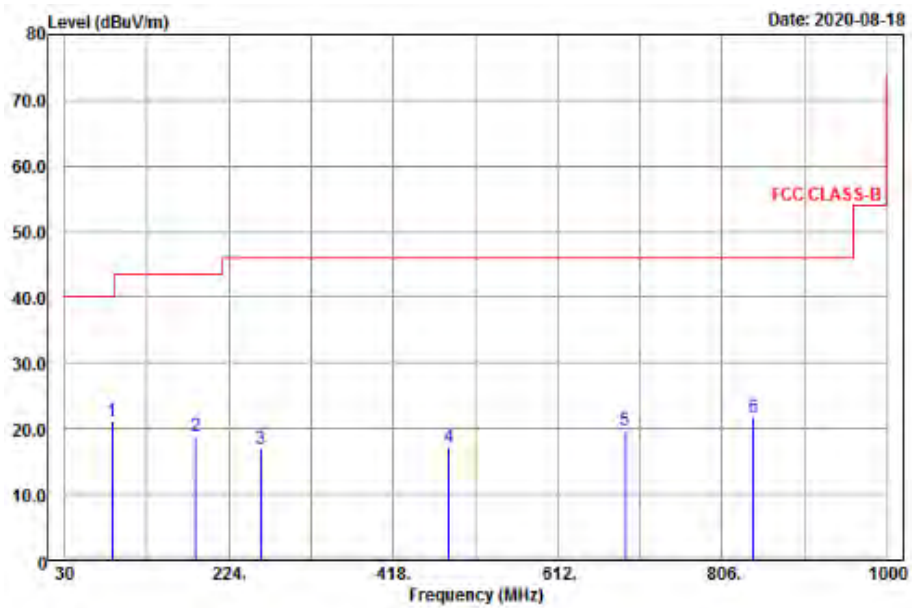

Antenna Polarity & Test Distance: Horizontal at 3 m

Frequency (MHz)	Emission Level (dBuV/m)	Read Level (dBuV)	Factor (dB/m)	Limit (dBuV/m)	Margin (dB)	Antenna Height (cm)	Table Angle (Degree)	Remark
89.13	33.47	52.76	-19.29	43.5	-10.03	151	124	Peak
179.04	23.29	42.99	-19.7	43.5	-20.21	160	235	Peak
247.89	21.9	38.77	-16.87	46	-24.1	183	226	Peak
455.4	17.82	31	-13.18	46	-28.18	145	8	Peak
533.8	17.96	29.79	-11.83	46	-28.04	139	226	Peak
814.5	21.26	28.71	-7.45	46	-24.74	127	125	Peak

Antenna Polarity & Test Distance: Vertical at 3 m

Frequency (MHz)	Emission Level (dBuV/m)	Read Level (dBuV)	Factor (dB/m)	Limit (dBuV/m)	Margin (dB)	Antenna Height (cm)	Table Angle (Degree)	Remark
86.16	21.14	41.23	-20.09	40	-18.86	112	157	Peak
184.98	18.89	38.04	-19.15	43.5	-24.61	198	236	Peak
261.93	17.02	33.67	-16.65	46	-28.98	150	124	Peak
483.4	17.29	29.94	-12.65	46	-28.71	188	234	Peak
692	19.88	29.17	-9.29	46	-26.12	129	134	Peak
842.5	21.82	28.74	-6.92	46	-24.18	120	157	Peak

Remarks:

3. Emission Level = Read Level + Factor
Margin value = Emission level – Limit value
4. The emission levels of other frequencies were very low against the limit

4.2 Conducted Emission Measurement

4.2.1 Limits of Conducted Emission Measurement

Frequency (MHz)	Conducted Limit (dBuV)	
	Quasi-Peak	Average
0.15 - 0.5	66 - 56	56 - 46
0.50 - 5.0	56	46
5.0 - 30.0	60	50

- Note: 1. The lower limit shall apply at the transition frequencies.
 2. The limit decreases in line with the logarithm of the frequency in the range of 0.15 to 0.50 MHz.

4.2.2 Test Instruments

Description & Manufacturer	Model No.	Serial No.	Date of Calibration	Due Date of Calibration
Test Receiver ROHDE & SCHWARZ	ESR3	102412	Feb. 17, 2020	Feb. 16, 2021
RF signal cable (with 10dB PAD) Woken	5D-FB	Cable-cond2-01	Sep. 05, 2019	Sep. 04, 2020
LISN ROHDE & SCHWARZ (EUT)	ESH2-Z5	100100	Jan. 20, 2020	Jan. 19, 2021
LISN ROHDE & SCHWARZ (Peripheral)	ESH3-Z5	100312	Aug. 13, 2019	Aug. 12, 2020
Software ADT	BV ADT_Cond_ V7.3.7.4	NA	NA	NA

- Note: 1. The calibration interval of the above test instruments is 12 months and the calibrations are traceable to NML/ROC and NIST/USA.
 2. The test was performed in HwaYa Shielded Room 2 (Conduction 2).
 3. The VCCI Site Registration No. is C-12047.

4.2.3 Test Procedures

- a. The EUT was placed 0.4 meters from the conducting wall of the shielded room with EUT being connected to the power mains through a line impedance stabilization network (LISN). Other support units were connected to the power mains through another LISN. The two LISNs provide 50 ohm/ 50uH of coupling impedance for the measuring instrument.
- b. Both lines of the power mains connected to the EUT were checked for maximum conducted interference.
- c. The frequency range from 150 kHz to 30 MHz was searched. Emission levels under (Limit -20 dB) was not recorded.

Note: All modes of operation were investigated and the worst-case emissions are reported.

4.2.4 Deviation from Test Standard

No deviation.

4.2.5 Test Setup

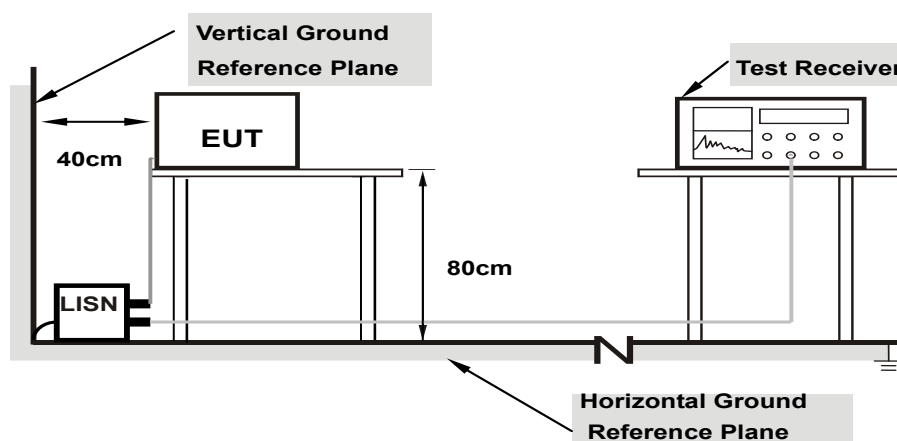

- Note:**
1. Support units were connected to second LISN.
 2. Both of LISNs (AMN) are 80 cm from EUT and at least 80 from other units and other metal planes

For the actual test configuration, please refer to the attached file (Test Setup Photo).

4.2.6 EUT Operating Conditions

- a. Placed the EUT on a testing table.
- b. Use the software to control the EUT under transmission condition continuously at specific channel frequency.

4.2.7 Test Results

Frequency Range	150kHz ~ 30MHz	Detector Function & Resolution Bandwidth	Quasi-Peak (QP) / Average (AV), 9kHz
Input Power	120Vac, 60Hz	Environmental Conditions	25°C, 65%RH
Tested by	Jisyong Wang	Test Date	2020/7/23
Test Mode	Mode A		

Phase Of Power : Line (L)										
No	Frequency (MHz)	Correction Factor (dB)	Reading Value (dBuV)		Emission Level (dBuV)		Limit (dBuV)		Margin (dB)	
			Q.P.	AV.	Q.P.	AV.	Q.P.	AV.	Q.P.	AV.
1	0.17191	10.16	36.98	30.40	47.14	40.56	64.87	54.87	-17.73	-14.31
2	0.21300	10.17	27.32	20.91	37.49	31.08	63.09	53.09	-25.60	-22.01
3	0.40335	10.20	33.71	25.88	43.91	36.08	57.78	47.78	-13.87	-11.70
4	0.69670	10.23	22.06	20.04	32.29	30.27	56.00	46.00	-23.71	-15.73
5	1.20750	10.27	20.88	13.25	31.15	23.52	56.00	46.00	-24.85	-22.48
6	17.50875	10.57	23.28	20.70	33.85	31.27	60.00	50.00	-26.15	-18.73

Remarks:

1. Q.P. and AV. are abbreviations of quasi-peak and average individually.
2. The emission levels of other frequencies were very low against the limit.
3. Margin value = Emission level – Limit value
4. Correction factor = Insertion loss + Cable loss
5. Emission Level = Correction Factor + Reading Value

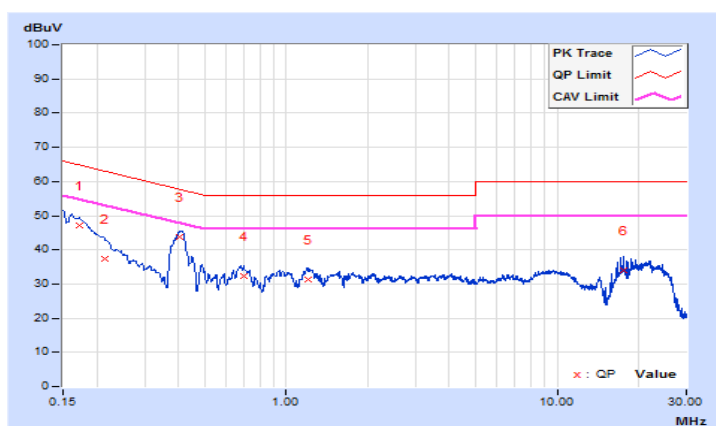

Frequency Range	150kHz ~ 30MHz	Detector Function & Resolution Bandwidth	Quasi-Peak (QP) / Average (AV), 9kHz
Input Power	120Vac, 60Hz	Environmental Conditions	25°C, 65%RH
Tested by	Jisyong Wang	Test Date	2020/7/23
Test Mode	Mode A		

Phase Of Power : Neutral (N)										
No	Frequency (MHz)	Correction Factor (dB)	Reading Value (dBuV)		Emission Level (dBuV)		Limit (dBuV)		Margin (dB)	
			Q.P.	AV.	Q.P.	AV.	Q.P.	AV.	Q.P.	AV.
1	0.16093	10.12	37.90	30.37	48.02	40.49	65.42	55.42	-17.40	-14.93
2	0.19500	10.13	34.33	30.62	44.46	40.75	63.82	53.82	-19.36	-13.07
3	0.41305	10.18	33.59	27.62	43.77	37.80	57.59	47.59	-13.82	-9.79
4	0.67855	10.21	19.42	13.30	29.63	23.51	56.00	46.00	-26.37	-22.49
5	1.23886	10.25	19.43	11.17	29.68	21.42	56.00	46.00	-26.32	-24.58
6	18.81375	10.78	24.26	20.18	35.04	30.96	60.00	50.00	-24.96	-19.04

Remarks:

1. Q.P. and AV. are abbreviations of quasi-peak and average individually.
2. The emission levels of other frequencies were very low against the limit.
3. Margin value = Emission level – Limit value
4. Correction factor = Insertion loss + Cable loss
5. Emission Level = Correction Factor + Reading Value

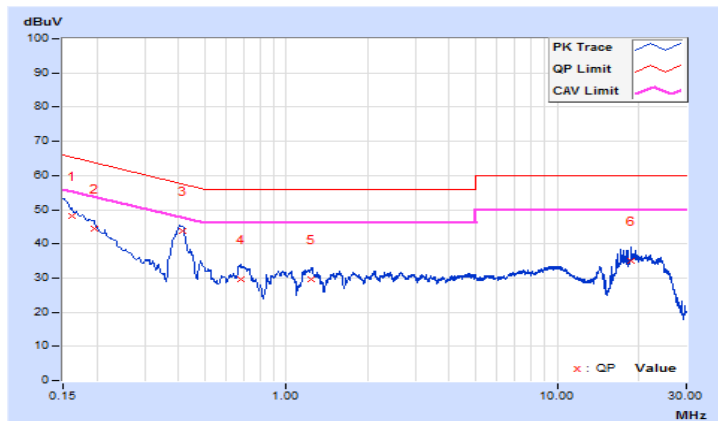

Frequency Range	150kHz ~ 30MHz	Detector Function & Resolution Bandwidth	Quasi-Peak (QP) / Average (AV), 9kHz
Input Power	120Vac, 60Hz	Environmental Conditions	25°C, 65%RH
Tested by	Jisyong Wang	Test Date	2020/7/23
Test Mode	Mode B		

Phase Of Power : Line (L)										
No	Frequency (MHz)	Correction Factor (dB)	Reading Value (dBuV)		Emission Level (dBuV)		Limit (dBuV)		Margin (dB)	
			Q.P.	AV.	Q.P.	AV.	Q.P.	AV.	Q.P.	AV.
1	0.16125	10.15	39.02	30.99	49.17	41.14	65.40	55.40	-16.23	-14.26
2	0.17925	10.16	32.39	30.85	42.55	41.01	64.52	54.52	-21.97	-13.51
3	0.23550	10.18	28.90	21.64	39.08	31.82	62.25	52.25	-23.17	-20.43
4	0.41325	10.20	33.84	27.94	44.04	38.14	57.58	47.58	-13.54	-9.44
5	1.20525	10.27	20.21	12.59	30.48	22.86	56.00	46.00	-25.52	-23.14
6	17.50650	10.57	23.87	21.23	34.44	31.80	60.00	50.00	-25.56	-18.20

Remarks:

1. Q.P. and AV. are abbreviations of quasi-peak and average individually.
2. The emission levels of other frequencies were very low against the limit.
3. Margin value = Emission level – Limit value
4. Correction factor = Insertion loss + Cable loss
5. Emission Level = Correction Factor + Reading Value

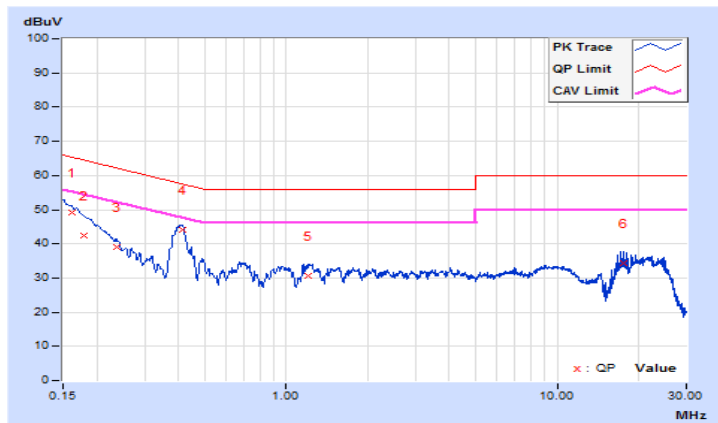

Frequency Range	150kHz ~ 30MHz	Detector Function & Resolution Bandwidth	Quasi-Peak (QP) / Average (AV), 9kHz
Input Power	120Vac, 60Hz	Environmental Conditions	25°C, 65%RH
Tested by	Jisyong Wang	Test Date	2020/7/23
Test Mode	Mode B		

Phase Of Power : Neutral (N)										
No	Frequency (MHz)	Correction Factor (dB)	Reading Value (dBuV)		Emission Level (dBuV)		Limit (dBuV)		Margin (dB)	
			Q.P.	AV.	Q.P.	AV.	Q.P.	AV.	Q.P.	AV.
1	0.16093	10.12	38.47	30.31	48.59	40.43	65.42	55.42	-16.83	-14.99
2	0.19500	10.13	33.07	30.52	43.20	40.65	63.82	53.82	-20.62	-13.17
3	0.41325	10.18	33.44	27.47	43.62	37.65	57.58	47.58	-13.96	-9.93
4	0.69854	10.21	19.95	11.91	30.16	22.12	56.00	46.00	-25.84	-23.88
5	17.24550	10.74	24.27	21.20	35.01	31.94	60.00	50.00	-24.99	-18.06
6	22.30575	10.74	22.56	17.55	33.30	28.29	60.00	50.00	-26.70	-21.71

Remarks:

1. Q.P. and AV. are abbreviations of quasi-peak and average individually.
2. The emission levels of other frequencies were very low against the limit.
3. Margin value = Emission level – Limit value
4. Correction factor = Insertion loss + Cable loss
5. Emission Level = Correction Factor + Reading Value

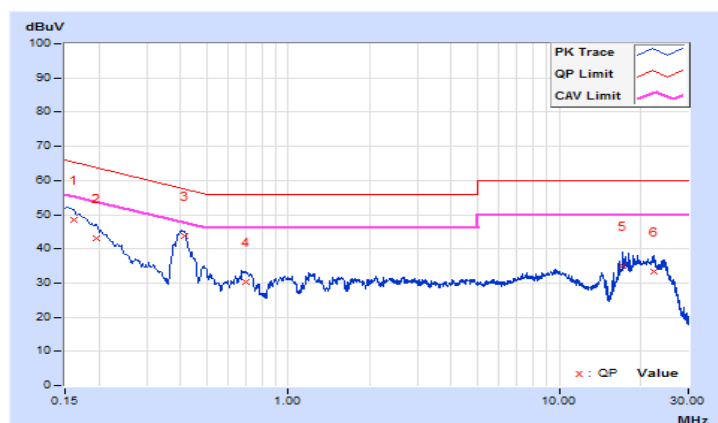

4.3 Transmit Power Measurement

4.3.1 Limits of Transmit Power Measurement

Operation Band	EUT Category		Limit
U-NII-1		Outdoor Access Point	1 Watt (30 dBm) (Max. e.i.r.p \leq 125 mW (21 dBm) at any elevation angle above 30 degrees as measured from the horizon)
		Fixed point-to-point Access Point	1 Watt (30 dBm)
		Indoor Access Point	1 Watt (30 dBm)
		Mobile and Portable client device	250 mW (24 dBm)
U-NII-2A		√	250 mW (24 dBm) or 11 dBm + 10 log B*
U-NII-2C		√	250 mW (24 dBm) or 11 dBm + 10 log B*
U-NII-3			1 Watt (30 dBm)

*B is the 26 dB emission bandwidth in megahertz

Per KDB 662911 Method of conducted output power measurement on IEEE 802.11 devices,

Array Gain = 0 dB (i.e., no array gain) for $N_{ANT} \leq 4$;

Array Gain = 0 dB (i.e., no array gain) for channel widths ≥ 40 MHz for any N_{ANT} ;

Array Gain = $5 \log(N_{ANT}/N_{SS})$ dB or 3 dB, whichever is less for 20 MHz channel widths with $N_{ANT} \geq 5$.

For power measurements on all other devices: Array Gain = $10 \log(N_{ANT}/N_{SS})$ dB.

4.3.2 Test Setup

<Power Output Measurement>

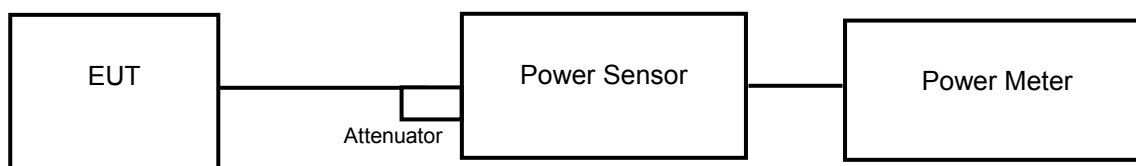

or

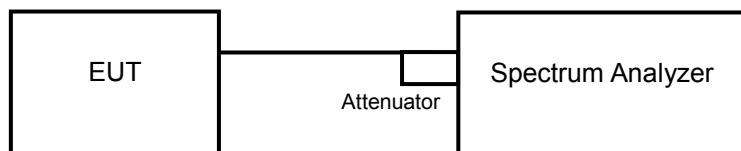

<26 dB Bandwidth>

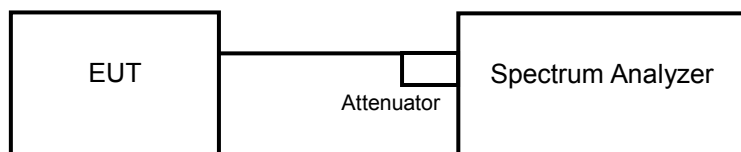

4.3.3 Test Instruments

Refer to section 4.1.2 to get information of above instrument.

4.3.4 Test Procedure

Average Power Measurement

<802.11a, 802.11ax (HE20), 802.11ax (HE40)>

Method PM is used to perform output power measurement, trigger and gating function of wide band power meter is enabled to measure max output power of TX on burst. Duty factor is not added to measured value.

<802.11ax (HE80)>

- a. Set span to encompass the entire 26 dB EBW (or, alternatively, the entire 99 % occupied bandwidth) of the signal.
- b. Set sweep trigger to "free run".
- c. Set RBW = 1 MHz.
- d. Set VBW \geq 3 MHz
- e. Number of points in sweep \geq 2 Span / RBW.
- f. Sweep time \leq (number of points in sweep) * T
- g. Using emission bandwidth to determine the frequency span for integration the channel bandwidth.
- h. Detector = RMS.
- i. Trace mode = max hold.
- j. Allow max hold to run for at least 60 seconds, or longer as needed to allow the trace to stabilize.
- k. Compute power by integrating the spectrum across the EBW (or, alternatively, the entire 99% occupied bandwidth) of the signal using the instrument's band power measurement function with band limits set equal to the EBW (or occupied bandwidth) band edges. If the instrument does not have a band power function, sum the spectrum levels (in power units) at 1 MHz intervals extending across the EBW (or, alternatively, the entire 99% occupied bandwidth) of the spectrum

26 dB Bandwidth

- a. Set RBW = approximately 1 % of the emission bandwidth.
- b. Set the VBW \geq 3 x RBW.
- c. Detector = Peak.
- d. Trace mode = max hold.
- e. Measure the maximum width of the emission that is 26 dB down from the peak of the emission. Compare this with the RBW setting of the analyzer. Readjust RBW and repeat measurement as needed until the RBW/EBW ratio is approximately 1 %.

4.3.5 Deviation from Test Standard

No deviation.

4.3.6 EUT Operating Conditions

The software provided by client to enable the EUT under transmission condition continuously at lowest, middle and highest channel frequencies individually.

4.3.7 Test Results

Power Output:

CDD Mode

Mode A

802.11a

Channel	Frequency (MHz)	Maximum Conducted Power (dBm)		Total Power (mW)	Total Power (dBm)	Power Limit (dBm)	Pass / Fail
		Chain 0	Chain 1				
52	5260	18.57	18.49	142.577	21.54	24	Pass
60	5300	18.52	18.44	140.945	21.49	24	Pass
64	5320	17.90	17.74	121.089	20.83	24	Pass
100	5500	16.25	16.22	84.049	19.25	24	Pass
116	5580	18.18	18.14	130.929	21.17	24	Pass
140	5700	16.30	15.93	81.832	19.13	24	Pass

Note:

For U-NII-2A, U-NII-2C Band:

Chain 0

1. $11 \text{ dBm} + 10\log(21.55) = 24.33 \text{ dBm} > 24 \text{ dBm}$.
2. $11 \text{ dBm} + 10\log(21.58) = 24.34 \text{ dBm} > 24 \text{ dBm}$.
3. $11 \text{ dBm} + 10\log(21.53) = 24.33 \text{ dBm} > 24 \text{ dBm}$.
4. $11 \text{ dBm} + 10\log(21.68) = 24.36 \text{ dBm} > 24 \text{ dBm}$.
5. $11 \text{ dBm} + 10\log(21.61) = 24.35 \text{ dBm} > 24 \text{ dBm}$.
6. $11 \text{ dBm} + 10\log(21.68) = 24.36 \text{ dBm} > 24 \text{ dBm}$.

Chain 1

1. $11 \text{ dBm} + 10\log(22.05) = 24.43 \text{ dBm} > 24 \text{ dBm}$.
2. $11 \text{ dBm} + 10\log(22.17) = 24.46 \text{ dBm} > 24 \text{ dBm}$.
3. $11 \text{ dBm} + 10\log(21.59) = 24.34 \text{ dBm} > 24 \text{ dBm}$.
4. $11 \text{ dBm} + 10\log(21.62) = 24.35 \text{ dBm} > 24 \text{ dBm}$.
5. $11 \text{ dBm} + 10\log(22.11) = 24.45 \text{ dBm} > 24 \text{ dBm}$.
6. $11 \text{ dBm} + 10\log(21.66) = 24.36 \text{ dBm} > 24 \text{ dBm}$.

802.11ax (HE20)

Channel	Frequency (MHz)	Maximum Conducted Power (dBm)		Total Power (mW)	Total Power (dBm)	Power Limit (dBm)	Pass / Fail
		Chain 0	Chain 1				
52	5260	18.46	18.41	139.488	21.45	24	Pass
60	5300	18.58	18.52	143.232	21.56	24	Pass
64	5320	17.72	17.66	117.501	20.70	24	Pass
100	5500	16.58	16.31	88.255	19.46	24	Pass
116	5580	18.23	18.11	131.242	21.18	24	Pass
140	5700	13.70	13.67	46.723	16.70	24	Pass

Note:

For U-NII-2A, U-NII-2C Band:

Chain 0

1. $11 \text{ dBm} + 10\log(21.90) = 24.40 \text{ dBm} > 24 \text{ dBm}$.
2. $11 \text{ dBm} + 10\log(21.88) = 24.40 \text{ dBm} > 24 \text{ dBm}$.
3. $11 \text{ dBm} + 10\log(22.01) = 24.43 \text{ dBm} > 24 \text{ dBm}$.
4. $11 \text{ dBm} + 10\log(21.84) = 24.39 \text{ dBm} > 24 \text{ dBm}$.
5. $11 \text{ dBm} + 10\log(21.91) = 24.41 \text{ dBm} > 24 \text{ dBm}$.
6. $11 \text{ dBm} + 10\log(21.83) = 24.39 \text{ dBm} > 24 \text{ dBm}$.

Chain 1

1. $11 \text{ dBm} + 10\log(21.64) = 24.35 \text{ dBm} > 24 \text{ dBm}$.
2. $11 \text{ dBm} + 10\log(21.74) = 24.37 \text{ dBm} > 24 \text{ dBm}$.
3. $11 \text{ dBm} + 10\log(21.73) = 24.37 \text{ dBm} > 24 \text{ dBm}$.
4. $11 \text{ dBm} + 10\log(21.65) = 24.35 \text{ dBm} > 24 \text{ dBm}$.
5. $11 \text{ dBm} + 10\log(21.64) = 24.35 \text{ dBm} > 24 \text{ dBm}$.
6. $11 \text{ dBm} + 10\log(21.72) = 24.37 \text{ dBm} > 24 \text{ dBm}$.

802.11ax (HE40)

Channel	Frequency (MHz)	Maximum Conducted Power (dBm)		Total Power (mW)	Total Power (dBm)	Power Limit (dBm)	Pass / Fail
		Chain 0	Chain 1				
54	5270	20.70	20.54	230.73	23.63	24	Pass
62	5310	15.94	15.65	75.993	18.81	24	Pass
102	5510	16.20	16.14	82.802	19.18	24	Pass
110	5550	20.77	20.65	235.544	23.72	24	Pass
134	5670	18.13	17.71	124.033	20.94	24	Pass

Note:

For U-NII-2A, U-NII-2C Band:

Chain 0

1. $11 \text{ dBm} + 10\log (58.68) = 28.68 \text{ dBm} > 24 \text{ dBm}.$
2. $11 \text{ dBm} + 10\log (41.77) = 27.20 \text{ dBm} > 24 \text{ dBm}.$
3. $11 \text{ dBm} + 10\log (41.57) = 27.19 \text{ dBm} > 24 \text{ dBm}.$
4. $11 \text{ dBm} + 10\log (69.23) = 29.40 \text{ dBm} > 24 \text{ dBm}.$
5. $11 \text{ dBm} + 10\log (41.58) = 27.19 \text{ dBm} > 24 \text{ dBm}.$

Chain 1

1. $11 \text{ dBm} + 10\log (48.23) = 27.83 \text{ dBm} > 24 \text{ dBm}.$
2. $11 \text{ dBm} + 10\log (41.52) = 27.18 \text{ dBm} > 24 \text{ dBm}.$
3. $11 \text{ dBm} + 10\log (41.62) = 27.19 \text{ dBm} > 24 \text{ dBm}.$
4. $11 \text{ dBm} + 10\log (48.29) = 27.84 \text{ dBm} > 24 \text{ dBm}.$
5. $11 \text{ dBm} + 10\log (41.20) = 27.15 \text{ dBm} > 24 \text{ dBm}.$

802.11ax (HE80)

Channel	Frequency (MHz)	Maximum Conducted Power (dBm)		Total Power (mW)	Total Power (dBm)	Power Limit (dBm)	Pass / Fail
		Chain 0	Chain 1				
58	5290	15.44	15.22	68.26	18.34	24	Pass
106	5530	14.48	14.38	55.47	17.44	24	Pass
122	5610	18.97	18.67	152.507	21.83	24	Pass

Note:

For U-NII-2A, U-NII-2C Band:

Chain 0

1. $11 \text{ dBm} + 10\log (83.02) = 30.19 \text{ dBm} > 24 \text{ dBm}.$
2. $11 \text{ dBm} + 10\log (83.15) = 30.20 \text{ dBm} > 24 \text{ dBm}.$
3. $11 \text{ dBm} + 10\log (83.21) = 30.20 \text{ dBm} > 24 \text{ dBm}.$

Chain 1

1. $11 \text{ dBm} + 10\log (82.53) = 30.17 \text{ dBm} > 24 \text{ dBm}.$
2. $11 \text{ dBm} + 10\log (82.75) = 30.18 \text{ dBm} > 24 \text{ dBm}.$
3. $11 \text{ dBm} + 10\log (82.53) = 30.17 \text{ dBm} > 24 \text{ dBm}.$

Mode B

802.11a

Channel	Frequency (MHz)	Maximum Conducted Power (mW)	Maximum Conducted Power (dBm)	Power Limit (dBm)	Pass / Fail
52	5260	85.901	19.34	24	Pass
60	5300	77.09	18.87	24	Pass
64	5320	45.29	16.56	24	Pass
100	5500	33.343	15.23	24	Pass
116	5580	84.14	19.25	24	Pass
140	5700	35.075	15.45	24	Pass

Note:

For U-NII-2A, U-NII-2C Band:

1. $11 \text{ dBm} + 10\log (47.31) = 27.75 \text{ dBm} > 24 \text{ dBm}$.
2. $11 \text{ dBm} + 10\log (45.35) = 27.57 \text{ dBm} > 24 \text{ dBm}$.
3. $11 \text{ dBm} + 10\log (43.41) = 27.38 \text{ dBm} > 24 \text{ dBm}$.
4. $11 \text{ dBm} + 10\log (41.01) = 27.13 \text{ dBm} > 24 \text{ dBm}$.
5. $11 \text{ dBm} + 10\log (47.65) = 27.78 \text{ dBm} > 24 \text{ dBm}$.
6. $11 \text{ dBm} + 10\log (41.10) = 27.14 \text{ dBm} > 24 \text{ dBm}$.

802.11ax (HE20)

Channel	Frequency (MHz)	Maximum Conducted Power (mW)	Maximum Conducted Power (dBm)	Power Limit (dBm)	Pass / Fail
52	5260	87.7	19.43	24	Pass
60	5300	73.621	18.67	24	Pass
64	5320	35.975	15.56	24	Pass
100	5500	34.674	15.40	24	Pass
116	5580	86.099	19.35	24	Pass
140	5700	21.577	13.34	24	Pass

Note:

For U-NII-2A, U-NII-2C Band:

1. $11 \text{ dBm} + 10\log (48.88) = 27.89 \text{ dBm} > 24 \text{ dBm}$.
2. $11 \text{ dBm} + 10\log (49.88) = 27.98 \text{ dBm} > 24 \text{ dBm}$.
3. $11 \text{ dBm} + 10\log (29.71) = 25.73 \text{ dBm} > 24 \text{ dBm}$.
4. $11 \text{ dBm} + 10\log (28.74) = 25.58 \text{ dBm} > 24 \text{ dBm}$.
5. $11 \text{ dBm} + 10\log (52.99) = 28.24 \text{ dBm} > 24 \text{ dBm}$.
6. $11 \text{ dBm} + 10\log (24.56) = 24.90 \text{ dBm} > 24 \text{ dBm}$.

802.11ax (HE40)

Channel	Frequency (MHz)	Maximum Conducted Power (mW)	Maximum Conducted Power (dBm)	Power Limit (dBm)	Pass / Fail
54	5270	49.774	16.97	24	Pass
62	5310	17.14	12.34	24	Pass
102	5510	19.724	12.95	24	Pass
110	5550	35.075	15.45	24	Pass
134	5670	19.498	12.90	24	Pass

Note:

For U-NII-2A, U-NII-2C Band:

1. $11 \text{ dBm} + 10\log (87.05) = 30.40 \text{ dBm} > 24 \text{ dBm}$.
2. $11 \text{ dBm} + 10\log (41.81) = 27.21 \text{ dBm} > 24 \text{ dBm}$.
3. $11 \text{ dBm} + 10\log (41.94) = 27.23 \text{ dBm} > 24 \text{ dBm}$.
4. $11 \text{ dBm} + 10\log (57.17) = 28.57 \text{ dBm} > 24 \text{ dBm}$.
5. $11 \text{ dBm} + 10\log (41.84) = 27.22 \text{ dBm} > 24 \text{ dBm}$.

802.11ax (HE80)

Channel	Frequency (MHz)	Maximum Conducted Power (mW)	Maximum Conducted Power (dBm)	Power Limit (dBm)	Pass / Fail
58	5290	14.322	11.56	24	Pass
106	5530	19.498	12.90	24	Pass
122	5610	40.926	16.12	24	Pass

Note:

For U-NII-2A, U-NII-2C Band:

1. $11 \text{ dBm} + 10\log (83.25) = 30.20 \text{ dBm} > 24 \text{ dBm}$.
2. $11 \text{ dBm} + 10\log (83.44) = 30.21 \text{ dBm} > 24 \text{ dBm}$.
3. $11 \text{ dBm} + 10\log (170.62) = 33.32 \text{ dBm} > 24 \text{ dBm}$.

Beamforming Mode

Mode A

802.11ax (HE20)

Channel	Frequency (MHz)	Maximum Conducted Power (dBm)		Total Power (mW)	Total Power (dBm)	Power Limit (dBm)	Pass / Fail
		Chain 0	Chain 1				
52	5260	18.23	18.12	131.391	21.19	21.39	Pass
60	5300	18.19	18.05	129.744	21.13	21.39	Pass
64	5320	17.72	17.66	117.501	20.70	21.39	Pass
100	5500	16.58	16.31	88.255	19.46	21.39	Pass
116	5580	18.23	18.11	131.242	21.18	21.39	Pass
140	5700	13.70	13.67	46.723	16.70	21.39	Pass

Note:

For U-NII-2A, U-NII-2C Band:

Directional gain = $10\log[(10^{G1/20} + 10^{G2/20} + \dots + 10^{GN/20})^2 / \text{NANT}] = 8.61 \text{ dBi} > 6 \text{ dBi}$, so the power limit shall be reduced to $24 - (8.61 - 6) = 21.39 \text{ dBm}$.

For U-NII-2A, U-NII-2C Band:

Chain 0

1. $11 \text{ dBm} + 10\log(21.90) = 24.40 \text{ dBm} > 24 \text{ dBm}$.
2. $11 \text{ dBm} + 10\log(21.88) = 24.40 \text{ dBm} > 24 \text{ dBm}$.
3. $11 \text{ dBm} + 10\log(22.01) = 24.43 \text{ dBm} > 24 \text{ dBm}$.
4. $11 \text{ dBm} + 10\log(21.84) = 24.39 \text{ dBm} > 24 \text{ dBm}$.
5. $11 \text{ dBm} + 10\log(21.91) = 24.41 \text{ dBm} > 24 \text{ dBm}$.
6. $11 \text{ dBm} + 10\log(21.83) = 24.39 \text{ dBm} > 24 \text{ dBm}$.

Chain 1

1. $11 \text{ dBm} + 10\log(21.64) = 24.35 \text{ dBm} > 24 \text{ dBm}$.
2. $11 \text{ dBm} + 10\log(21.74) = 24.37 \text{ dBm} > 24 \text{ dBm}$.
3. $11 \text{ dBm} + 10\log(21.73) = 24.37 \text{ dBm} > 24 \text{ dBm}$.
4. $11 \text{ dBm} + 10\log(21.65) = 24.35 \text{ dBm} > 24 \text{ dBm}$.
5. $11 \text{ dBm} + 10\log(21.64) = 24.35 \text{ dBm} > 24 \text{ dBm}$.
6. $11 \text{ dBm} + 10\log(21.72) = 24.37 \text{ dBm} > 24 \text{ dBm}$.

802.11ax (HE40)

Channel	Frequency (MHz)	Maximum Conducted Power (dBm)		Total Power (mW)	Total Power (dBm)	Power Limit (dBm)	Pass / Fail
		Chain 0	Chain 1				
54	5270	17.89	17.78	121.497	20.85	21.39	Pass
62	5310	15.94	15.65	75.993	18.81	21.39	Pass
102	5510	16.20	16.14	82.802	19.18	21.39	Pass
110	5550	17.80	17.72	119.412	20.77	21.39	Pass
134	5670	18.13	17.71	124.033	20.94	21.39	Pass

Note:

For U-NII-2A, U-NII-2C Band:

Directional gain = $10\log[(10G^{1/20} + 10G^{2/20} + \dots + 10G^{N/20})^2 / NANT]$ = 8.61 dBi > 6 dBi , so the power limit shall be reduced to $24-(8.61-6) = 21.39$ dBm.

For U-NII-2A, U-NII-2C Band:

Chain 0

1. 11 dBm + 10log (58.68) = 28.68 dBm > 24 dBm.
2. 11 dBm + 10log (41.77) = 27.20 dBm > 24 dBm.
3. 11 dBm + 10log (41.57) = 27.19 dBm > 24 dBm.
4. 11 dBm + 10log (69.23) = 29.40 dBm > 24 dBm.
5. 11 dBm + 10log (41.58) = 27.19 dBm > 24 dBm.

Chain 1

1. 11 dBm + 10log (48.23) = 27.83 dBm > 24 dBm.
2. 11 dBm + 10log (41.52) = 27.18 dBm > 24 dBm.
3. 11 dBm + 10log (41.62) = 27.19 dBm > 24 dBm.
4. 11 dBm + 10log (48.29) = 27.84 dBm > 24 dBm.
5. 11 dBm + 10log (41.20) = 27.15 dBm > 24 dBm.

802.11ax (HE80)

Channel	Frequency (MHz)	Maximum Conducted Power (dBm)		Total Power (mW)	Total Power (dBm)	Power Limit (dBm)	Pass / Fail
		Chain 0	Chain 1				
58	5290	15.44	15.22	68.26	18.34	21.39	Pass
106	5530	14.48	14.38	55.47	17.44	21.39	Pass
122	5610	18.11	18.04	128.394	21.09	21.39	Pass

Note:

For U-NII-2A, U-NII-2C Band:

Directional gain = $10\log[(10G^{1/20} + 10G^{2/20} + \dots + 10G^{N/20})^2 / NANT]$ = 8.61 dBi > 6 dBi , so the power limit shall be reduced to $24-(8.61-6) = 21.39$ dBm

For U-NII-2A, U-NII-2C Band:

Chain 0

1. 11 dBm + 10log (83.02) = 30.19 dBm > 24 dBm.
2. 11 dBm + 10log (83.15) = 30.20 dBm > 24 dBm.
3. 11 dBm + 10log (83.21) = 30.20 dBm > 24 dBm.

Chain 1

1. 11 dBm + 10log (82.53) = 30.17 dBm > 24 dBm.
2. 11 dBm + 10log (82.75) = 30.18 dBm > 24 dBm.
3. 11 dBm + 10log (82.53) = 30.17 dBm > 24 dBm.

26 dB Bandwidth:

Mode A

802.11a

Channel	Frequency (MHz)	26 dBc Bandwidth (MHz)	
		Chain 0	Chain 1
52	5260	21.55	22.05
60	5300	21.58	22.17
64	5320	21.53	21.59
100	5500	21.68	21.62
116	5580	21.61	22.11
140	5700	21.68	21.66

802.11ax (HE20)

Channel	Frequency (MHz)	26 dBc Bandwidth (MHz)	
		Chain 0	Chain 1
52	5260	21.90	21.64
60	5300	21.88	21.74
64	5320	22.01	21.73
100	5500	21.84	21.65
116	5580	21.91	21.64
140	5700	21.83	21.72

802.11ax (HE40)

Channel	Frequency (MHz)	26 dBc Bandwidth (MHz)	
		Chain 0	Chain 1
54	5270	58.68	48.23
62	5310	41.77	41.52
102	5510	41.57	41.62
110	5550	69.23	48.29
134	5670	41.58	41.20

802.11ax (HE80)

Channel	Frequency (MHz)	26 dBc Bandwidth (MHz)	
		Chain 0	Chain 1
58	5290	83.02	82.53
106	5530	83.15	82.75
122	5610	83.21	82.53

Spectrum Plot of Worst Value

802.11a

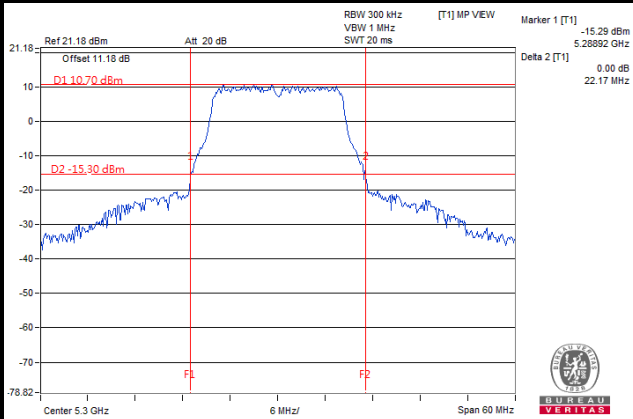

802.11ax (HE20)

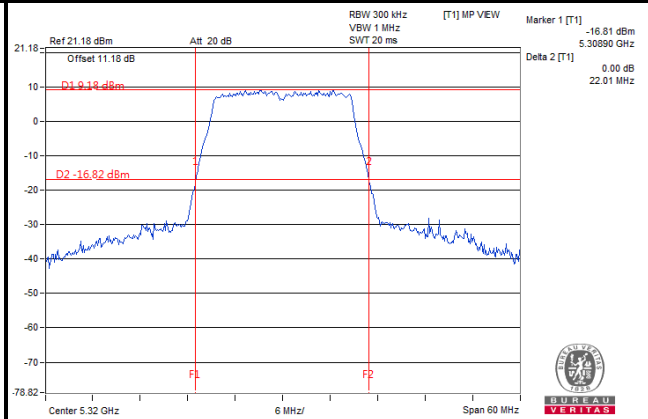

802.11ax (HE40)

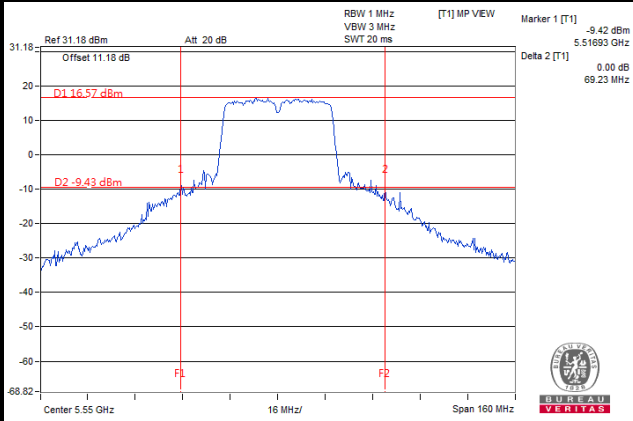

802.11ax (HE80)

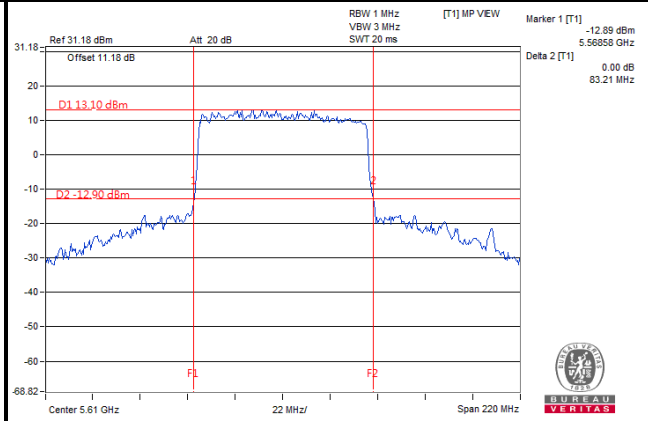

Mode B
802.11a

Channel	Frequency (MHz)	26 dBc Bandwidth (MHz)
52	5260	47.31
60	5300	45.35
64	5320	43.41
100	5500	41.01
116	5580	47.65
140	5700	41.10

802.11ax (HE20)

Channel	Frequency (MHz)	26 dBc Bandwidth (MHz)
52	5260	48.88
60	5300	49.88
64	5320	29.71
100	5500	28.74
116	5580	52.99
140	5700	24.56

802.11ax (HE40)

Channel	Frequency (MHz)	26 dBc Bandwidth (MHz)
54	5270	87.05
62	5310	41.81
102	5510	41.94
110	5550	57.17
134	5670	41.84

802.11ax (HE80)

Channel	Frequency (MHz)	26 dBc Bandwidth (MHz)
58	5290	83.25
106	5530	83.44
122	5610	170.62

Spectrum Plot of Worst Value

802.11a

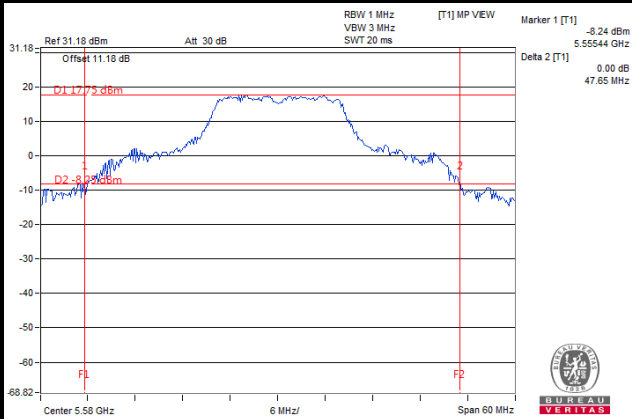

802.11ax (HE20)

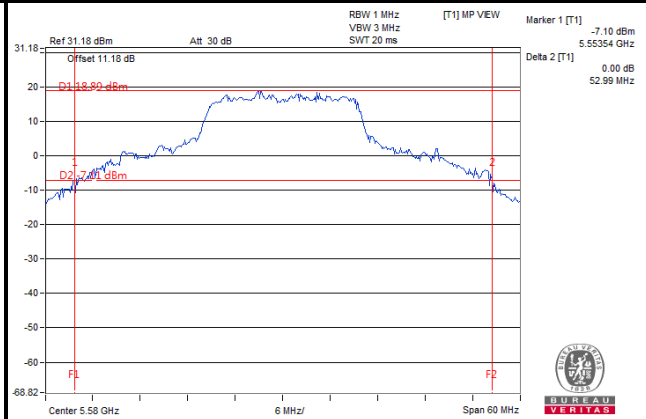

802.11ax (HE40)

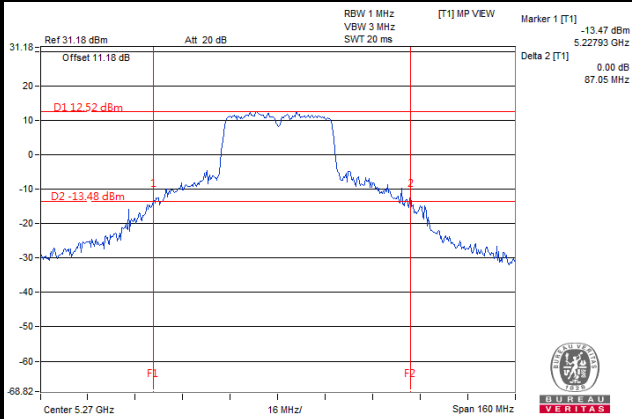

802.11ax (HE80)

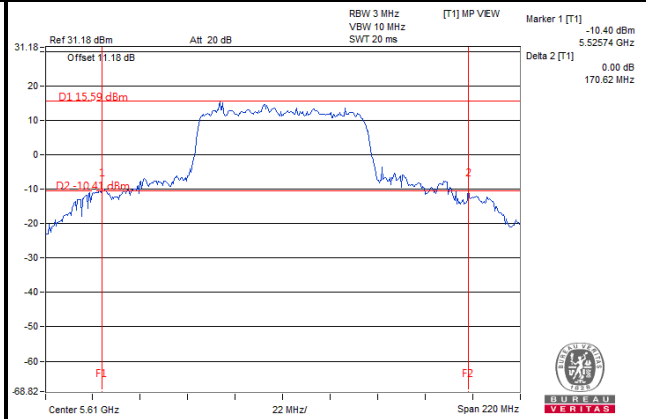

4.4 Occupied Bandwidth Measurement

4.4.1 Test Setup

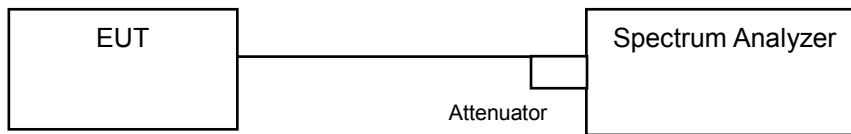

4.4.2 Test Instruments

Refer to section 4.1.2 to get information of above instrument.

4.4.3 Test Procedure

The transmitter output was connected to the spectrum analyzer through an attenuator. The bandwidth of the fundamental frequency was measured by spectrum analyzer with resolution bandwidth in the range of 1 % to 5 % of the anticipated emission bandwidth, and a video bandwidth at least 3x the resolution bandwidth and set the detector to SAMPLE. The width of a frequency band such that, below the lower and above the upper frequency limits, the mean powers emitted are each equal to a specified percentage 0.5 % of the total mean power of a given emission.

4.4.4 Test Results

Mode A

802.11a

Channel	Channel Frequency (MHz)	Occupied Bandwidth (MHz)	
		Chain 0	Chain 1
52	5260	16.92	16.92
60	5300	16.92	16.92
64	5320	16.92	16.92
100	5500	16.92	16.92
116	5580	17.04	16.80
140	5700	17.04	16.92

802.11ax (HE20)

Channel	Channel Frequency (MHz)	Occupied Bandwidth (MHz)	
		Chain 0	Chain 1
52	5260	18.84	18.00
60	5300	19.80	19.08
64	5320	18.12	18.00
100	5500	19.08	18.00
116	5580	18.96	19.20
140	5700	19.08	18.00

802.11ax (HE40)

Channel	Channel Frequency (MHz)	Occupied Bandwidth (MHz)	
		Chain 0	Chain 1
54	5270	38.16	38.16
62	5310	37.92	37.68
102	5510	37.68	37.92
110	5550	36.72	38.16
134	5670	36.48	36.48

802.11ax (HE80)

Channel	Channel Frequency (MHz)	Occupied Bandwidth (MHz)	
		Chain 0	Chain 1
58	5290	77.28	77.28
106	5530	77.28	77.76
122	5610	77.28	77.28

Spectrum Plot of Worst Value

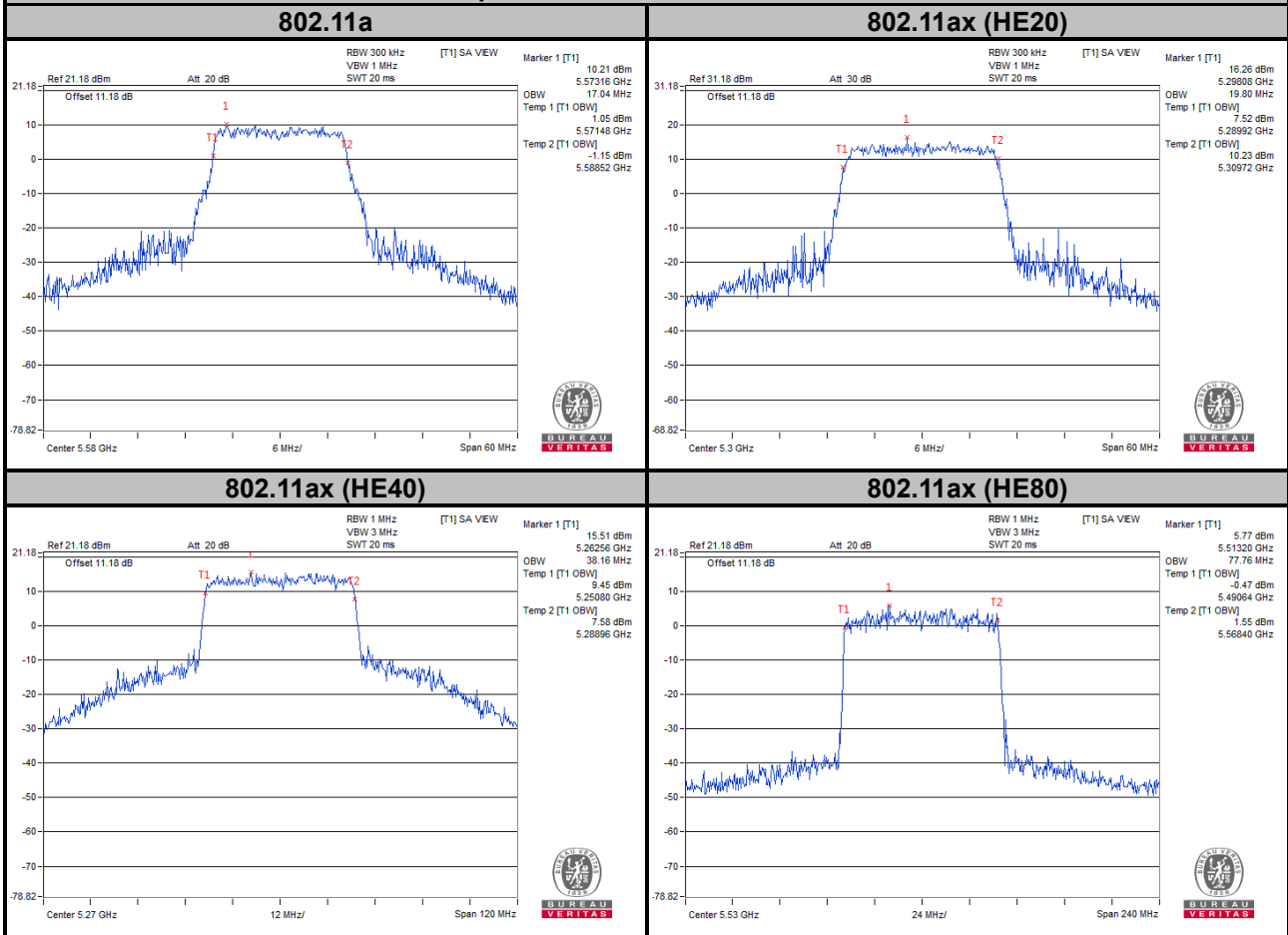

Mode B

802.11a

Channel	Channel Frequency (MHz)	Occupied Bandwidth (MHz)
52	5260	28.68
60	5300	21.96
64	5320	17.52
100	5500	17.04
116	5580	27.96
140	5700	17.16

802.11ax (HE20)

Channel	Channel Frequency (MHz)	Occupied Bandwidth (MHz)
52	5260	30.24
60	5300	24.60
64	5320	19.20
100	5500	18.24
116	5580	31.44
140	5700	19.20

802.11ax (HE40)

Channel	Channel Frequency (MHz)	Occupied Bandwidth (MHz)
54	5270	39.84
62	5310	37.92
102	5510	37.92
110	5550	38.16
134	5670	38.16

802.11ax (HE80)

Channel	Channel Frequency (MHz)	Occupied Bandwidth (MHz)
58	5290	77.28
106	5530	77.28
122	5610	78.24

Spectrum Plot of Worst Value

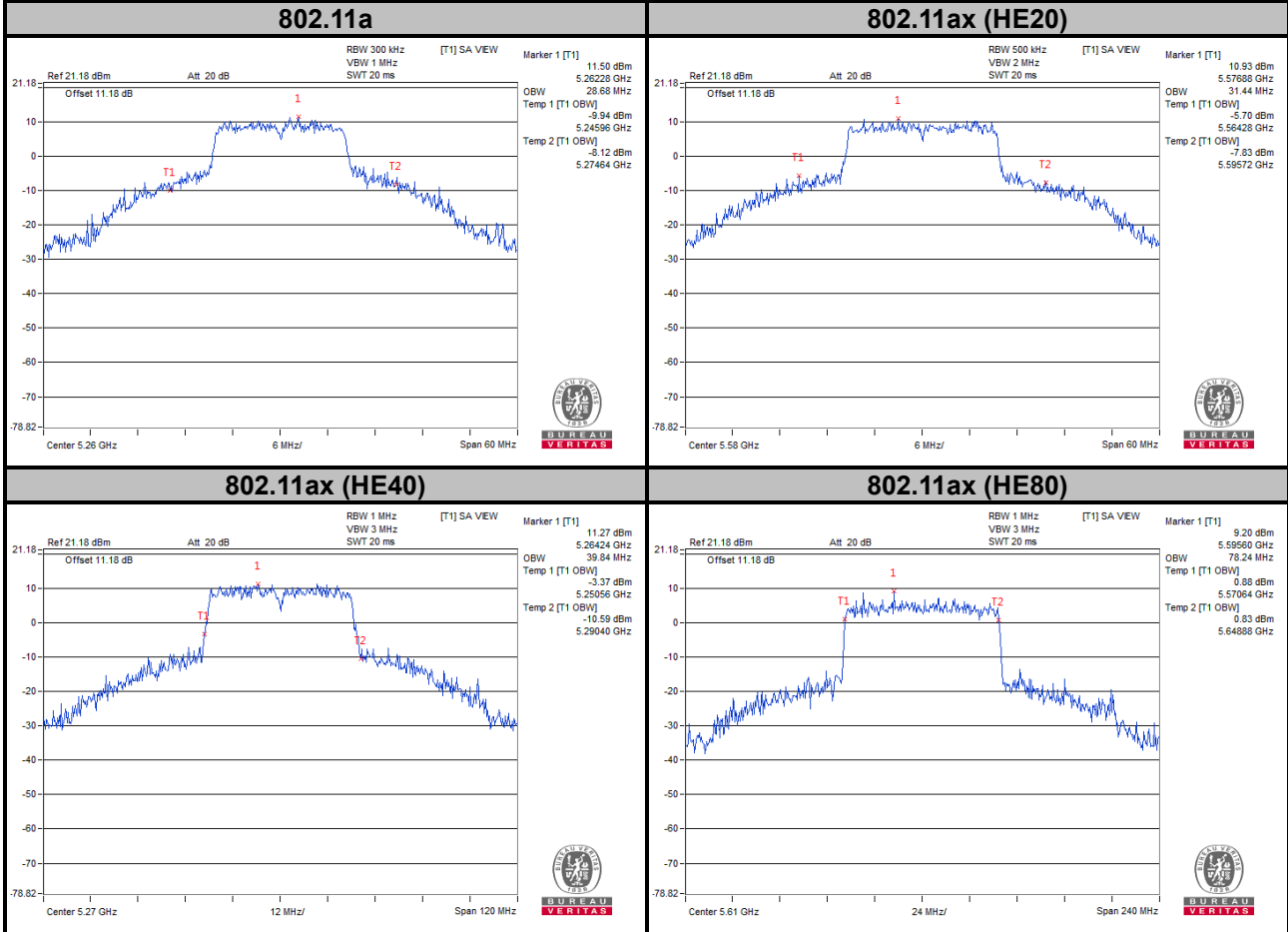

4.5 Peak Power Spectral Density Measurement

4.5.1 Limits of Peak Power Spectral Density Measurement

Operation Band	EUT Category		Limit
U-NII-1		Outdoor Access Point	17 dBm/MHz
		Fixed point-to-point Access Point	
		Indoor Access Point	
		Mobile and Portable client device	11 dBm/MHz
U-NII-2A	√		11 dBm/MHz
U-NII-2C	√		11 dBm/MHz
U-NII-3			30 dBm/500 kHz

4.5.2 Test Setup

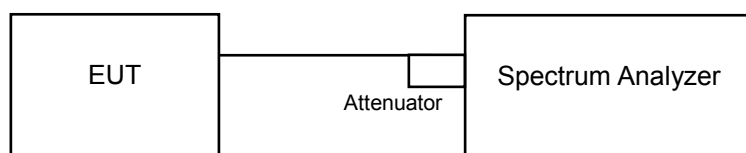

4.5.3 Test Instruments

Refer to section 4.1.2 to get information of above instrument.

4.5.4 Test Procedures

For U-NII-2A, U-NII-2C band:

Using method SA-2

1. Set span to encompass the entire emission bandwidth (EBW) of the signal.
2. Set RBW = 1 MHz, Set VBW ≥ 3 RBW, Detector = RMS
3. Sweep time = auto, trigger set to "free run".
4. Trace average at least 100 traces in power averaging mode.
5. Record the max value and add 10 log (1/duty cycle)

4.5.5 Deviation from Test Standard

No deviation.

4.5.6 EUT Operating Conditions

The software provided by client to enable the EUT under transmission condition continuously at lowest, middle and highest channel frequencies individually.

4.5.7 Test Results

For U-NII-2A, U-NII-2C Band

CDD Mode

Mode A

802.11a

Channel	Frequency (MHz)	PSD (dBm/MHz)		Duty Factor (dB)	Total PSD with Duty Factor (dBm/MHz)	Max. Limit (dBm/MHz)	Pass / Fail
		Chain 0	Chain 1				
52	5260	4.74	5.01	0.22	8.11	8.39	Pass
60	5300	4.44	4.93	0.22	7.92	8.39	Pass
64	5320	4.26	4.13	0.22	7.43	8.39	Pass
100	5500	3.65	3.21	0.22	6.67	8.39	Pass
116	5580	4.54	4.61	0.22	7.81	8.39	Pass
140	5700	1.76	1.01	0.22	4.63	8.39	Pass

Note:

- Method E) 2) a) of power density measurement of KDB 662911 is using for calculating total power density. Total power density is summing entire spectra across corresponding frequency bins on the various outputs by computer.
- For U-NII-2A, U-NII-2C Band:**
 $\text{Directional gain} = 10\log[(10^{G1/20} + 10^{G2/20} + \dots + 10^{GN/20})^2 / \text{NANT}] = 8.61 \text{ dBi} > 6 \text{ dBi}$, so the power density limit shall be reduced to $11 - (8.61 - 6) = 8.39 \text{ dBm}$.
- Refer to section 3.3 for duty cycle spectrum plot.

802.11ax (HE20)

Channel	Frequency (MHz)	PSD (dBm/MHz)		Duty Factor (dB)	Total PSD with Duty Factor (dBm/MHz)	Max. Limit (dBm/MHz)	Pass / Fail
		Chain 0	Chain 1				
52	5260	4.51	4.63	0.10	7.68	8.39	Pass
60	5300	4.73	4.63	0.10	7.79	8.39	Pass
64	5320	3.91	3.81	0.10	6.97	8.39	Pass
100	5500	2.72	3.22	0.10	6.09	8.39	Pass
116	5580	4.78	4.68	0.10	7.84	8.39	Pass
140	5700	-1.26	-1.21	0.10	1.88	8.39	Pass

Note:

- Method E) 2) a) of power density measurement of KDB 662911 is using for calculating total power density. Total power density is summing entire spectra across corresponding frequency bins on the various outputs by computer.
- For U-NII-2A, U-NII-2C Band:**
 $\text{Directional gain} = 10\log[(10^{G1/20} + 10^{G2/20} + \dots + 10^{GN/20})^2 / \text{NANT}] = 8.61 \text{ dBi} > 6 \text{ dBi}$, so the power density limit shall be reduced to $11 - (8.61 - 6) = 8.39 \text{ dBm}$.
- Refer to section 3.3 for duty cycle spectrum plot.

802.11ax (HE40)

Channel	Frequency (MHz)	PSD (dBm/MHz)		Duty Factor (dB)	Total PSD with Duty Factor (dBm/MHz)	Max. Limit (dBm/MHz)	Pass / Fail
		Chain 0	Chain 1				
54	5270	4.92	4.57	0.21	7.97	8.39	Pass
62	5310	-1.52	-1.43	0.21	1.75	8.39	Pass
102	5510	-0.36	0.25	0.21	3.18	8.39	Pass
110	5550	4.56	4.44	0.21	7.72	8.39	Pass
134	5670	0.18	0.32	0.21	3.47	8.39	Pass

Note:

- Method E) 2) a) of power density measurement of KDB 662911 is using for calculating total power density. Total power density is summing entire spectra across corresponding frequency bins on the various outputs by computer.
- For U-NII-2A, U-NII-2C Band:**
Directional gain = $10\log[(10^{G1/20} + 10^{G2/20} + \dots + 10^{GN/20})^2 / NANT]$ = 8.61 dBi > 6 dBi , so the power density limit shall be reduced to $11-(8.61-6) = 8.39$ dBm.
- Refer to section 3.3 for duty cycle spectrum plot.

802.11ax (HE80)

Channel	Frequency (MHz)	PSD (dBm/MHz)		Duty Factor (dB)	Total PSD with Duty Factor (dBm/MHz)	Max. Limit (dBm/MHz)	Pass / Fail
		Chain 0	Chain 1				
58	5290	-4.30	-4.39	0.35	-0.98	8.39	Pass
106	5530	-3.89	-4.31	0.35	-0.73	8.39	Pass
122	5610	-6.43	-6.02	0.35	-2.86	8.39	Pass

Note:

- Method E) 2) a) of power density measurement of KDB 662911 is using for calculating total power density. Total power density is summing entire spectra across corresponding frequency bins on the various outputs by computer.
- For U-NII-2A, U-NII-2C Band:**
Directional gain = $10\log[(10^{G1/20} + 10^{G2/20} + \dots + 10^{GN/20})^2 / NANT]$ = 8.61 dBi > 6 dBi , so the power density limit shall be reduced to $11-(8.61-6) = 8.39$ dBm.
- Refer to section 3.3 for duty cycle spectrum plot.

Spectrum Plot of Worst Value

802.11a

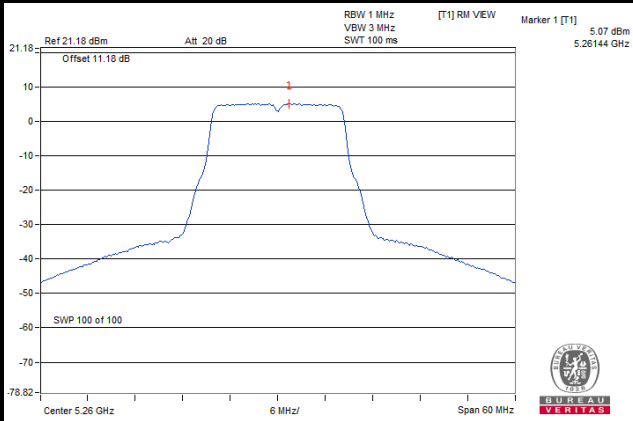

802.11ax (HE20)

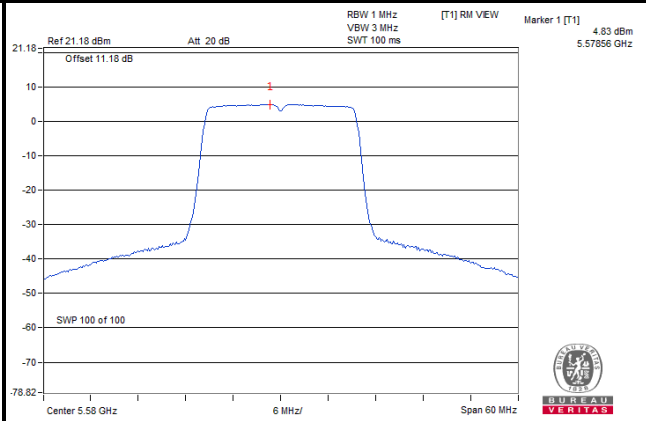

802.11ax (HE40)

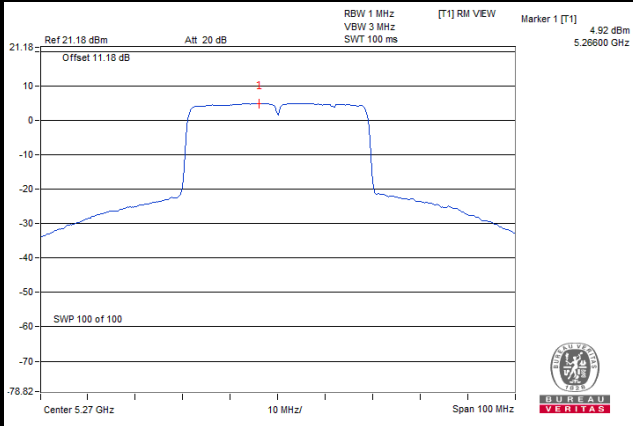

802.11ax (HE80)

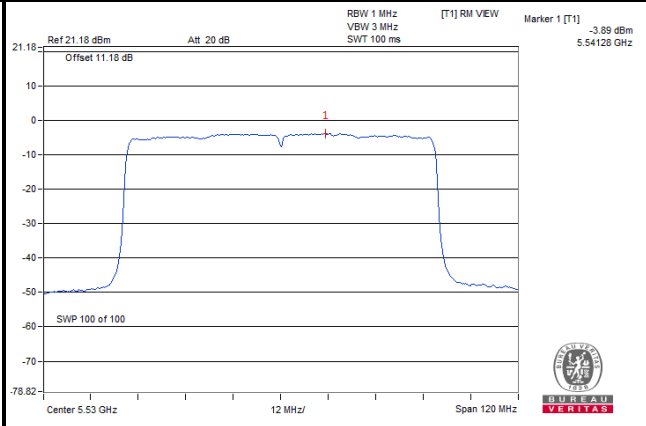

Mode B

802.11a

Channel	Frequency (MHz)	PSD w/o Duty Factor (dBm/MHz)	Duty Factor (dB)	PSD with Duty Factor (dBm/MHz)	Maximum Limit (dBm/MHz)	Pass / Fail
52	5260	5.95	0.22	6.17	11	Pass
60	5300	5.04	0.22	5.26	11	Pass
64	5320	3.27	0.22	3.49	11	Pass
100	5500	2.34	0.22	2.56	11	Pass
116	5580	5.86	0.22	6.08	11	Pass
140	5700	2.55	0.22	2.77	11	Pass

Note: Refer to section 3.3 for duty cycle spectrum plot.

802.11ax (HE20)

Channel	Frequency (MHz)	PSD w/o Duty Factor (dBm/MHz)	Duty Factor (dB)	PSD with Duty Factor (dBm/MHz)	Maximum Limit (dBm/MHz)	Pass / Fail
52	5260	5.92	0.10	6.02	11	Pass
60	5300	4.94	0.10	5.04	11	Pass
64	5320	2.18	0.10	2.28	11	Pass
100	5500	2.15	0.10	2.25	11	Pass
116	5580	5.42	0.10	5.52	11	Pass
140	5700	0.22	0.10	0.32	11	Pass

Note: Refer to section 3.3 for duty cycle spectrum plot.

802.11ax (HE40)

Channel	Frequency (MHz)	PSD w/o Duty Factor (dBm/MHz)	Duty Factor (dB)	PSD with Duty Factor (dBm/MHz)	Maximum Limit (dBm/MHz)	Pass / Fail
54	5270	1.08	0.18	1.26	11	Pass
62	5310	-3.88	0.18	-3.70	11	Pass
102	5510	-3.68	0.18	-3.50	11	Pass
110	5550	-1.15	0.18	-0.97	11	Pass
134	5670	-3.40	0.18	-3.22	11	Pass

Note: Refer to section 3.3 for duty cycle spectrum plot.

802.11ax (HE80)

Channel	Frequency (MHz)	PSD w/o Duty Factor (dBm/MHz)	Duty Factor (dB)	PSD with Duty Factor (dBm/MHz)	Maximum Limit (dBm/MHz)	Pass / Fail
58	5290	-7.49	0.37	-7.12	11	Pass
106	5530	-6.78	0.37	-6.41	11	Pass
122	5610	-3.11	0.37	-2.74	11	Pass

Note: Refer to section 3.3 for duty cycle spectrum plot.

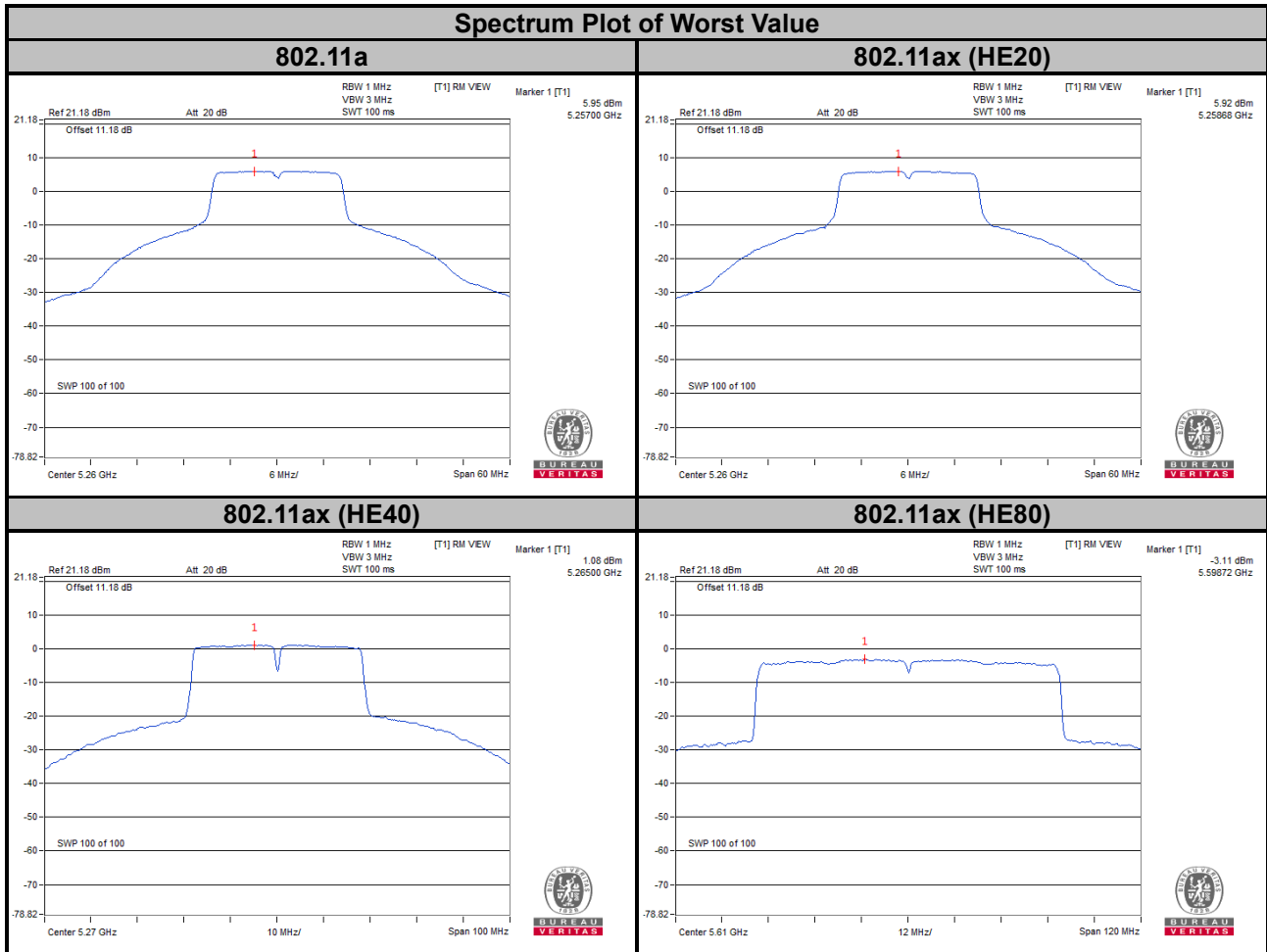

4.6 Frequency Stability

4.6.1 Limit of Frequency Stability Measurement

The frequency of the carrier signal shall be maintained within band of operation.

4.6.2 Test Setup

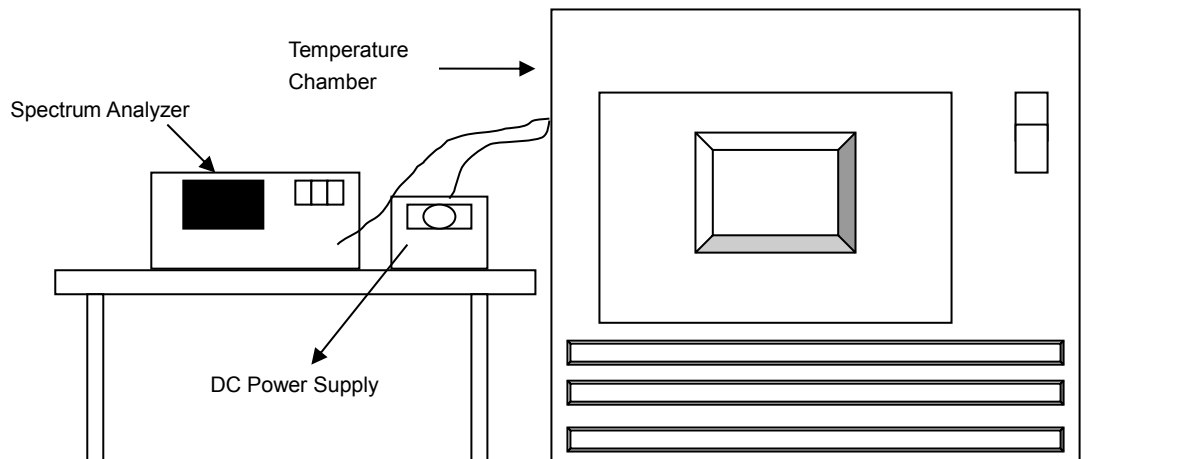

4.6.3 Test Instruments

Refer to section 4.1.2 to get information of above instrument.

4.6.4 Test Procedure

- The EUT was placed inside the environmental test chamber and powered by nominal DC voltage.
- Turn the EUT on and couple its output to a spectrum analyzer.
- Turn the EUT off and set the chamber to the highest temperature specified.
- Allow sufficient time (approximately 30 min) for the temperature of the chamber to stabilize, turn the EUT on and measure the operating frequency after 2, 5, and 10 Minutes.
- Repeat step (d) with the temperature chamber set to the next desired temperature until measurements down to the lowest specified temperature have been completed.
- The test chamber was allowed to stabilize at +20 degree C for a minimum of 30 Minutes. The supply voltage was then adjusted on the EUT from 85% to 115% and the frequency record.

4.6.5 Deviation from Test Standard

No deviation.

4.6.6 EUT Operating Condition

Set the EUT transmit at un-modulation mode to test frequency stability.

4.6.7 Test Results

Mode A

Frequency Stability Versus Temp.									
Operating Frequency: 5180 MHz									
Temp. (°C)	Power Supply (Vdc)	0 Minute		2 Minute		5 Minute		10 Minute	
		Measured Frequency (MHz)	Result	Measured Frequency (MHz)	Result	Measured Frequency (MHz)	Result	Measured Frequency (MHz)	Result
40	55	5180.0112	PASS	5180.0129	PASS	5180.0121	PASS	5180.0152	PASS
30	55	5180.0065	PASS	5180.0077	PASS	5180.011	PASS	5180.0065	PASS
20	55	5180.0095	PASS	5180.0111	PASS	5180.013	PASS	5180.0093	PASS
10	55	5180.0047	PASS	5180.005	PASS	5180.0011	PASS	5180.003	PASS
0	55	5180.0172	PASS	5180.0147	PASS	5180.0189	PASS	5180.0139	PASS
-5	55	5179.9922	PASS	5179.9968	PASS	5179.9918	PASS	5179.9957	PASS

Frequency Stability Versus Voltage									
Operating Frequency: 5180 MHz									
Temp. (°C)	Power Supply (Vdc)	0 Minute		2 Minute		5 Minute		10 Minute	
		Measured Frequency (MHz)	Result	Measured Frequency (MHz)	Result	Measured Frequency (MHz)	Result	Measured Frequency (MHz)	Result
20	63.25	5180.0087	PASS	5180.0111	PASS	5180.0128	PASS	5180.0096	PASS
	55	5180.0095	PASS	5180.0111	PASS	5180.013	PASS	5180.0093	PASS
	46.75	5180.0101	PASS	5180.0102	PASS	5180.013	PASS	5180.01	PASS

Mode B

Frequency Stability Versus Temp.									
Operating Frequency: 5180 MHz									
Temp. (°C)	Power Supply (Vdc)	0 Minute		2 Minute		5 Minute		10 Minute	
		Measured Frequency (MHz)	Result	Measured Frequency (MHz)	Result	Measured Frequency (MHz)	Result	Measured Frequency (MHz)	Result
40	55	5189.9764	PASS	5189.9752	PASS	5189.9737	PASS	5189.976	PASS
30	55	5190.0126	PASS	5190.013	PASS	5190.0103	PASS	5190.0119	PASS
20	55	5189.9963	PASS	5189.9985	PASS	5189.9969	PASS	5189.9982	PASS
10	55	5189.9838	PASS	5189.9806	PASS	5189.9817	PASS	5189.9799	PASS
0	55	5189.9769	PASS	5189.9752	PASS	5189.9728	PASS	5189.9744	PASS
-5	55	5190.0035	PASS	5190.0049	PASS	5190.0012	PASS	5190.0049	PASS

Frequency Stability Versus Voltage									
Operating Frequency: 5180 MHz									
Temp. (°C)	Power Supply (Vdc)	0 Minute		2 Minute		5 Minute		10 Minute	
		Measured Frequency (MHz)	Result	Measured Frequency (MHz)	Result	Measured Frequency (MHz)	Result	Measured Frequency (MHz)	Result
20	63.25	5189.9956	PASS	5189.9993	PASS	5189.9978	PASS	5189.9987	PASS
	55	5189.9963	PASS	5189.9985	PASS	5189.9969	PASS	5189.9982	PASS
	46.75	5189.9972	PASS	5189.9982	PASS	5189.9969	PASS	5189.9979	PASS

5 Pictures of Test Arrangements

Please refer to the attached file (Test Setup Photo).

Annex A- Band-edge measurement (For U-NII-2A, U-NII-2C band)

Mode A
802.11a

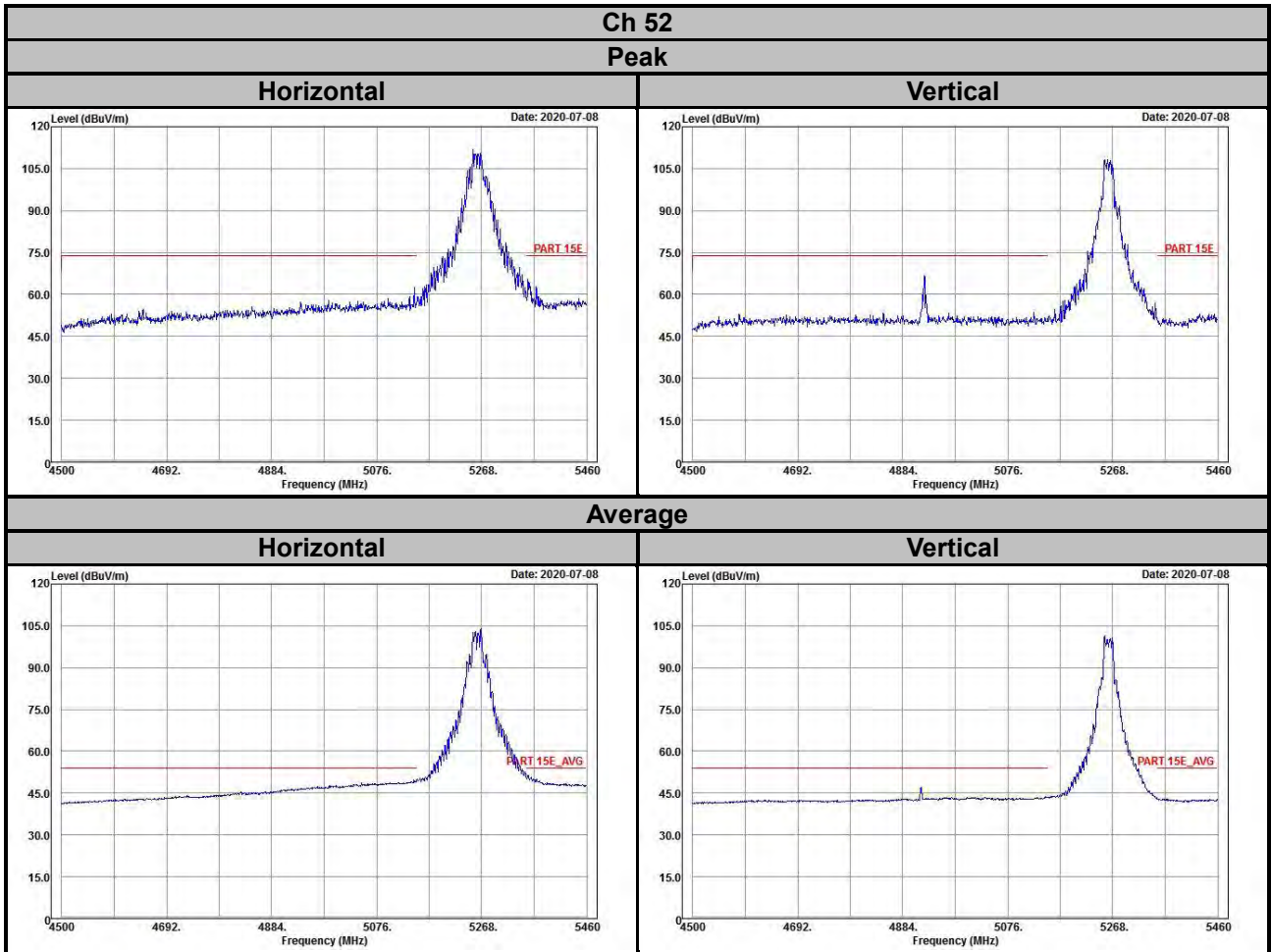

Ch 60
Peak

Horizontal

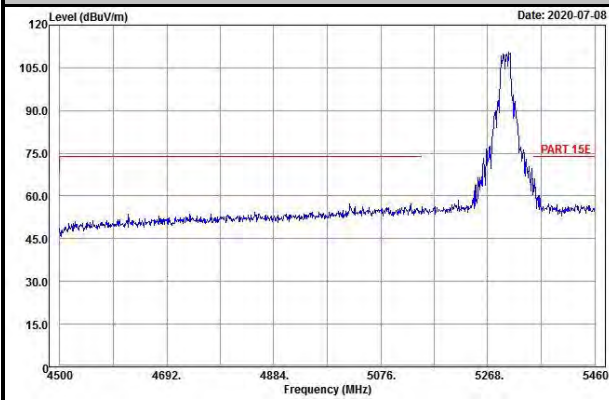

Vertical

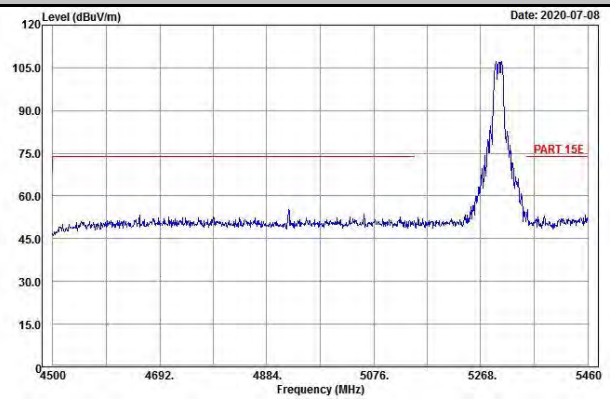

Average

Horizontal

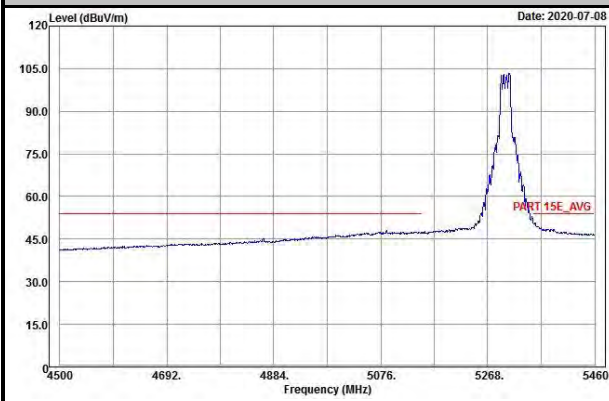

Vertical

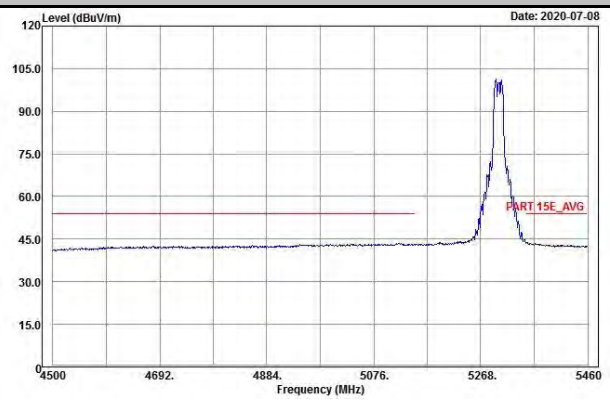

Ch 64
Peak

Horizontal

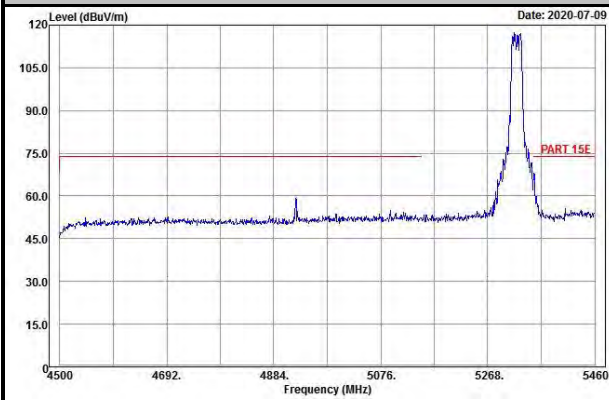

Vertical

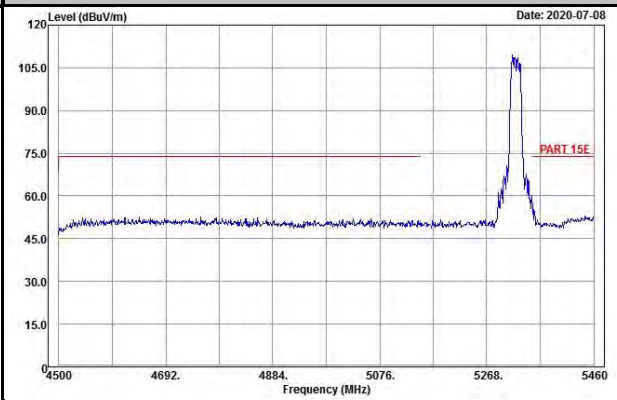

Average

Horizontal

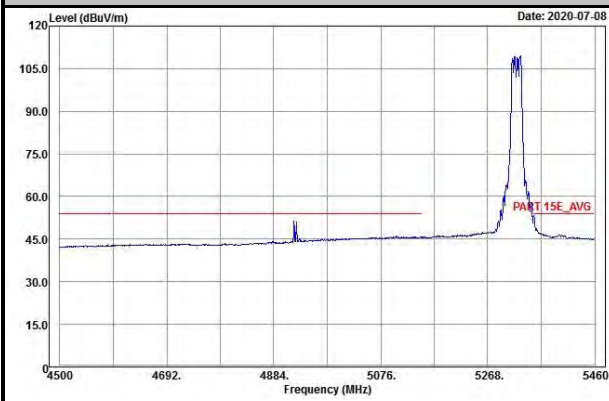

Vertical

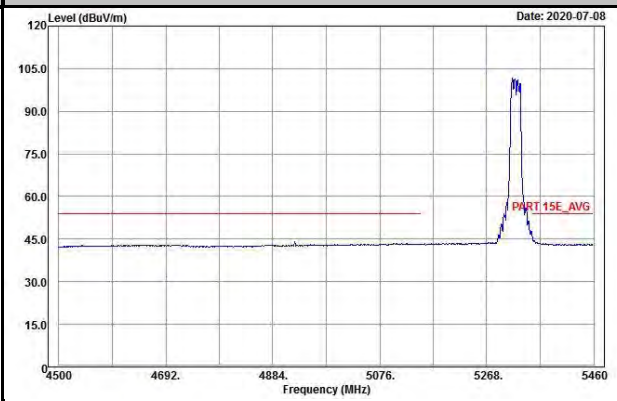

Ch 100

Peak

Horizontal

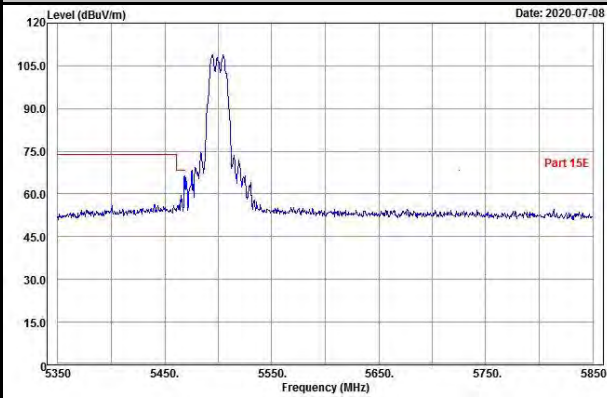

Vertical

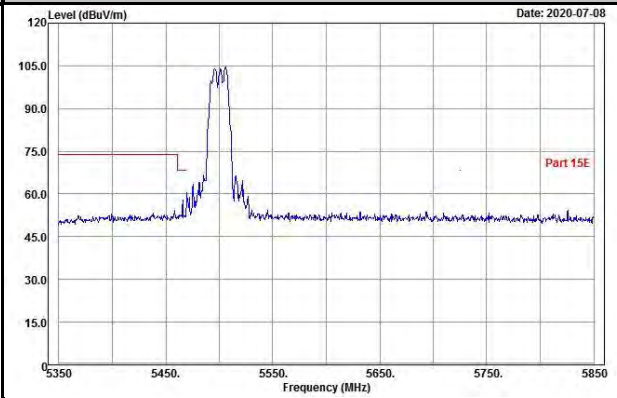

Average

Horizontal

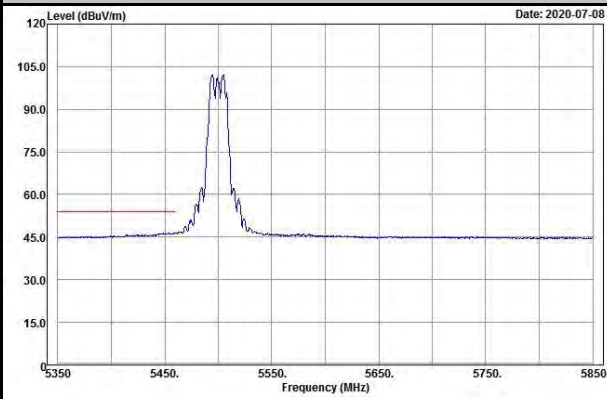

Vertical

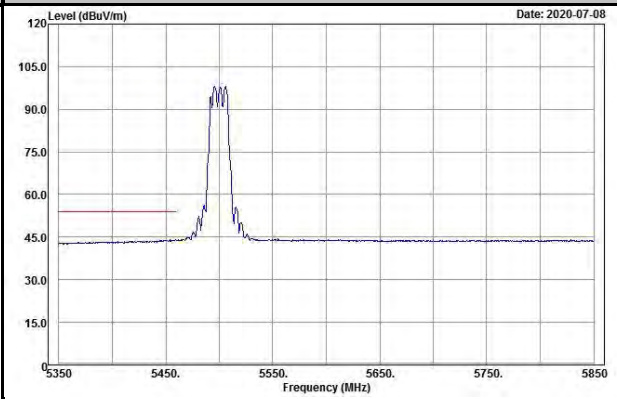

Ch 116

Peak

Horizontal

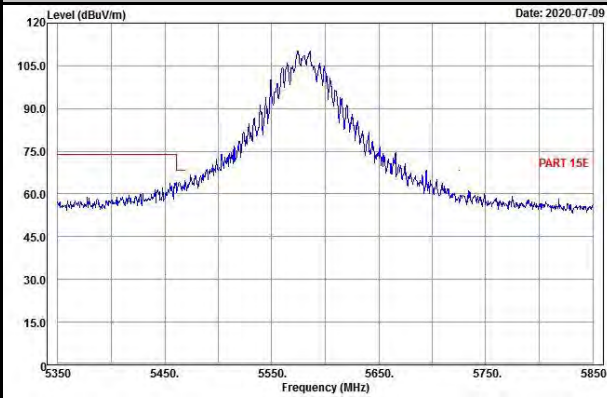

Vertical

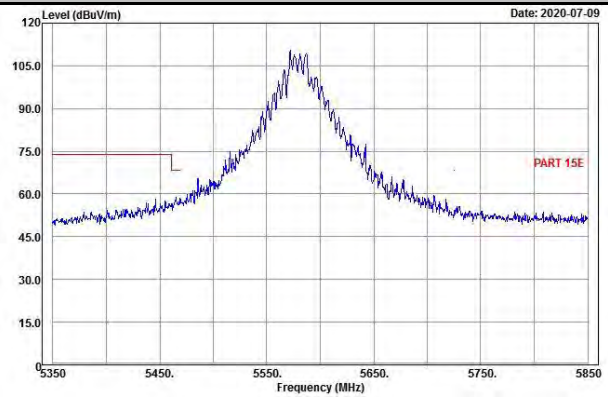

Average

Horizontal

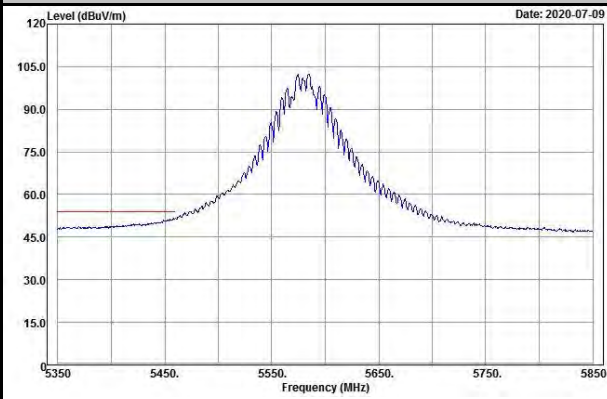

Vertical

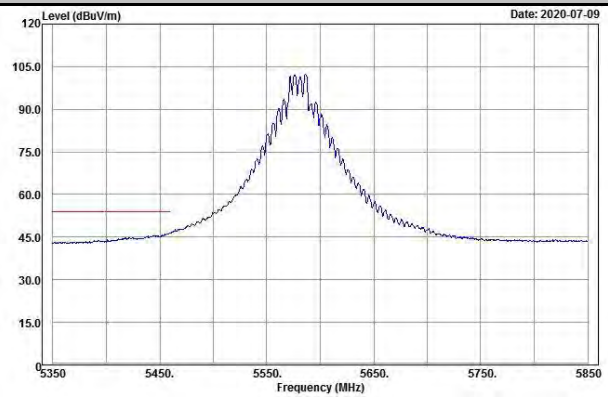

Ch 140

Peak

Horizontal

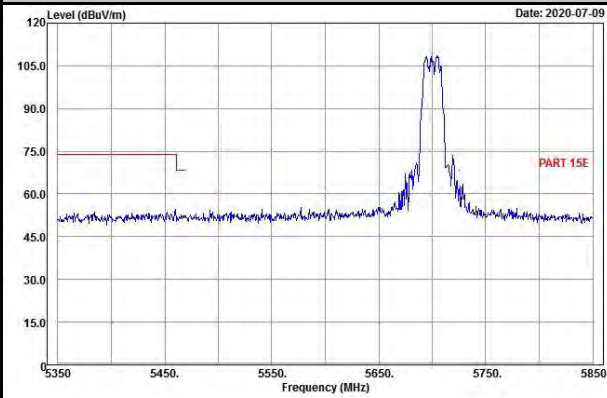

Vertical

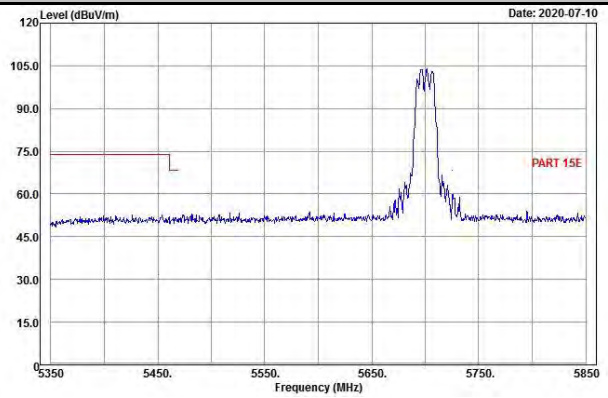

Average

Horizontal

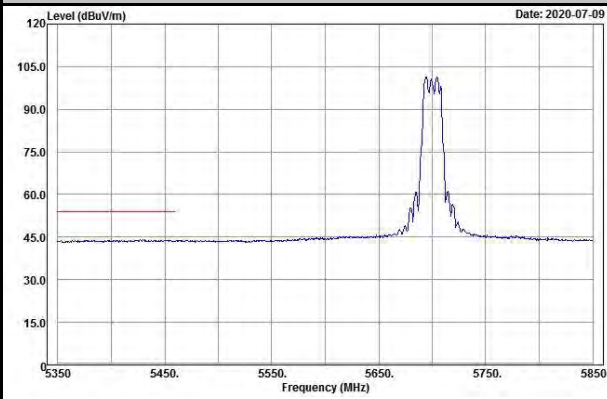

Vertical

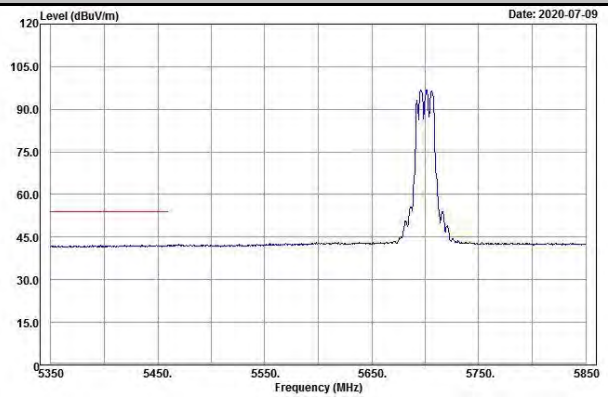

802.11ax (HE20)

Ch 52

Peak

Horizontal

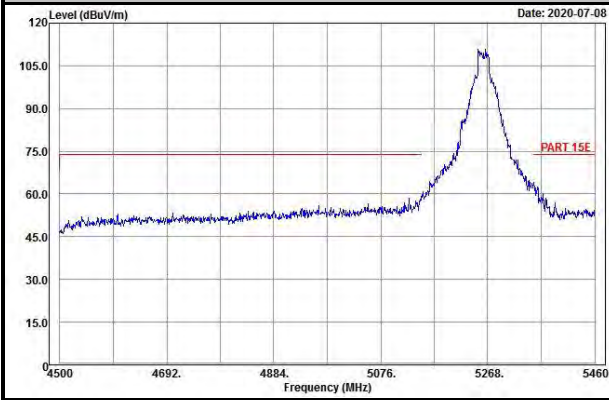

Vertical

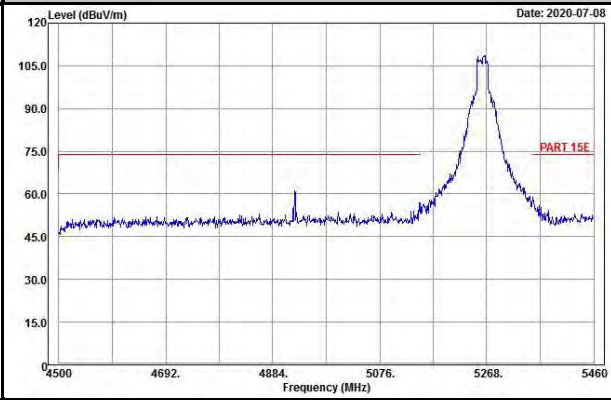

Average

Horizontal

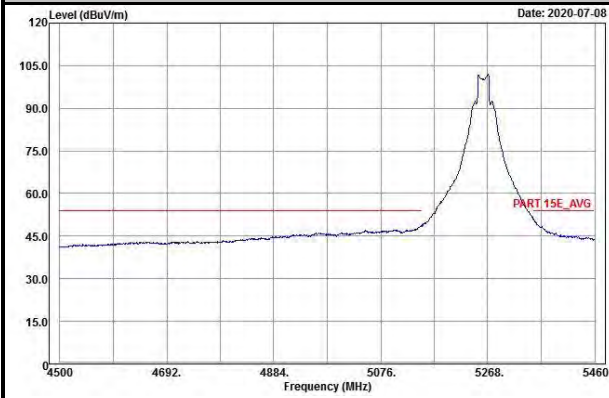

Vertical

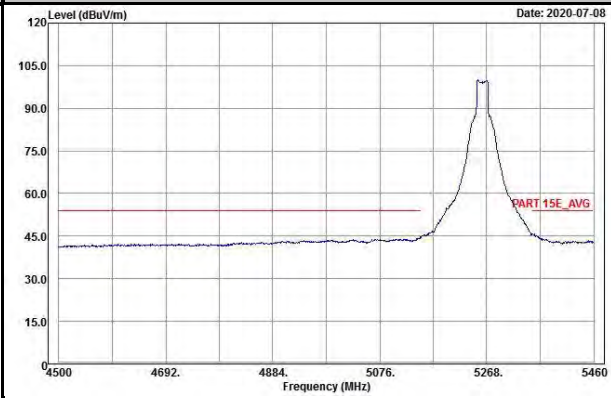

Ch 60
Peak

Horizontal

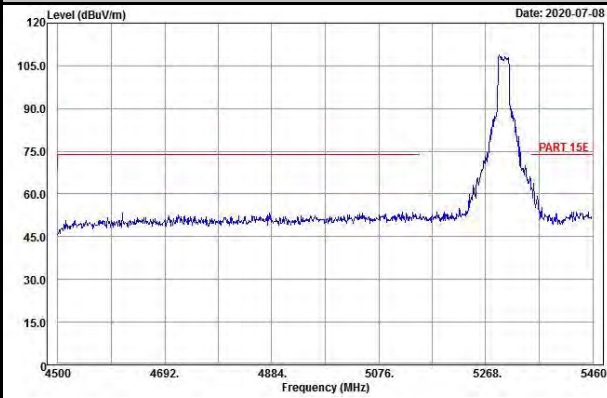

Vertical

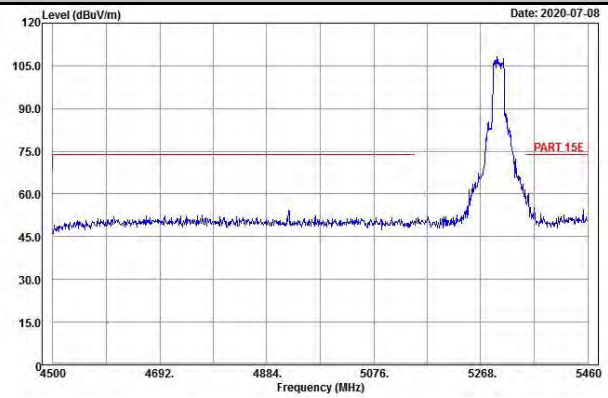

Average

Horizontal

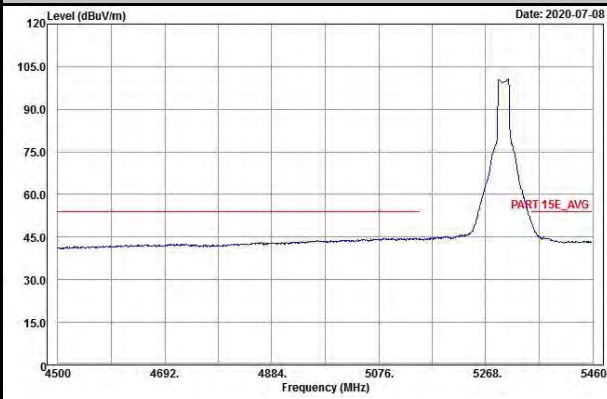

Vertical

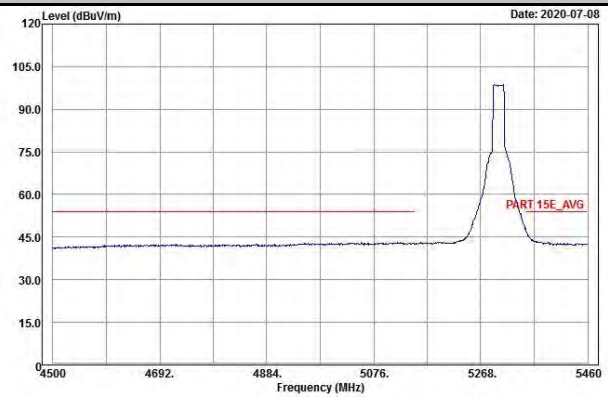

Ch 64
Peak

Horizontal

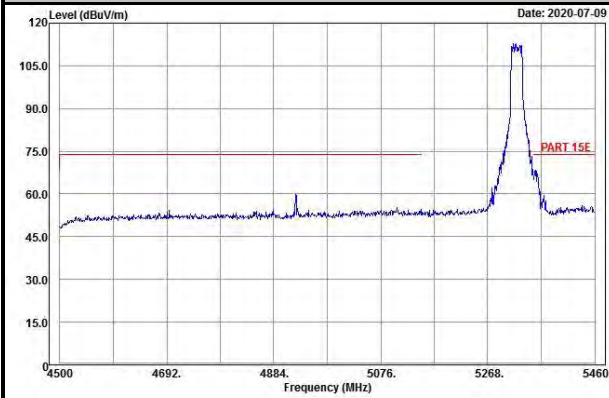

Vertical

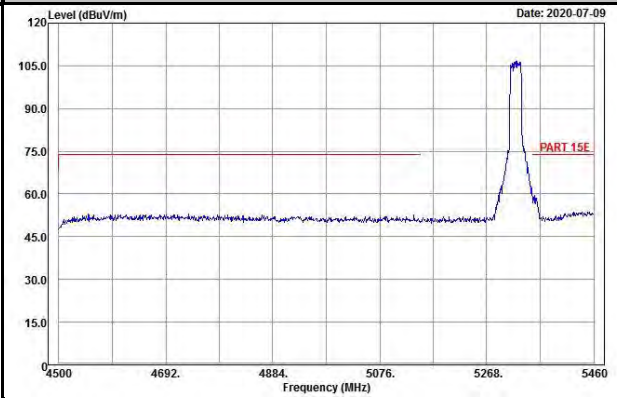

Average

Horizontal

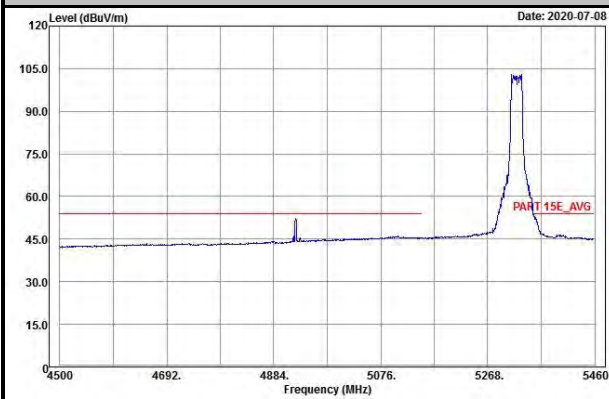

Vertical

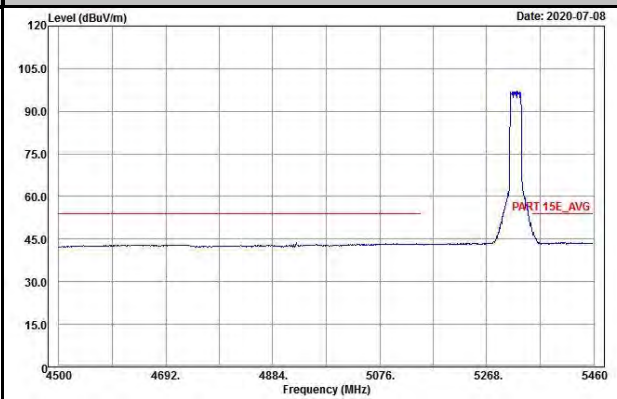

Ch 100

Peak

Horizontal

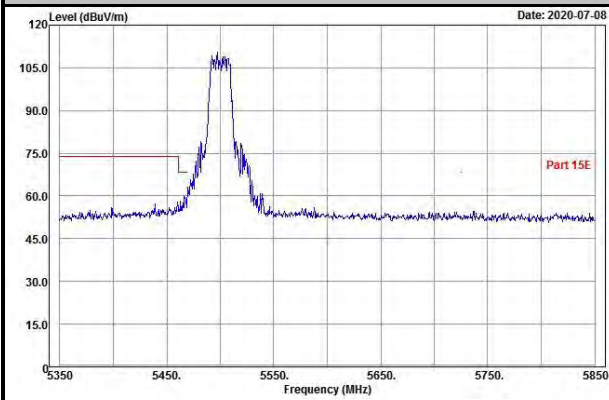

Vertical

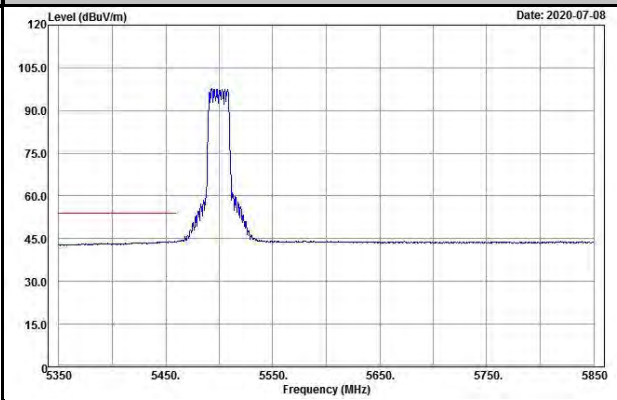

Average

Horizontal

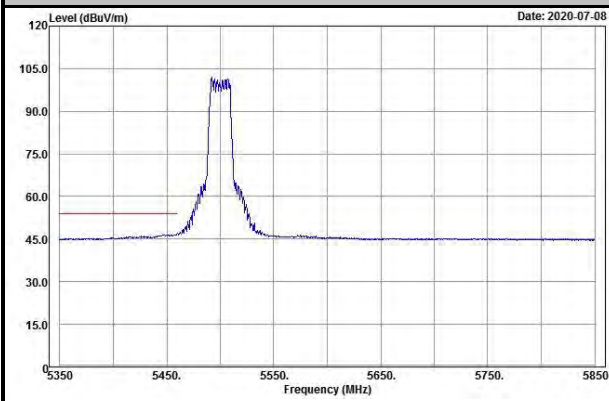

Vertical

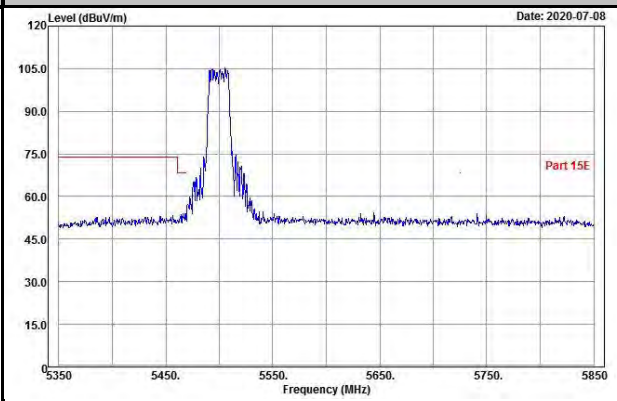

Ch 116

Peak

Horizontal

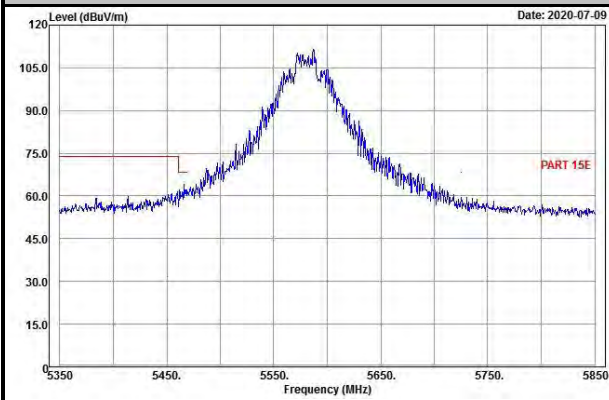

Vertical

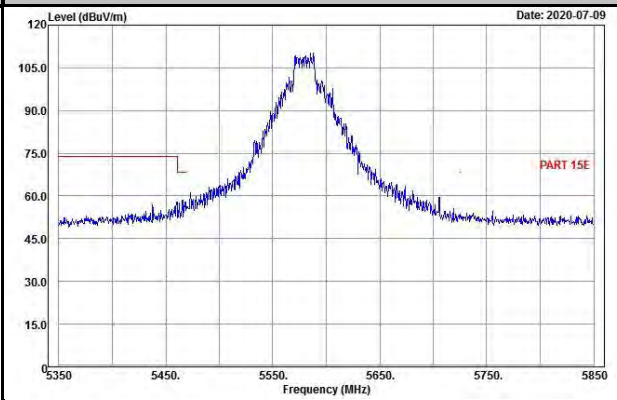

Average

Horizontal

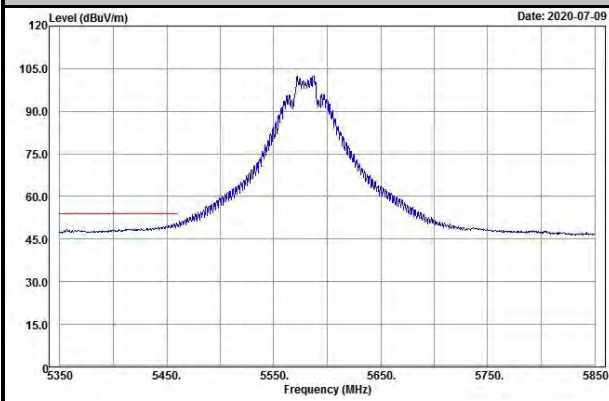

Vertical

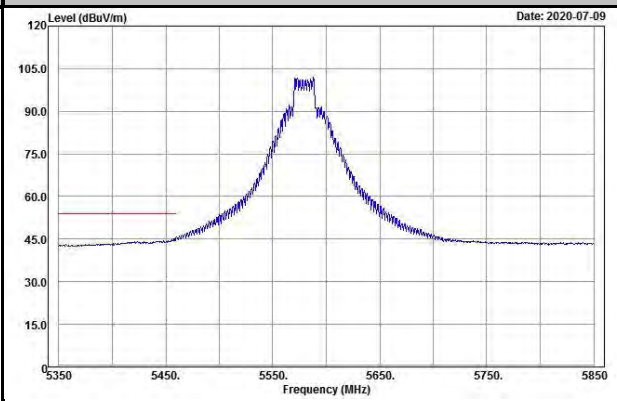

Ch 140

Peak

Horizontal

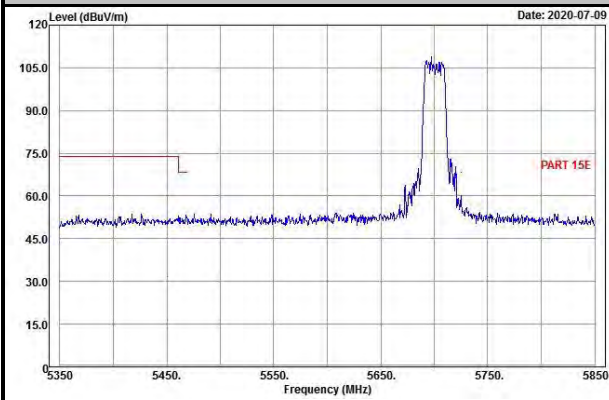

Vertical

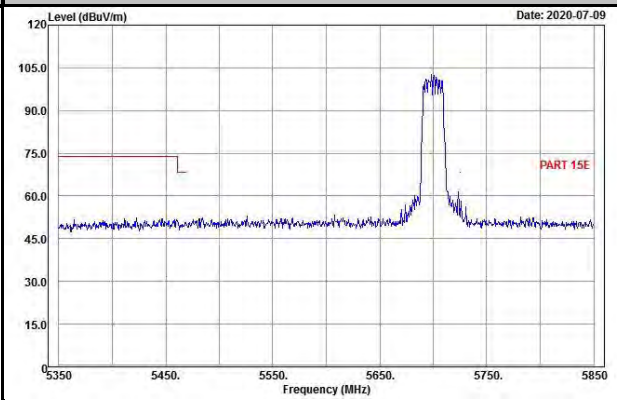

Average

Horizontal

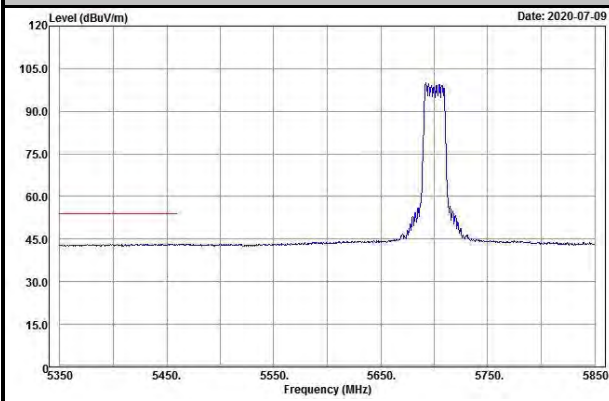

Vertical

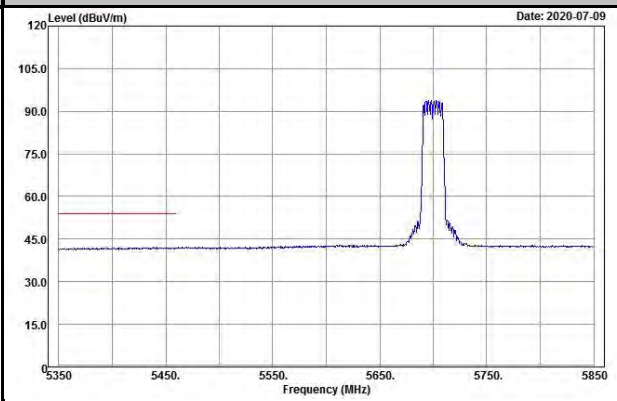

802.11ax (HE40)

Ch 54

Peak

Horizontal

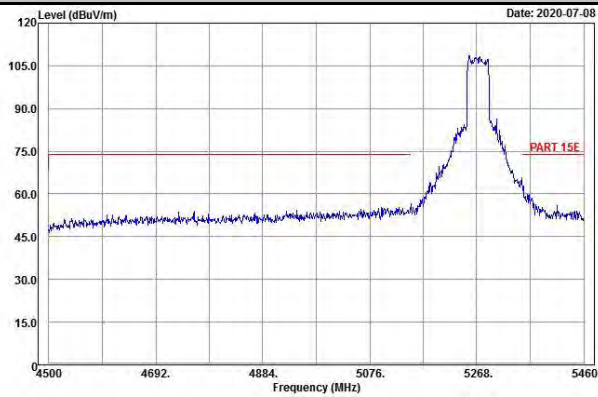

Vertical

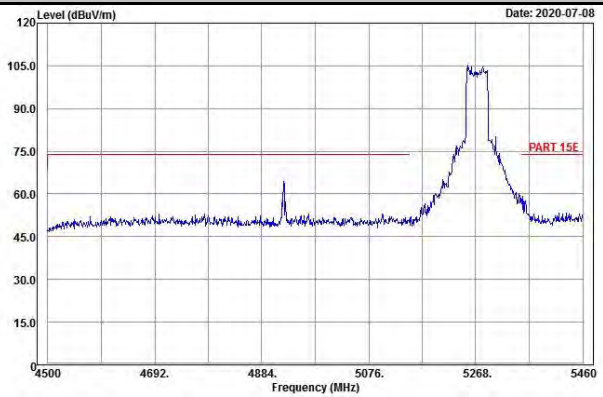

Average

Horizontal

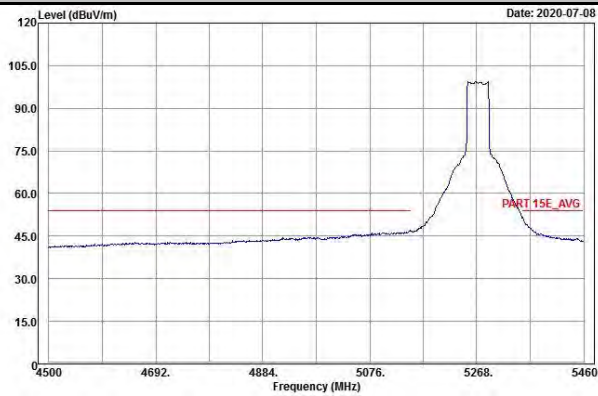

Vertical

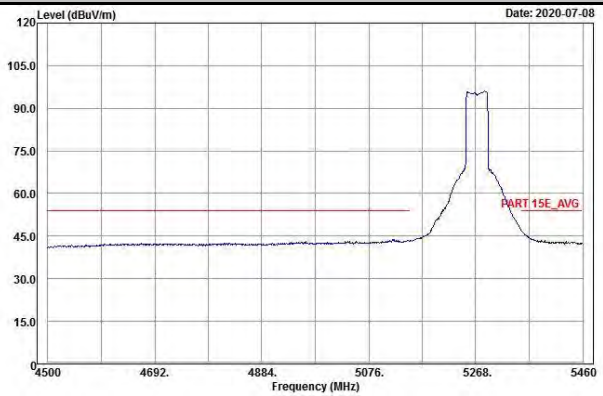

Ch 62
Peak

Horizontal

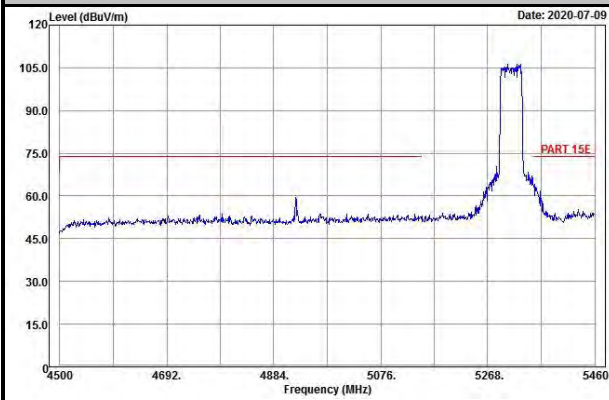

Vertical

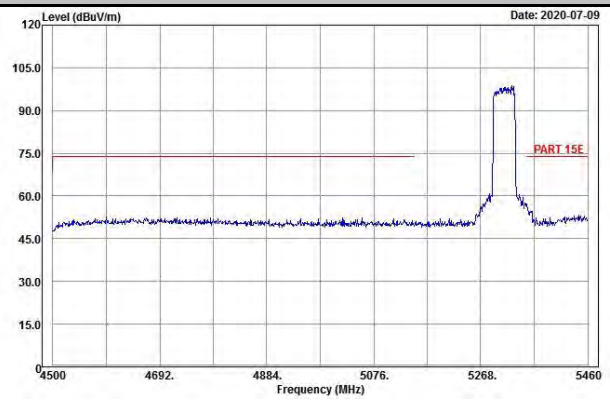

Average

Horizontal

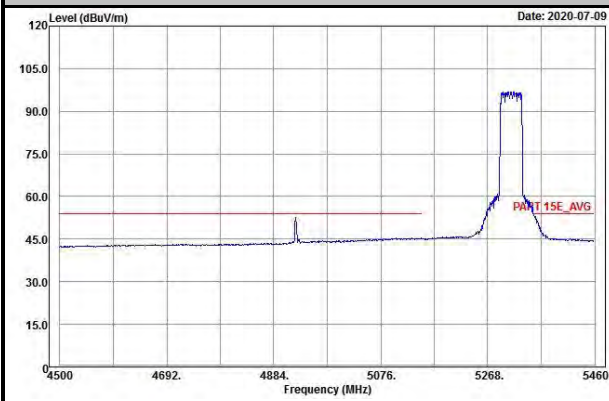

Vertical

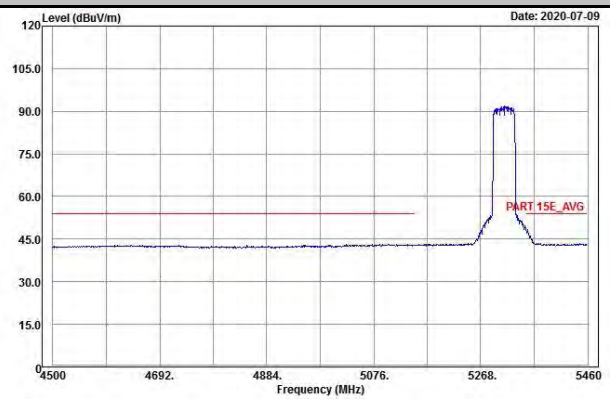

Ch 102

Peak

Horizontal

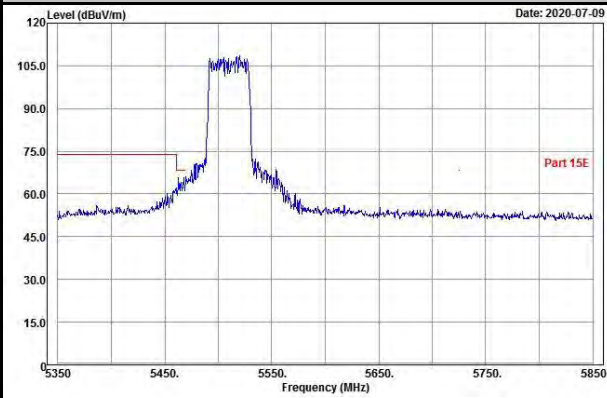

Vertical

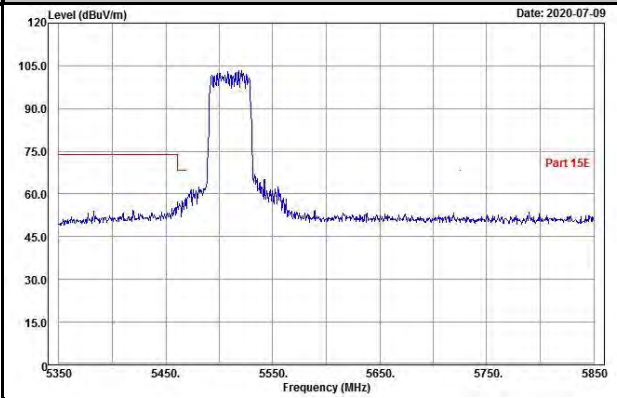

Average

Horizontal

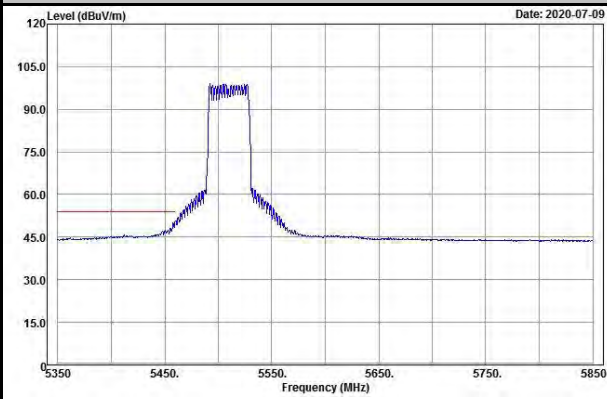

Vertical

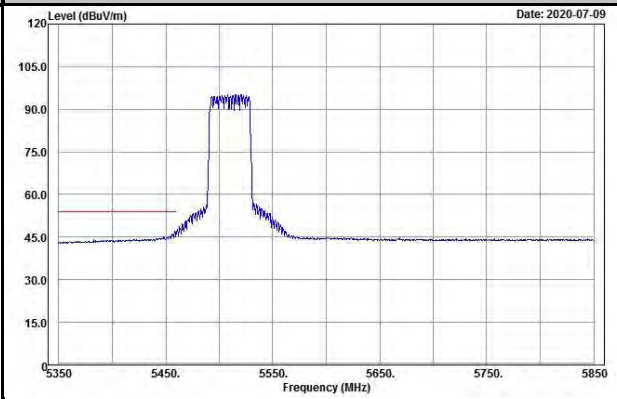

Ch 110

Peak

Horizontal

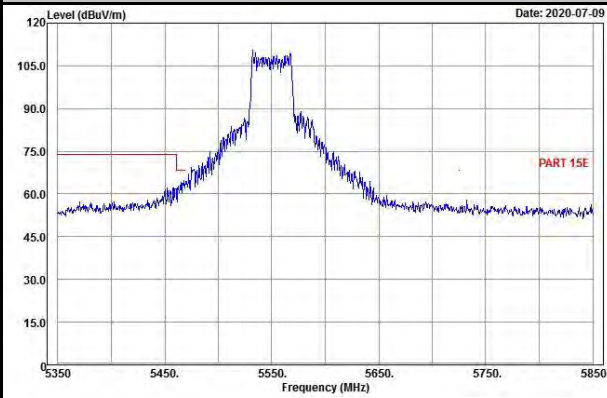

Vertical

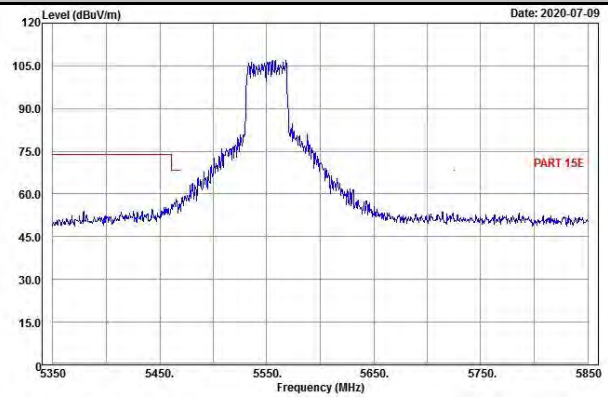

Average

Horizontal

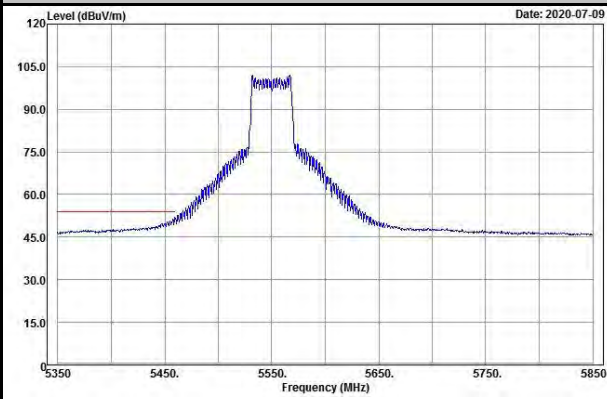

Vertical

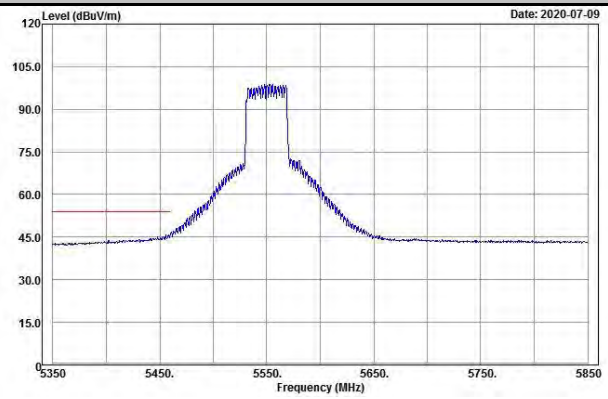

Ch 134

Peak

Horizontal

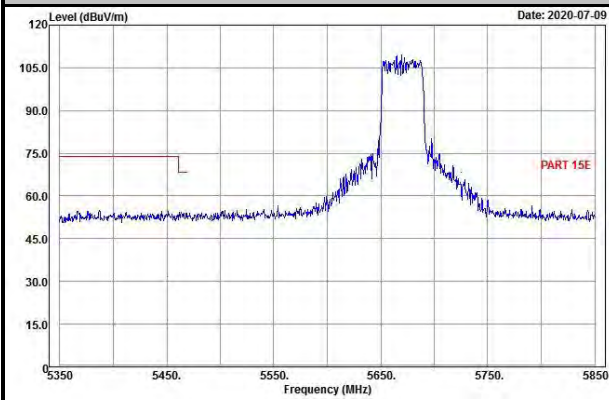

Vertical

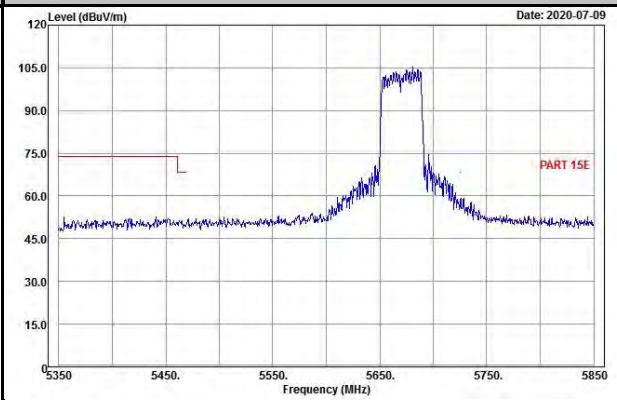

Average

Horizontal

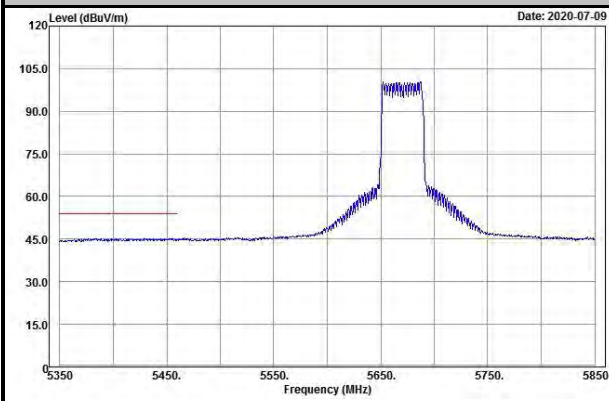

Vertical

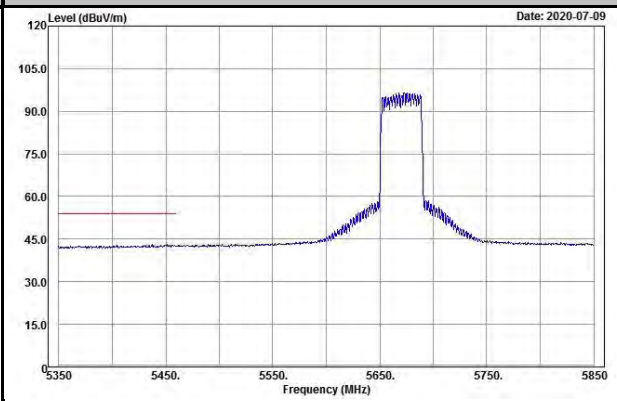

802.11ax (HE80)

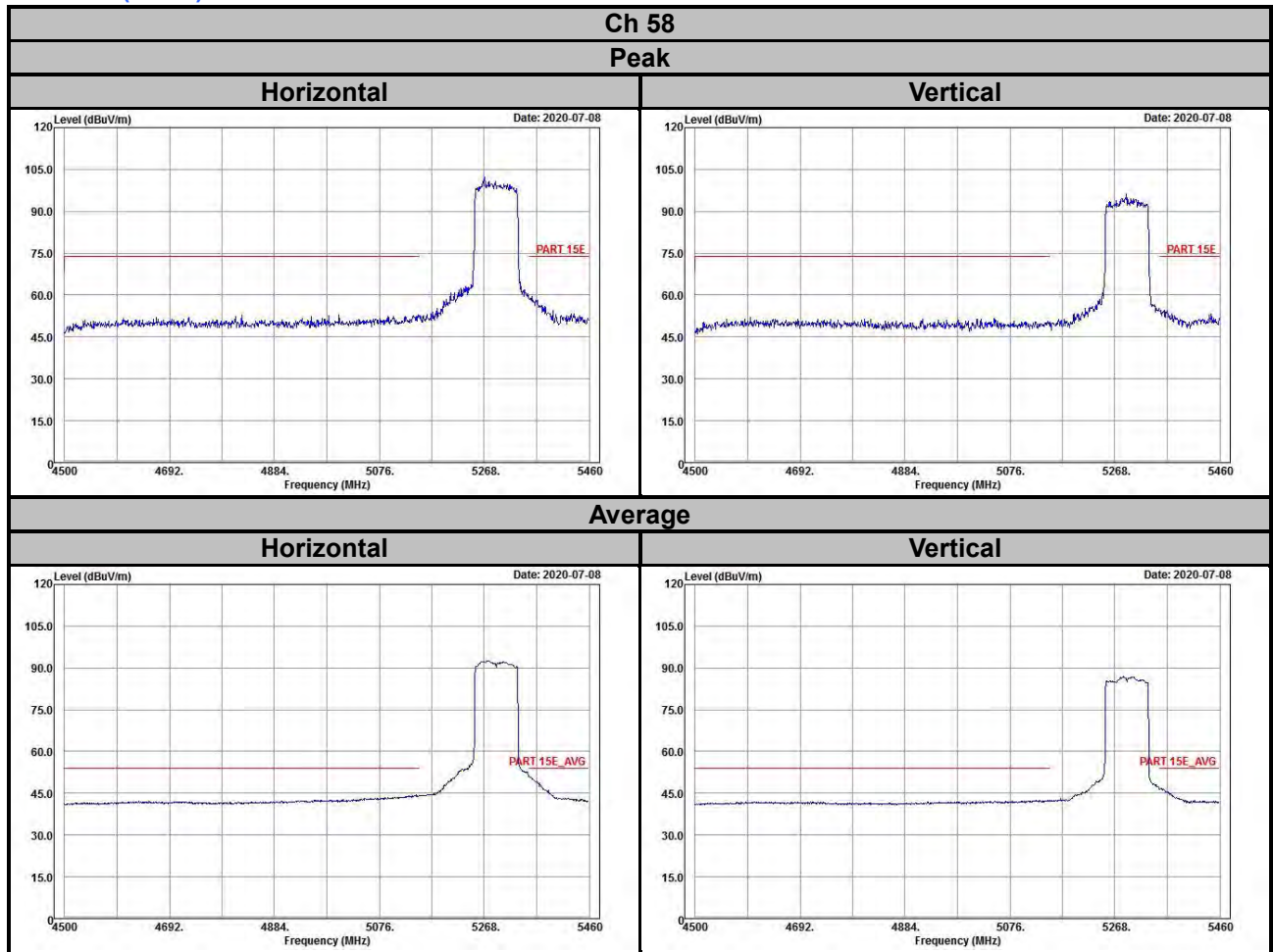

Ch 106

Peak

Horizontal

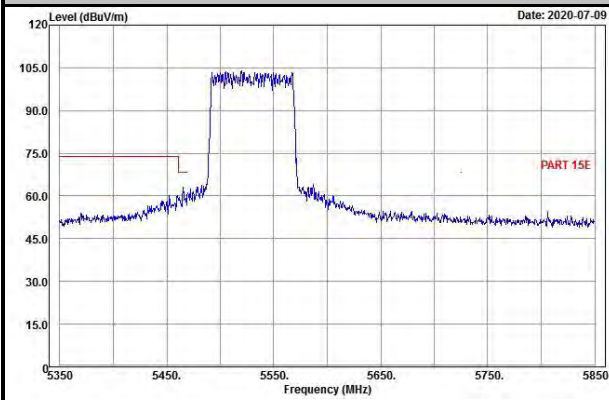

Vertical

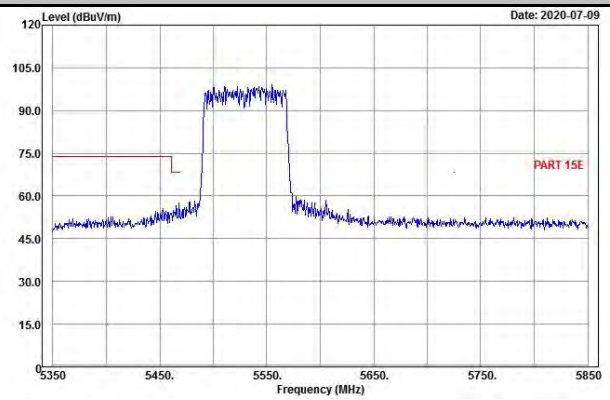

Average

Horizontal

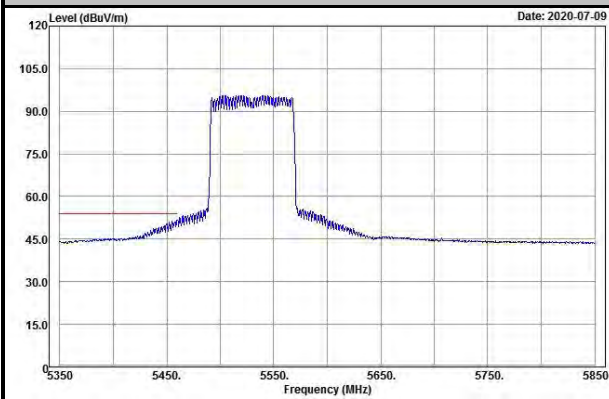

Vertical

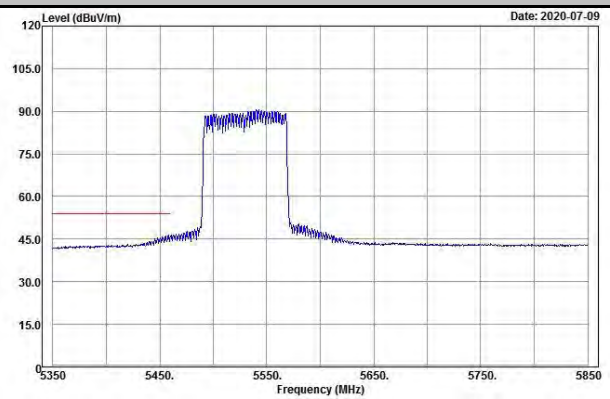

Ch 122

Peak

Horizontal

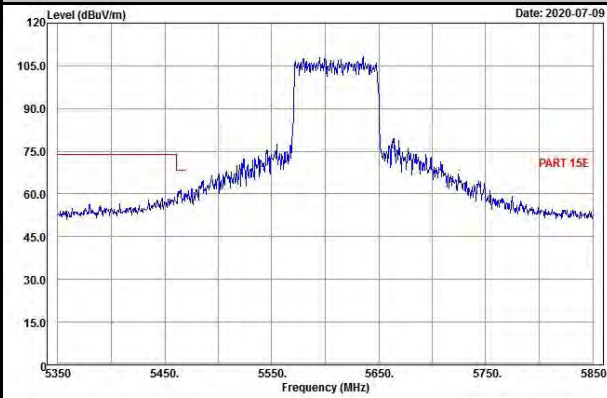

Vertical

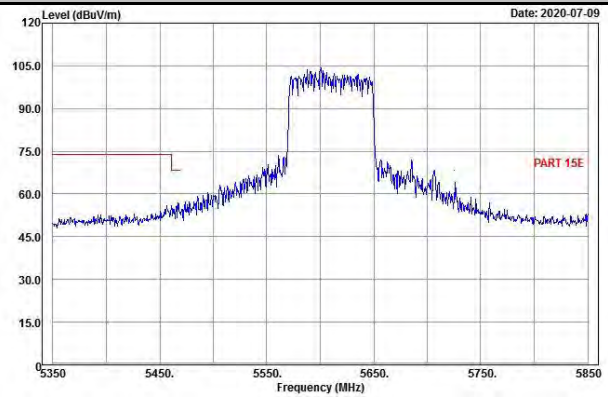

Average

Horizontal

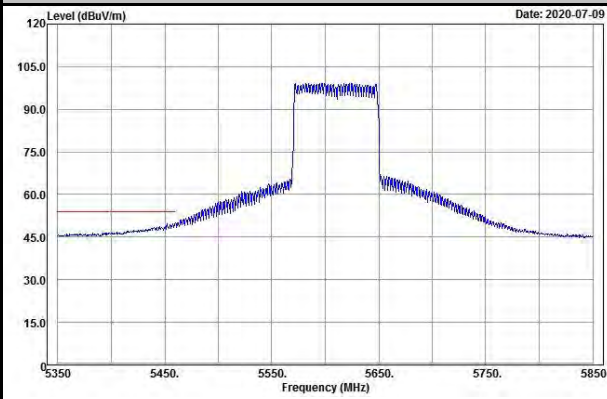

Vertical

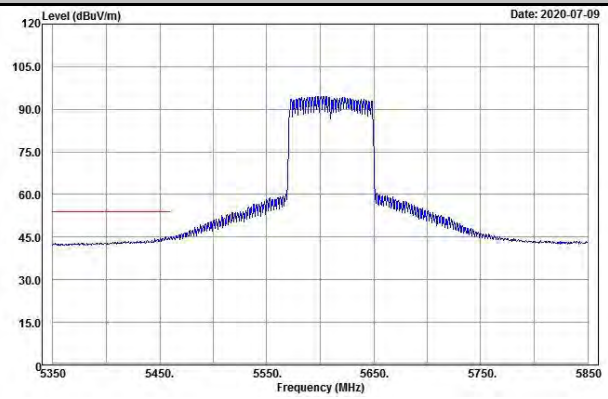

Mode B
802.11a

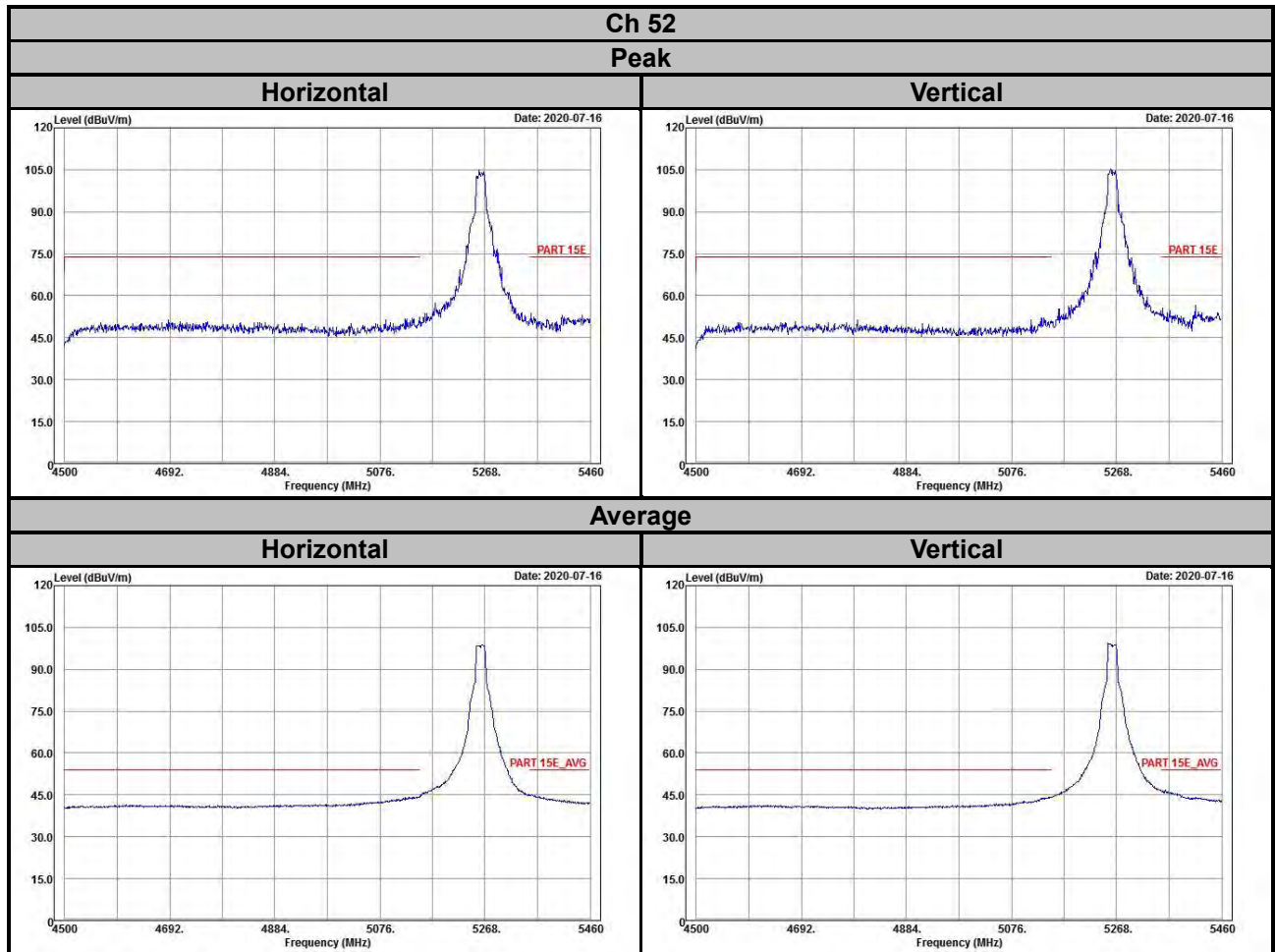

Ch 60
Peak

Horizontal

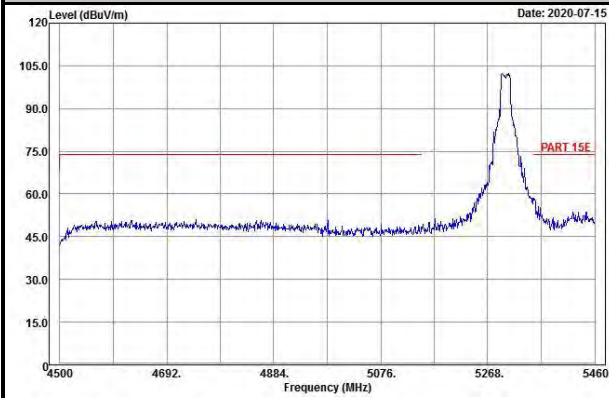

Vertical

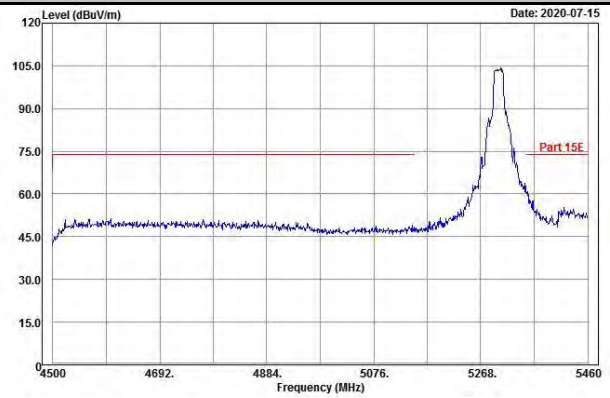

Average

Horizontal

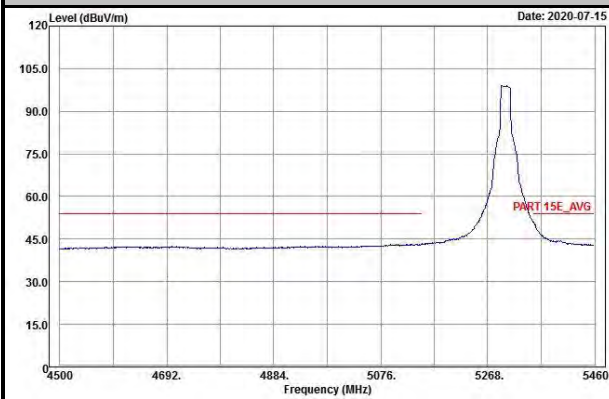

Vertical

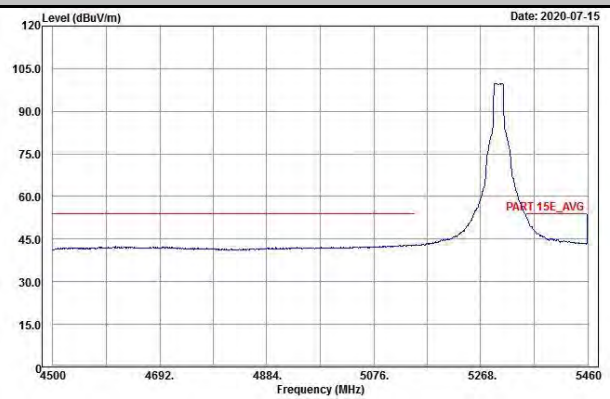

Ch 64
Peak

Horizontal

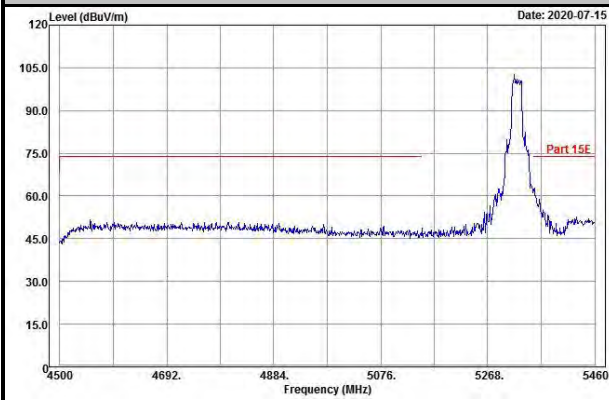

Vertical

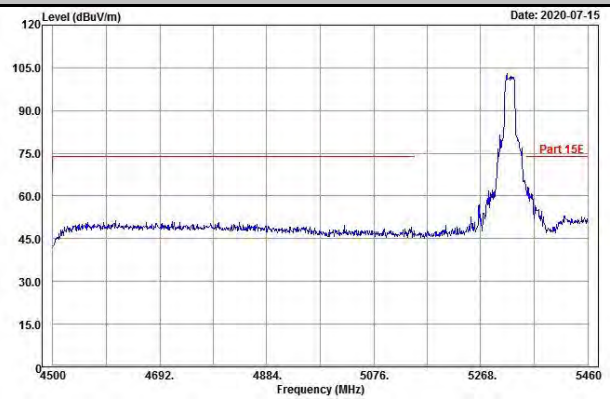

Average

Horizontal

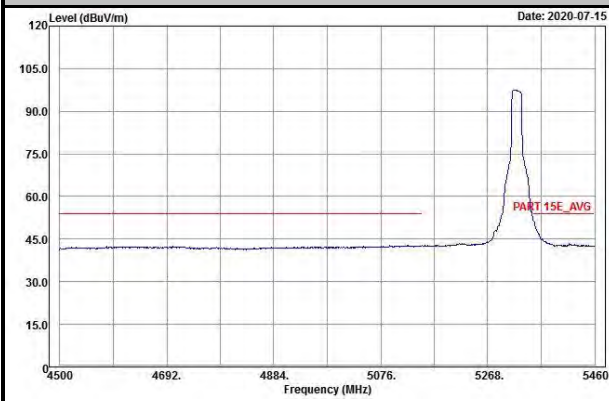

Vertical

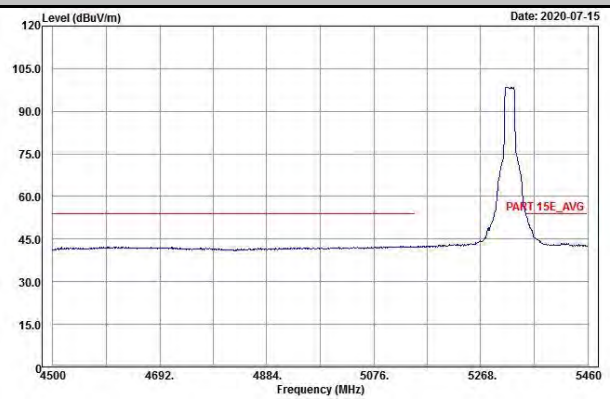

Ch 100

Peak

Horizontal

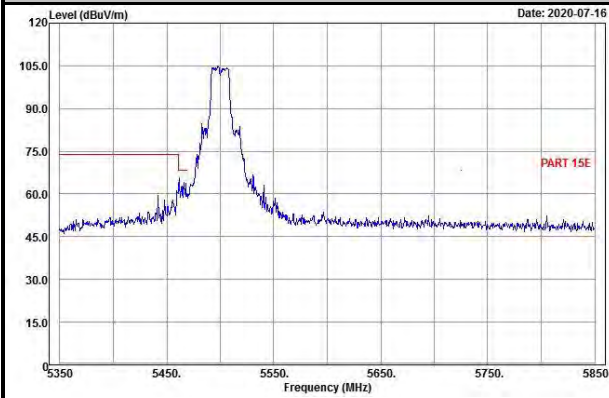

Vertical

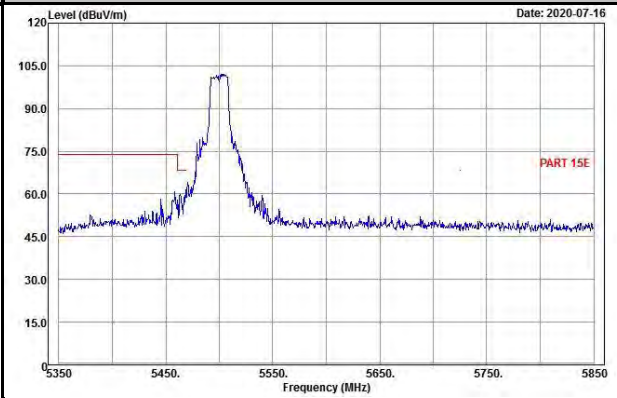

Average

Horizontal

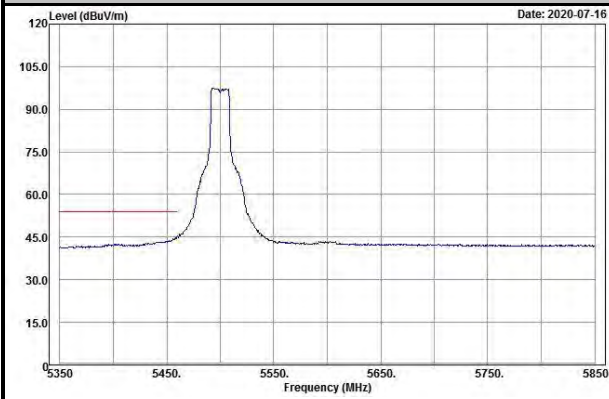

Vertical

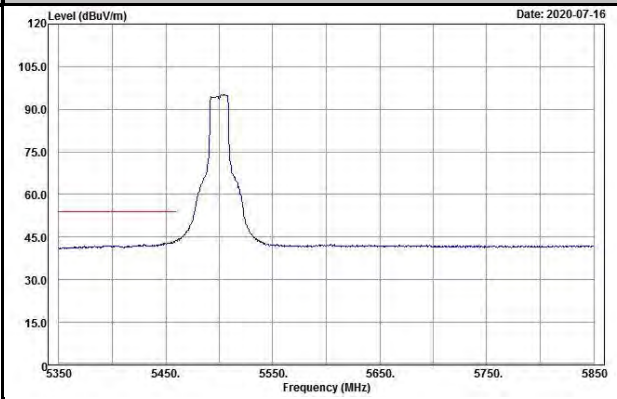

Ch 116

Peak

Horizontal

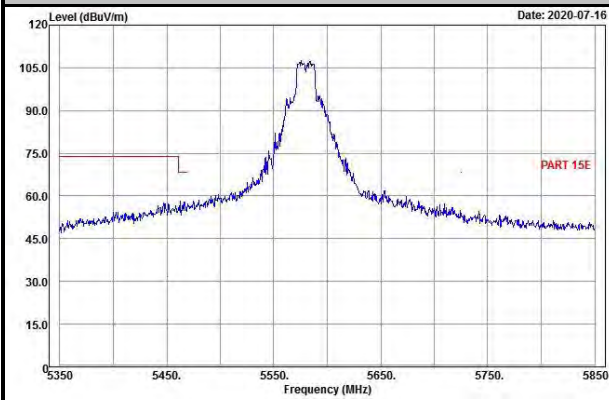

Vertical

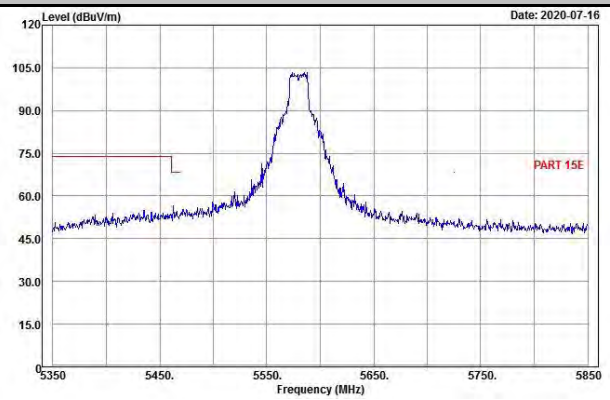

Average

Horizontal

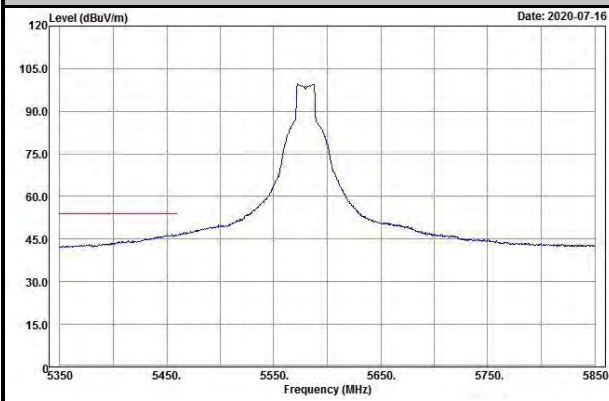

Vertical

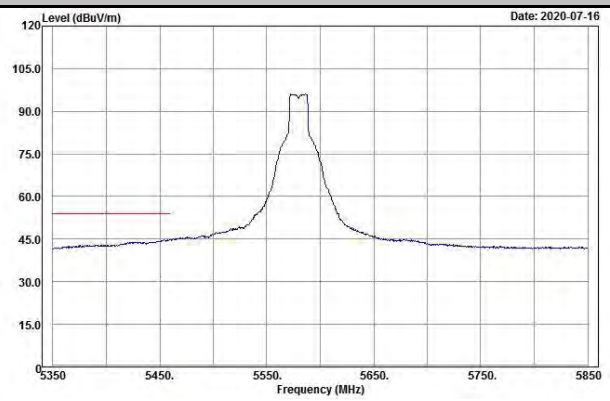

Ch 140

Peak

Horizontal

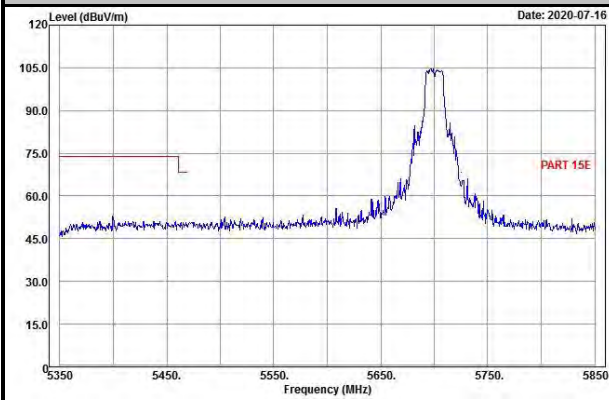

Vertical

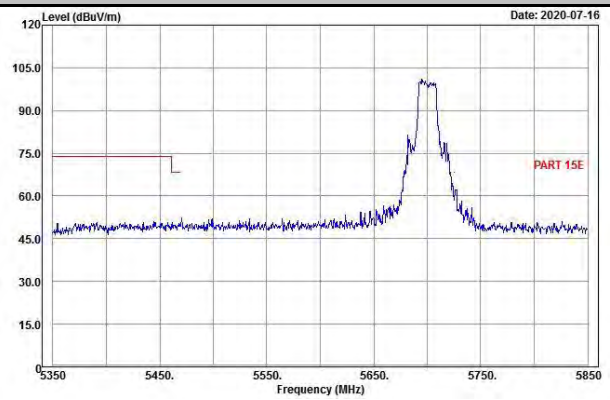

Average

Horizontal

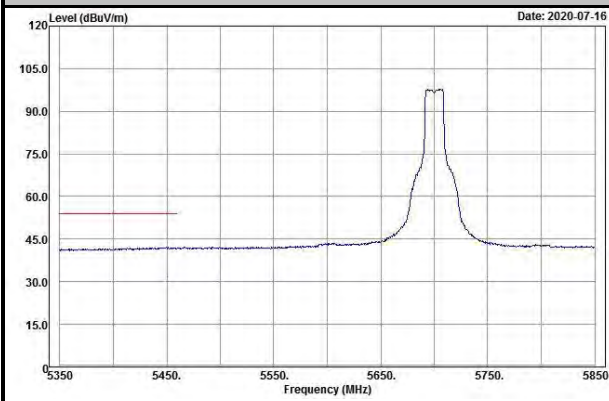

Vertical

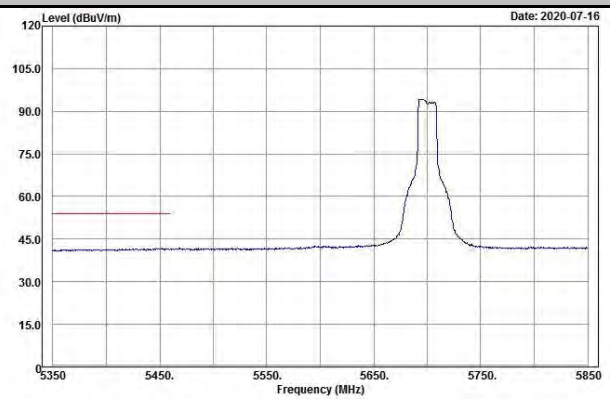

802.11ax (HE20)

Ch 52

Peak

Horizontal

Vertical

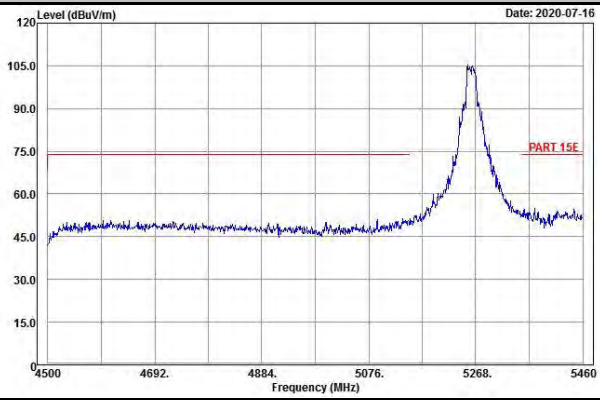
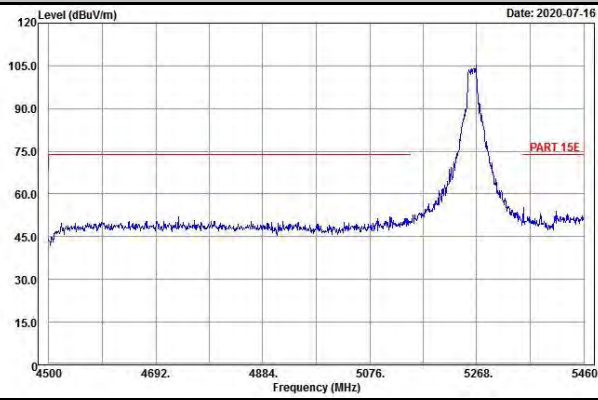

Average

Horizontal

Vertical

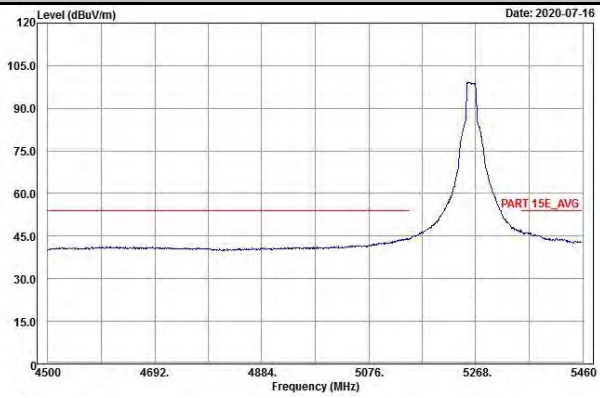
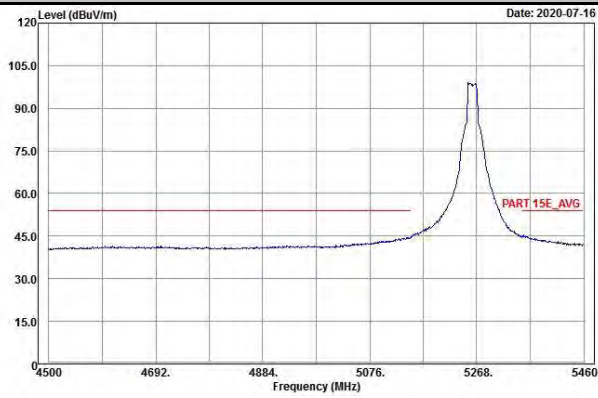

Ch 60
Peak

Horizontal

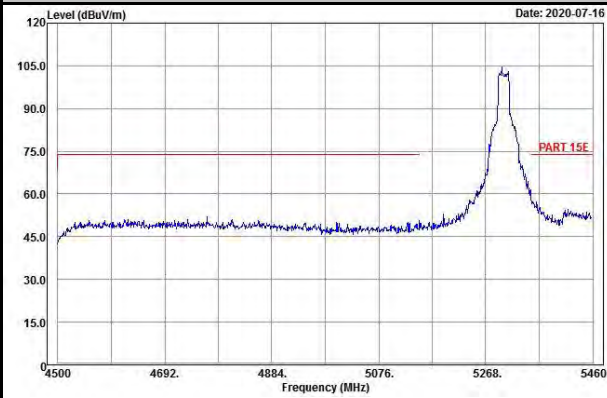

Vertical

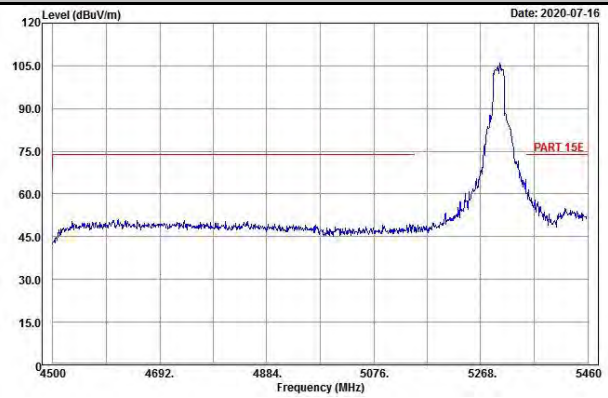

Average

Horizontal

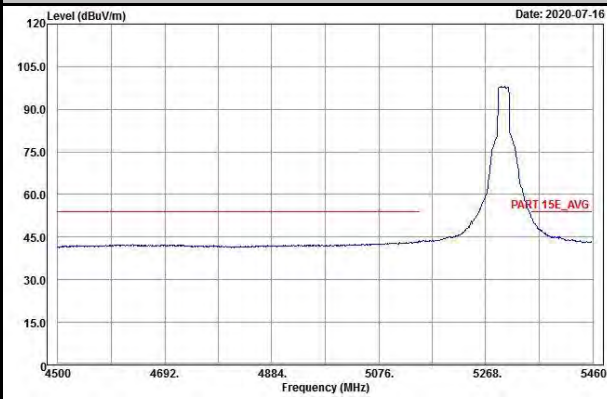

Vertical

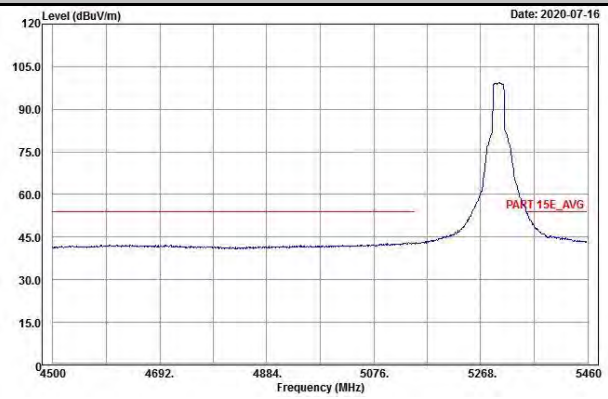

Ch 64
Peak

Horizontal

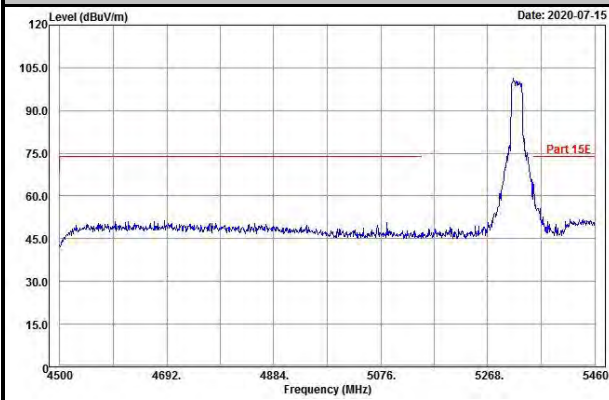

Vertical

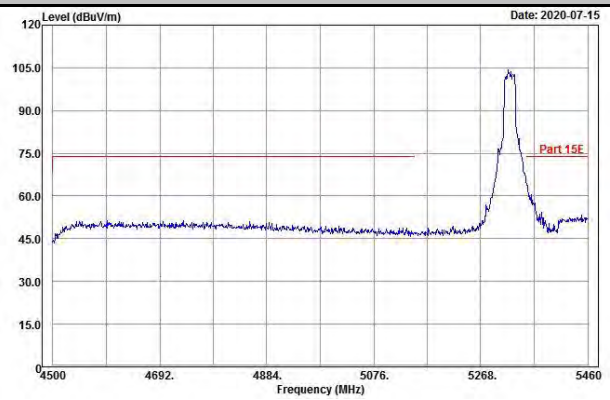

Average

Horizontal

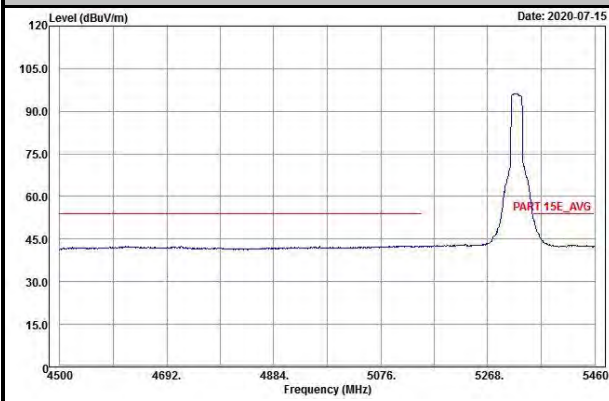

Vertical

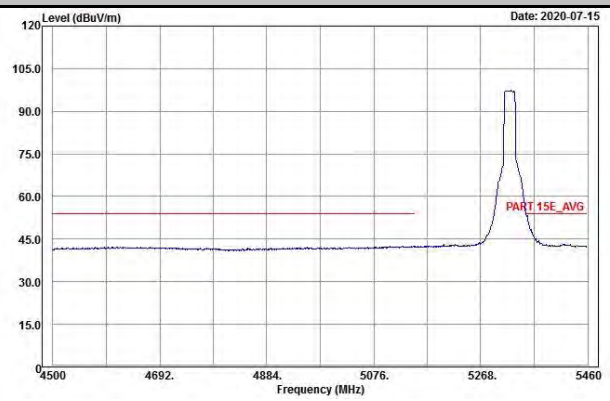

Ch 100

Peak

Horizontal

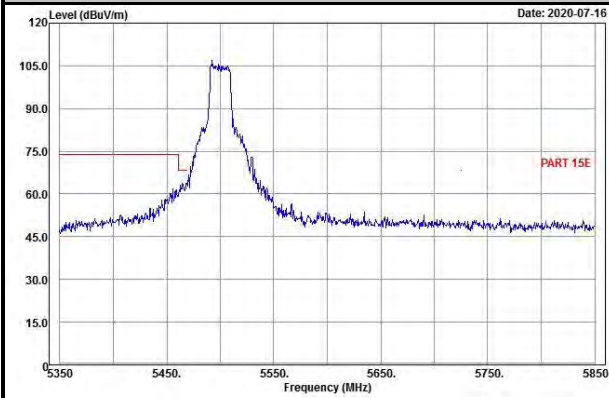

Vertical

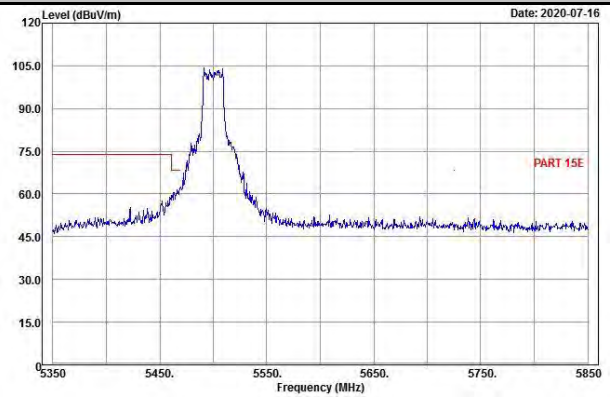

Average

Horizontal

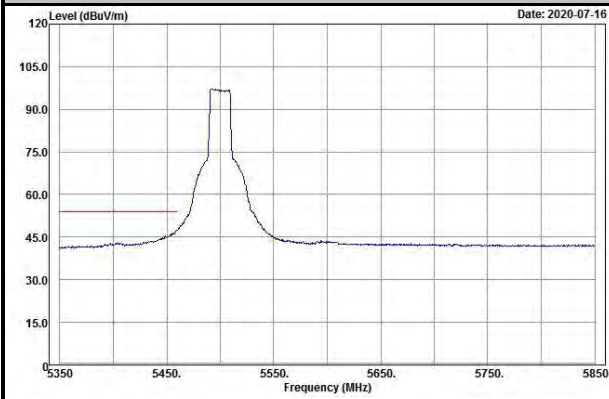

Vertical

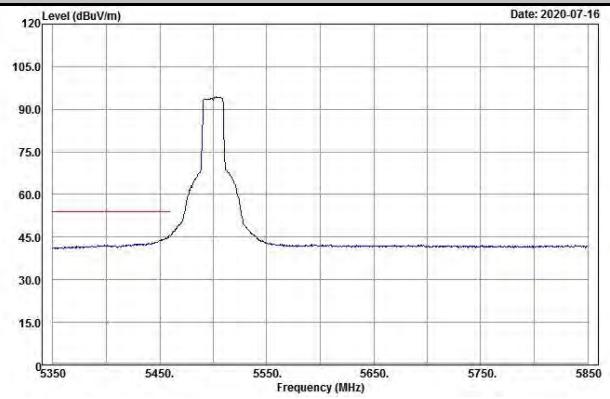

Ch 116

Peak

Horizontal

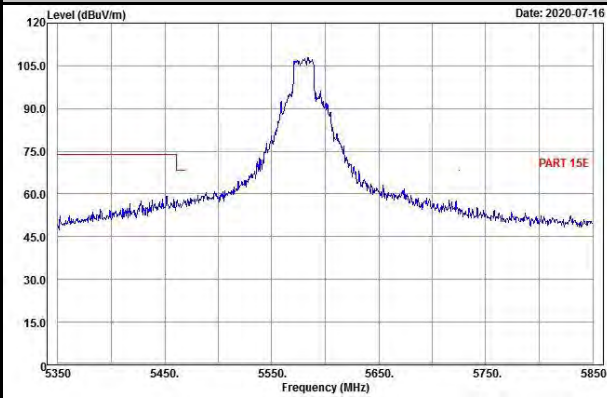

Vertical

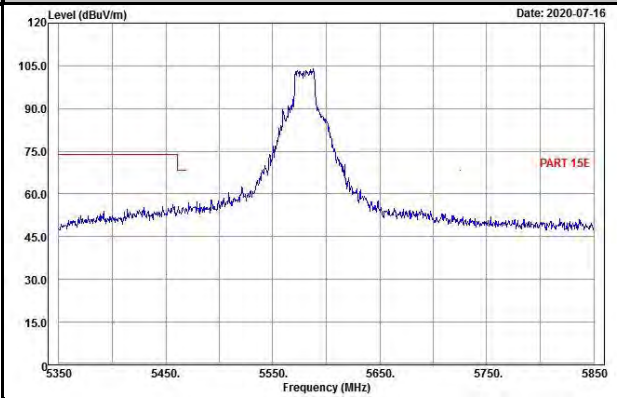

Average

Horizontal

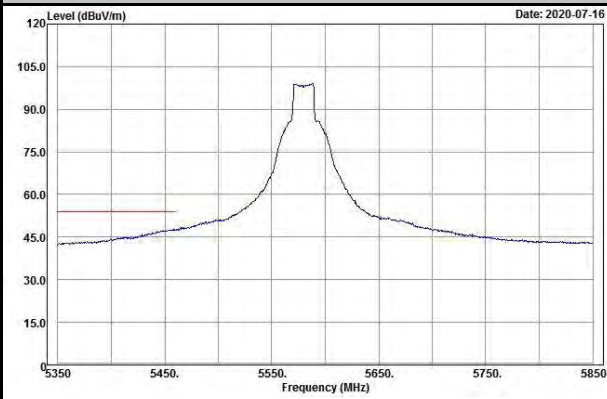

Vertical

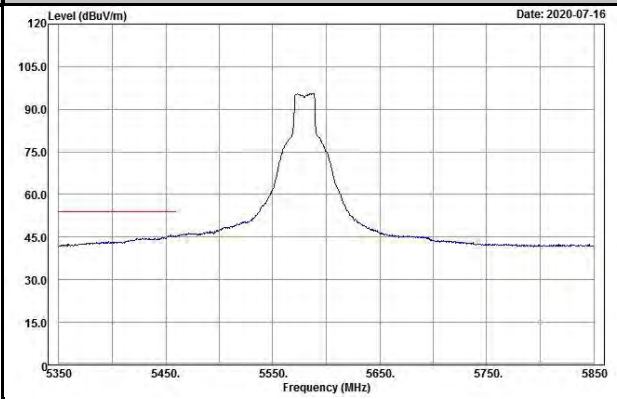

Ch 140

Peak

Horizontal

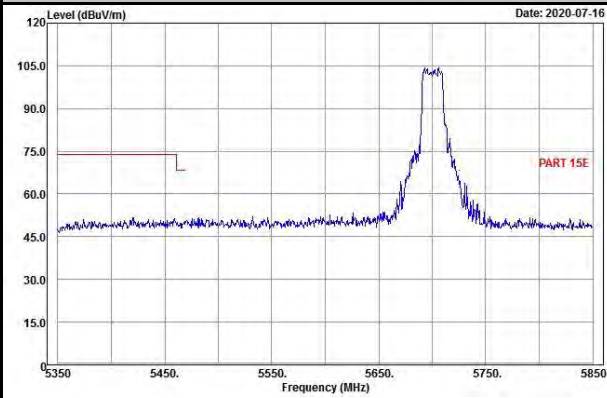

Vertical

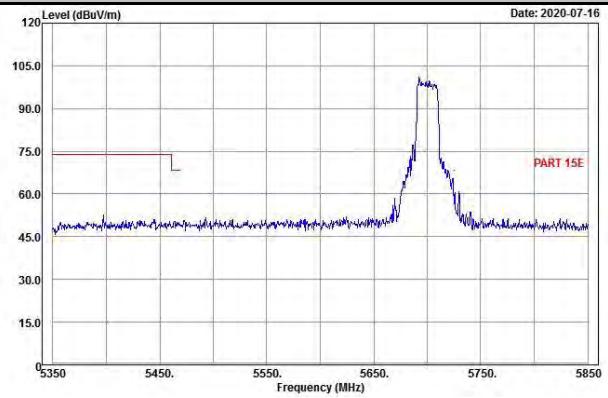

Average

Horizontal

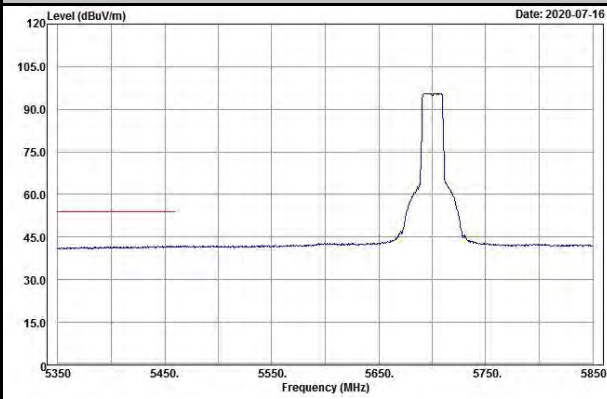

Vertical

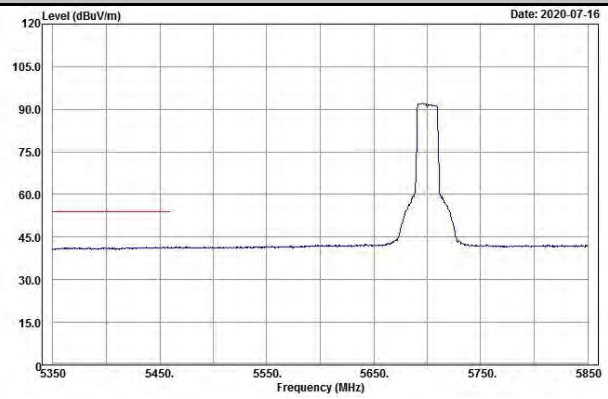

802.11ax (HE40)

Ch 54

Peak

Horizontal

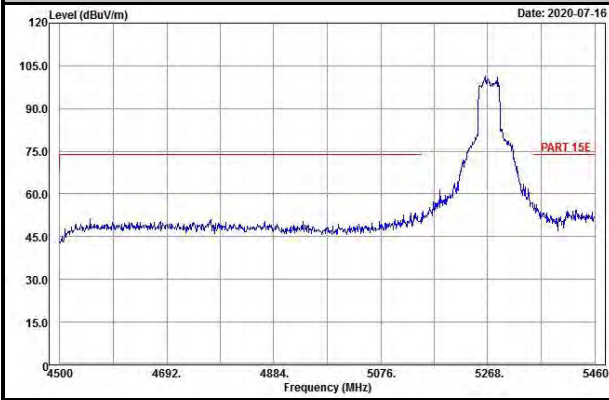

Vertical

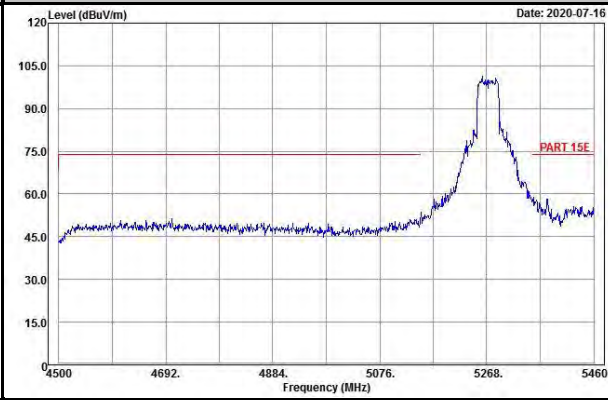

Average

Horizontal

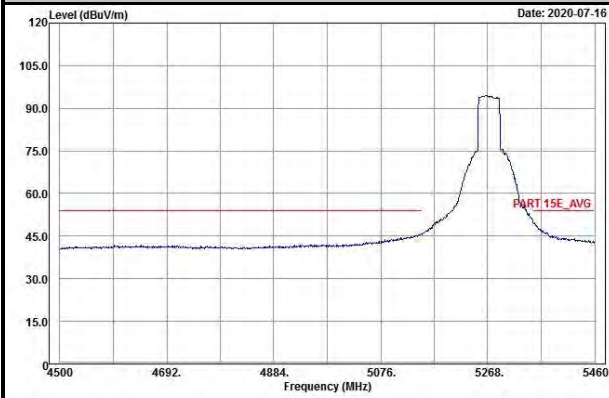

Vertical

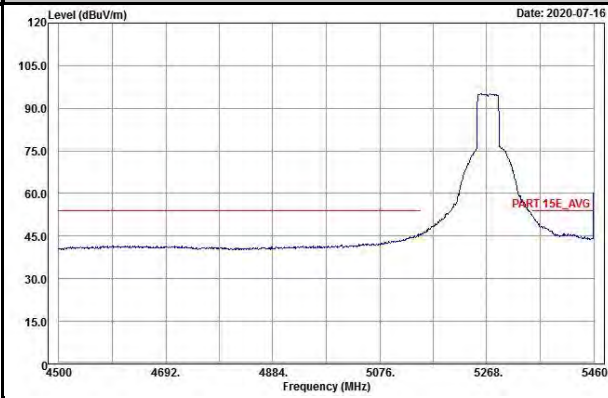

Ch 62
Peak

Horizontal

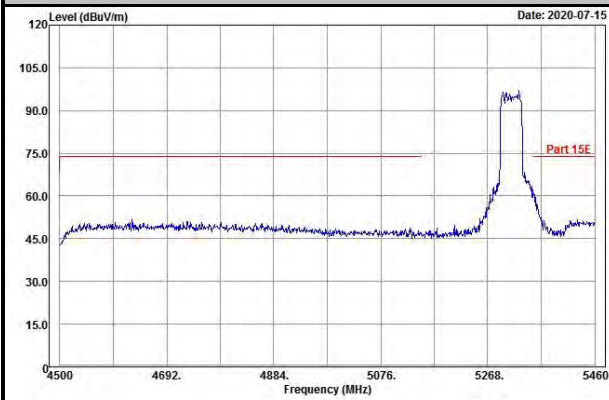

Vertical

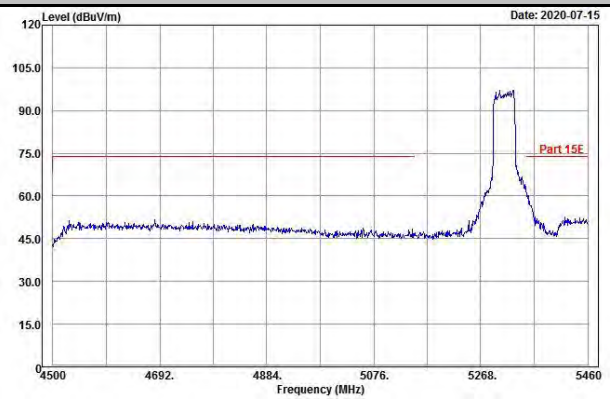

Average

Horizontal

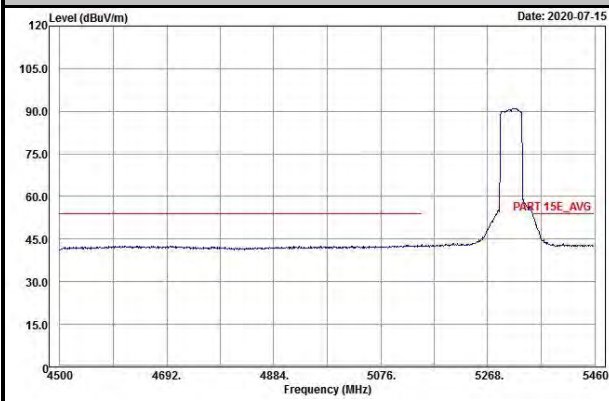

Vertical

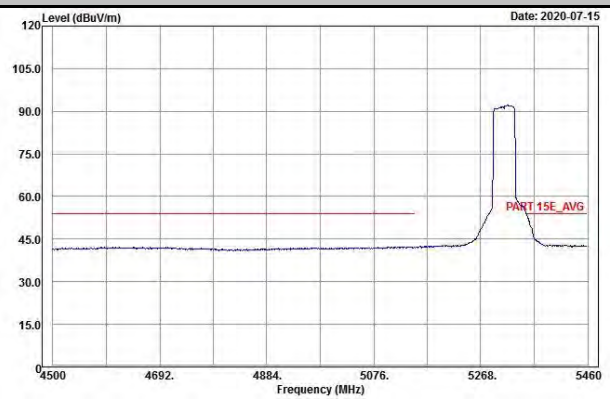

Ch 102

Peak

Horizontal

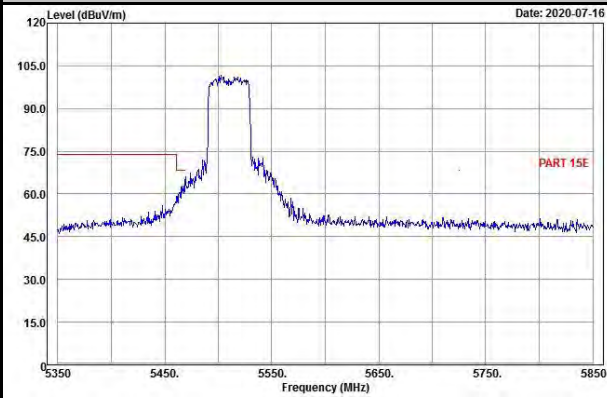

Vertical

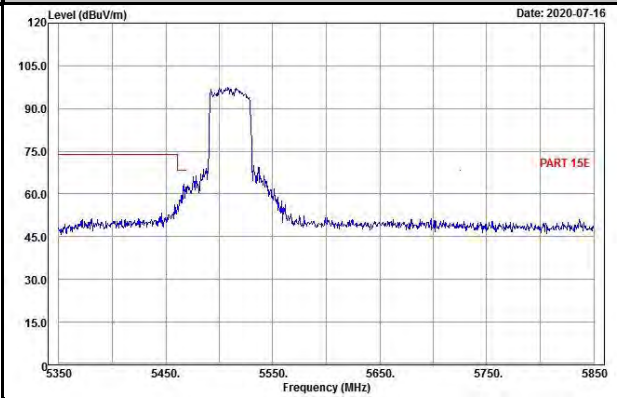

Average

Horizontal

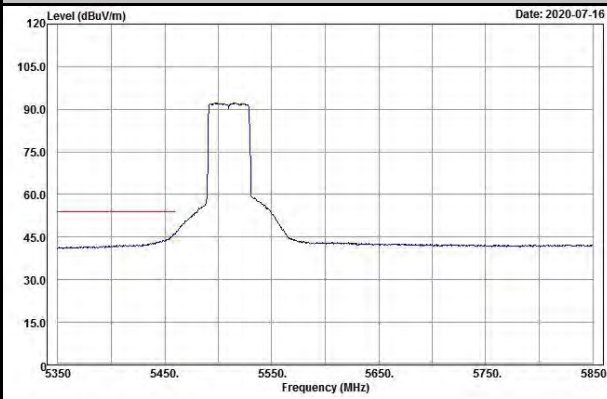

Vertical

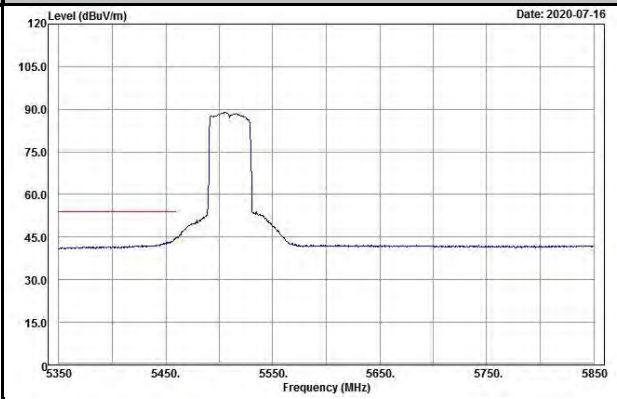

Ch 110

Peak

Horizontal

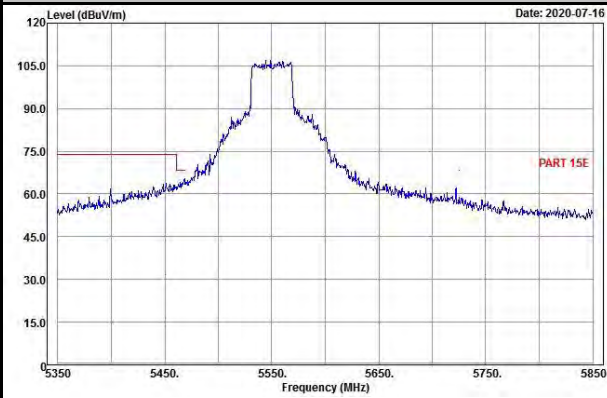

Vertical

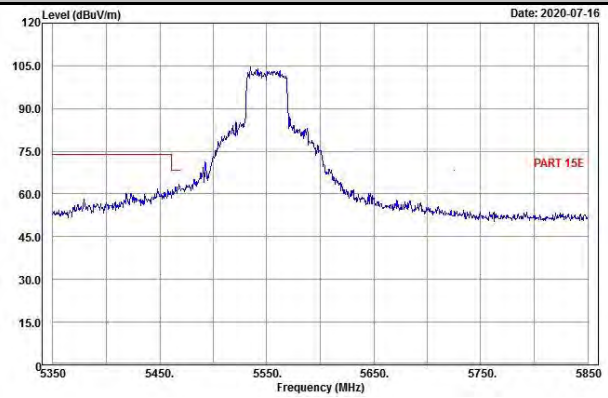

Average

Horizontal

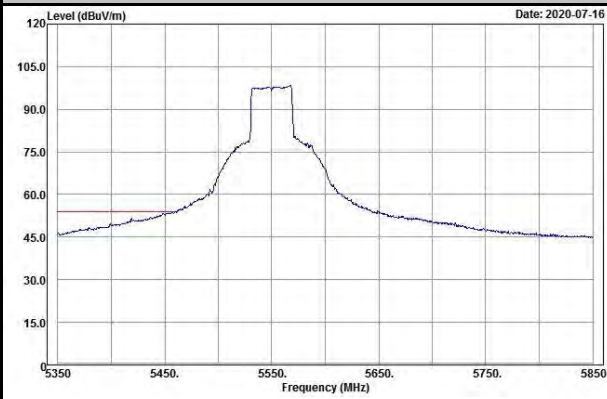

Vertical

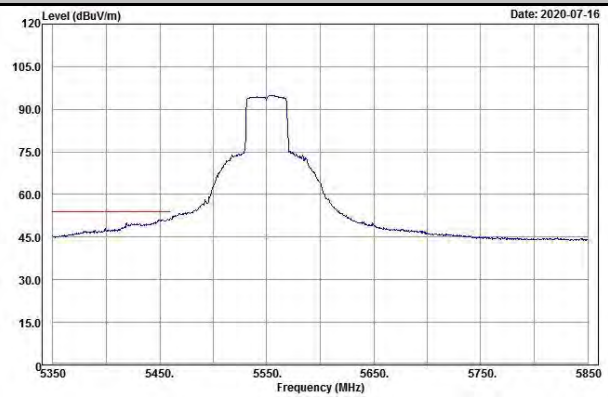

Ch 134

Peak

Horizontal

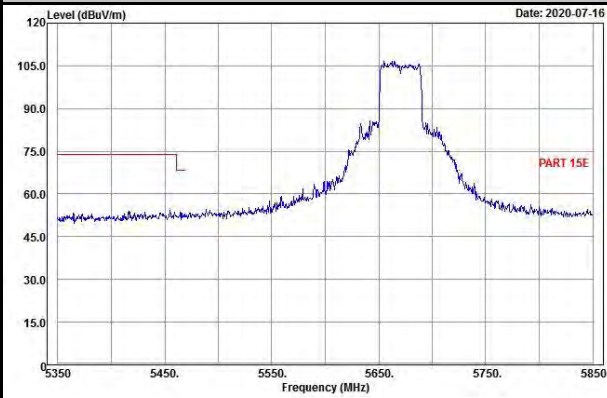

Vertical

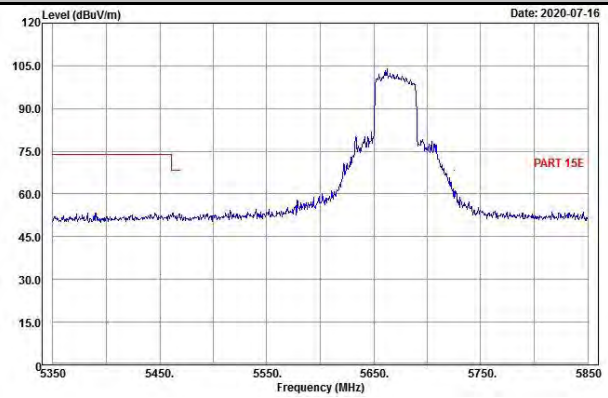

Average

Horizontal

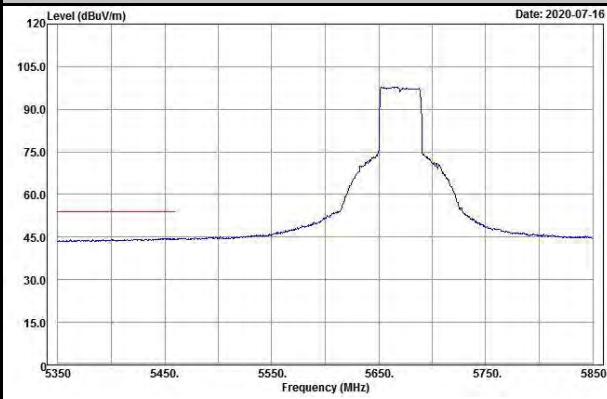

Vertical

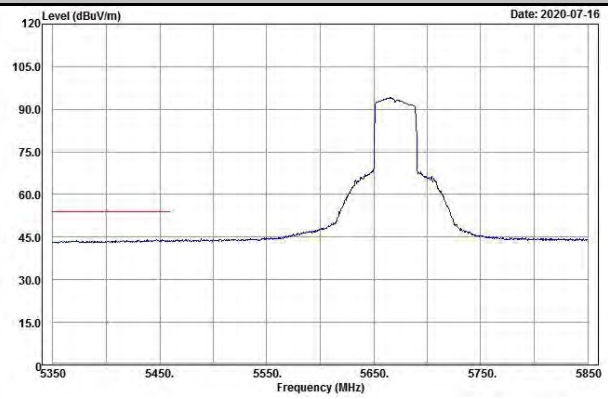

802.11ax (HE80)

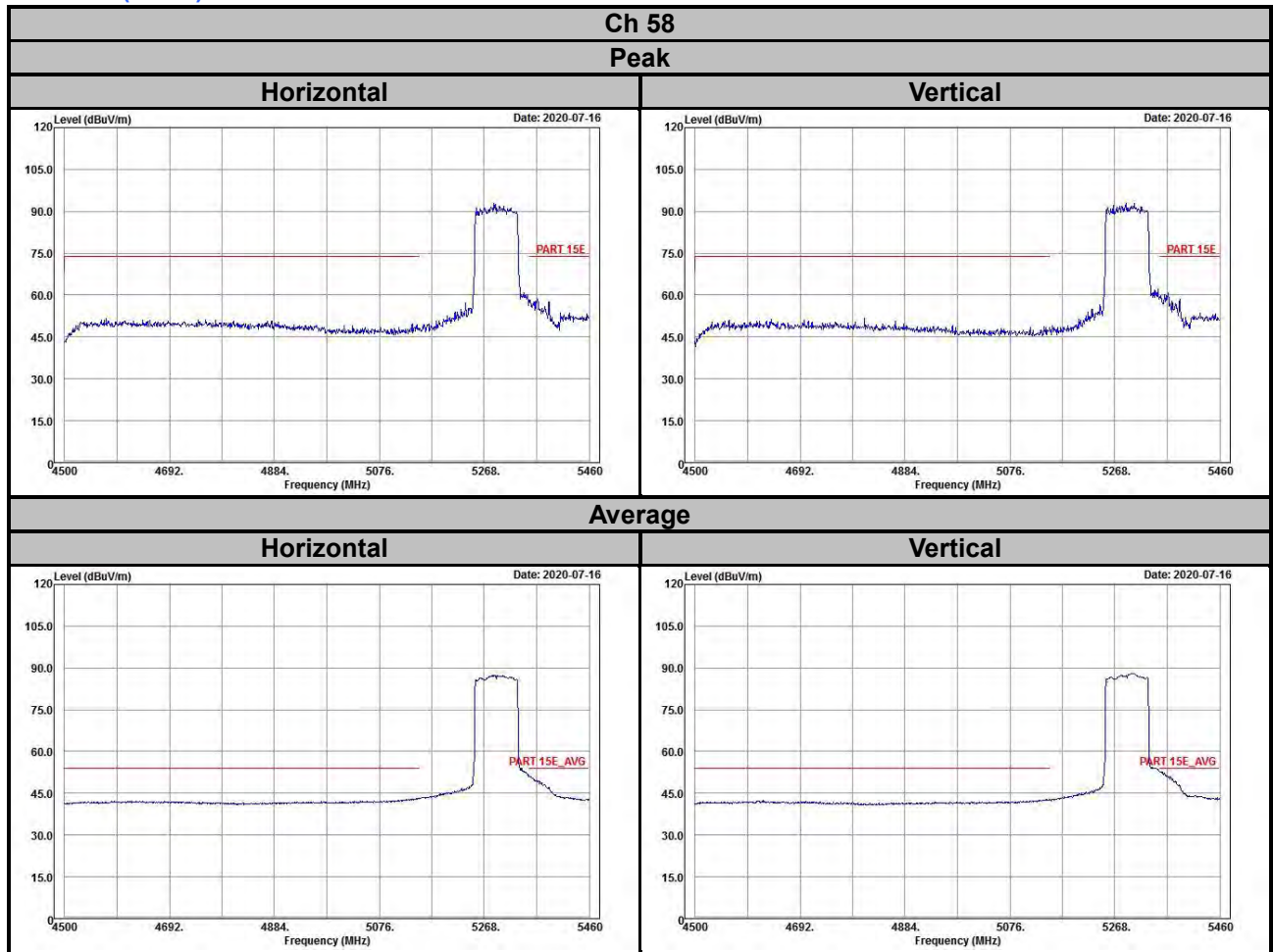

Ch 106

Peak

Horizontal

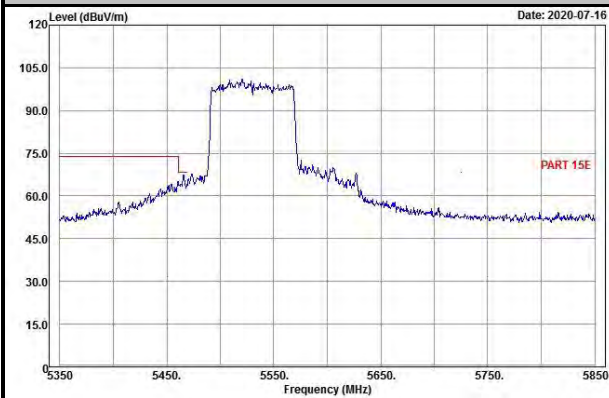

Vertical

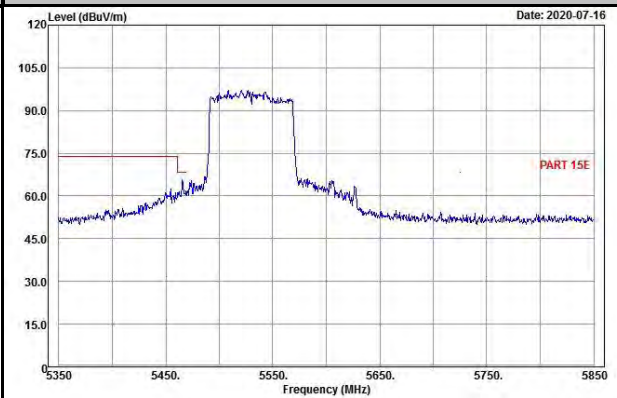

Average

Horizontal

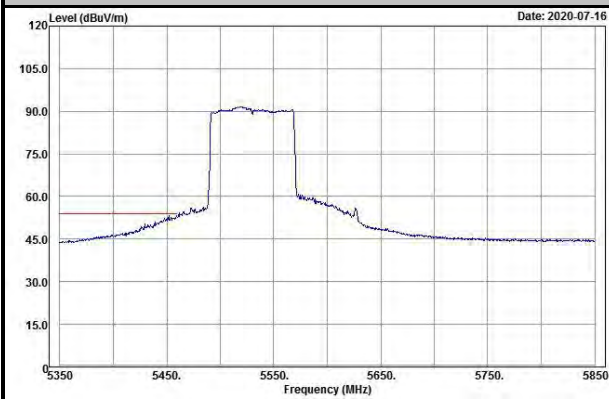

Vertical

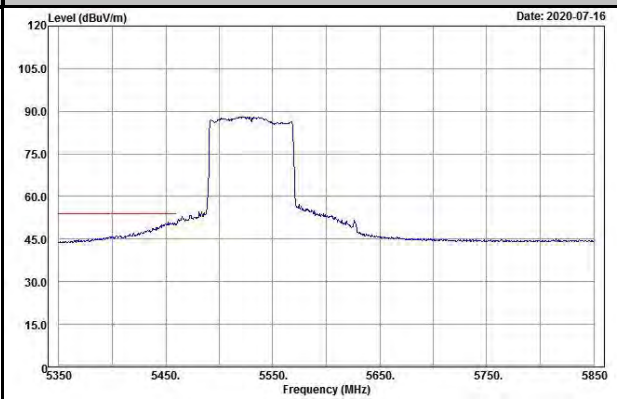

Ch 122

Peak

Horizontal

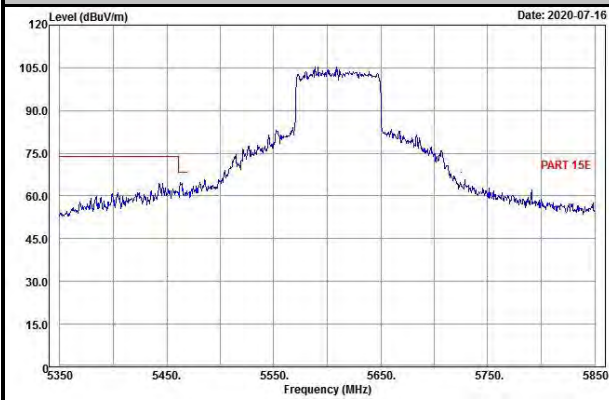

Vertical

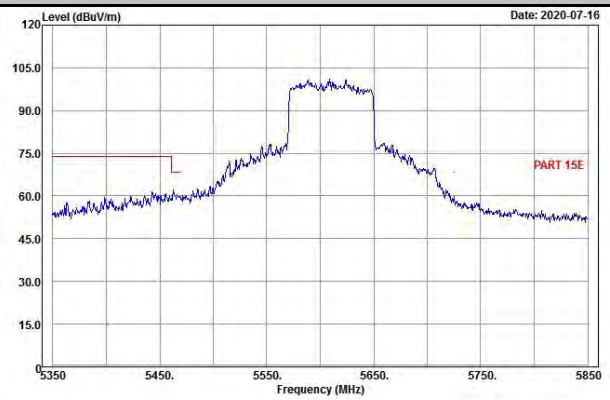

Average

Horizontal

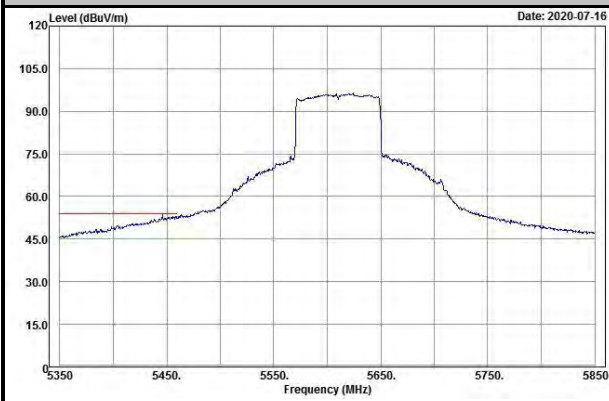

Vertical

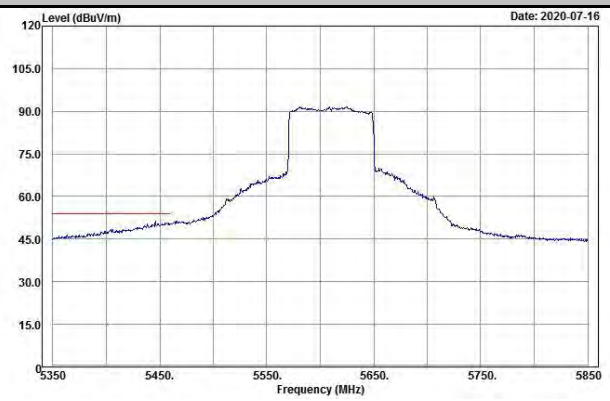

Appendix – Information of the Testing Laboratories

We, Bureau Veritas Consumer Products Services (H.K.) Ltd., Taoyuan Branch, were founded in 1988 to provide our best service in EMC, Radio, Telecom and Safety consultation. Our laboratories are FCC recognized accredited test firms and accredited according to ISO/IEC 17025.

If you have any comments, please feel free to contact us at the following:

Lin Kou EMC/RF Lab

Tel: 886-2-26052180

Fax: 886-2-26051924

Hsin Chu EMC/RF/Telecom Lab

Tel: 886-3-6668565

Fax: 886-3-6668323

Hwa Ya EMC/RF/Safety Lab

Tel: 886-3-3183232

Fax: 886-3-3270892

Email: service.adt@tw.bureauveritas.com

Web Site: www.bureauveritas-adt.com

The address and road map of all our labs can be found in our web site also.

--- END ---