



FCC PART 15 B
TEST REPORT

For

SZ DJI BaiWang Technology Co.,Ltd

Building No.1.2.7.9,Baiwang Creative Factory, No.1051,Songbai Road, Nanshan Xili
District,Shenzhen,China

FCC ID: 2AHAY-S5121601

Report Type: Original Report	Product Type: X5R SSD
Test Engineer: Jone Lv	<i>Jone Lv</i>
Report Number: RDG160119004-00	
Report Date: 2016-01-22	
Reviewed By: Harry Wu EMC Manager	<i>Harry Wu</i>
Test Laboratory: Bay Area Compliance Laboratories Corp. (Dongguan) No.69 Pulongcun, Puxinhu Industrial Zone, Tangxia, Dongguan, Guangdong, China Tel: +86-769-86858888 Fax: +86-769-86858891 www.baclcorp.com.cn	

Note: This test report is prepared for the customer shown above and for the device described herein. It may not be duplicated or used in part without prior written consent from Bay Area Compliance Laboratories Corp. (Dongguan).

TABLE OF CONTENTS

GENERAL INFORMATION.....	3
PRODUCT DESCRIPTION FOR EQUIPMENT UNDER TEST (EUT)	3
OBJECTIVE	3
RELATED SUBMITTAL(S)/GRANT(S).....	3
TEST METHODOLOGY	3
TEST FACILITY	4
SYSTEM TEST CONFIGURATION.....	5
DESCRIPTION OF TEST CONFIGURATION	5
EUT EXERCISE SOFTWARE	5
EQUIPMENT MODIFICATIONS	5
LOCAL SUPPORT EQUIPMENT LIST AND DETAILS	5
SUPPORT CABLE LIST AND DETAILS	5
CONFIGURATION OF TEST SETUP	6
SUMMARY OF TEST RESULTS	7
FCC§15.107 - CONDUCTED EMISSIONS.....	8
MEASUREMENT UNCERTAINTY	8
EUT SETUP.....	8
EMI TEST RECEIVER SETUP.....	9
TEST EQUIPMENT LIST AND DETAILS.....	9
TEST PROCEDURE	9
CORRECTED AMPLITUDE & MARGIN CALCULATION	9
TEST RESULTS SUMMARY	10
TEST DATA	10
FCC §15.109 - RADIATED SPURIOUS EMISSIONS	13
MEASUREMENT UNCERTAINTY	13
EUT SETUP	13
EMI TEST RECEIVER SETUP.....	14
TEST PROCEDURE	14
TEST EQUIPMENT LIST AND DETAILS.....	15
CORRECTED AMPLITUDE & MARGIN CALCULATION	15
TEST RESULTS SUMMARY	15
TEST DATA	15
ENVIRONMENTAL CONDITIONS.....	15

GENERAL INFORMATION

Product Description for Equipment Under Test (EUT)

The *SZ DJI BaiWang Technology Co.,Ltd* 's product, model number: *S512 (FCC ID: 2AHAY-S5121601)* (the "EUT") in this report was a *X5R SSD* , which was measured approximately:8.4 cm (L) x 3.8cm (W) x 0.5cm (H), rated input voltage: DC3.3V. The highest operating frequency is 2.5 GHz.

All measurement and test data in this report was gathered from production sample serial number: 160119004 (Assigned byBACL, Dongguan). The EUT was received on 2016-01-18.

Objective

This test report is prepared on behalf of *SZ DJI BaiWang Technology Co.,Ltd* in accordance with Part 2, Subpart J, and Part 15-Subparts A and B of the Federal Communications Commission's rules.

The objective of the manufacturer is to determine the compliance of EUT with FCC Part 15 B Class B.

Related Submittal(s)/Grant(s)

Submitted with the Part of a system with FCC ID: 2AHAY-SR6G1601.

Test Methodology

All measurements contained in this report were conducted with ANSI C63.4-2014, American National Standard for Methods of Measurement of Radio-Noise Emissions from Low-Voltage Electrical and Electronic Equipment in the range of 9 kHz to 40 GHz.

All radiated and conducted emissions measurement was performed at Bay Area Compliance Laboratories Corp. (Dongguan).

Test Facility

The Test site used by Bay Area Compliance Laboratories Corp. (Dongguan) to collect test data is located on the No.69 Pulongcun, Puxinhu Industrial Zone, Tangxia, Dongguan, Guangdong, China

Test site at Bay Area Compliance Laboratories Corp. (Dongguan) has been fully described in reports submitted to the Federal Communications Commission (FCC). The details of these reports have been found to be in compliance with the requirements of Section 2.948 of the FCC Rules on February 06, 2015.

The Federal Communications Commission has the reports on file and is listed under FCC Registration No.: 273710. The test site has been approved by the FCC for public use and is listed in the FCC Public Access Link (PAL) database.

F I N A L

SYSTEM TEST CONFIGURATION

Description of Test Configuration

The system was configured for testing in a typical fashion (as normally used by a typical user).

EUT Exercise Software

The software “winthrax.exe” was used during test.

Equipment Modifications

No modification was made to the EUT tested.

Local Support Equipment List and Details

Manufacturer	Description	Model	Serial Number
HP	Printer	C3990A	JPZW030603
SAST	Modem	AEM-2100	090200213
DELL	Keyboard	SK-8115	CN-0J4628-71616-52H-0RT6
DJI	X5R SSD READER	SR6G	N/A
DELL	Laptop	PP11L	N/A

Support Cable List and Details

Cable Description	Length (m)	From Port	To
Shielded Detachable Parallel Cable	1.5	Parallel Port of Laptop	Printer
Shielded Detachable Serial Cable	1.5	Serial Port of Laptop	Modem
Shielded Undetachable USBCable	2.0	USB Port of Laptop	Keyboard
Unshielded Detachable USB Cable	0.5	USB Port of Laptop	SR6G

Configuration of Test Setup

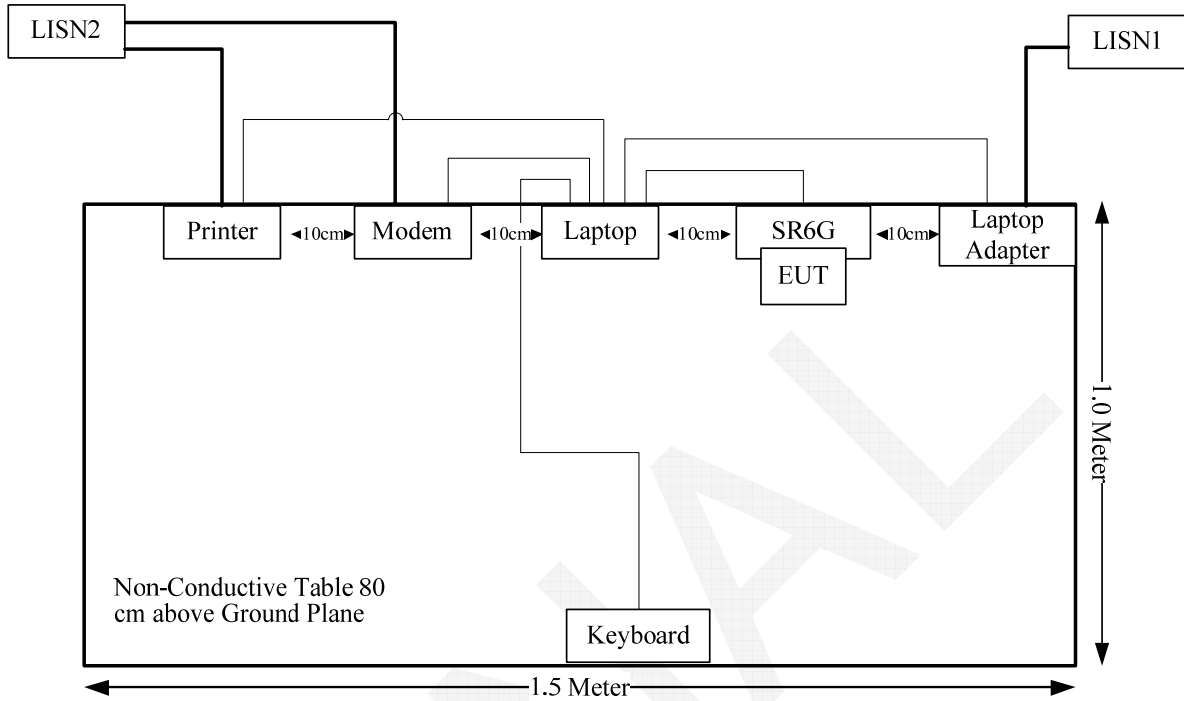

SUMMARY OF TEST RESULTS

FCC Rules	Description of Test	Results
§15.107	Conducted Emissions	Compliance
§15.109	Radiated Emissions	Compliance

F I N A L

FCC§15.107 - CONDUCTED EMISSIONS

Measurement Uncertainty

All measurements involve certain levels of uncertainties, especially in field of EMC. The factors contributing to uncertainties are Receiver, cable loss, and LISN.

Compliance or non-compliance with a disturbance limit shall be determined in the following manner:

If U_{lab} is less than or equal to U_{cispr} of Table 1, then:

- compliance is deemed to occur if no measured disturbance level exceeds the disturbance limit;
- non-compliance is deemed to occur if any measured disturbance level exceeds the disturbance limit.

If U_{lab} is greater than U_{cispr} of Table 1, then:

- compliance is deemed to occur if no measured disturbance level, increased by $(U_{lab} - U_{cispr})$, exceeds the disturbance limit;
- non-compliance is deemed to occur if any measured disturbance level, increased by $(U_{lab} - U_{cispr})$, exceeds the disturbance limit.

Based on CISPR 16-4-2: 2011, measurement uncertainty of conducted disturbance at mains port using AMN at Bay Area Compliance Laboratories Corp. (Dongguan) is 3.12 dB (150 kHz to 30 MHz).

Table 1 – Values of U_{cispr}

Measurement	U_{cispr}
Conducted disturbance at mains port using AMN (150 kHz to 30 MHz)	3.4 dB

EUT Setup

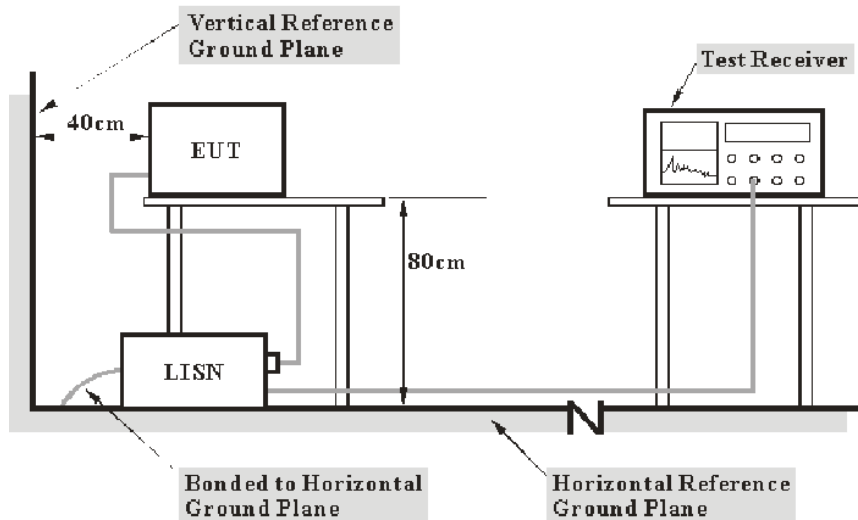

- Note: 1. Support units were connected to second LISN.
 2. Both of LISNs (AMN) 80 cm from EUT and at the least 80 cm from other units and other metal planes support units.

The setup of EUT is according with per ANSI C63.4-2014 measurement procedure. The specification used was with the FCC Part 15 B Class B limits.

The external I/O cables were draped along the test table and formed a bundle 30 to 40 cm long in the middle.

The adapter of laptop was connected to a 120V/60Hz AC power source.

EMI Test Receiver Setup

The EMI test receiver was set to investigate the spectrum from 150 kHz to 30 MHz.

During the conducted emission test, the EMI test receiver was set with the following configurations:

Frequency Range	IF B/W
150 kHz – 30 MHz	9 kHz

Test Equipment List and Details

Manufacturer	Description	Model	Serial Number	Calibration Date	Calibration Due Date
R&S	EMI Test Receiver	ESCS 30	830245/006	2015-12-10	2016-12-09
R&S	L.I.S.N	ESH2-Z5	892107/021	2015-07-16	2016-07-15
R&S	Two-line V-network	ENV 216	3560.6550.12	2015-11-26	2016-11-25
R&S	Test Software	EMC32	Version8.53.0	N/A	N/A

* Statement of Traceability: Bay Area Compliance Laboratories Corp. (Dongguan) attests that all calibrations have been performed, traceable to National Primary Standards and International System of Units (SI).

Test Procedure

During the conducted emission test, the adapter of laptop was connected to the outlet of the first LISN and the other support equipments were connected to the outlet of the second LISN.

Maximizing procedure was performed on the six (6) highest emissions of the EUT.

All data was recorded in the Quasi-peak and average detection mode.

Corrected Amplitude & Margin Calculation

The basic equation is as follows:

$$V_C = V_R + A_C + VDF$$

Herein,

V_C : corrected voltage amplitude

V_R : reading voltage amplitude

A_c : attenuation caused by cable loss

VDF: voltage division factor of AMN or ISN

The “**Margin**” column of the following data tables indicates the degree of compliance within the applicable limit. For example, a margin of 7dB means the emission is 7dB below the maximum limit. The equation for margin calculation is as follows:

$$\text{Margin} = \text{Limit} - \text{Corrected Amplitude}$$

Test Results Summary

According to the recorded data in following table, the EUT complied with the FCC Part 15 B Class B, with the worst margin reading of:

10.3 dB at 0.432855 MHz in the Neutral conducted mode

Test Data

Environmental Conditions

Temperature:	22.4°C
Relative Humidity:	44 %
ATM Pressure:	101.6 kPa

The testing was performed by Jone Lv on 2016-01-19.

Test Mode: Downloading

AC120V, 60Hz, Line:

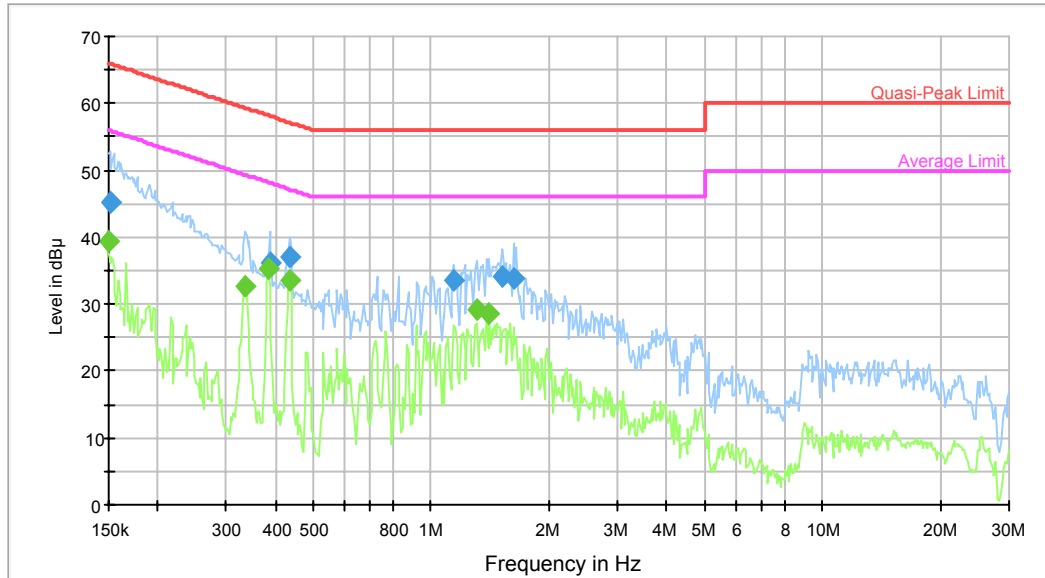

Frequency (MHz)	QuasiPeak (dBμV)	Bandwidth (kHz)	Line	Corr. (dB)	Margin (dB)	Limit (dBμV)	Comment
0.151200	45.3	9.000	L1	9.8	20.6	65.9	Compliance
0.387164	36.2	9.000	L1	9.8	21.9	58.1	Compliance
0.436318	37.0	9.000	L1	9.8	20.1	57.1	Compliance
1.144267	33.6	9.000	L1	9.8	22.4	56.0	Compliance
1.524426	34.0	9.000	L1	9.8	22.0	56.0	Compliance
1.624765	33.8	9.000	L1	9.8	22.2	56.0	Compliance

Frequency (MHz)	Average (dBμV)	Bandwidth (kHz)	Line	Corr. (dB)	Margin (dB)	Limit (dBμV)	Comment
0.150000	39.5	9.000	L1	9.8	16.5	56.0	Compliance
0.335433	32.8	9.000	L1	9.7	16.5	49.3	Compliance
0.384091	35.2	9.000	L1	9.8	13.0	48.2	Compliance
0.436318	33.7	9.000	L1	9.8	13.4	47.1	Compliance
1.310256	29.3	9.000	L1	9.8	16.7	46.0	Compliance
1.407671	28.6	9.000	L1	9.8	17.4	46.0	Compliance

AC120V, 60Hz, Neutral:

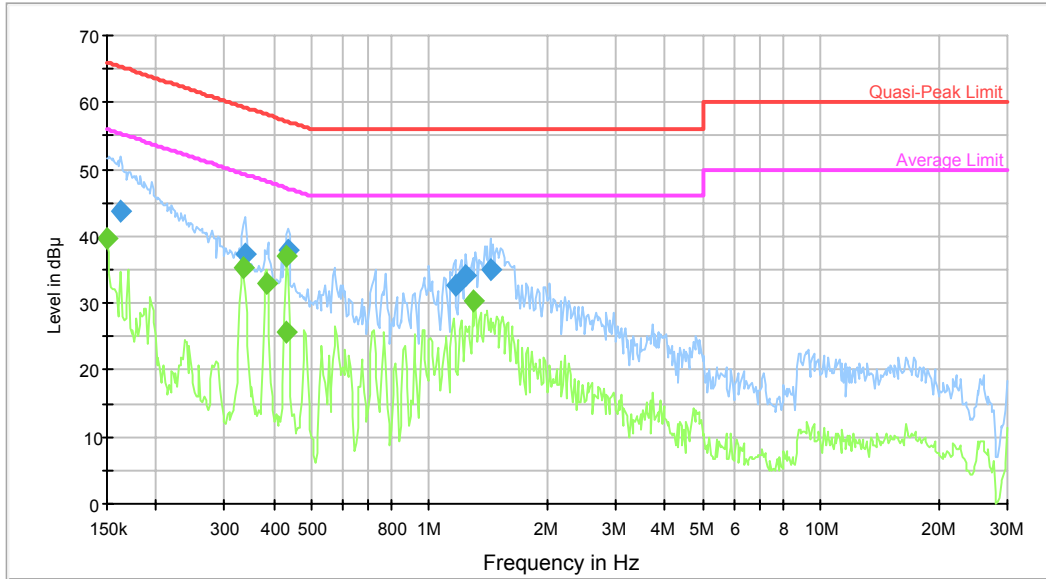

Frequency (MHz)	QuasiPeak (dBµV)	Bandwidth (kHz)	Line	Corr. (dB)	Margin (dB)	Limit (dBµV)	Comment
0.162441	43.7	9.000	N	9.7	21.6	65.3	Compliance
0.338116	37.4	9.000	N	9.7	21.8	59.2	Compliance
0.436318	37.9	9.000	N	9.7	19.2	57.1	Compliance
1.162648	32.6	9.000	N	9.8	23.4	56.0	Compliance
1.239175	34.2	9.000	N	9.8	21.8	56.0	Compliance
1.430284	35.1	9.000	N	9.8	20.9	56.0	Compliance

Frequency (MHz)	Average (dBµV)	Bandwidth (kHz)	Line	Corr. (dB)	Margin (dB)	Limit (dBµV)	Comment
0.150000	39.8	9.000	N	9.7	16.2	56.0	Compliance
0.335433	35.3	9.000	N	9.7	14.0	49.3	Compliance
0.384091	32.9	9.000	N	9.7	15.3	48.2	Compliance
0.429420	25.8	9.000	N	9.7	21.5	47.3	Compliance
0.432855	36.9	9.000	N	9.7	10.3	47.2	Compliance
1.289541	30.3	9.000	N	9.8	15.7	46.0	Compliance

FCC §15.109 - RADIATED SPURIOUS EMISSIONS

Measurement Uncertainty

Compliance or non-compliance with a disturbance limit shall be determined in the following manner:

If U_{lab} is less than or equal to U_{cispr} of Table 1, then:

- compliance is deemed to occur if no measured disturbance level exceeds the disturbance limit;
- non-compliance is deemed to occur if any measured disturbance level exceeds the disturbance limit.

If U_{lab} is greater than U_{cispr} of Table 1, then:

- compliance is deemed to occur if no measured disturbance level, increased by $(U_{lab} - U_{cispr})$, exceeds the disturbance limit;
- non-compliance is deemed to occur if any measured disturbance level, increased by $(U_{lab} - U_{cispr})$, exceeds the disturbance limit.

Based on CISPR 16-4-2: 2011, measurement uncertainty of radiated emission at a distance of 10m at Bay Area Compliance Laboratories Corp. (Dongguan) is: 30M~200MHz: 4.55 dB for Horizontal, 4.57 dB for Vertical; 200M~1GHz: 4.66 dB for Horizontal, 4.56 dB for Vertical; measurement uncertainty of radiated emission at a distance of 3m at Bay Area Compliance Laboratories Corp. (Dongguan) is: 30M~200MHz: 4.58 dB for Horizontal, 4.59 dB for Vertical; 200M~1GHz: 4.83 dB for Horizontal, 5.85 dB for Vertical; 1G~6GHz: 4.45 dB, 6G~18GHz: 5.23 dB.

Table 1 – Values of U_{cispr}

Measurement		U_{cispr}
Radiated disturbance (electric field strength at an OATS or in a SAC)	(30 MHz to 1000 MHz)	6.3 dB
Radiated disturbance (electric field strength in a FAR)	(1 GHz to 6 GHz)	5.2 dB
Radiated disturbance (electric field strength in a FAR)	(6 GHz to 18 GHz)	5.5 dB

EUT Setup

Below 1GHz:

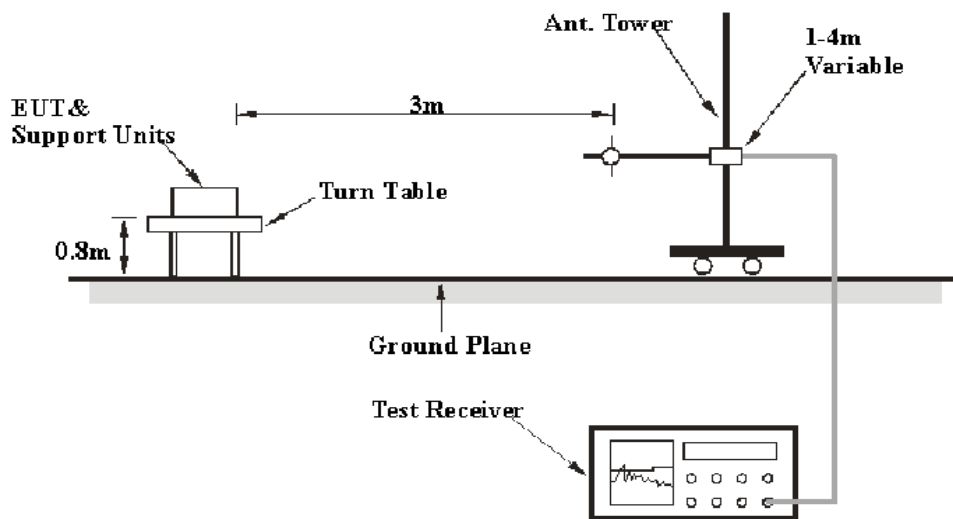

Above 1GHz:

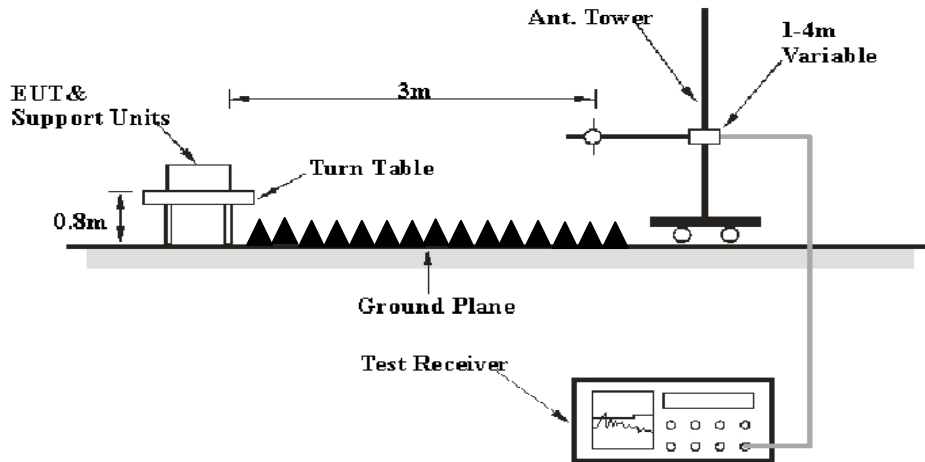

The radiated emission tests were performed in the 3 meters chamber test site, using the setup accordance with the ANSI C63.4-2014. The specification used was the FCC Part 15.109 Class B limits.

EMI Test Receiver Setup

The system was investigated from 30 MHz to 15 GHz.

During the radiated emission test, the EMI test receiver was set with the following configurations:

Frequency Range	RBW	Video B/W	IF B/W	Detector
30 MHz – 1000 MHz	120 kHz	300 kHz	120 kHz	QP
Above 1 GHz	1 MHz	3 MHz	/	Peak
	1 MHz	10 Hz	/	Ave.

Test Procedure

Maximizing procedure was performed on the highest emissions to ensure that the EUT complied with all installation combinations.

The data was recorded in the Quasi-peak detection mode for below 1 GHz, peak and average detection mode above 1 GHz.

Test Equipment List and Details

Manufacturer	Description	Model	Serial Number	Calibration Date	Calibration Due Date
R&S	EMI Test Receiver	ESCI	100224	2015-08-03	2016-08-02
Sunol Sciences	Antenna	JB3	A060611-3	2014-11-06	2017-11-05
HP	Amplifier	8447E	2434A02181	2015-09-01	2016-09-01
Agilent	Spectrum Analyzer	E4440A	SG43360054	2015-11-23	2016-11-22
ETS-Lindgren	Horn Antenna	3115	9808-5557	2015-09-06	2018-09-06
Mini-Circuit	Amplifier	ZVA-213-S+	054201245	2015-02-19	2016-02-19
Farad	Test Software	EZ-EMC	V1.1.4.2	N/A	N/A

* **Statement of Traceability:** Bay Area Compliance Laboratories Corp. (Dongguan) attests that all calibrations have been performed, traceable to National Primary Standards and International System of Units (SI).

Corrected Amplitude & Margin Calculation

The Corrected Amplitude is calculated by adding the Antenna Loss and Cable Loss, and subtracting the Amplifier Gain from the Meter Reading. The basic equation is as follows:

$$\text{Corrected Amplitude} = \text{Meter Reading} + \text{Antenna Loss} + \text{Cable Loss} - \text{Amplifier Gain}$$

The “**Margin**” column of the following data tables indicates the degree of compliance with the applicable limit. For example, a margin of 7 dB means the emission is 7 dB below the limit. The equation for margin calculation is as follows:

$$\text{Margin} = \text{Limit} - \text{Corrected Amplitude}$$

Test Results Summary

According to the data in the following table, the EUT complied with the FCC Part 15 B Class B, with the worst margin reading of:

6.00 dB at 175.5000 MHz in the Vertical polarization

Test Data

Environmental Conditions

Temperature:	20.2 °C
Relative Humidity:	72%
ATM Pressure:	101.4 kPa

* The testing was performed by Jone Lvon 2016-01-22.

Test Result: Compliance

Below 1G

Test Mode: Downloading

Horizontal

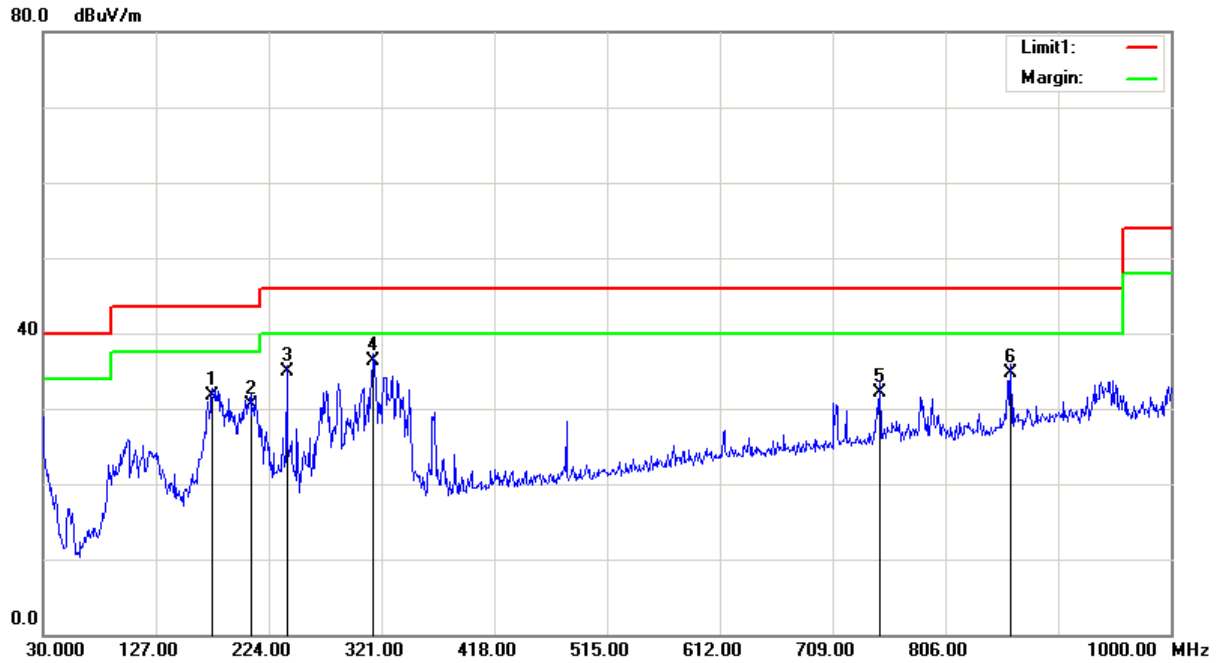

Frequency (MHz)	Receiver Reading (dBµV)	Detector (PK/QP/Avg)	Correction Factor (dB/m)	Cord. Amp. (dBµV/m)	Limit (dBµV/m)	Margin (dB)
175.5000	40.09	QP	-8.39	31.70	43.50	11.80
208.4800	38.97	QP	-8.47	30.50	43.50	13.00
239.5200	42.31	QP	-7.41	34.90	46.00	11.10
314.2100	41.36	QP	-4.96	36.40	46.00	9.60
749.7400	29.80	QP	2.40	32.20	46.00	13.80
862.2600	31.00	QP	3.70	34.70	46.00	11.30

Vertical

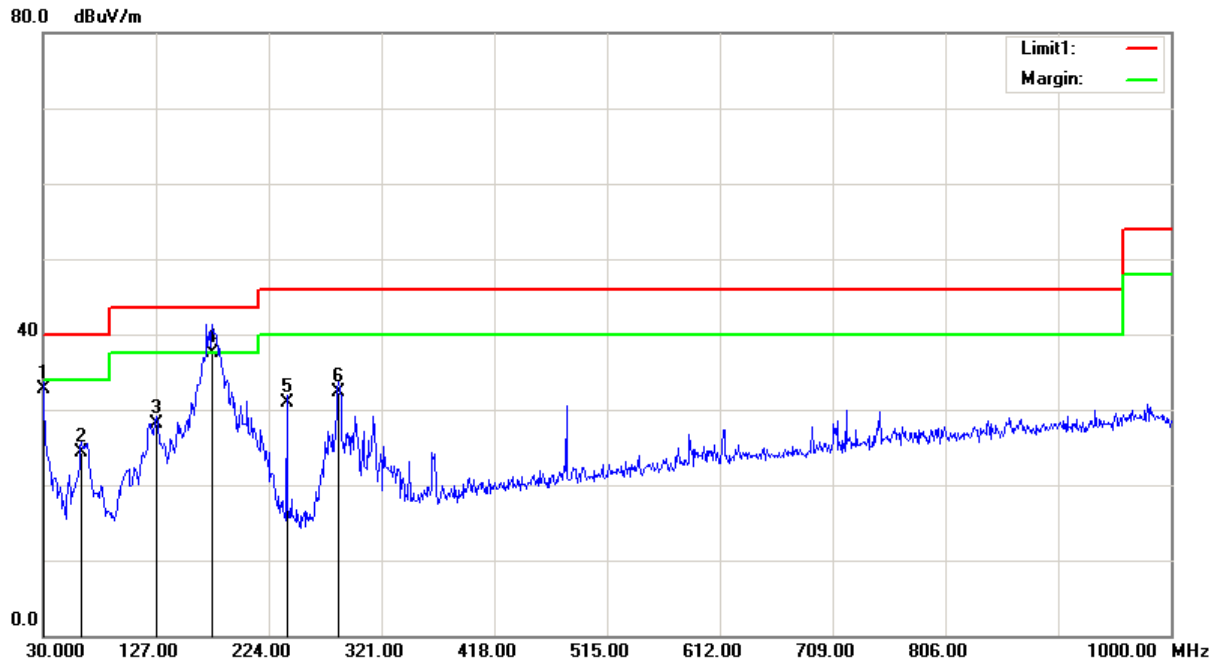

Frequency (MHz)	Receiver Reading (dBµV)	Detector (PK/QP/Avg)	Correction Factor (dB/m)	Cord. Amp. (dBµV/m)	Limit (dBµV/m)	Margin (dB)
30.0000	31.10	QP	1.70	32.80	40.00	7.20
62.9800	36.88	QP	-12.58	24.30	40.00	15.70
127.9700	34.00	QP	-5.80	28.20	43.50	15.30
175.5000	45.89	QP	-8.39	37.50	43.50	6.00
239.5200	38.31	QP	-7.41	30.90	46.00	15.10
284.1400	38.09	QP	-5.69	32.40	46.00	13.60

Above 1G

Test Mode: Downloading

Horizontal

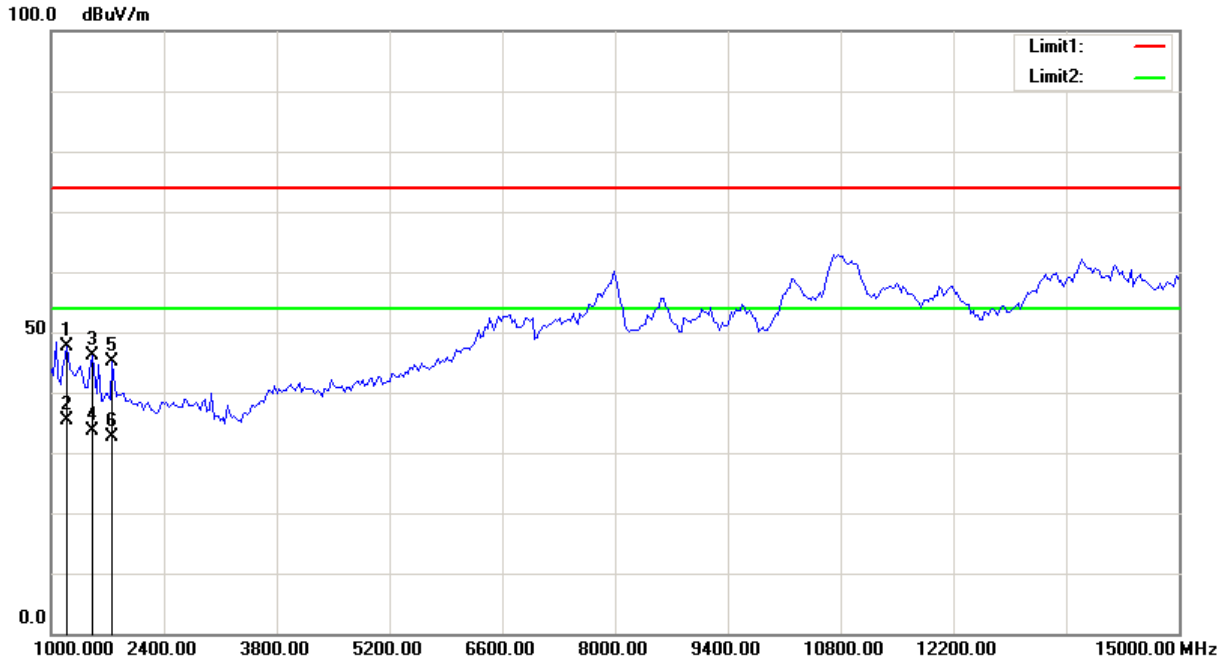

Frequency (MHz)	Receiver Reading (dBμV)	Detector (PK/QP/Avg)	Correction Factor (dB/m)	Cord. Amp. (dBμV/m)	Limit (dBμV/m)	Margin (dB)
1196.393	42.98	peak	4.55	47.53	74.00	26.47
1196.393	30.71	AVG	4.55	35.26	54.00	18.74
1505.010	42.91	peak	3.21	46.12	74.00	27.88
1505.010	30.48	AVG	3.21	33.69	54.00	20.31
1757.515	42.06	peak	2.96	45.02	74.00	28.98
1757.515	29.61	AVG	2.96	32.57	54.00	21.43

Vertical

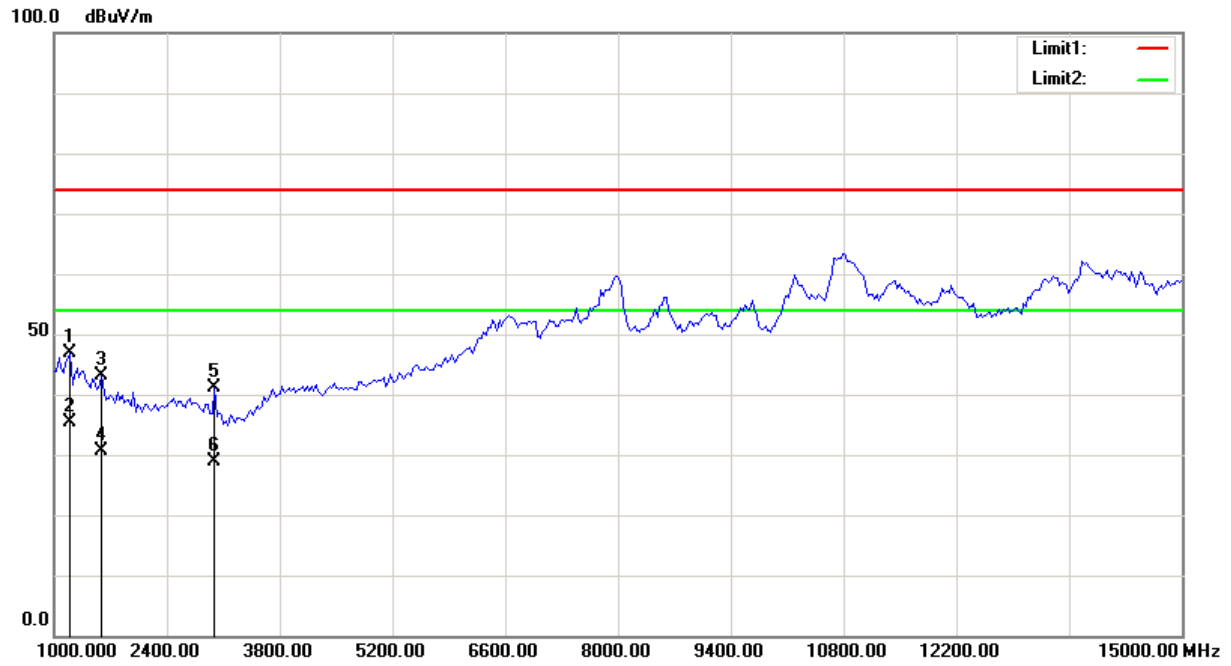

Frequency (MHz)	Receiver Reading (dBµV)	Detector (PK/QP/Avg)	Correction Factor (dB/m)	Cord. Amp. (dBµV/m)	Limit (dBµV/m)	Margin (dB)
1196.393	42.26	peak	4.55	46.81	74.00	27.19
1196.393	30.72	AVG	4.55	35.27	54.00	18.73
1589.178	39.47	peak	3.68	43.15	74.00	30.85
1589.178	26.98	AVG	3.68	30.66	54.00	23.34
2991.984	36.41	peak	4.82	41.23	74.00	32.77
2991.984	23.97	AVG	4.82	28.79	54.00	25.21

******* END OF REPORT *******