

VDDC=1.25V DEFAULT

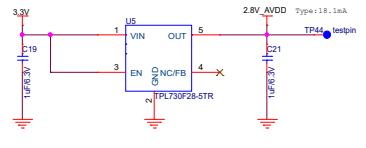

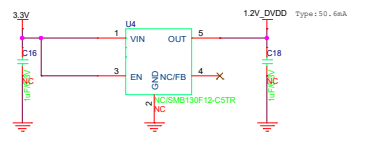

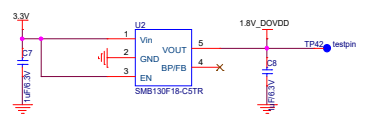

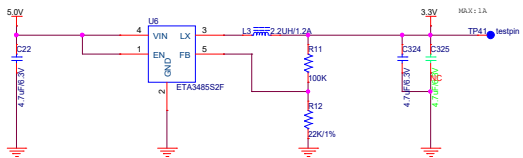
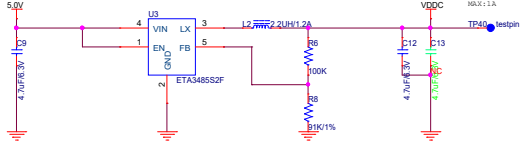
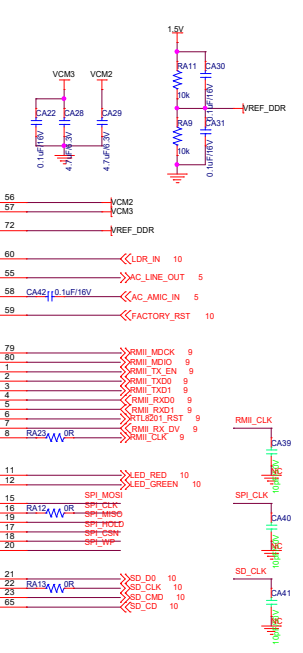
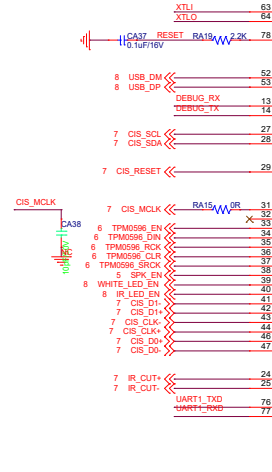
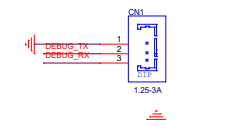
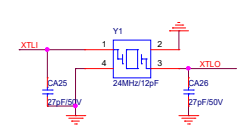
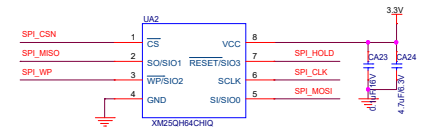
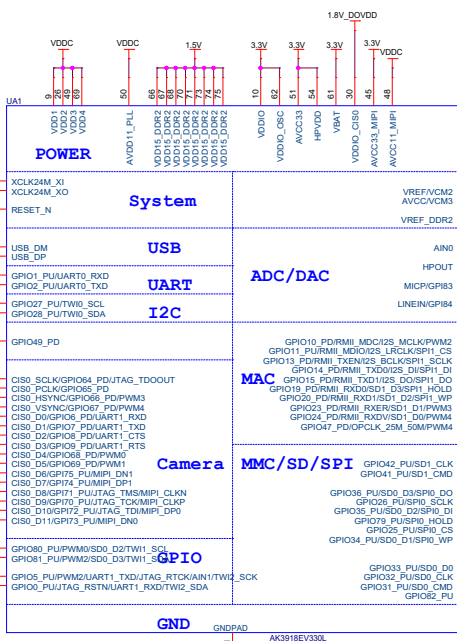
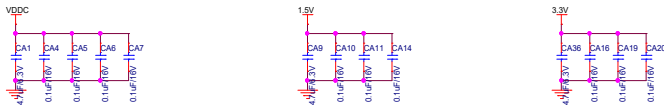
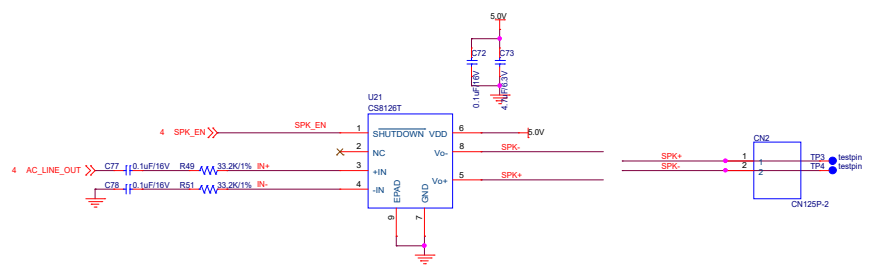
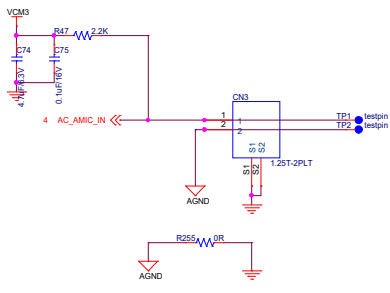
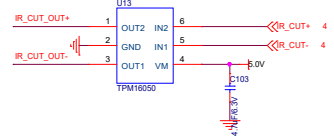
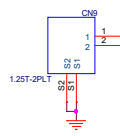
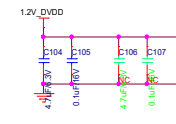
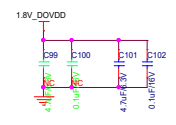
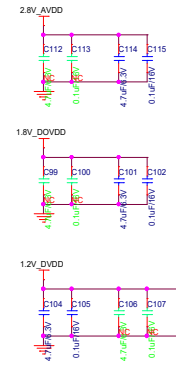
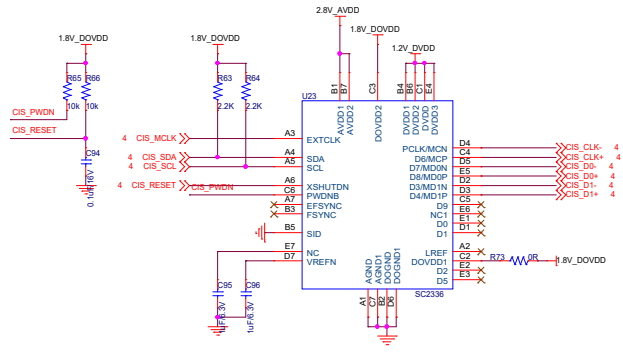

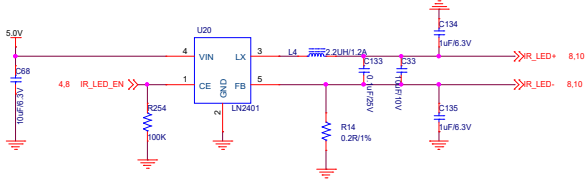
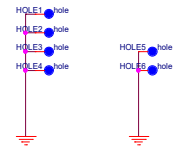
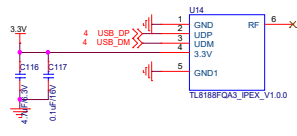

5

4

3

2

1

D

D

C

C

B

B

A

A

5

4

3

2

1

