

Antenna Specifications

CUSTOMER			
CS P/N		MDT865	
HX P/N		<u>A20-073-MDT865</u>	
Checked by(RF)	Checked by(ME)	Checked by(QA)	Approval led by
Customer Approval			



Index

1. General Description	3
1.1 Print Acceptance	3
1.2 Coordinate System	3
2. Specifications	4
2.1 Frequency Band	5
2.2 Impedance	5
2.2.1 Nominal	5
2.2.2 Matching Circuit	5
2.3 Passive Measurements	6
2.3.1 S11 of the Typical Sample	6
2.3.2 Effi& Gain Specifications	9
Main	9
.....	9
div	10
.....	10
WIFI/BT	11
2.3.3 antenna radiation patter	11
MAIN	12
.....	12
2.4 Active Measurements	19
2.4.1 Active Measurements Data	19
3 Mechanical Properties	22
Specifications Drawings	22
4. Environmental Characteristic	28

1. General Description

This document provides the antenna specifications on electric, mechanic and reliability. The testing conditions and related pictures are also included.

1.1 Print Acceptance

Samples and Antenna Specifications are to be sent to customer. When they are approved, the approval form should be completed, signed, and sent back to HX before further mass production batches can be delivered.

1.2 Coordinate System

The coordinate system for the phone is defined as follows:

- Origin in center of gravity.
- Positive X axis is perpendicular to, and directed from, front plane.
- Positive Y axis is perpendicular to, and directed from, right side plane (as seen from front).
- Positive Z axis is perpendicular to, and directed from, top plane.

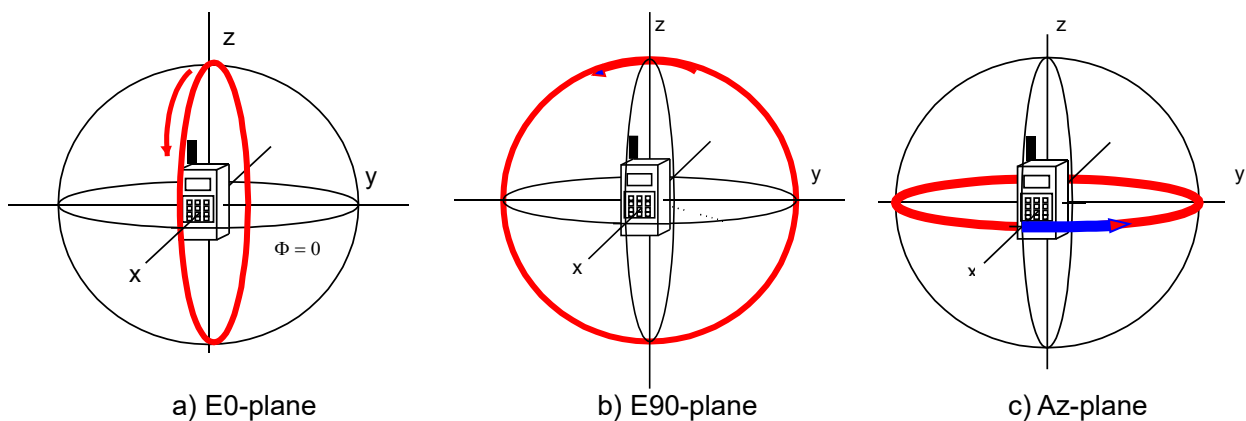

Figure 1-1 The coordinate system for the phone

2. Specifications

This report mainly provides the testing conditions of various electric and structural performance parameters for cell phone antenna ----MDT865 Figure 2-1 shows the antenna designed by HXT & The fixturing of MDT865

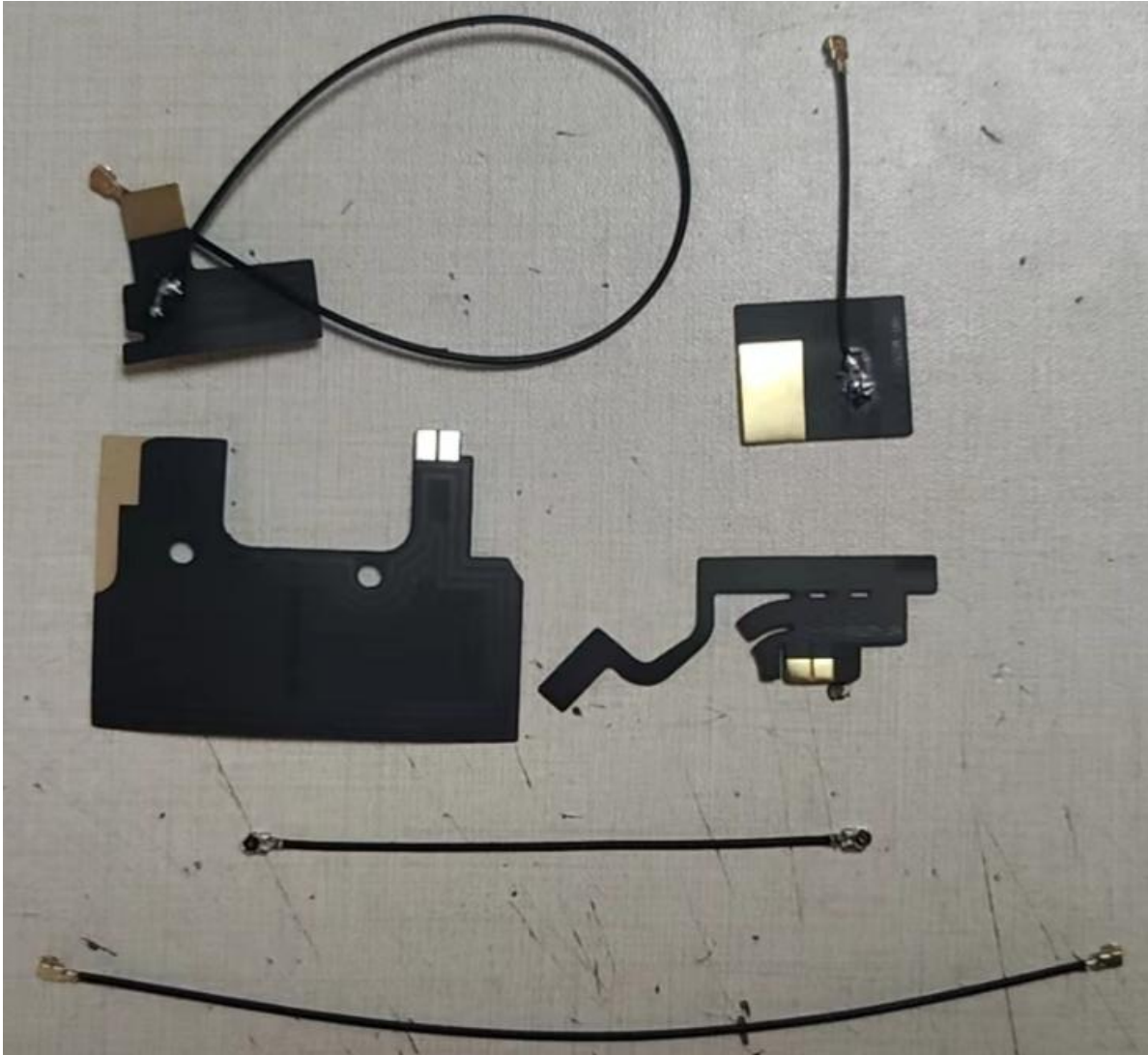

Figure 2-1 The antenna designed by HXT & The fixturing of MDT865

2.1 Frequency Band

	Frequency Band	Tx(MHz)/Rx(MHz)
Main	G850/900/1800/1900	700~960, 1710~2690
	W1/2/4/5/8/FDD B1/2/3/4/5/7/8/12/17/20/28/66/TDD38/40/41	
WIFI	2.4G WIFI/BT/5G WIFI	2400~2500,5185~5825
DIV	FDD B1/2/3/4/7/66/TDD38/40/41	1710~2170,2500~2690

2.2 Impedance

2.2.1 Nominal

Nominal Impedance(including matching circuit) : 50 ohms

2.2.2 Matching Circuit

The matching circuit is as Figure 2-2.

Main

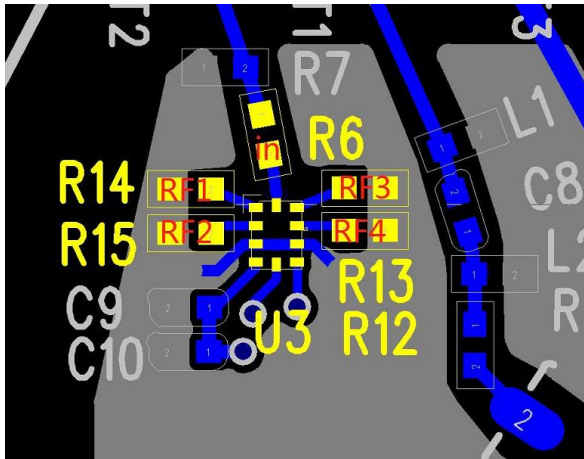

位号	值
L1	0.75p
C8	2.2N
L2	10N
R5	0 Ω
R7	15n
R6	0 Ω
R14	0 Ω
R15	6.8n
R13	NC
R12	10N

开关逻辑	频段
RF1	GSM 2/3/8/WCDMA 1/2/4/8/4G1/2/3/4/7/8/66/38/40/41
RF2	GSM 5/WCDMA 5/4G 5
RF3	4G 12/17/28
RF4	4G 20

WiFi/div

	位号	匹配
GPS (无改动)	无改动	
DIV		

Figure 2-2: Matching circuit



2.3 Passive Measurements

2.3.1 S11 of the Typical Sample

Main(RF1)

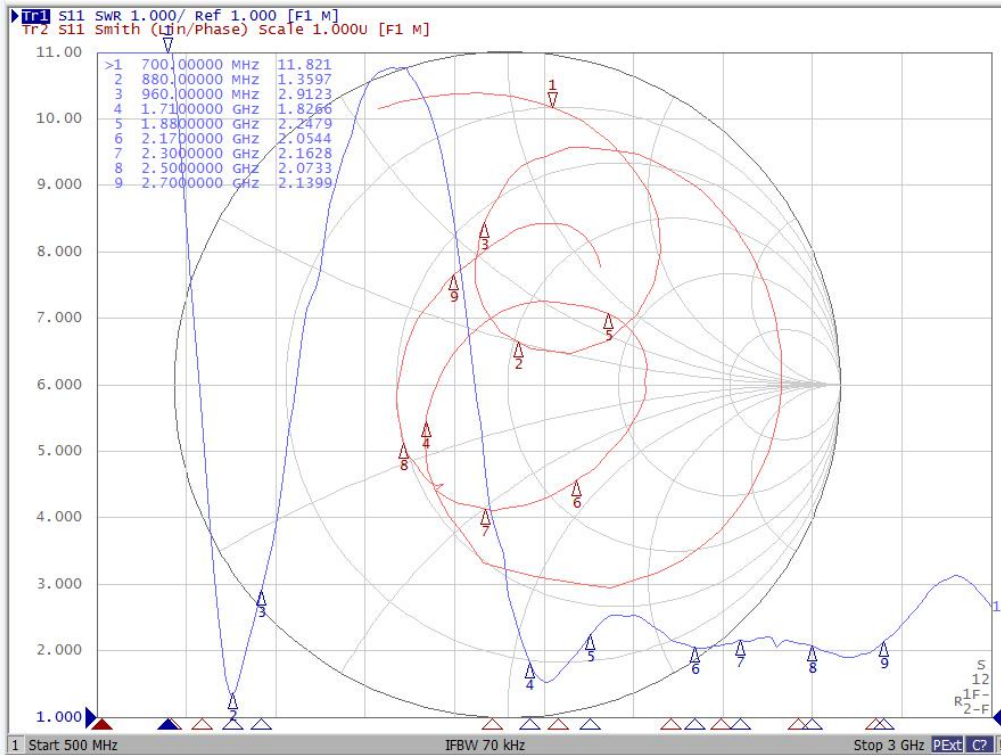

Main(RF2)

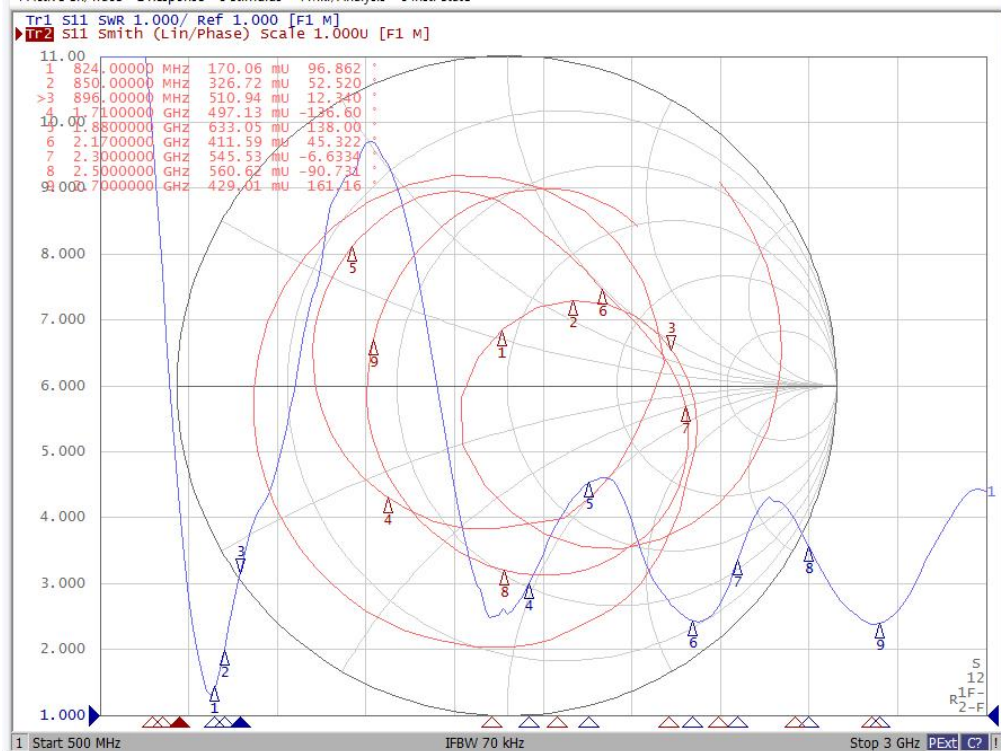

Add: 3/F, Building 4, XinJianXing Industrial Park, Yangguang Industrial Zone, Xili Town, Nanshan District, ShenZhen, P.R.China,
Tel. +86-755-27657751 Fax +86-755-27599500



Antenna Specifications

SHENZHEN HENGXIANGTONG ANTENNA TECHNOLOGY CO., LTD.

Main(RF3)

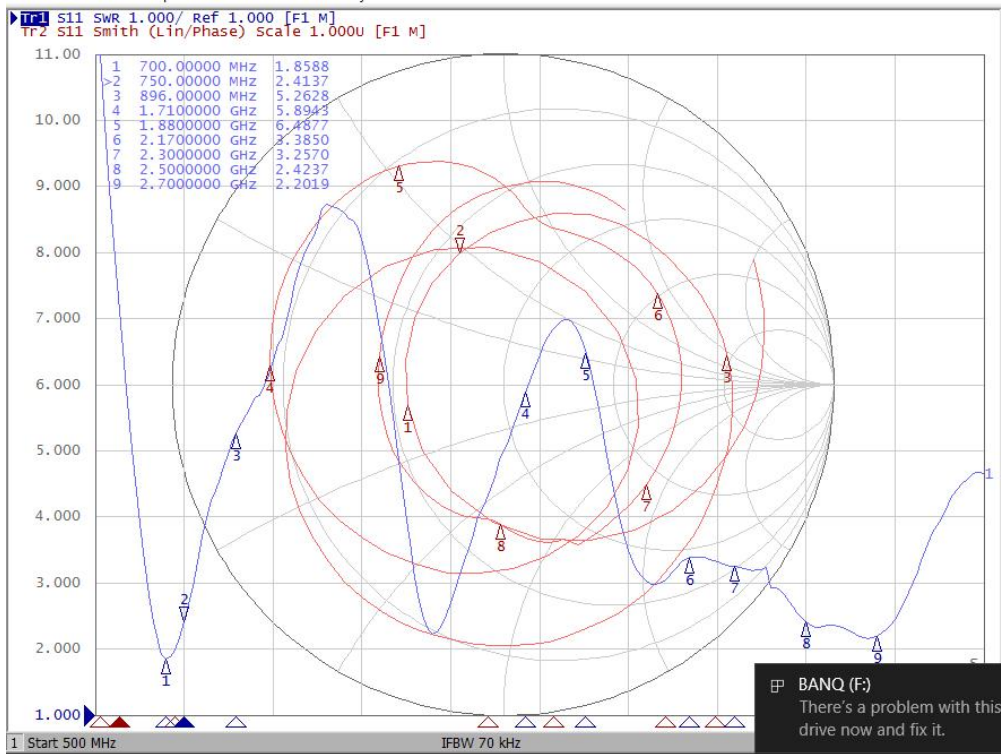

Main(RF4)

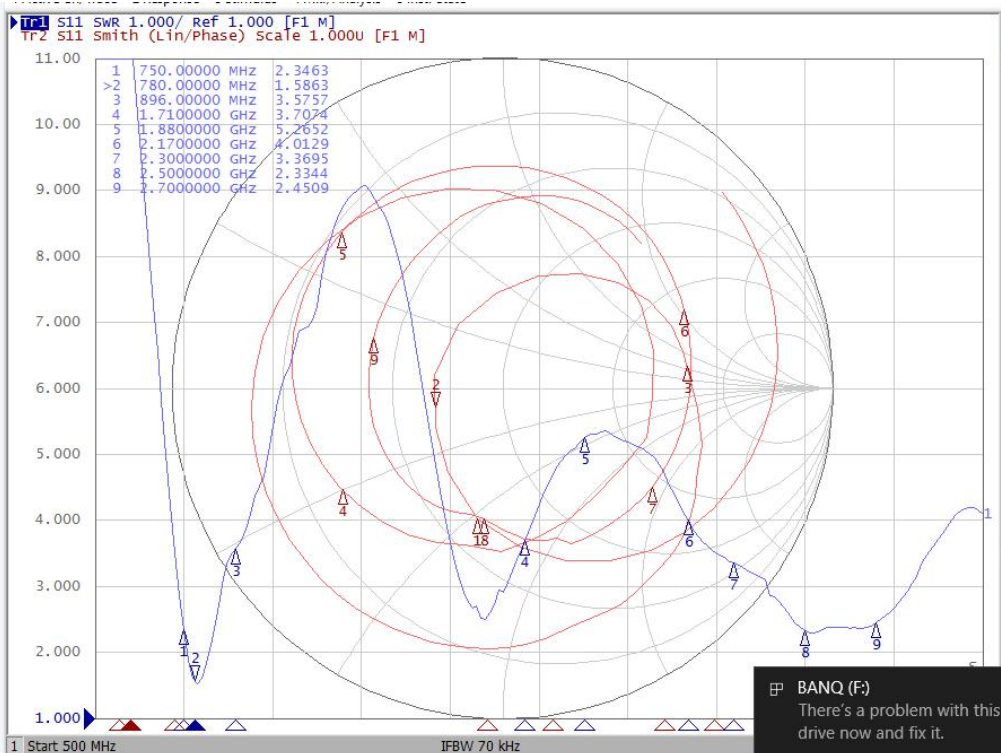

Add: 3/F, Building 4, XinJianXing Industrial Park, Yangguang Industrial Zone, Xili Town, Nanshan District, ShenZhen, P.R.China,
Tel. +86-755-27657751 Fax +86-755-27599500

DIV

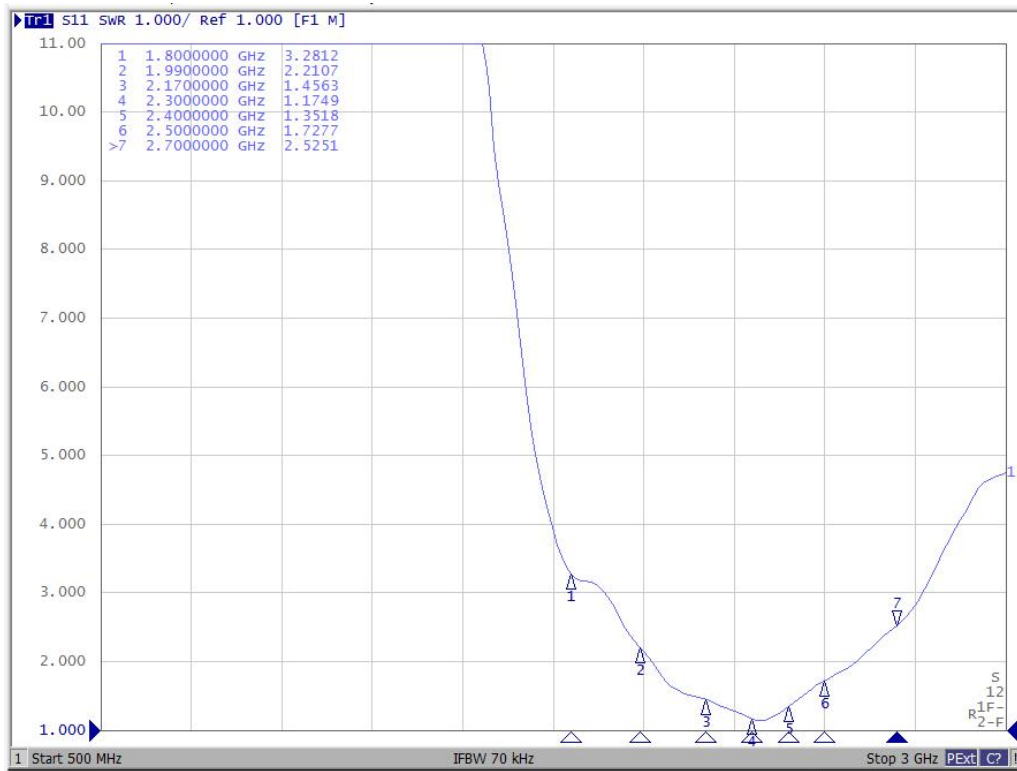

WIFI

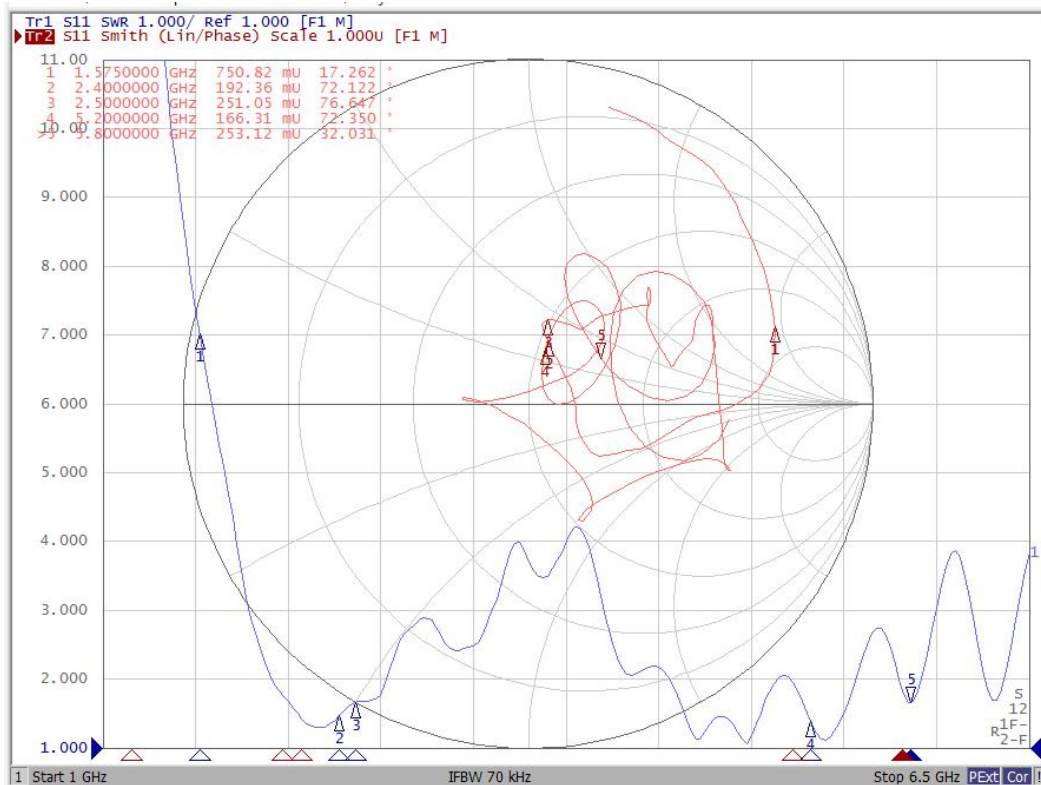

Add: 3/F, Building 4, XinJianXing Industrial Park, Yangguang Industrial Zone, Xili Town, Nanshan District, ShenZhen, P.R.China,
 Tel. +86-755-27657751 Fax +86-755-27599500



Antenna Specifications

SHENZHEN HENGXIANGTONG ANTENNA TECHNOLOGY CO., LTD.

2.3.2 Effi& Gain Specifications

Technical Specification	
product model	MDT865
	Antenna Gain(dBi)
GSM850	-0.16
GSM900	0.7
DCS1800	1.42
PCS1900	1.83
WCDMA B1	1.72
WCDMA B2	1.83
WCDMA B4	1.0
WCDMA B5	-0.16
WCDMA B8	0.7
FDD B1	1.72
FDD B2	1.83
FDD B3	1.42
FDD B4	1.0
FDD B5	-0.16
FDD B7	0.08
FDD B8	0.7
FDD B12	-2.28
FDD B17	-2.28
FDD B20	0.6
FDD B28	-2.28
FDD B66	1.42
TDD B38	-0.34
TDD B40	0.56
TDD B41	0.08



Antenna Specifications

SHENZHEN HENGXIANGTONG ANTENNA TECHNOLOGY CO., LTD.

div

(MHz)	Effi (dB)	Effi (dBi)	Effi (%)	(MHz)	Effi (dB)	Effi (dBi)	Effi (%)	(MHz)	Effi (dB)	Effi (dBi)	Effi (%)
1770	-7.34	-3.49	18.44	2010	-4.25	-0.45	37.6	2500	-5.3	-1.57	29.54
1780	-7.16	-3.24	19.22	2020	-4.11	-0.06	38.81	2510	-5.45	-1.8	28.52
1790	-7.01	-2.77	19.89	2030	-3.94	0.16	40.39	2520	-5.59	-2.05	27.61
1800	-7	-2.44	19.94	2040	-3.84	0.37	41.29	2530	-5.78	-2.4	26.45
1810	-6.89	-2.13	20.44	2050	-3.78	0.31	41.88	2540	-6	-2.78	25.14
1820	-6.85	-1.92	20.67	2060	-3.74	0.23	42.24	2550	-6.12	-3.08	24.41
1830	-6.75	-1.65	21.16	2070	-3.74	0.31	42.29	2560	-6.31	-3.26	23.38
1840	-6.61	-1.38	21.84	2080	-3.77	0.37	41.94	2570	-6.5	-3.5	22.36
1850	-6.61	-1.27	21.85	2090	-3.84	0.44	41.31	2580	-6.62	-3.56	21.78
1860	-6.56	-1.22	22.07	2100	-3.86	0.51	41.16	2590	-6.75	-3.61	21.13
1870	-6.56	-1.32	22.06	2110	-3.87	0.6	40.98	2600	-6.86	-3.62	20.6
1880	-6.62	-1.56	21.8	2120	-3.89	0.72	40.85	2610	-6.89	-3.56	20.44
1890	-6.54	-1.77	22.19	2130	-3.88	0.94	40.91	2620	-7	-3.58	19.97
1900	-6.28	-1.8	23.55	2140	-3.86	1.1	41.1	2630	-7.09	-3.62	19.55
1910	-6	-1.84	25.14	2150	-3.9	1.2	40.78	2640	-7.24	-3.81	18.86
1920	-5.73	-1.81	26.73	2160	-3.92	1.21	40.53	2650	-7.39	-4.02	18.23
1930	-5.6	-1.95	27.52	2170	-3.97	1.15	40.13	2660	-7.47	-4.13	17.89
1940	-5.42	-2.04	28.68	2180	-4.07	1.04	39.19	2670	-7.53	-4.16	17.67
1950	-5.19	-1.92	30.27	2190	-4.14	0.94	38.53	2680	-7.55	-4.24	17.57
1960	-5.08	-1.71	31.03	2200	-4.28	0.77	37.31	2690	-7.54	-4.23	17.61
1970	-4.88	-1.41	32.52	2300	-4.98	-0.03	31.74	2700	-7.63	-4.24	17.25
1980	-4.74	-1.12	33.6	2310	-4.96	-0.11	31.91	2710	-7.67	-4.11	17.08
1990	-4.61	-0.99	34.59	2320	-4.89	-0.17	32.41				
2000	-4.42	-0.75	36.16	2330	-4.76	-0.17	33.43				
				2340	-4.67	-0.19	34.12				
				2350	-4.55	-0.14	35.07				
				2360	-4.48	-0.15	35.62				
				2370	-4.49	-0.24	35.56				
				2380	-4.51	-0.31	35.44				
				2390	-4.61	-0.51	34.56				
				2400	-4.7	-0.86	33.89				
				2410	-4.86	-0.93	32.63				
				2420	-4.85	-1.06	32.7				

Add: 3/F, Building 4, XinJianXing Industrial Park, Yangguang Industrial Zone, Xili Town, Nanshan District, ShenZhen, P.R.China,
 Tel. +86-755-27657751 Fax +86-755-27599500



Antenna Specifications

SHENZHEN HENGXIANGTONG ANTENNA TECHNOLOGY CO., LTD.

WIFI/BT

(MHz)	Effi (dB)	Effi (dBi)	Effi (%)
2360	-2.45	1.42	56.82
2370	-2.37	1.44	57.99
2380	-2.69	1.24	53.84
2390	-2.74	1.17	53.22
2400	-2.77	1	52.87
2410	-2.83	0.89	52.17
2420	-2.82	1.11	52.21
2430	-2.77	1.28	52.85
2440	-2.81	1.38	52.42
2450	-2.73	1.46	53.39
2460	-2.78	1.36	52.71
2470	-2.83	1.23	52.11
2480	-2.86	1.06	51.77
2490	-2.84	1.29	52
2500	-2.8	1.49	52.44
2510	-2.86	1.52	51.8
2520	-3.03	1.41	49.79
2530	-3.25	1.18	47.34
2540	-3.25	1.14	47.32
2550	-3.27	1.16	47.1

(MHz)	Effi (dB)	Effi (dBi)	Effi (%)
5180	-4.4	0.54	36.28
5200	-4.22	1	37.88
5220	-3.9	1.28	40.73
5240	-3.87	1.66	41
5260	-4.04	1.46	39.44
5280	-3.7	1.66	42.68
5300	-3.87	1.39	41.04
5320	-3.63	1.57	43.35
5340	-3.53	1.8	44.33
5360	-3.82	1.12	41.53
5380	-3.4	1.86	45.7
5400	-3.39	1.54	45.82
5420	-3.4	1.46	45.73
5440	-3.58	1.41	43.83
5460	-3.7	0.94	42.66
5480	-3.65	1.06	43.16
5500	-3.49	1.04	44.79
5520	-3.7	0.73	42.62
5540	-3.76	0.96	42.08
5560	-4.09	0.66	39.04
5580	-4.12	0.21	38.73
5600	-4.32	0.22	36.95
5620	-4.24	0.29	37.7
5640	-4.56	0.03	34.97
5660	-4.86	-0.01	32.64
5680	-4.9	0.33	32.39
5700	-4.9	0.06	32.33
5720	-4.89	0.53	32.42
5740	-4.8	0.93	33.08
5760	-5.11	1.05	30.86
5780	-5.06	0.76	31.15
5800	-4.89	1.2	32.43
5820	-4.58	1.04	34.82
5840	-4.56	1.15	35.03
5860	-4.6	0.92	34.7

2.3.3 antenna radiation patter

Add: 3/F, Building 4, XinJianXing Industrial Park, Yangguang Industrial Zone, Xili Town, Nanshan District, ShenZhen, P.R.China,

Tel. +86-755-27657751 Fax +86-755-27599500

MAIN

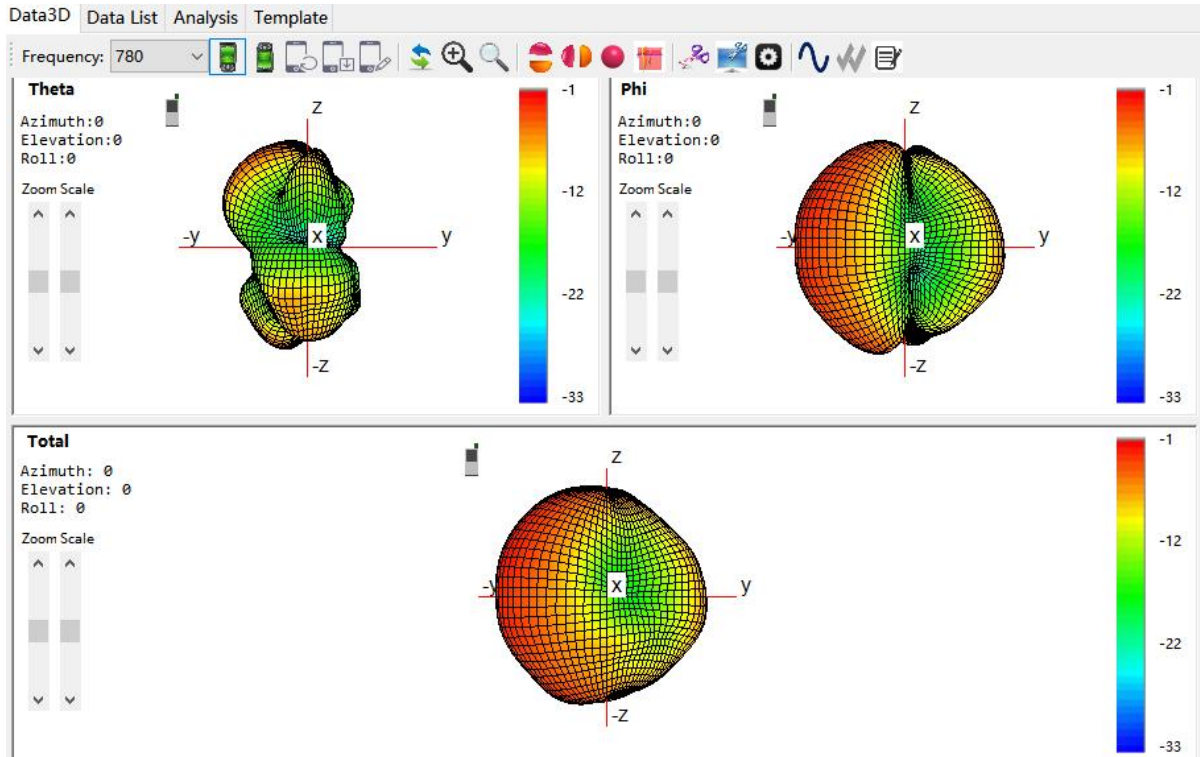
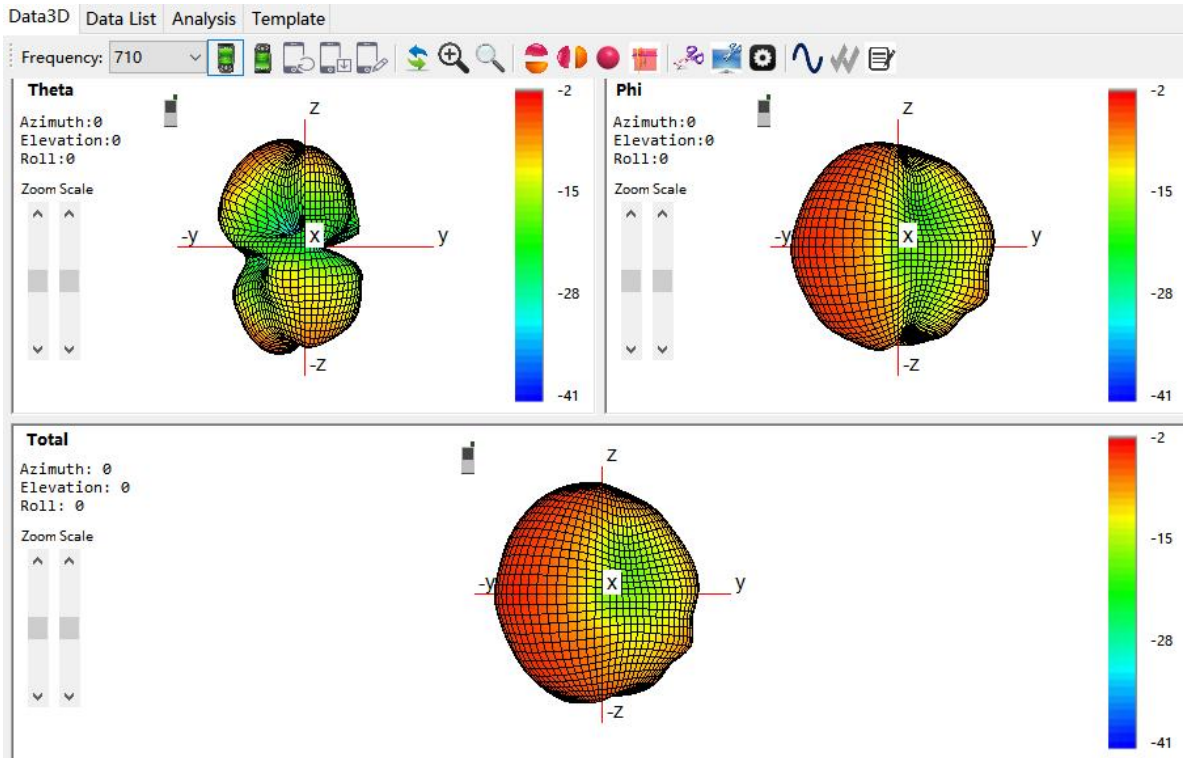

Add: 3/F, Building 4, XinJianXing Industrial Park, Yangguang Industrial Zone, Xili Town, Nanshan District, ShenZhen, P.R.China,
 Tel. +86-755-27657751 Fax +86-755-27599500

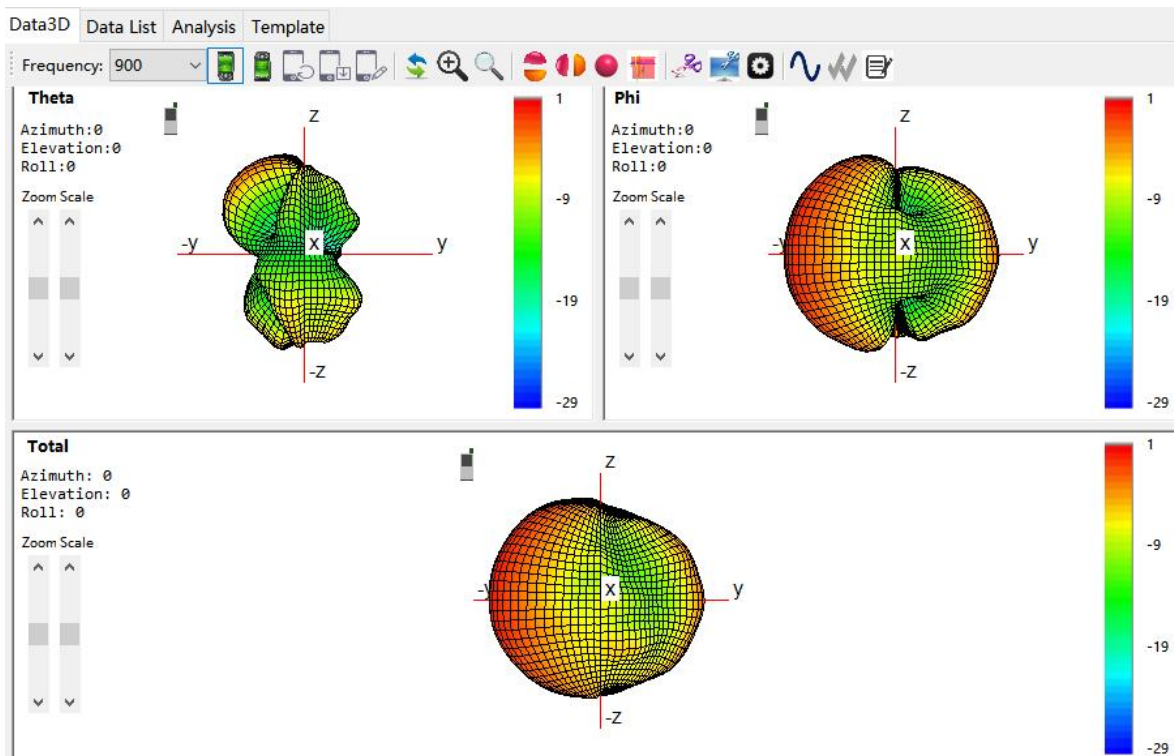
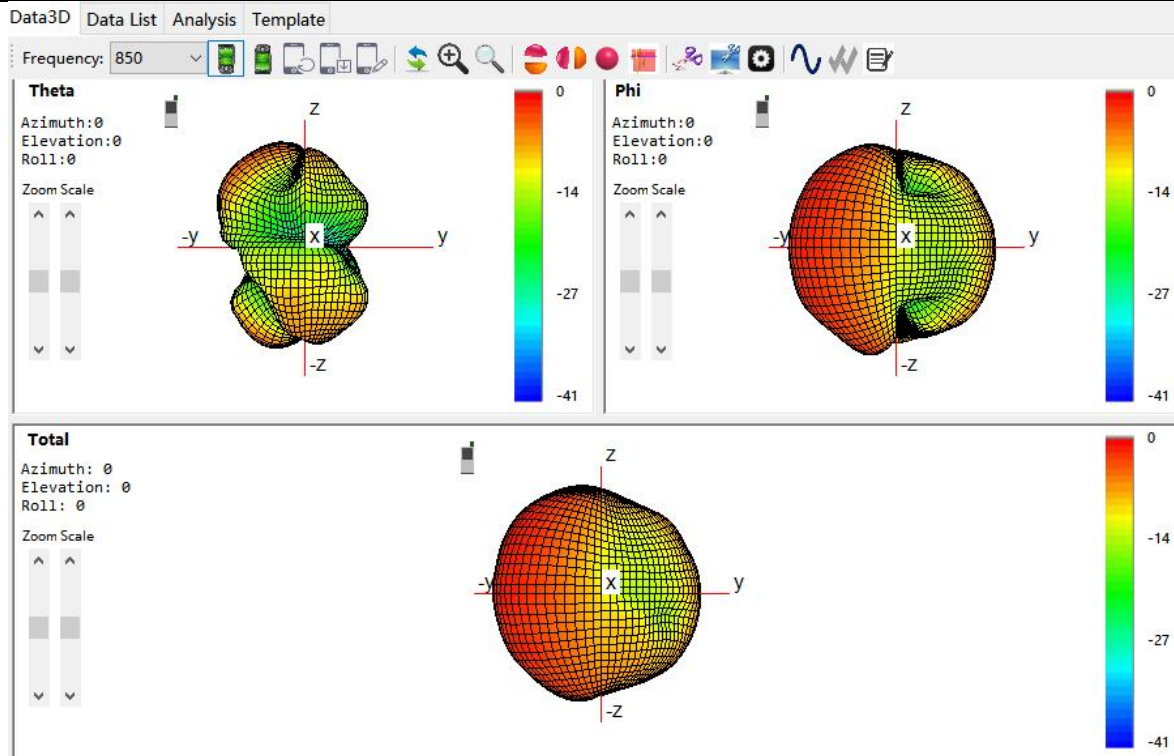

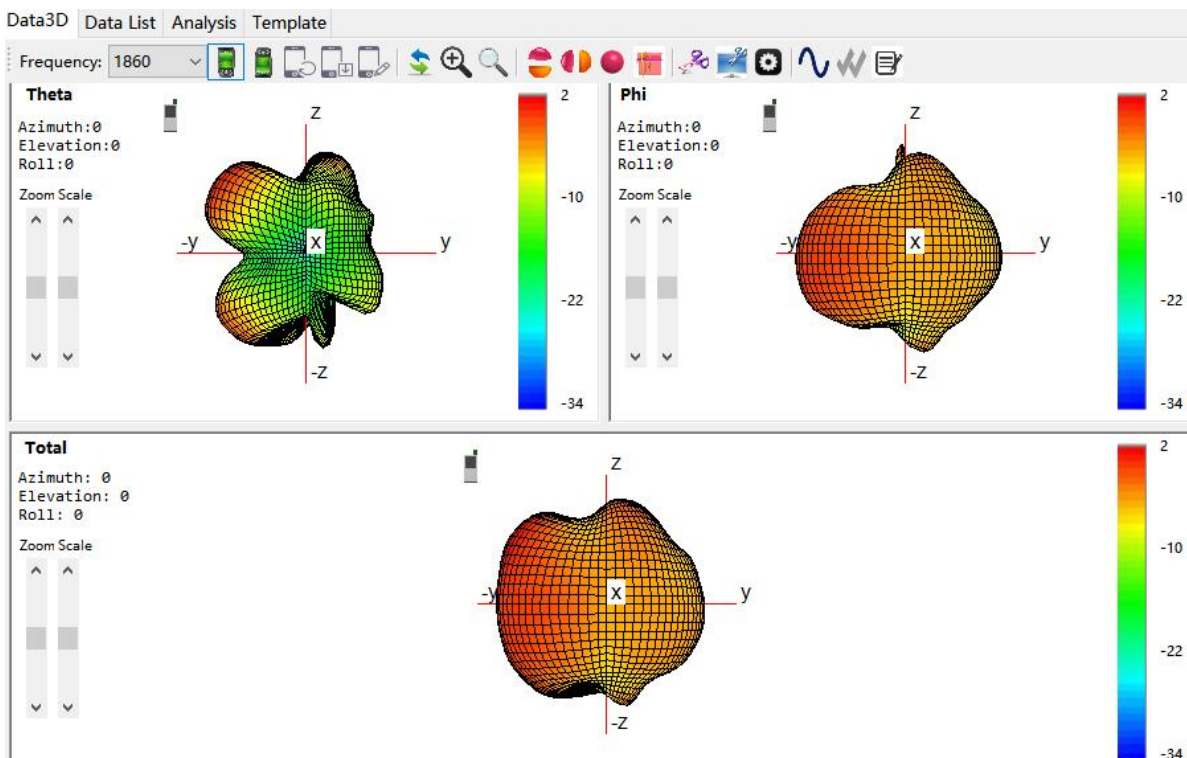
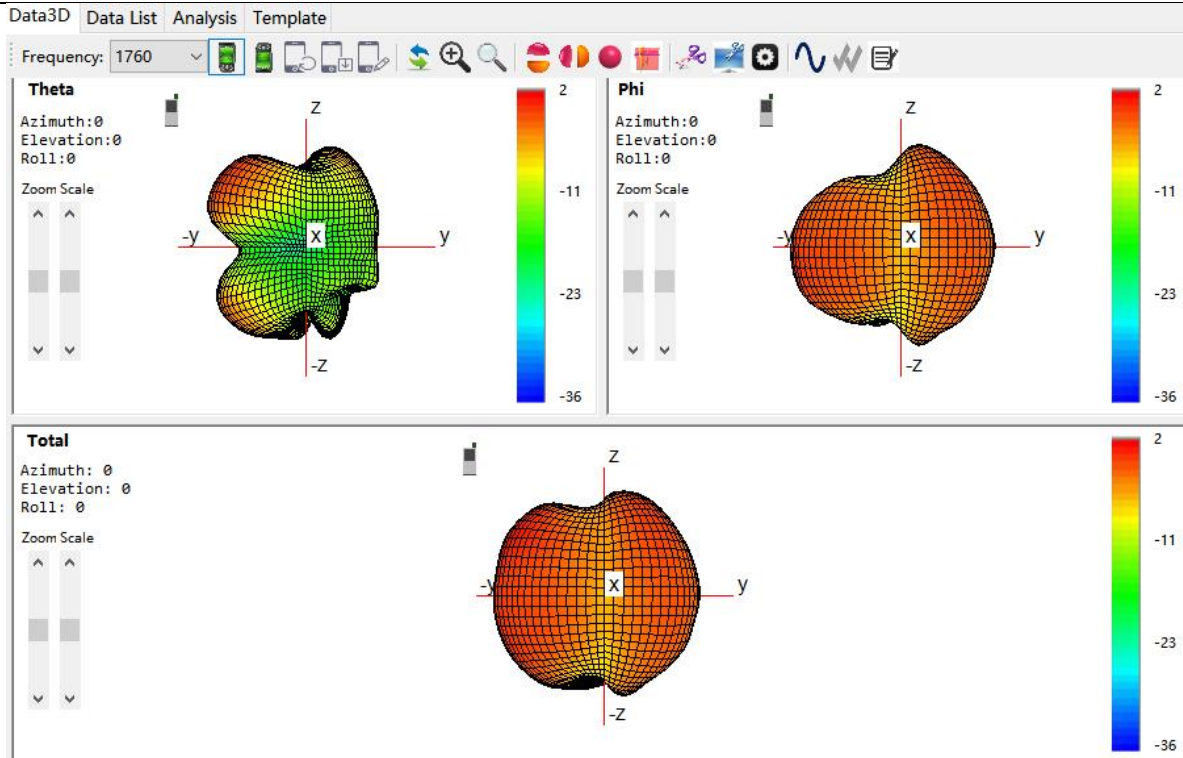

Antenna Specifications
 SHENZHEN HENGXIANGTONG ANTENNA TECHNOLOGY CO., LTD.

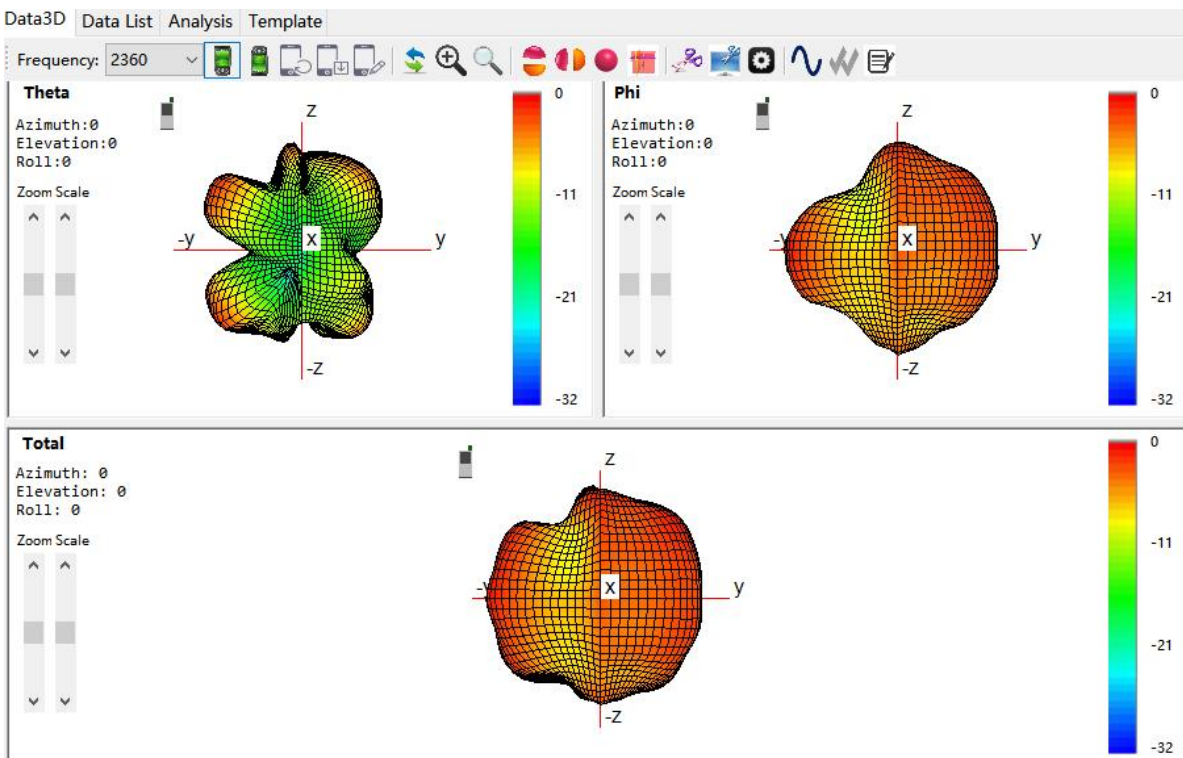
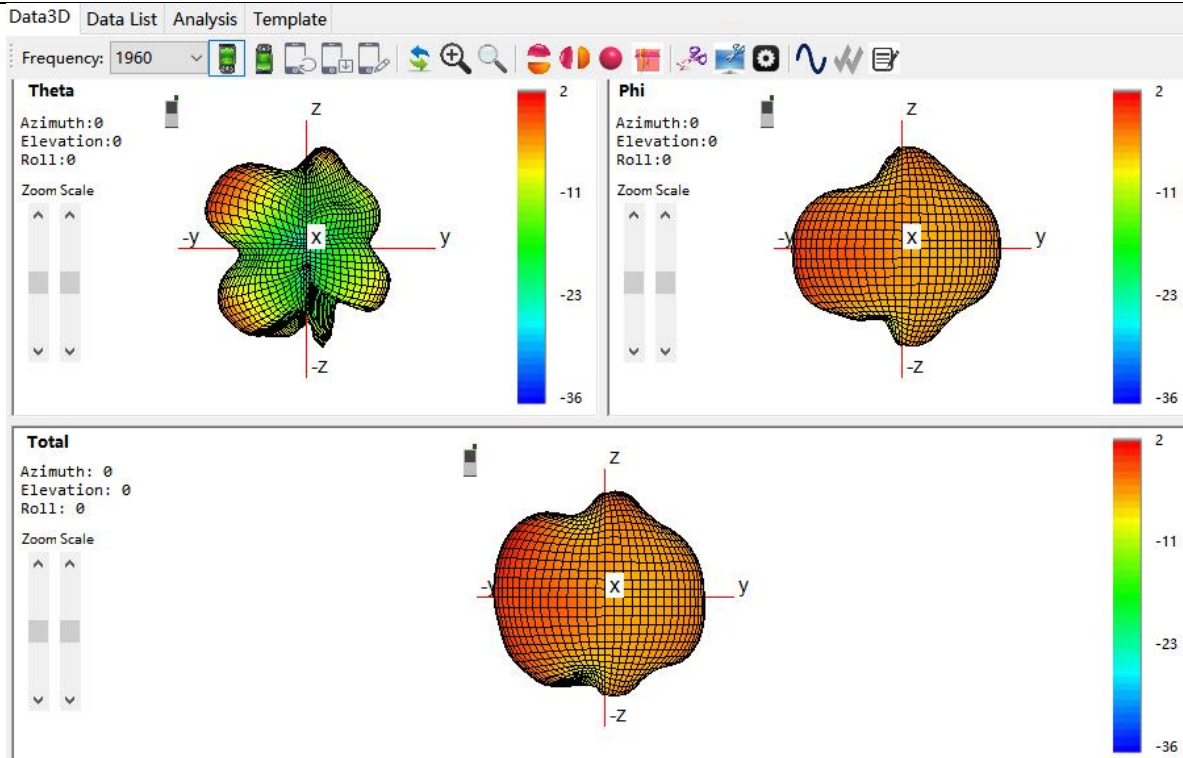

Add: 3/F, Building 4, XinJianXing Industrial Park, Yangguang Industrial Zone, Xili Town, Nanshan District, ShenZhen, P.R.China,
 Tel. +86-755-27657751 Fax +86-755-27599500

Antenna Specifications
 SHENZHEN HENGXIANGTONG ANTENNA TECHNOLOGY CO., LTD.



Add: 3/F, Building 4, XinJianXing Industrial Park, Yangguang Industrial Zone, Xili Town, Nanshan District, ShenZhen, P.R.China,
 Tel. +86-755-27657751 Fax +86-755-27599500

Antenna Specifications
 SHENZHEN HENGXIANGTONG ANTENNA TECHNOLOGY CO., LTD.

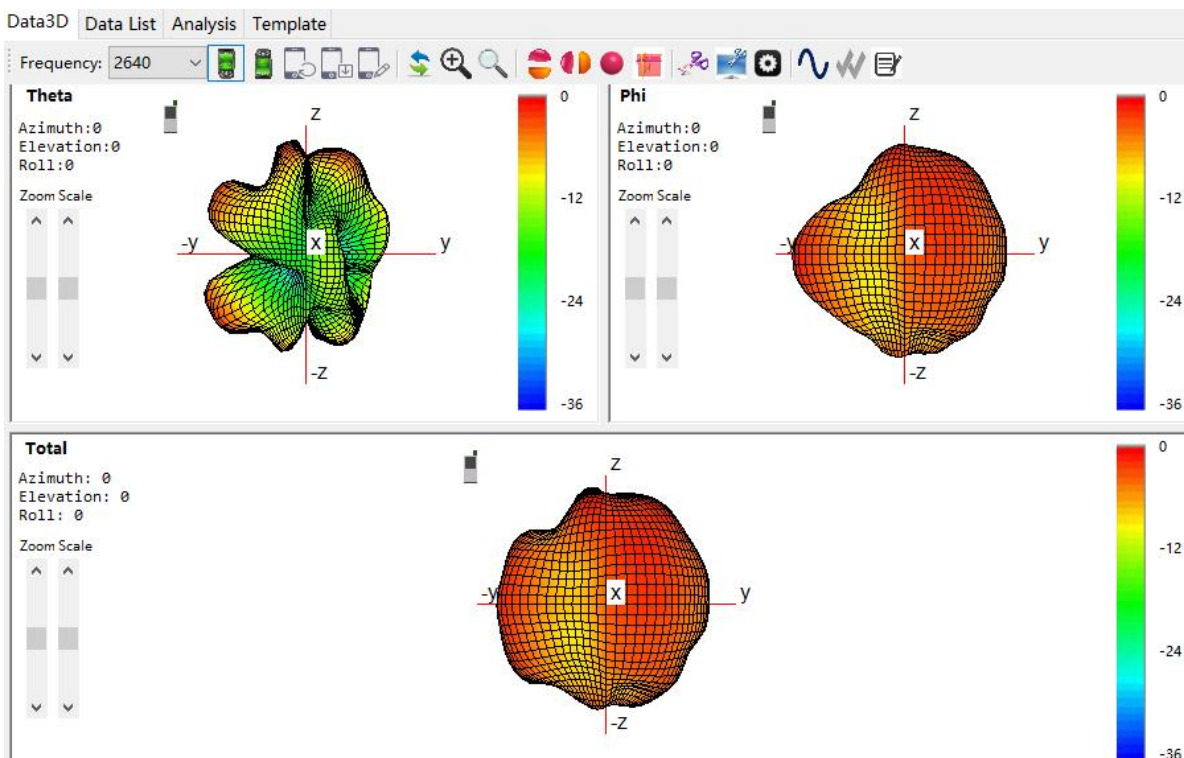
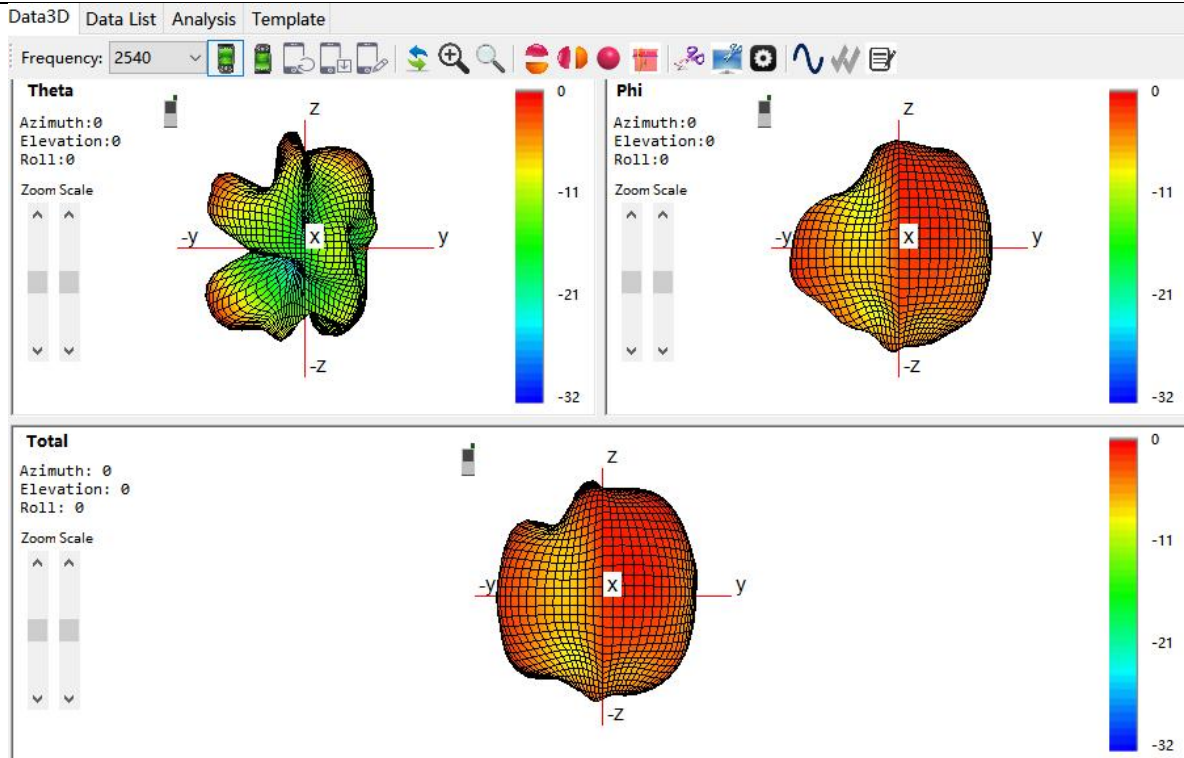

Add: 3/F, Building 4, XinJianXing Industrial Park, Yangguang Industrial Zone, Xili Town, Nanshan District, ShenZhen, P.R.China,
 Tel. +86-755-27657751 Fax +86-755-27599500

WIFI

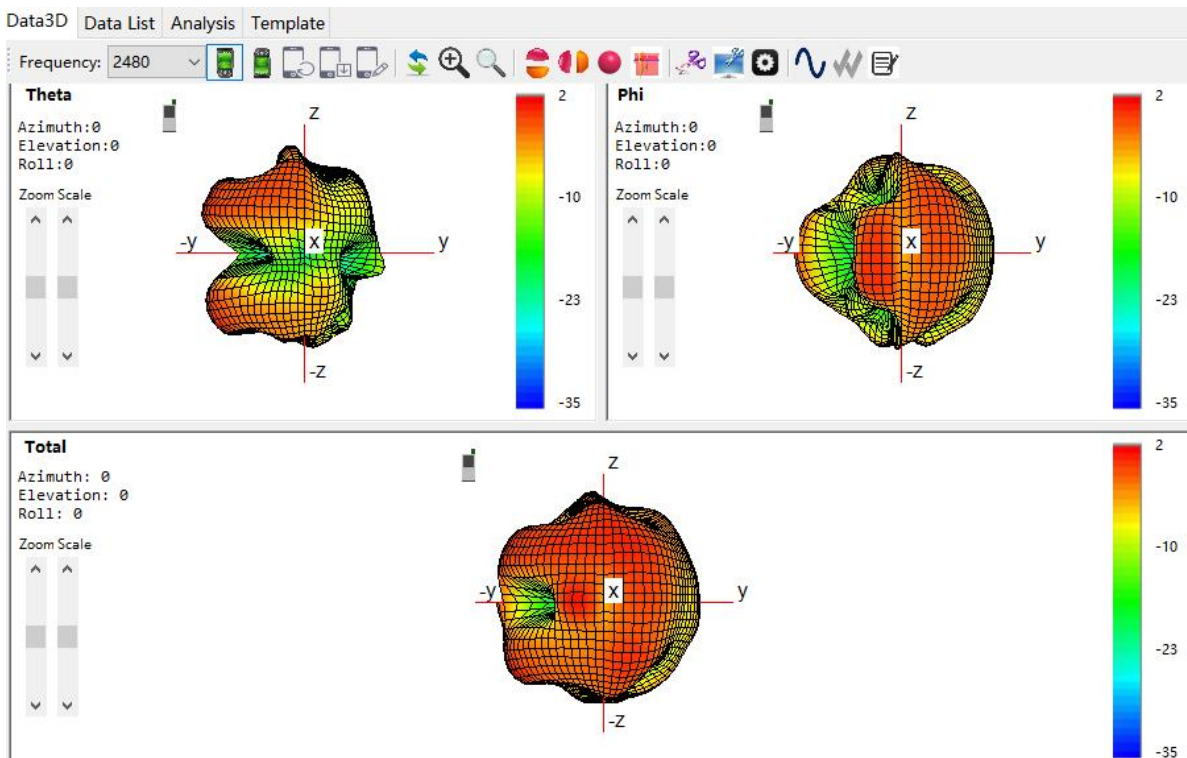
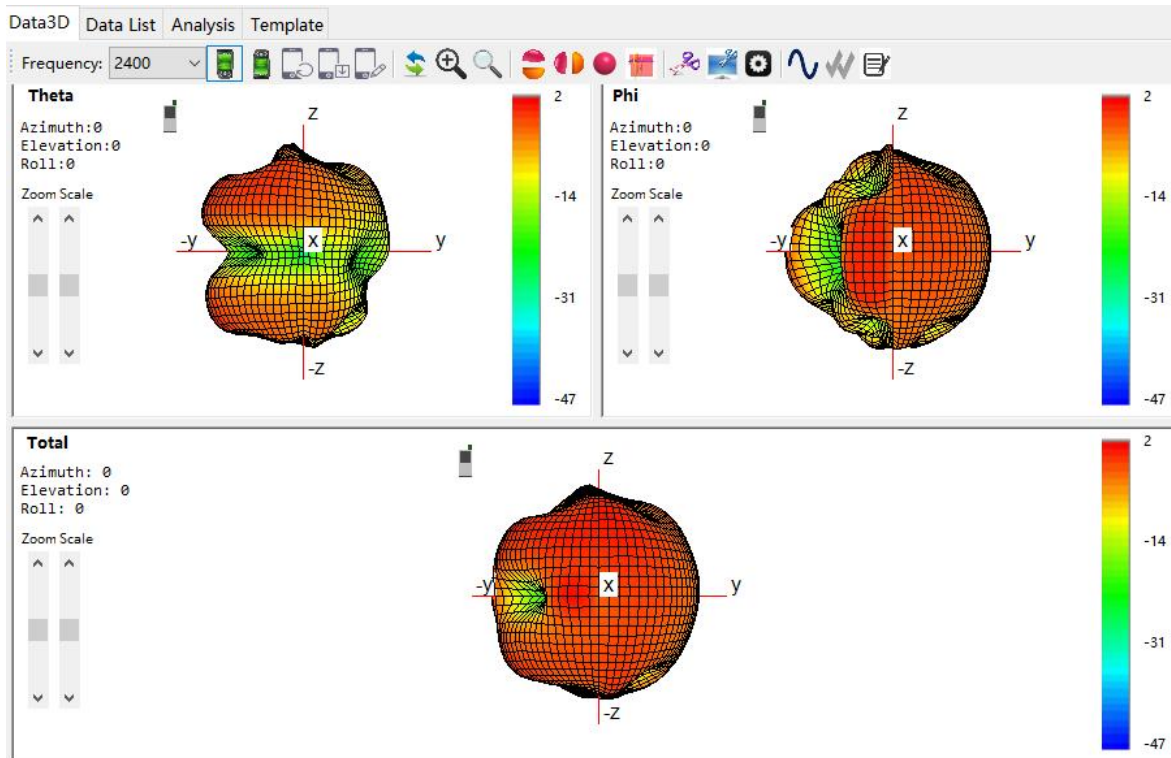

Add: 3/F, Building 4, XinJianXing Industrial Park, Yangguang Industrial Zone, Xili Town, Nanshan District, ShenZhen, P.R.China,
 Tel. +86-755-27657751 Fax +86-755-27599500

Antenna Specifications
SHENZHEN HENGXIANGTONG ANTENNA TECHNOLOGY CO., LTD.

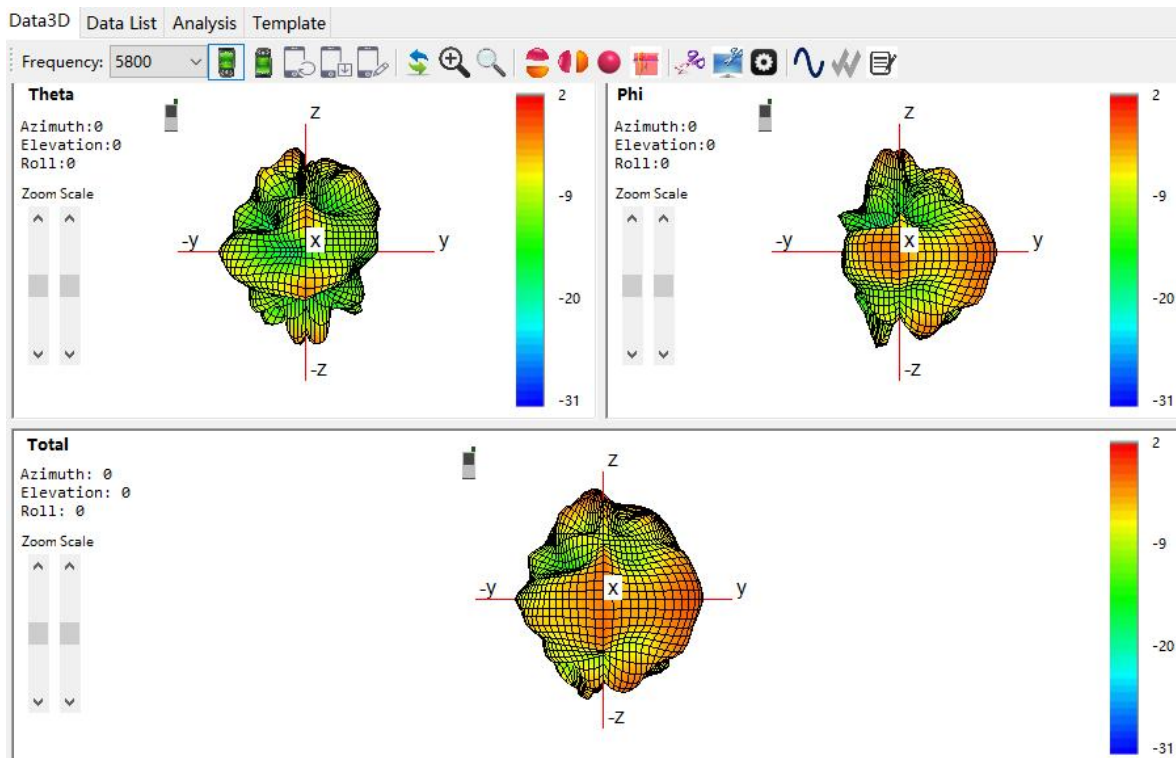
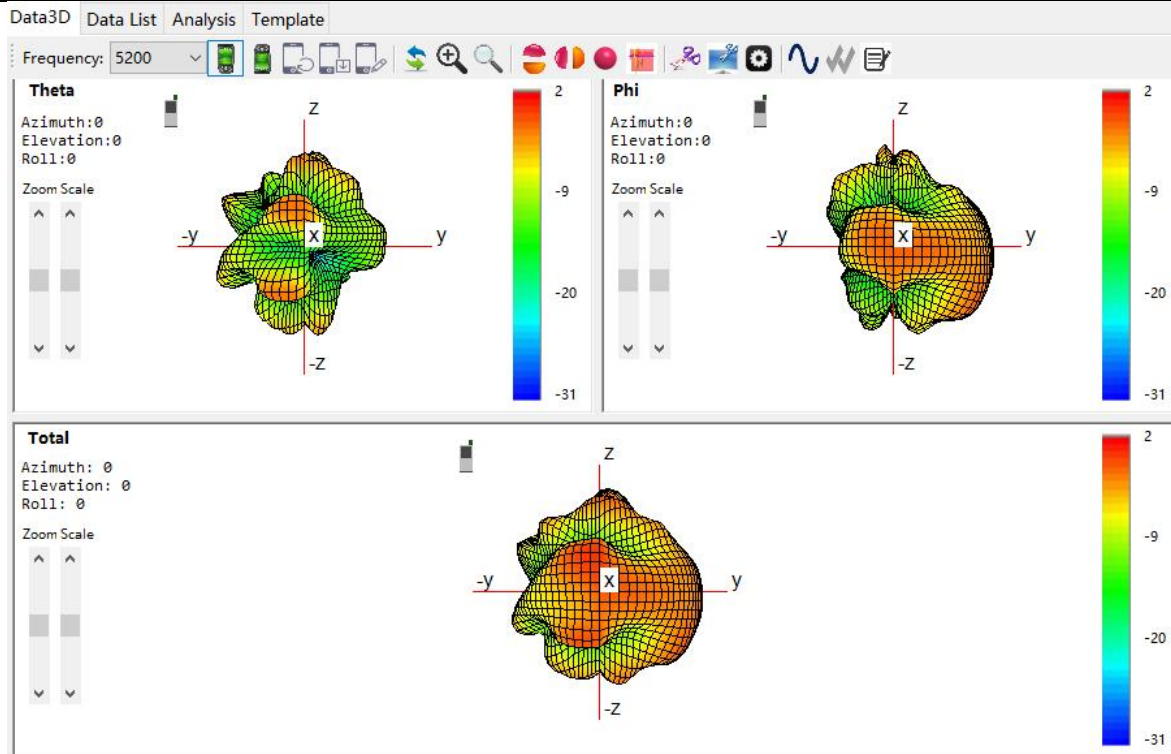

Add: 3/F, Building 4, XinJianXing Industrial Park, Yangguang Industrial Zone, Xili Town, Nanshan District, ShenZhen, P.R.China,
 Tel. +86-755-27657751 Fax +86-755-27599500



Antenna Specifications

SHENZHEN HENGXIANGTONG ANTENNA TECHNOLOGY CO., LTD.

2.4 Active Measurements

2.4.1 Active Measurements Data

Total Radiated Power (TRP) and Total Isotropic Sensitivity (TIS) of the handsets with antenna are tested in the antenna chambers .

Chamber Test Data

Main

2G	CH	TRP	TIS(灭)
GSM850	128	28.47	-104.53
	190	28.35	
	251	28.7	-103.98
EGSM900	1	28.43	-104.9
	62	28.84	
	124	28.45	-103.35
DCS1800	512	25.95	-103.89
	698	25.63	
	885	26.21	-105.16
PCS1900	512	25.85	-103.77
	661	26.09	
	810	25.77	-103.88
3G	CH	TRP	TIS(灭)
WCDMA1	9612	19.42	
	9750	19.24	
	9888	19.04	-104.75
WCDMA2	9662	19.29	
	9800	19.04	
	9938	18.79	-105.79
WCDMA4	1537	18.85	
	1637	18.57	
	1737	18.15	-105.19
WCDMA5	4132	18.66	
	4183	18.67	
	4233	18.38	-105.72
WCDMA8	2712	18.56	
	2787	19.09	
	2863	18.6	-105.29

Add: 3/F,Building4,XinJianXing Industrial Park,Yanguang Industrial Zone, Xili Town, Nanshan District, ShenZhen, P.R.China,

Tel. +86-755-27657751 Fax +86-755-27599500



Antenna Specifications

SHENZHEN HENGXIANGTONG ANTENNA TECHNOLOGY CO., LTD.

4G	CH	TRP	TIS(天)
FDD-B1(10M)	18050	19.96	
	18300	19.5	
	18550	19.41	-96.26
FDD-B2(10M)	18650	19.36	
	18900	19.78	
	19150	19.85	-97.34
FDD-B3(10M)	19250	18.54	
	19900	18.26	
	18550	19.11	-96.06
FDD-B4(10M)	2000	19.16	
	20175	19.42	
	20350	19.03	-96.67
FDD-B5(10M)	20450	18.32	
	20525	18.56	
	20600	17.98	-93.37
FDD-B7(10M)	20800	19.03	
	21100	19.1	
	21400	19.04	-95.69
FDD-B8(10M)	21500	18.39	
	21625	18.86	
	21750	18.24	-94.67
FDD-LTE 12(10M)	23060	16.22	
	23095	16.1	
	23130	16.68	-92.95
FDD-LTE 17(10M)	23780	16	
	23790	16.53	
	23800	16.51	-93.13
FDD-LTE 20(10M)	27260	18.39	
	27435	18.3	
	27610	18.14	-93.24
FDD-LTE 28(10M)	27260	16.07	
	27435	16.77	
	27610	16.85	-92.77
FDD-LTE 66	132022	19.5	
	132322	19.78	
	132602	20.1	-96.12

Add: 3/F, Building 4, XinJianXing Industrial Park, Yangguang Industrial Zone, Xili Town, Nanshan District, ShenZhen, P.R.China,

Tel. +86-755-27657751 Fax +86-755-27599500



Antenna Specifications

SHENZHEN HENGXIANGTONG ANTENNA TECHNOLOGY CO., LTD.

TDD-B38(20M)	37850	18.6	
	38150	18.64	
	38550	18.3	-90.98
TDD-B40(20M)	38850	20.96	
	39150	21.26	
	39550	19.99	-91.27
TDD-B41(20M)	40240	17.37	
	40620	18.03	
	41240	17.65	-90.18

WiFi

	channel	TRP	TIS
2.4G 11b : 11Mbps	1	13.58	-82.03
	6	13.83	-80.22
	13	14.11	-78.03
	channel	TRP	TIS
5G 802.11a : 54Mbps	36	10.43	-72.1
	64	11.09	-72.11
	165	11.53	-72.37

3 Mechanical Properties Specifications Drawings

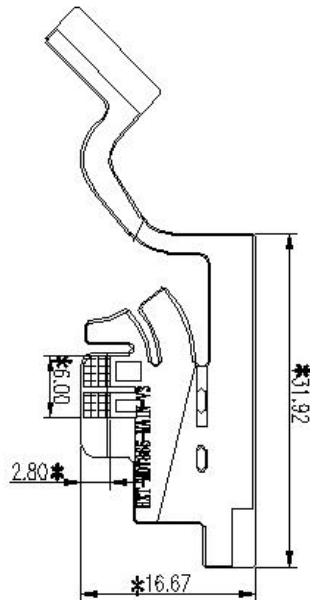

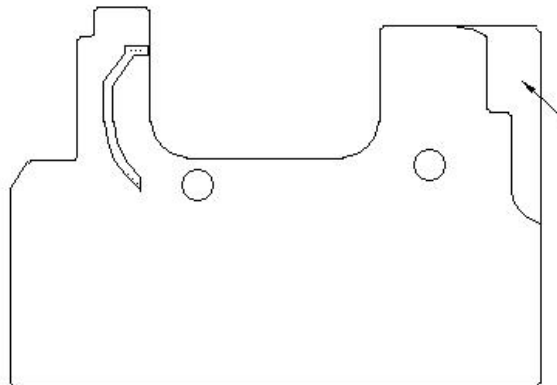
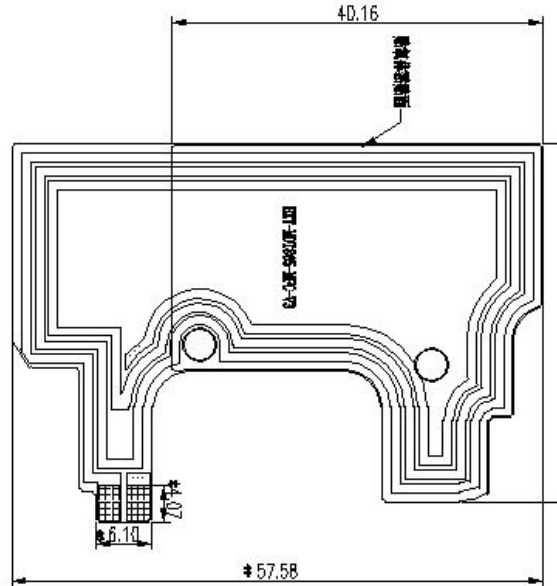

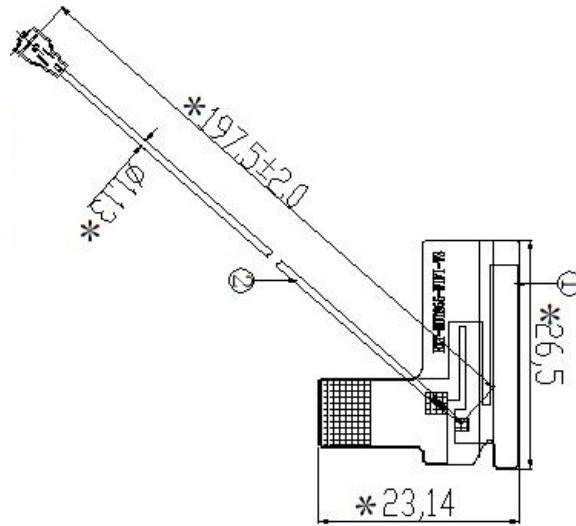

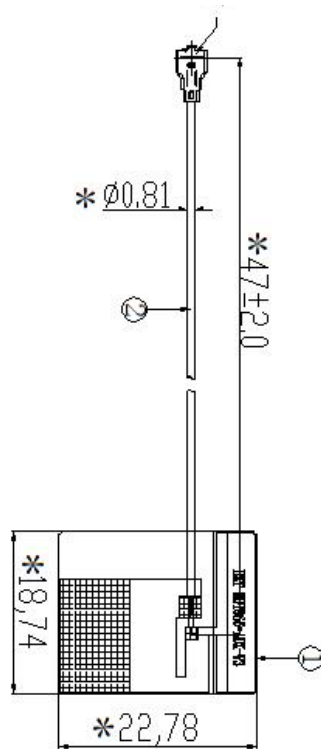



Antenna Specifications

SHENZHEN HENGXIANGTONG ANTENNA TECHNOLOGY CO., LTD.

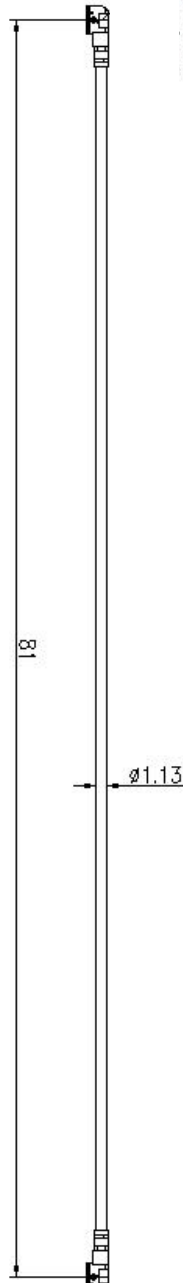



Antenna Specifications

SHENZHEN HENGXIANGTONG ANTENNA TECHNOLOGY CO., LTD.

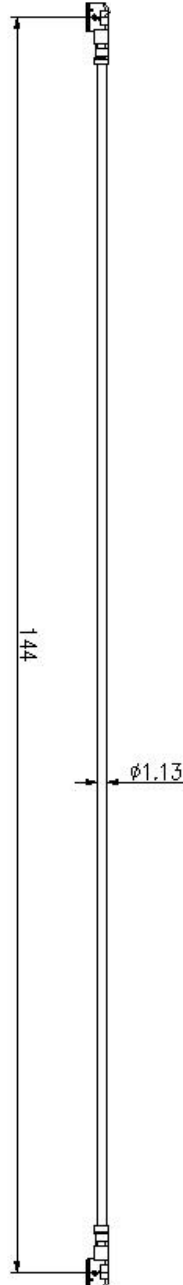

4. Environmental Characteristic

Test Item	Test description
1. Low Temperature	Temp.: -20 °C Time: 24 hours
2. High Temperature	Temp.: 80°C Time: 24 hours
3. Salt Fog	5±0.1% Nad salt fog PH Value: 6.5-7.2 Temp: 35±1°C Time:24 hours