

TEST REPORT



Report No.: TW2305330E
Applicant: Dongguan IMLONG Electronic Co., Ltd.
Product: Mouse Pad with wireless charger
Model No.: EAC-AS22BK
Trademark: N/A
Test Standards: FCC Part 15 Subpart C

Test Result: It is herewith confirmed and found to comply with the requirements set up by ANSI C63.4&FCC Part 15 Subpart C, for the evaluation of electromagnetic compatibility

Approved By

A handwritten signature in black ink that reads 'Terry Tang'.

Terry Tang

Manager

Dated: June 20, 2023

Results appearing herein relate only to the sample tested

The technical reports is issued errors and omissions exempt and is subject to withdrawal at

SHENZHEN TIMEWAY TESTING LABORATORIES

Zone C, 1st Floor, Block B, Jun Xiang Da Building, Zhongshan Park Road West, Tong Le Village, Nanshan District, Shenzhen, China

Tel (755) 83448688, Fax (755) 83442996, E-Mail:info@timeway-lab.com



Special Statement:

The testing quality ability of our laboratory meet with "Quality Law of People's Republic of China" Clause 19.

The testing quality system of our laboratory meets with ISO/IEC-17025 requirements, which is approved by CNAS. This approval result is accepted by MRA of APLAC.

Our test facility is recognized, certified, or accredited by the following organizations:

CNAS-LAB Code: L2292

The EMC Laboratory has been assessed and in compliance with CNAS-CL01 accreditation criteria for testing Laboratories (identical to ISO/IEC 17025:2017 General Requirements) for the Competence of testing Laboratories.

FCC-Registration No.: 744189

The EMC Laboratory has been registered and fully described in a report filed with the (FCC) Federal Communications commission. The acceptance letter from the FCC is maintained in our files. Registration No.: 744189.

Industry Canada (IC) —Registration No.:5205A

The EMC Laboratory has been registered by Certification and Engineering Bureau of Industry Canada for radio equipment testing with Registration No.: 5205A.

A2LA (Certification Number:5013.01)

The EMC Laboratory has been accredited by the American Association for Laboratory Accreditation (A2LA). Certification Number:5013.01

The report refers only to the sample tested and does not apply to the bulk.

This report is issued in confidence to the client and it will be strictly treated as such by the SHENZHEN TIMEWAY TESTING LABORATORIES. It may not be reproduced rather in its entirety or in part and it may not be used for adverting. The client to whom the report is issued may, however, show or send it . or a certified copy there of prepared by the SHENZHEN TIMEWAY TESTING LABORATORIES. to his customer. Supplier or others persons directly concerned. SHENZHEN TIMEWAY TESTING LABORATORIES. will not, without the consent of the client enter into any discussion of correspondence with any third party concerning the contents of the report. In the event of the improper use of the report. The SHENZHEN TIMEWAY TESTING LABORATORIES. reserves the rights to withdraw it and to adopt any other remedies which may be appropriate.



Test Report Conclusion
Content

1.0	General Details	4
1.1	Test Lab Details.....	4
1.2	Applicant Details.....	4
1.3	Description of EUT	4
1.4	Submitted Sample.....	5
1.5	Test Duration.....	5
1.6	Test Uncertainty.....	5
1.7	Test By.....	5
2.0	List of Measurement Equipment	6
3.0	Technical Details	7
3.1	Summary of Test Results.....	7
3.2	Test Standards.....	7
4.0	EUT Modification	7
5.0	Power Line Conducted Emission Test	8
5.1	Schematics of the Test.....	8
5.2	Test Method and Test Procedure.....	8
5.3	Configuration of the EUT.....	8
5.4	EUT Operating Condition.....	9
5.5	Conducted Emission Limit.....	9
5.6	Test Result.....	9
6.0	Radiated Emission test	12
6.1	Test Method and Test Procedure.....	12
6.2	Configuration of the EUT.....	13
6.3	EUT Operation Condition.....	13
6.4	Radiated Emission Limit.....	13
6.5	Test Result.....	14
7.0	20dB Bandwidth Test	18
8.0	Antenna Requirement	20
9.0	FCC Label	21
10.0	Photo of Testing	22

The report refers only to the sample tested and does not apply to the bulk.

This report is issued in confidence to the client and it will be strictly treated as such by the SHENZHEN TIMEWAY TESTING LABORATORIES. It may not be reproduced rather in its entirety or in part and it may not be used for advertising. The client to whom the report is issued may, however, show or send it, or a certified copy thereof prepared by the SHENZHEN TIMEWAY TESTING LABORATORIES, to his customer. Supplier or others persons directly concerned. SHENZHEN TIMEWAY TESTING LABORATORIES, will not, without the consent of the client enter into any discussion of correspondence with any third party concerning the contents of the report.

In the event of the improper use of the report. The SHENZHEN TIMEWAY TESTING LABORATORIES, reserves the rights to withdraw it and to adopt any other remedies which may be appropriate.



1.0 General Details

1.1 Test Lab Details

Name: SHENZHEN TIMEWAY TESTING LABORATORIES.
Address: Zone C, 1st Floor, Block B, Jun Xiang Da Building, Zhongshan Park Road West, Tong Le Village, Nanshan District, Shenzhen, China
Telephone: +86 755 83448688
Fax: +86 755 83442996
Site on File with the Federal Communications Commission – United States
Registration Number: 744189
For 3m Anechoic Chamber

1.2 Applicant Details

Applicant: Dongguan IMLONG Electronic Co., Ltd.
Address: Huixiang Road5, Jinglian Community, Qiaotou Town, Dongguan City, China
Telephone: --
Fax: --

1.3 Description of EUT

Product: Mouse Pad with wireless charger
Manufacturer: Dongguan IMLONG Electronic Co., Ltd.
Address: Huixiang Road5, Jinglian Community, Qiaotou Town, Dongguan City, China
Trademark: N/A
Model Number: EAC-AS22BK
Additional Model Name: N/A
Additional Trade Name: N/A
Rating: Input: 5Vdc, 3A or 9Vdc, 2A
Output: 15W max.

Note: Wireless Output: 15W was tested, and it was the worst case.

Hardware Version: W2236-15W
Software Version: W2236-V2.0
Serial No.:



Operation Frequency: 111.5-205kHz
Test Frequency: 175kHz
Modulation Type: MSK
Antenna Designation: Inductive Loop Antenna with gain 0dBi Max (Declared by the applicant)

The report refers only to the sample tested and does not apply to the bulk.

This report is issued in confidence to the client and it will be strictly treated as such by the SHENZHEN TIMEWAY TESTING LABORATORIES. It may not be reproduced in its entirety or in part and it may not be used for advertising. The client to whom the report is issued may, however, show or send it, or a certified copy thereof prepared by the SHENZHEN TIMEWAY TESTING LABORATORIES, to his customer. Supplier or others persons directly concerned. SHENZHEN TIMEWAY TESTING LABORATORIES, will not, without the consent of the client enter into any discussion of correspondence with any third party concerning the contents of the report.

In the event of the improper use of the report. The SHENZHEN TIMEWAY TESTING LABORATORIES, reserves the rights to withdraw it and to adopt any other remedies which may be appropriate.



2.0 Test Equipment					
Instrument Type	Manufacturer	Model	Serial No.	Date of Cal.	Due Date
ESPI Test Receiver	R&S	ESPI 3	100379	2022-07-15	2023-07-14
LISN	R&S	EZH3-Z5	100294	2022-07-18	2023-07-17
LISN	R&S	EZH3-Z5	100253	2022-07-18	2023-07-17
Impuls-Begrenzer	R&S	ESH3-Z2	100281	2022-07-18	2023-07-17
Loop Antenna	EMCO	6507	00078608	2022-07-18	2025-07-17
Spectrum	R&S	FSIQ26	100292	2022-07-15	2023-07-14
Horn Antenna	A-INFO	LB-180400-KF	J211060660	2022-07-18	2025-07-17
Horn Antenna	R&S	BBHA 9120D	9120D-631	2022-07-18	2024-07-17
Power meter	Anritsu	ML2487A	6K00003613	2022-07-18	2023-07-17
Power sensor	Anritsu	MA2491A	32263	2022-07-18	2023-07-17
Bilog Antenna	Schwarebeck	VULB9163	9163/340	2022-07-18	2025-07-17
9*6*6 Anechoic	--	--	N/A	2022-07-26	2025-07-25
EMI Test Receiver	RS	ESVB	826156/011	2022-07-15	2023-07-14
EMI Test Receiver	RS	ESCS 30	834115/006	2022-07-15	2023-07-14
Spectrum	HP/Agilent	E4407B	MY50441392	2022-07-15	2023-07-14
Spectrum	RS	FSP	1164.4391.38	2022-07-15	2023-07-14
RF Cable	Zhengdi	ZT26-NJ-NJ-8 M/FA	--	2022-07-15	2023-07-14
RF Cable	Zhengdi	7m	--	2022-07-15	2023-07-14
Pre-Amplifier	Schwarebeck	BBV9743	#218	2022-07-15	2023-07-14
Pre-Amplifier	HP/Agilent	8449B	3008A00160	2022-07-15	2023-07-14
LISN	SCHAFFNER	NNB42	00012	2022-08-18	2023-07-17
ESPI Test Receiver	R&S	ESPI 3	100379	2022-07-15	2023-07-14
LISN	R&S	EZH3-Z5	100294	2022-07-18	2023-07-17

2.2 Automation Test Software

For Conducted Emission Test

Name	Version
EZ-EMC	Ver.EMC-CON 3A1.1

For Radiated Emissions

Name	Version
EMI Test Software BL410-EV18.91	V18.905
EMI Test Software BL410-EV18.806 High Frequency	V18.06

The report refers only to the sample tested and does not apply to the bulk.

This report is issued in confidence to the client and it will be strictly treated as such by the SHENZHEN TIMEWAY TESTING LABORATORIES. It may not be reproduced rather in its entirety or in part and it may not be used for advertising. The client to whom the report is issued may, however, show or send it, or a certified copy thereof prepared by the SHENZHEN TIMEWAY TESTING LABORATORIES, to his customer. Supplier or others persons directly concerned. SHENZHEN TIMEWAY TESTING LABORATORIES, will not, without the consent of the client enter into any discussion of correspondence with any third party concerning the contents of the report.

In the event of the improper use of the report. The SHENZHEN TIMEWAY TESTING LABORATORIES, reserves the rights to withdraw it and to adopt any other remedies which may be appropriate.



3.0 Technical Details

3.1 Summary of test results

The EUT has been tested according to the following specifications:			
Standard	Test Type	Result	Notes
FCC Part 15, Paragraph 15.203	Antenna requirements	Pass	Compliant
FCC Part 15, Paragraph 15.207	Conducted Emission Test	Pass	Compliant
FCC Part 15, Paragraph 15.209 (a) (f)	General Requirement	Pass	Compliant
FCC Part 15, Paragraph 15.215	20dB Bandwidth Testing	Pass	Compliant

3.2 Test Standards

FCC Part 15 Subpart C , ANSI C63.4 :2014 and ANSI C63.10 :2013

4.0 EUT Modification

No modification by SHENZHEN TIMEWAY TESTING LABORATORIES

The report refers only to the sample tested and does not apply to the bulk.

This report is issued in confidence to the client and it will be strictly treated as such by the SHENZHEN TIMEWAY TESTING LABORATORIES. It may not be reproduced rather in its entirety or in part and it may not be used for advertising. The client to whom the report is issued may, however, show or send it . or a certified copy there of prepared by the SHENZHEN TIMEWAY TESTING LABORATORIES. to his customer. Supplier or others persons directly concerned. SHENZHEN TIMEWAY TESTING LABORATORIES. will not, without the consent of the client enter into any discussion of correspondence with any third party concerning the contents of the report.

In the event of the improper use of the report. The SHENZHEN TIMEWAY TESTING LABORATORIES. reserves the rights to withdraw it and to adopt any other remedies which may be appropriate.



5.0 Power Line Conducted Emission Test

5.1 Schematics of the test

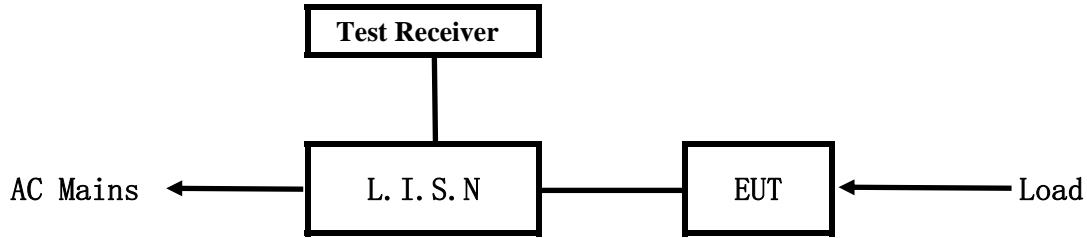

EUT: Equipment Under Test

5.2 Test Method and test Procedure

The EUT was tested according to ANSI C63.10-2013. The Frequency spectrum from 0.15MHz to 30MHz was investigated. The LISN used was 50ohm/50uH as specified by section 5.1 of ANSI C63.10 –2013.

Test Voltage: 120V~, 60Hz

Block diagram of Test setup

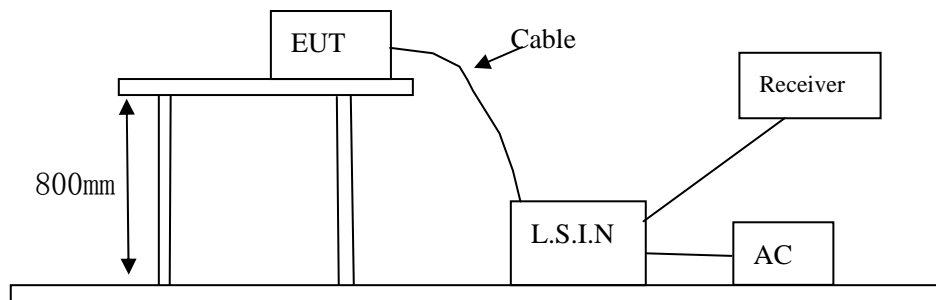

5.3 Configuration of The EUT

The EUT was configured according to ANSI C63.10-2013. All interface ports were connected to the appropriate peripherals. All peripherals and cables are listed below.

A. EUT

Device	Manufacturer	Model	FCC ID
Mouse Pad with wireless charger	Dongguan Imlong Electronic Limited	EAC-AS22BK	2AH9Y-EAC-AS22BK

B. Internal Device

Device	Manufacturer	Model	FCC ID/DOC
N/A			

The report refers only to the sample tested and does not apply to the bulk.

This report is issued in confidence to the client and it will be strictly treated as such by the SHENZHEN TIMEWAY TESTING LABORATORIES. It may not be reproduced rather in its entirety or in part and it may not be used for advertising. The client to whom the report is issued may, however, show or send it, or a certified copy thereof prepared by the SHENZHEN TIMEWAY TESTING LABORATORIES, to his customer. Supplier or others persons directly concerned. SHENZHEN TIMEWAY TESTING LABORATORIES, will not, without the consent of the client enter into any discussion of correspondence with any third party concerning the contents of the report.

In the event of the improper use of the report. The SHENZHEN TIMEWAY TESTING LABORATORIES, reserves the rights to withdraw it and to adopt any other remedies which may be appropriate.



C. Peripherals

Device	Manufacturer	Model	Rating
PC	DELL	P54G	Input: DC19.5V, 3.3A
Power Supply	DELL	HA65NS5-00	Input: 100-240V~, 50-60Hz, 1.7A Output: DC19.5V, 3.34A

5.4 EUT Operating Condition

Operating condition is according to ANSI C63.10 -2013.

A Setup the EUT and simulators as shown on follow

B Enable AF signal and confirm EUT active to normal condition

5.5 Power line conducted Emission Limit according to Paragraph 15.207

Frequency (MHz)	Limits (dB μ V)	
	Quasi-peak Level	Average Level
0.15 ~ 0.50	66.0~56.0*	56.0~46.0*
0.50 ~ 5.00	56.0	46.0
5.00 ~ 30.00	60.0	50.0

- Notes: 1. *Decreasing linearly with logarithm of frequency.
 2. The tighter limit shall apply at the transition frequencies

5.6 Test Results

The frequency spectrum from 0.15MHz to 30MHz was investigated. All reading are quasi-peak values with a resolution bandwidth of 9kHz. (The average detector is necessary when the Quasi-peak emission level beyond the average Limit.)



A: Conducted Emission on Live Terminal (150kHz to 30MHz)

EUT Operating Environment

Temperature: 25°C Humidity:75%RH Atmospheric Pressure: 101 kPa

EUT set Condition: Keep Transmitting

Results: Pass

Please refer to following diagram for individual

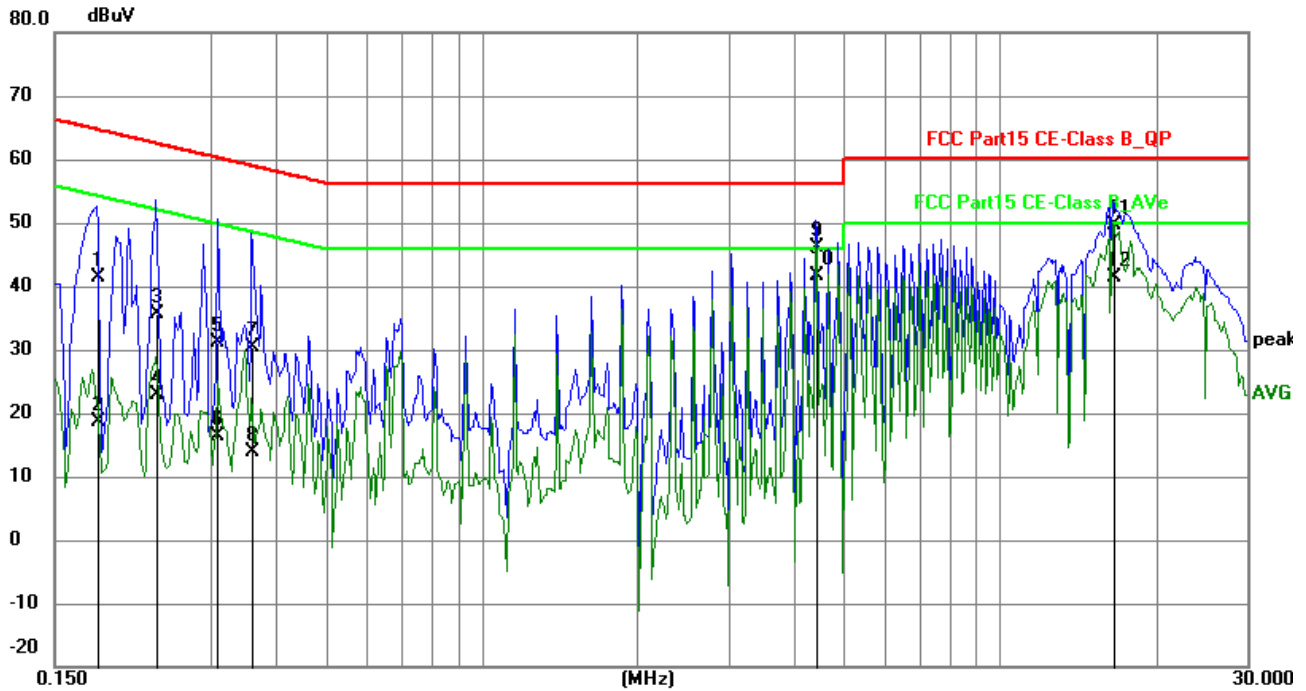

No.	Frequency (MHz)	Reading (dBuV)	Factor (dB)	Level (dBuV)	Limit (dBuV)	Margin (dB)	Detector	P/F
1	0.1812	31.52	9.76	41.28	64.43	-23.15	QP	P
2	0.1812	8.75	9.76	18.51	54.43	-35.92	AVG	P
3	0.2358	25.77	9.75	35.52	62.24	-26.72	QP	P
4	0.2358	13.10	9.75	22.85	52.24	-29.39	AVG	P
5	0.3099	21.28	9.76	31.04	59.97	-28.93	QP	P
6	0.3099	6.55	9.76	16.31	49.97	-33.66	AVG	P
7	0.3605	20.73	9.76	30.49	58.72	-28.23	QP	P
8	0.3605	4.00	9.76	13.76	48.72	-34.96	AVG	P
9	4.4274	36.31	9.91	46.22	56.00	-9.78	QP	P
10	4.4274	31.82	9.91	41.73	46.00	-4.27	AVG	P
11	16.5408	39.16	10.47	49.63	60.00	-10.37	QP	P
12	16.5408	30.85	10.47	41.32	50.00	-8.68	AVG	P

The report refers only to the sample tested and does not apply to the bulk.

This report is issued in confidence to the client and it will be strictly treated as such by the SHENZHEN TIMEWAY TESTING LABORATORIES. It may not be reproduced rather in its entirety or in part and it may not be used for advertising. The client to whom the report is issued may, however, show or send it, or a certified copy thereof prepared by the SHENZHEN TIMEWAY TESTING LABORATORIES, to his customer. Supplier or others persons directly concerned. SHENZHEN TIMEWAY TESTING LABORATORIES, will not, without the consent of the client enter into any discussion of correspondence with any third party concerning the contents of the report.

In the event of the improper use of the report. The SHENZHEN TIMEWAY TESTING LABORATORIES, reserves the rights to withdraw it and to adopt any other remedies which may be appropriate.



B: Conducted Emission on Neutral Terminal (150kHz to 30MHz)

EUT Operating Environment

Temperature: 25°C Humidity:75%RH Atmospheric Pressure: 101 kPa

EUT set Condition: Keep Transmitting

Results: Pass

Please refer to following diagram for individual

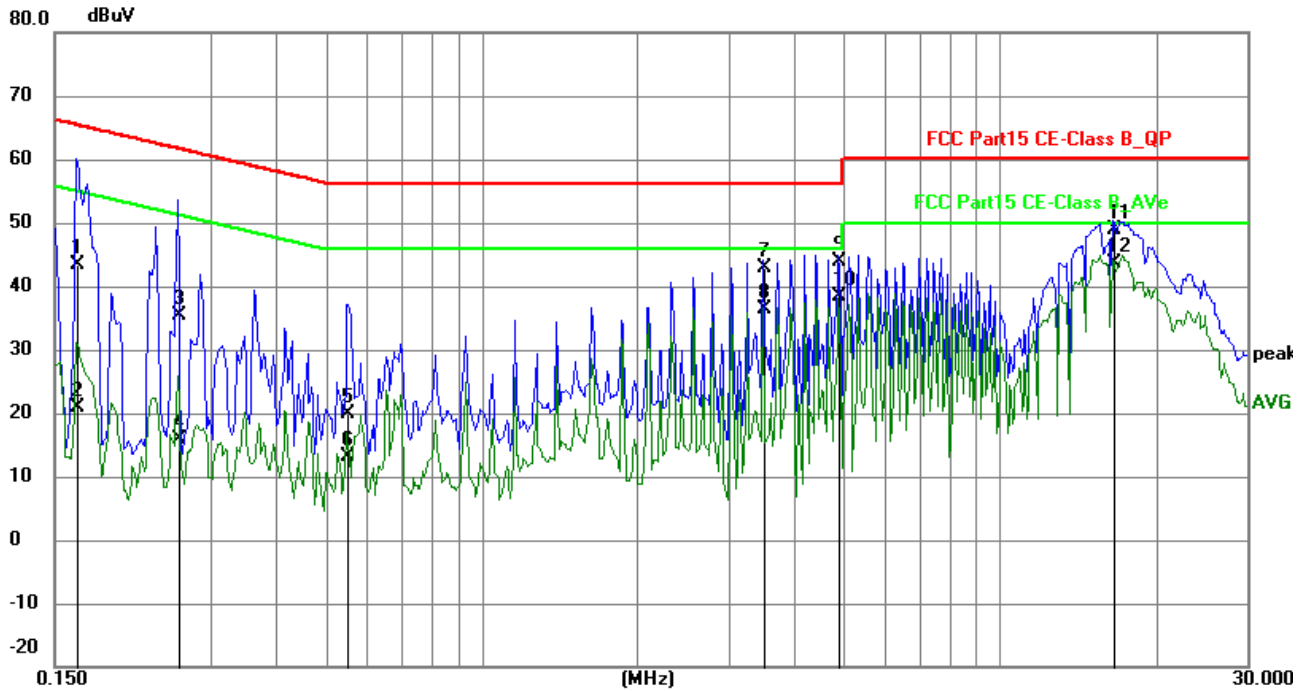

No.	Frequency (MHz)	Reading (dBuV)	Factor (dB)	Level (dBuV)	Limit (dBuV)	Margin (dB)	Detector	P/F
1	0.1655	33.67	9.77	43.44	65.18	-21.74	QP	P
2	0.1655	11.07	9.77	20.84	55.18	-34.34	AVG	P
3	0.2592	25.66	9.75	35.41	61.46	-26.05	QP	P
4	0.2592	6.14	9.75	15.89	51.46	-35.57	AVG	P
5	0.5517	10.18	9.77	19.95	56.00	-36.05	QP	P
6	0.5517	3.41	9.77	13.18	46.00	-32.82	AVG	P
7	3.4953	32.93	9.86	42.79	56.00	-13.21	QP	P
8	3.4953	26.52	9.86	36.38	46.00	-9.62	AVG	P
9	4.8915	33.92	9.93	43.85	56.00	-12.15	QP	P
10	4.8915	28.33	9.93	38.26	46.00	-7.74	AVG	P
11	16.5408	38.35	10.47	48.82	60.00	-11.18	QP	P
12	16.5408	33.20	10.47	43.67	50.00	-6.33	AVG	P

The report refers only to the sample tested and does not apply to the bulk.

This report is issued in confidence to the client and it will be strictly treated as such by the SHENZHEN TIMEWAY TESTING LABORATORIES. It may not be reproduced rather in its entirety or in part and it may not be used for advertising. The client to whom the report is issued may, however, show or send it, or a certified copy thereof prepared by the SHENZHEN TIMEWAY TESTING LABORATORIES, to his customer. Supplier or others persons directly concerned. SHENZHEN TIMEWAY TESTING LABORATORIES, will not, without the consent of the client enter into any discussion of correspondence with any third party concerning the contents of the report.

In the event of the improper use of the report. The SHENZHEN TIMEWAY TESTING LABORATORIES, reserves the rights to withdraw it and to adopt any other remedies which may be appropriate.



6.0 Radiated Emission Test

6.1 Test Method and test Procedure:

- (1) The EUT was tested according to ANSI C63.10-2013. The radiated test was performed at TIMEWAY EMC Laboratory. This site is on file with the FCC laboratory division, Registration No.744189
- (2) The EUT, peripherals were put on the turntable which table size is 1m x 1.5 m, table high 0.8 m. All set up is according to ANSI C63.10-2013.
- (3) The frequency spectrum from 9 kHz to 1 GHz was investigated. All readings from 30 MHz to 1 GHz are quasi-peak values with RBW=120 kHz/VBW=300 kHz; All readings from 9 kHz to 30 MHz are quasi-peak values with RBW=10 kHz/VBW=30 kHz. For the frequency bands 9-90 kHz, 110-490 kHz and above 1000 MHz Radiated emission test in these three bands are based on measurements employing an average detector. Measurements were made at 3 meters.
- (4) The antenna high is varied from 1 m to 4 m high to find the maximum emission for each frequency.
- (5) Maximizing procedure was performed on the six (6) highest emissions to ensure EUT compliance is with all installation combinations. All data was recorded in the peak detection mode. Quasi-peak readings was performed only when an emission was found to be marginal (within -4 dB of specification limit), and are distinguished with a "QP" in the data table.
- (6) The antenna polarization: Vertical polarization and Horizontal polarization.

Block diagram of Test setup

9kHz-30MHz

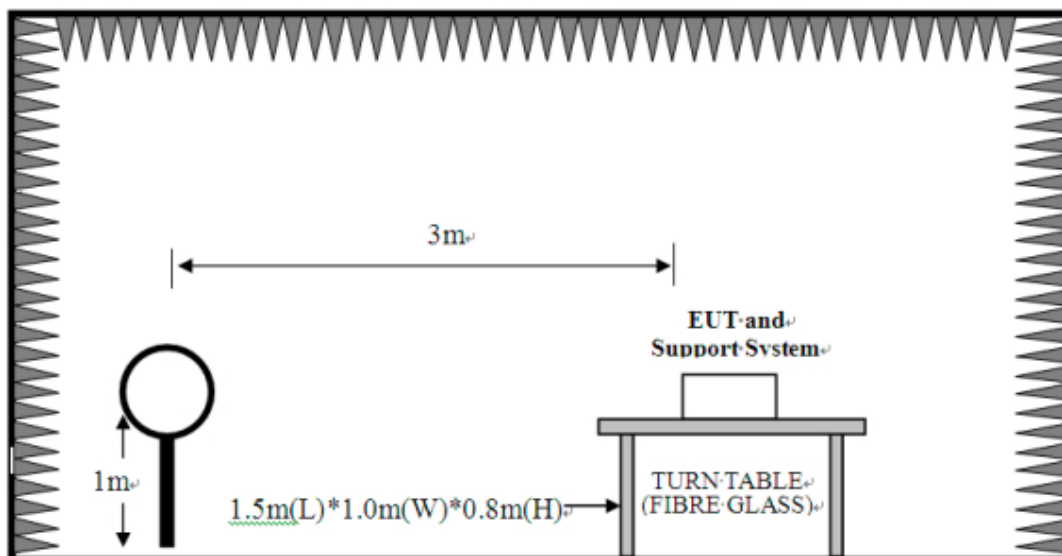

The report refers only to the sample tested and does not apply to the bulk.

This report is issued in confidence to the client and it will be strictly treated as such by the SHENZHEN TIMEWAY TESTING LABORATORIES. It may not be reproduced rather in its entirety or in part and it may not be used for advertising. The client to whom the report is issued may, however, show or send it, or a certified copy thereof prepared by the SHENZHEN TIMEWAY TESTING LABORATORIES, to his customer. Supplier or others persons directly concerned. SHENZHEN TIMEWAY TESTING LABORATORIES, will not, without the consent of the client enter into any discussion of correspondence with any third party concerning the contents of the report.

In the event of the improper use of the report. The SHENZHEN TIMEWAY TESTING LABORATORIES, reserves the rights to withdraw it and to adopt any other remedies which may be appropriate.



30MHz-1000MHz

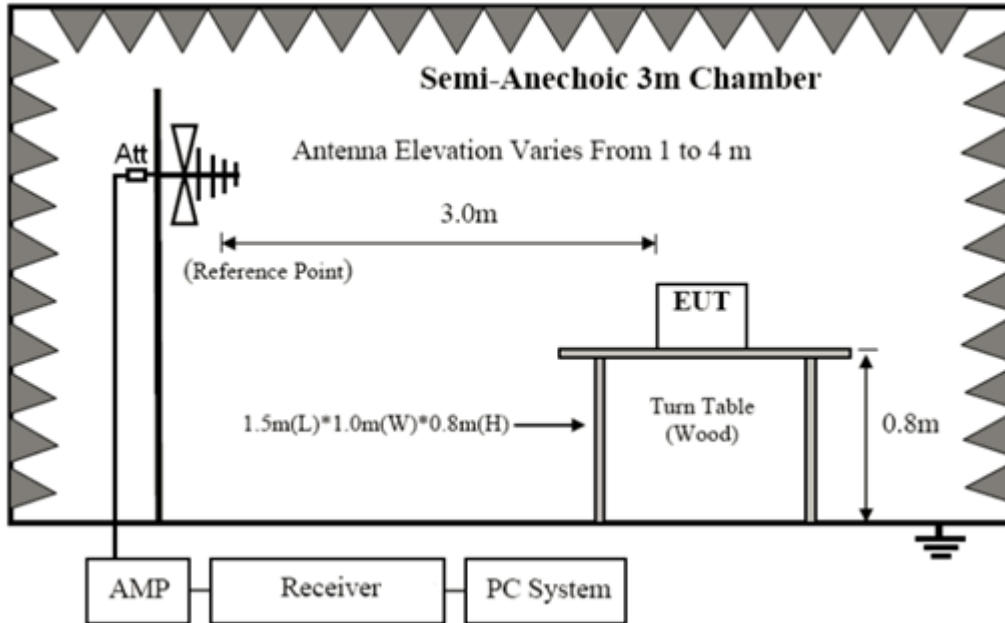

6.2 Configuration of The EUT
 Same as section 5.3 of this report

6.3 EUT Operating Condition
 Same as section 5.4 of this report.

6.4 Radiated Emission Limit
 All emission from a digital device, including any network of conductors and apparatus connected thereto, shall not exceed the level of field strength specified below:

B. Frequencies in restricted band are compiled to limit on Paragraph 15.209.

Limits for frequency below 30MHz

Frequency Range (MHz)	Distance (m)	Field strength (V/m)
0.009-0.490	300	2400/F(kHz)
0.490-1.705	30	24000/F(kHz)
1.705-30	30	30

The report refers only to the sample tested and does not apply to the bulk.
 This report is issued in confidence to the client and it will be strictly treated as such by the SHENZHEN TIMEWAY TESTING LABORATORIES. It may not be reproduced in its entirety or in part and it may not be used for advertising. The client to whom the report is issued may, however, show or send it, or a certified copy thereof prepared by the SHENZHEN TIMEWAY TESTING LABORATORIES, to his customer, supplier or other persons directly concerned. SHENZHEN TIMEWAY TESTING LABORATORIES, will not, without the consent of the client enter into any discussion of correspondence with any third party concerning the contents of the report.
 In the event of the improper use of the report, the SHENZHEN TIMEWAY TESTING LABORATORIES, reserves the rights to withdraw it and to adopt any other remedies which may be appropriate.



Limits for frequency above 30MHz

Frequency Range (MHz)	Distance (m)	Field strength (dB μ V/m)
30-88	3	40.0
88-216	3	43.5
216-960	3	46.0
Above 960	3	54.0

- Note:
1. RF Voltage (dBuV) = 20 log RF Voltage (μ V)
 2. In the Above Table, the tighter limit applies at the band edges.
 3. Distance refers to the distance in meters between the measuring instrument antenna and the EUT
 4. The emission limits shown in the above table are based on measurements employing a CISPR quasi-peak detector except for the frequency bands 9-90 kHz, 110-490 kHz. Radiated emission limits in these two bands are based on measurements employing an average detector.

6.5 Test result

The report refers only to the sample tested and does not apply to the bulk.
This report is issued in confidence to the client and it will be strictly treated as such by the SHENZHEN TIMEWAY TESTING LABORATORIES. It may not be reproduced rather in its entirety or in part and it may not be used for advertising. The client to whom the report is issued may, however, show or send it . or a certified copy there of prepared by the SHENZHEN TIMEWAY TESTING LABORATORIES. to his customer. Supplier or others persons directly concerned. SHENZHEN TIMEWAY TESTING LABORATORIES. will not, without the consent of the client enter into any discussion of correspondence with any third party concerning the contents of the report.
In the event of the improper use of the report. The SHENZHEN TIMEWAY TESTING LABORATORIES. reserves the rights to withdraw it and to adopt any other remedies which may be appropriate.



Measurement data:

Note: Limit dBuV/m @3m = Limit dBuV/m @300m+ 80

Limit dBuV/m @3m = Limit dBuV/m @30m + 40

9 kHz~30 MHz

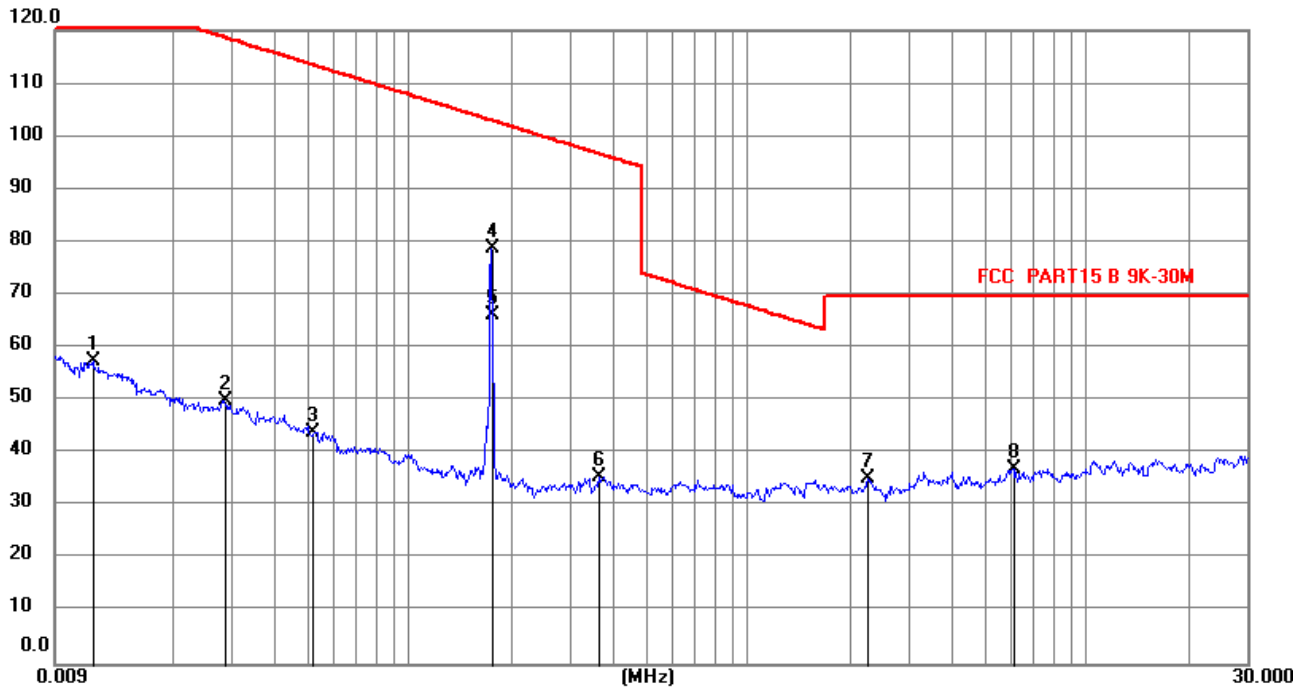

No.	Frequency (MHz)	Reading ()	Factor (dB)	Level (dBuV/m)	Limit (dBuV/m)	Margin (dB)	Detector	P/F
1	0.0117	47.33	10.06	57.39	126.06	-68.67	peak	P
2	0.0286	39.80	10.20	50.00	118.34	-68.34	peak	P
3	0.0522	34.16	9.80	43.96	113.14	-69.18	peak	P
4	0.1753	69.06	9.77	78.83	102.68	-23.85	peak	P
5	0.1753	56.43	9.77	66.20	102.68	-36.48	AVG	P
6	0.3634	25.80	9.76	35.56	96.38	-60.82	peak	P
7	2.2659	25.58	9.81	35.39	69.51	-34.12	peak	P
8	6.1250	27.02	9.97	36.99	69.54	-32.55	peak	P

The report refers only to the sample tested and does not apply to the bulk.

This report is issued in confidence to the client and it will be strictly treated as such by the SHENZHEN TIMEWAY TESTING LABORATORIES. It may not be reproduced in its entirety or in part and it may not be used for advertising. The client to whom the report is issued may, however, show or send it, or a certified copy thereof prepared by the SHENZHEN TIMEWAY TESTING LABORATORIES, to his customer. Supplier or other persons directly concerned. SHENZHEN TIMEWAY TESTING LABORATORIES, will not, without the consent of the client enter into any discussion of correspondence with any third party concerning the contents of the report.

In the event of the improper use of the report, the SHENZHEN TIMEWAY TESTING LABORATORIES, reserves the rights to withdraw it and to adopt any other remedies which may be appropriate.



A. General Radiated Emission Data

Radiated Emission In Horizontal (30MHz----1000MHz)

EUT set Condition: Keep Transmitting

Results: Pass

Please refer to following diagram for individual

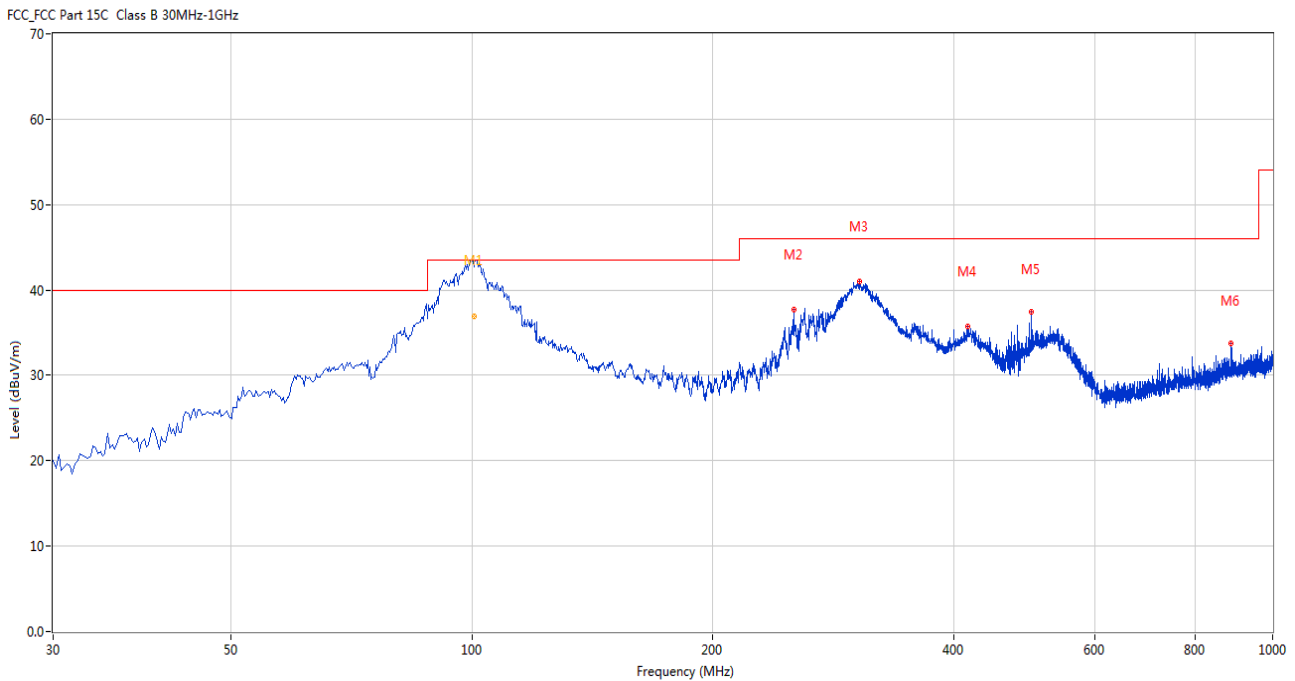

No.	Frequency (MHz)	Results (dBuV/m)	Factor (dB)	Limit (dBuV/m)	Over Limit (dB)	Detector	Table (o)	Height (cm)	ANT	Verdict
1*	100.792	36.86	-13.46	43.5	6.64	QP	360.00	200	Horizontal	Pass
2	252.317	37.71	-12.09	46.0	8.29	Peak	309.00	100	Horizontal	Pass
3	304.684	41.06	-10.96	46.0	4.94	Peak	135.00	100	Horizontal	Pass
4	415.964	35.73	-8.34	46.0	10.27	Peak	183.00	200	Horizontal	Pass
5	499.848	37.43	-6.90	46.0	8.57	Peak	56.00	200	Horizontal	Pass
6	887.508	33.77	-2.04	46.0	12.23	Peak	261.00	200	Horizontal	Pass

The report refers only to the sample tested and does not apply to the bulk.
 This report is issued in confidence to the client and it will be strictly treated as such by the SHENZHEN TIMEWAY TESTING LABORATORIES. It may not be reproduced in its entirety or in part and it may not be used for advertising. The client to whom the report is issued may, however, show or send it, or a certified copy thereof prepared by the SHENZHEN TIMEWAY TESTING LABORATORIES, to his customer. Supplier or others persons directly concerned. SHENZHEN TIMEWAY TESTING LABORATORIES, will not, without the consent of the client enter into any discussion of correspondence with any third party concerning the contents of the report.
 In the event of the improper use of the report. The SHENZHEN TIMEWAY TESTING LABORATORIES, reserves the rights to withdraw it and to adopt any other remedies which may be appropriate.



B. General Radiated Emission Data

Radiated Emission In Vertical (30MHz----1000MHz)

EUT set Condition: Keep Transmitting

Results: Pass

Please refer to following diagram for individual

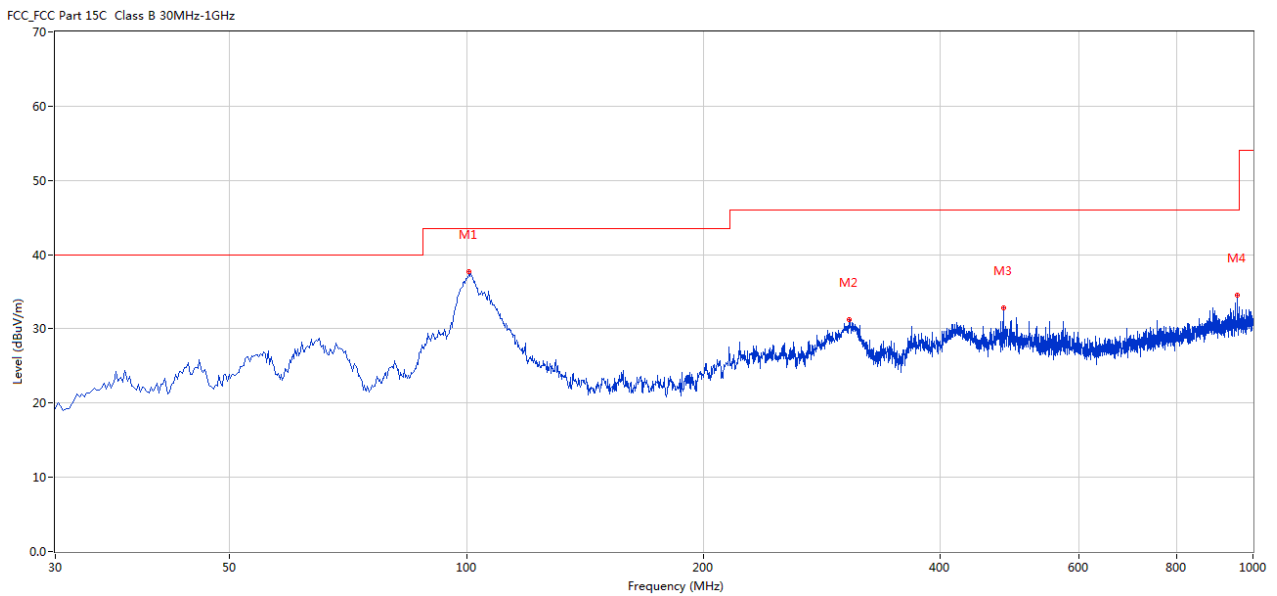

No.	Frequency (MHz)	Results (dBuV/m)	Factor (dB)	Limit (dBuV/m)	Over Limit (dB)	Detector	Table (o)	Height (cm)	ANT	Verdict
1	100.792	37.74	-13.46	43.5	5.76	Peak	260.00	100	Vertical	Pass
2	306.623	31.25	-10.96	46.0	14.75	Peak	180.00	100	Vertical	Pass
3	481.907	32.82	-7.34	46.0	13.18	Peak	344.00	100	Vertical	Pass
4	954.179	34.58	-1.69	46.0	11.42	Peak	83.00	100	Vertical	Pass

The report refers only to the sample tested and does not apply to the bulk.
 This report is issued in confidence to the client and it will be strictly treated as such by the SHENZHEN TIMEWAY TESTING LABORATORIES. It may not be reproduced rather in its entirety or in part and it may not be used for advertising. The client to whom the report is issued may, however, show or send it . or a certified copy there of prepared by the SHENZHEN TIMEWAY TESTING LABORATORIES. to his customer. Supplier or others persons directly concerned. SHENZHEN TIMEWAY TESTING LABORATORIES. will not, without the consent of the client enter into any discussion of correspondence with any third party concerning the contents of the report.
 In the event of the improper use of the report. The SHENZHEN TIMEWAY TESTING LABORATORIES. reserves the rights to withdraw it and to adopt any other remedies which may be appropriate.



7.0 20dB Bandwidth Testing

7.1 Test Procedure

With the EUT's antenna attached, the EUT's 20dB Bandwidth was received by the test antenna which was connected to the spectrum analyzer with the START and STOP frequencies set to the EUT's operation band.

7.3 Test Data

Frequency (MHz)	20dB Bandwidth Emission (kHz)	Limit (kHz)	Result
0.175	3.282	--	Pass

Refer to attached plots:

The report refers only to the sample tested and does not apply to the bulk.

This report is issued in confidence to the client and it will be strictly treated as such by the SHENZHEN TIMEWAY TESTING LABORATORIES. It may not be reproduced rather in its entirety or in part and it may not be used for advertising. The client to whom the report is issued may, however, show or send it . or a certified copy there of prepared by the SHENZHEN TIMEWAY TESTING LABORATORIES. to his customer. Supplier or others persons directly concerned. SHENZHEN TIMEWAY TESTING LABORATORIES. will not, without the consent of the client enter into any discussion of correspondence with any third party concerning the contents of the report.

In the event of the improper use of the report. The SHENZHEN TIMEWAY TESTING LABORATORIES. reserves the rights to withdraw it and to adopt any other remedies which may be appropriate.



20dB Bandwidth



Ref Lvl	Marker 1 [T1 ndB]	RBW	1 kHz	RF Att	10 dB
-20 dBm	ndB 20.00 dB	VBW	3 kHz		
	BW 3.28156313 kHz	SWT	150 ms	Unit	dBm

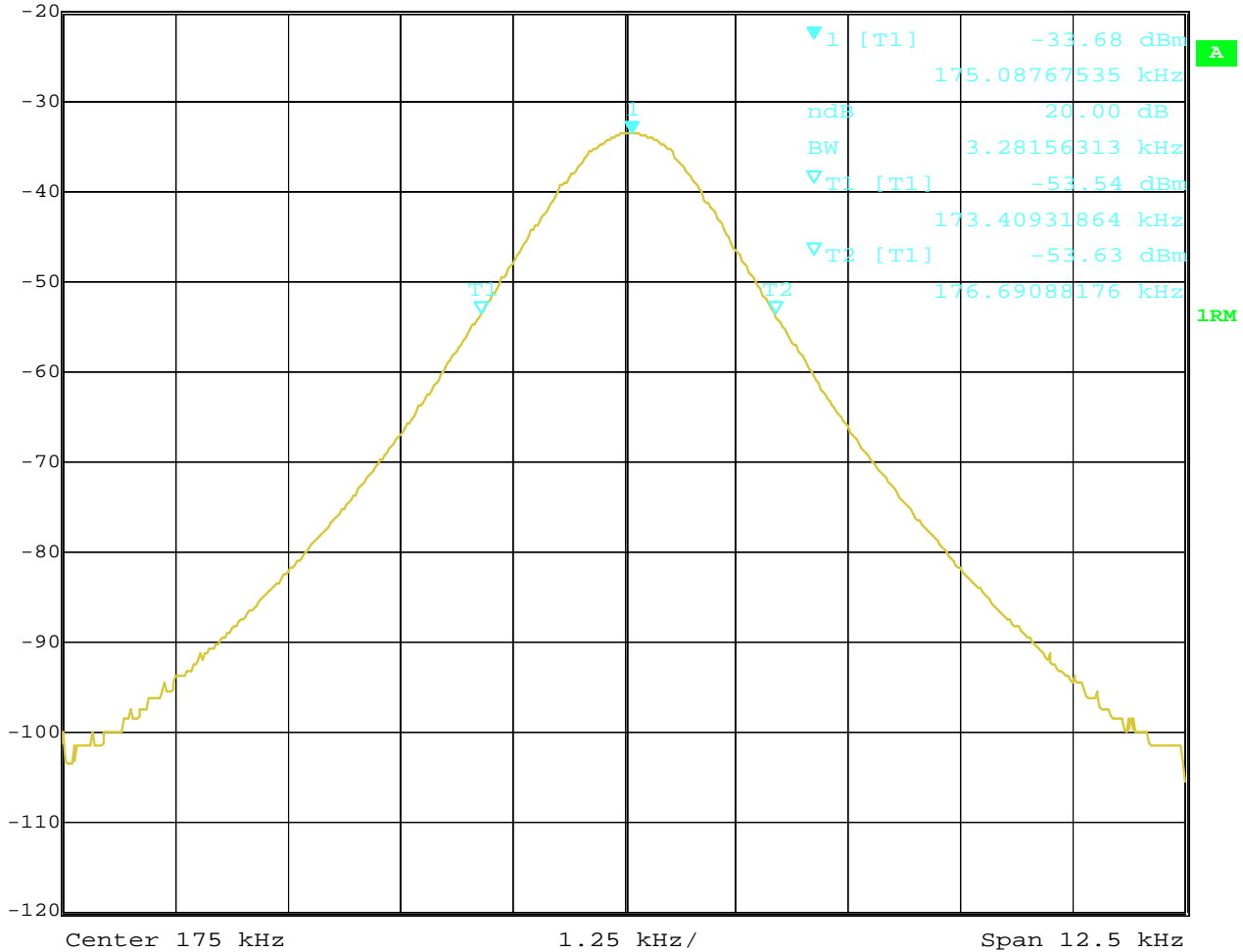

Date: 20.JUN.2023 10:03:31

The report refers only to the sample tested and does not apply to the bulk.
 This report is issued in confidence to the client and it will be strictly treated as such by the SHENZHEN TIMEWAY TESTING LABORATORIES. It may not be reproduced rather in its entirety or in part and it may not be used for advertising. The client to whom the report is issued may, however, show or send it . or a certified copy there of prepared by the SHENZHEN TIMEWAY TESTING LABORATORIES. to his customer. Supplier or others persons directly concerned. SHENZHEN TIMEWAY TESTING LABORATORIES. will not, without the consent of the client enter into any discussion of correspondence with any third party concerning the contents of the report.
 In the event of the improper use of the report. The SHENZHEN TIMEWAY TESTING LABORATORIES. reserves the rights to withdraw it and to adopt any other remedies which may be appropriate.



8.0 Antenna Requirement

8.1 Standard Applicable

An intentional radiator shall be designed to ensure that no antenna other than that furnished by the responsible party shall be used with the device. The use of a permanently attached antenna or of an antenna that uses a unique coupling to the intentional radiator shall be considered sufficient to comply with the provisions of this Section. The manufacturer may design the unit so that a broken antenna can be replaced by the user, but the use of a standard antenna jack or electrical connector is prohibited. This requirement does not apply to carrier current devices or to devices operated under the provisions of Sections 15.211, 15.213, 15.217, 15.219, or 15.221. Further, this requirement does not apply to intentional radiators that must be professionally installed, such as perimeter protection systems and some field disturbance sensors, or to other intentional radiators which, in accordance with Section 15.31(d), must be measured at the installation site. However, the installer shall be responsible for ensuring that the proper antenna is employed so that the limits in this Part are not exceeded.

8.2 Antenna Connected constructions

The antenna is Inductive Loop Antenna. The antenna gain is 0dBi. So it meets the requirement of 15.203

The report refers only to the sample tested and does not apply to the bulk.

This report is issued in confidence to the client and it will be strictly treated as such by the SHENZHEN TIMEWAY TESTING LABORATORIES. It may not be reproduced rather in its entirety or in part and it may not be used for advertising. The client to whom the report is issued may, however, show or send it . or a certified copy there of prepared by the SHENZHEN TIMEWAY TESTING LABORATORIES. to his customer. Supplier or others persons directly concerned. SHENZHEN TIMEWAY TESTING LABORATORIES. will not, without the consent of the client enter into any discussion of correspondence with any third party concerning the contents of the report.

In the event of the improper use of the report. The SHENZHEN TIMEWAY TESTING LABORATORIES. reserves the rights to withdraw it and to adopt any other remedies which may be appropriate.



9.0 FCC ID Label

FCC ID: 2AH9Y-EAC-AS22BK

This device complies with Part 15 of the FCC Rules. Operation is subject to the following two conditions: (1) this device may not cause harmful interference, and (2) this device must accept any interference received, including interference that may cause undesired operation

The label must not be a stick-on paper label. The label on these products must be permanently affixed to the product and readily visible at the time of purchase and must last the expected lifetime of the equipment not be readily detachable.

Mark Location:

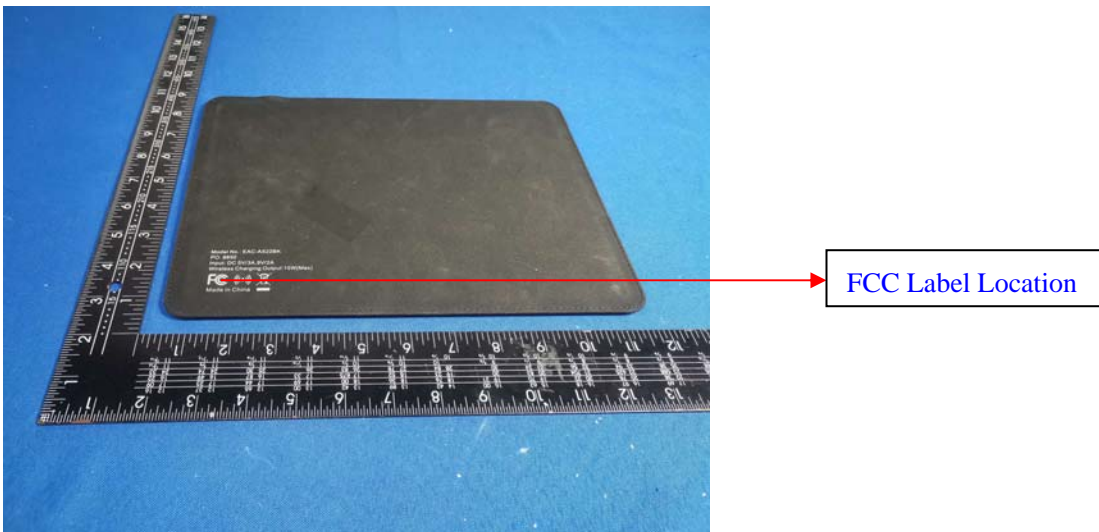

The report refers only to the sample tested and does not apply to the bulk.

This report is issued in confidence to the client and it will be strictly treated as such by the SHENZHEN TIMEWAY TESTING LABORATORIES. It may not be reproduced rather in its entirety or in part and it may not be used for advertising. The client to whom the report is issued may, however, show or send it, or a certified copy thereof prepared by the SHENZHEN TIMEWAY TESTING LABORATORIES, to his customer, supplier or other persons directly concerned. SHENZHEN TIMEWAY TESTING LABORATORIES, will not, without the consent of the client enter into any discussion of correspondence with any third party concerning the contents of the report.

In the event of the improper use of the report, the SHENZHEN TIMEWAY TESTING LABORATORIES, reserves the rights to withdraw it and to adopt any other remedies which may be appropriate.



10.0 Photo of testing

10.1 Conducted test View



The report refers only to the sample tested and does not apply to the bulk.

This report is issued in confidence to the client and it will be strictly treated as such by the SHENZHEN TIMEWAY TESTING LABORATORIES. It may not be reproduced rather in its entirety or in part and it may not be used for advertizing. The client to whom the report is issued may, however, show or send it . or a certified copy there of prepared by the SHENZHEN TIMEWAY TESTING LABORATORIES. to his customer. Supplier or others persons directly concerned. SHENZHEN TIMEWAY TESTING LABORATORIES. will not, without the consent of the client enter into any discussion of correspondence with any third party concerning the contents of the report.

In the event of the improper use of the report. The SHENZHEN TIMEWAY TESTING LABORATORIES. reserves the rights to withdraw it and to adopt any other remedies which may be appropriate.



10.2 Radiated emission test view

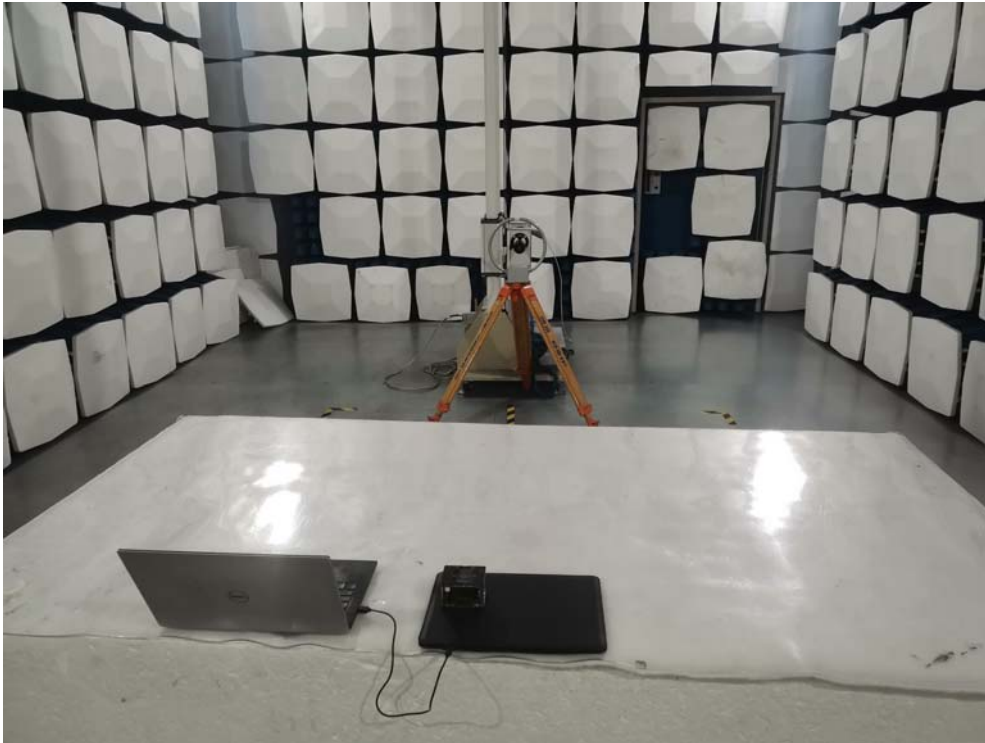

The report refers only to the sample tested and does not apply to the bulk.
This report is issued in confidence to the client and it will be strictly treated as such by the SHENZHEN TIMEWAY TESTING LABORATORIES. It may not be reproduced rather in its entirety or in part and it may not be used for advertising. The client to whom the report is issued may, however, show or send it . or a certified copy there of prepared by the SHENZHEN TIMEWAY TESTING LABORATORIES. to his customer. Supplier or others persons directly concerned. SHENZHEN TIMEWAY TESTING LABORATORIES. will not, without the consent of the client enter into any discussion of correspondence with any third party concerning the contents of the report.
In the event of the improper use of the report. The SHENZHEN TIMEWAY TESTING LABORATORIES. reserves the rights to withdraw it and to adopt any other remedies which may be appropriate.

Photographs – EUT

Outside View



The report refers only to the sample tested and does not apply to the bulk.

This report is issued in confidence to the client and it will be strictly treated as such by the SHENZHEN TIMEWAY TESTING LABORATORIES. It may not be reproduced rather in its entirety or in part and it may not be used for advertising. The client to whom the report is issued may, however, show or send it, or a certified copy thereof prepared by the SHENZHEN TIMEWAY TESTING LABORATORIES, to his customer. Supplier or others persons directly concerned. SHENZHEN TIMEWAY TESTING LABORATORIES, will not, without the consent of the client enter into any discussion of correspondence with any third party concerning the contents of the report.

In the event of the improper use of the report. The SHENZHEN TIMEWAY TESTING LABORATORIES, reserves the rights to withdraw it and to adopt any other remedies which may be appropriate.



Outside View



The report refers only to the sample tested and does not apply to the bulk.

This report is issued in confidence to the client and it will be strictly treated as such by the SHENZHEN TIMEWAY TESTING LABORATORIES. It may not be reproduced in its entirety or in part and it may not be used for advertising. The client to whom the report is issued may, however, show or send it, or a certified copy thereof prepared by the SHENZHEN TIMEWAY TESTING LABORATORIES, to his customer, supplier or other persons directly concerned. SHENZHEN TIMEWAY TESTING LABORATORIES will not, without the consent of the client, enter into any discussion of correspondence with any third party concerning the contents of the report.

In the event of the improper use of the report, the SHENZHEN TIMEWAY TESTING LABORATORIES reserves the rights to withdraw it and to adopt any other remedies which may be appropriate.

Inside View

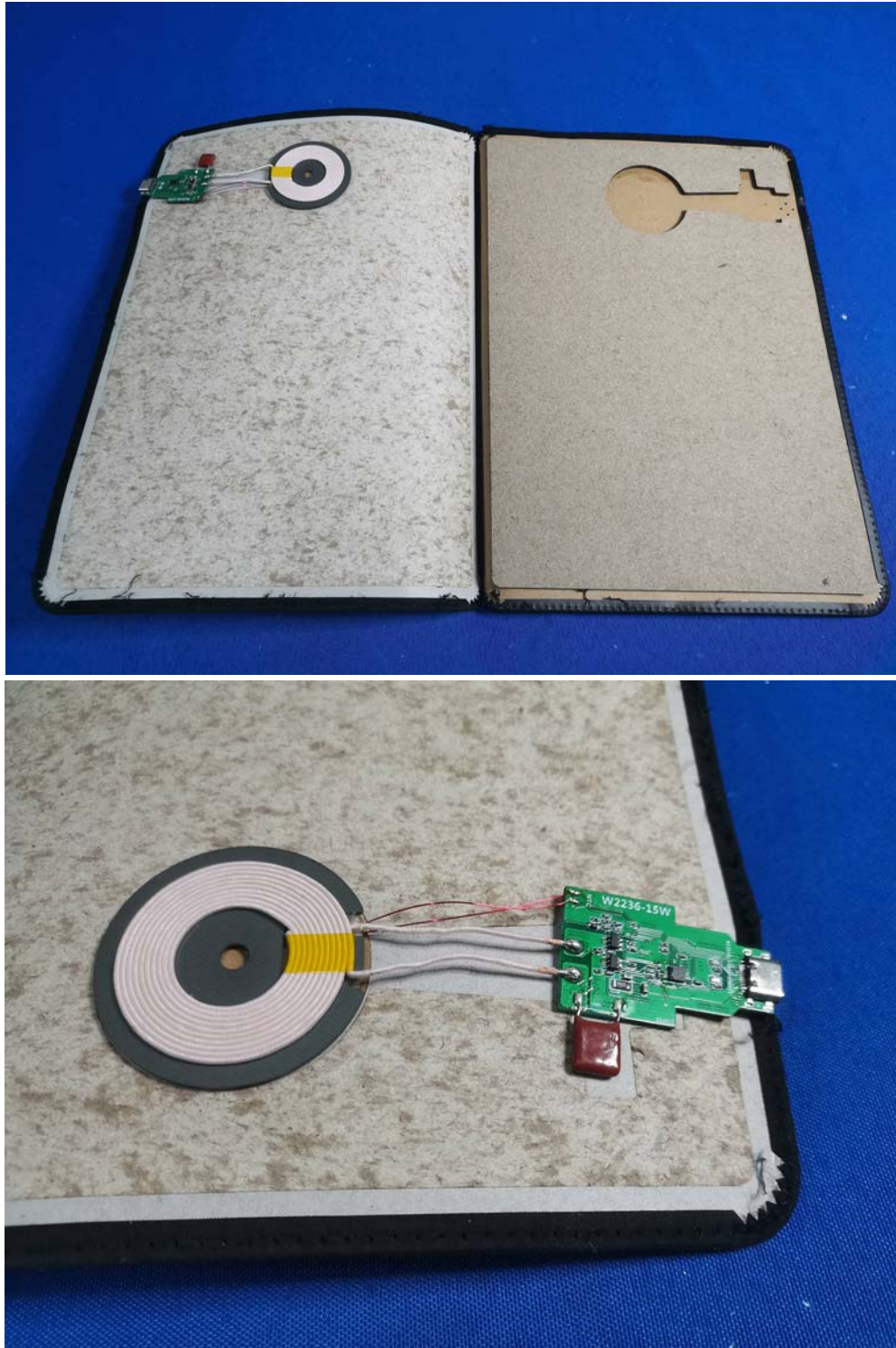

The report refers only to the sample tested and does not apply to the bulk.

This report is issued in confidence to the client and it will be strictly treated as such by the SHENZHEN TIMEWAY TESTING LABORATORIES. It may not be reproduced rather in its entirety or in part and it may not be used for advertising. The client to whom the report is issued may, however, show or send it . or a certified copy there of prepared by the SHENZHEN TIMEWAY TESTING LABORATORIES. to his customer. Supplier or others persons directly concerned. SHENZHEN TIMEWAY TESTING LABORATORIES. will not, without the consent of the client enter into any discussion of correspondence with any third party concerning the contents of the report.

In the event of the improper use of the report. The SHENZHEN TIMEWAY TESTING LABORATORIES. reserves the rights to withdraw it and to adopt any other remedies which may be appropriate.



Inside View

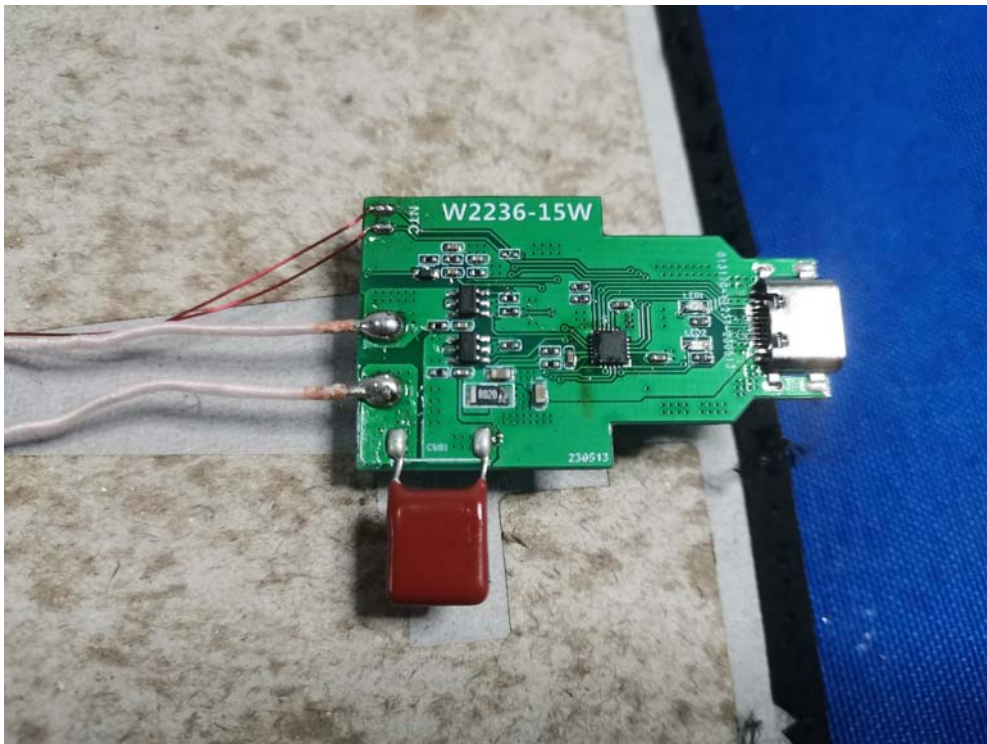
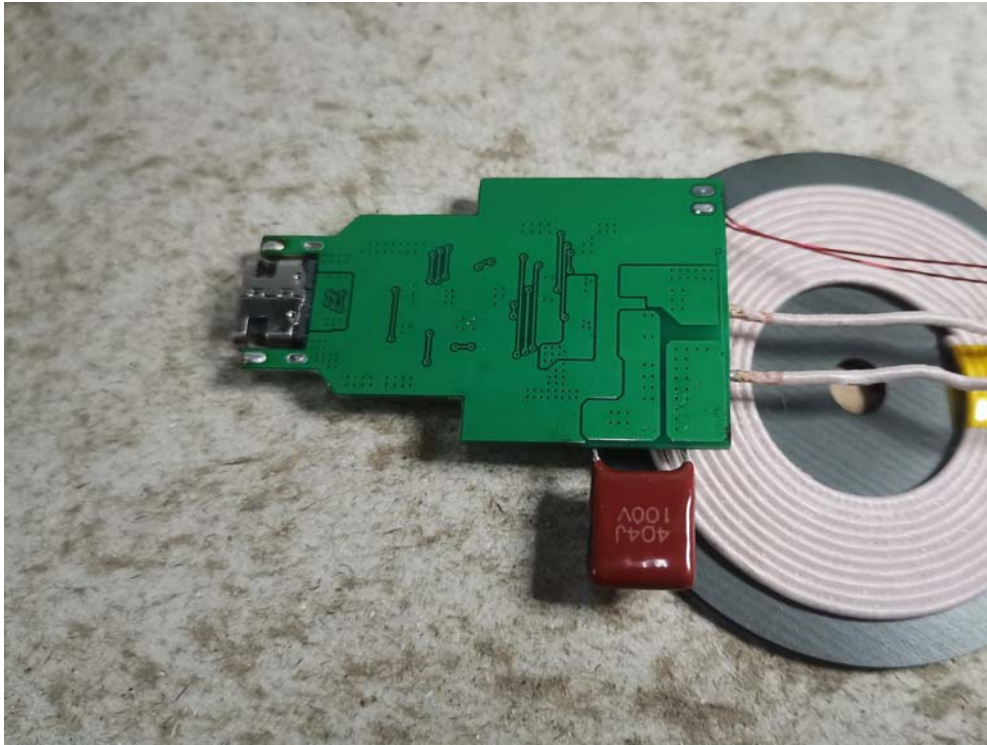

The report refers only to the sample tested and does not apply to the bulk.

This report is issued in confidence to the client and it will be strictly treated as such by the SHENZHEN TIMEWAY TESTING LABORATORIES. It may not be reproduced rather in its entirety or in part and it may not be used for advertising. The client to whom the report is issued may, however, show or send it, or a certified copy thereof prepared by the SHENZHEN TIMEWAY TESTING LABORATORIES, to his customer, supplier or others persons directly concerned. SHENZHEN TIMEWAY TESTING LABORATORIES, will not, without the consent of the client enter into any discussion of correspondence with any third party concerning the contents of the report.

In the event of the improper use of the report, the SHENZHEN TIMEWAY TESTING LABORATORIES, reserves the rights to withdraw it and to adopt any other remedies which may be appropriate.



Inside View

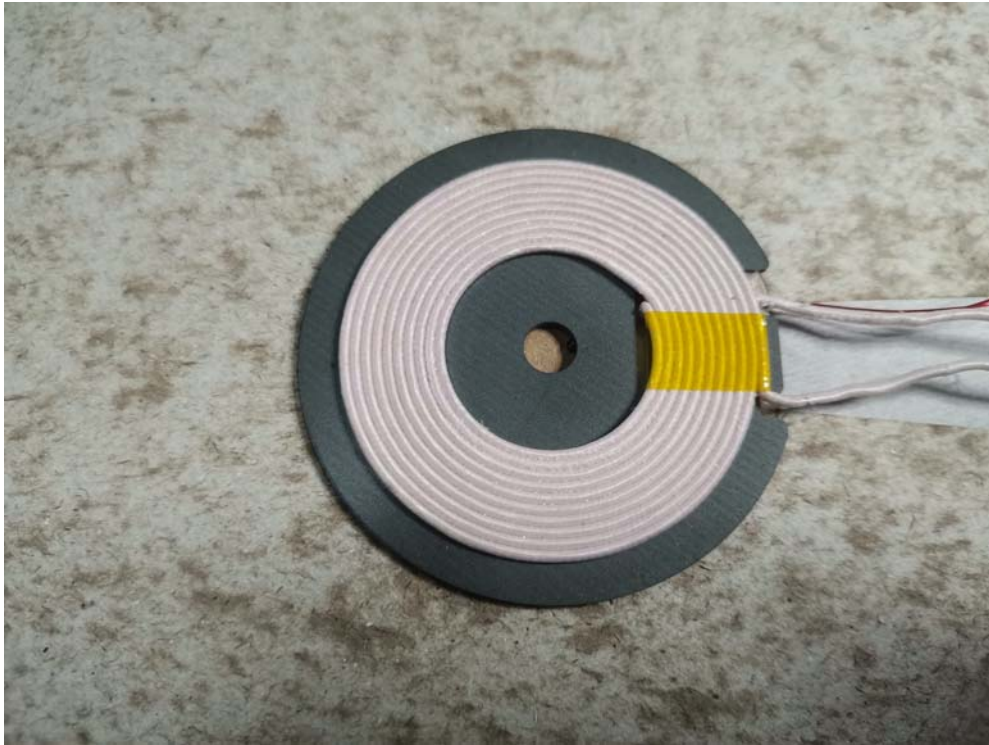

-End of the report-

The report refers only to the sample tested and does not apply to the bulk.

This report is issued in confidence to the client and it will be strictly treated as such by the SHENZHEN TIMEWAY TESTING LABORATORIES. It may not be reproduced rather in its entirety or in part and it may not be used for advertising. The client to whom the report is issued may, however, show or send it . or a certified copy there of prepared by the SHENZHEN TIMEWAY TESTING LABORATORIES. to his customer. Supplier or others persons directly concerned. SHENZHEN TIMEWAY TESTING LABORATORIES. will not, without the consent of the client enter into any discussion of correspondence with any third party concerning the contents of the report. In the event of the improper use of the report. The SHENZHEN TIMEWAY TESTING LABORATORIES. reserves the rights to withdraw it and to adopt any other remedies which may be appropriate.