



LCIE



Accreditation  
N°1-1633  
Scope available on  
www.cofrac.fr

Template : May 28<sup>th</sup>, 2024

# TEST REPORT

N°: 23206282-803702-B(FILE#7739604-SRA)

Version: 02

## Subject

Radio spectrum tests according to the standards:  
FCC CFR 47 Part 15.247 & ANSI C63.10  
RSS-247 & RSS-Gen

## Issued to

**SCHNEIDER ELECTRIC INDUSTRIE SAS**  
31 rue Pierre Mendes France  
38050 – GRENOBLE  
FRANCE

## Apparatus under test

Product	PowerTag F160 3P/3P+N
Trade mark	SCHNEIDER ELECTRIC
Manufacturer	SCHNEIDER ELECTRIC
Family range	PowerLogic
Model under test	PLTPPB1253P
Serial number	SM2418100400101 / SM2418100400115
FCCID	2AH7L-PLTPPB3P
IC	21522-PLTPPB3P

## Conclusion

See Test Program chapter

Test date	August 07, 2024 to August 12, 2024
Test location	LCIE Grenoble
FCC Test site	FR0008 - 918017 (MOI)
ISED Test site	6500A (MOI)
Sample receipt date	August 07, 2024
Composition of document	52 pages
Document issued on	November 29, 2024

## Written by :

Akram HAKKARI  
Tests operator

## Approved by :

Majid MOURZAGH  
Technical manager



Reproduction of this document is only authorized in its complete form. Any partial reproduction or any insertion of results in an accompanying text with a view to their distribution must receive prior and formal agreement from LCIE. This document results from tests carried out on a specimen, sample or test piece. It does not prejudice the conformity of all the products manufactured to the object tested. Unless otherwise indicated or rule specified by the test method, the decision of conformity does not take into account measurement uncertainty. It in no way prejudices a certification decision. The accreditation of the COFRAC Testing Section attests to the technical competence of the laboratories for the tests covered by the accreditation only. If certain tests mentioned in this report were carried out outside the framework of COFRAC accreditation, they are identified by the symbol

**LCIE**  
Laboratoire Central des Industries Electriques  
Une société Bureau Veritas

Z.I Centr'alp  
170, Rue de Chatagnon  
38430 Moirans  
FRANCE

Tél. + 33 4 76 07 36 36  
contact@lcie.fr  
[www.lcie.fr](http://www.lcie.fr)



## PUBLICATION HISTORY

Version	Date	Author	Modification
01	October 02, 2024	Akram HAKKARI	Creation of the document
02	November 29, 2024	Akram HAKKARI	Correction test setup

*Each new edition of this test report replaces and cancels the previous edition. The control of the old editions of report is under responsibility of client.*



## SUMMARY

1.	TEST PROGRAM .....	4
2.	EQUIPMENT UNDER TEST: CONFIGURATION (DECLARED BY PROVIDER).....	5
3.	OCCUPIED BANDWIDTH.....	12
4.	6DB BANDWIDTH .....	16
5.	MAXIMUM CONDUCTED OUTPUT POWER .....	20
6.	POWER SPECTRAL DENSITY .....	25
7.	UNWANTED EMISSIONS IN NON-RESTRICTED FREQUENCY BANDS .....	29
8.	UNWANTED EMISSIONS IN RESTRICTED FREQUENCY BANDS .....	36
9.	UNCERTAINTIES CHART .....	52



## 1. TEST PROGRAM

### References

- 47 CFR Part 15.247 (2023)
- RSS 247 Issue 3
- RSS Gen Issue 5
- KDB 558074 D01 DTS Meas Guidance v05r02 [P](#)
- KDB 662911 D01 Multiple Transmitter Output v02r01 [P](#)
- ANSI C63.10 (2013)

### Radio requirement:

Clause - Test Description		Test result - Comments
Occupied Bandwidth	<i>ISED</i>	PASS
6dB Bandwidth	<i>FCC &amp; ISED</i>	PASS
Maximum Conducted Output Power	<i>FCC &amp; ISED</i>	PASS
Power Spectral Density	<i>FCC &amp; ISED</i>	PASS
Unwanted Emissions in Non-Restricted Frequency Bands	<i>FCC &amp; ISED</i>	PASS
Unwanted Emissions in Restricted Frequency Bands	<i>FCC &amp; ISED</i>	PASS
Receiver Radiated Emissions	<i>ISED</i>	PASS(2)

This table is a summary of test report, see conclusion of each clause of this test report for detail.

(1) Limited program

(2) Testing covered the receive mode, and receiver spurious emissions are considered to be the same as transmitter.

PASS: EUT complies with standard's requirement

FAIL: EUT does not comply with standard's requirement

NA: Not Applicable

NP: Test Not Performed

## 2. EQUIPMENT UNDER TEST: CONFIGURATION (DECLARED BY PROVIDER)

### 2.1. HARDWARE IDENTIFICATION (EUT AND AUXILIARIES):

#### Equipment under test (EUT):

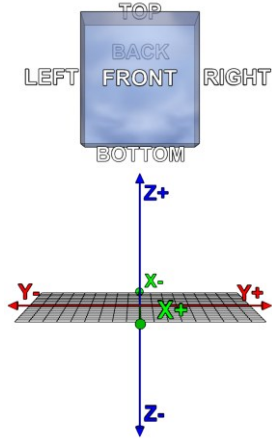
<b>Model under test:</b>	PLTPPB1253P
<b>Serial Number:</b>	SM2418100400101 / SM2418100400115
	
	
<b>Dimensions:</b>	6cm x 9cm x 3cm (Length x Width x Height)
<b>Type:</b>	Table-Top

#### Power supply:

Name	Type	Rating	Reference / Sn	Comments
Supply1	AC	3P+N 173...480 V AC (L-L)	-	-

NC: Not communicated by provider



L C I E

**Inputs/outputs - Cable:**

Access	Type	Length used (m)	Declared <3m	Shielded	Comments
Supply1	3P+N 173...480 V AC (L-L)	4	No	No	-

NC: Not communicated by provider

**Auxiliary equipment used during test:**

Type	Reference	Sn	Comments
Laptop	LENOVO	-	-
Zigbee DONGLE	-	-	-

NC: Not communicated by provider



**Equipment information (declaration of provider):**

<b>802.15.4:</b>	<b>ZigBee</b>
Chipset / RF Module	EFR32MG13P732F512IM32
Frequency band:	[2400 – 2483.5] MHz
Spectrum Modulation:	DSSS
Number of Channel:	16
Spacing channel:	5MHz
Channel bandwidth:	2MHz
Antenna Type:	Internal
Antenna connector:	Temporary for tests
Antenna requirements §15.203	The transmitter uses an integral antenna and it permanently connected
Transmit chains:	1
Receiver chains	1

CHANNEL PLAN	
Channel	Frequency (MHz)
<b>Cmin: 11</b>	2405
12	2410
13	2415
14	2420
15	2425
16	2430
17	2435
<b>Cmid: 18</b>	2440
19	2445
20	2450
21	2455
22	2460
23	2465
24	2470
25	2475
<b>Cmax: 26</b>	2480

DATA RATE		
Data Rate (Mbps)	Modulation Type	Worst Case Modulation
0.25	O-QPSK	<input checked="" type="checkbox"/>



Antenna Characteristic			
Antenna reference	Gain (dBi)	Frequency Band (MHz)	Impedance( $\Omega$ )
Printed Antenna	4.4	2400-2480	50

Hardware information			
Highest internal frequency (PLL, Quartz, Clock, Microprocessor...):	<b>F<sub>Highest</sub>:</b>	<b>38.4</b>	<b>MHz</b>
Firmware (if applicable):	<b>V:</b>	Specific FW for RF tests	
Software (if applicable):	<b>V:</b>	NA	
Equipment intended:	Fixed		
Type of equipment:	Stand-alone		
Equipment sample:	Production model		
Duty cycle:	Continuous duty		
Operating temperature range:	<b>T<sub>min</sub>:</b>	-25 °C	
	<b>T<sub>nom</sub>:</b>	20°C	
	<b>T<sub>max</sub>:</b>	70 °C	
Operating voltage:	<b>V<sub>nom</sub>:</b>	400 VAC 50 Hz	

NC: Not communicated by provider





## 2.2. RUNNING MODE

Test mode	Description of test mode
Test mode 1	Permanent emission with modulation on a fixed channel in the data rate that produced the highest power. Using a companion a device with the EMC ZIGBEE radio Tool 1.5.4 Use T1 test
Test mode 2	Permanent reception Using a companion a device with the EMC ZIGBEE radio Tool 1.5.4 Use T3 and T4

Test	Running mode
Occupied Bandwidth	Test mode 1
6dB Bandwidth	Test mode 1
Maximum Conducted Output Power	Test mode 1
Power Spectral Density	Test mode 1
Conducted Spurious Emission at the Band Edge	Test mode 1
Unwanted Emissions in Non-Restricted Frequency Bands	Test mode 1
AC Power Line Conducted Emission	Test mode 1
Unwanted Emissions in Restricted Frequency Bands	Test mode 1
Receiver Radiated Emissions	Test mode 2 (1)

(1) Testing covered the receive mode, and receiver spurious emissions are considered to be the same as transmitter.

### 2.3. EQUIPMENT LABELLING

#### Label



### 2.4. EQUIPMENT MODIFICATIONS DURING THE TESTS

None



## 2.5. FIELD STRENGTH CALCULATION

The field strength is calculated by adding the Antenna Factor and Cable Factor, and subtracting the Amplifier Gain (if any) from the measured reading. The basic equation with a sample calculation is as follow:

$$FS = RA + AF + CF - AG$$

Where:

FS = Field Strength

RA = Receiver Amplitude

AF = Antenna Factor

CF = Cable Factor

AG = Amplifier Gain

Example:

Assume a receiver reading of 52.5dB $\mu$ V is obtained. The antenna factor of 7.4 and a cable factor of 1.1 are added. The amplifier gain of 29dB is subtracted, giving a field strength of 32 dB $\mu$ V/m.

$$FS = 52.5 + 7.4 + 1.1 - 29 = 32 \text{ dB}\mu\text{V/m}$$

The 32 dB $\mu$ V/m value can be mathematically converted to its corresponding level in  $\mu$ V/m.

$$\text{Level in } \mu\text{V/m} = \text{Common Antilogarithm } [(32\text{dB}\mu\text{V/m})/20] = 39.8 \mu\text{V/m.}$$

## 2.6. TEST DISTANCE EXTRAPOLATION – FCC/ISED

The field strength is extrapolated to the new measurement distance using formula from FCC Part15.31 (f) and §6.5-6.6 RSS-GEN:

Below 30MHz,

$$FS_{\text{limit}} = FS_{\text{max}} - 40 \log \left( \frac{d_{\text{limit}}}{d_{\text{measure}}} \right)$$

Above 30MHz,

$$FS_{\text{limit}} = FS_{\text{max}} - 20 \log \left( \frac{d_{\text{limit}}}{d_{\text{measure}}} \right)$$

Where:

$FS_{\text{limit}}$  is the calculation of field strength at the limit distance, expressed in dB $\mu$ V/m

$FS_{\text{max}}$  is the measured field strength, expressed in dB $\mu$ V/m

$d_{\text{measure}}$  is the distance of the measurement point from the EUT

$d_{\text{limit}}$  is the reference limit distance

## 2.7. CALIBRATION DATE

The calibration intervals are extended at 12+2 months. This extended interval is based on the fact that there is sufficient calibration data to statistically establish a trend or based on experience of use of the test equipment to assure good measurement results for a longer period. The symbol -/- replaces the date for equipment checking before test or that have none impact on the test or that have no calibration required by the standard.

## 2.8. METHOD TO DETERMINATE THE SPURIOUS RADIATED EMISSION

The Normalized Site Attenuation (NSA) is added to the maximum values observed during the azimuth search in order to obtain the spurious radiated emission. For spurious above -6dB from the limit found with the NSA, the Substitution Method is applied.

The substitution antenna replaces the equipment under test (EUT) for Effective Radiated Power (ERP) or Effective Isotropically Radiated Power (EIRP) measurement following the standard. Power is measured for a high level and calculated for the same level of radiated field strength obtained on the measuring antenna and EUT.

### 3. OCCUPIED BANDWIDTH

#### 3.1. TEST CONDITIONS

Date of test : August 09, 2024  
 Test performed by : Akram HAKKARI  
 Relative humidity (%) : 33  
 Ambient temperature (°C) : 21

#### 3.2. TEST SETUP

The Equipment Under Test is installed in an anechoic chamber. Measurement is performed with a spectrum analyzer in conducted method.

The EUT is turned ON, the center frequency of the spectrum analyzer is set to the fundamental frequency. The captured power is measured and recorded; the measurement is repeated until all frequencies required were complete.

Test Procedure:

*ANSI C63.10 § 6.9.2 and RSS-Gen Issue 5 § 6.7*

- RBW used in the range of 1% to 5% of the anticipated emission bandwidth
- Set the video bandwidth (VBW)  $\geq 3 \times$  RBW.
- Detector = Peak.
- Trace mode = Max Hold.
- Sweep = Auto couple.
- Allow the trace to stabilize.
- OBW 99% function of spectrum analyzer used

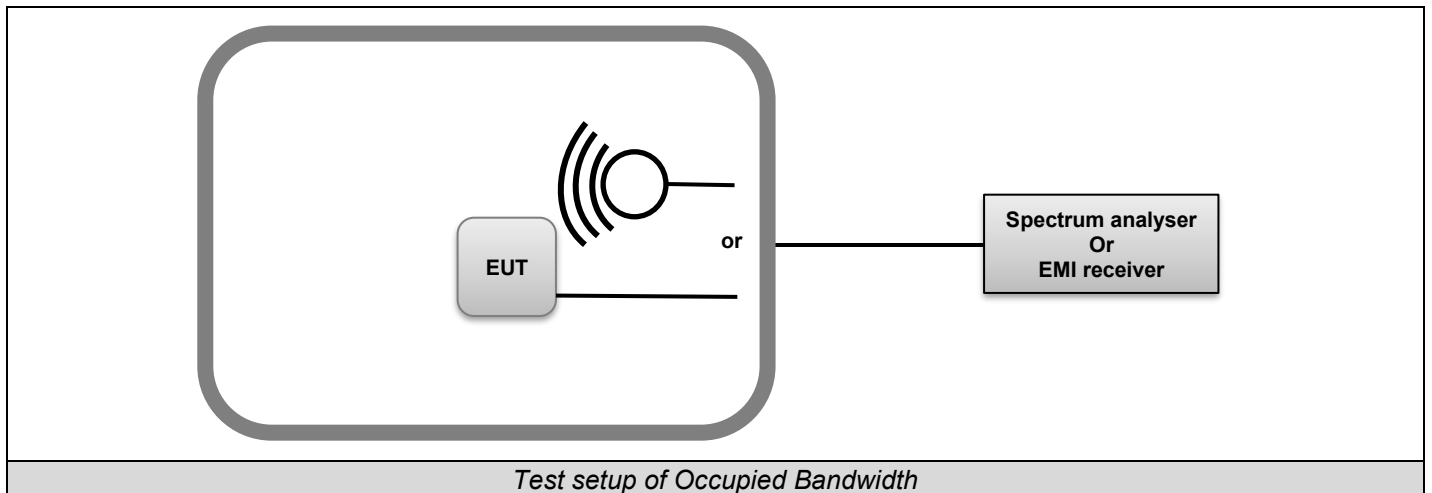

*Test setup of Occupied Bandwidth*



L C I E

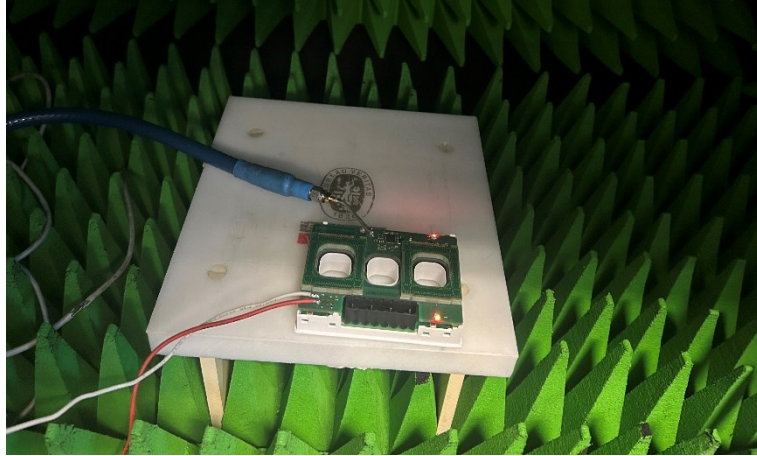

*Photo of Occupied bandwidth*

### 3.3. **LIMIT**

None



L C I E

### 3.4. TEST EQUIPMENT LIST

TEST EQUIPMENT USED					
Description	Manufacturer	Model	Identifier	Cal_Date	Cal_Due
Attenuator 10dB	AEROFLEX	–	A7122268	07/23	07/25
DC Power Supply	RS PRO	RS3005P	A7042314		
Full Anechoic Room	SIEPEL	–	D3044024		
SMA 1.5m	SUCOFLEX	18GHz	A5329864	10/23	10/24
SMA 1.5m	SUCOFLEX	18GHz	A5329863	08/24	08/25
Spectrum analyzer	ROHDE & SCHWARZ	FSV 40	A4060059	04/24	04/26
Thermo-hygrometer	TESTO	608-H1	B4204120	03/23	03/25

### 3.5. DIVERGENCE, ADDITION OR SUPPRESSION ON THE TEST SPECIFICATION

None

### 3.6. RESULTS

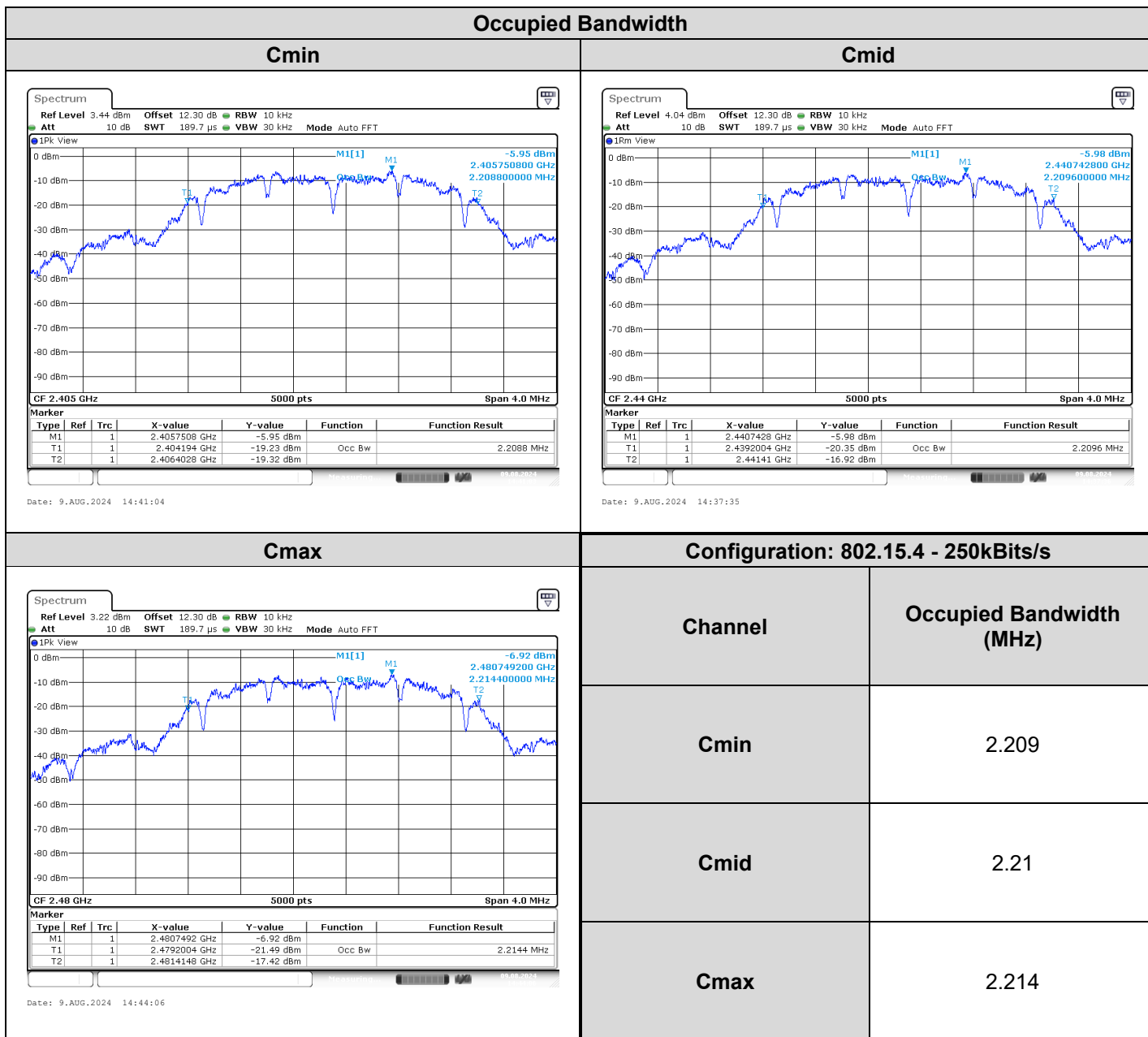

### 3.7. CONCLUSION

Occupied Channel Bandwidth measurement performed on the sample of the product **PLTPPB1253P**, Sn: **SM2418100400101 / SM2418100400115**, in configuration and description presented in this test report, show levels **compliant** to the **RSS-GEN** limits.

## 4. 6dB BANDWIDTH

### 4.1. TEST CONDITIONS

Date of test : August 09, 2024  
 Test performed by : Akram HAKKARI  
 Relative humidity (%) : 33  
 Ambient temperature (°C) : 21

### 4.2. TEST SETUP

The Equipment Under Test is installed in an anechoic chamber.  
 Measurement is performed with a spectrum analyzer in conducted method.

The EUT is turned ON, the center frequency of the spectrum analyzer is set to the fundamental frequency. The captured power is measured and recorded; the measurement is repeated until all frequencies required were complete.

Test Procedure:

*KDB 558074 D01 DTS Meas Guidance v05r02 § 8.2*

- Set resolution bandwidth (RBW) = 100kHz.
- Set the video bandwidth (VBW)  $\geq 3 \times$  RBW.
- Detector = Peak.
- Trace mode = max hold.
- Sweep = auto couple.
- Allow the trace to stabilize.
- Measure the maximum width of the emission that is constrained by the frequencies associated with the two outermost amplitude points (upper and lower) that are attenuated by 6 dB relative to the maximum level measured in the fundamental emission. Compare the resultant bandwidth with the RBW setting of the analyzer.

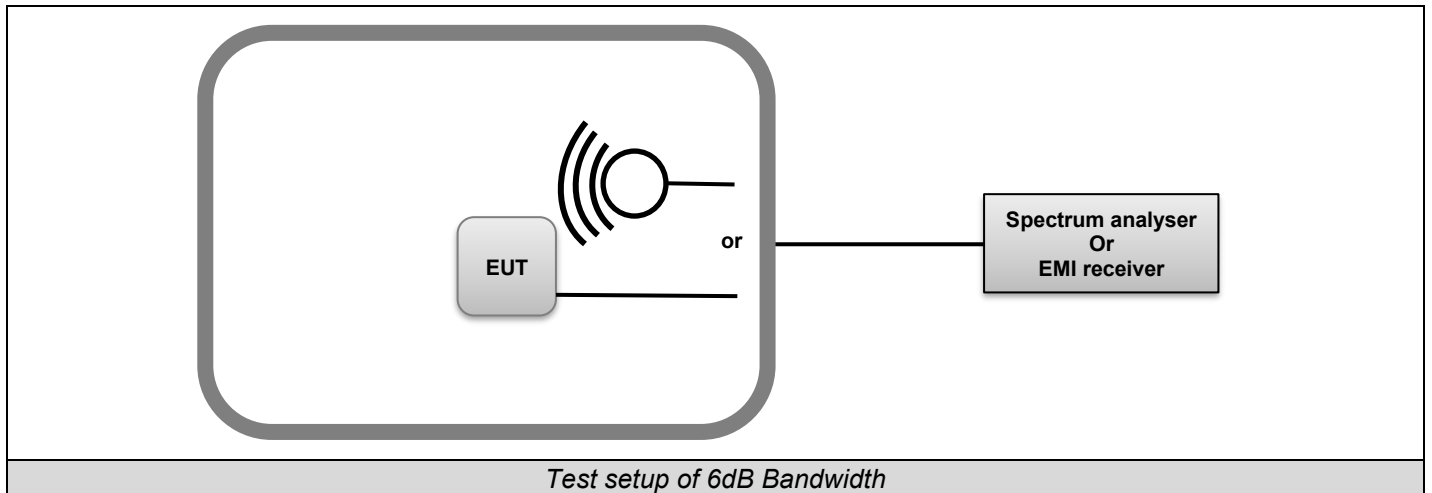



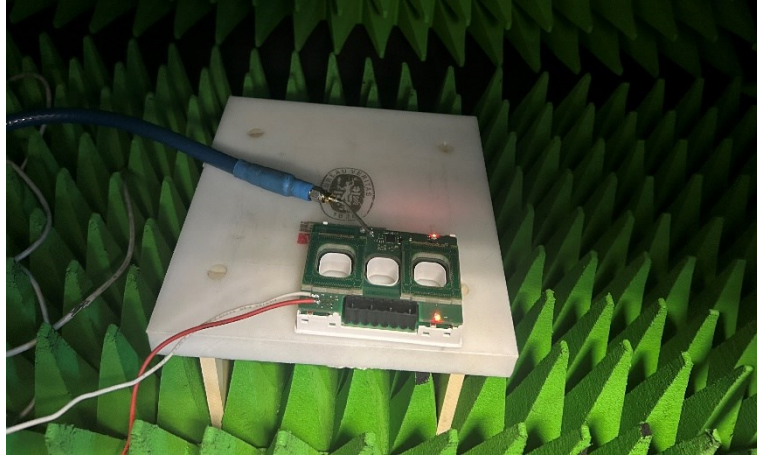

Photo of 6dB bandwidth

**4.3. LIMIT**

Frequency range	6dB bandwidth
902-928MHz 2400MHz to 2483.5MHz 5725-5850 MHz	≥500kHz



#### 4.4. TEST EQUIPMENT LIST

TEST EQUIPMENT USED					
Description	Manufacturer	Model	Identifier	Cal_Date	Cal_Due
Attenuator 10dB	AEROFLEX	–	A7122268	07/23	07/25
DC Power Supply	RS PRO	RS3005P	A7042314		
Full Anechoic Room	SIEPEL	–	D3044024		
SMA 1.5m	SUCOFLEX	18GHz	A5329864	10/23	10/24
SMA 1.5m	SUCOFLEX	18GHz	A5329863	08/24	08/25
Spectrum analyzer	ROHDE & SCHWARZ	FSV 40	A4060059	04/24	04/26
Thermo-hygrometer	TESTO	608-H1	B4204120	03/23	03/25

#### 4.5. DIVERGENCE, ADDITION OR SUPPRESSION ON THE TEST SPECIFICATION

None



L C I E

**4.6. RESULTS**

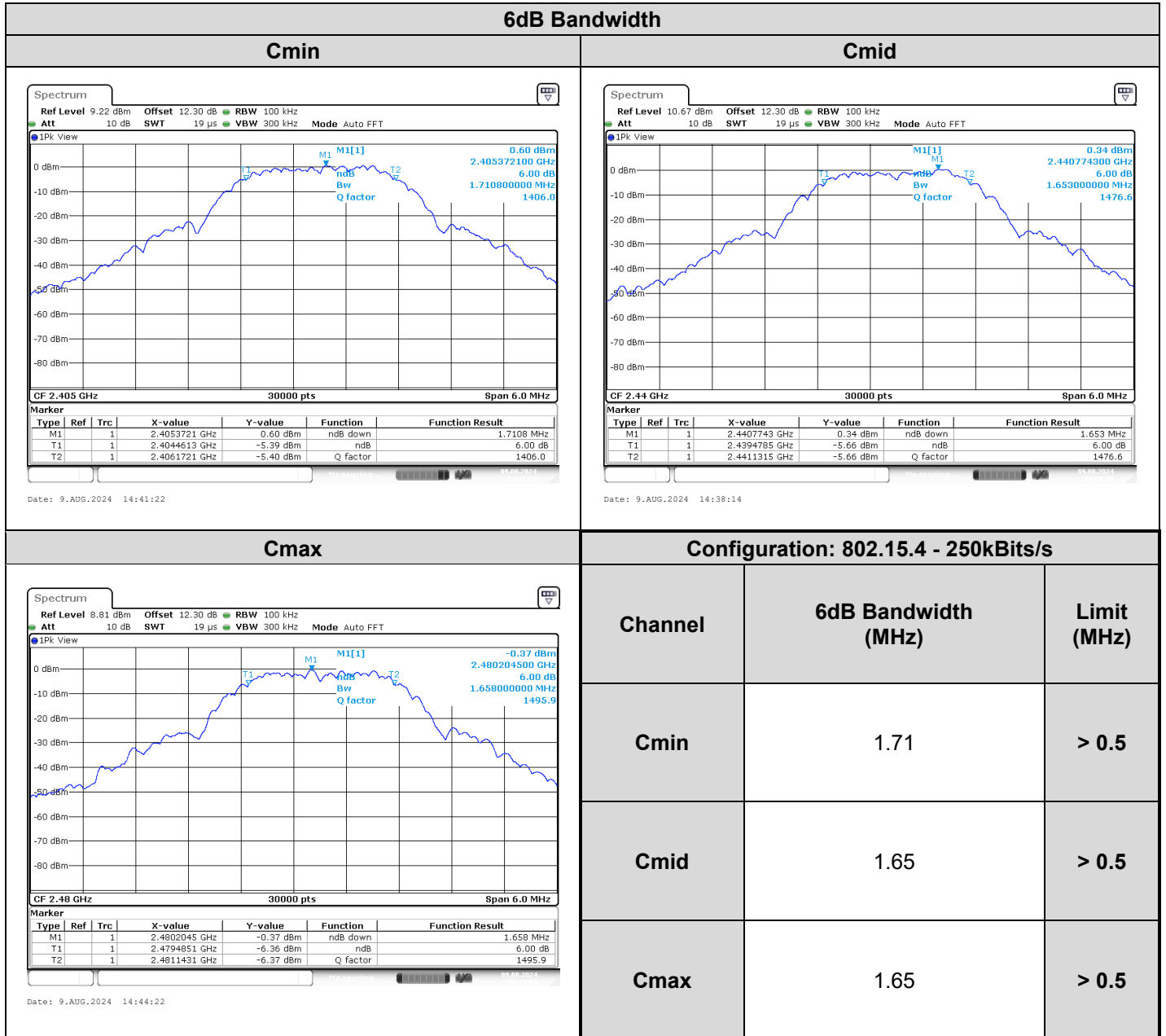

**4.7. CONCLUSION**

6dB Bandwidth measurement performed on the sample of the product **PLTPPB1253P**, Sn: **SM2418100400101 / SM2418100400115**, in configuration and description presented in this test report, show levels **compliant** to the **47 CFR PART 15.247 & RSS 247** limits.



## 5. MAXIMUM CONDUCTED OUTPUT POWER

### 5.1. TEST CONDITIONS

Date of test	: August 09, 2024
Test performed by	: Akram HAKKARI
Relative humidity (%)	: 33
Ambient temperature (°C)	: 21

### 5.2. TEST SETUP

The Equipment Under Test is installed in an anechoic chamber.  
Measurement is performed with a spectrum analyzer in conducted method.

The EUT is turned ON, the center frequency of the spectrum analyzer is set to the fundamental frequency. The captured power is measured and recorded; the measurement is repeated until all frequencies required were complete.

Test Procedure used: KDB 558074 D01 DTS Meas Guidance v05r02 § 8.3.1.1

#### *KDB 558074 D01 DTS Meas Guidance v05r02 § 8.3.1.1*

This procedure shall be used when the measurement instrument has available a resolution bandwidth that is greater than the DTS bandwidth.

- Set the RBW  $\geq$  DTS bandwidth.
- Set VBW  $\geq 3 \times$  RBW.
- Set span  $\geq 3 \times$  RBW
- Sweep time = auto couple.
- Detector = peak.
- Trace mode = max hold.
- Allow trace to fully stabilize.
- Use peak marker function to determine the peak amplitude level.

#### *KDB 558074 D01 DTS Meas Guidance v05r02 § 8.3.1.2*

This procedure may be used when the maximum available RBW of the measurement instrument is less than the DTS bandwidth.

- Set the RBW = 1 MHz.
- Set the VBW  $\geq 3 \times$  RBW
- Set the span  $\geq 1.5 \times$  DTS bandwidth.
- Detector = peak.
- Sweep time = auto couple.
- Trace mode = max hold.
- Allow trace to fully stabilize.
- Use the instrument's band/channel power measurement function with the band limits set equal to the DTS bandwidth edges

#### *KDB 558074 D01 DTS Meas Guidance v05r02 § 8.3.2.2(Method AVGSA-1)*

Subclause 11.9.2.2 of ANSI C63.10 is applicable, Method AVGSA-1 uses trace averaging with the EUT transmitting at full power throughout each sweep.

- a) Set span to at least 1.5 times the OBW.
- b) Set RBW = 1% to 5% of the OBW, not to exceed 1 MHz.
- c) Set VBW  $\geq [3 \times$  RBW].
- d) Number of points in sweep  $\geq [2 \times$  span / RBW]. (This gives bin-to-bin spacing  $\leq$  RBW / 2, so that narrowband signals are not lost between frequency bins.)
- e) Sweep time = auto.
- f) Detector = RMS (i.e., power averaging), if available. Otherwise, use sample detector mode.
- g) If transmit duty cycle  $< 98\%$ , use a sweep trigger with the level set to enable triggering only on full power pulses. The transmitter shall operate at the maximum power control level for the entire duration of every sweep. If the EUT transmits continuously (i.e., with no OFF intervals) or at duty cycle  $\geq 98\%$ , and if each transmission is entirely at the maximum power control level, then the trigger shall be set to "free run."
- h) Trace average at least 100 traces in power averaging (rms) mode.
- i) Compute power by integrating the spectrum across the OBW of the signal using the instrument's band power measurement function, with band limits set equal to the OBW band edges. If the instrument does not have a band power function, sum the spectrum levels (in power units) at intervals equal to the RBW extending across the entire OBW of the spectrum.

**KDB 558074 D01 DTS Meas Guidance v05r02 § 8.3.2.2(Method AVGSA-2)**

Subclause 11.9.2.2 of ANSI C63.10 is applicable.

Method AVGSA-2 uses trace averaging across ON and OFF times of the EUT transmissions, followed by duty cycle correction. The procedure for this method is as follows:

- o a) Measure the duty cycle D of the transmitter output signal as described in 11.6.
- o b) Set span to at least 1.5 times the OBW.
- o c) Set RBW = 1% to 5% of the OBW, not to exceed 1 MHz.
- o d) Set VBW  $\geq [3 \times \text{RBW}]$ .
- o e) Number of points in sweep  $\geq [2 \times \text{span} / \text{RBW}]$ . (This gives bin-to-bin spacing  $\leq \text{RBW} / 2$ , so that narrowband signals are not lost between frequency bins.)
- o f) Sweep time = auto.
- o g) Detector = RMS (i.e., power averaging), if available. Otherwise, use the sample detector mode.
- o h) Do not use sweep triggering. Allow the sweep to “free run.”
- o i) Trace average at least 100 traces in power averaging (rms) mode; however, the number of traces to be averaged shall be increased above 100 as needed such that the average accurately represents the true average over the ON and OFF periods of the transmitter.
- o j) Compute power by integrating the spectrum across the OBW of the signal using the instrument’s band power measurement function with band limits set equal to the OBW band edges. If the instrument does not have a band power function, then sum the spectrum levels (in power units) at intervals equal to the RBW extending across the entire OBW of the spectrum.
- o k) Add  $[10 \log (1 / D)]$ , where D is the duty cycle, to the measured power to compute the average power during the actual transmission times (because the measurement represents an average over both the ON and OFF times of the transmission). For example, add  $[10 \log (1/0.25)] = 6 \text{ dB}$  if the duty cycle is 25%.

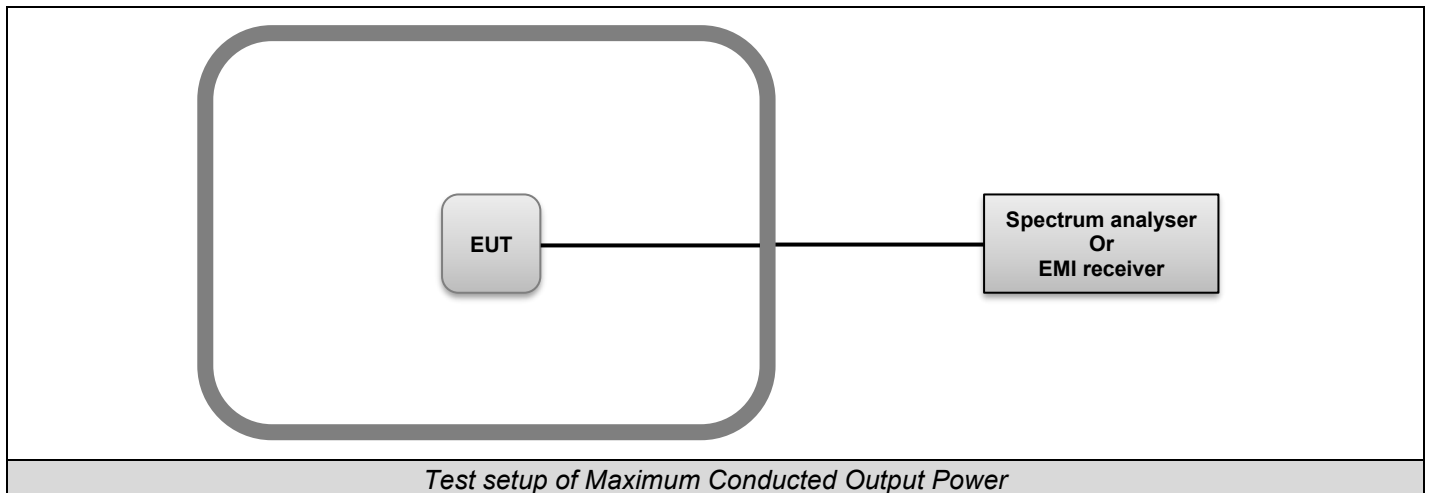



L C I E

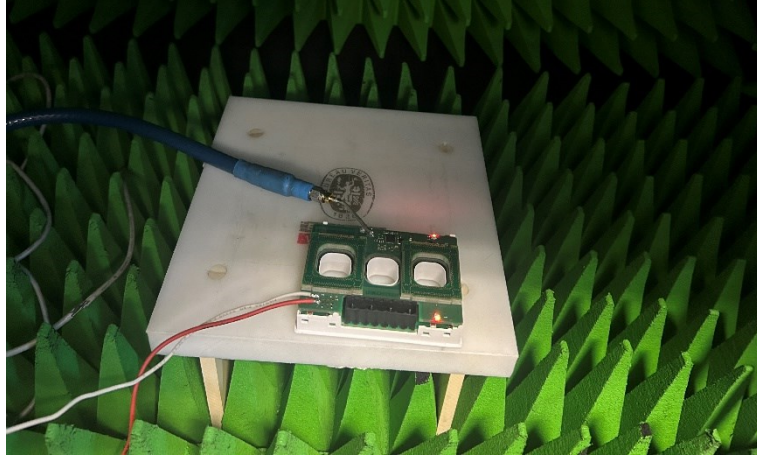

*Photo of Maximum Conducted Output Power*



### 5.3. LIMIT

Frequency range	Maximum Conducted Output Power
902-928MHz 2400MHz to 2483.5MHz 5725-5850 MHz	≤30dBm*

\*Remark: Limits are reduced by G-6dBi if Overall Antenna Gain above 6dBi

### 5.4. TEST EQUIPMENT LIST

TEST EQUIPMENT USED					
Description	Manufacturer	Model	Identifier	Cal_Date	Cal_Due
Attenuator 10dB	AEROFLEX	-	A7122268	07/23	07/25
DC Power Supply	RS PRO	RS3005P	A7042314		
Full Anechoic Room	SIEPEL	-	D3044024		
SMA 1.5m	SUCOFLEX	18GHz	A5329864	10/23	10/24
SMA 1.5m	SUCOFLEX	18GHz	A5329863	08/24	08/25
Spectrum analyzer	ROHDE & SCHWARZ	FSV 40	A4060059	04/24	04/26
Thermo-hygrometer	TESTO	608-H1	B4204120	03/23	03/25

### 5.5. DIVERGENCE, ADDITION OR SUPPRESSION ON THE TEST SPECIFICATION

None



L C I E

## 5.6. RESULTS

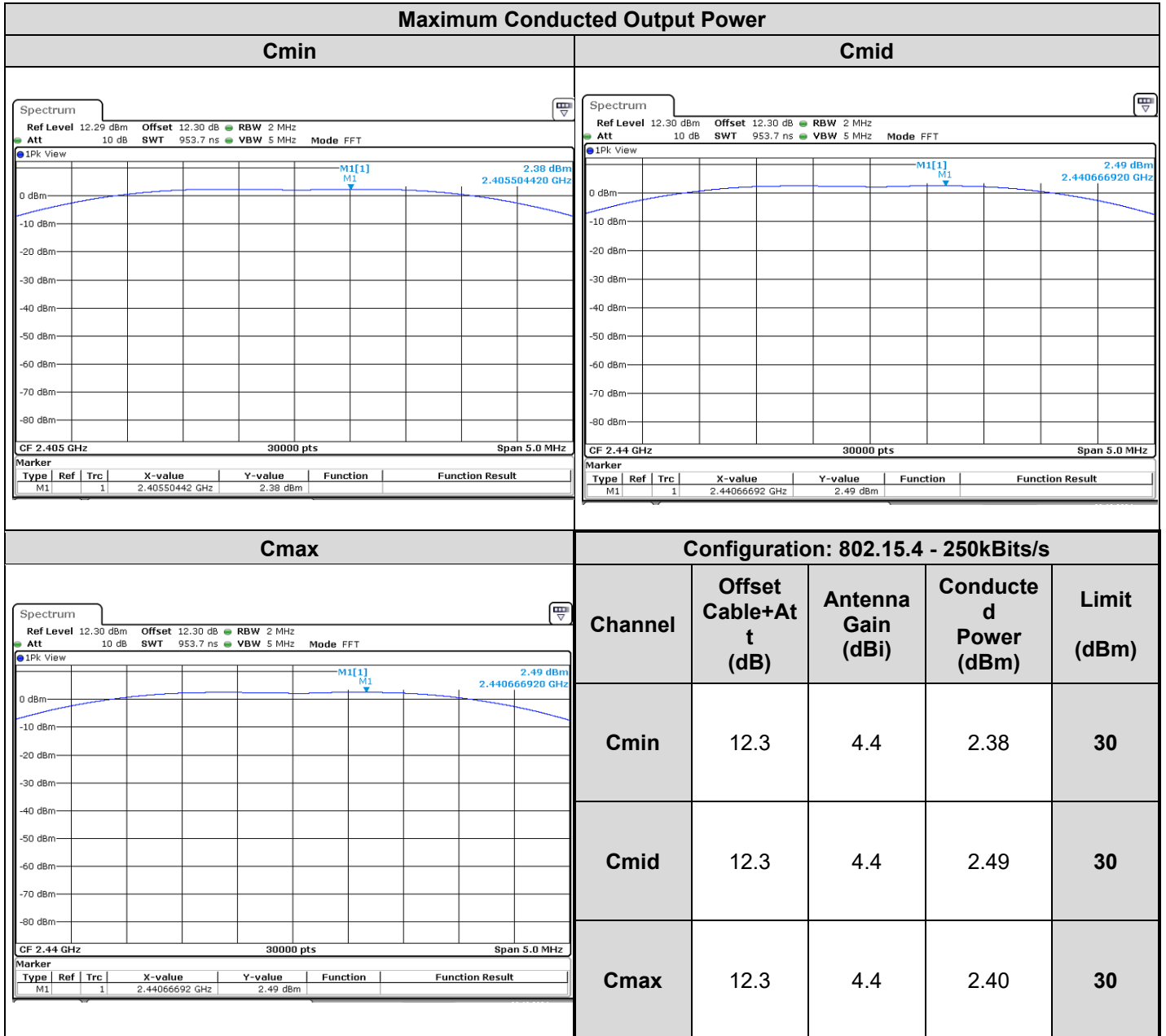

## 5.7. CONCLUSION

Maximum Output Conducted Power measurement performed on the sample of the product **PLTPPB1253P**, Sn: **SM2418100400101 / SM2418100400115**, in configuration and description presented in this test report, show levels compliant to the 47 CFR PART 15.247 & RSS 247 limits.





## 6. POWER SPECTRAL DENSITY

### 6.1. TEST CONDITIONS

Date of test : August 12, 2024  
Test performed by : Akram HAKKARI  
Relative humidity (%) : 33  
Ambient temperature (°C) : 21

### 6.2. TEST SETUP

The Equipment Under Test is installed in an anechoic chamber.  
Measurement is performed with a spectrum analyzer in conducted method.

The EUT is turned ON, the center frequency of the spectrum analyzer is set to the fundamental frequency. The captured power is measured and recorded; the measurement is repeated until all frequencies required were complete.

Test Procedure used: KDB 558074 D01 DTS Meas Guidance v05r02 § 8.4 (Method PKPSD)

*KDB 558074 D01 DTS Meas Guidance v05r02 § 8.4 (Method PKPSD)*

Subclause 11.10 of ANSI C63.10 is applicable

- o Set analyzer center frequency to DTS channel center frequency.
- o Set the span to 1.5 times the DTS bandwidth.
- o Set the RBW to: 3 kHz.
- o Set the VBW  $\geq 3 \times$  RBW.
- o Detector = peak.
- o Sweep time = auto couple.
- o Trace mode = max hold.
- o Allow trace to fully stabilize.
- o Use the peak marker function to determine the maximum amplitude level within the RBW.
- o If measured value exceeds limit, reduce RBW (no less than 3 kHz) and repeat.

*KDB 558074 D01 DTS Meas Guidance v05r02 § 8.4 (Method AVGPS-1)*

Subclause 11.10 of ANSI C63.10 is applicable

Method AVGPS-1 uses trace averaging with EUT transmitting at full power throughout each sweep. The following procedure may be used when the maximum (average) conducted output power was used to determine compliance to the fundamental output power limit. This is the baseline method for determining the maximum (average) conducted PSD level. If the instrument has a power averaging (rms) detector, then it must be used; otherwise, use the sample detector. The EUT must be configured to transmit continuously ( $D \geq 98\%$ ), or else sweep triggering/signal gating must be implemented to ensure that measurements are made only when the EUT is transmitting at its maximum power control level (no transmitter OFF time to be considered):

- o a) Set instrument center frequency to DTS channel center frequency.
- o b) Set span to at least 1.5 times the OBW.
- o c) Set RBW to:  $3 \text{ kHz} \leq \text{RBW} \leq 100 \text{ kHz}$ .
- o d) Set  $\text{VBW} \geq [3 \times \text{RBW}]$ .
- o e) Detector = power averaging (rms) or sample detector (when rms not available).
- o f) Ensure that the number of measurement points in the sweep  $\geq [2 \times \text{span} / \text{RBW}]$ .
- o g) Sweep time = auto couple.
- o h) Employ trace averaging (rms) mode over a minimum of 100 traces.
- o i) Use the peak marker function to determine the maximum amplitude level.
- o j) If the measured value exceeds requirement, then reduce RBW (but no less than 3 kHz) and repeat (note that this may require zooming in on the emission of interest and reducing the span to meet the minimum measurement point requirement as the RBW is reduced).

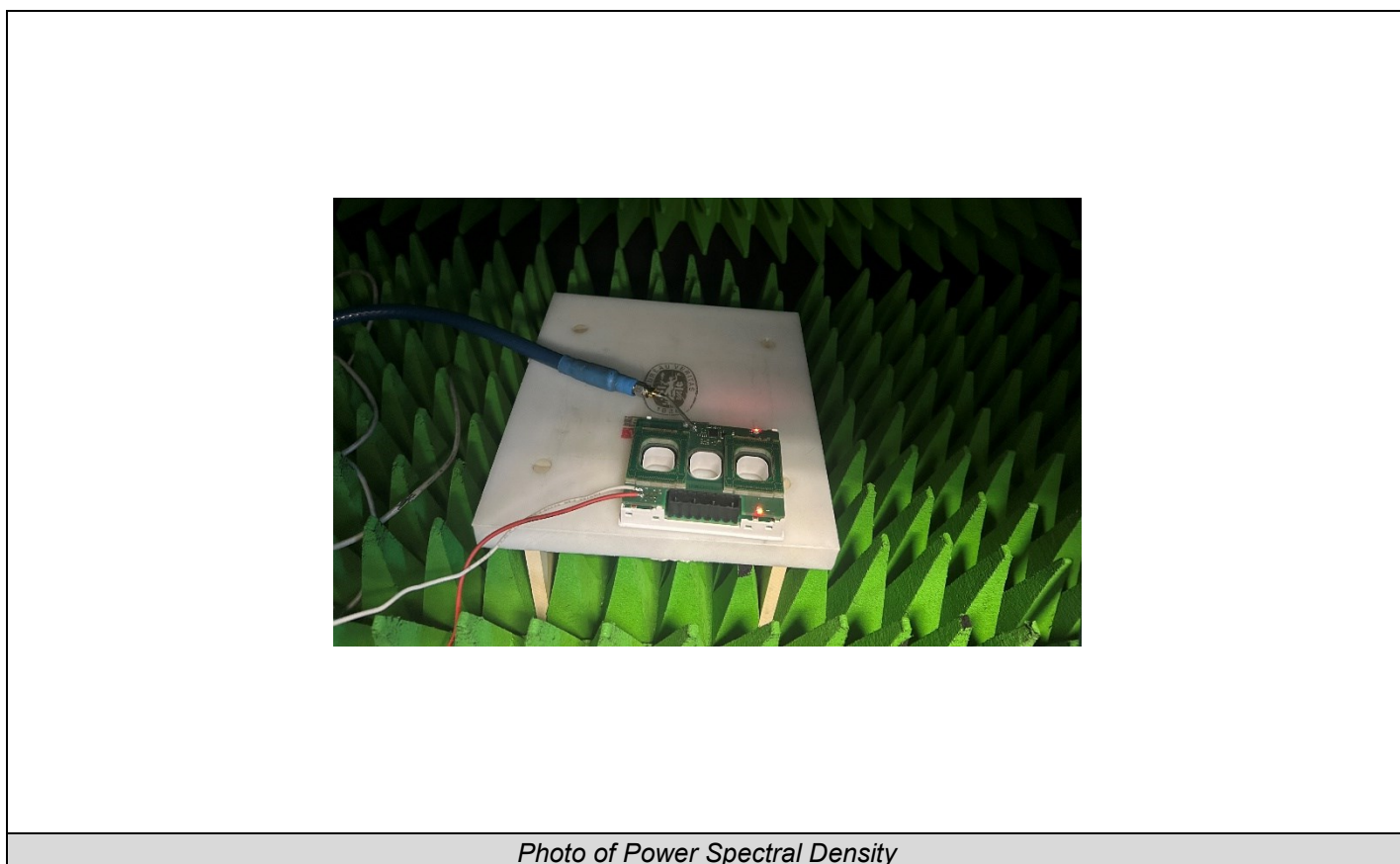
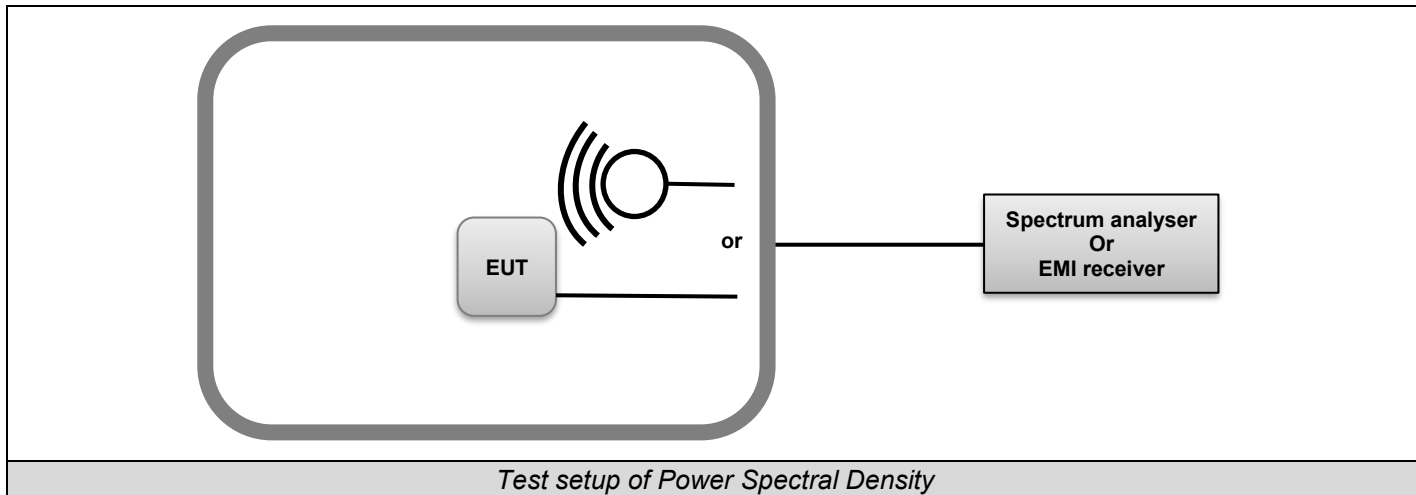



### 6.3. LIMIT

Frequency range	Power Spectral Density
902-928MHz 2400MHz to 2483.5MHz 5725-5850 MHz	≤8dBm / 3kHz *

\*Remark: Limits are reduced by G-6dBi if Overall Antenna Gain above 6dBi

### 6.4. TEST EQUIPMENT LIST

TEST EQUIPMENT USED					
Description	Manufacturer	Model	Identifier	Cal_Date	Cal_Due
Attenuator 10dB	AEROFLEX	_	A7122268	07/23	07/25
DC Power Supply	RS PRO	RS3005P	A7042314		
Full Anechoic Room	SIEPEL	_	D3044024		
SMA 1.5m	SUCOFLEX	18GHz	A5329864	10/23	10/24
SMA 1.5m	SUCOFLEX	18GHz	A5329863	08/24	08/25
Spectrum analyzer	ROHDE & SCHWARZ	FSV 40	A4060059	04/24	04/26
Thermo-hygrometer	TESTO	608-H1	B4204120	03/23	03/25

### 6.5. DIVERGENCE, ADDITION OR SUPPRESSION ON THE TEST SPECIFICATION

None



## 6.6. RESULTS

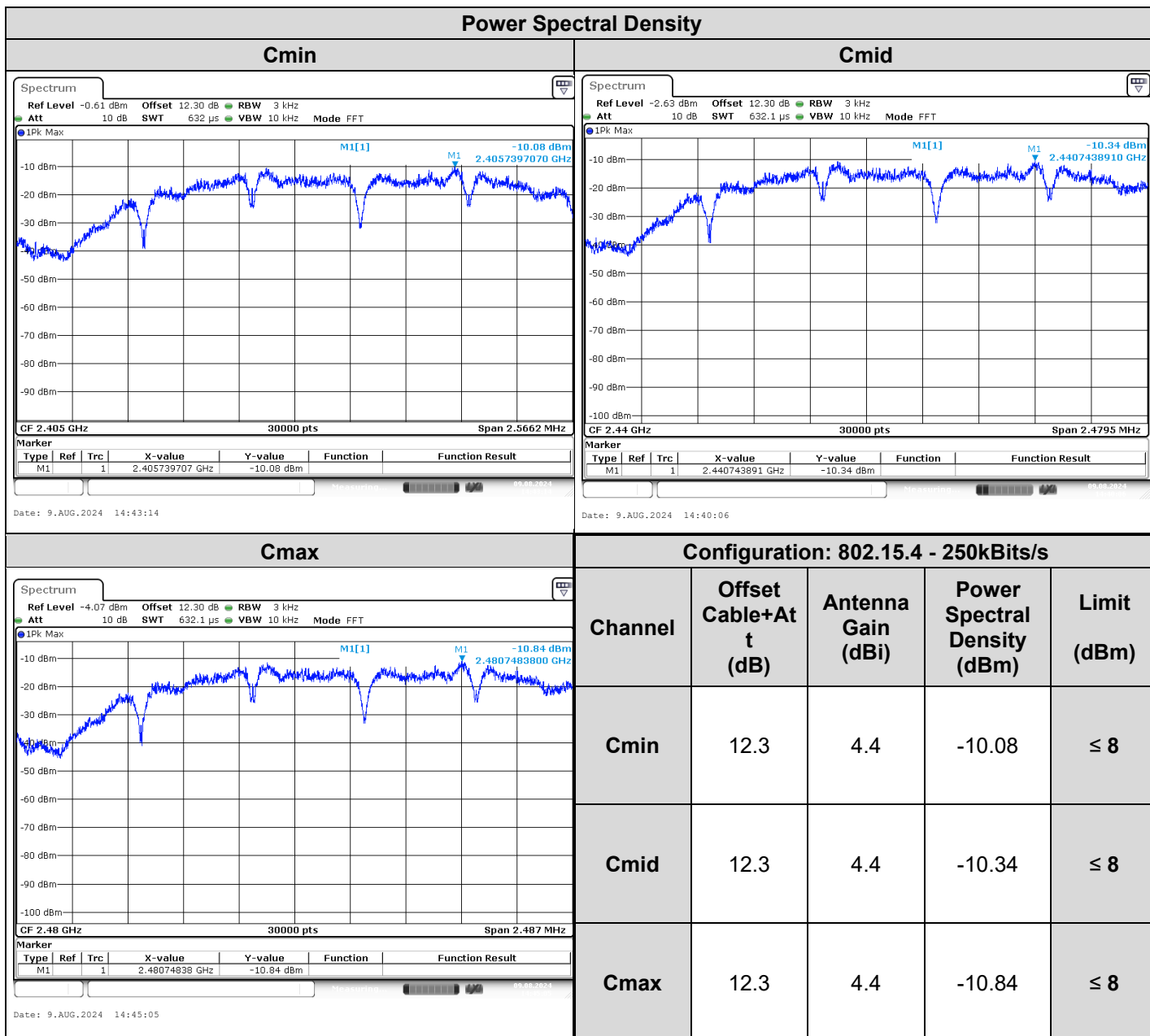

## 6.7. CONCLUSION

Power Spectral Density measurement performed on the sample of the product **PLTPPB1253P**, Sn: **SM2418100400101 / SM2418100400115**, in configuration and description presented in this test report, show levels **compliant** to the **47 CFR PART 15.247 & RSS 247** limits.

## 7. UNWANTED EMISSIONS IN NON-RESTRICTED FREQUENCY BANDS

### 7.1. TEST CONDITIONS

Date of test : August 12, 2024  
 Test performed by : Akram HAKKARI  
 Relative humidity (%) : 33  
 Ambient temperature (°C) : 21

### 7.2. TEST SETUP

The Equipment Under Test is installed in an anechoic chamber. Measurement is performed with a spectrum analyzer in conducted method.

The EUT is turned ON, the captured power is measured and recorded; the measurement is repeated until all frequencies required were complete.

Test Procedure:  
*KDB 558074 D01 DTS Meas Guidance v05r02 § 8.5*

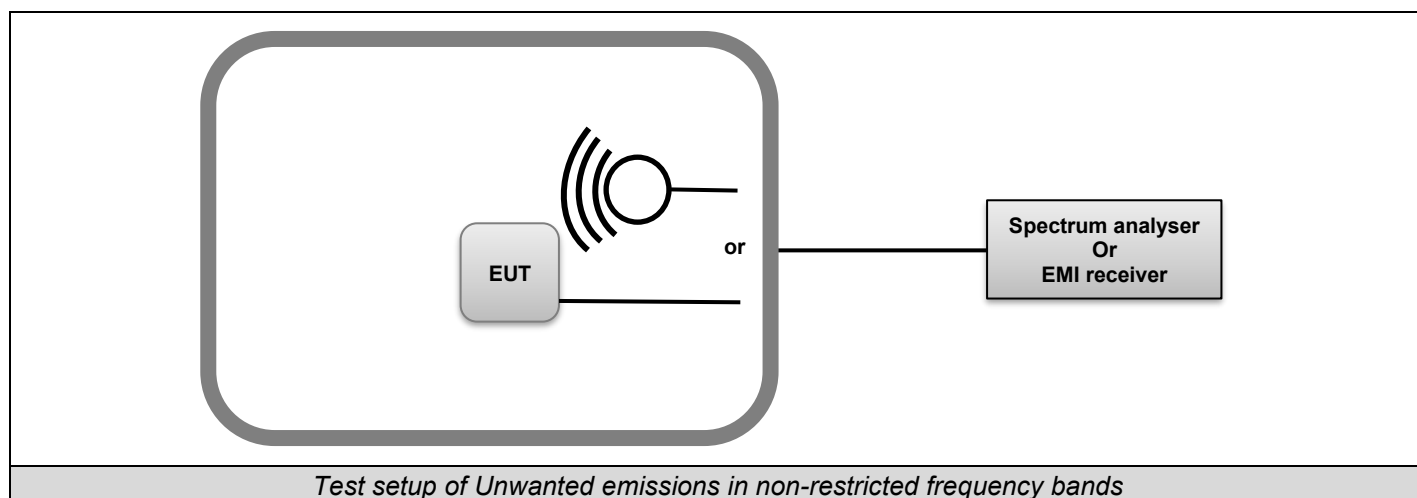



L C I E

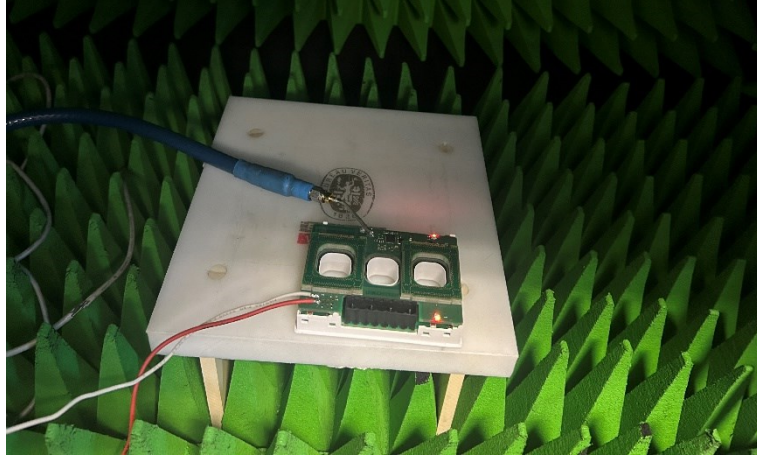

*Photo of Unwanted emissions in non-restricted frequency bands*



### 7.3. LIMIT

All Spurious Emissions must be at least 20dB below the Fundamental Radiator Level at the Band Edge of operating frequency band and in non-restricted bands.

### 7.4. TEST EQUIPMENT LIST

TEST EQUIPMENT USED					
Description	Manufacturer	Model	Identifier	Cal_Date	Cal_Due
Attenuator 10dB	AEROFLEX	_	A7122268	07/23	07/25
DC Power Supply	RS PRO	RS3005P	A7042314		
Full Anechoic Room	SIEPEL	_	D3044024		
SMA 1.5m	SUCOFLEX	18GHz	A5329864	10/23	10/24
SMA 1.5m	SUCOFLEX	18GHz	A5329863	08/24	08/25
Spectrum analyzer	ROHDE & SCHWARZ	FSV 40	A4060059	04/24	04/26
Thermo-hygrometer	TESTO	608-H1	B4204120	03/23	03/25

### 7.5. DIVERGENCE, ADDITION OR SUPPRESSION ON THE TEST SPECIFICATION

None



## 7.6. RESULTS

### 7.6.1. Operational frequency band

<b>Unwanted emissions in non-restricted bands at the band edge</b>
<b>Configuration: 802.15.4 - 250kBits/s</b>
<b>Cmin / Cmid / Cmax</b>
<b>Delta limit (dBc) determination</b>
<b>Tx1</b>

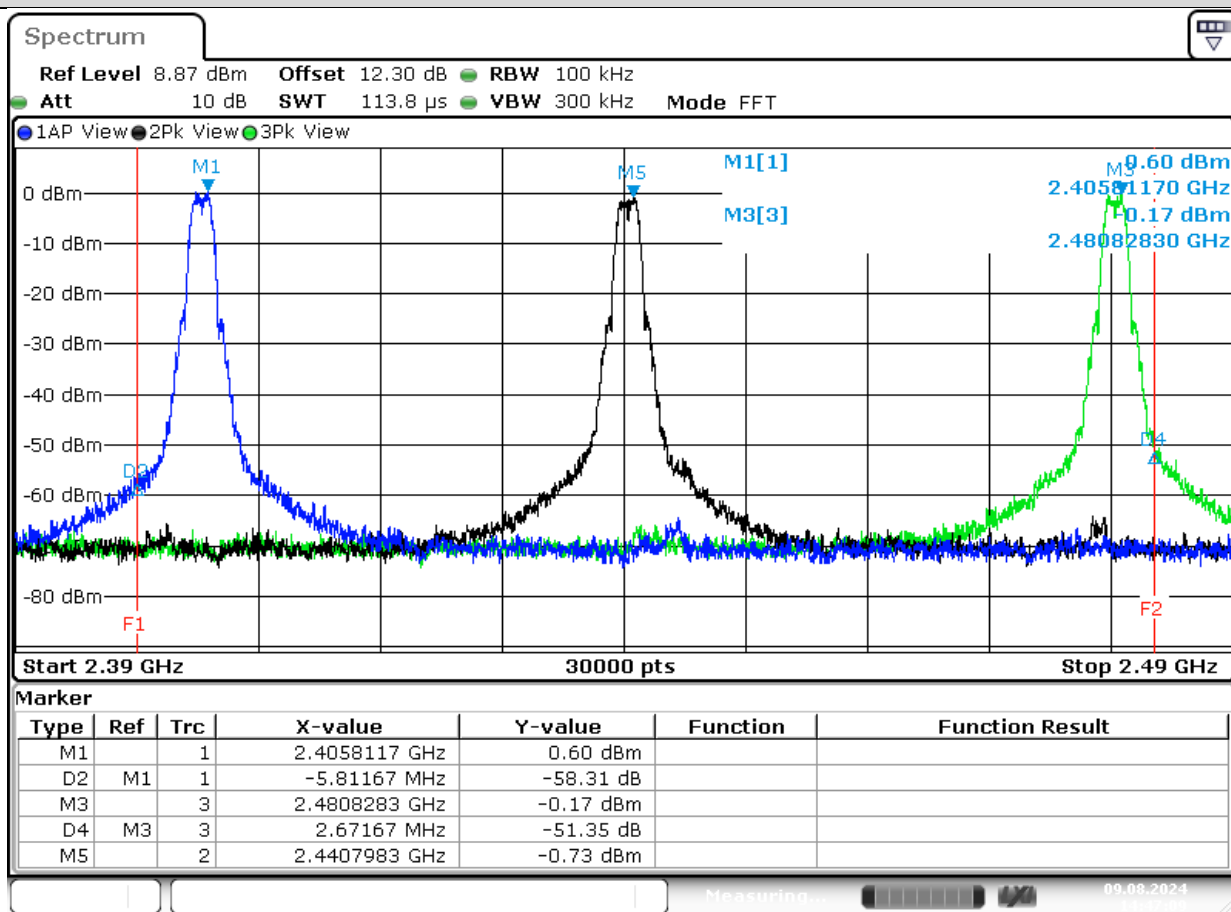

Date: 9.AUG.2024 14:47:09

Frequency (MHz)	Level (dBc)	Limit (dBc)
C <sub>min</sub>	-58.31	-30
C <sub>max</sub>	-51.35	-30





### 7.6.2. At the band edge

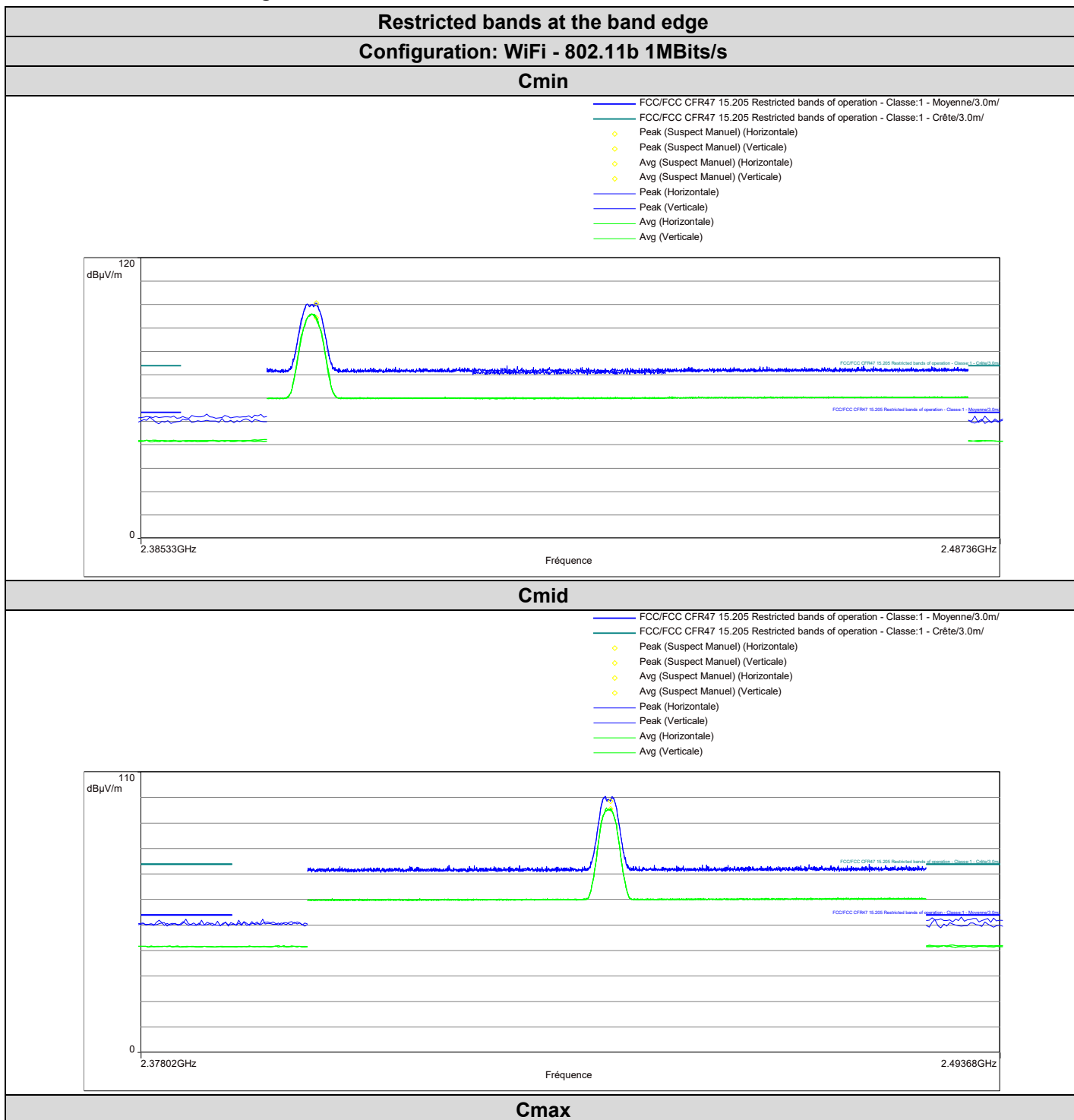



L C I E

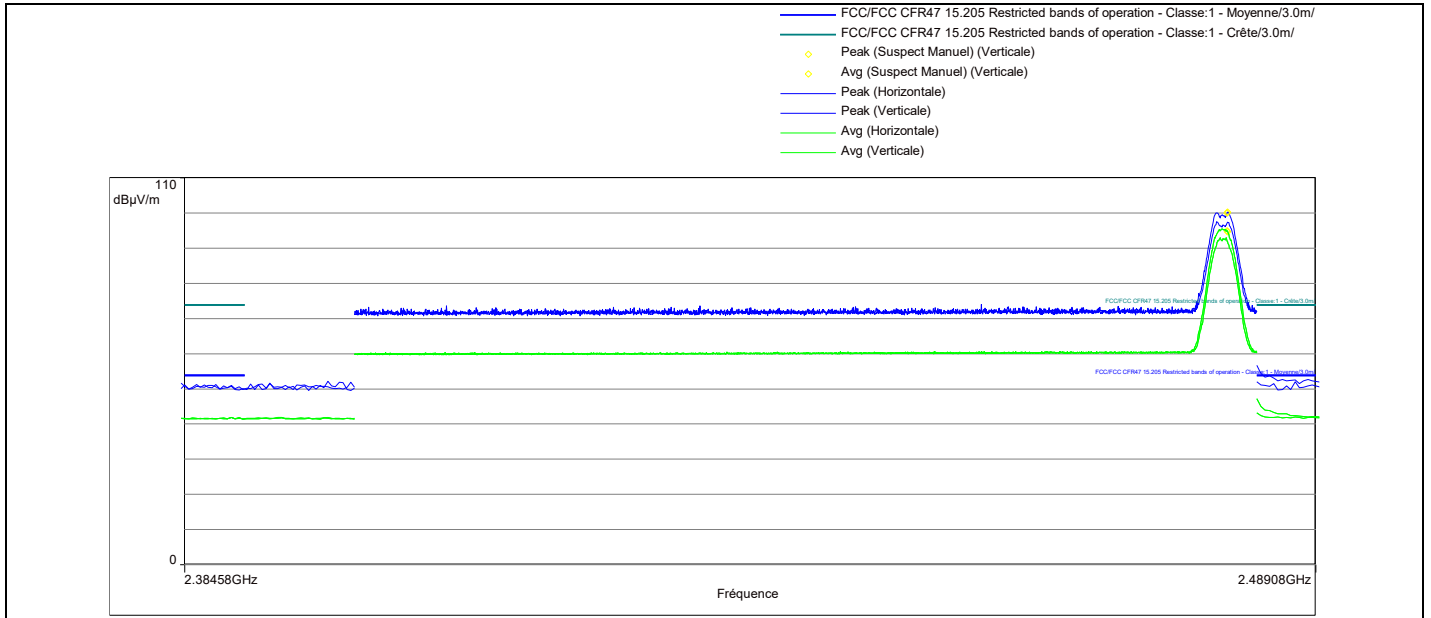

### 7.6.3. Non restricted frequency bands

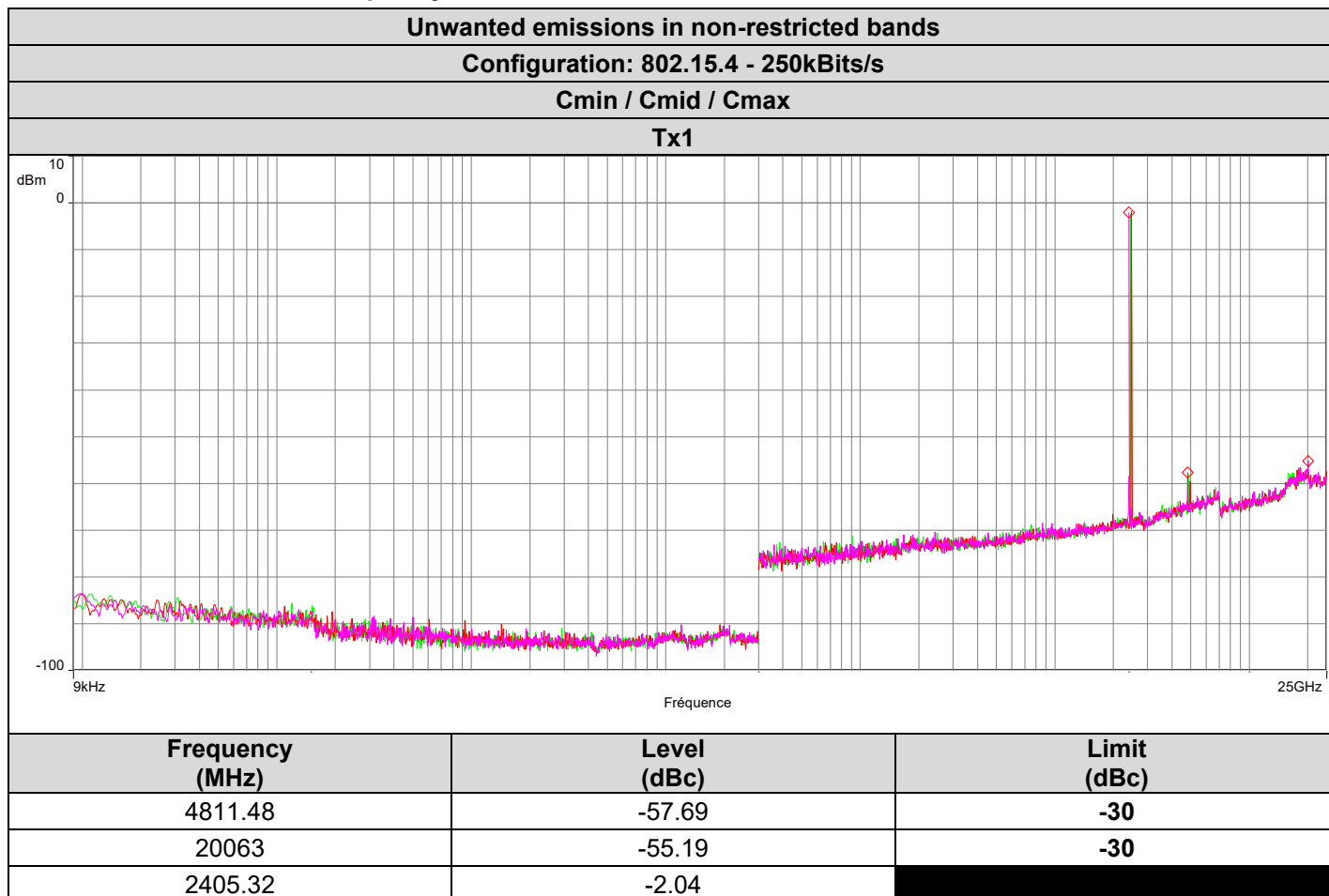

### 7.7. CONCLUSION

Unwanted emissions in non-restricted bands and at the band edge measurement performed on the sample of the product **PLTPPB1253P**, Sn: **SM2418100400101 / SM2418100400115**, in configuration and description presented in this test report, show levels **compliant** to the **47 CFR PART 15.247 & RSS 247** limits.



## 8. UNWANTED EMISSIONS IN RESTRICTED FREQUENCY BANDS

### 8.1. TEST CONDITIONS

Date of test : August 08, 2024  
 Test performed by : Akram HAKKARI  
 Relative humidity (%) : 33  
 Ambient temperature (°C) : 21

### 8.2. TEST SETUP

Test procedure:  
 ANSI C63.10 & FCC Part 15 subpart C

Following frequency ranges, test setup parameters are different and specified in this table:

Frequency range:	9kHz to 30MHz	
Test:	Pre-Characterization	Qualification
Antenna Polarization:	Parallel, Perpendicular and Ground parallel	
Antenna Height:	Centered on EUT (§6.6.5 ANSI C63-10)	1m
Antenna Type:	Loop	
RBW Filter:	200Hz below 150kHz / 9kHz above 150kHz	
Maximization:	Turntable rotation of 360 degrees range and all axis of EUT used in normal configuration	
EUT height:	1.5m	0.8m
Test site:	Full Anechoic Chamber	Open Aera Test Site
Distance EUT - Antenna:	3m	10m
Detector:	Peak	QPeak

Frequency range:	30MHz to 1GHz	
Test:	Pre-Characterization	Qualification
Antenna Polarization:	Horizontal and Vertical	
Antenna Height:	Centered on EUT (§6.6.5 ANSI C63-10)	Varied from 1m to 4m
Antenna Type:	Bi-Log	
RBW Filter:	120kHz	
Maximization:	Turntable rotation of 360 degrees range and all axis of EUT used in normal configuration	
EUT height:	1.5m	0.8m
Test site:	Full Anechoic Chamber	Open Aera Test Site
Distance EUT - Antenna:	3m	10m
Detector:	Peak	QPeak



Frequency range:	1GHz to 14GHz	
Test:	Pre-Characterization	Qualification
Antenna Polarization:	Horizontal and Vertical	
Antenna Height:	Centered on EUT (§6.6.5 ANSI C63-10)	Centered on EUT (§6.6.5 ANSI C63-10)
Antenna Type:	Horn	
RBW Filter:	1MHz	
Maximization:	Turntable rotation of 360 degrees range and all axis of EUT used in normal configuration	
EUT height:	1.5m	1.5m
Test site:	Full Anechoic Chamber	Full Anechoic Chamber
Distance EUT - Antenna:	3m	3m
Detector:	Peak & Average	Peak & Average

Frequency range:	14GHz to 25GHz	
Test:	Pre-Characterization	Qualification
Antenna Polarization:	Horizontal and Vertical	
Antenna Height:	Centered on EUT (§6.6.5 ANSI C63-10)	Centered on EUT (§6.6.5 ANSI C63-10)
Antenna Type:	Horn	
RBW Filter:	1MHz	
Maximization:	Turntable rotation of 360 degrees range and all axis of EUT used in normal configuration	
EUT height:	1.5m	1.5m
Test site:	Full Anechoic Chamber	Full Anechoic Chamber
Distance EUT - Antenna:	1m	1m
Detector:	Peak & Average	Peak & Average



L C I E

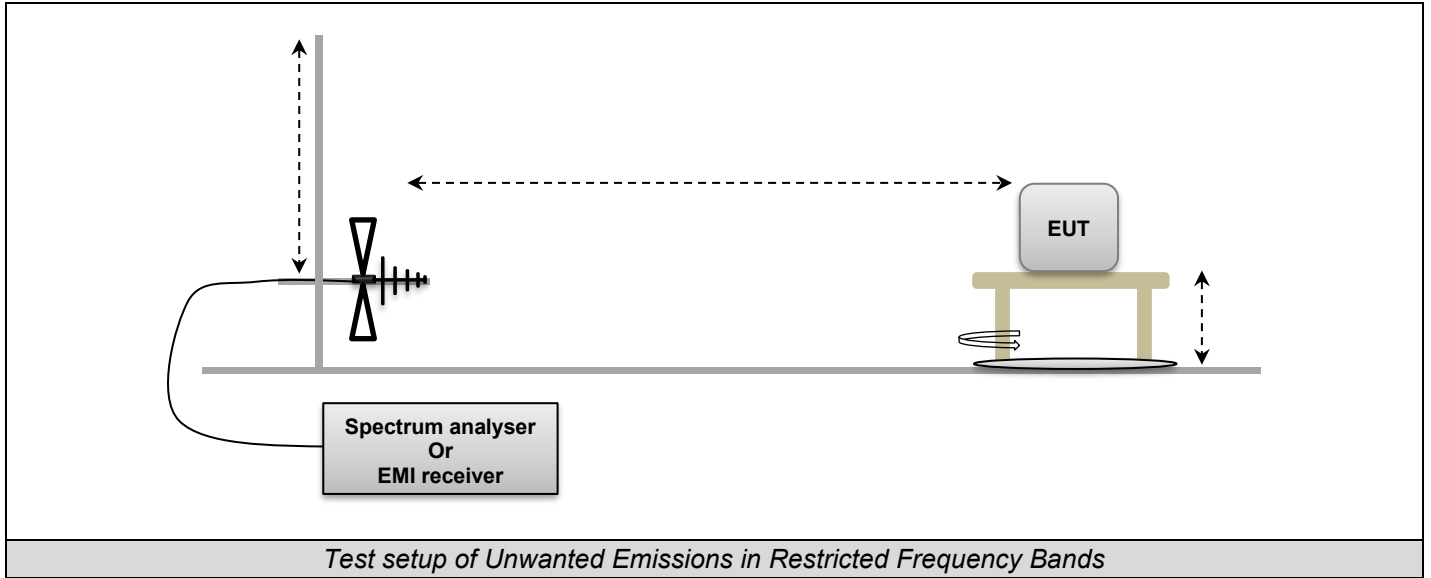

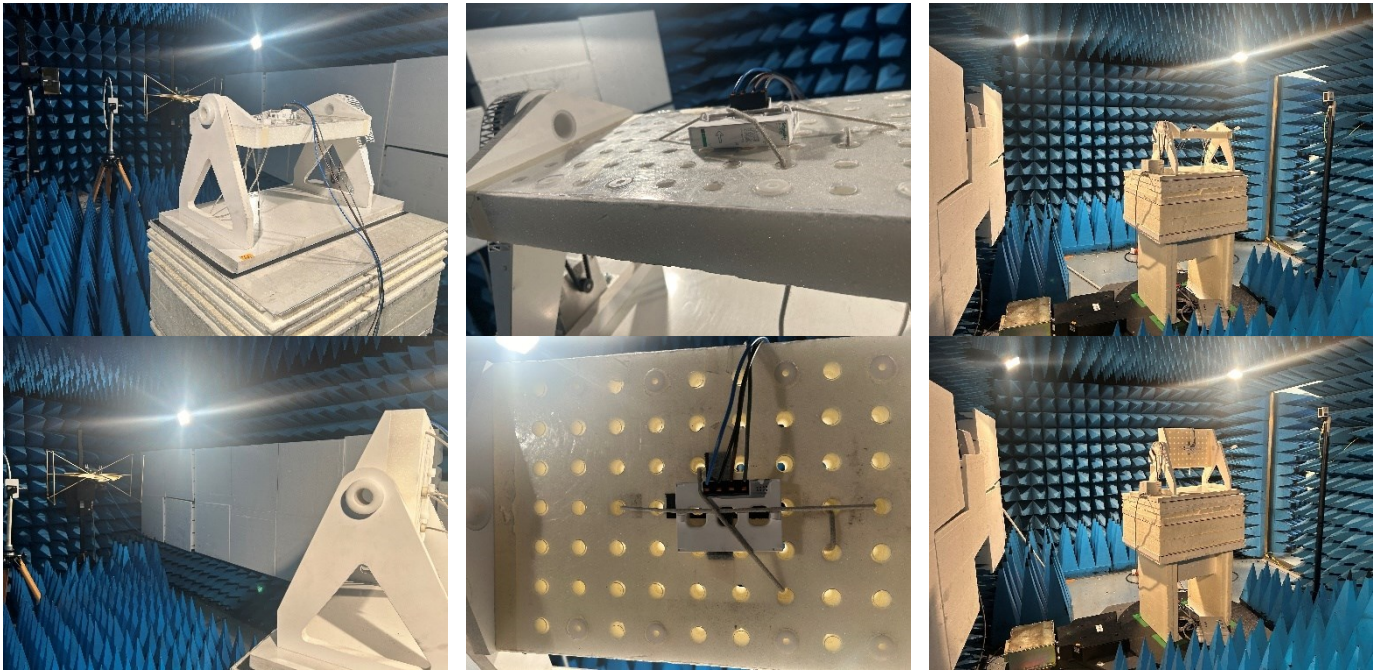

*Photo of Unwanted Emissions in Restricted Frequency Bands*



L C I E



*Photo on OATS*





### 8.3. LIMIT

Measure at 300m		
Frequency range	Level	Detector
9kHz-490kHz	67.6dB $\mu$ V/m /F(kHz)	QPeak
Measure at 30m		
Frequency range	Level	Detector
490kHz-1.705MHz	87.6dB $\mu$ V/m /F(kHz)	QPeak
1.705MHz-30MHz	29.5dB $\mu$ V/m	QPeak
Measure at 10m		
Frequency range	Level	Detector
30MHz to 88MHz	29.5dB $\mu$ V/m	QPeak
88MHz to 216MHz	33dB $\mu$ V/m	QPeak
216MHz to 960MHz	35.5B $\mu$ V/m	QPeak
960MHz to 1000MHz	43.5dB $\mu$ V/m	QPeak
Above 1000MHz	63.5dB $\mu$ V/m	Peak
	43.5dB $\mu$ V/m	Average
Measure at 3m		
Frequency range	Level	Detector
30MHz to 88MHz	40dB $\mu$ V/m	QPeak
88MHz to 216MHz	43.5dB $\mu$ V/m	QPeak
216MHz to 960MHz	46B $\mu$ V/m	QPeak
960MHz to 1000MHz	54dB $\mu$ V/m	QPeak
Above 1000MHz	74dB $\mu$ V/m	Peak
	54dB $\mu$ V/m	Average



#### 8.4. TEST EQUIPMENT LIST

TEST EQUIPMENT USED					
Description	Manufacturer	Model	Identifier	Cal_Date	Cal_Due
Amplifier 10MHz - 18GHz	LCIE SUD EST	_	A7102082	05/22	09/24
Antenna Bi-log	AH System	SAS-521-7	C2040180	05/23	05/25
Antenna horn 18GHz	EMCO	3115	C2042029	03/22	03/25
BAT EMC	NEXIO	v3.21.0.32	L1000115		
CABLE	TELEDYNE	R82-0404-0.5M	A5330010	03/22	03/25
Cable 0.75m	-	18GHz	A5329900	08/24	08/26
Cable SMA 40cm	WITHWAVE	W101-SM1-0.4M	A5329979	10/23	10/26
Comb EMR HF	YORK	CGE01	A3169114		
CONTROLLER	INNCO	CO3000	D3044034		
Emission Cable (SMA 1m)	TELEDYNE	26GHz	A5329874	08/22	08/25
Emission Cable (SMA 3.3m)	TELEDYNE	26GHz	A5329875	08/22	08/25
Filter Matrice	LCIE SUD EST	Combined filters	A7484078	03/23	03/25
Multimeter - CEM	FLUKE	87	A1240251	10/23	10/25
Rehausse Table C3	LCIE	_	F2000511		
Rehausse Table C3	LCIE	_	F2000507		
Semi-Anechoic chamber #3 (BF)	SIEPEL	_	D3044017_BF	04/22	04/25
Semi-Anechoic chamber #3 (VSWR)	SIEPEL	_	D3044017_VSWR	04/22	04/25
Spectrum analyzer	ROHDE & SCHWARZ	FSU 26	A4060058	09/23	09/25
Table C3	LCIE	_	F2000461		
Thermo-hygrometer (PM1/2/3)	KIMO	HQ 210	B4206022	05/23	05/25
TILT	INNCO	TILT	D3044033		
Turntable chamber (Cage#3)	ETS Lingren	Model 2165	F2000371		
Turntable controller (Cage#3)	ETS Lingren	Model 2090	F2000444		

#### 8.5. DIVERGENCE, ADDITION OR SUPPRESSION ON THE TEST SPECIFICATION

None



## 8.6. RESULTS

For all following measurements, worst case is presented with different configurations and modulations of EUT.

### 8.6.1. 9kHz to 30MHz

#### Graphs – Pre characterization:

Graph identifier	Polarization	Mode	Channel	EUT position	Comments
Emr# 1	0°/90°	TX	Single	Axis XY/Z	See the following results
Emr# 2	180°	TX	Single	Axis XY/Z	See the following results



L C I E

**Radiated Emissions**

**Graph name:** Emr#1  
**Frequency range:** 9 kHz to 30 MHz

(0°/90°) - TX mode - Axis 0° (Worst case presented)



**Pre-Characterization:**

Frequency	PK Level (dBµV/m)	Lim.PK (dBµV/m)	Lim.Avg (dBµV/m)	Lim.QP (dBµV/m)	Angle (°)	Polar.	Correct. (dB)
185.819 kHz	53.41	/	/	102.10	326	H	55.04



L C I E

**Radiated Emissions**

**Graph name:** Emr#2  
**Frequency range:** 9 kHz to 30 MHz

(180°) - TX mode - Axis 0° (Worst case presented)

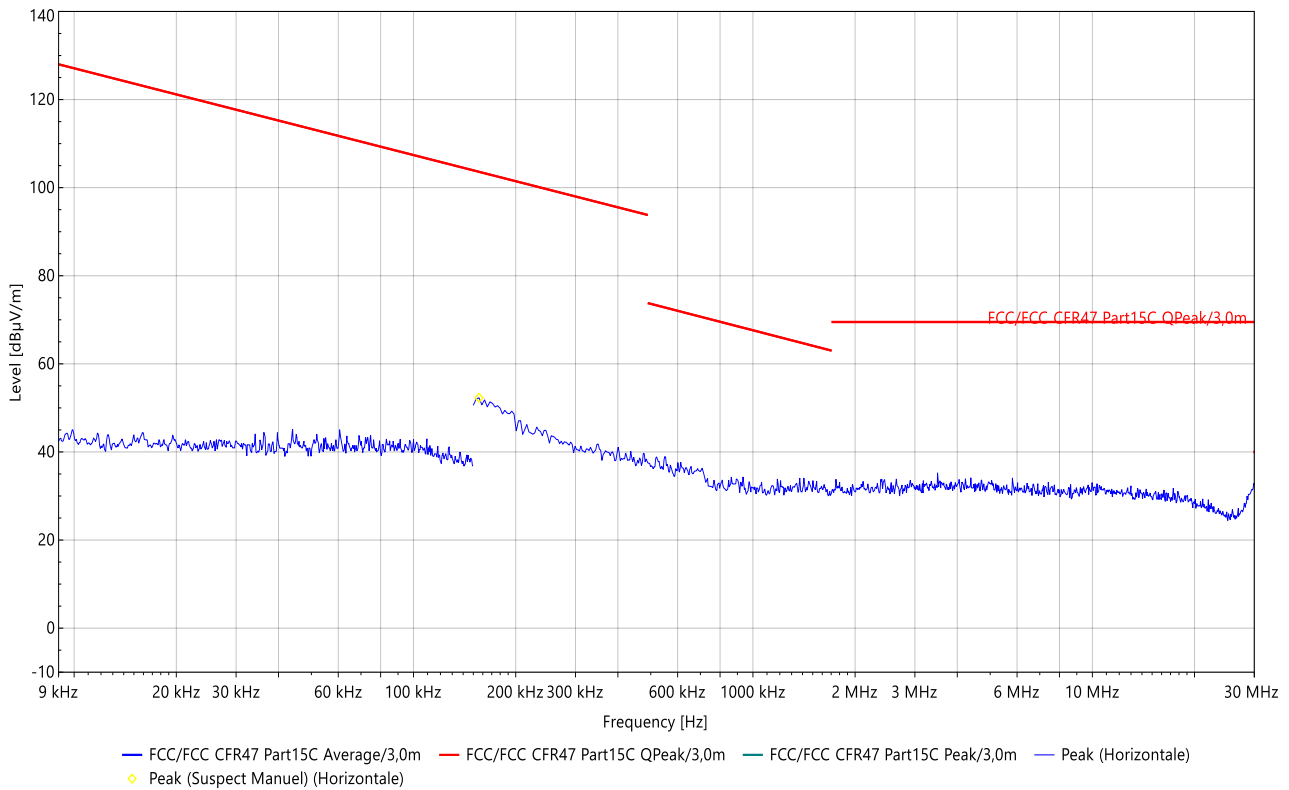

**Pre-Characterization:**

Frequency	PK Level (dBµV/m)	Lim.PK (dBµV/m)	Lim.Avg (dBµV/m)	Lim.QP (dBµV/m)	Angle (°)	Polar.	Correct. (dB)
155.97 kHz	52.29	/	/	103.59	180	H	56.43

### 8.6.2. 30MHz to 1GHz

#### Graphs – Pre characterization:

Graph identifier	Polarization	Mode	Channel	EUT position	Comments
Emr# 3	H/V	TX	Cmin	Axis XY/Z	See the following results
Emr# 4	H/V	TX	Cmid	Axis XY/Z	See the following results
Emr# 5	H/V	TX	Cmax	Axis XY/Z	See the following results

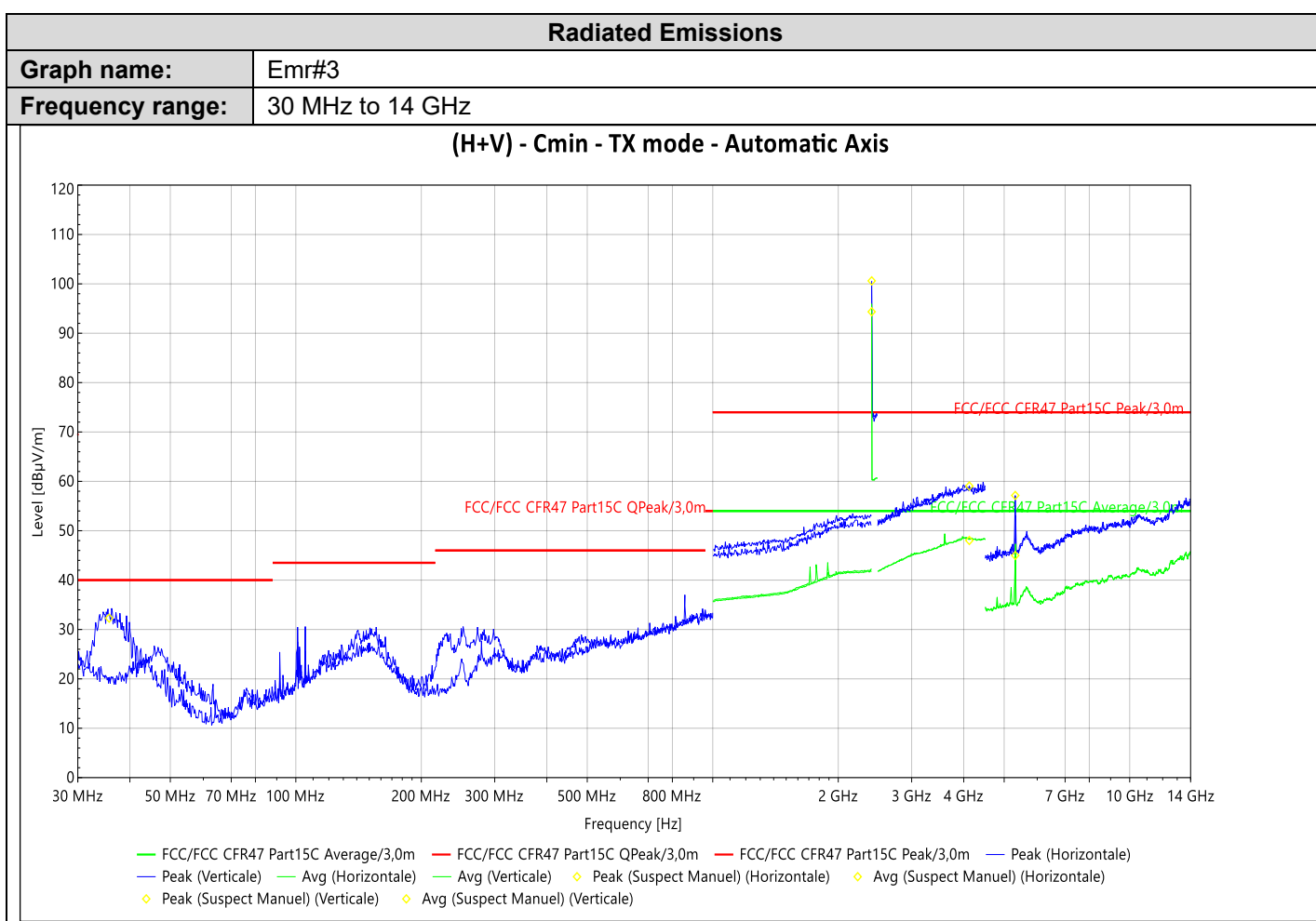

#### Pre-Characterization:

Frequency	PK Level (dBµV/m)	Lim.PK (dBµV/m)	Avg (dBµV/m)	Lim.Avg (dBµV/m)	Lim.QP (dBµV/m)	Angle (°)	Polar.	Correct. (dB)
2.40580325 GHz*	100.61	74.00	94.35	54.00	/	134	H	35.71
4.124527699 GHz	59.05	74.00	48.03	54.00	/	0	H	41.54
5.3151 GHz	57.14	74.00	45.00	54.00	/	313	V	-17.56
35.6745 MHz	32.29	/	/	/	40.00	90	V	18.98

\*Carrier frequency  
 No significant frequency observed



L C I E

### Radiated Emissions

**Graph name:** Emr#4  
**Frequency range:** 30 MHz to 14 GHz

(H+V) - Cmid - TX mode - Automatic Axis

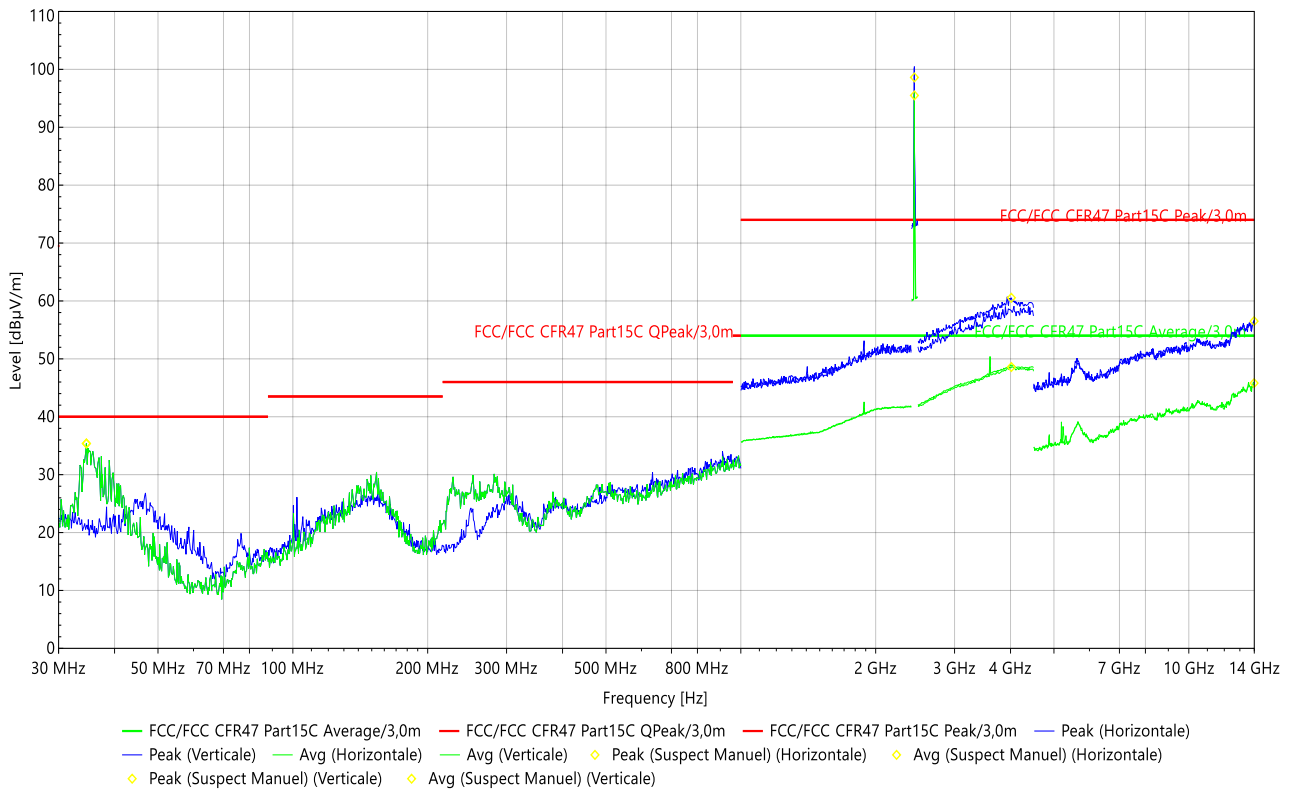

#### Pre-Characterization:

Frequency	PK Level (dBµV/m)	Lim.PK (dBµV/m)	Avg (dBµV/m)	Lim.Avg (dBµV/m)	Lim.QP (dBµV/m)	Angle (°)	Polar.	Correct. (dB)
2.44053925 GHz*	98.61	74.00	95.50	54.00	/	115	H	35.77
4.0168466 GHz	60.55	74.00	48.59	54.00	/	356	H	41.72
13.98575 GHz	56.51	74.00	45.81	54.00	/	347	H	-4.02
34.6075 MHz	35.38	/	/	/	40.00	3	V	19.54

\*Carrier frequency  
 No significant frequency observed



L C I E

**Radiated Emissions**

**Graph name:** Emr#5  
**Frequency range:** 30 MHz to 14 GHz

**(H+V) - Cmax - TX mode - Automatic Axis**

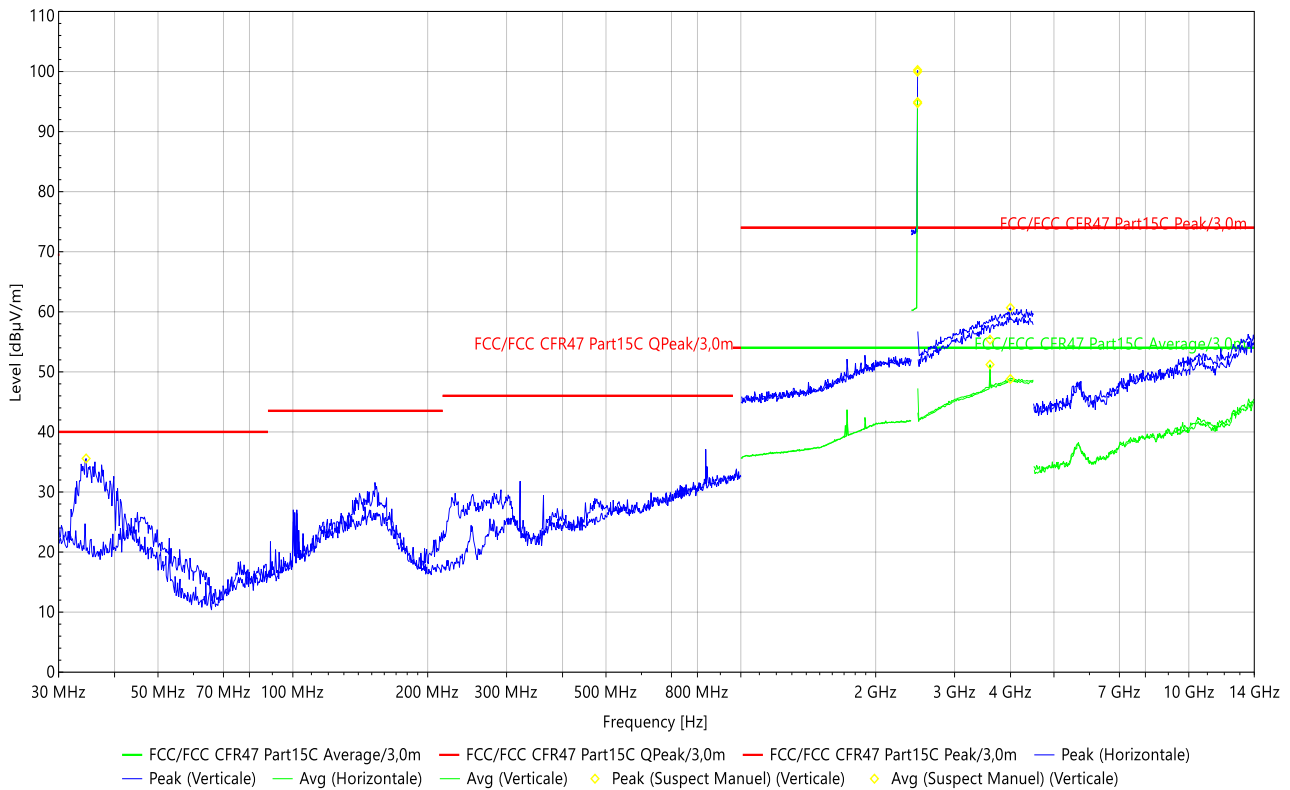

**Pre-Characterization:**

Frequency	PK Level (dBµV/m)	Lim.PK (dBµV/m)	Avg (dBµV/m)	Lim.Avg (dBµV/m)	Lim.QP (dBµV/m)	Angle (°)	Polar.	Correct. (dB)
3.599834399 GHz	55.36	74.00	51.21	54.00	/	259	V	40.39
3.9970849 GHz	60.67	74.00	48.82	54.00	/	95	V	41.71
2.48070275 GHz	99.97	74.00	94.93	54.00	/	115	V	35.77
2.48078625 GHz	100.26	74.00	94.72	54.00	/	115	V	35.77
34.559 MHz	35.58	/	/	/	40.00	0	V	19.57





8.6.3. 1GHz to 25GHz

Graphs – Pre characterization:

Graph identifier	Polarization	Mode	Channel	EUT position	Comments
Emr# 6	H/V	TX	Cmin	Axis XY/Z	See the following results
Emr# 7	H/V	TX	Cmid	Axis XY/Z	See the following results
Emr# 8	H/V	TX	Cmax	Axis XY/Z	See the following results

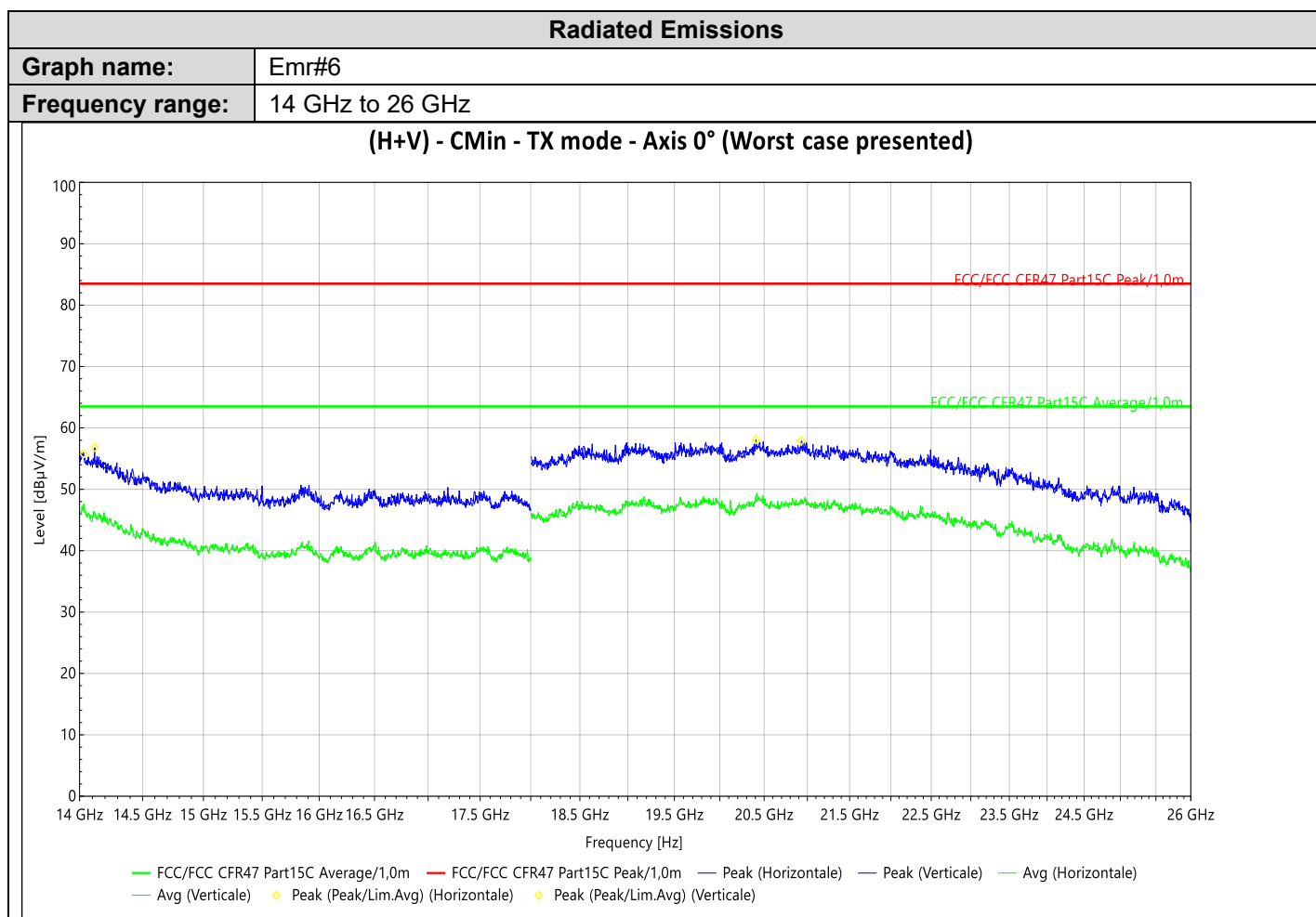

Pre-Characterization:

Frequency	PK Level (dBµV/m)	LimM (dBµV/m)	Peak-LimM (dB)	Angle (°)	Polar.	Tilt (°)	Correct. (dB)
14.000_1195 GHz	56.79	63.50	-6.71	330	H	0.30	2.74
20.000_929 GHz	57.88	63.50	-5.62	154	H	0.30	2.92
14.000_0305 GHz	55.78	63.50	-7.72	48	V	0.30	3.45
20.000_407 GHz	58.11	63.50	-5.39	280	V	0.30	3.64

No significant frequency observed



L C I E

**Radiated Emissions**

**Graph name:** Emr#10  
**Frequency range:** 14 GHz to 26 GHz

**(H+V) - CMid - TX mode - Axis 0° (Worst case presented)**

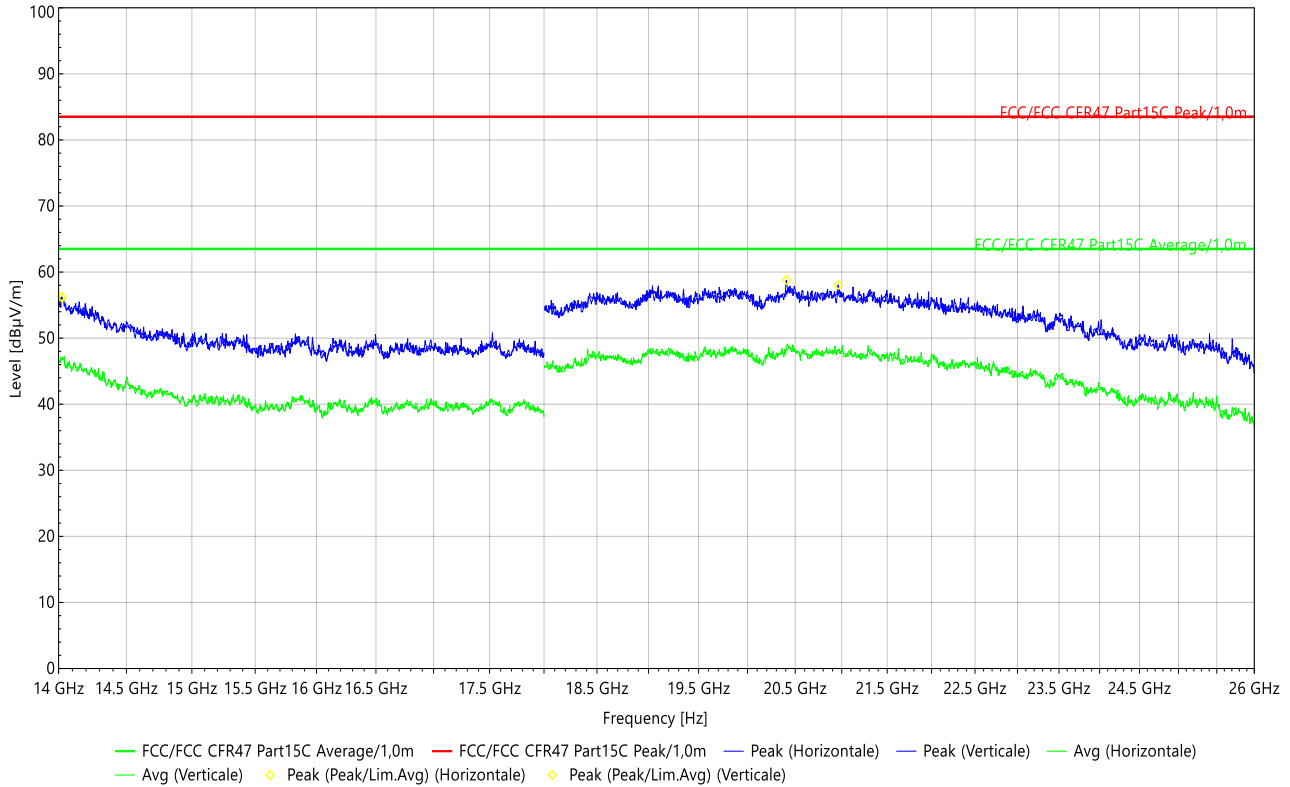

**Pre-Characterization:**

Frequency	PK Level (dBµV/m)	LimM (dBµV/m)	Peak-LimM (dB)	Angle (°)	Polar.	Tilt (°)	Correct. (dB)
14.000_0255 GHz	56.10	63.50	-7.40	95	H	0.30	3.48
20.000_962 GHz	58.07	63.50	-5.43	228	H	0.30	3.02
14.000_0205 GHz	56.26	63.50	-7.24	173	V	0.30	3.51
20.000_409 GHz	58.80	63.50	-4.70	0	V	0.30	3.64

No significant frequency observed

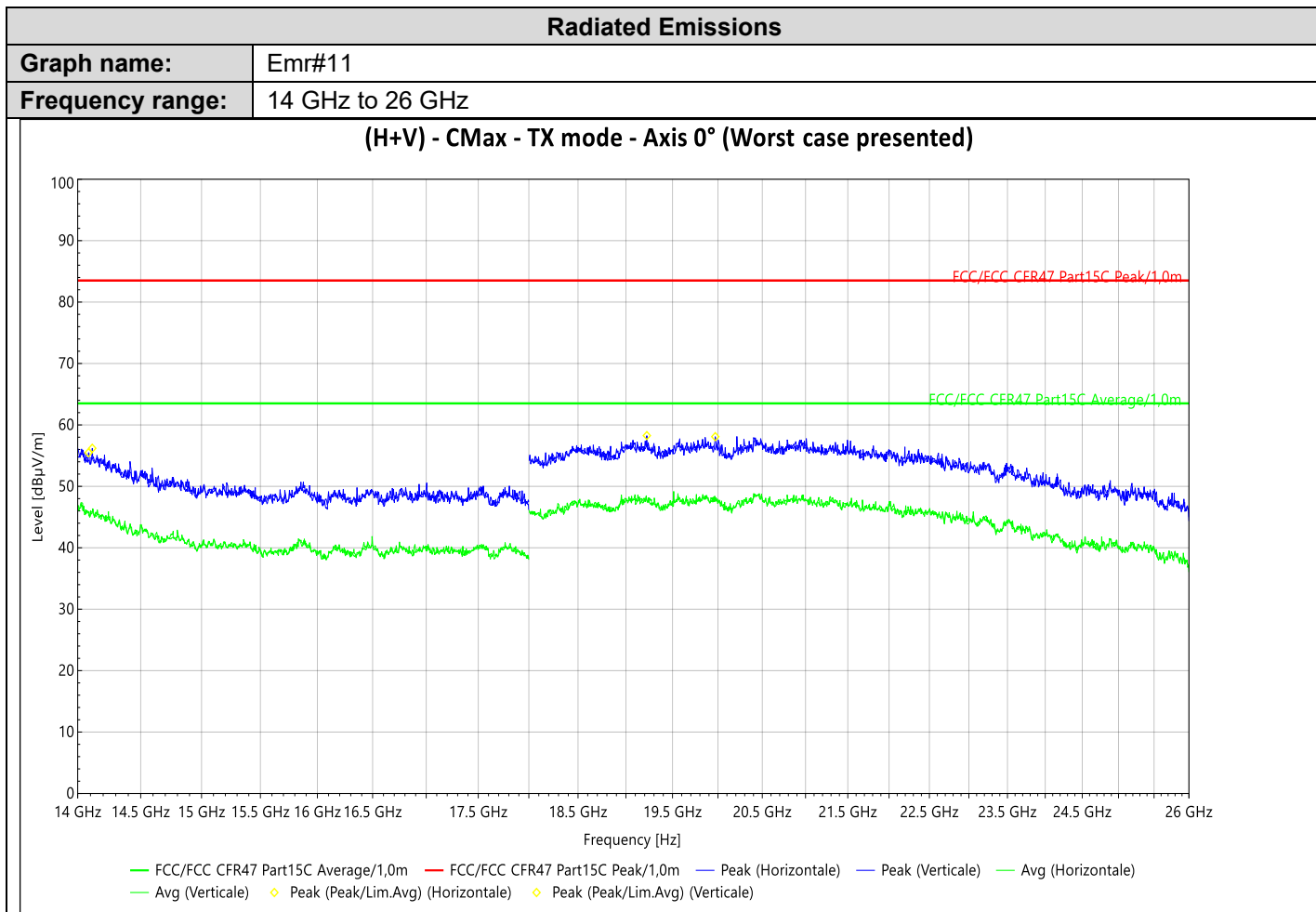

**Pre-Characterization:**

Frequency	PK Level (dBµV/m)	LimM (dBµV/m)	Peak-LimM (dB)	Angle (°)	Polar.	Tilt (°)	Correct. (dB)
14.000 ,114 GHz	56.20	63.50	-7.30	224	H	0.30	2.81
19.000 ,223 GHz	58.26	63.50	-5.24	23	H	0.30	3.32
14.000 ,0845 GHz	55.47	63.50	-8.03	210	V	0.30	3.08
19.000 ,97 GHz	58.09	63.50	-5.41	268	V	0.30	3.00

No significant frequency observed

**8.7. CONCLUSION**

Unwanted emissions in non-restricted bands measurement performed on the sample of the product **PLTPPB1253P**, Sn: **SM2418100400101 / SM2418100400115**, in configuration and description presented in this test report, show levels compliant to the **47 CFR PART 15.247 & RSS 247** limits.



## 9. UNCERTAINTIES CHART

<i>Kind of measurement</i>	<i>Wide uncertainty laboratory</i>
Occupied Channel Bandwidth	±2.8 %
Humidity	±3.2 %
Power Spectral Density, Conducted	±1.7 dB
Radio frequency	±0.3 ppm
RF power, conducted	±1.2 dB
RF power, radiated (Full anechoic chamber above 1GHz)	±3.7 dB
RF power, radiated (Semi anechoic chamber & open test site)	±5.6 dB
Spurious emission, conducted	±2.3 dB
Spurious emission, radiated (Full anechoic chamber above 1GHz)	±3.8 dB
Spurious emission, radiated (Semi anechoic chamber & open test site)	±5.7 dB
Temperature	±0.75 °C
Time	±2.3 %
Voltage	±1.7 %

The uncertainty values calculated by the laboratory are lower than limit uncertainty values defined by the standard. The conformity of the sample is directly established by the applicable limit values. This table includes all uncertainties maximum feasible for testing in the laboratory, whether or not made in this report.