



Shenzhen Global Test Service Co.,Ltd.

No.7-101 and 8A-104, Building 7 and 8, DCC Cultural and Creative Garden, No.98, Pingxin North Road, Shangmugu Community, Pinghu Street, Longgang District, Shenzhen, Guangdong

FCC PART 15 SUBPART C TEST REPORT

FCC PART 15.247

Report Reference No. : **GTS20190918014-1-1**

FCC ID. : **2AH68-PIVOT3SAT**

Compiled by

(position+printed name+signature) . : File administrators Tracy Hu

Supervised by

(position+printed name+signature) . : Test Engineer Moon

Approved by

(position+printed name+signature) . : Manager Simon Hu

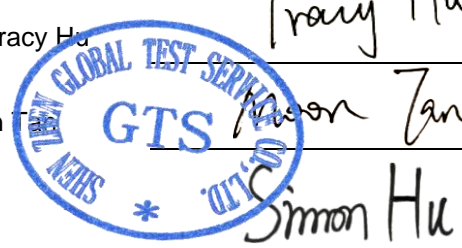

Date of issue : Dec. 26, 2019

Representative Laboratory Name.: **Shenzhen Global Test Service Co.,Ltd.**

Address : No.7-101 and 8A-104, Building 7 and 8, DCC Cultural and Creative Garden, No.98, Pingxin North Road, Shangmugu Community, Pinghu Street, Longgang District, Shenzhen, Guangdong

Applicant's name : **TuringSense, Inc**

Address : 4675 Stevens Creek Blvd,Santa Clara, CA 95051

Test specification..... :

Standard..... : **FCC Part 15.247**

TRF Originator : Shenzhen Global Test Service Co.,Ltd.

Master TRF : Dated 2014-12

Shenzhen Global Test Service Co.,Ltd. All rights reserved.

This publication may be reproduced in whole or in part for non-commercial purposes as long as the Shenzhen Global Test Service Co.,Ltd. is acknowledged as copyright owner and source of the material. Shenzhen Global Test Service Co.,Ltd. takes no responsibility for and will not assume liability for damages resulting from the reader's interpretation of the reproduced material due to its placement and context.

Test item description..... : **Pivot Yoga**

Trade Mark..... : /

Manufacturer : **Sceiba Intelligent Fashin Co Ltd.**

Model/Type reference : PIVOT Yoga Pant1.0" for the pants

Listed Models : N/A

Modulation Type..... : GFSK

Operation Frequency : From 2402MHz to 2480MHz

Hardware Version : 2.0

Software Version : FW 9.12.22.94.42.1

Rating..... : DC 3.7V from battery
Recharged by DC 5V

Result : **PASS**

TEST REPORT

| | | |
|--------------------------|---------------------------|---------------|
| Test Report No. : | GTS20190918014-1-1 | Dec. 26, 2019 |
| | | Date of issue |

Equipment under Test : Pivot Yoga

Model /Type : PIVOT Yoga Pant1.0" for the pants

Listed Models : N/A

Applicant : **TuringSense, Inc**

Address : 4675 Stevens Creek Blvd,Santa Clara, CA 95051

Manufacturer : **Sceiba Inteligent Fashin Co Ltd.**

Address : A301, DongXin Science & Technology Park, 2nd St. ChenWu
Village, Houjie Town , Donguan, China

| | |
|---------------------|-------------|
| Test Result: | PASS |
|---------------------|-------------|

The test report merely corresponds to the test sample.

It is not permitted to copy extracts of these test result without the written permission of the test laboratory.

Contents

| | |
|--|-----------|
| 1. TEST STANDARDS | 4 |
| 2. SUMMARY | 5 |
| 2.1. General Remarks | 5 |
| 2.2. Product Description | 5 |
| 2.3. Equipment Under Test | 5 |
| 2.4. Short description of the Equipment under Test (EUT) | 5 |
| 2.5. EUT operation mode | 5 |
| 2.6. Block Diagram of Test Setup | 6 |
| 2.7. Special Accessories | 6 |
| 2.8. Related Submittal(s) / Grant (s) | 6 |
| 2.9. Modifications | 6 |
| 3. TEST ENVIRONMENT | 7 |
| 3.1. Address of the test laboratory | 7 |
| 3.2. Test Facility | 7 |
| 3.3. Environmental conditions | 7 |
| 3.4. Test Description | 8 |
| 3.5. Statement of the measurement uncertainty | 8 |
| 3.6. Equipments Used during the Test..... | 9 |
| 4. TEST CONDITIONS AND RESULTS | 10 |
| 4.1. AC Power Conducted Emission | 10 |
| 4.2. Radiated Emission | 12 |
| 4.3. Maximum Peak Output Power | 16 |
| 4.4. Power Spectral Density | 18 |
| 4.5. 6dB Bandwidth | 21 |
| 4.6. Band Edge Compliance of RF Emission | 24 |
| 4.7. Antenna Requirement | 28 |
| 5. TEST SETUP PHOTOS OF THE EUT | 29 |
| 6. EXTERNAL AND INTERNAL PHOTOS OF THE EUT | 30 |

1. TEST STANDARDS

The tests were performed according to following standards:

[FCC Rules Part 15.247](#): Frequency Hopping, Direct Spread Spectrum and Hybrid Systems that are in operation within the bands of 902-928 MHz, 2400-2483.5 MHz, and 5725-5850 MHz.

[ANSI C63.10-2013](#): American National Standard for Testing Unlicensed Wireless Devices

[KDB558074 D01 DTS Meas Guidance v05](#): Guidance for Performing Compliance Measurements on Digital Transmission Systems (DTS) Operating Under §15.247.

2. SUMMARY

2.1. General Remarks

| | | |
|--------------------------------|---|---------------|
| Date of receipt of test sample | : | Sep. 27, 2019 |
| Testing commenced on | : | Oct. 17, 2019 |
| Testing concluded on | : | Dec. 26, 2019 |

2.2. Product Description

| | |
|-----------------------|--|
| Product Name: | Pivot Yoga |
| Trade Mark: | / |
| Model/Type reference: | PIVOT Yoga Pant1.0" for the pants |
| Antenna Type | Internal Antenna |
| Power supply: | DC 3.7V from battery Recharged by DC 5V |
| Adapter information: | N/A |
| ESB | |
| Modulation Type | GFSK |
| Operation frequency | 2402-2480MHz |
| Antenna gain | 2.11dBi Max |

2.3. Equipment Under Test

Power supply system utilised

| | | | |
|----------------------|---|---|-----------------------------------|
| Power supply voltage | : | <input type="radio"/> 230V / 50 Hz | <input type="radio"/> 120V / 60Hz |
| | | <input type="radio"/> 12 V DC | <input type="radio"/> 24 V DC |
| | | <input checked="" type="radio"/> Other (specified in blank below) | |

DC 3.7V from battery

2.4. Short description of the Equipment under Test (EUT)

This is a Pivot Yoga.

2.5. EUT operation mode

The Applicant provides communication tools software to control the EUT for staying in continuous transmitting (Duty Cycle more than 98%) and receiving mode for testing .There are 40 channels provided to the EUT.

Channel 02/40/80 was selected to test.

| Channel | Frequency(MHz) | Channel | Frequency(MHz) |
|---------|----------------|---------|----------------|
| 02 | 2402 | 42 | 2442 |
| 03 | 2403 | 43 | 2443 |
| 04 | 2404 | 44 | 2444 |
| 05 | 2405 | 45 | 2445 |
| 06 | 2406 | 46 | 2446 |
| 07 | 2407 | 47 | 2447 |
| 08 | 2408 | 48 | 2448 |
| 09 | 2409 | 49 | 2449 |
| 10 | 2410 | 50 | 2450 |
| 11 | 2411 | 51 | 2451 |

| | | | |
|-----------|------|-----------|------|
| 12 | 2412 | 52 | 2452 |
| 13 | 2413 | 53 | 2453 |
| 14 | 2414 | 54 | 2454 |
| 15 | 2415 | 55 | 2455 |
| 16 | 2416 | 56 | 2456 |
| 17 | 2417 | 57 | 2457 |
| 18 | 2418 | 58 | 2458 |
| 19 | 2419 | 59 | 2459 |
| 20 | 2420 | 60 | 2460 |
| 21 | 2421 | 61 | 2461 |
| 22 | 2422 | 62 | 2462 |
| 23 | 2423 | 63 | 2463 |
| 24 | 2424 | 64 | 2464 |
| 25 | 2425 | 65 | 2465 |
| 26 | 2426 | 66 | 2466 |
| 27 | 2427 | 67 | 2467 |
| 28 | 2428 | 68 | 2468 |
| 29 | 2429 | 69 | 2469 |
| 30 | 2430 | 70 | 2470 |
| 31 | 2431 | 71 | 2471 |
| 32 | 2432 | 72 | 2472 |
| 33 | 2433 | 73 | 2473 |
| 34 | 2434 | 74 | 2474 |
| 35 | 2435 | 75 | 2475 |
| 36 | 2436 | 76 | 2476 |
| 37 | 2437 | 77 | 2477 |
| 38 | 2438 | 78 | 2478 |
| 39 | 2439 | 79 | 2479 |
| 40 | 2440 | 80 | 2480 |
| 41 | 2441 | | |

2.6. Block Diagram of Test Setup

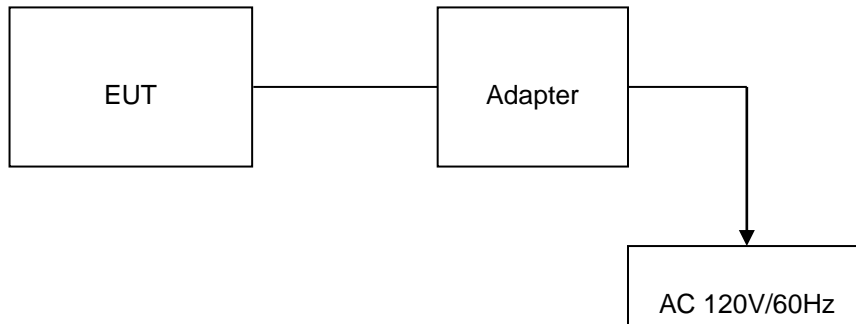

2.7. Special Accessories

| Manufacturer | Description | Model | Serial Number | Certificate |
|--------------|-------------|-------|---------------|-------------|
| | | | | |

2.8. Related Submittal(s) / Grant (s)

This submittal(s) (test report) is intended for **FCC ID: 2AH68-PIVOT3SAT** filing to comply with Section 15.247 of the FCC Part 15, Subpart C Rules.

2.9. Modifications

No modifications were implemented to meet testing criteria.

3. TEST ENVIRONMENT

3.1. Address of the test laboratory

Shenzhen Global Test Service Co.,Ltd.

No.7-101 and 8A-104, Building 7 and 8, DCC Cultural and Creative Garden, No.98, Pingxin North Road, Shangmugu Community, Pinghu Street, Longgang District, Shenzhen, Guangdong

3.2. Test Facility

The test facility is recognized, certified, or accredited by the following organizations:

CNAS (No. CNAS L8169)

Shenzhen Global Test Service Co., Ltd. has been assessed and proved to be in compliance with CNAS-CL01 Accreditation Criteria for Testing and Calibration Laboratories (identical to ISO/IEC 17025: 2019 General Requirements) for the Competence of Testing and Calibration Laboratories.

A2LA (Certificate No. 4758.01)

Shenzhen Global Test Service Co., Ltd. has been assessed by the American Association for Laboratory Accreditation (A2LA). Certificate No. 4758.01.

3.3. Environmental conditions

During the measurement the environmental conditions were within the listed ranges:

| | |
|-----------------------|--------------|
| Temperature: | 15-35 ° C |
| | |
| Humidity: | 30-60 % |
| | |
| Atmospheric pressure: | 950-1050mbar |

3.4. Test Description

| Test Specification clause | Test case | Test Mode | Test Channel | Recorded In Report | | Pass | Fail | NA | NP | Remark |
|---------------------------|---|-----------|---|--------------------|---|---|--------------------------|--------------------------|--------------------------|----------|
| §15.247(b)(4) | Antenna gain | GFSK | <input checked="" type="checkbox"/> Lowest <input checked="" type="checkbox"/> Middle <input checked="" type="checkbox"/> Highest | GFSK | <input checked="" type="checkbox"/> Lowest <input checked="" type="checkbox"/> Middle <input checked="" type="checkbox"/> Highest | <input checked="" type="checkbox"/> | <input type="checkbox"/> | <input type="checkbox"/> | <input type="checkbox"/> | complies |
| §15.247(e) | Power spectral density | GFSK | <input checked="" type="checkbox"/> Lowest <input checked="" type="checkbox"/> Middle <input checked="" type="checkbox"/> Highest | GFSK | <input checked="" type="checkbox"/> Lowest <input checked="" type="checkbox"/> Middle <input checked="" type="checkbox"/> Highest | <input checked="" type="checkbox"/> | <input type="checkbox"/> | <input type="checkbox"/> | <input type="checkbox"/> | complies |
| §15.247(a)(2) | Spectrum bandwidth – 6 dB bandwidth | GFSK | <input checked="" type="checkbox"/> Lowest <input checked="" type="checkbox"/> Middle <input checked="" type="checkbox"/> Highest | GFSK | <input checked="" type="checkbox"/> Lowest <input checked="" type="checkbox"/> Middle <input checked="" type="checkbox"/> Highest | <input checked="" type="checkbox"/> <input checked="" type="checkbox"/> | <input type="checkbox"/> | <input type="checkbox"/> | <input type="checkbox"/> | complies |
| §15.247(b)(1) | Maximum output power | GFSK | <input checked="" type="checkbox"/> Lowest <input checked="" type="checkbox"/> Middle <input checked="" type="checkbox"/> Highest | GFSK | <input checked="" type="checkbox"/> Lowest <input checked="" type="checkbox"/> Middle <input checked="" type="checkbox"/> Highest | <input checked="" type="checkbox"/> <input checked="" type="checkbox"/> <input checked="" type="checkbox"/> | <input type="checkbox"/> | <input type="checkbox"/> | <input type="checkbox"/> | complies |
| §15.247(d) | Band edge compliance conducted | GFSK | <input checked="" type="checkbox"/> Lowest <input checked="" type="checkbox"/> Highest | GFSK | <input checked="" type="checkbox"/> Lowest <input checked="" type="checkbox"/> Highest | <input checked="" type="checkbox"/> <input checked="" type="checkbox"/> | <input type="checkbox"/> | <input type="checkbox"/> | <input type="checkbox"/> | complies |
| §15.205 | Band edge compliance radiated | GFSK | <input checked="" type="checkbox"/> Lowest <input checked="" type="checkbox"/> Highest | GFSK | <input checked="" type="checkbox"/> Lowest <input checked="" type="checkbox"/> Highest | <input checked="" type="checkbox"/> | <input type="checkbox"/> | <input type="checkbox"/> | <input type="checkbox"/> | complies |
| §15.247(d) | TX spurious emissions conducted | GFSK | <input checked="" type="checkbox"/> Lowest <input checked="" type="checkbox"/> Middle <input checked="" type="checkbox"/> Highest | GFSK | <input checked="" type="checkbox"/> Lowest <input checked="" type="checkbox"/> Middle <input checked="" type="checkbox"/> Highest | <input checked="" type="checkbox"/> <input checked="" type="checkbox"/> | <input type="checkbox"/> | <input type="checkbox"/> | <input type="checkbox"/> | complies |
| §15.247(d) | TX spurious emissions radiated | GFSK | <input checked="" type="checkbox"/> Lowest <input checked="" type="checkbox"/> Middle <input checked="" type="checkbox"/> Highest | GFSK | <input checked="" type="checkbox"/> Lowest <input checked="" type="checkbox"/> Middle <input checked="" type="checkbox"/> Highest | <input checked="" type="checkbox"/> | <input type="checkbox"/> | <input type="checkbox"/> | <input type="checkbox"/> | complies |
| §15.109 | RX spurious emissions radiated | -/- | -/- | -/- | -/- | <input checked="" type="checkbox"/> | <input type="checkbox"/> | <input type="checkbox"/> | <input type="checkbox"/> | complies |
| §15.209(a) | TX spurious Emissions radiated < 30 MHz | GFSK | -/- | GFSK | -/- | <input checked="" type="checkbox"/> | <input type="checkbox"/> | <input type="checkbox"/> | <input type="checkbox"/> | complies |
| §15.107(a) §15.207 | Conducted Emissions < 30 MHz | GFSK | -/- | GFSK | -/- | <input checked="" type="checkbox"/> | <input type="checkbox"/> | <input type="checkbox"/> | <input type="checkbox"/> | complies |

Remark:

1. The measurement uncertainty is not included in the test result.
2. NA = Not Applicable; NP = Not Performed

3.5. Statement of the measurement uncertainty

The data and results referenced in this document are true and accurate. The reader is cautioned that there may be errors within the calibration limits of the equipment and facilities. The measurement uncertainty was calculated for all measurements listed in this test report acc. to CISPR 16 - 4 „Specification for radio disturbance and immunity measuring apparatus and methods – Part 4: Uncertainty in EMC Measurements“ and is documented in the Shenzhen Global Test Service Co.,Ltd. quality system acc. to DIN EN ISO/IEC 17025. Furthermore, component and process variability of devices similar to that tested may result in additional deviation. The manufacturer has the sole responsibility of continued compliance of the device.

Hereafter the best measurement capability for Shenzhen GTS laboratory is reported:

| Test | Range | Measurement Uncertainty | Notes |
|-----------------------|------------|-------------------------|-------|
| Radiated Emission | 30~1000MHz | 4.10 dB | (1) |
| Radiated Emission | 1~18GHz | 4.32 dB | (1) |
| Radiated Emission | 18-40GHz | 5.54 dB | (1) |
| Conducted Disturbance | 0.15~30MHz | 3.12 dB | (1) |

- (1) This uncertainty represents an expanded uncertainty expressed at approximately the 95% confidence level using a coverage factor of k=2.

3.6. Equipments Used during the Test

| Test Equipment | Manufacturer | Model No. | Serial No. | Calibration Date | Calibration Due Date |
|----------------------------|-----------------------------------|-----------------------|-----------------|------------------|----------------------|
| LISN | R&S | ENV216 | 3560.6550.08 | 2019/09/20 | 2020/09/19 |
| LISN | R&S | ESH2-Z5 | 893606/008 | 2019/09/20 | 2020/09/19 |
| EMI Test Receiver | R&S | ESPI3 | 101841-cd | 2019/09/20 | 2020/09/19 |
| EMI Test Receiver | R&S | ESCI7 | 101102 | 2019/09/20 | 2020/09/19 |
| Spectrum Analyzer | Agilent | N9020A | MY48010425 | 2019/09/20 | 2020/09/19 |
| Spectrum Analyzer | R&S | FSV40 | 100019 | 2019/09/20 | 2020/09/19 |
| Vector Signal generator | Agilent | N5181A | MY49060502 | 2019/09/20 | 2020/09/19 |
| Signal generator | Agilent | E4421B | 3610AO1069 | 2019/09/20 | 2020/09/19 |
| Climate Chamber | ESPEC | EL-10KA | A20120523 | 2019/09/20 | 2020/09/19 |
| Controller | EM Electronics | Controller EM 1000 | N/A | N/A | N/A |
| Horn Antenna | Schwarzbeck | BBHA 9120D | 01622 | 2019/09/23 | 2020/09/22 |
| Active Loop Antenna | Beijing Da Ze Technology Co.,Ltd. | ZN30900C | 15006 | 2019/10/12 | 2020/10/11 |
| Bilog Antenna | Schwarzbeck | VULB9163 | 000976 | 2019/05/26 | 2020/05/25 |
| Broadband Horn Antenna | SCHWARZBECK | BBHA 9170 | 791 | 2019/09/20 | 2020/09/19 |
| Amplifier | Schwarzbeck | BBV 9743 | #202 | 2019/09/20 | 2020/09/19 |
| Amplifier | Schwarzbeck | BBV9179 | 9719-025 | 2019/09/20 | 2020/09/19 |
| Amplifier | EMCI | EMC051845B | 980355 | 2019/09/20 | 2020/09/19 |
| Temperature/Humidity Meter | Gangxing | CTH-608 | 02 | 2019/09/20 | 2020/09/19 |
| High-Pass Filter | K&L | 9SH10-2700/X12750-O/O | KL142031 | 2019/09/20 | 2020/09/19 |
| High-Pass Filter | K&L | 41H10-1375/U12750-O/O | KL142032 | 2019/09/20 | 2020/09/19 |
| RF Cable(below 1GHz) | HUBER+SUHNER | RG214 | RE01 | 2019/09/20 | 2020/09/19 |
| RF Cable(above 1GHz) | HUBER+SUHNER | RG214 | RE02 | 2019/09/20 | 2020/09/19 |
| Data acquisition card | Agilent | U2531A | TW53323507 | 2019/09/20 | 2020/09/19 |
| Power Sensor | Agilent | U2021XA | MY5365004 | 2019/09/20 | 2020/09/19 |
| Test Control Unit | Tonscend | JS0806-1 | 178060067 | 2019/06/20 | 2020/06/19 |
| Automated filter bank | Tonscend | JS0806-F | 19F8060177 | 2019/06/20 | 2020/06/19 |
| EMI Test Software | Tonscend | JS1120-1 | Ver 2.6.8.0518 | / | / |
| EMI Test Software | Tonscend | JS1120-3 | Ver 2.5.77.0418 | / | / |
| EMI Test Software | Tonscend | JS32-CE | Ver 2.5 | / | / |
| EMI Test Software | Tonscend | JS32-RE | Ver 2.5.1.8 | / | / |

Note: 1. The Cal.Interval was one year.

4. TEST CONDITIONS AND RESULTS

4.1. AC Power Conducted Emission

TEST CONFIGURATION

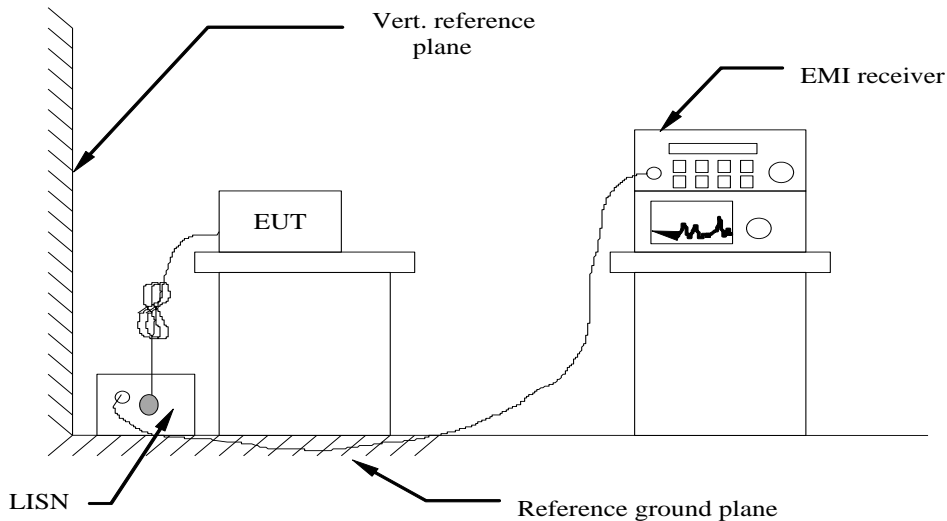

TEST PROCEDURE

- 1 The equipment was set up as per the test configuration to simulate typical actual usage per the user's manual. The EUT is a tabletop system, a wooden table with a height of 0.8 meters is used and is placed on the ground plane as per ANSI C63.10-2013.
- 2 Support equipment, if needed, was placed as per ANSI C63.10-2013
- 3 All I/O cables were positioned to simulate typical actual usage as per ANSI C63.10-2013
- 4 The EUT received DC5V power, the adapter received AC120V/60Hz power through a Line Impedance Stabilization Network (LISN) which supplied power source and was grounded to the ground plane.
- 5 All support equipments received AC power from a second LISN, if any.
- 6 The EUT test program was started. Emissions were measured on each current carrying line of the EUT using a spectrum Analyzer / Receiver connected to the LISN powering the EUT. The LISN has two monitoring points: Line 1 (Hot Side) and Line 2 (Neutral Side). Two scans were taken: one with Line 1 connected to Analyzer / Receiver and Line 2 connected to a 50 ohm load; the second scan had Line 1 connected to a 50 ohm load and Line 2 connected to the Analyzer / Receiver.
- 7 Analyzer / Receiver scanned from 150 KHz to 30MHz for emissions in each of the test modes.
- 8 During the above scans, the emissions were maximized by cable manipulation.

AC Power Conducted Emission Limit

For intentional device, according to § 15.207(a) AC Power Conducted Emission Limits is as following :

| Frequency range (MHz) | Limit (dBuV) | |
|-----------------------|--------------|-----------|
| | Quasi-peak | Average |
| 0.15-0.5 | 66 to 56* | 56 to 46* |
| 0.5-5 | 56 | 46 |
| 5-30 | 60 | 50 |

* Decreases with the logarithm of the frequency.

TEST RESULTS

| | | | |
|---------------|--------------|--------------|---|
| Power supply: | AC 120V/60Hz | Polarization | L |
|---------------|--------------|--------------|---|

Test Graph

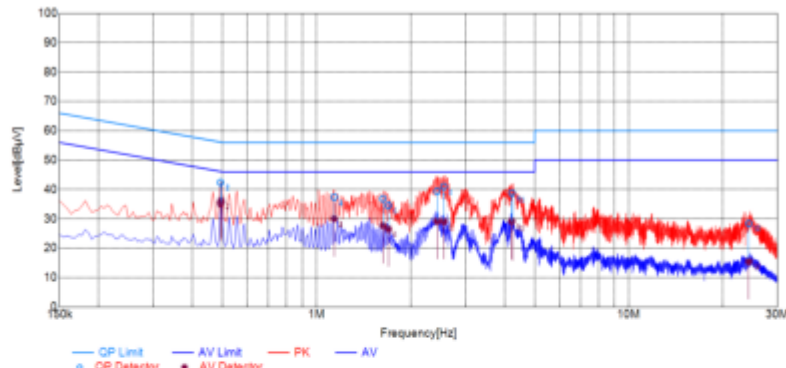

Final Data List

| NO. | Frequency [MHz] | QP Reading [dBµV] | AVG. Reading [dBµV] | Factor [dB] | QP Result [dBµV] | AVG. Result [dBµV] | QP Limit [dBµV] | AVG. Limit [dBµV] | QP Margin [dB] | AVG. Margin [dB] | Line | Remark |
|-----|-----------------|-------------------|---------------------|-------------|------------------|--------------------|-----------------|-------------------|----------------|------------------|------|--------|
| 1 | 0.4920 | 32.14 | 24.79 | 10.26 | 42.40 | 35.05 | 56.13 | 46.13 | 13.73 | 11.08 | L1 | PASS |
| 2 | 0.4941 | 32.42 | 25.94 | 10.26 | 42.68 | 36.20 | 56.10 | 46.10 | 13.42 | 9.90 | L1 | PASS |
| 3 | 1.1386 | 27.23 | 19.86 | 10.21 | 37.44 | 30.07 | 56.00 | 46.00 | 18.56 | 15.93 | L1 | PASS |
| 4 | 1.1398 | 27.10 | 19.71 | 10.21 | 37.31 | 29.92 | 56.00 | 46.00 | 18.69 | 16.08 | L1 | PASS |
| 5 | 1.6316 | 26.63 | 17.49 | 10.24 | 36.87 | 27.73 | 56.00 | 46.00 | 19.13 | 18.27 | L1 | PASS |
| 6 | 1.6972 | 24.24 | 16.34 | 10.25 | 34.49 | 26.59 | 56.00 | 46.00 | 21.51 | 19.41 | L1 | PASS |
| 7 | 2.4329 | 29.10 | 18.88 | 10.30 | 39.40 | 29.18 | 56.00 | 46.00 | 16.60 | 16.82 | L1 | PASS |
| 8 | 2.5580 | 30.70 | 18.79 | 10.31 | 41.01 | 29.10 | 56.00 | 46.00 | 14.99 | 16.90 | L1 | PASS |
| 9 | 4.2203 | 28.47 | 18.83 | 10.37 | 38.84 | 29.20 | 56.00 | 46.00 | 17.16 | 16.80 | L1 | PASS |
| 10 | 4.2523 | 28.13 | 18.18 | 10.36 | 38.49 | 28.54 | 56.00 | 46.00 | 17.51 | 17.46 | L1 | PASS |
| 11 | 24.2718 | 16.84 | 3.88 | 11.56 | 28.42 | 15.46 | 60.00 | 50.00 | 31.58 | 34.54 | L1 | PASS |
| 12 | 24.2079 | 17.30 | 4.35 | 11.57 | 28.87 | 15.92 | 60.00 | 50.00 | 31.13 | 34.08 | L1 | PASS |

| | | | |
|---------------|--------------|--------------|---|
| Power supply: | AC 120V/60Hz | Polarization | N |
|---------------|--------------|--------------|---|

Test Graph

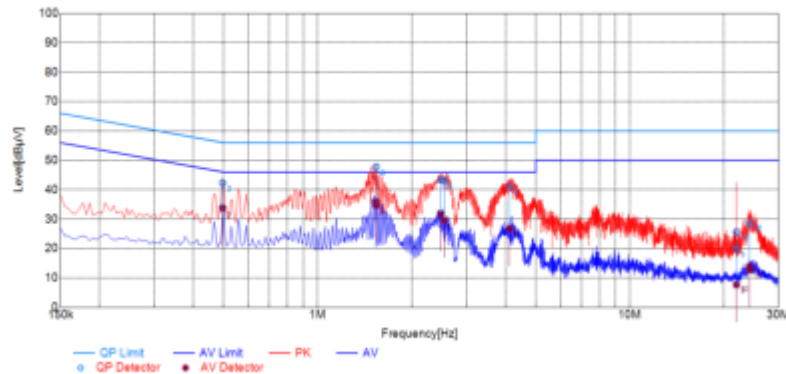

Final Data List

| NO. | Frequency [MHz] | QP Reading [dBµV] | AVG. Reading [dBµV] | Factor [dB] | QP Result [dBµV] | AVG. Result [dBµV] | QP Limit [dBµV] | AVG. Limit [dBµV] | QP Margin [dB] | AVG. Margin [dB] | Line | Remark |
|-----|-----------------|-------------------|---------------------|-------------|------------------|--------------------|-----------------|-------------------|----------------|------------------|------|--------|
| 1 | 0.4959 | 32.08 | 23.56 | 10.26 | 42.34 | 33.82 | 56.07 | 46.07 | 13.73 | 12.25 | N | PASS |
| 2 | 0.4974 | 32.12 | 23.16 | 10.25 | 42.37 | 33.41 | 56.04 | 46.04 | 13.67 | 12.63 | N | PASS |
| 3 | 1.5411 | 37.56 | 25.84 | 10.24 | 47.80 | 36.08 | 56.00 | 46.00 | 8.20 | 9.92 | N | PASS |
| 4 | 1.5397 | 37.12 | 24.51 | 10.24 | 47.36 | 34.75 | 56.00 | 46.00 | 8.64 | 11.25 | N | PASS |
| 5 | 2.4831 | 33.04 | 21.56 | 10.30 | 43.34 | 31.86 | 56.00 | 46.00 | 12.66 | 14.14 | N | PASS |
| 6 | 2.5453 | 32.88 | 19.41 | 10.31 | 43.19 | 29.72 | 56.00 | 46.00 | 12.81 | 16.28 | N | PASS |
| 7 | 4.1206 | 30.79 | 16.45 | 10.36 | 41.15 | 26.81 | 56.00 | 46.00 | 14.85 | 19.19 | N | PASS |
| 8 | 4.1215 | 30.88 | 16.90 | 10.36 | 41.24 | 27.26 | 56.00 | 46.00 | 14.76 | 18.74 | N | PASS |
| 9 | 21.9865 | 8.40 | -3.75 | 11.47 | 19.87 | 7.72 | 60.00 | 50.00 | 40.13 | 42.28 | N | PASS |
| 10 | 21.9975 | 14.16 | -3.14 | 11.47 | 25.63 | 8.33 | 60.00 | 50.00 | 34.37 | 41.67 | N | PASS |
| 11 | 24.2457 | 17.15 | 1.16 | 11.52 | 28.67 | 12.68 | 60.00 | 50.00 | 31.33 | 37.32 | N | PASS |
| 12 | 24.2400 | 17.50 | 2.40 | 11.52 | 29.02 | 13.92 | 60.00 | 50.00 | 30.98 | 36.08 | N | PASS |

4.2. Radiated Emission

TEST CONFIGURATION

Frequency range 9 KHz – 30MHz

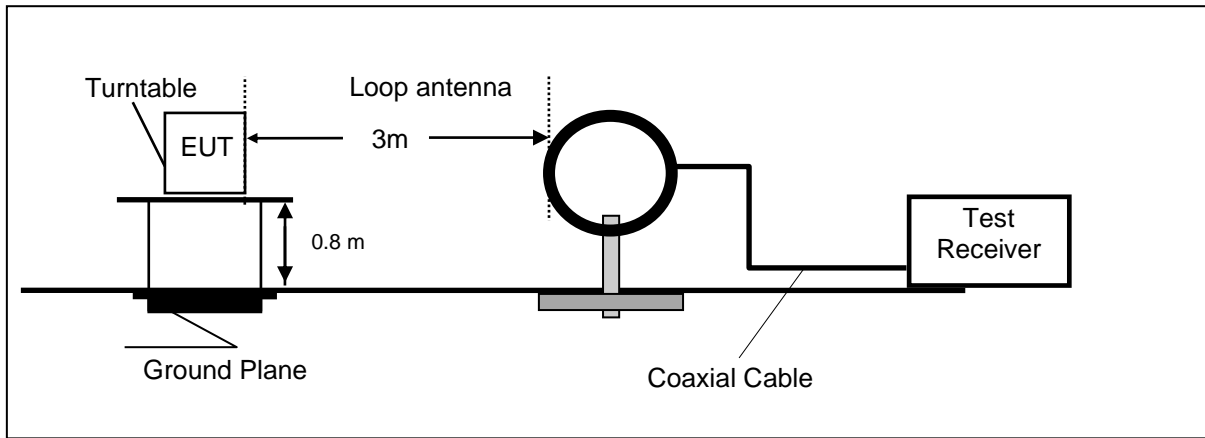

Frequency range 30MHz – 1000MHz

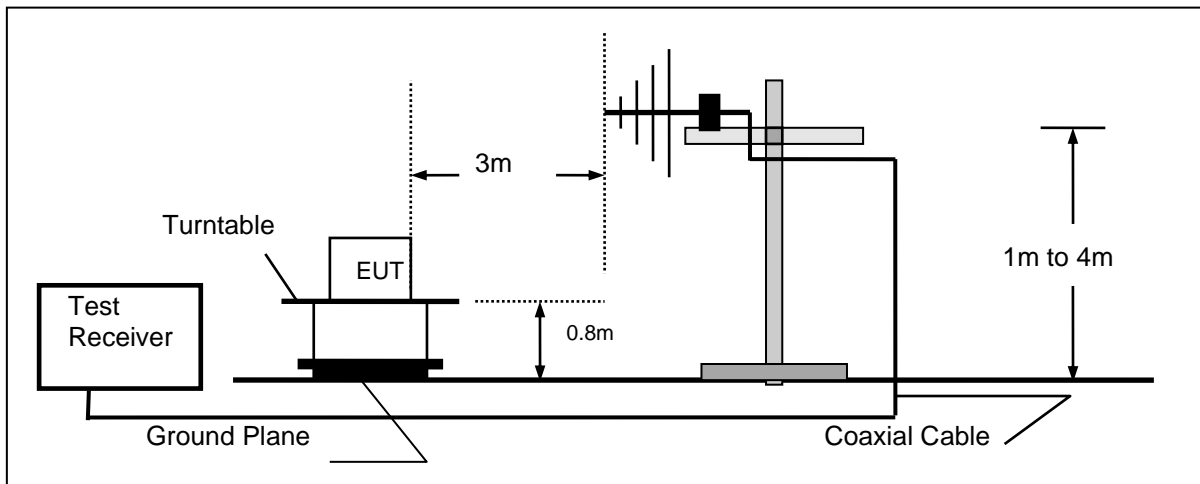

Frequency range above 1GHz-25GHz

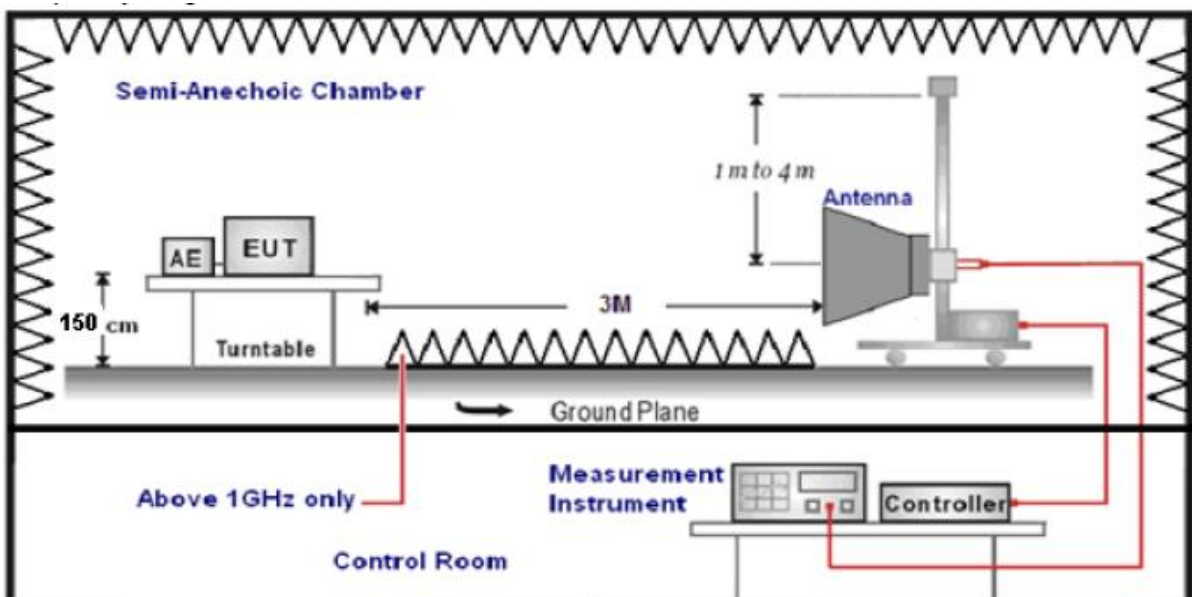

TEST PROCEDURE

1. The EUT was placed on a turn table which is 0.8m above ground plane when testing frequency range 9 KHz –1GHz;the EUT was placed on a turn table which is 1.5m above ground plane when testing frequency range 1GHz – 25GHz.
2. Maximum procedure was performed by raising the receiving antenna from 1m to 4m and rotating the turn table from 0°C to 360°C to acquire the highest emissions from EUT.
3. And also, each emission was to be maximized by changing the polarization of receiving antenna both horizontal and vertical.
4. Repeat above procedures until all frequency measurements have been completed.
5. The EUT minimum operation frequency was 32.768KHz and maximum operation frequency was 2480MHz.so radiated emission test frequency band from 9KHz to 25GHz.
6. The distance between test antenna and EUT as following table states:

| Test Frequency range | Test Antenna Type | Test Distance |
|----------------------|----------------------------|---------------|
| 9KHz-30MHz | Active Loop Antenna | 3 |
| 30MHz-1GHz | Ultra-Broadband Antenna | 3 |
| 1GHz-18GHz | Double Ridged Horn Antenna | 3 |
| 18GHz-25GHz | Horn Antenna | 1 |

7. Setting test receiver/spectrum as following table states:

| Test Frequency range | Test Receiver/Spectrum Setting | Detector |
|----------------------|---|----------|
| 9KHz-150KHz | RBW=200Hz/VBW=3KHz,Sweep time=Auto | QP |
| 150KHz-30MHz | RBW=9KHz/VBW=100KHz,Sweep time=Auto | QP |
| 30MHz-1GHz | RBW=120KHz/VBW=1000KHz,Sweep time=Auto | QP |
| 1GHz-40GHz | Peak Value: RBW=1MHz/VBW=3MHz, Sweep time=Auto Average Value: RBW=1MHz/VBW=10Hz, Sweep time=Auto | Peak |

Field Strength Calculation

The field strength is calculated by adding the Antenna Factor and Cable Factor and subtracting the Amplifier Gain and Duty Cycle Correction Factor(if any) from the measured reading. The basic equation with a sample calculation is as follows:

FS = RA + AF + CL - AG

| | |
|---------------------------|--|
| Where FS = Field Strength | CL = Cable Attenuation Factor (Cable Loss) |
| RA = Reading Amplitude | AG = Amplifier Gain |
| AF = Antenna Factor | |

Transd=AF +CL-AG

RADIATION LIMIT

For intentional device, according to § 15.209(a), the general requirement of field strength of radiated emission from intentional radiators at a distance of 3 meters shall not exceed the following table. According to § 15.247(d), in any 100kHz bandwidth outside the frequency band in which the EUT is operating, the radio frequency power that is produced by the intentional radiator shall be at least 20dB below that in the100kHz bandwidth within the band that contains the highest level of desired power.

The pre-test have done for the EUT in three axes and found the worst emission at position shown in test setup photos.

| Frequency (MHz) | Distance (Meters) | Radiated (dBµV/m) | Radiated (µV/m) |
|-----------------|-------------------|----------------------------------|-----------------|
| 0.009-0.49 | 3 | 20log(2400/F(KHz))+40log(300/3) | 2400/F(KHz) |
| 0.49-1.705 | 3 | 20log(24000/F(KHz))+ 40log(30/3) | 24000/F(KHz) |
| 1.705-30 | 3 | 20log(30)+ 40log(30/3) | 30 |
| 30-88 | 3 | 40.0 | 100 |
| 88-216 | 3 | 43.5 | 150 |
| 216-960 | 3 | 46.0 | 200 |
| Above 960 | 3 | 54.0 | 500 |

TEST RESULTS

For 30MHz to 1000MHz

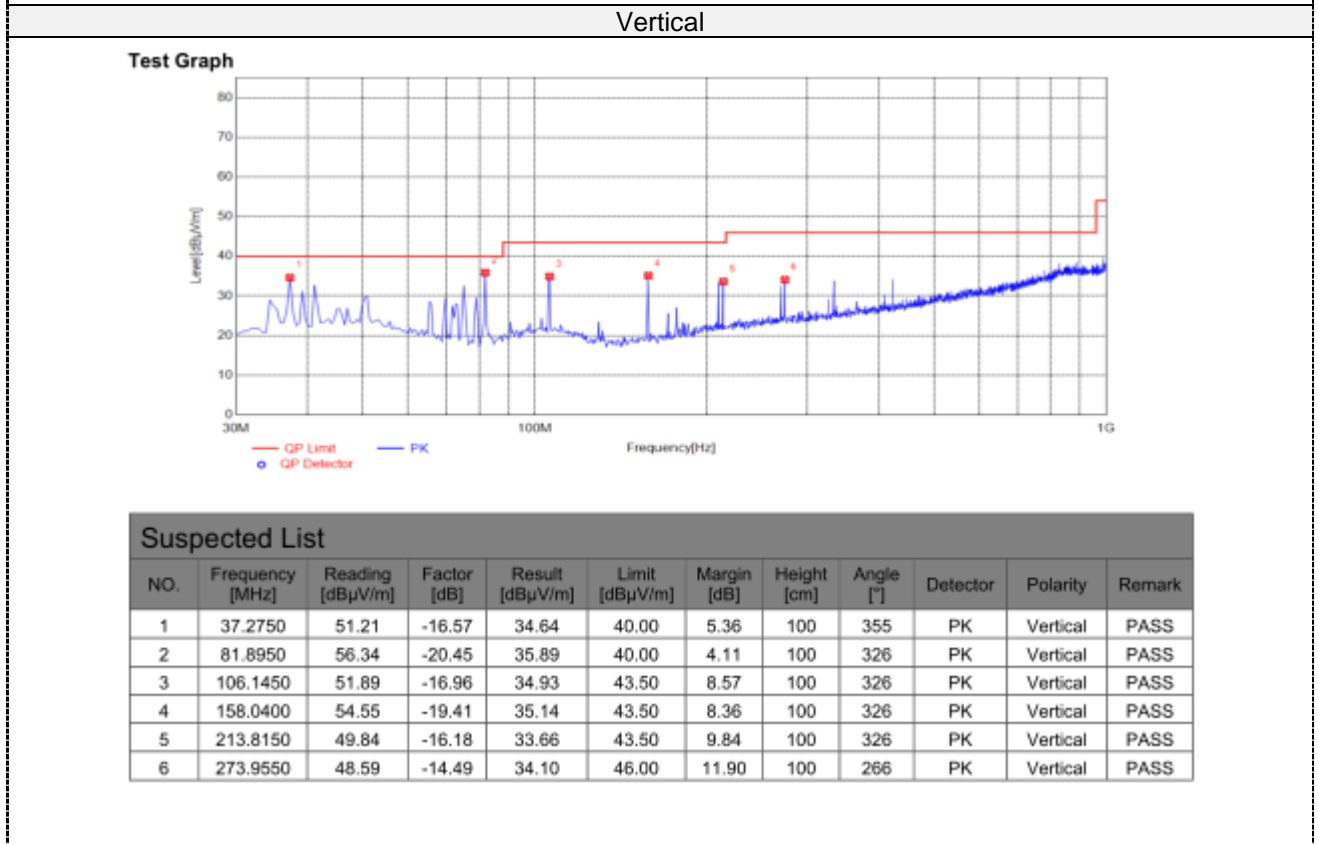
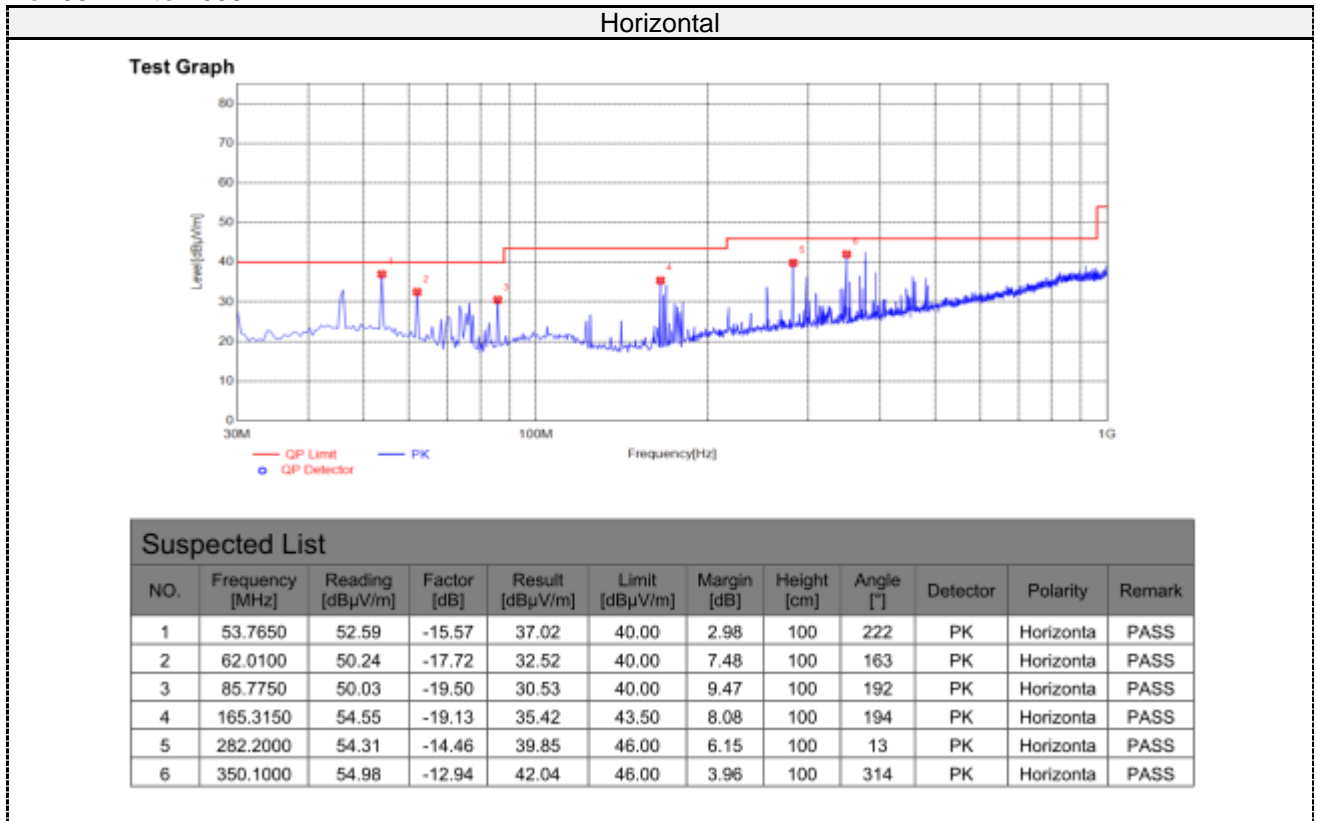

For 1GHz to 25GHz

| Frequency | Meter Reading | Antenna Factor | Cable loss | Preamp factor | Emission Level | Limits | Margin | Detector Type | Comment |
|-----------|---------------|----------------|------------|---------------|----------------|----------------|--------|---------------|------------|
| (MHz) | (dB μ V) | (dB) | (dB) | (dB) | (dB μ V/m) | (dB μ V/m) | (dB) | | |
| TX-2402 | | | | | | | | | |
| 4804 | 45.62 | 32.44 | 30.25 | 7.95 | 55.76 | 74 | 18.24 | Pk | Vertical |
| 4804 | 34.35 | 32.44 | 30.25 | 7.95 | 44.49 | 54 | 9.51 | AV | Vertical |
| 4804 | 40.93 | 32.44 | 30.25 | 7.95 | 51.07 | 74 | 22.93 | Pk | Horizontal |
| 4804 | 29.98 | 32.44 | 30.25 | 7.95 | 40.12 | 54 | 13.88 | AV | Horizontal |
| TX-2440 | | | | | | | | | |
| 4880 | 46.13 | 32.52 | 30.31 | 8.12 | 56.46 | 74 | 17.54 | Pk | Vertical |
| 4880 | 35.45 | 32.52 | 30.31 | 8.12 | 45.78 | 54 | 8.22 | AV | Vertical |
| 4880 | 38.60 | 32.52 | 30.31 | 8.12 | 48.93 | 74 | 25.07 | Pk | Horizontal |
| 4880 | 31.74 | 32.52 | 30.31 | 8.12 | 42.07 | 54 | 11.93 | AV | Horizontal |
| TX-2480 | | | | | | | | | |
| 4960 | 45.40 | 32.68 | 30.27 | 7.88 | 55.69 | 74 | 18.31 | Pk | Vertical |
| 4960 | 34.13 | 32.68 | 30.27 | 7.88 | 44.42 | 54 | 9.58 | AV | Vertical |
| 4960 | 39.78 | 32.68 | 30.27 | 7.88 | 50.07 | 74 | 23.93 | Pk | Horizontal |
| 4960 | 32.16 | 32.68 | 30.27 | 7.88 | 42.45 | 54 | 11.55 | AV | Horizontal |

REMARKS:

1. Emission level (dB μ V/m) = Meter Reading+ antenna Factor+ cable loss- preamp factor
2. Margin value = Emission level-Limits
3. -- Mean the PK detector measured value is below average limit.
4. The other emission levels were very low against the limit.
5. If the PK measured levels comply with average limit, then the average level were deemed to comply with average limit.

4.3. Maximum Peak Output Power

TEST CONFIGURATION

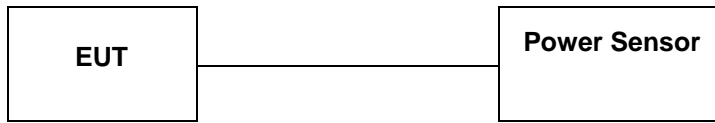

TEST PROCEDURE

According to KDB558074 D01 DTS Measurement Guidance Section 9.1 Maximum peak conducted output power,9.1.2.

The maximum peak conducted output power may be measured using a broadband peak RF power meter. The power meter shall have a video bandwidth that is greater than or equal to the DTS bandwidth and shall utilize a fast-responding diode detector.

LIMIT

The Maximum Peak Output Power Measurement is 30dBm.

TEST RESULTS

| Type | Channel | Peak Output power (dBm) | Limit (dBm) | Result |
|------|---------|-------------------------|-------------|--------|
| 1M | 02 | -0.41 | 30 | Pass |
| | 40 | -0.34 | | |
| | 80 | -0.87 | | |
| 2M | 02 | -0.51 | | |
| | 40 | -0.45 | | |
| | 80 | -1.01 | | |

Note: 1.The test results including the cable lose.

Duty cycle used in all test items: 1M:95.5%, 2M:91.1%

1M

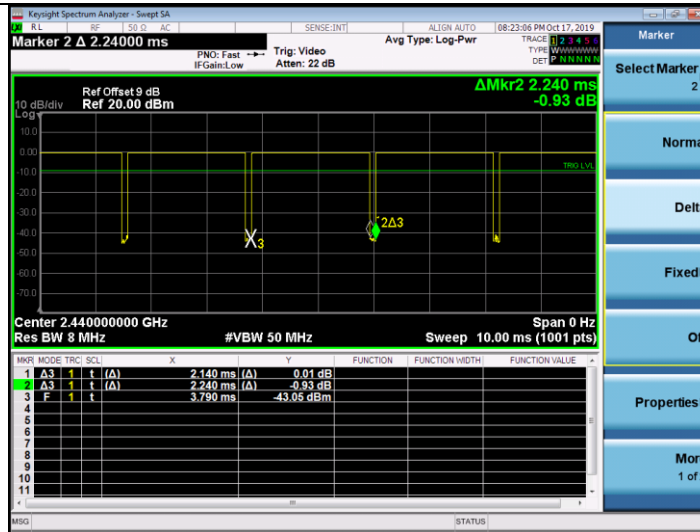

2M

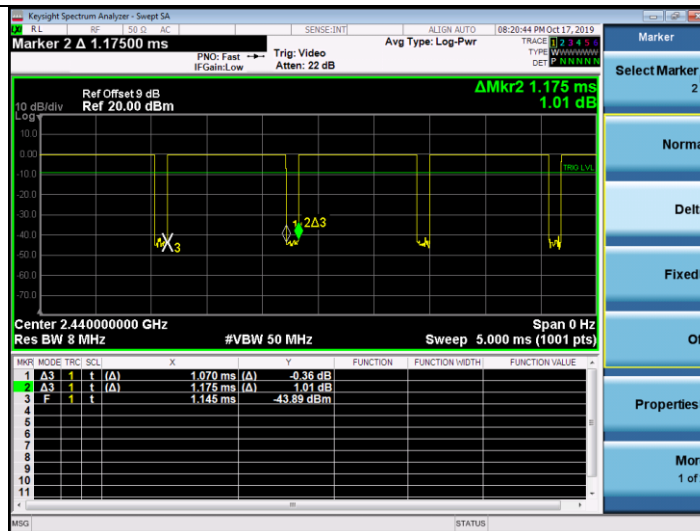

4.4. Power Spectral Density

TEST CONFIGURATION

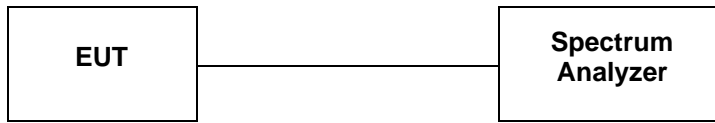

TEST PROCEDURE

1. Use this procedure when the maximum peak conducted output power in the fundamental emission is used to demonstrate compliance.
2. Set the RBW = 3 kHz.
3. Set the VBW = 10 KHz.
4. Set the span to 1.5 times the DTS channel bandwidth.
5. Detector = peak.
6. Sweep time = auto couple.
7. Trace mode = max hold.
8. Allow trace to fully stabilize.
9. Use the peak marker function to determine the maximum power level.
10. If measured value exceeds limit, reduce RBW (no less than 3 kHz) and repeat.
11. The resulting peak PSD level must be 8 dBm.

LIMIT

For digitally modulated systems, the power spectral density conducted from the intentional radiator to the antenna shall not be greater than 8 dBm in any 3 kHz band during any time interval of continuous transmission.

TEST RESULTS

| Type | Channel | Power Spectral Density | Limit (dBm/3KHz) | Result |
|------|---------|------------------------|------------------|--------|
| 1M | 02 | -9.80 | 8.00 | Pass |
| | 40 | -9.57 | | |
| | 80 | -10.78 | | |
| 2M | 02 | -12.45 | | |
| | 40 | -14.69 | | |
| | 80 | -13.84 | | |

1M:

CH02



CH40

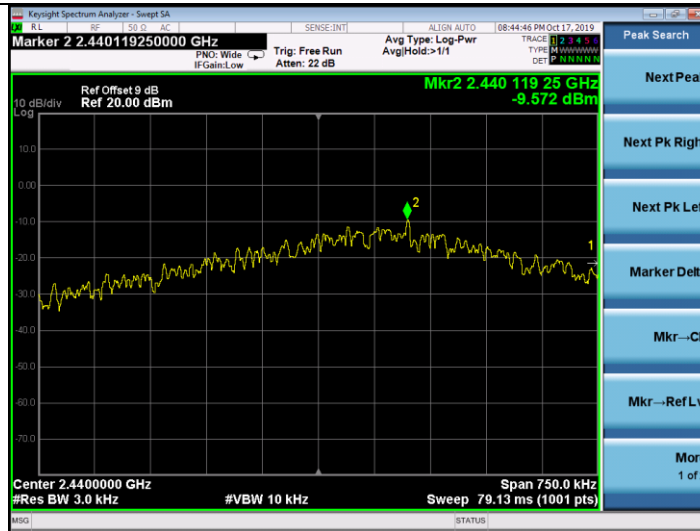

CH80

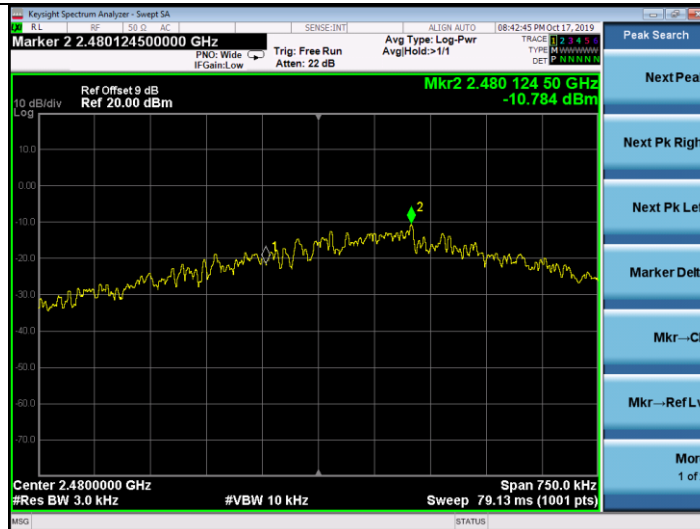

2M:

CH02

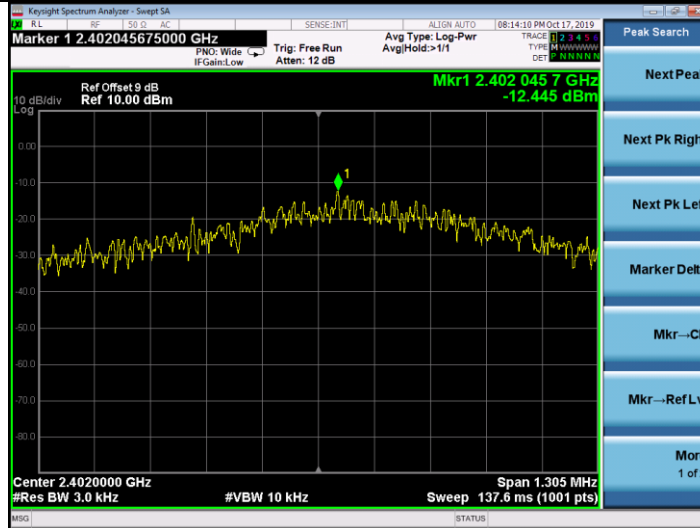

CH40

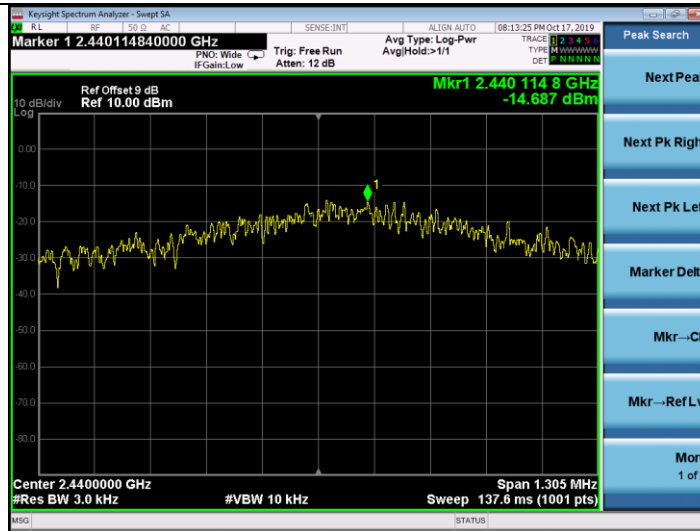

CH80

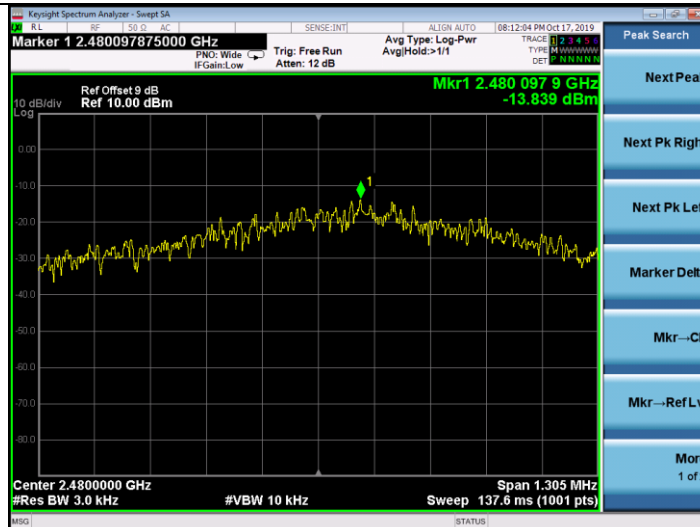

4.5. 6dB Bandwidth

TEST CONFIGURATION

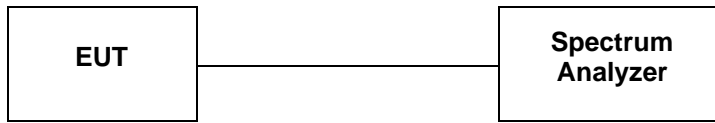

TEST PROCEDURE

The transmitter output was connected to the spectrum analyzer through an attenuator. The bandwidth of the fundamental frequency was measured by spectrum analyzer with RBW=100 KHz and VBW=300KHz. The 6dB bandwidth is defined as the total spectrum the power of which is higher than peak power minus 6dB. According to KDB558074 D01 V05 for one of the following procedures may be used to determine the modulated DTS device signal bandwidth.

1. Set RBW = 100 kHz.
2. Set the video bandwidth (VBW) ≥ 3 RBW.
3. Detector = Peak.
4. Trace mode = max hold.
5. Sweep = auto couple.
6. Allow the trace to stabilize.
7. Measure the maximum width of the emission that is constrained by the frequencies associated with the two outermost amplitude points (upper and lower frequencies) that are attenuated by 6 dB relative to the maximum level measured in the fundamental emission.

LIMIT

For digital modulation systems, the minimum 6 dB bandwidth shall be at least 500 kHz

TEST RESULTS

| Type | Channel | 6dB Bandwidth (KHz) | Limit (KHz) | Result |
|------|---------|---------------------|-------------|--------|
| 1M | 02 | 503.6 | ≥500 | Pass |
| | 40 | 503.6 | | |
| | 80 | 500.7 | | |
| 2M | 02 | 846.3 | | |
| | 40 | 867.0 | | |
| | 80 | 872.4 | | |

1M:

CH02

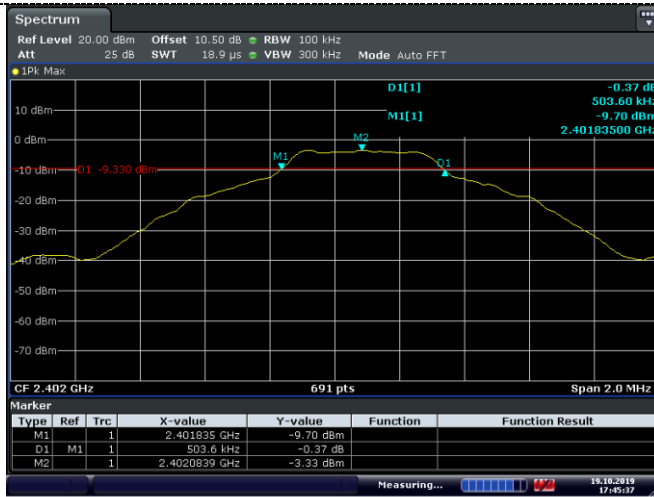

Date: 19.OCT.2019 17:45:37

CH40

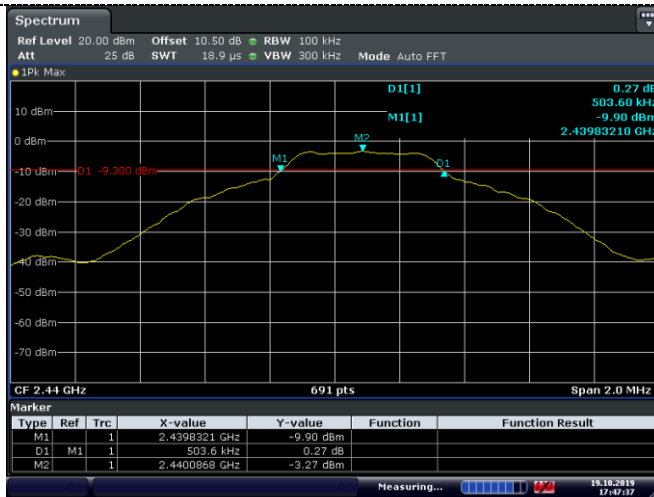

Date: 19.OCT.2019 17:47:37

CH80

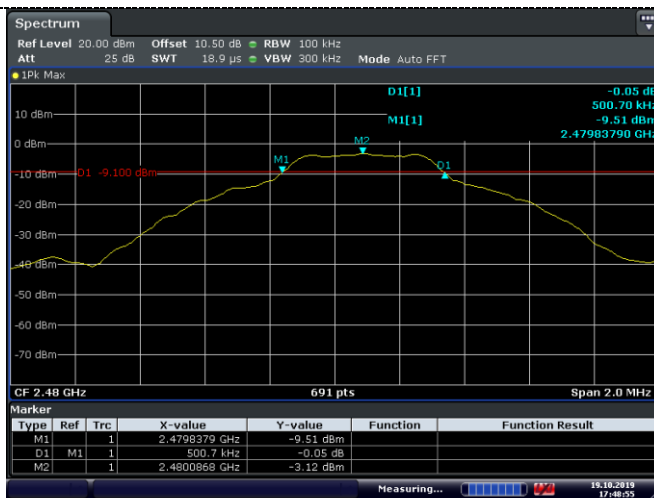

Date: 19.OCT.2019 17:48:55

2M:

CH02

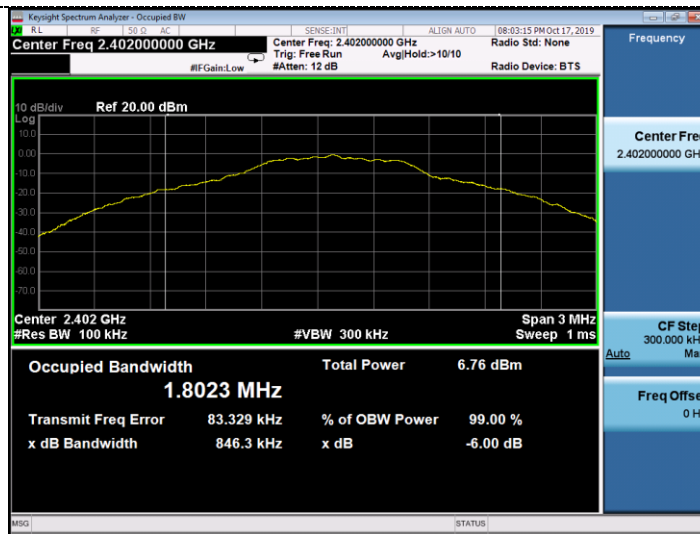

CH40

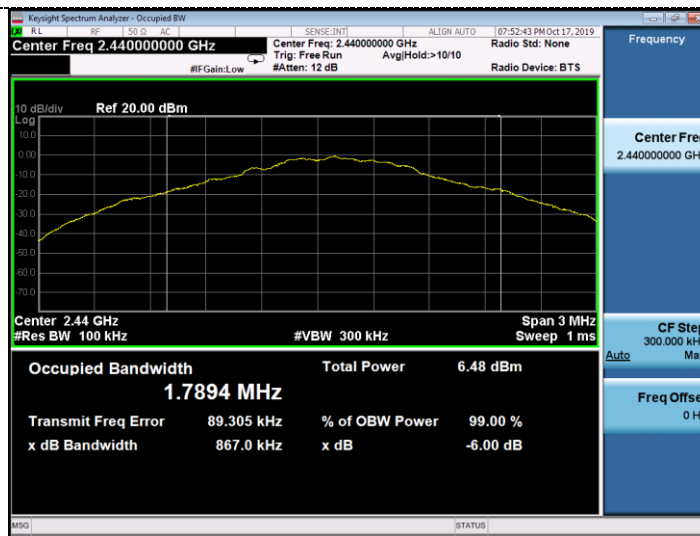

CH80

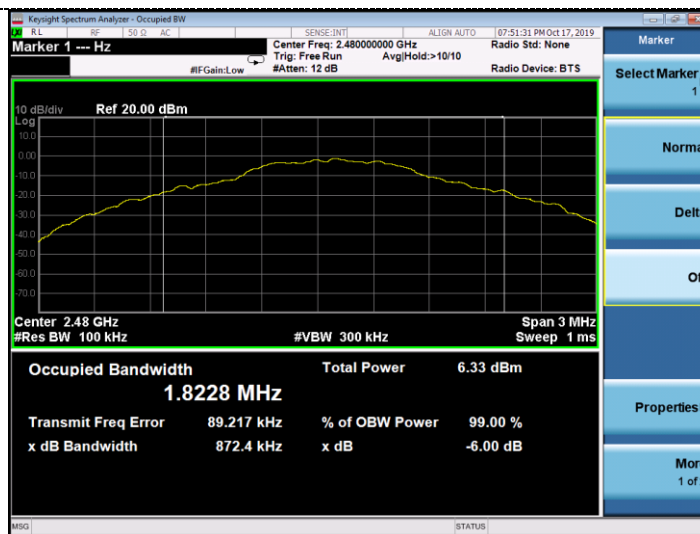

4.6. Band Edge Compliance of RF Emission

TEST REQUIREMENT

In any 100 kHz bandwidth outside the frequency band in which the spread spectrum or digitally modulated intentional radiator is operating, the radio frequency power that is produced by the intentional radiator shall be at least 20 dB below that in the 100 kHz bandwidth within the band that contains the highest level of the desired power, based on either an RF conducted or a radiated measurement, provided the transmitter demonstrates compliance with the peak conducted power limits. If the transmitter complies with the conducted power limits based on the use of RMS averaging over a time interval, as permitted under paragraph (b)(3) of this section, the attenuation required under this paragraph shall be 30 dB instead of 20 dB. Attenuation below the general limits specified in §15.209(a) is not required. In addition, radiated emissions which fall in the restricted bands, as defined in §15.205(a), must also comply with the radiated emission limits specified in §15.209(a) (see §15.205(c)).

TEST CONFIGURATION

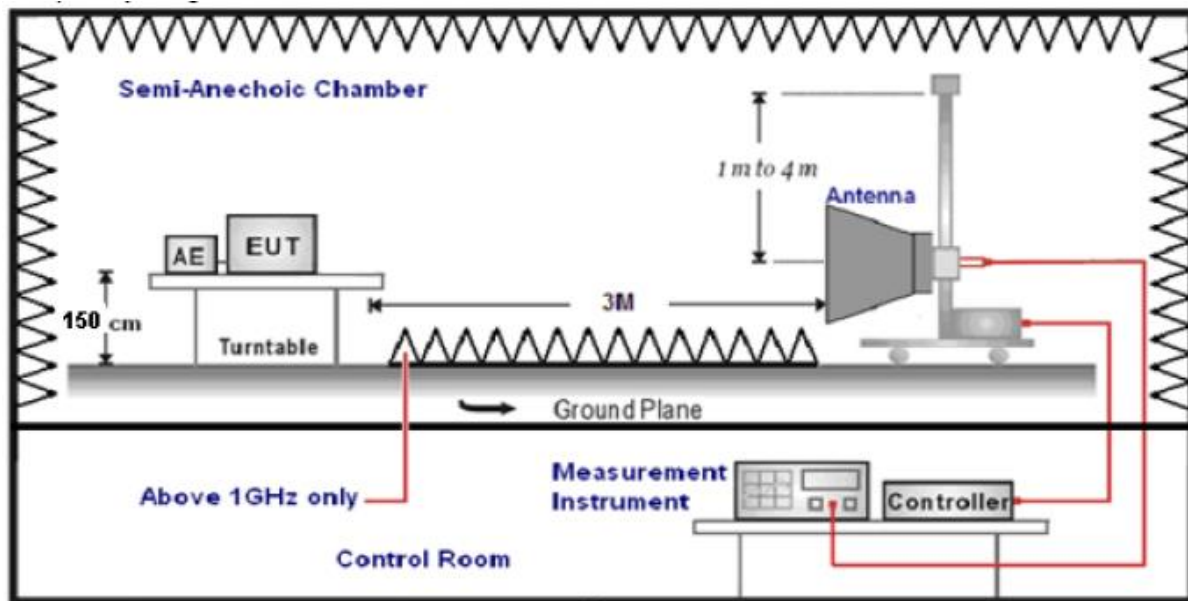

TEST PROCEDURE

1. The EUT was placed on a turn table which is 1.5m above ground plane.
2. Maximum procedure was performed by raising the receiving antenna from 1m to 4m and rotating the turn table from 0° to 360° to acquire the highest emissions from EUT.
3. And also, each emission was to be maximized by changing the polarization of receiving antenna both horizontal and vertical.
4. Repeat above procedures until all frequency measurements have been completed..
5. The distance between test antenna and EUT was 3 meter:
6. Setting test receiver/spectrum as following table states:

| Test Frequency range | Test Receiver/Spectrum Setting | Detector |
|----------------------|---|----------|
| 1GHz-40GHz | Peak Value: RBW=1MHz/VBW=3MHz, Sweep time=Auto Average Value: RBW=1MHz/VBW=10Hz, Sweep time=Auto | Peak |

LIMIT

Below -20dB of the highest emission level in operating band.
Radiated emissions which fall in the restricted bands, as defined in § 15.205(a), must also comply with the radiated emission limits specified in § 15.209(a)

TEST RESULTS**4.6.1 For Radiated Bandedge Measurement
1M:**

| Frequency(MHz): | | | 2402 | | | Polarity: | | | HORIZONTAL | | |
|-----------------|-------------------------|----|----------------|-------------|--------------------|----------------------|------------------|-----------------------|-------------------|---------------|--------------------------|
| Frequency (MHz) | Emission Level (dBuV/m) | | Limit (dBuV/m) | Margin (dB) | Antenna Height (m) | Table Angle (Degree) | Raw Value (dBuV) | Antenna Factor (dB/m) | Cable Factor (dB) | Pre-amplifier | Correction Factor (dB/m) |
| 2390.00 | 48.10 | PK | 74 | 25.90 | 1 | 115 | 53.41 | 27.49 | 3.32 | 36.12 | -5.31 |
| 2390.00 | 37.80 | AV | 54 | 16.20 | 1 | 115 | 43.11 | 27.49 | 3.32 | 36.12 | -5.31 |
| Frequency(MHz): | | | 2402 | | | Polarity: | | | VERTICAL | | |
| Frequency (MHz) | Emission Level (dBuV/m) | | Limit (dBuV/m) | Margin (dB) | Antenna Height (m) | Table Angle (Degree) | Raw Value (dBuV) | Antenna Factor (dB/m) | Cable Factor (dB) | Pre-amplifier | Correction Factor (dB/m) |
| 2390.00 | 48.61 | PK | 74 | 25.39 | 1 | 318 | 53.92 | 27.49 | 3.32 | 36.12 | -5.31 |
| 2390.00 | 38.68 | AV | 54 | 15.32 | 1 | 318 | 43.99 | 27.49 | 3.32 | 36.12 | -5.31 |
| Frequency(MHz): | | | 2480 | | | Polarity: | | | HORIZONTAL | | |
| Frequency (MHz) | Emission Level (dBuV/m) | | Limit (dBuV/m) | Margin (dB) | Antenna Height (m) | Table Angle (Degree) | Raw Value (dBuV) | Antenna Factor (dB/m) | Cable Factor (dB) | Pre-amplifier | Correction Factor (dB/m) |
| 2483.50 | 48.06 | PK | 74 | 24.67 | 1 | 118 | 53.78 | 27.45 | 3.38 | 36.55 | -5.72 |
| 2483.50 | 38.10 | AV | 54 | 12.37 | 1 | 118 | 43.82 | 27.45 | 3.38 | 36.55 | -5.72 |
| Frequency(MHz): | | | 2480 | | | Polarity: | | | VERTICAL | | |
| Frequency (MHz) | Emission Level (dBuV/m) | | Limit (dBuV/m) | Margin (dB) | Antenna Height (m) | Table Angle (Degree) | Raw Value (dBuV) | Antenna Factor (dB/m) | Cable Factor (dB) | Pre-amplifier | Correction Factor (dB/m) |
| 2483.50 | 48.34 | PK | 74 | 24.67 | 1 | 108 | 54.06 | 27.45 | 3.38 | 36.55 | -5.72 |
| 2483.50 | 38.15 | AV | 54 | 12.37 | 1 | 108 | 43.87 | 27.45 | 3.38 | 36.55 | -5.72 |

2M:

| Frequency(MHz): | | | 2402 | | | Polarity: | | | HORIZONTAL | | |
|-----------------|-------------------------|----|----------------|-------------|--------------------|----------------------|------------------|-----------------------|-------------------|---------------|--------------------------|
| Frequency (MHz) | Emission Level (dBuV/m) | | Limit (dBuV/m) | Margin (dB) | Antenna Height (m) | Table Angle (Degree) | Raw Value (dBuV) | Antenna Factor (dB/m) | Cable Factor (dB) | Pre-amplifier | Correction Factor (dB/m) |
| 2390.00 | 48.77 | PK | 74 | 25.23 | 1 | 113 | 54.08 | 27.49 | 3.32 | 36.12 | -5.31 |
| 2390.00 | 38.74 | AV | 54 | 15.26 | 1 | 113 | 44.05 | 27.49 | 3.32 | 36.12 | -5.31 |
| Frequency(MHz): | | | 2402 | | | Polarity: | | | VERTICAL | | |
| Frequency (MHz) | Emission Level (dBuV/m) | | Limit (dBuV/m) | Margin (dB) | Antenna Height (m) | Table Angle (Degree) | Raw Value (dBuV) | Antenna Factor (dB/m) | Cable Factor (dB) | Pre-amplifier | Correction Factor (dB/m) |
| 2390.00 | 48.51 | PK | 74 | 25.49 | 1 | 207 | 53.82 | 27.49 | 3.32 | 36.12 | -5.31 |
| 2390.00 | 38.65 | AV | 54 | 15.35 | 1 | 207 | 43.96 | 27.49 | 3.32 | 36.12 | -5.31 |
| Frequency(MHz): | | | 2480 | | | Polarity: | | | HORIZONTAL | | |
| Frequency (MHz) | Emission Level (dBuV/m) | | Limit (dBuV/m) | Margin (dB) | Antenna Height (m) | Table Angle (Degree) | Raw Value (dBuV) | Antenna Factor (dB/m) | Cable Factor (dB) | Pre-amplifier | Correction Factor (dB/m) |
| 2483.50 | 48.66 | PK | 74 | 24.67 | 1 | 118 | 54.38 | 27.45 | 3.38 | 36.55 | -5.72 |
| 2483.50 | 38.01 | AV | 54 | 12.37 | 1 | 118 | 43.73 | 27.45 | 3.38 | 36.55 | -5.72 |
| Frequency(MHz): | | | 2480 | | | Polarity: | | | VERTICAL | | |
| Frequency (MHz) | Emission Level (dBuV/m) | | Limit (dBuV/m) | Margin (dB) | Antenna Height (m) | Table Angle (Degree) | Raw Value (dBuV) | Antenna Factor (dB/m) | Cable Factor (dB) | Pre-amplifier | Correction Factor (dB/m) |
| 2483.50 | 48.50 | PK | 74 | 24.67 | 1 | 200 | 54.22 | 27.45 | 3.38 | 36.55 | -5.72 |
| 2483.50 | 37.97 | AV | 54 | 12.37 | 1 | 200 | 43.69 | 27.45 | 3.38 | 36.55 | -5.72 |

NOTE:

Emission level (dBuV/m) = Meter Reading+ antenna Factor+ cable loss- preamp factor

Margin value = Limits-Emission level

4.6.2 For Conducted Bandedge Measurement

1M:

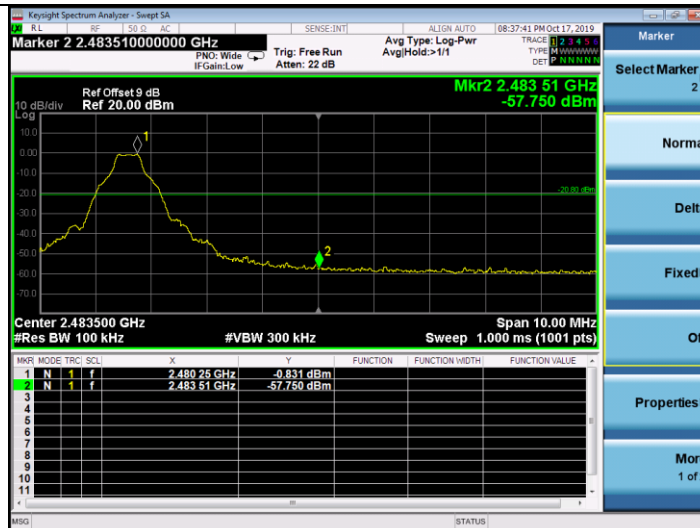
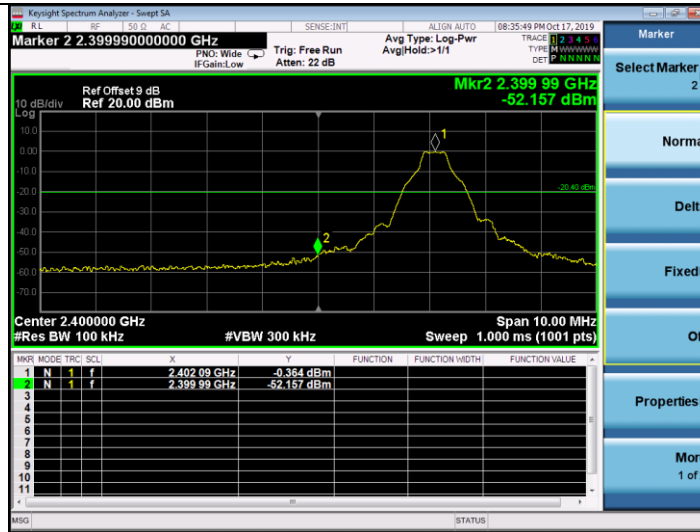

2M:

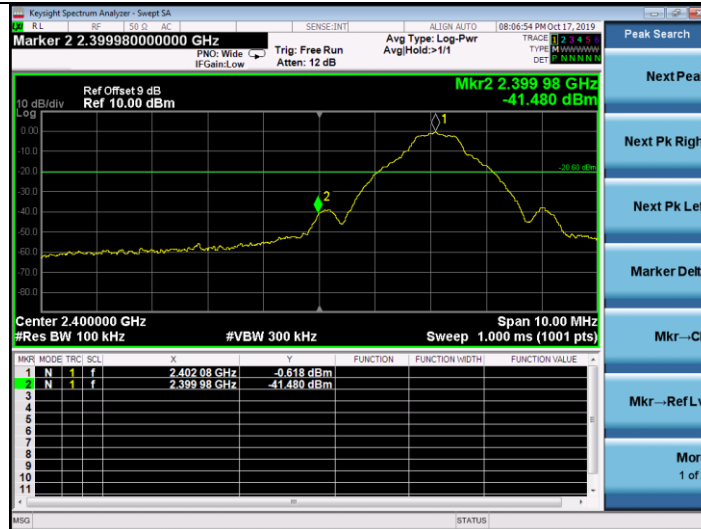

Peak Search

Next Peak

Next Pk Right

Next Pk Left

Marker Delta

Mkr--CF

Mkr--Ref Lvl

More
1 of 2

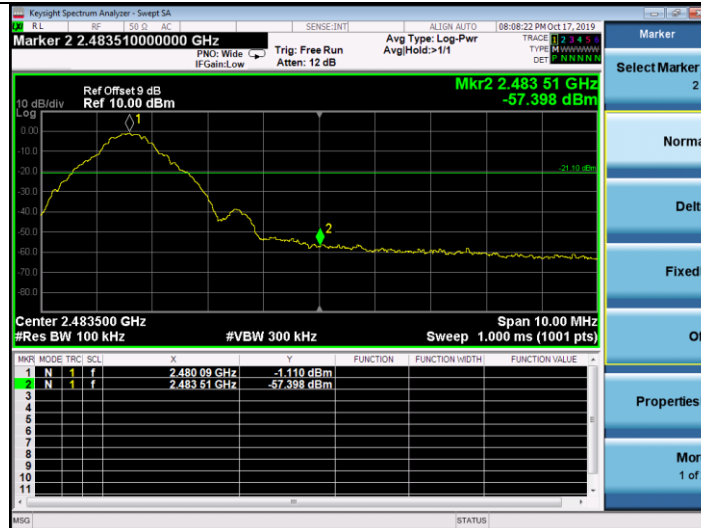

Marker

Select Marker
2

Normal

Delta

Fixed

Off

Properties

More
1 of 2

4.7. Antenna Requirement

Standard Applicable

For intentional device, according to FCC 47 CFR Section 15.203, an intentional radiator shall be designed to ensure that no antenna other than that furnished by the responsible party shall be used with the device.

And according to FCC 47 CFR Section 15.247 (c), if transmitting antennas of directional gain greater than 6dBi are used, the power shall be reduced by the amount in dB that the directional gain of the antenna exceeds 6dBi.

Test Result

The antenna used for this product is Internal Antenna and that no antenna other than that furnished by the responsible party shall be used with the device, the maximum peak gain of the transmit antenna is only 2.11dBi.

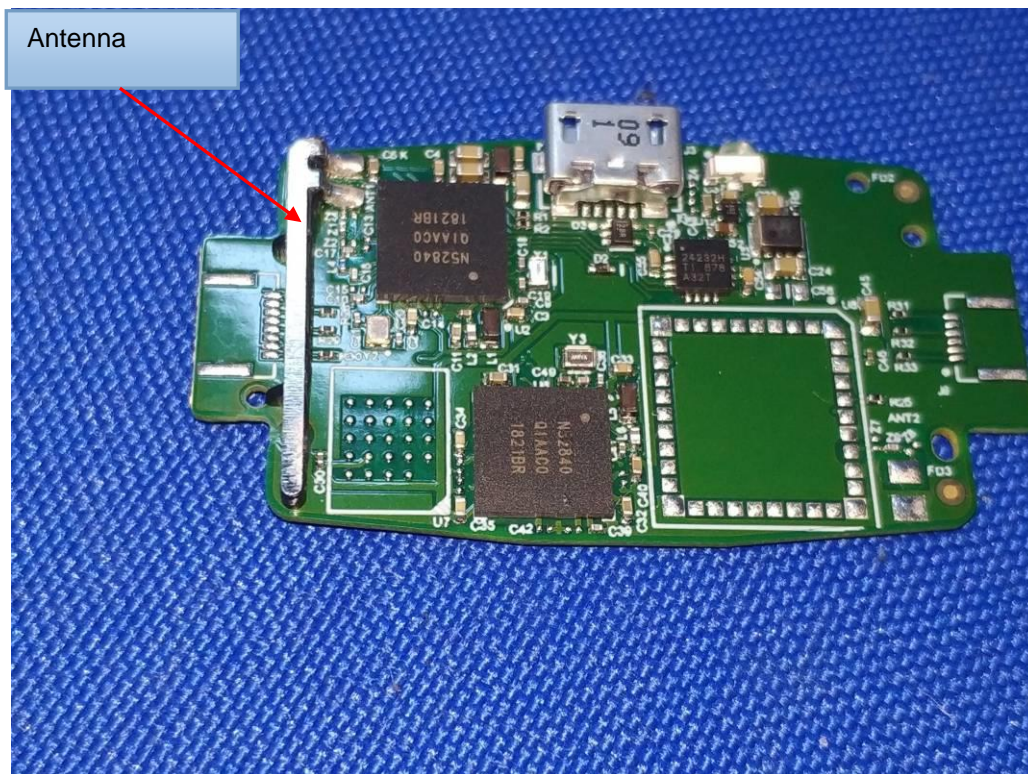

5. TEST SETUP PHOTOS OF THE EUT

Radiated Emission Test



Conducted Emission



6. EXTERNAL AND INTERNAL PHOTOS OF THE EUT

Reference to the EXTERNAL AND INTERNAL PHOTOS

.....End of Report.....