



RF TEST REPORT

Applicant Quectel Wireless Solutions Co., Ltd
FCC ID XMR201705BG96NA
Product LTE Cat M1 Module
Brand Quectel
Model BG96-NA
Report No. R1907A0353-R2
Issue Date August 1, 2019

TA Technology (Shanghai) Co., Ltd. tested the above equipment in accordance with the requirements in **FCC CFR47 Part 2 (2018)/ FCC CFR47 Part 27C (2018)**. The test results show that the equipment tested is capable of demonstrating compliance with the requirements as documented in this report.

Performed by: Peng Tao

Approved by: Kai Xu

TA Technology (Shanghai) Co., Ltd.

No.145, Jintang Rd, Tangzhen Industry Park, Pudong Shanghai, China

TEL: +86-021-50791141/2/3

FAX: +86-021-50791141/2/3-8000

Table of Contents

1	Test Laboratory	4
1.1	Notes of the Test Report	4
1.2	Test facility	4
1.3	Testing Location	5
2	General Description of Equipment under Test	6
2.1	Applied Standards	7
3	Test Configuration	8
4	Test Information	9
4.1	RF Power Output	9
4.2	Effective Isotropic Radiated Power	12
4.3	Occupied Bandwidth	16
4.4	Band Edge Compliance	19
4.5	Peak-to-Average Power Ratio (PAPR)	27
4.6	Frequency Stability	29
4.7	Spurious Emissions at Antenna Terminals	31
4.8	Radiates Spurious Emission	36
5	Main Test Instruments	41
ANNEX A: EUT Appearance and Test Setup		42
A.1	EUT Appearance	42
A.2	Test Setup	44
ANNEX B: Product Change Description		45

Summary of Measurement Results

Number	Test Case	Clause in FCC rules	Verdict
1	RF power output	2.1046	PASS
2	Effective Isotropic Radiated power	27.50(c)(10)	PASS
3	Occupied Bandwidth	2.1049	PASS
4	Band Edge Compliance	27.53(g)	PASS
5	Peak-to-Average Power Ratio	27.50(d)/KDB971168 D01(5.7)	PASS
6	Frequency Stability	2.1055 / 27.54	PASS
7	Spurious Emissions at Antenna Terminals	2.1051 /27.53(g)	PASS
8	Radiates Spurious Emission	2.1053 /27.53(g)	PASS
Date of Testing: May 9, 2017 ~ May 23, 2017 and July 10, 2019 ~ July 19, 2019			
Note: PASS: The EUT complies with the essential requirements in the standard. FAIL: The EUT does not comply with the essential requirements in the standard.			

BG96-NA (Report No.:R1907A0353-R2) is a variant model of BG96-NA (Report No.: RXA1705-0129RF01R2). This report adds LTE band 12. The detailed product change description please refers to the ANNEX B.

1 Test Laboratory

1.1 Notes of the Test Report

This report shall not be reproduced in full or partial, without the written approval of **TA technology (shanghai) co., Ltd.** The results documented in this report apply only to the tested sample, under the conditions and modes of operation as described herein .Measurement Uncertainties were not taken into account and are published for informational purposes only. This report is written to support regulatory compliance of the applicable standards stated above. This report must not be used by the client to claim product certification, approval, or endorsement by any government agencies.

1.2 Test facility

CNAS (accreditation number: L2264)

TA Technology (Shanghai) Co., Ltd. has obtained the accreditation of China National Accreditation Service for Conformity Assessment (CNAS).

FCC (recognition number is 428261)

TA Technology (Shanghai) Co., Ltd. has been listed on the US Federal Communications Commission list of test facilities recognized to perform electromagnetic emissions measurements.

IC (recognition number is 8510A)

TA Technology (Shanghai) Co., Ltd. has been listed by industry Canada to perform electromagnetic emission measurement.

A2LA (Certificate Number: 3857.01)

TA Technology (Shanghai) Co., Ltd. has been listed by American Association for Laboratory Accreditation to perform electromagnetic emission measurement.

1.3 Testing Location

Company: TA Technology (Shanghai) Co., Ltd.
Address: No.145, Jintang Rd, Tangzhen Industry Park, Pudong Shanghai, China
City: Shanghai
Post code: 201201
Country: P. R. China
Contact: Xu Kai
Telephone: +86-021-50791141/2/3
Fax: +86-021-50791141/2/3-8000
Website: <http://www.ta-shanghai.com>
E-mail: xukai@ta-shanghai.com

2 General Description of Equipment under Test

Client Information

Applicant	Quectel Wireless Solutions Co., Ltd
Applicant address	Building 5, Shanghai Business Park Phase III (Area B), No.1016 Tianlin Road, Minhang District, Shanghai, China 200233
Manufacturer	Quectel Wireless Solutions Co., Ltd
Manufacturer address	Building 5, Shanghai Business Park Phase III (Area B), No.1016 Tianlin Road, Minhang District, Shanghai, China 200233

General information

EUT Description			
Model:	BG96-NA		
IMEI:	86450803081341		
Hardware Version:	R1.0		
Software Version:	BG96NAMAR02A09M1G		
Power Supply:	External power supply		
Antenna Type:	The EUT don't have standard Antenna, The Antenna used for testing in this report is the after-market accessory (Dipole Antenna)		
Test Mode(s):	LTE Band 12		
LTE Release:	13		
LTE Category:	M1		
Maximum E.I.R.P./ E.R.P.	LTE Band 12: 20.79dBm		
Rated Power Supply Voltage:	3.8V		
Extreme Voltage:	Minimum: 3.3V Maximum: 4.3V		
Extreme Temperature:	Lowest: -40°C Highest: +85°C		
Operating Frequency Range(s)	Mode	Tx (MHz)	Rx (MHz)
	LTE Band 12	699 ~ 716	729 ~746
Note: 1. The information of the EUT is declared by the manufacturer. Please refer to the specifications or user manual for details.			

Accessory equipment	
Evaluation Board	RF Cable
RS232-to-USB Cable	Antenna: Dipole Antenna
Headset	USB Cable

2.1 Applied Standards

According to the specifications of the manufacturer, it must comply with the requirements of the following standards:

Test standards

FCC CFR47 Part 2 (2018)

FCC CFR47 Part 27C (2018)

ANSI C63.26 (2015)

KDB 971168 D01 Power Meas License Digital Systems v03r01

3 Test Configuration

Radiated measurements are performed by rotating the EUT in three different orthogonal test planes. EUT stand-up position (Z axis), lie-down position (X, Y axis). Receiver antenna polarization (horizontal and vertical), the worst emission was found in position (Z axis, vertical polarization) and the worst case was recorded.

All mode and data rates and positions and RB size and modulations were investigated. Subsequently, only the worst case emissions are reported.

The following testing in LTE is set based on the maximum RF Output Power.

The following testing in different Bandwidth is set to detail in the following table:

Test modes are chosen to be reported as the worst case configuration below for LTE Band 4/12/13:

Test items	Modes	Bandwidth (MHz)						Modulation		RB			Test Channel		
		1.4	3	5	10	15	20	QPSK	16QAM	1	50%	100%	L	M	H
RF power output	LTE 12	O	O	O	O	-	-	O	O	O	O	O	O	O	O
Effective Isotropic Radiated power	LTE 12	O	O	O	O	-	-	O	O	O	O	O	O	O	O
Occupied Bandwidth	LTE 12	O	O	O	O	-	-	O	O	-	-	O	O	O	O
Band Edge Compliance	LTE 12	O	O	O	O	-	-	O	O	O	-	O	O	-	O
Peak-to-Average Power Ratio	LTE 12	O	O	O	O	-	-	O	O	-	-	O	O	O	O
Frequency Stability	LTE 12	O	O	O	O	-	-	O	O	O	O	O	O	O	O
Spurious Emissions at Antenna Terminals	LTE 12	O	O	O	O	-	-	O	-	O	-	-	O	O	O
Radiates Spurious Emission	LTE 12	O	-	O	O	-	-	O	-	O	-	-	-	O	-
Note	1. The mark "O" means that this configuration is chosen for testing. 2. The mark "-" means that this configuration is not testing.														

4 Test Information

4.1 RF Power Output

Ambient condition

Temperature	Relative humidity	Pressure
23°C ~25°C	45%~50%	101.5kPa

Methods of Measurement

During the process of the testing, The EUT is controlled by the Base Station Simulator to ensure max power transmission and proper modulation.

Test Setup

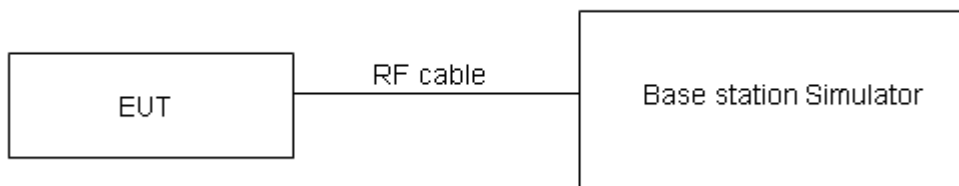

The loss between RF output port of the EUT and the input port of the tester has been taken into consideration.

Limits

No specific RF power output requirements in part 2.1046.

Measurement Uncertainty

The assessed measurement uncertainty to ensure 95% confidence level for the normal distribution is with the coverage factor $k = 2$, $U=0.4$ dB.

Test Results

LTE Band 12				AV Conducted Power(dBm)		
Bandwidth	Modulation	RB size	RB offset	Channel/Frequency (MHz)		
				23017/699.7	23095/707.5	23173/715.3
1.4MHz	QPSK	1	0	23.15	23.00	23.03
		1	2	22.96	23.16	22.99
		1	5	22.91	22.93	22.94
		3	0	22.84	22.90	22.87
		3	2	22.90	22.87	22.83
		3	3	22.93	22.89	22.84
		6	0	21.92	22.00	21.93
	16QAM	1	0	22.50	22.50	22.47
		1	2	22.79	22.74	22.78
		1	5	22.41	22.49	22.40
		3	0	22.46	22.38	22.34
		3	2	22.45	22.41	22.30
		3	3	22.42	22.39	22.32
		5	0	22.52	22.50	22.43
Bandwidth	Modulation	RB size	RB offset	Channel/Frequency (MHz)		
				23025/700.5	23095/707.5	23165/714.5
3MHz	QPSK	1	0	23.17	23.01	23.06
		1	2	22.99	23.21	23.03
		1	5	22.93	22.97	22.97
		3	0	22.87	22.95	22.91
		3	2	22.93	22.92	22.87
		3	3	22.95	22.93	22.89
		6	0	22.00	22.02	21.97
	16QAM	1	0	22.52	22.53	22.49
		1	2	22.82	22.78	22.81
		1	5	22.44	22.51	22.43
		3	0	22.49	22.43	22.38
		3	2	22.47	22.45	22.33
		3	3	22.45	22.44	22.36
		5	0	22.55	22.55	22.47
Bandwidth	Modulation	RB size	RB offset	Channel/Frequency (MHz)		
				23035/701.5	23095/707.5	23155/713.5
5MHz	QPSK	1	0	23.16	22.97	23.04
		1	2	22.97	23.20	23.00
		1	5	22.90	22.92	22.93
		3	0	22.85	22.91	22.88
		3	2	22.90	22.87	22.83
		3	3	22.92	22.90	22.85
		6	0	21.98	21.98	21.92



Bandwidth	Modulation	RB size	RB offset	Channel/Frequency (MHz)		
				23060/704	23095/707.5	23130/711
10MHz	16QAM	1	0	22.47	22.51	22.47
		1	2	22.80	22.75	22.79
		1	5	22.41	22.47	22.40
		3	0	22.46	22.41	22.35
		3	2	22.44	22.40	22.29
		3	3	22.43	22.40	22.33
		5	0	22.52	22.50	22.43
	QPSK	1	0	23.13	22.93	23.01
		1	2	22.96	23.16	22.98
		1	5	22.88	22.91	22.90
		3	0	22.82	22.86	22.84
		3	2	22.88	22.83	22.80
		3	3	22.89	22.85	22.81
		6	0	21.95	21.93	21.88
16QAM	1	0	22.45	22.47	22.42	
	1	2	22.76	22.73	22.75	
	1	5	22.39	22.44	22.38	
	3	0	22.43	22.37	22.32	
	3	2	22.41	22.38	22.26	
	3	3	22.40	22.35	22.29	
	5	0	22.50	22.46	22.40	

4.2 Effective Isotropic Radiated Power

Ambient condition

Temperature	Relative humidity	Pressure
23°C ~25°C	45%~50%	101.5kPa

Methods of Measurement

1. The testing follows FCC KDB 971168 v02r02 Section 5.8 and ANSI / TIA-603-D-2010 Section 2.2.12.

2. Above 30MHz: The EUT is placed on a turntable 0.8 meters above the ground in the chamber, 3 meter away from the antenna. The maximal emission value is acquired by adjusting the antenna height, polarisation and turntable azimuth. Normally, the height range of antenna is 1 m to 4 m, the azimuth range of turntable is 0° to 360°, and the receive antenna has two polarizations Vertical (V) and Horizontal (H). Above 1GHz: (Note: the FCC's permission to use 1.5m as an alternative per TCBC Conf call of Dec. 2, 2014.) The EUT is placed on a turntable 1.5 meters above the ground in the chamber, 3 meter away from the antenna. The maximal emission value is acquired by adjusting the antenna height, polarisation and turntable azimuth. Normally, the height range of antenna is 1 m to 4 m, the azimuth range of turntable is 0° to 360°, and the receive antenna has two polarizations Vertical (V) and Horizontal (H).

3. A log-periodic antenna or double-ridged waveguide horn antenna shall be substituted in place of the EUT. The log-periodic antenna will be driven by a signal generator and the level will be adjusted till the same power value on the spectrum analyzer or receiver. The level of the spurious emissions can be calculated through the level of the signal generator, cable loss, the gain of the substitution antenna and the reading of the spectrum analyzer or receiver.

4. The EUT is then put into continuously transmitting mode at its maximum power level during the test. Set Test Receiver or Spectrum RBW=1MHz, VBW=3MHz for above 1GHz and RBW=100kHz, VBW=300kHz for 30MHz to 1GHz, And the maximum value of the receiver should be recorded as (Pr).

5. The EUT shall be replaced by a substitution antenna. In the chamber, an substitution antenna for the frequency band of interest is placed at the reference point of the chamber. An RF Signal source for the frequency band of interest is connected to the substitution antenna with a cable that has been constructed to not interfere with the radiation pattern of the antenna. A power (PMea) is applied to the input of the substitution antenna, and adjust the level of the signal generator output until the value of the receiver reach the previously recorded (Pr). The power of signal source (PMea) is recorded. The test should be performed by rotating the test item and adjusting the receiving antenna polarization.

6. A amplifier should be connected to the Signal Source output port. And the cable should be connect between the Amplifier and the Substitution Antenna. The cable loss (Pcl) ,the Substitution Antenna Gain (Ga) and the Amplifier Gain (PAg) should be recorded after test.

7. The measurement results are obtained as described below:

$$\text{Power(EIRP)} = \text{PMea} - \text{PAg} - \text{Pcl} + \text{Ga}$$

The measurement results are amend as described below:

$$\text{Power(EIRP)} = \text{PMea} - \text{Pcl} + \text{Ga}$$

8. This value is EIRP since the measurement is calibrated using an antenna of known gain (2.15 dBi)

and known input power. ERP can be calculated from EIRP by subtracting the gain of the dipole, $ERP = EIRP - 2.15\text{dBi}$.

Test setup

30MHz~~~ 1GHz

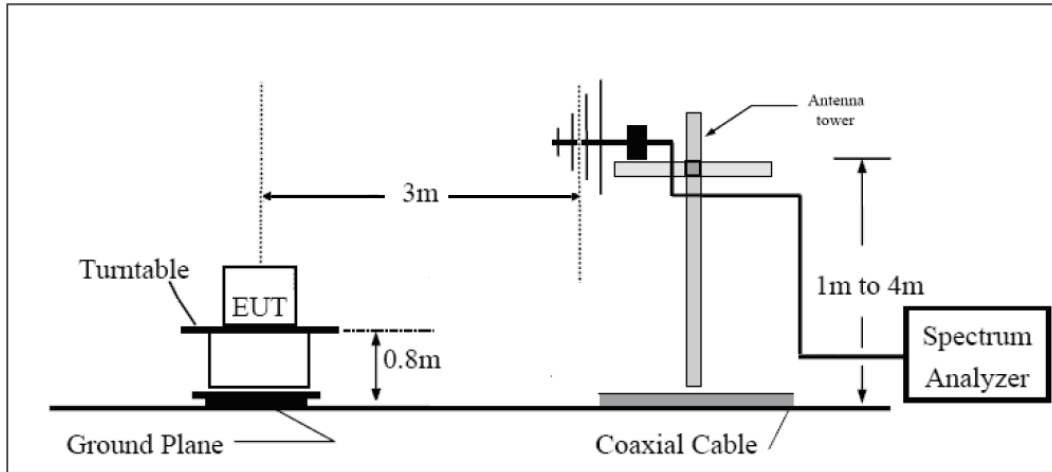

Above 1GHz

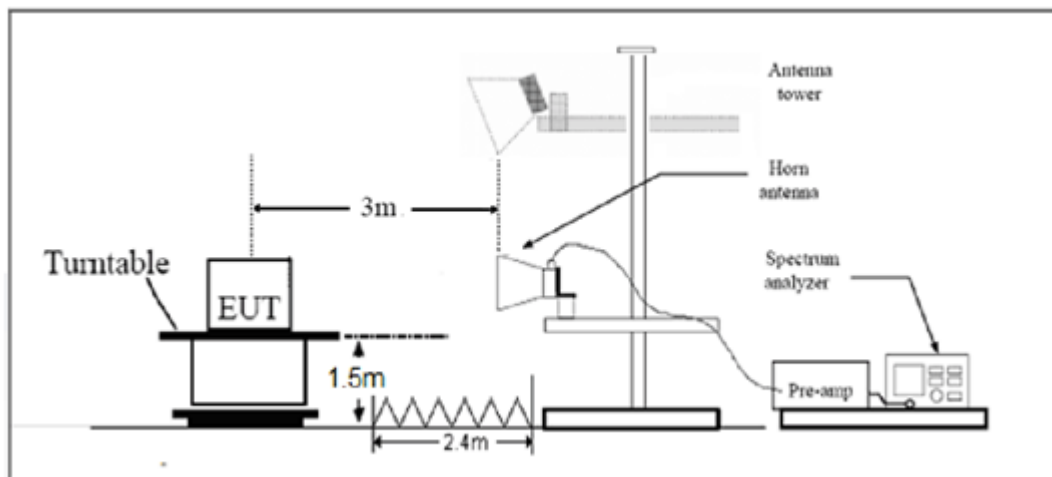

Note: Area side:2.4mX3.6m

The radiated emission was measured in the following position: EUT stand-up position (Z axis), lie-down position (X, Y axis). The worst emission was found in stand-up position (Z axis) and the worst case was recorded.

**Limits**

Rule Part 27.50(c) (10) specifies that “Portable stations (hand-held devices) in the 600 MHz uplink band and the 698-746 MHz band, and fixed and mobile stations in the 600 MHz uplink band are limited to 3 watts ERP”

Part 27.50(c)(10)Limit	$\leq 3 \text{ W}$ (34.77 dBm)
------------------------	--------------------------------

Measurement Uncertainty

The assessed measurement uncertainty to ensure 95% confidence level for the normal distribution is with the coverage factor $k = 2$, $U = 1.19 \text{ dB}$



Test Results

LTE Band 12						
Bandwidth	Channel	Frequency (MHz)	Polarization	ERP (dBm)	Limit (dBm)	Conclusion
1.4 MHz (QPSK)	Low	699.7	Horizontal	20.56	34.77	Pass
	Mid	707.5	Horizontal	20.79	34.77	Pass
	High	715.3	Horizontal	20.54	34.77	Pass
3 MHz (QPSK)	Low	700.5	Horizontal	20.58	34.77	Pass
	Mid	707.5	Horizontal	20.69	34.77	Pass
	High	714.5	Horizontal	20.48	34.77	Pass
5 MHz (QPSK)	Low	701.5	Horizontal	20.44	34.77	Pass
	Mid	707.5	Horizontal	20.59	34.77	Pass
	High	713.5	Horizontal	20.50	34.77	Pass
10 MHz (QPSK)	Low	704	Horizontal	20.64	34.77	Pass
	Mid	707.5	Horizontal	20.73	34.77	Pass
	High	711	Horizontal	20.61	34.77	Pass
1.4 MHz (16QAM)	Low	699.7	Horizontal	20.11	34.77	Pass
	Mid	707.5	Horizontal	20.30	34.77	Pass
	High	715.3	Horizontal	20.06	34.77	Pass
3 MHz (16QAM)	Low	700.5	Horizontal	20.13	34.77	Pass
	Mid	707.5	Horizontal	20.19	34.77	Pass
	High	714.5	Horizontal	20.01	34.77	Pass
5 MHz (16QAM)	Low	701.5	Horizontal	19.90	34.77	Pass
	Mid	707.5	Horizontal	20.13	34.77	Pass
	High	713.5	Horizontal	19.98	34.77	Pass
10 MHz (16QAM)	Low	704	Horizontal	20.12	34.77	Pass
	Mid	707.5	Horizontal	20.20	34.77	Pass
	High	711	Horizontal	20.04	34.77	Pass

4.3 Occupied Bandwidth

Ambient condition

Temperature	Relative humidity	Pressure
23°C ~25°C	45%~50%	101.5kPa

Method of Measurement

The EUT was connected to Spectrum Analyzer and Base Station Simulator via power Splitter. The occupied bandwidth is measured using spectrum analyzer.

RBW is set to 51 kHz, VBW is set to 160 kHz for LTE Band 4 (1.4MHz).

RBW is set to 100 kHz, VBW is set to 300 kHz for LTE Band 4 (3MHz).

RBW is set to 100 kHz, VBW is set to 300 kHz for LTE Band 4/13 (5MHz).

RBW is set to 300 kHz, VBW is set to 1MHz for LTE Band 4/13 (10MHz).

RBW is set to 300 kHz, VBW is set to 1MHz for LTE Band 4 (15MHz/20MHz).

RBW is set to 51 kHz, VBW is set to 160 kHz for LTE Band 12 (1.4MHz/3MHz/5MHz/10MHz).

99% power and -26dBc occupied bandwidths are recorded. Spectrum analyzer plots are included on the following pages.

Test Setup

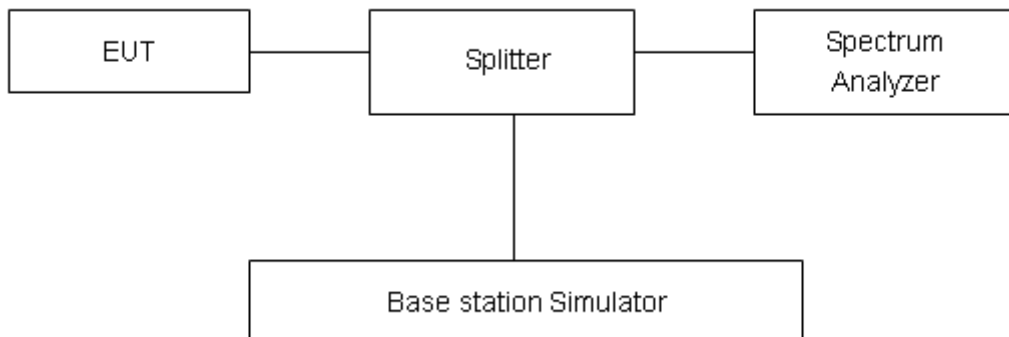

Limits

No specific occupied bandwidth requirements in part 2.1049.

Measurement Uncertainty

The assessed measurement uncertainty to ensure 95% confidence level for the normal distribution is with the coverage factor $k = 2$, $U=624\text{Hz}$.



Test Result

Variant

Mode	Bandwidth	Modulation	Channel/ Frequency(MHz)	RB	Index	Bandwidth(MHz)	
						99% Power	-26dBc
Band12	1.4MHz	QPSK	23095/707.5	6#0	0	1.1034	1.331
		16QAM	23095/707.5	6#0	0	0.9475	1.214
	3MHz	QPSK	23095/707.5	6#0	0	1.174	2.338
		16QAM	23095/707.5	6#0	0	0.9771	1.307
	5MHz	QPSK	23095/707.5	6#0	0	1.1589	2.072
		16QAM	23095/707.5	6#0	0	1.1263	2.008
10MHz	QPSK	23095/707.5	6#0	0	1.2324	2.35	
	16QAM	23095/707.5	6#0	0	1.0727	1.578	

LTE Band 12 QPSK 1.4MHz CH-Middle

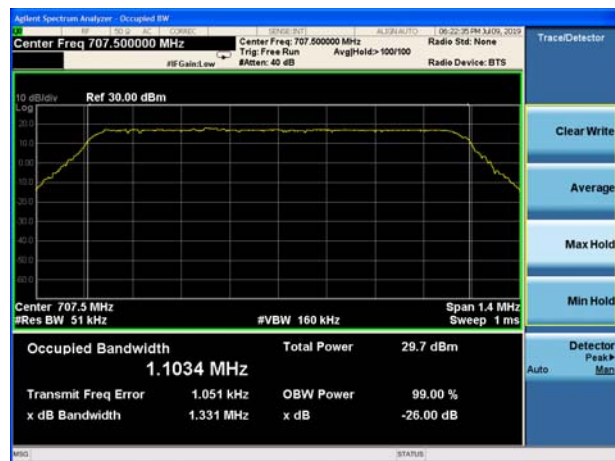

LTE Band 12 QPSK 3MHz CH-Middle

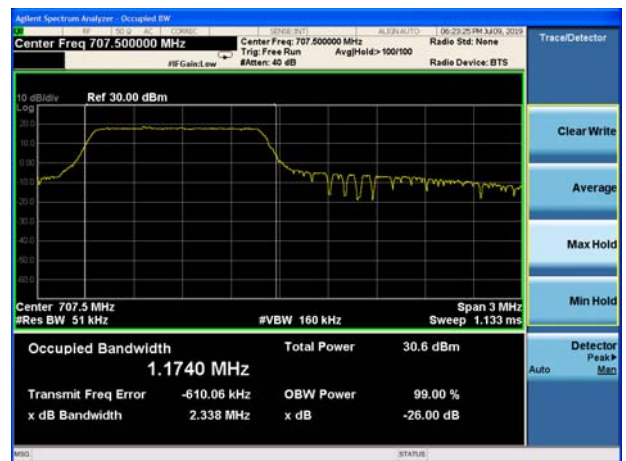

LTE Band 12 QPSK 5MHz CH-Middle



LTE Band 12 QPSK 10MHz CH-Middle





LTE Band 12 16QAM 1.4MHz CH-Middle



LTE Band 12 16QAM 3MHz CH-Middle



LTE Band 12 16QAM 5MHz CH-Middle



LTE Band 12 16QAM 10MHz CH-Middle



4.4 Band Edge Compliance

Ambient condition

Temperature	Relative humidity	Pressure
23°C ~25°C	45%~50%	101.5kPa

Method of Measurement

The EUT was connected to Spectrum Analyzer and Base Station Simulator via power Splitter. The band edge of the lowest and highest channels were measured.

The testing follows KDB 971168 v02r02 Section 6.0

- 1.The EUT was connected to spectrum analyzer and system simulator via a power divider.
2. The band edges of low and high channels for the highest RF powers were measured.
3. For LTE Band 41 Set RBW \geq 1% EBW in the 1MHz band immediately outside and adjacent to the band edge. Beyond the 1 MHz band from the band edge, RBW=1MHz was used.
 RBW is set to 15 kHz, VBW is set to 51 kHz for LTE Band 4 (1.4MHz).
 RBW is set to 30 kHz, VBW is set to 100 kHz for LTE Band 4 (3MHz).
 RBW is set to 51 kHz, VBW is set to 160 kHz for LTE Band 4/13 (5MHz).
 RBW is set to 100 kHz, VBW is set to 300kHz for LTE Band 4/13 (10MHz).
 RBW is set to 150 kHz, VBW is set to 510 kHz for LTE Band 4 (15MHz).
 RBW is set to 200 kHz, VBW is set to 620 kHz for LTE Band 4 (20MHz)
 RBW is set to 51 kHz, VBW is set to 160 kHz for LTE Band 12 (1.4MHz/3MHz/5MHz/10MHz). on spectrum analyzer.
4. Set spectrum analyzer with RMS detector.
5. The RF fundamental frequency should be excluded against the limit line in the operating frequency band.
6. Checked that all the results comply with the emission limit line.

Test Setup

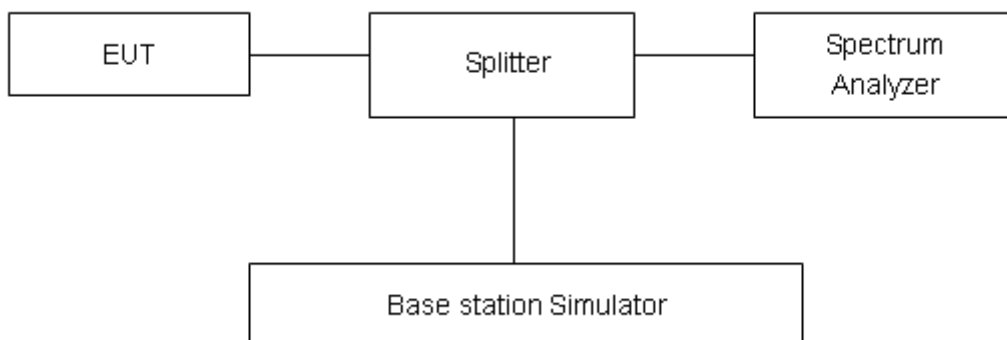

**Limits**

Hz band, the power of any emission outside a licensee's frequency block shall be attenuated below the transmitter power (P) within the licensed band(s) of operation, measured in watts, by at least $43 + 10 \log_{10}(P)$ dB."

Measurement Uncertainty

The assessed measurement uncertainty to ensure 95% confidence level for the normal distribution is with the coverage factor $k = 1.96$, $U=0.684$ dB.

Test Result

All the test traces in the plots shows the test results clearly.

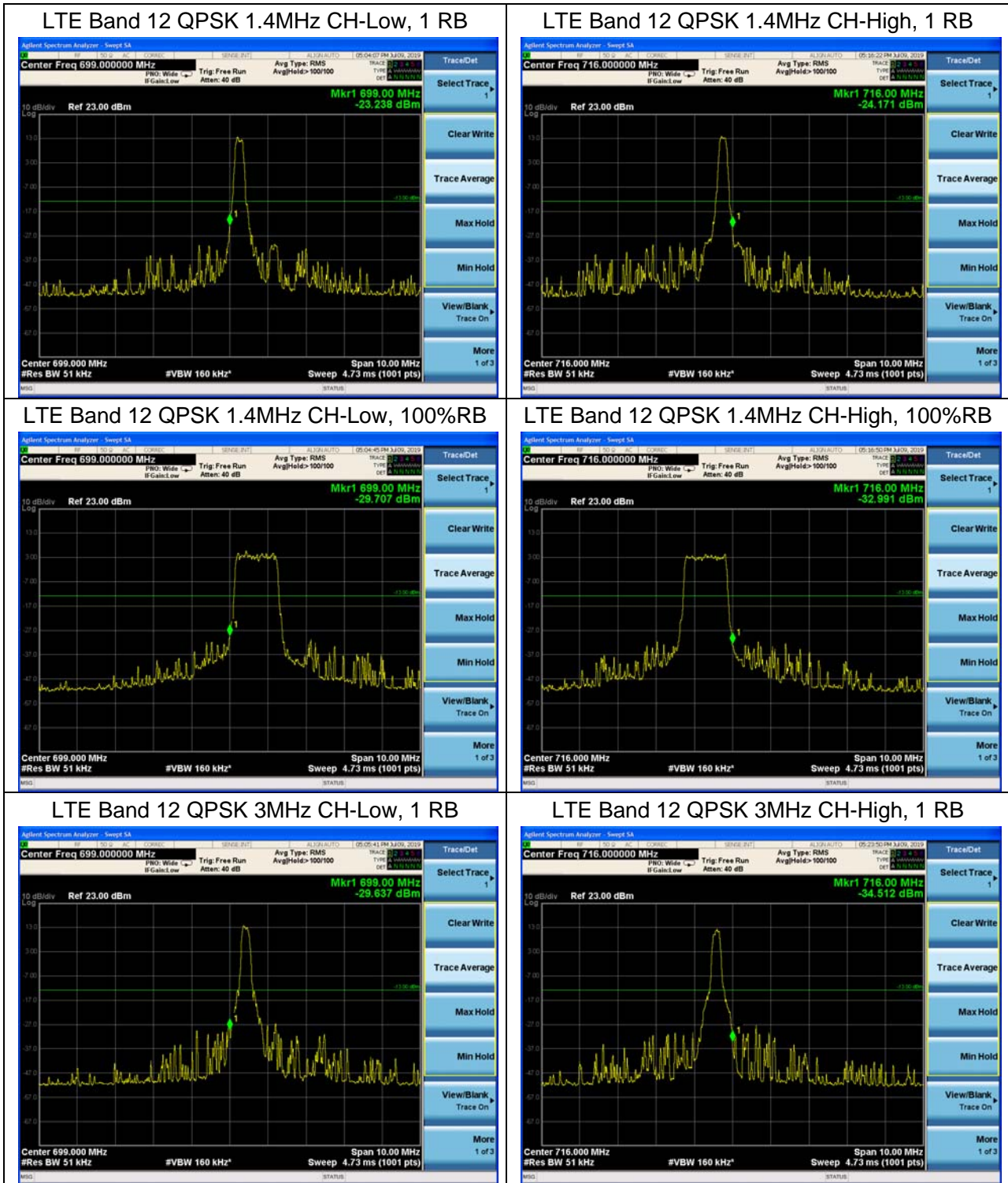

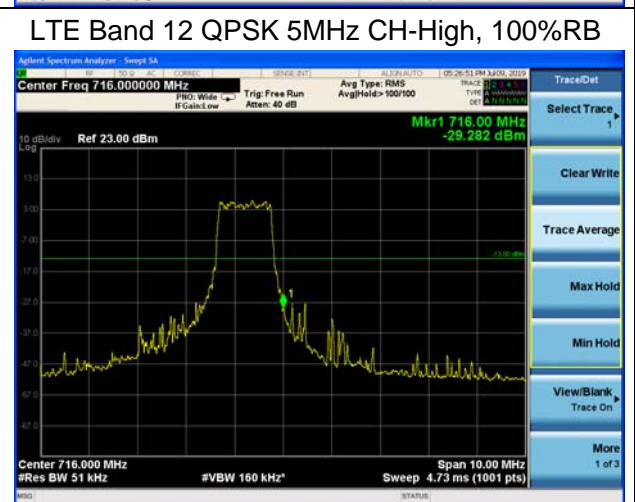
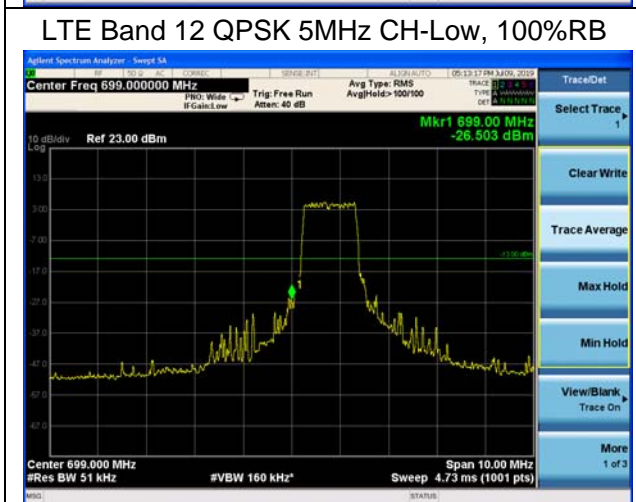
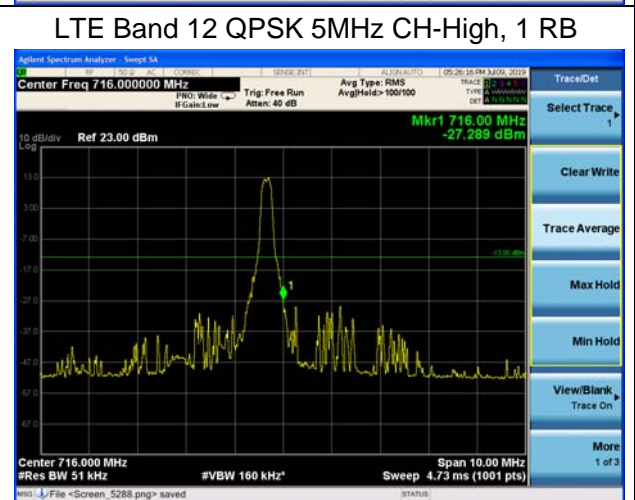
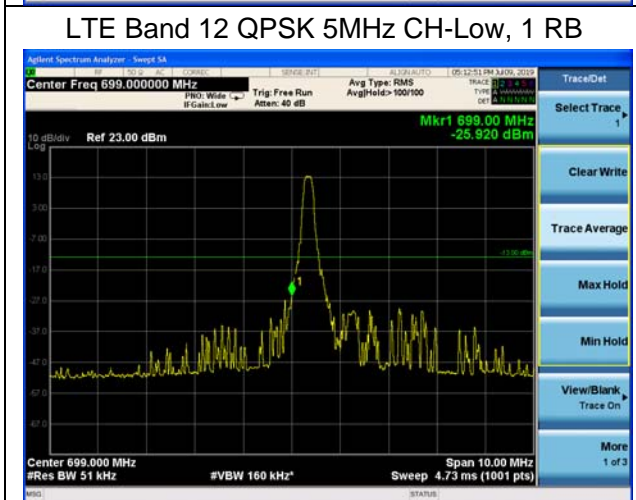
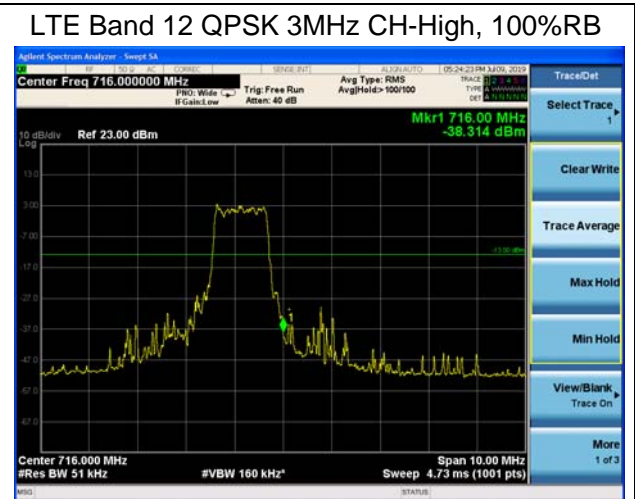
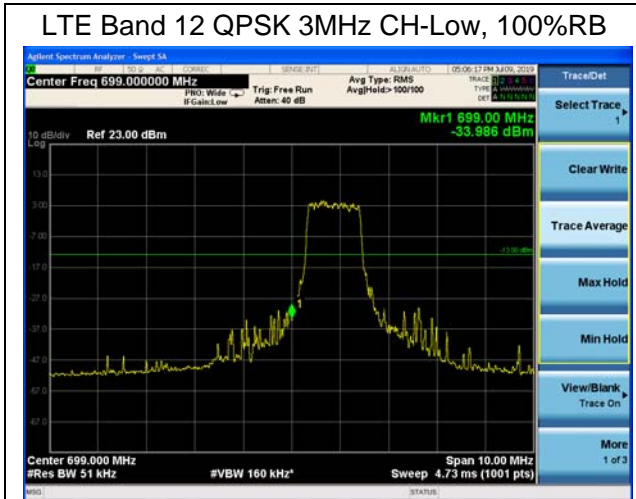

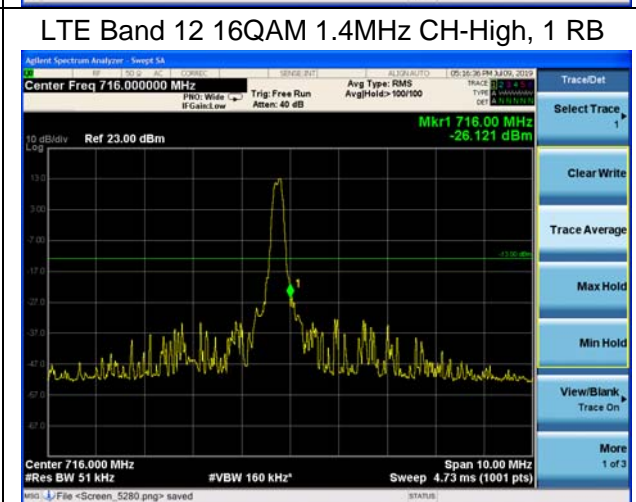
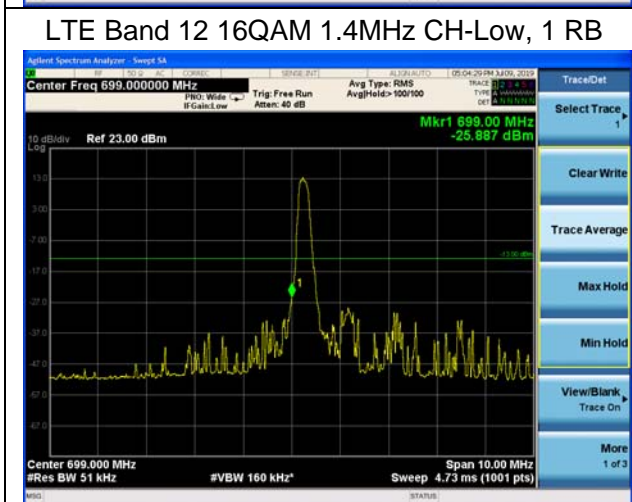
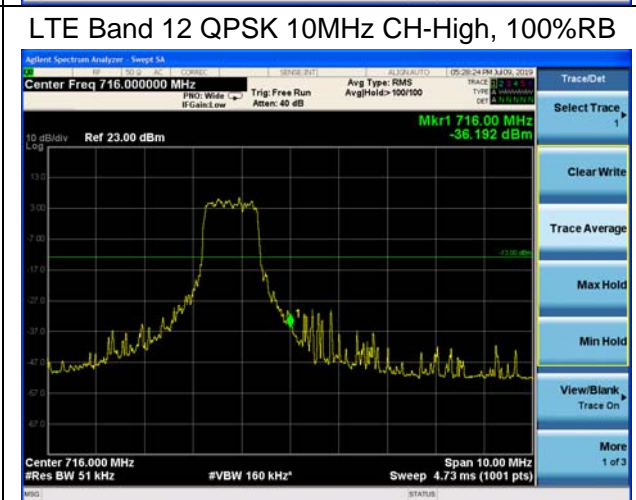
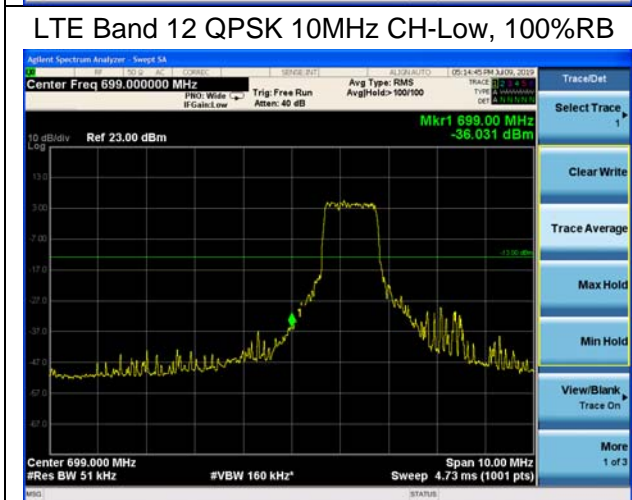
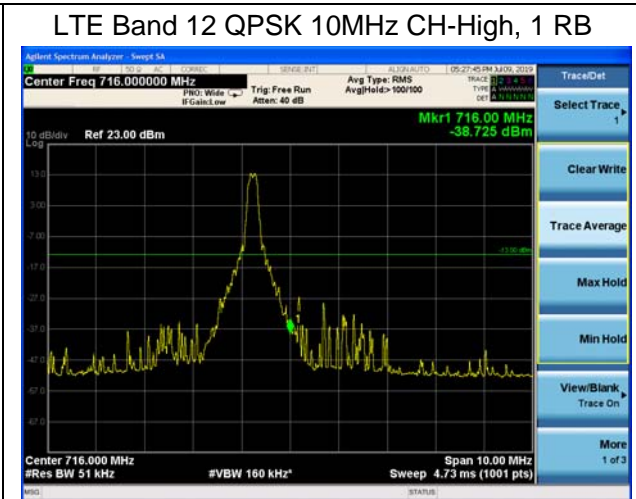
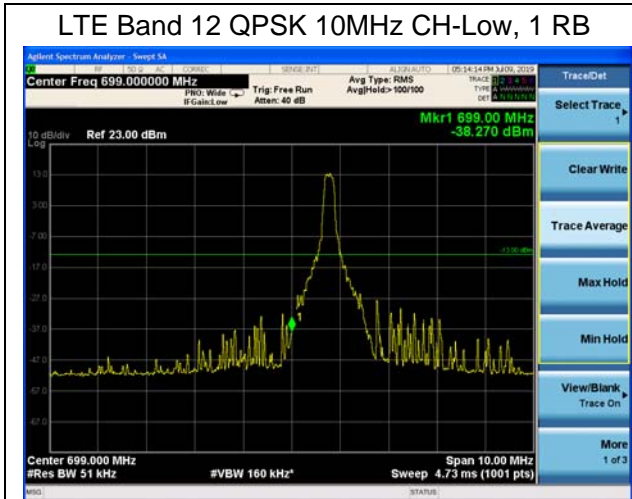

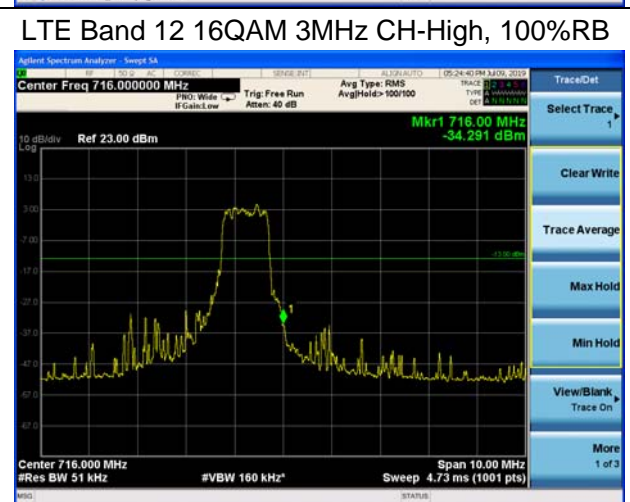
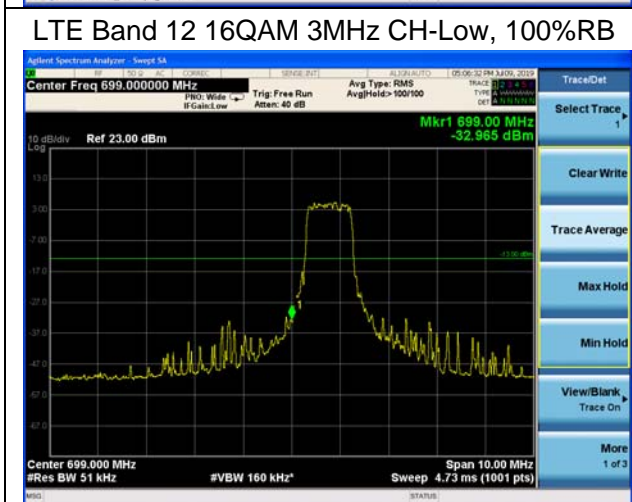
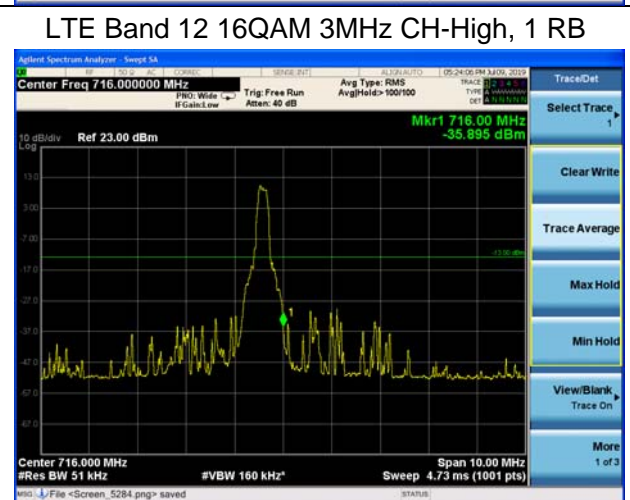
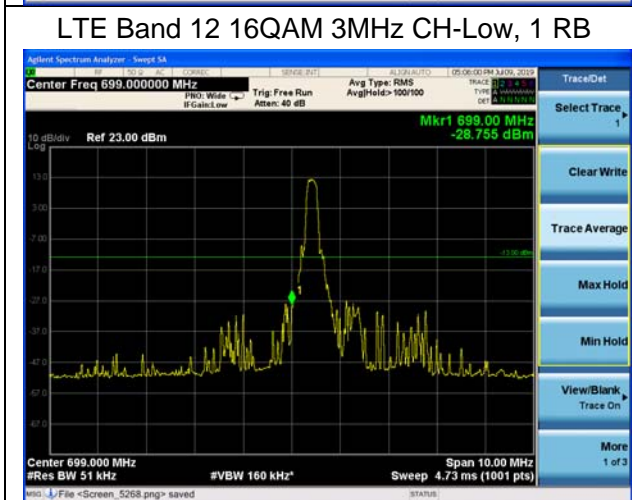
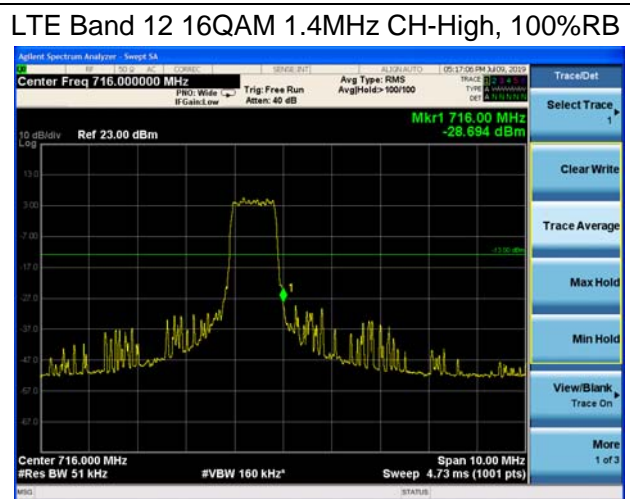
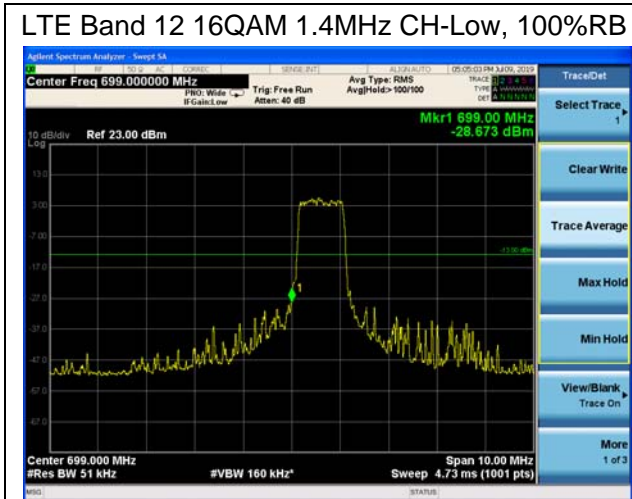

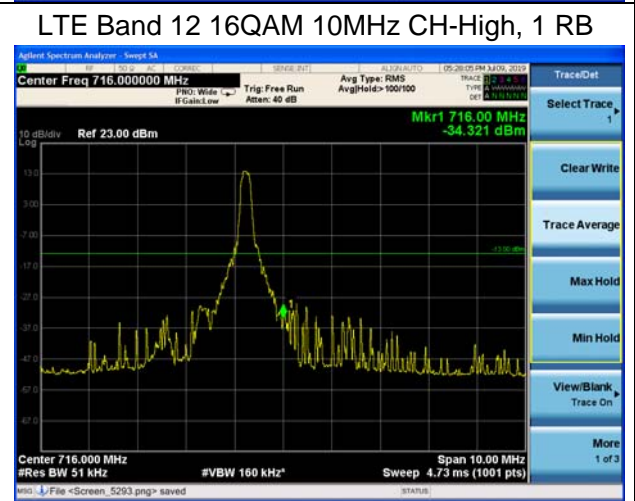
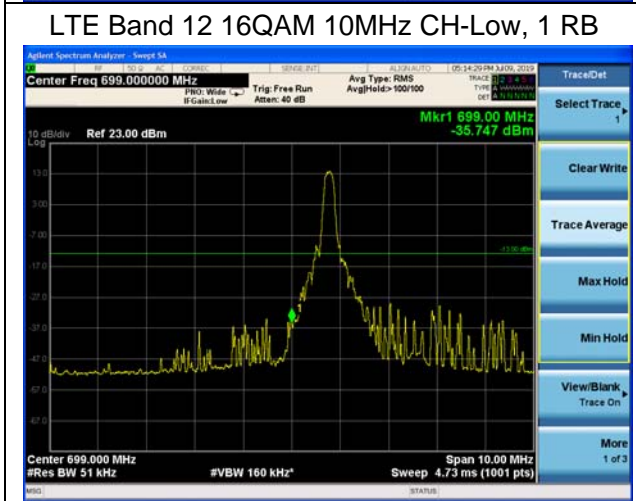
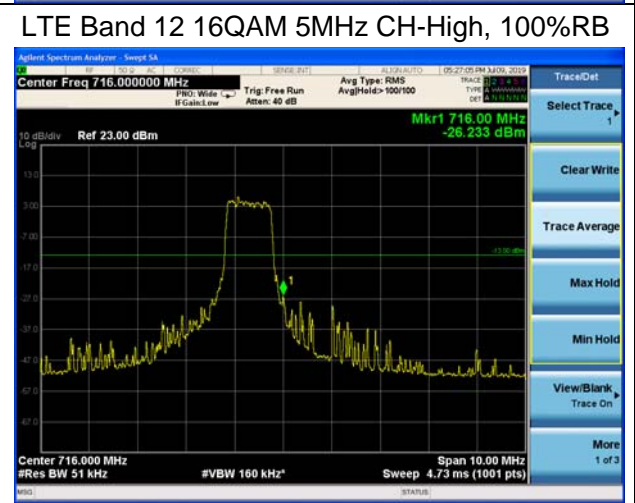
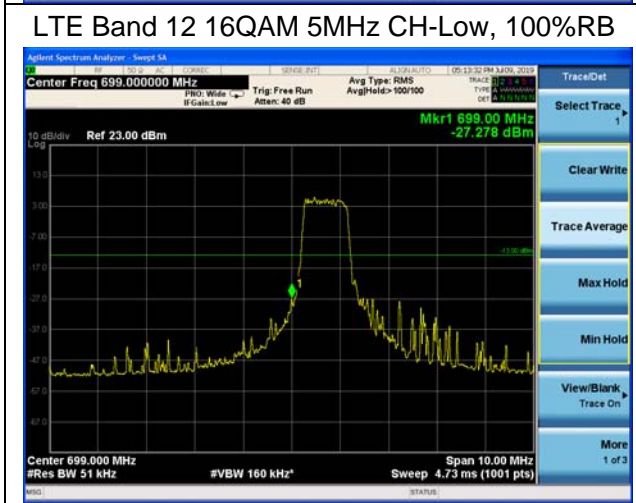
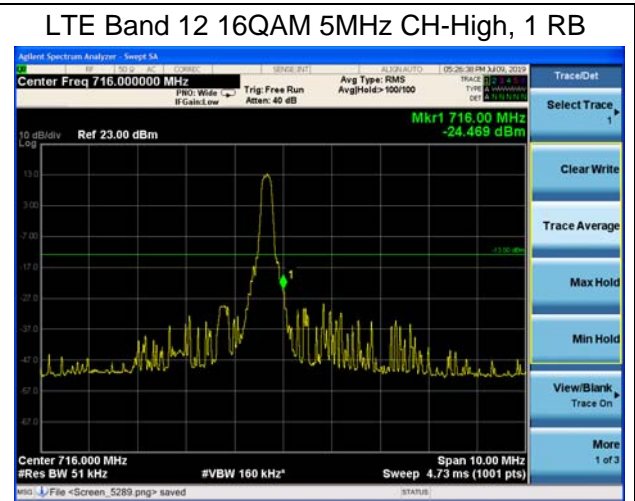
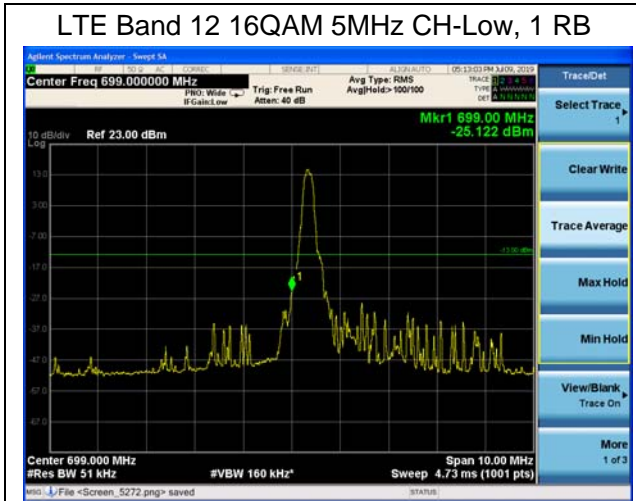

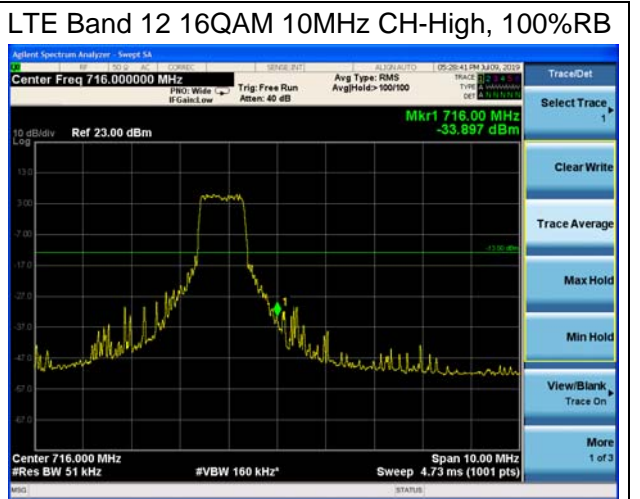
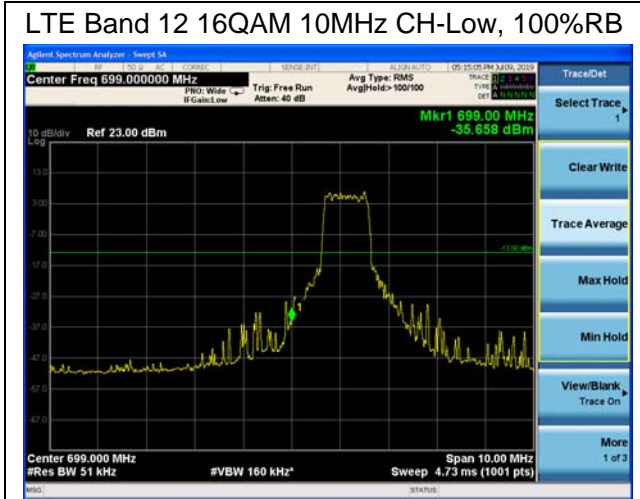

4.5 Peak-to-Average Power Ratio (PAPR)

Ambient condition

Temperature	Relative humidity	Pressure
23°C ~25°C	45%~50%	101.5kPa

Methods of Measurement

Measure the total peak power and record as PPk. And measure the total average power and record as PAvg. Both the peak and average power levels must be expressed in the same logarithmic units (e.g., dBm). Determine the PAPR from:

$$PAPR (dB) = PPk (dBm) - PAvg (dBm).$$

Test Setup

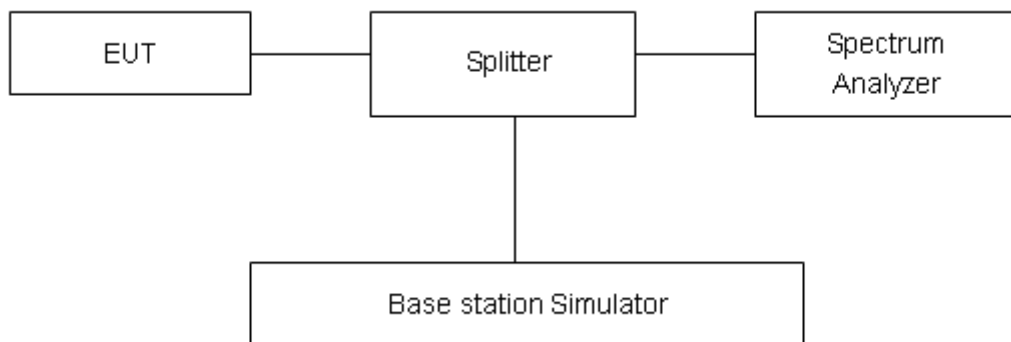

Limits

Rule Part 27.50(d)(5) Equipment employed must be authorized in accordance with the provisions of 24.51. Power measurements for transmissions by stations authorized under this section may be made either in accordance with a Commission-approved average power technique or in compliance with paragraph (d)(6) of this section. In measuring transmissions in this band using an average power technique, the peak-to-average ratio (PAR) of the transmission may not exceed 13 dB.

Measurement Uncertainty

The assessed measurement uncertainty to ensure 95% confidence level for the normal distribution is with the coverage factor k = 2, U= 0.4 dB.

**Test Results****Variant**

Mode	Bandwidth	Modulation	Channel/ Frequency(MHz)	Peak-to-Average Power Ratio (PAPR)		
				Peak(dBm)	Avg(dBm)	PAPR(dB)
Band12	1.4MHz	QPSK	23095/707.5	26.04	16.58	9.46
		16QAM	23095/707.5	26.88	16.35	10.53
	3MHz	QPSK	23095/707.5	25.92	15.65	10.27
		16QAM	23095/707.5	26.79	16.18	10.61
	5MHz	QPSK	23095/707.5	27.06	17.45	9.61
		16QAM	23095/707.5	27.06	16.16	10.90
	10MHz	QPSK	23095/707.5	27.11	18.09	9.02
		16QAM	23095/707.5	27.77	18.17	9.60

4.6 Frequency Stability

Ambient condition

Temperature	Relative humidity	Pressure
23°C ~25°C	45%~50%	101.5kPa

Method of Measurement

1. Frequency Stability (Temperature Variation)

The temperature inside the climate chamber is varied from -40°C to +85°C in 10°C step size.

(1) With all power removed, the temperature was decreased to -10°C and permitted to stabilize for three hours.

(2) Measure the carrier frequency with the test equipment in a “call mode”. These measurements should be made within 1 minute of powering up the mobile station, to prevent significant self warming.

(3) Repeat the above measurements at 10°C increments from -40°C to +85°C. Allow at least 1.5 hours at each temperature, un-powered, before making measurements.

2. Frequency Stability (Voltage Variation)

The frequency stability shall be measured with variation of primary supply voltage as follows:

(1) Vary primary supply voltage from 85 to 115 percent of the nominal value for other than hand carried battery equipment.

(2) For hand carried, battery powered equipment, reduce primary supply voltage to the battery-operating end point which shall be specified by the manufacturer.

This transceiver is specified to operate with an input voltage of between 3.3 V and 4.3 V, with a nominal voltage of 3.8V.

Test setup

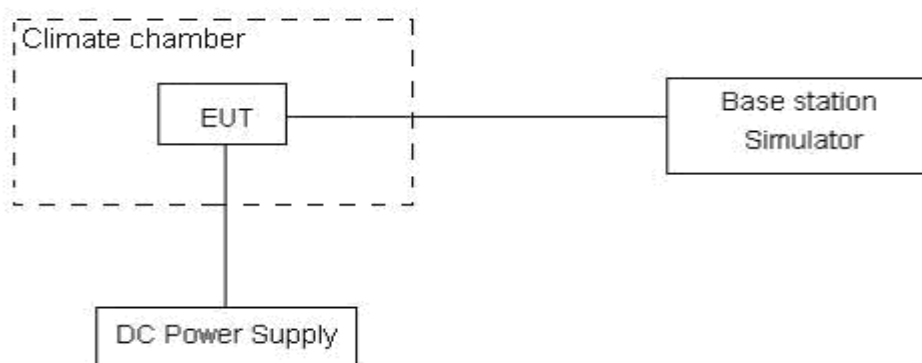

Limits

No specific frequency stability requirements in part 27.54

Measurement Uncertainty

The assessed measurement uncertainty to ensure 99.75% confidence level for the normal distribution is with the coverage factor $k = 3, U=0.01\text{ppm}$.

Test Result

LTE Band 12(BANDWIDTH, 10MHz)						
Condition		Freq.Error (Hz)	Freq.Error (Hz)	Frequency Stability (ppm)	Frequency Stability (ppm)	Verdict
BANDWIDTH	10MHz	16QAM	QPSK	16QAM	QPSK	
Temperature	Voltage	16QAM	QPSK	16QAM	QPSK	
Normal (25℃)	Normal	1.72	13.22	0.00091	0.00703	PASS
Extreme (85℃)		1.69	8.52	0.00090	0.00453	PASS
Extreme (80℃)		3.93	16.58	0.00209	0.00882	PASS
Extreme (70℃)		11.86	1.22	0.00631	0.00065	PASS
Extreme (60℃)		10.05	16.20	0.00535	0.00862	PASS
Extreme (50℃)		10.28	9.45	0.00547	0.00503	PASS
Extreme (40℃)		10.05	8.74	0.00535	0.00465	PASS
Extreme (30℃)		2.62	9.89	0.00140	0.00526	PASS
Extreme (20℃)		16.54	1.66	0.00880	0.00088	PASS
Extreme (10℃)		17.56	11.57	0.00934	0.00615	PASS
Extreme (0℃)		4.41	9.03	0.00235	0.00480	PASS
Extreme (-10℃)		1.99	14.86	0.00106	0.00790	PASS
Extreme (-20℃)		13.79	15.88	0.00733	0.00845	PASS
Extreme (-30℃)		14.75	3.50	0.00785	0.00186	PASS
Extreme (-40℃)		5.88	13.32	0.00313	0.00709	PASS
25℃	LV	4.43	13.76	0.00236	0.00732	PASS
	HV	15.99	2.45	0.00851	0.00130	PASS

4.7 Spurious Emissions at Antenna Terminals

Ambient condition

Temperature	Relative humidity	Pressure
23°C ~25°C	45%~50%	101.5kPa

Method of Measurement

The EUT was connected to Spectrum Analyzer and Base Station Simulator via power Splitter. The measurement is carried out using a spectrum analyzer. The spectrum analyzer scans from 30MHz to the 10th harmonic of the carrier. The peak detector is used. RBW and VBW are set to 100 kHz for the carrier frequency, or RBW and VBW are set to 1MHz (other frequency), Sweep is set to ATUO. Of those disturbances below (limit – 20 dB), the mark is not required for the EUT.

Test setup

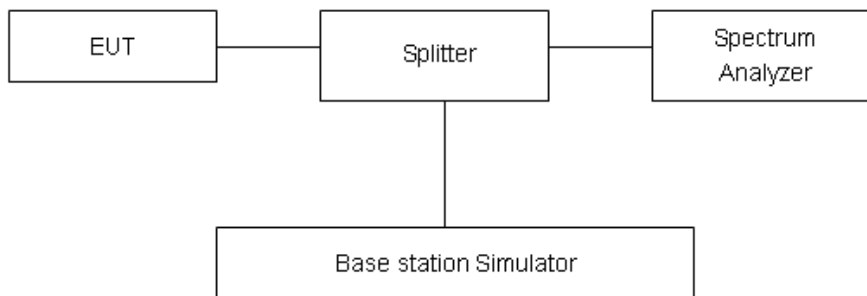

Limits

Rule Part 27.53 (g) For operations in the 600 MHz band and the 698-746 MHz band, the power of any emission outside a licensee's frequency band(s) of operation shall be attenuated below the transmitter power (P) within the licensed band(s) of operation, measured in watts, by at least 43 + 10 log (P) dB. Compliance with this provision is based on the use of measurement instrumentation employing a resolution bandwidth of 100 kilohertz or greater. However, in the 100 kilohertz bands immediately outside and adjacent to a licensee's frequency block, a resolution bandwidth of at least 30 kHz may be employed.

Limit	-13 dBm
-------	---------

Measurement Uncertainty

The assessed measurement uncertainty to ensure 99.75% confidence level for the normal distribution is with the coverage factor $k = 1.96$.

Frequency	Uncertainty
100kHz-2GHz	0.684 dB
2GHz-18GHz	1.407 dB

Test Result: PASS

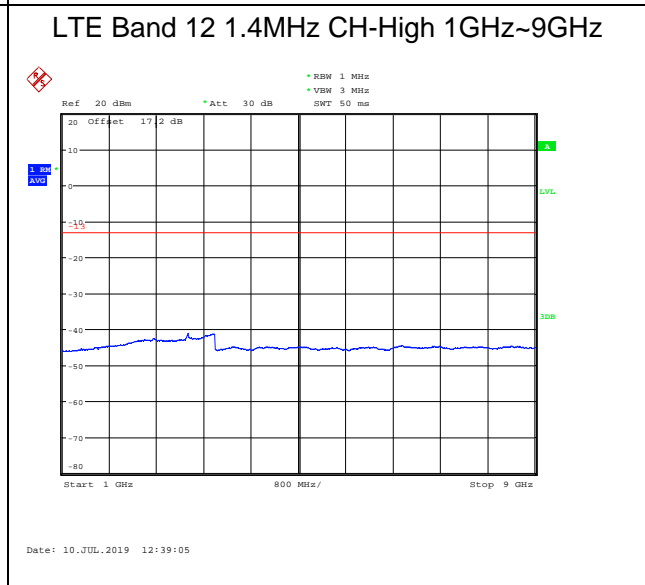
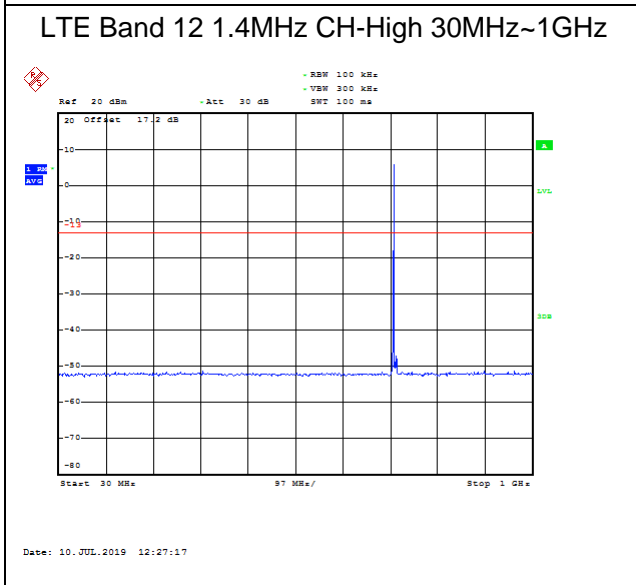
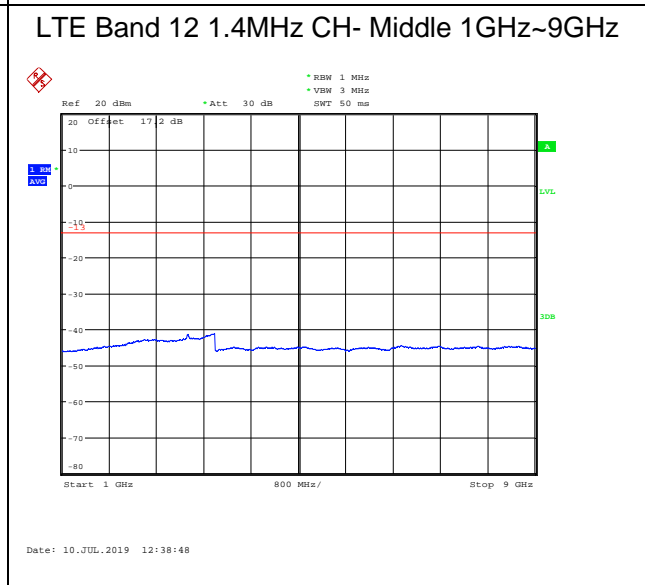
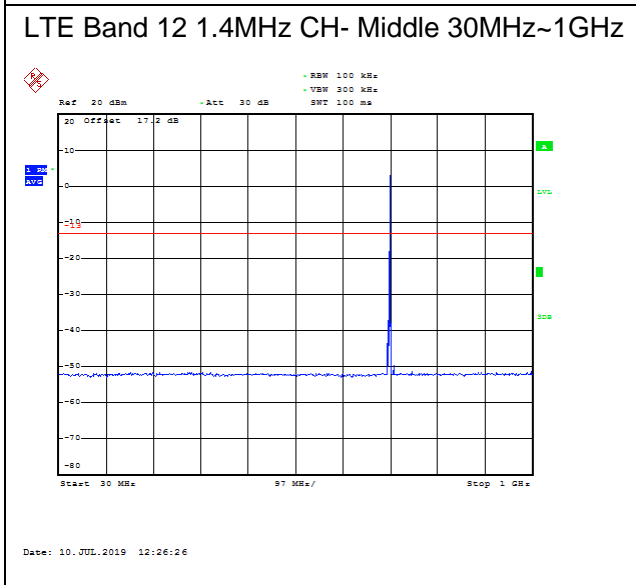
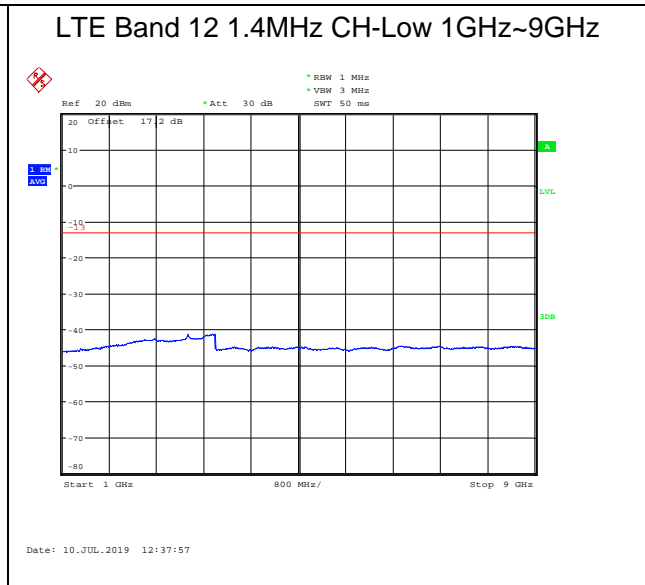
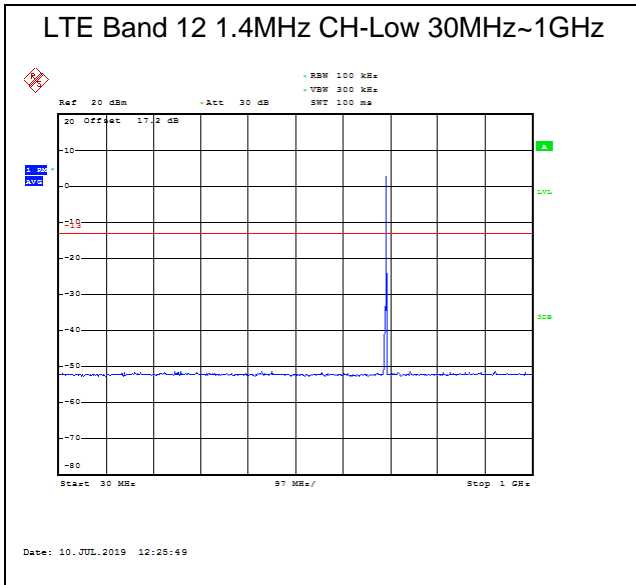



LTE Band 12 3MHz CH-Low 30MHz~1GHz

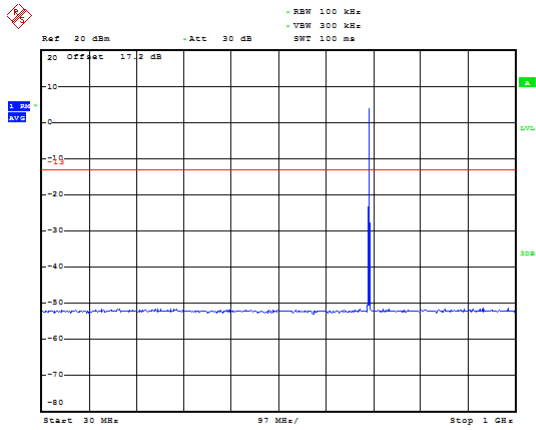

Date: 10.JUL.2019 12:30:03

LTE Band 12 3MHz CH-Low 1GHz~9GHz

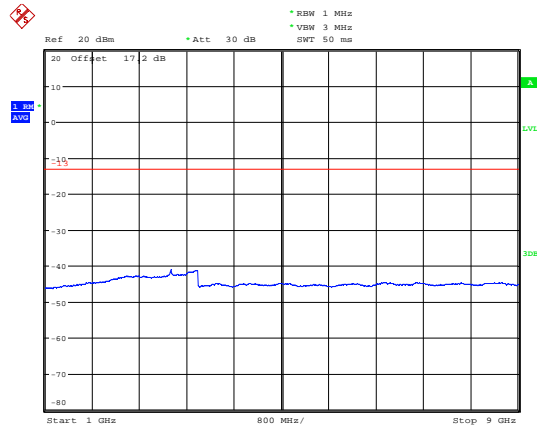

Date: 10.JUL.2019 12:40:02

LTE Band 12 3MHz CH- Middle 30MHz~1GHz

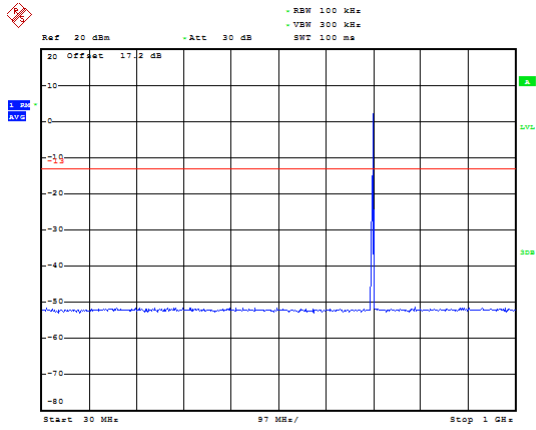

Date: 10.JUL.2019 12:30:32

LTE Band 12 3MHz CH- Middle 1GHz~9GHz

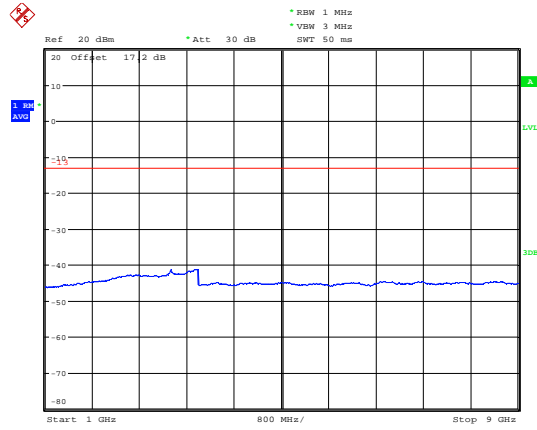

Date: 10.JUL.2019 12:40:35

LTE Band 12 3MHz CH-High 30MHz~1GHz

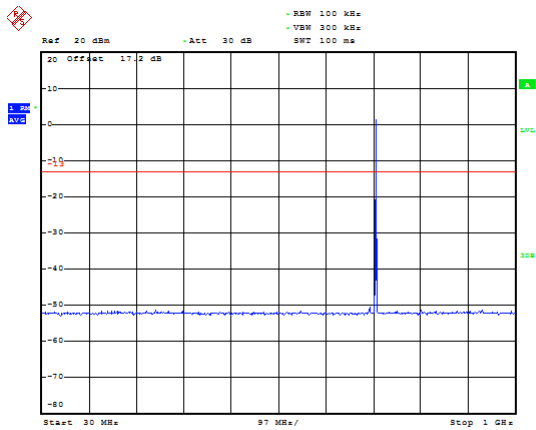

Date: 10.JUL.2019 12:31:28

LTE Band 12 3MHz CH-High 1GHz~9GHz

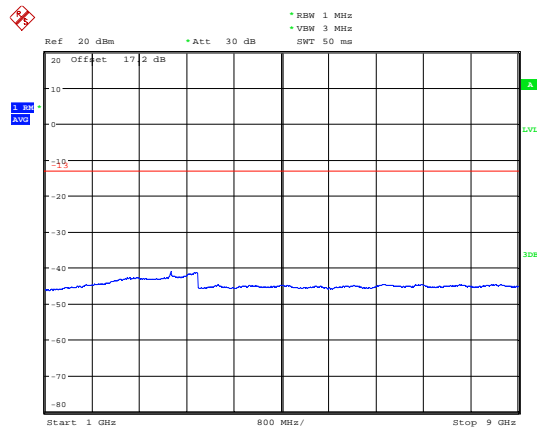

Date: 10.JUL.2019 12:40:54



LTE Band 12 5MHz CH-Low 30MHz~1GHz

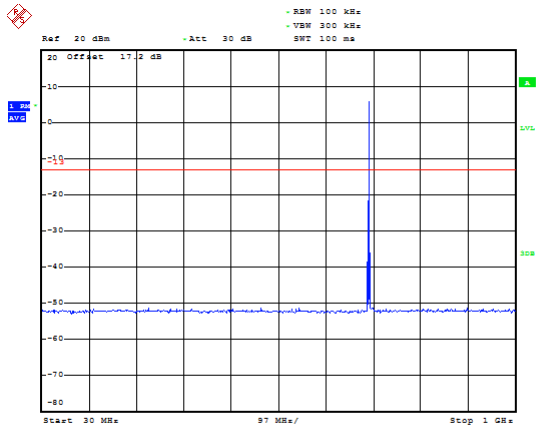

Date: 10.JUL.2019 12:32:18

LTE Band 12 5MHz CH-Low 1GHz~9GHz

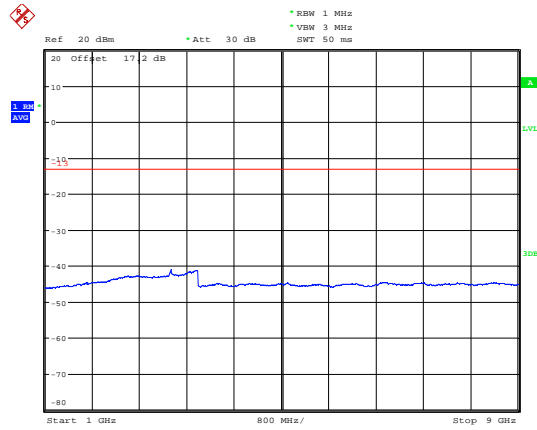

Date: 10.JUL.2019 12:41:10

LTE Band 12 5MHz CH- Middle 30MHz~1GHz

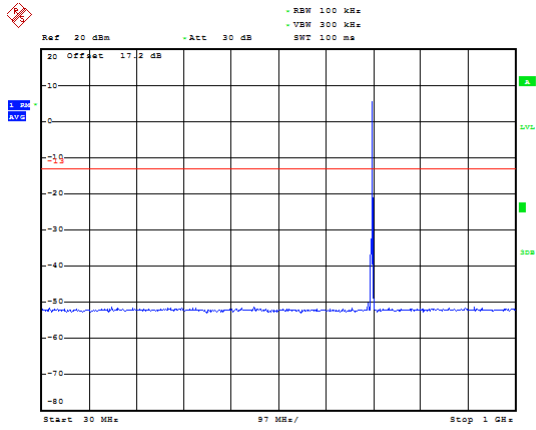

Date: 10.JUL.2019 12:32:48

LTE Band 12 5MHz CH- Middle 1GHz~9GHz

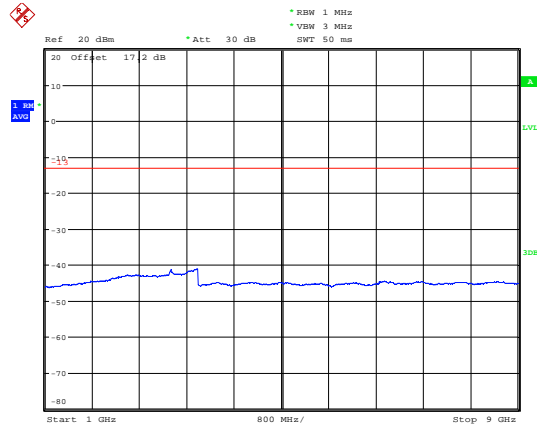

Date: 10.JUL.2019 12:41:37

LTE Band 12 5MHz CH-High 30MHz~1GHz

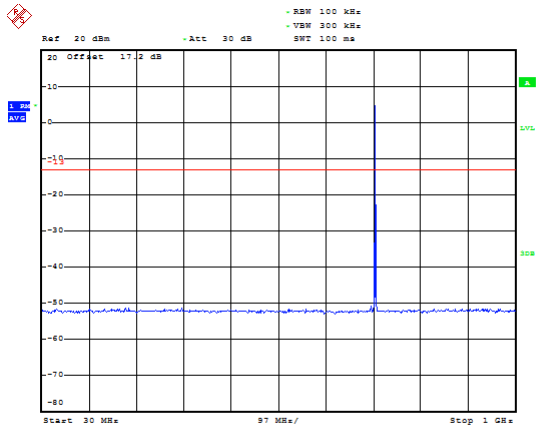

Date: 10.JUL.2019 12:33:19

LTE Band 12 5MHz CH-High 1GHz~9GHz

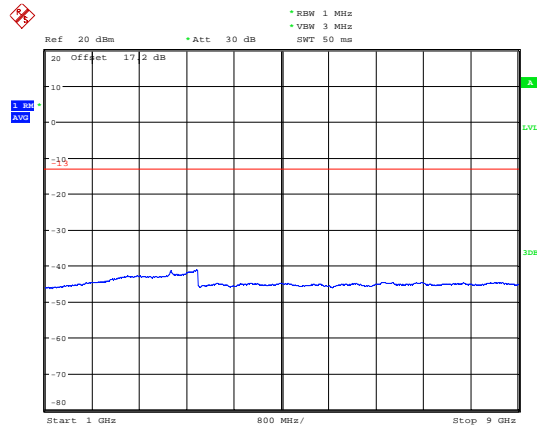

Date: 10.JUL.2019 12:42:08



LTE Band 12 10MHz CH-Low 30MHz~1GHz

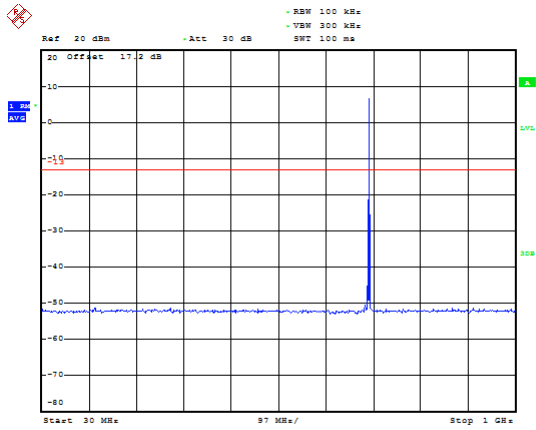

Date: 10.JUL.2019 12:34:00

LTE Band 12 10MHz CH-Low 1GHz~9GHz

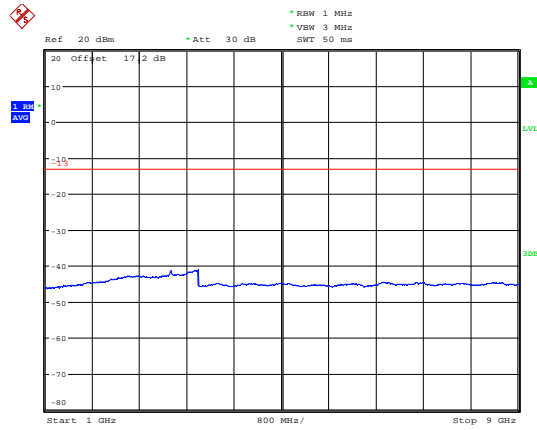

Date: 10.JUL.2019 12:36:57

LTE Band 12 10MHz CH- Middle 30MHz~1GHz

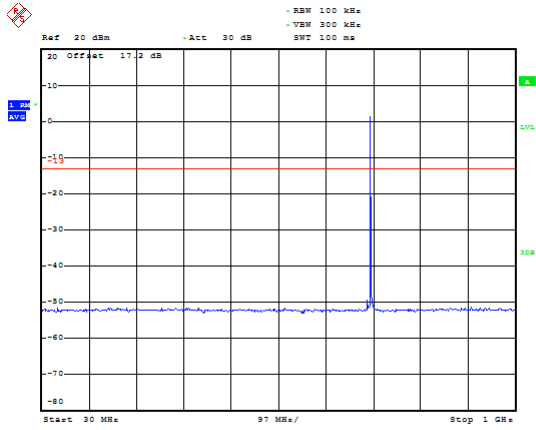

Date: 10.JUL.2019 12:34:35

LTE Band 12 10MHz CH- Middle 1GHz~9GHz

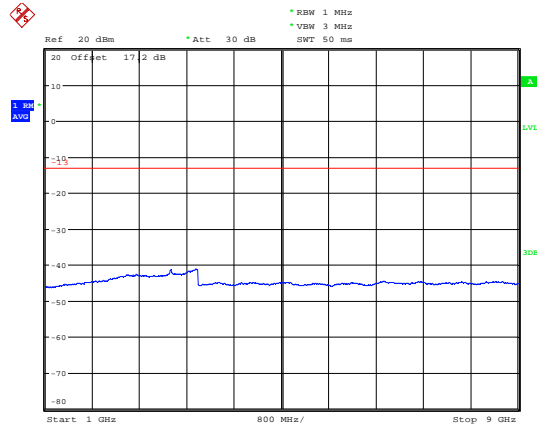

Date: 10.JUL.2019 12:37:30

LTE Band 12 10MHz CH-High 30MHz~1GHz

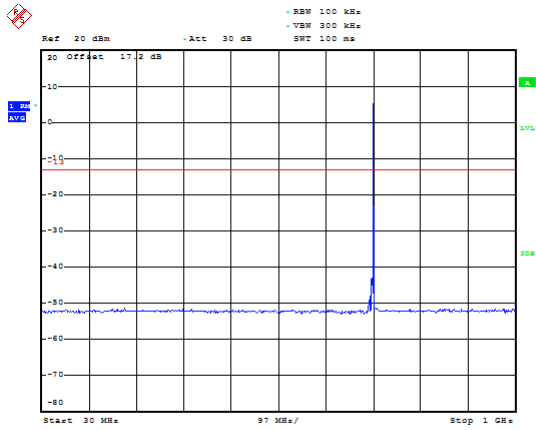

Date: 10.JUL.2019 12:35:40

LTE Band 12 10MHz CH-High 1GHz~9GHz

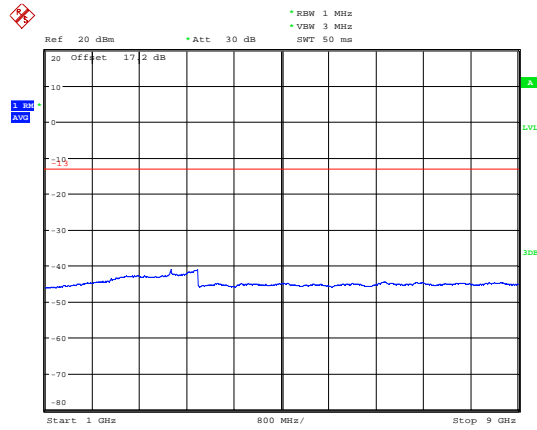

Date: 10.JUL.2019 12:36:25

4.8 Radiates Spurious Emission

Ambient condition

Temperature	Relative humidity	Pressure
23°C ~25°C	45%~50%	101.5kPa

Method of Measurement

1. The testing follows FCC KDB 971168 v02r02 Section 5.8 and ANSI / TIA-603-D-2010 Section 2.2.12.
2. Above 30MHz: The EUT is placed on a turntable 0.8 meters above the ground in the chamber, 3 meter away from the antenna. The maximal emission value is acquired by adjusting the antenna height, polarisation and turntable azimuth. Normally, the height range of antenna is 1 m to 4 m, the azimuth range of turntable is 0° to 360°, and the receive antenna has two polarizations Vertical (V) and Horizontal (H). Above 1GHz: (Note: the FCC's permission to use 1.5m as an alternative per TCBC Conf call of Dec. 2, 2014.) The EUT is placed on a turntable 1.5 meters above the ground in the chamber, 3 meter away from the antenna. The maximal emission value is acquired by adjusting the antenna height, polarisation and turntable azimuth. Normally, the height range of antenna is 1 m to 4 m, the azimuth range of turntable is 0° to 360°, and the receive antenna has two polarizations Vertical (V) and Horizontal (H).
3. A log-periodic antenna or double-ridged waveguide horn antenna shall be substituted in place of the EUT. The log-periodic antenna will be driven by a signal generator and the level will be adjusted till the same power value on the spectrum analyzer or receiver. The level of the spurious emissions can be calculated through the level of the signal generator, cable loss, the gain of the substitution antenna and the reading of the spectrum analyzer or receiver.
4. The EUT is then put into continuously transmitting mode at its maximum power level during the test. Set Test Receiver or Spectrum RBW=1MHz, VBW=3MHz for above 1GHz and RBW=100kHz, VBW=300kHz for 30MHz to 1GHz, And the maximum value of the receiver should be recorded as (Pr).
5. The EUT shall be replaced by a substitution antenna. In the chamber, an substitution antenna for the frequency band of interest is placed at the reference point of the chamber. An RF Signal source for the frequency band of interest is connected to the substitution antenna with a cable that has been constructed to not interfere with the radiation pattern of the antenna. A power (PMea) is applied to the input of the substitution antenna, and adjust the level of the signal generator output until the value of the receiver reach the previously recorded (Pr). The power of signal source (PMea) is recorded. The test should be performed by rotating the test item and adjusting the receiving antenna polarization.
6. A amplifier should be connected to the Signal Source output port. And the cable should be connect between the Amplifier and the Substitution Antenna. The cable loss (Pcl) ,the Substitution Antenna Gain (Ga) and the Amplifier Gain (PAg) should be recorded after test.
7. The measurement results are obtained as described below:

$$\text{Power(EIRP)} = \text{PMea} - \text{PAg} - \text{Pcl} + \text{Ga}$$

The measurement results are amend as described below:

$$\text{Power(EIRP)} = \text{PMea} - \text{Pcl} + \text{Ga}$$

8. This value is EIRP since the measurement is calibrated using an antenna of known gain (2.15 dBi)

and known input power. ERP can be calculated from EIRP by subtracting the gain of the dipole, $ERP = EIRP - 2.15\text{dBi}$.

Test setup

30MHz~~~ 1GHz

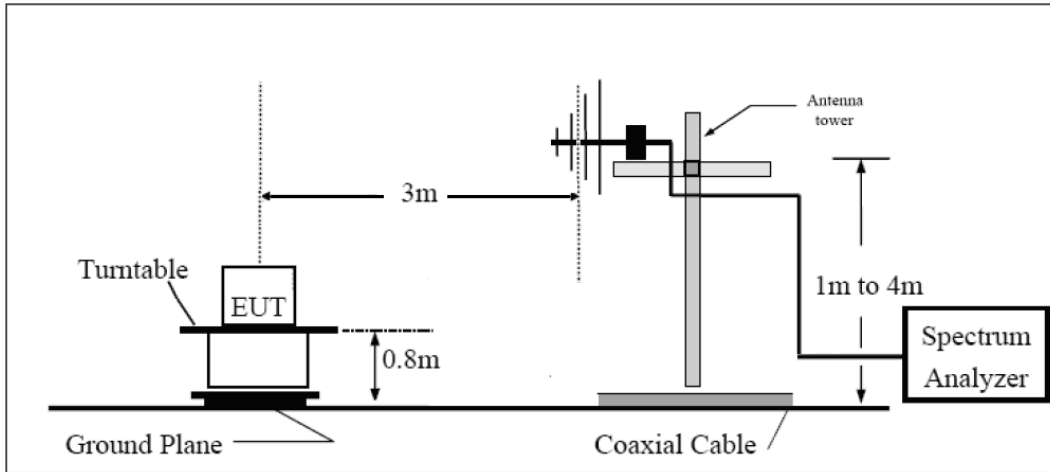

Above 1GHz

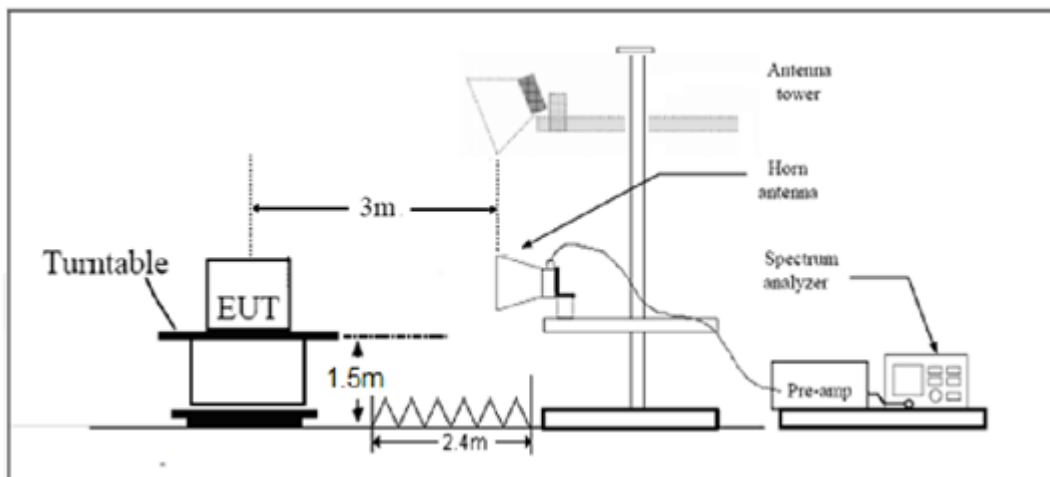

Note: Area side:2.4mX3.6m

The radiated emission was measured in the following position: EUT stand-up position (Z axis), lie-down position (X, Y axis). The worst emission was found in stand-up position (Z axis) and the worst case was recorded.

Limits

Rule Part 27.53 (g) For operations in the 600 MHz band and the 698-746 MHz band, the power of any emission outside a licensee's frequency band(s) of operation shall be attenuated below the transmitter power (P) within the licensed band(s) of operation, measured in watts, by at least $43 + 10 \log (P)$ dB. Compliance with this provision is based on the use of measurement instrumentation employing a resolution bandwidth of 100 kilohertz or greater. However, in the 100 kilohertz bands immediately outside and adjacent to a licensee's frequency block, a resolution bandwidth of at least 30 kHz may be employed.

Limit	-13 dBm
-------	---------



Measurement Uncertainty

The assessed measurement uncertainty to ensure 95% confidence level for the normal distribution is with the coverage factor $k = \pm 1.96$, $U = \pm 3.55$ dB.

Test Result

LTE Band 12 QPSK 1.4MHz CH-Middle, RB 1

Harmonic	Frequency (MHz)	SG (dBm)	Cable Loss (dB)	Gain (dBi)	Antenna Polarization	ERP Level (dBm)	Limit (dBm)	Margin (dB)	Azimuth (deg)
2	1415.00	-64.10	2.00	10.75	Horizontal	-57.50	-13.00	44.50	45
3	2122.50	-47.71	2.51	11.05	Horizontal	-41.32	-13.00	28.32	90
4	2830.00	-55.86	4.20	11.15	Horizontal	-51.06	-13.00	38.06	315
5	3537.50	-62.44	5.20	11.15	Horizontal	-58.64	-13.00	45.64	90
6	4245.00	-60.99	5.50	11.95	Horizontal	-56.69	-13.00	43.69	315
7	4952.50	-60.40	5.70	13.55	Horizontal	-54.70	-13.00	41.70	225
8	5660.00	-58.99	6.30	13.75	Horizontal	-53.69	-13.00	40.69	135
9	6367.50	-58.84	6.80	13.85	Horizontal	-53.94	-13.00	40.94	45
10	7075.00	-53.85	6.90	14.25	Horizontal	-48.65	-13.00	35.65	0

Note: 1.The other Spurious RF Radiated emissions level is no more than noise floor.
 2. The worst emission was found in the antenna is Horizontal position.

LTE Band 12 QPSK 5MHz CH-Middle, RB 1

Harmonic	Frequency (MHz)	SG (dBm)	Cable Loss (dB)	Gain (dBi)	Antenna Polarization	ERP Level (dBm)	Limit (dBm)	Margin (dB)	Azimuth (deg)
2	1415.00	-59.79	2.00	10.75	Horizontal	-53.19	-13.00	40.19	225
3	2122.50	-47.55	2.51	11.05	Horizontal	-41.16	-13.00	28.16	135
4	2830.00	-57.05	4.20	11.15	Horizontal	-52.25	-13.00	39.25	180
5	3537.50	-63.44	5.20	11.15	Horizontal	-59.64	-13.00	46.64	90
6	4245.00	-60.65	5.50	11.95	Horizontal	-56.35	-13.00	43.35	315
7	4952.50	-61.18	5.70	13.55	Horizontal	-55.48	-13.00	42.48	180
8	5660.00	-59.66	6.30	13.75	Horizontal	-54.36	-13.00	41.36	225
9	6367.50	-57.26	6.80	13.85	Horizontal	-52.36	-13.00	39.36	90
10	7075.00	-53.85	6.90	14.25	Horizontal	-48.65	-13.00	35.65	180

Note: 1.The other Spurious RF Radiated emissions level is no more than noise floor.
 2. The worst emission was found in the antenna is Horizontal position.



LTE Band 12 QPSK 10MHz CH-Middle, RB 1

Harmonic	Frequency (MHz)	SG (dBm)	Cable Loss (dB)	Gain (dBi)	Antenna Polarization	ERP Level (dBm)	Limit (dBm)	Margin (dB)	Azimuth (deg)
2	1415.00	-61.30	2.00	10.75	Horizontal	-54.70	-13.00	41.70	180
3	2122.50	-47.72	2.51	11.05	Horizontal	-41.33	-13.00	28.33	135
4	2830.00	-59.04	4.20	11.15	Horizontal	-54.24	-13.00	41.24	45
5	3537.50	-63.04	5.20	11.15	Horizontal	-59.24	-13.00	46.24	45
6	4245.00	-61.21	5.50	11.95	Horizontal	-56.91	-13.00	43.91	135
7	4952.50	-61.05	5.70	13.55	Horizontal	-55.35	-13.00	42.35	315
8	5660.00	-59.88	6.30	13.75	Horizontal	-54.58	-13.00	41.58	225
9	6367.50	-58.02	6.80	13.85	Horizontal	-53.12	-13.00	40.12	45
10	7075.00	-54.55	6.90	14.25	Horizontal	-49.35	-13.00	36.35	0

Note: 1. The other Spurious RF Radiated emissions level is no more than noise floor.

2. The worst emission was found in the antenna is Horizontal position.

5 Main Test Instruments

Name	Manufacturer	Type	Serial Number	Calibration Date	Expiration Date
Base Station Simulator	R&S	CMW500	113824	2019-05-19	2020-05-18
Power Splitter	Hua Xiang	SHX-GF2-2-13	10120101	/	/
Spectrum Analyzer	Key sight	N9010A	MY50210259	2019-05-19	2020-05-18
Signal Analyzer	R&S	FSV30	100815	2018-12-16	2019-12-15
Loop Antenna	SCHWARZBECK	FMZB1519	1519-047	2017-09-26	2019-09-25
Trilog Antenna	SCHWARZBECK	VUBL 9163	9163-201	2017-11-18	2019-11-17
Horn Antenna	R&S	HF907	100126	2018-07-07	2020-07-06
Horn Antenna	ETS-Lindgren	3160-09	00102643	2018-06-20	2020-06-19
Horn Antenna	STEATITE	QSH-SL-26-40-K-15	16779	2017-07-20	2019-07-19
Signal generator	R&S	SMB 100A	102594	2019-05-19	2020-05-18
Climatic Chamber	ESPEC	SU-242	93000506	2017-12-17	2020-12-16
Preamplifier	R&S	SCU18	102327	2019-05-19	2020-05-18
MOB COMMS DC SUPPLY	Keysight	66319D	MY43004105	2019-05-19	2020-05-18
RF Cable	Agilent	SMA 15cm	0001	2019-06-14	2019-09-13
Software	R&S	EMC32	9.26.0	/	/

ANNEX A: EUT Appearance and Test Setup

A.1 EUT Appearance

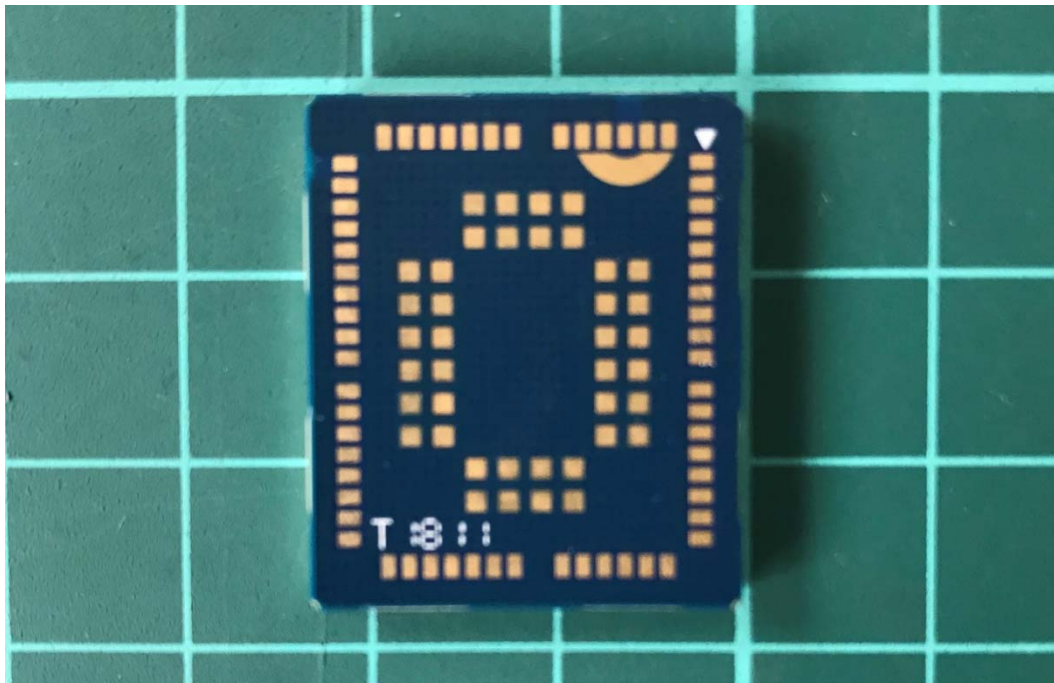

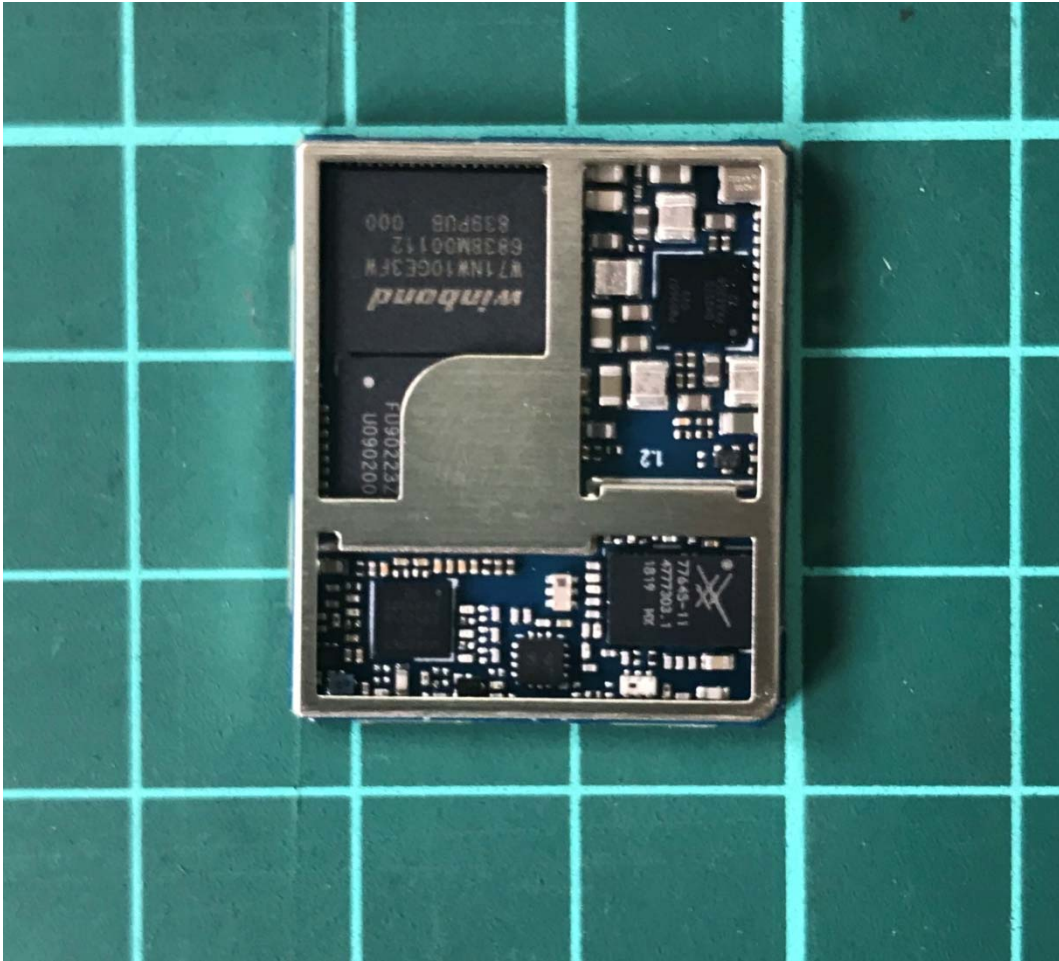

a: EUT

Picture 1 EUT and Accessory

A.2 Test Setup



30MHz ~ 1GHz



Above 1GHz

Picture 2: Radiated Spurious Emissions Test setup

ANNEX B: Product Change Description

Statement

We **Quectel Wireless Solutions Co., Ltd** declare the following models.

Product Name: LTE Cat M1 Module

Model Number: BG96-NA

Hardware Version: R1.0

Module	Category	Supported Band
BG96-NA	CAT M1	B2/B4/B12/B13

The HW design of BG96-NA is exactly the same with before, it just increases B2/B12. Because B2 and B12 were disabled through software before and now be enabled. The hardware design and software feature are exactly the same.

The change will not impact RF performance for original frequency bands.

Your assistance on this matter is highly appreciated.

Sincerely,

Name: Jean Hu

Title: Certification Section