

# FCC Radio Test Report

## FCC ID: 2AH4HMT4201

This report concerns: Original Grant

**Project No.** : 2104C020  
**Equipment** : LTE Cat-M1 Tracker  
**Brand Name** : Mobilogix  
**Test Model** : MT4201E  
**Series Model** : MT4201C  
**Applicant** : Mobilogix, Inc.  
**Address** : 5500 Trabuco Rd Suite 150 Irvine, CA, USA  
**Manufacturer** : Mobilogix, Inc.  
**Address** : 5500 Trabuco Rd Suite 150 Irvine, CA, USA  
**Factory** : Suga Electronics (Dongguan) Co., Ltd.  
**Address** : No.8 Fulong Road, Qingxi Town, Dongguan City  
**Date of Receipt** : Apr. 28, 2021  
**Date of Test** : Apr. 29, 2021 ~ May 18, 2021  
**Issued Date** : Jun. 07, 2021  
**Report Version** : R00  
**Test Sample** : Engineering Sample No.: DG2021050858  
**Standard(s)** : 47 CFR FCC Part 22 Subpart H  
47 CFR FCC Part 2  
ANSI/TIA/EIA-603-E-2016  
FCC KDB 971168 D01 Power Meas License Digital Systems v03r01

The above equipment has been tested and found compliance with the requirement of the relative standards by BTL Inc.

*Vegeta Li*

Prepared by : Vegeta Li

*Steven Lu*

Approved by : Steven Lu



Certificate #5123.02

Add: No.3, Jinshagang 1st Road, Shixia, Dalang Town, Dongguan, Guangdong, China.

Tel: +86-769-8318-3000

Web: [www.newbtl.com](http://www.newbtl.com)

**Declaration**

**BTL** represents to the client that testing is done in accordance with standard procedures as applicable and that test instruments used has been calibrated with standards traceable to international standard(s) and/or national standard(s).

**BTL's** reports apply only to the specific samples tested under conditions. It is manufacture's responsibility to ensure that additional production units of this model are manufactured with the identical electrical and mechanical components. **BTL** shall have no liability for any declarations, inferences or generalizations drawn by the client or others from **BTL** issued reports.

The report must not be used by the client to claim product certification, approval, or endorsement by NIST, A2LA, or any agency of the U.S. Government.

This report is the confidential property of the client. As a mutual protection to the clients, the public and ourselves, the test report shall not be reproduced, except in full, without our written approval.

**BTL's** laboratory quality assurance procedures are in compliance with the **ISO/IEC 17025** requirements, and accredited by the conformity assessment authorities listed in this test report.

**BTL** is not responsible for the sampling stage, so the results only apply to the sample as received.

The information, data and test plan are provided by manufacturer which may affect the validity of results, so it is manufacturer's responsibility to ensure that the apparatus meets the essential requirements of applied standards and in all the possible configurations as representative of its intended use.

**Limitation**

For the use of the authority's logo is limited unless the Test Standard(s)/Scope(s)/Item(s) mentioned in this test report is (are) included in the conformity assessment authorities acceptance respective.

Please note that the measurement uncertainty is provided for informational purpose only and is not use in determining the Pass/Fail results.

<b>Table of Contents</b>	<b>Page</b>
<b>REPORT ISSUED HISTORY</b>	<b>5</b>
<b>1 . SUMMARY OF TEST RESULTS</b>	<b>6</b>
1.1 TEST FACILITY	7
1.2 MEASUREMENT UNCERTAINTY	7
1.3 TEST ENVIRONMENT CONDITIONS	7
<b>2 . GENERAL INFORMATION</b>	<b>8</b>
2.1 GENERAL DESCRIPTION OF EUT	8
2.2 DESCRIPTION OF TEST MODES	9
2.3 BLOCK DIGRAM SHOWING THE CONFIGURATIONOFSYSTEMTESTED	10
2.4 DESCRIPTION OF SUPPORT UNITS	10
<b>3 . TEST RESULT</b>	<b>11</b>
3.1 OUTPUT POWER MEASUREMENT	11
3.1.1 LIMIT	11
3.1.2 TEST PROCEDURE	11
3.1.3 TEST SETUP LAYOUT	11
3.1.4 TEST DEVIATION	11
3.1.5 TEST RESULTS	11
3.2 OCCUPIED BANDWIDTH MEASUREMENT	12
3.2.1 TEST PROCEDURE	12
3.2.2 TEST SETUP LAYOUT	12
3.2.3 TEST DEVIATION	12
3.2.4 TEST RESULTS	12
3.3 CONDUCTED SPURIOUS EMISSIONS MEASUREMENT	13
3.3.1 LIMIT	13
3.3.2 TEST PROCEDURES	13
3.3.3 TEST SETUP LAYOUT	13
3.3.4 TEST DEVIATION	13
3.3.5 TEST RESULTS	13
3.4 RADIATED SPURIOUS EMISSIONS MEASUREMENT	14
3.4.1 LIMIT	14
3.4.2 TEST PROCEDURES	14
3.4.3 TEST SETUP LAYOUT	15
3.4.4 TEST DEVIATION	16
3.4.5 TEST RESULTS (9KHZ TO 30MHZ)	16
3.4.6 TEST RESULTS (30MHZ TO 1000MHZ)	16
3.4.7 TEST RESULTS (ABOVE 1000MHZ)	16
3.5 BAND EDGE MEASUREMENT	17
3.5.1 LIMIT	17
3.5.2 TEST PROCEDURES	17

<b>Table of Contents</b>	<b>Page</b>
3.5.3 TEST SETUP LAYOUT	17
3.5.4 TEST DEVIATION	17
3.5.5 TEST RESULTS	17
3.6 PEAK TO AVERAGE RATIO MEASUREMENT	18
3.6.1 LIMIT	18
3.6.2 TEST PROCEDURES	18
3.6.3 TEST SETUP LAYOUT	18
3.6.4 TEST DEVIATION	18
3.6.5 TEST RESULTS	18
3.7 FREQUENCY STABILITY MEASUREMENT	19
3.7.1 LIMIT	19
3.7.2 TEST PROCEDURES	19
3.7.3 TEST SETUP LAYOUT	19
3.7.4 TEST DEVIATION	19
3.7.5 TEST RESULTS	19
4. LIST OF MEASUREMENT EQUIPMENTS	20
APPENDIX A - OUTPUT POWER	22
APPENDIX B - OCCUPIED BANDWIDTH	24
APPENDIX C - CONDUCTED SPURIOUS EMISSIONS	35
APPENDIX D - RADIATED SPURIOUS EMISSIONS (9KHZ TO 30MHZ)	44
APPENDIX E - RADIATED SPURIOUS EMISSIONS (30MHZ TO 1000MHZ)	49
APPENDIX F - RADIATED SPURIOUS EMISSIONS (ABOVE 1000MHZ)	66
APPENDIX G - BAND EDGE	83
APPENDIX H - PEAK TO AVERAGE RATIO	90
APPENDIX I - FREQUENCY STABILITY	95

**REPORT ISSUED HISTORY**

Report Version	Description	Issued Date
R00	Original Issue.	Jun. 07, 2021

## 1. SUMMARY OF TEST RESULTS

Test procedures according to the technical standard(s):

FCC Part 22 Subpart H & Part 2			
Standard(s) Section	Test Item	Judgment	Remark
2.1046 22.913(a)(5)	Effective Radiated Power	PASS	-----
2.1049	Occupied Bandwidth	PASS	-----
2.1051 22.917(a)	Conducted Spurious Emissions	PASS	-----
2.1053 22.917(a)	Radiated Spurious Emissions	PASS	-----
22.917(a)	Band Edge Measurements	PASS	-----
-	Peak To Average Ratio	PASS	Record Only
2.1055 22.355	Frequency Stability	PASS	-----

Note:

(1) "N/A" denotes test is not applicable in this test report.

### 1.1 TEST FACILITY

The test facilities used to collect the test data in this report is at the location of No.3, Jinshagang 1st Road, Shixia, Dalang Town, Dongguan, Guangdong, China.  
 BTL's Test Firm Registration Number for FCC: 357015  
 BTL's Designation Number for FCC: CN1240

### 1.2 MEASUREMENT UNCERTAINTY

ISO/IEC 17025 requires that an estimate of the measurement uncertainties associated with the emissions test results be included in the report. The measurement uncertainties given below are based on a 95% confidence level (based on a coverage factor ( $k=2$ ))  
 The BTL measurement uncertainty as below table:

#### A. Radiated Measurement:

Test Site	Method	Measurement Frequency Range	Ant. H / V	U,(dB)
DG-CB03 (3m)	CISPR	9KHz ~ 30MHz	V	3.79
		9KHz ~ 30MHz	H	3.57
		30MHz ~ 200MHz	V	4.88
		30MHz ~ 200MHz	H	4.14
		200MHz ~ 1,000MHz	V	4.62
		200MHz ~ 1,000MHz	H	4.80

Test Site	Method	Measurement Frequency Range	U,(dB)
DG-CB03 (3m)	CISPR	1GHz ~ 6GHz	4.58
		6GHz ~ 18GHz	5.18

#### B. Other Measurement:

Parameter	Uncertainty
Spectrum Bandwidth	±3.8 %
Maximum Output Power	±0.95 dB
Power Spectral Density	±0.86 dB
Frequency Stability	±0.16 dB
Temperature	±0.08 °C
Time	±0.58 %
Supply voltages	±0.3 %

Note: Unless specifically mentioned, the uncertainty of measurement has not been taken into account to declare the compliance or non-compliance to the specification.

### 1.3 TEST ENVIRONMENT CONDITIONS

Test Item	Temperature	Humidity	Test Voltage	Tested By
Output Power & ERP	21.3°C	46%	DC 3.7	Tate Liu
Occupied Bandwidth	21.3°C	46%	DC 3.7	Tate Liu
Conducted Spurious Emissions	21.3°C	46%	DC 3.7	Tate Liu
Radiated Spurious Emissions	26°C	52%	DC 3.7	Grani Zhou
Band Edge	21.3°C	46%	DC 3.7	Tate Liu
Peak to Average Ratio	21.3°C	46%	DC 3.7	Tate Liu
Frequency Stability	Normal & Extreme	46%	Normal & Extreme	Tate Liu

## 2. GENERAL INFORMATION

### 2.1 GENERAL DESCRIPTION OF EUT

Equipment	LTE Cat-M1 Tracker			
Brand Name	Mobilogix			
Test Model	MT4201E			
Series Model	MT4201C			
Model Difference(s)	Only differ in model name and Harness.			
Hardware Version	1.2			
Software Version	1.5.0.1			
Power Source	1# DC voltage supplied from external power supply. 2# Supplied from battery.			
Power Rating	1# DC 48V 2# DC 3.7V			
IEMI No.	864475040048497			
Category	NB2			
Sub-carrier Spacing	3.75KHz, 15KHz			
Modulation Type	UL: BPSK, QPSK DL: BPSK, QPSK			
Max. ERP	LTE	Sub-carrier Spacing (KHz)	BPSK (dBm)	QPSK (dBm)
	Band 5	3.75	15.43	15.46
		15	15.87	15.90
	Band 26	3.75	16.21	16.25
		15	15.28	15.91

Note:

1. For a more detailed features description, please refer to the manufacturer's specifications or the user's manual.

2. Table for Filed Antenna:

Brand	Model Name	Antenna Type	Connector	Gain (dBi)	Note
N/A	N/A	Internal	N/A	-3.62	LTE Band 5
N/A	N/A	Internal	N/A	-3.62	LTE Band 26

Note: The antenna gain is provided by the manufacturer.



## 2.2 DESCRIPTION OF TEST MODES

Following mode(s) is (were) found to be the worst case(s) and selected for the final test.

LTE BAND 5 MODE				
Test Item	Tested Channel	Sub-carrier Spacing(kHz)	Modulation	Mode
Output Power & ERP	20401, 20525, 20649	3.75	BPSK, QPSK	1RB
		15		
Occupied Bandwidth	20401, 20525, 20649	3.75	BPSK, QPSK	1RB
		15		1RB/12RB
Conducted Spurious Emissions	20525	3.75	BPSK, QPSK	1RB
		15		
Radiated Spurious Emissions	20525	3.75	BPSK, QPSK	1RB
		15		
Band Edge	20402, 20648	3.75	BPSK, QPSK	1RB
		15		1RB/12RB
Peak To Average Ratio	20401, 20525, 20649	3.75	BPSK, QPSK	1RB
		15		
Frequency Stability	20525	3.75	BPSK, QPSK	1RB
		15		

LTE BAND 26 MODE				
Test Item	Tested Channel	Sub-carrier Spacing(kHz)	Modulation	Mode
Output Power & ERP	26791, 20925, 27039	3.75	BPSK, QPSK	1RB
		15		
Occupied Bandwidth	20794, 20925, 27039	3.75	BPSK, QPSK	1RB
		15		1RB/12RB
Conducted Spurious Emissions	20925	3.75	BPSK, QPSK	1RB
		15		
Radiated Spurious Emissions	20925	3.75	BPSK, QPSK	1RB
		15		
Band Edge	20792, 27038	3.75	BPSK, QPSK	1RB
		15		1RB/12RB
Peak To Average Ratio	26794, 20925, 27039	3.75	BPSK, QPSK	1RB
		15		
Frequency Stability	20925	3.75	BPSK, QPSK	1RB
		15		

### 2.3 BLOCK DIGRAM SHOWING THE CONFIGURATION OF SYSTEM TESTED

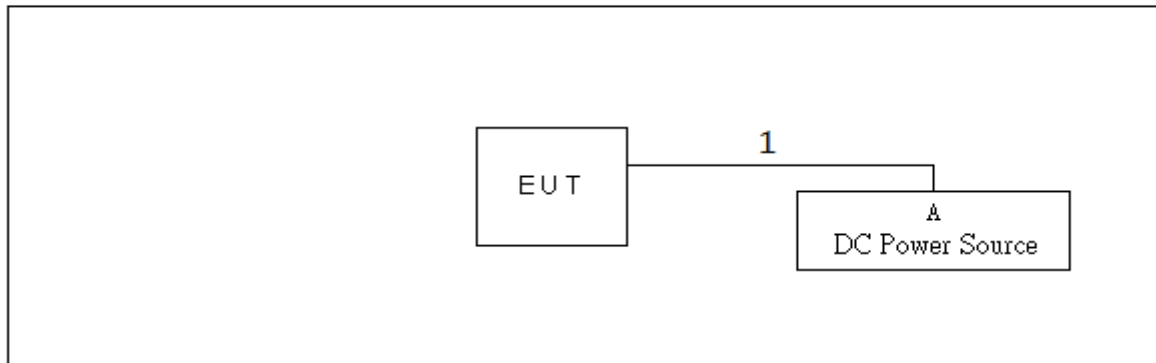

### 2.4 DESCRIPTION OF SUPPORT UNITS

The EUT has been tested as an independent unit together with other necessary accessories or support units. The following support units or accessories were used to form a representative test configuration during the tests.

Item	Equipment	Mfr/Brand	Model/Type No.	Series No.
A	DC Power Source	TRUE-POWER	GPC30300N	N/A

Item	Cable Type	Shielded Type	Ferrite Core	Length
1	DC Cable	NO	NO	1.5m

### 3. TEST RESULT

#### 3.1 OUTPUT POWER MEASUREMENT

##### 3.1.1 LIMIT

Mobile / Portable station are limited to 7 watts e.r.p.

##### 3.1.2 TEST PROCEDURE

The testing follows FCC KDB 971168 v03r01 Section 5.

##### EIRP / ERP:

EIRP = Output Power + Antenan gain

ERP = EIPR - 2.15dBi

##### Output Power:

The EUT was set up for the maximum power with GSM, GPRS, EDGE, WCDMA and LTE link data modulation and link up with simulator. Set the EUT to transmit under low, middle and high channel and record the power level shown on simulator.

##### 3.1.3 TEST SETUP LAYOUT

##### Output Power Measurement

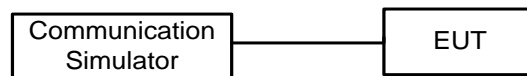

##### 3.1.4 TEST DEVIATION

No deviation

##### 3.1.5 TEST RESULTS

Please refer to the APPENDIX A.

### 3.2 OCCUPIED BANDWIDTH MEASUREMENT

#### 3.2.1 TEST PROCEDURE

The testing follows FCC KDB 971168 v03r01 Section 4.

1. The EUT makes a call to the communication simulator. All measurements were done at low, middle and high operational frequency range. The communication simulator station system controlled a EUT to export maximum output power under transmission mode and specific channel frequency. Use OBW measurement function of Spectrum analyzer to measure 99 % occupied bandwidth and 26dB bandwidth.
2. The EUT was connected to spectrum analyzer and system simulator via a power divider.
3.  $RBW=(1\% \sim 5\%)*EBW$   
 $VBW \geq 3* RBW$
4. Set spectrum analyzer with Peak detector.

#### 3.2.2 TEST SETUP LAYOUT

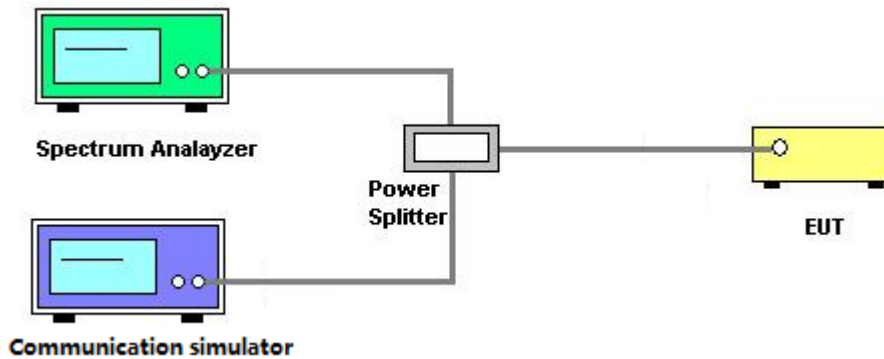

#### 3.2.3 TEST DEVIATION

No deviation

#### 3.2.4 TEST RESULTS

Please refer to the APPENDIX B.

### 3.3 CONDUCTED SPURIOUS EMISSIONS MEASUREMENT

#### 3.3.1 LIMIT

The power of any emission outside of the authorized operating frequency ranges must be attenuated below the transmitting power (P) by a factor of at least  $43 + 10 \log(P)$  dB. The emission limit equal to -13dBm.

#### 3.3.2 TEST PROCEDURES

The testing follows FCC KDB 971168 v03r01 Section 6.

1. The EUT was connected to spectrum analyzer and system simulator via a power divider.
2. The band edges of low and high channels for the highest RF powers were measured. Set RBW  $\geq 1\%$  EBW in the 1MHz band immediately outside and adjacent to the band edge.
3. Set spectrum analyzer with Peak detector.
4. The RF fundamental frequency should be excluded against the limit line in the operating frequency band.

#### 3.3.3 TEST SETUP LAYOUT

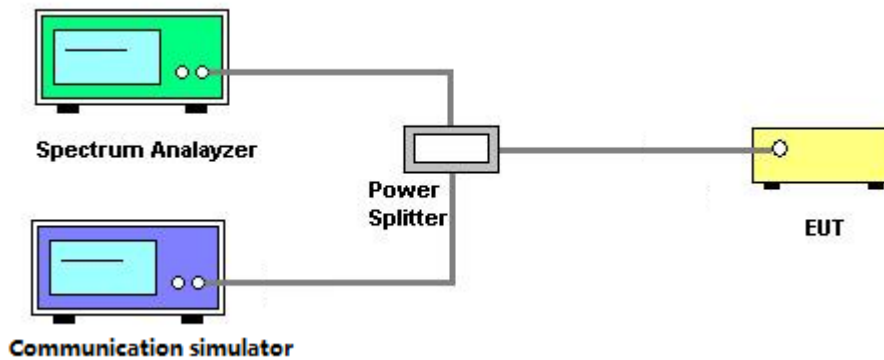

#### 3.3.4 TEST DEVIATION

No deviation

#### 3.3.5 TEST RESULTS

Please refer to the APPENDIX C.

### **3.4 RADIATED SPURIOUS EMISSIONS MEASUREMENT**

#### **3.4.1 LIMIT**

The power of any emission outside of the authorized operating frequency ranges must be attenuated below the transmitting power (P) by a factor of at least  $43 + 10 \log(P)$  dB. The emission limit equal to -13dBm.

#### **3.4.2 TEST PROCEDURES**

The testing follows FCC KDB 971168 v03r01 Section 6.2.

1. Substitution method is used for E.I.R.P measurement. In the semi-anechoic chamber, EUT placed on the 0.8m height of Turn Table, rotated the table around 360 degrees to search the maximum radiation power and receiver antenna shall be rotated vertical and horizontal polarization and moved height from 1m to 4m to find the maximum polar radiated power. The "Read Value" is the spectrum reading the maximum power value.
2. The substitution horn antenna is substituted for EUT at the same position and signals generator export the CW signal to the substitution antenna via a TX cable. Rotated the Turn Table and moved receiving antenna to find the maximum radiation power. Adjust output power level of S.G to get a Value of spectrum reading equal to "Read Value " of step a. Record the power level of S.G
3.  $EIRP = \text{Output power level of S.G} - \text{TX cable loss} + \text{Antenna gain of substitution horn.}$
4. ERP can be calculated form EIRP by subtracting the gain of dipole,  $ERP = EIPR - 2.15\text{dBi.}$
5. The resolution bandwidth and video bandwidth of test receiver/spectrum analyzer is 1MHz/3MHz.

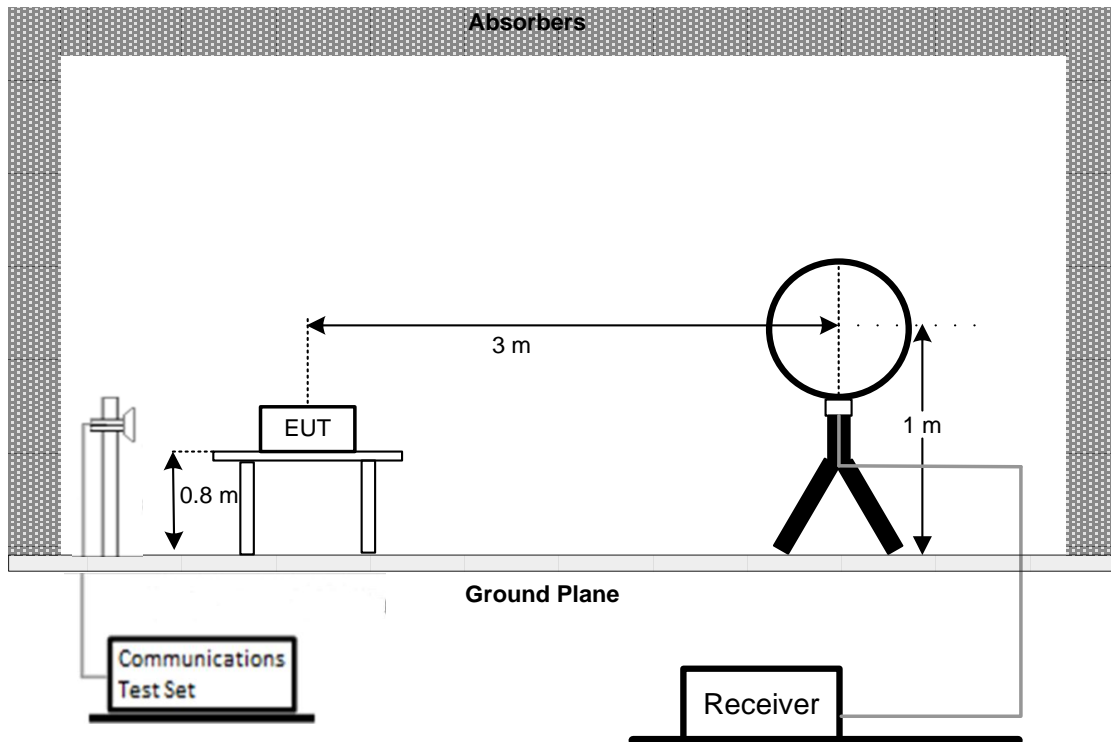
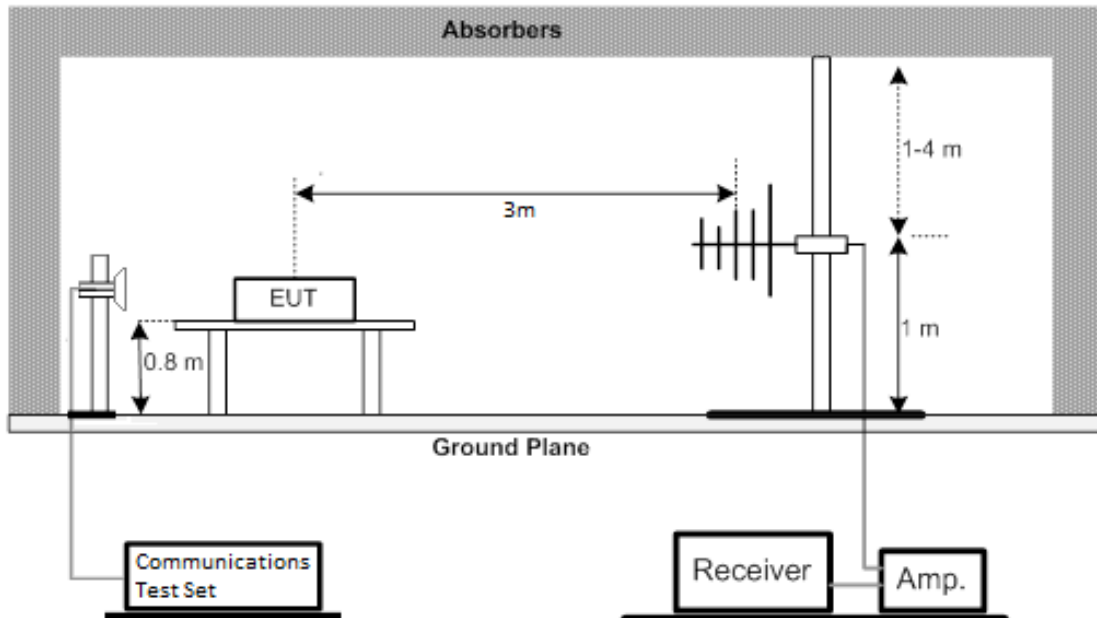
**3.4.3 TEST SETUP LAYOUT****Below 30MHz****30MHz to 1000MHz**

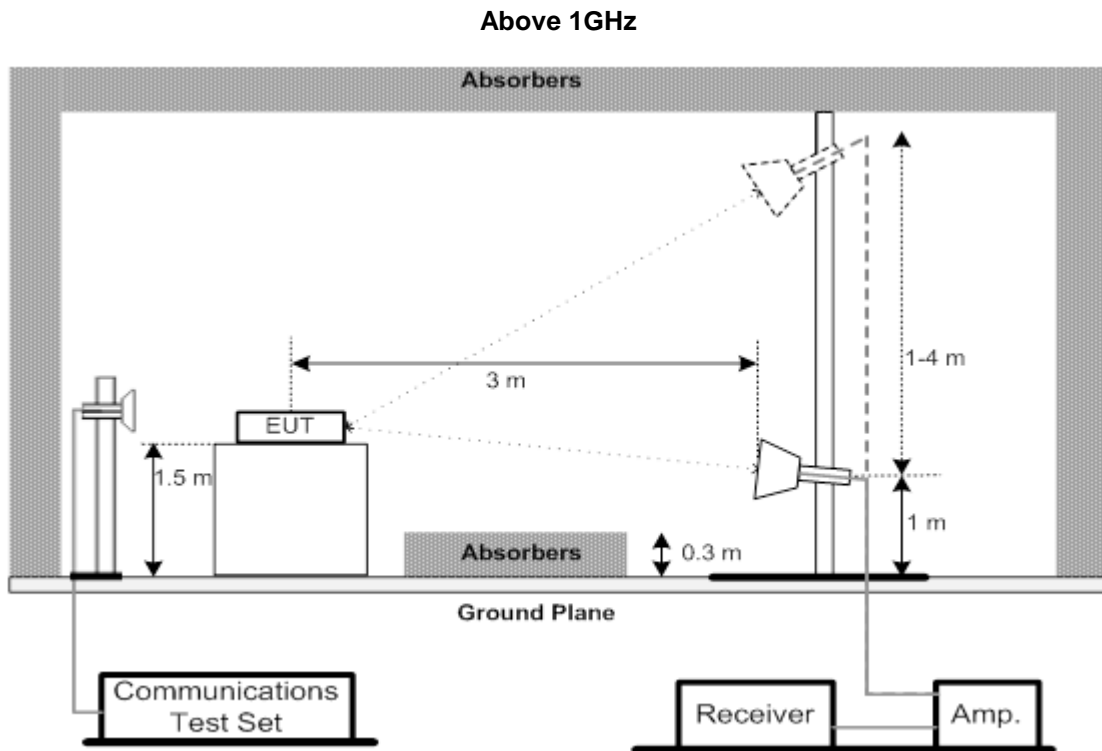

**3.4.4 TEST DEVIATION**

No deviation

**3.4.5 TEST RESULTS (9KHZ TO 30MHZ)**

Please refer to the APPENDIX D.

**3.4.6 TEST RESULTS (30MHZ TO 1000MHZ)**

Please refer to the APPENDIX E.

**3.4.7 TEST RESULTS (ABOVE 1000MHZ)**

Please refer to the APPENDIX F.



### 3.5 BAND EDGE MEASUREMENT

#### 3.5.1 LIMIT

A Power of any emission outside of the authorized operating frequency ranges must be attenuated below the transmitting power (P) by a factor of at least  $43 + 10 \log(P)$  dB. In the 1 MHz bands immediately outside and adjacent to the frequency block a resolution bandwidth of at least one percent of the emission bandwidth of the fundamental emission of the transmitter may be employed.

#### 3.5.2 TEST PROCEDURES

The testing follows FCC KDB 971168 v03r01 Section 6.

1. All measurements were done at low and high operational frequency range.
2. Record the max trace plot into the test report.

#### 3.5.3 TEST SETUP LAYOUT

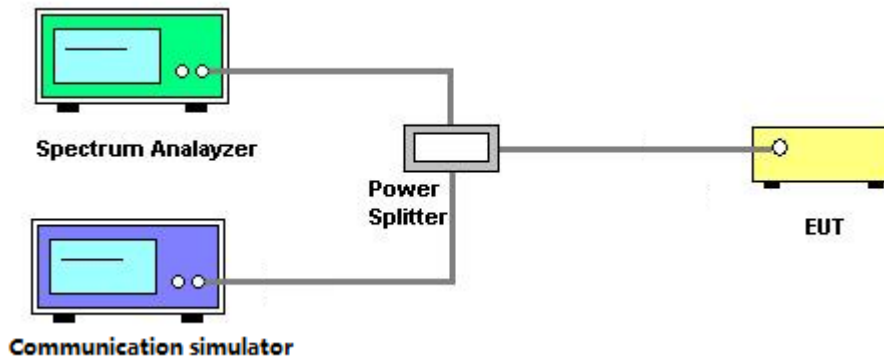

#### 3.5.4 TEST DEVIATION

No deviation

#### 3.5.5 TEST RESULTS

Please refer to the APPENDIX G.

### 3.6 PEAK TO AVERAGE RATIO MEASUREMENT

#### 3.6.1 LIMIT

In measuring transmissions in this band using an average power technique, the peak to-average ratio (PAR) of the transmission may not exceed 13 dB.

#### 3.6.2 TEST PROCEDURES

The testing follows FCC KDB 971168 v03r01 Section 5.7.

1. Set resolution/measurement bandwidth  $\geq$  signal's occupied bandwidth;
2. Set the number of counts to a value that stabilizes the measured CCDF curve;
3. Record the maximum PAPR level associated with a probability of 0.1%.

#### 3.6.3 TEST SETUP LAYOUT

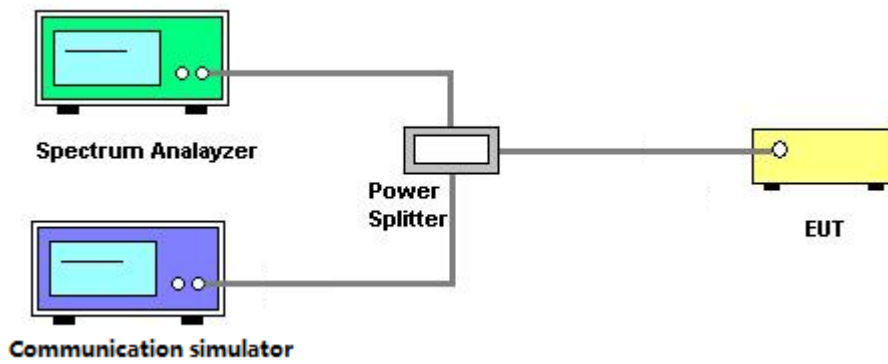

#### 3.6.4 TEST DEVIATION

No deviation

#### 3.6.5 TEST RESULTS

Please refer to the APPENDIX H.

### 3.7 FREQUENCY STABILITY MEASUREMENT

#### 3.7.1 LIMIT

$\pm 1.5$  ppm is for base and fixed station.  $\pm 2.5$  ppm is for mobile station.

#### 3.7.2 TEST PROCEDURES

The testing follows FCC KDB 971168 v03r01 Section 9.

1. Device is placed at the oven room. The oven room could control the temperatures and humidity. Power warm up is at least 15 min and power applied should perform before recording frequency error.
2. EUT is connected the external power supply to control the DC input power. The test voltage range is from minimum to maximum working voltage. Each step shall be record the frequency error rate.
3. The temperature range step is 10 degrees in this test items. All temperature levels shall be hold the  $\pm 0.5^{\circ}\text{C}$  during the measurement testing. The each temperature step shall be at least 0.5 hours, consider the EUT could be test under the stability condition.
4. The frequency error was recorded frequency error from the communication simulator.

#### 3.7.3 TEST SETUP LAYOUT

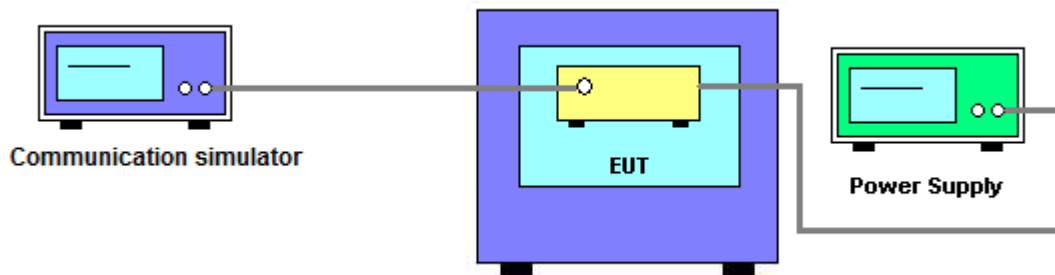

#### 3.7.4 TEST DEVIATION

No deviation

#### 3.7.5 TEST RESULTS

Please refer to the APPENDIX I.

#### 4. LIST OF MEASUREMENT EQUIPMENTS

Radiated Spurious Emission Measurement					
Item	Kind of Equipment	Manufacturer	Type No.	Serial No.	Calibrated until
1	Antenna	Schwarzbeck	VULB9160	9160-3232	Mar. 15, 2022
2	Amplifier	Agilent	8449B	3008A02334	Feb. 27, 2022
3	High Pass Filter	Wairwright Instruments Gmbh	WHK 1.5/15G-10ST	11	Feb. 27, 2022
4	Band Reject Filter	Wairwright Instruments Gmbh	WRCG 1710/1785-1690/1805-60/ 12SS	38	Feb. 27, 2022
5	Band Reject Filter	Wairwright Instruments Gmbh	WRCG 824/849-810/863-60/9SS	7	Feb. 27, 2022
6	Band Reject Filter	Wairwright Instruments Gmbh	WRCG 880/915-860/935-60/9SS	14	Feb. 27, 2022
7	Band Reject Filter	Wairwright Instruments Gmbh	WRCG 1850/1910-1830/1930-60/ 10SS	17	Feb. 27, 2022
8	High Pass Filter	Wairwright Instruments Gmbh	WHK3.1/18G-10SS	24	Feb. 27, 2022
9	Wireless Communication Test SET	Agilent	E5515C	MY48364183	Feb. 28, 2022
10	Microwave Preamplifier With Adaptor	EMC INSTRUMENT	EMC2654045	980039 & HA01	Feb. 28, 2022
11	Receiver	Agilent	N9038A	MY52130039	Jul. 25, 2021
12	wideband radio communication tester	R&S	CMW500	152372	Feb. 27, 2022
13	High pass filter	KANGMAIWEI	ZHPF-M3-12.75G-3869	B2015073763	Feb. 07, 2022
14	High pass filter	KANGMAIWEI	ZHPF-M1000-4000-1	B2015073762	Feb. 07, 2022
15	High pass filter	KANGMAIWEI	ZHPF-M6-186-1727	B2015073764	Feb. 07, 2022
16	Cable	emci	LMR-400(30MHz-1GHz) (8m+5m)	N/A	May 23, 2021
17	Cable	mitron	B10-01-01-12M	18072744	Jun. 28, 2021
18	Controller	ETS-Lindgren	2090	N/A	N/A
19	Measurement Software	Farad	EZ-EMC Ver.NB-03A1-01	N/A	N/A
20	Loop Antenna	EM	EM-6876-1	230	Apr. 28, 2022
21	Double Ridged Guide Antenna	ETS	3115	75846	Mar. 17, 2022
22	Broad-Band Horn Antenna	Schwarzbeck	BBHA 9170	9170319	Jul. 07, 2021

Conducted Measurement					
Item	Kind of Equipment	Manufacturer	Type No.	Serial No.	Calibrated until
1	Wireless Communication Test SET	Agilent	E5515C	MY48364183	Feb. 28, 2022
2	EXA Spectrum Analyzer	Agilent	N9010A	MY50520044	Feb. 28, 2022
3	POWER SPLITTER	Mini-Circuits	ZFRSC-123-S+	331000910-1	Feb. 27, 2022
4	wideband radio communication tester	R&S	CMW500	152372	Feb. 27, 2022

Frequency Stability Measurement					
Item	Kind of Equipment	Manufacturer	Type No.	Serial No.	Calibrated until
1	Wireless Communication Test SET	Agilent	E5515C	MY48364183	Feb. 28, 2022
2*	Multi-output DC Power Supply	GW Instek	GPC-3030DN	EK880675	Jul. 25, 2023
3	POWER SPLITTER	Mini-Circuits	ZFRSC-123-S+	331000910-1	Feb. 27, 2022
4	wideband radio communication tester	R&S	CMW500	152372	Feb. 27, 2022
5	Const Temp, & Humidity Chamber	Bell	BTH-50C	20170306001	Feb. 27, 2022

Remark: "N/A" denotes no model name, serial no. or calibration specified.

"\*\*" calibration period of equipment list is three year.

Except \* item, all calibration period of equipment list is one year.

## APPENDIX A - OUTPUT POWER

**Output Power (dBm):**

LTE Band	Sub-carrier Spacing (kHz)	Modulation	N <sub>tones</sub>	Tone offset	Low CH	Mid CH	High CH
					CH20401	CH20525	CH20649
					824.1MHz	836.5MHz	848.9MHz
5	3.75	BPSK	1	0	20.67	21.20	20.91
			1	47	20.54	21.09	20.88
		QPSK	1	0	20.67	21.23	20.97
			1	47	20.45	21.18	20.89
	15	BPSK	1	0	21.64	20.61	20.35
			1	11	21.53	20.52	20.24
		QPSK	1	0	21.03	20.75	20.46
			1	11	21.67	20.68	20.39

LTE Band	Sub-carrier Spacing (kHz)	Modulation	N <sub>tones</sub>	Tone offset	Low CH	Mid CH	High CH
					CH26791	CH26925	CH27039
					824.1MHz	836.5MHz	848.9MHz
26	3.75	BPSK	1	0	21.98	21.29	21.08
			1	47	21.87	21.22	21.05
		QPSK	1	0	22.02	21.42	21.25
			1	47	21.96	21.38	21.11
	15	BPSK	1	0	21.05	20.59	20.26
			1	11	20.96	20.51	20.19
		QPSK	1	0	21.19	20.69	20.40
			1	11	21.13	20.61	20.32

**ERP (dBm):**

LTE Band	Sub-carrier Spacing (kHz)	Modulation	N <sub>tones</sub>	Tone offset	Low CH	Mid CH	High CH
					CH20401	CH20525	CH20649
					824.1MHz	836.5MHz	848.9MHz
5	3.75	BPSK	1	0	14.90	15.43	15.14
			1	47	14.77	15.32	15.11
		QPSK	1	0	14.90	15.46	15.20
			1	47	14.68	15.41	15.12
	15	BPSK	1	0	15.87	14.84	14.58
			1	11	15.76	14.75	14.47
		QPSK	1	0	15.26	14.98	14.69
			1	11	15.90	14.91	14.62

LTE Band	Sub-carrier Spacing (kHz)	Modulation	N <sub>tones</sub>	Tone offset	Low CH	Mid CH	High CH
					CH26791	CH26925	CH27039
					824.1MHz	836.5MHz	848.9MHz
26	3.75	BPSK	1	0	16.21	15.52	15.31
			1	47	16.10	15.45	15.28
		QPSK	1	0	16.25	15.65	15.48
			1	47	16.19	15.61	15.34
	15	BPSK	1	0	15.28	14.82	14.49
			1	11	15.19	14.74	14.42
		QPSK	1	0	15.42	14.92	14.63
			1	11	15.36	14.84	14.55

## **APPENDIX B - OCCUPIED BANDWIDTH**



LTE Band 5_3.75KHz					
BPSK			1RB#0		
Channel	Frequency (MHz)	99% Occupied Bandwidth (KHz)	Channel	Frequency (MHz)	26dB Bandwidth (KHz)
20401	824.1	56.805	20401	824.1	39.85
20525	836.5	55.343	20525	836.5	38.73
20649	848.9	58.902	20649	848.9	41.26
QPSK			1RB#0		
Channel	Frequency (MHz)	99% Occupied Bandwidth (KHz)	Channel	Frequency (MHz)	26dB Bandwidth (KHz)
20401	824.1	65.477	20401	824.1	42.39
20525	836.5	65.414	20525	836.5	39.31
20649	848.9	66.350	20649	848.9	42.32

## Spectrum Plot

1RB#0

### BPSK-20401



### BPSK-20525



### BPSK-20649

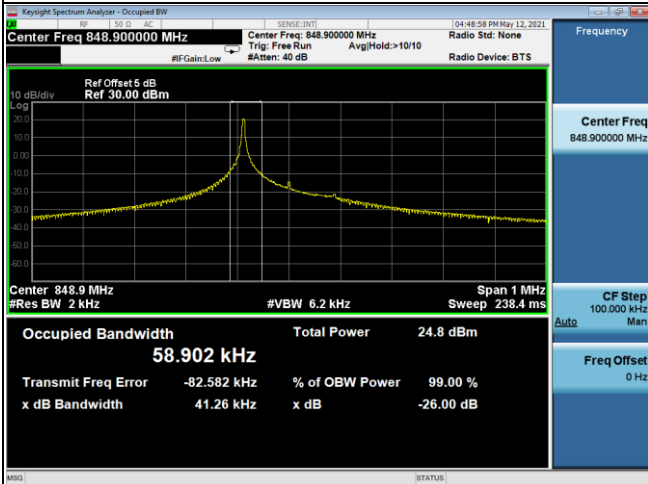

### QPSK-20401

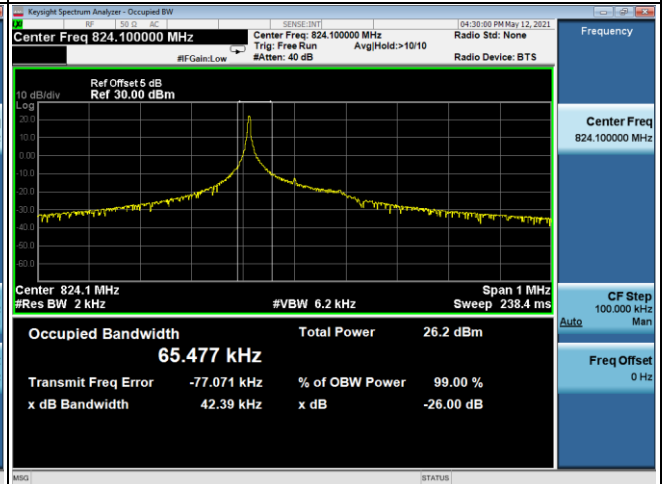

### QPSK-20525

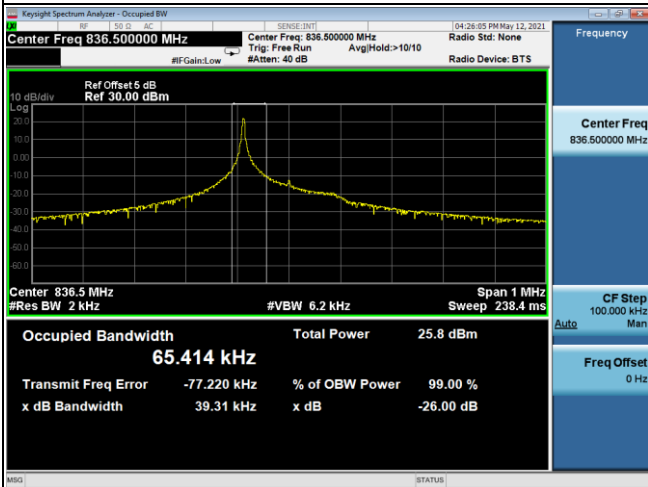

### QPSK-20649



LTE Band 5_15KHz					
BPSK			1RB#0		
Channel	Frequency (MHz)	99% Occupied Bandwidth (KHz)	Channel	Frequency (MHz)	26dB Bandwidth (KHz)
20401	824.1	120.81	20401	824.1	120.3
20525	836.5	121.91	20525	836.5	117.4
20649	848.9	119.17	20649	848.9	106.5
QPSK			1RB#0		
Channel	Frequency (MHz)	99% Occupied Bandwidth (KHz)	Channel	Frequency (MHz)	26dB Bandwidth (KHz)
20401	824.1	117.90	20401	824.1	116.6
20525	836.5	128.73	20525	836.5	131.0
20649	848.9	119.84	20649	848.9	117.2
QPSK			12RB#0		
Channel	Frequency (MHz)	99% Occupied Bandwidth (KHz)	Channel	Frequency (MHz)	26dB Bandwidth (KHz)
20401	824.1	187.41	20401	824.1	249.2
20525	836.5	185.97	20525	836.5	248.5
20649	848.9	188.65	20649	848.9	246.4

## Spectrum Plot

1RB#0

### BPSK-20401



### BPSK-20525

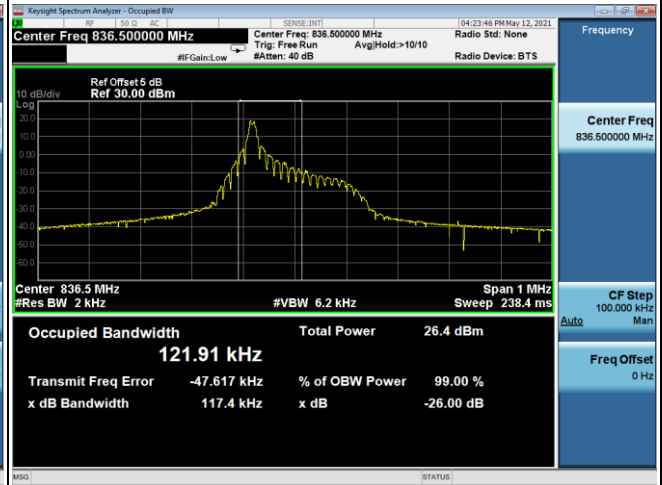

### BPSK-20649



### QPSK-20401



### QPSK-20525



### QPSK-20649



## Spectrum Plot

12RB#0

### QPSK-20401



### QPSK-20525

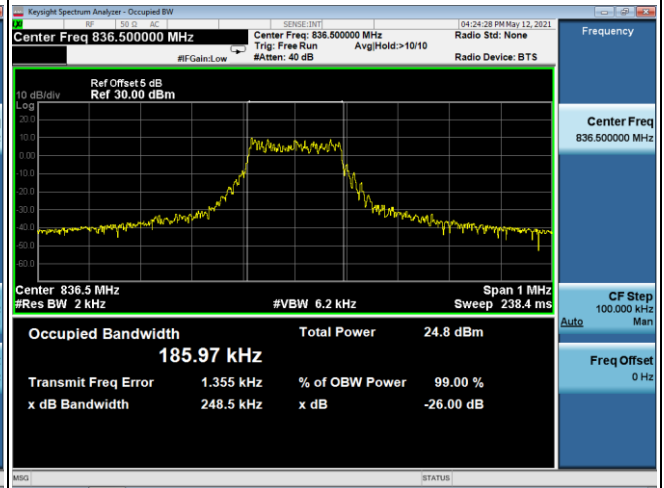

### QPSK-20649



LTE Band 26_3.75KHz					
BPSK			1RB#0		
Channel	Frequency (MHz)	99% Occupied Bandwidth (KHz)	Channel	Frequency (MHz)	26dB Bandwidth (KHz)
26794	824.1	59.132	26794	824.1	40.76
26925	836.5	57.351	26925	836.5	40.78
27039	848.9	57.954	27039	848.9	41.10
QPSK			1RB#0		
Channel	Frequency (MHz)	99% Occupied Bandwidth (KHz)	Channel	Frequency (MHz)	26dB Bandwidth (KHz)
26794	824.1	68.074	26794	824.1	40.21
26925	836.5	63.965	26925	836.5	40.76
27039	848.9	65.292	27039	848.9	41.15

## Spectrum Plot

1RB#0

### BPSK-26794

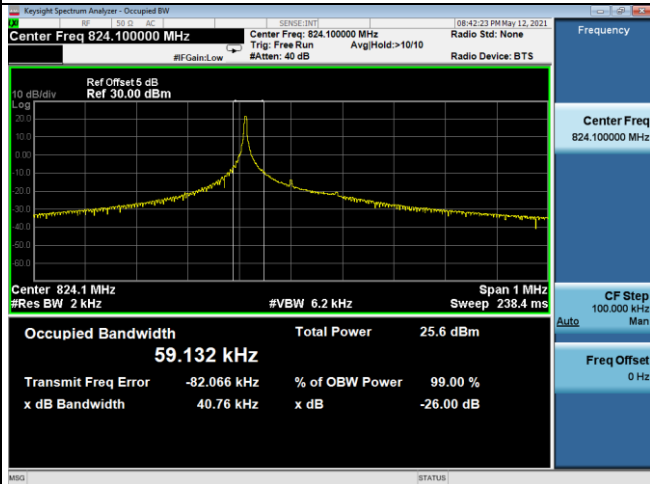

### BPSK-26925

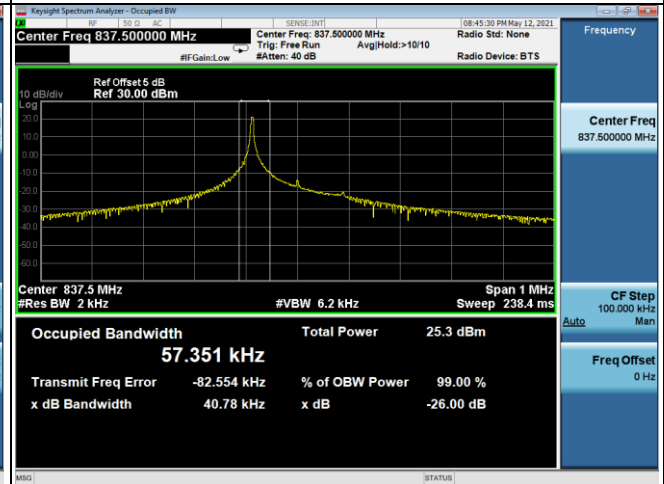

### BPSK-27039

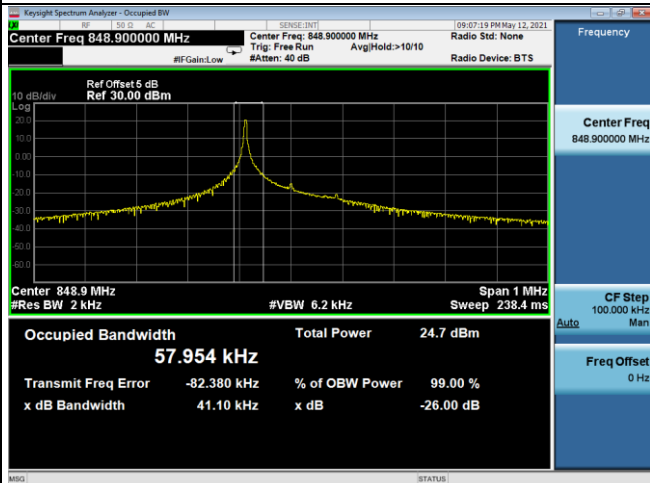

### QPSK-26794

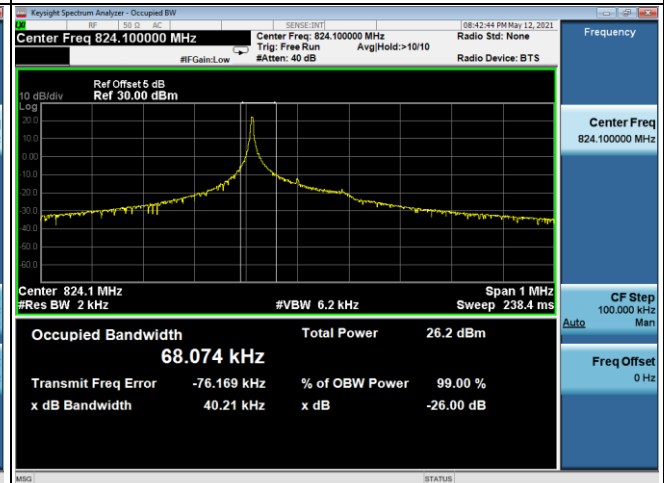

### QPSK-26925

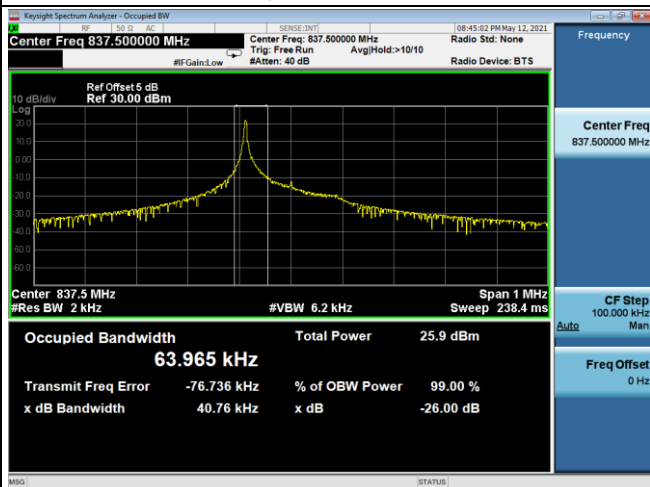

### QPSK-27039

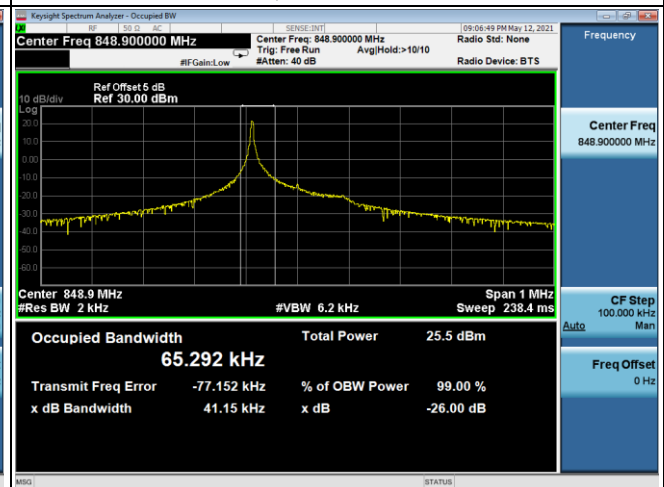

LTE Band 26_15KHz					
BPSK			1RB#0		
Channel	Frequency (MHz)	99% Occupied Bandwidth (KHz)	Channel	Frequency (MHz)	26dB Bandwidth (KHz)
26794	824.1	121.00	26794	824.1	105.5
26925	836.5	122.47	26925	836.5	119.5
27039	848.9	119.69	27039	848.9	115.9
QPSK			1RB#0		
Channel	Frequency (MHz)	99% Occupied Bandwidth (KHz)	Channel	Frequency (MHz)	26dB Bandwidth (KHz)
26794	824.1	117.30	26794	824.1	115.6
26925	836.5	115.27	26925	836.5	115.8
27039	848.9	125.94	27039	848.9	117.3
QPSK			12RB#0		
Channel	Frequency (MHz)	99% Occupied Bandwidth (KHz)	Channel	Frequency (MHz)	26dB Bandwidth (KHz)
26794	824.1	188.55	26794	824.1	250.0
26925	836.5	186.69	26925	836.5	249.9
27039	848.9	188.65	27039	848.9	249.6



## Spectrum Plot

1RB#0

### BPSK-26794

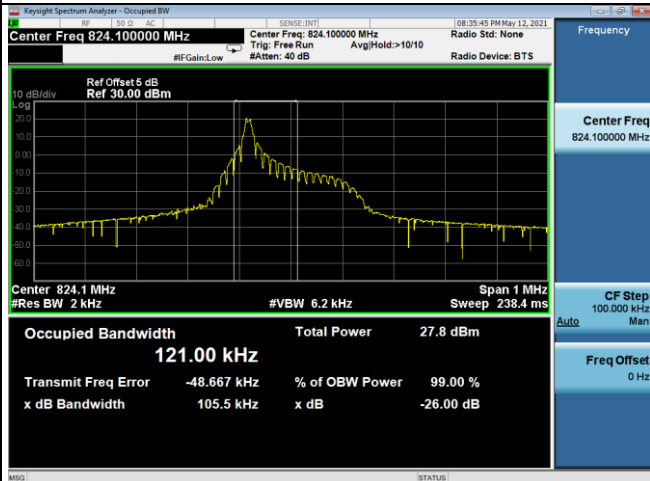

### BPSK-26925



### BPSK-27039



### QPSK-26794



### QPSK-26925



### QPSK-27039



## Spectrum Plot

12RB#0

### QPSK-26794

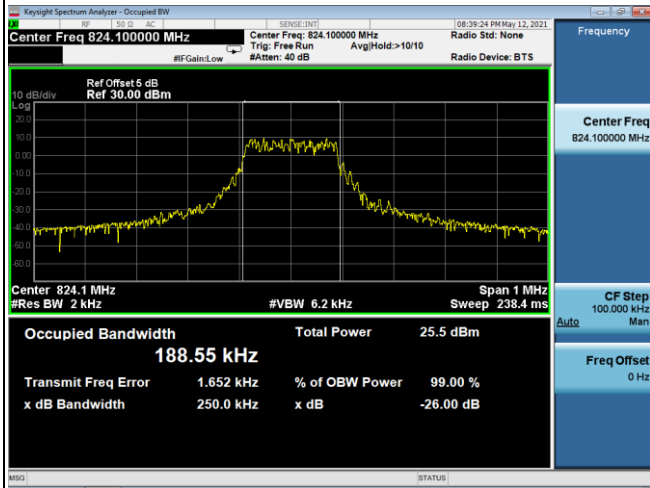

### QPSK-26925

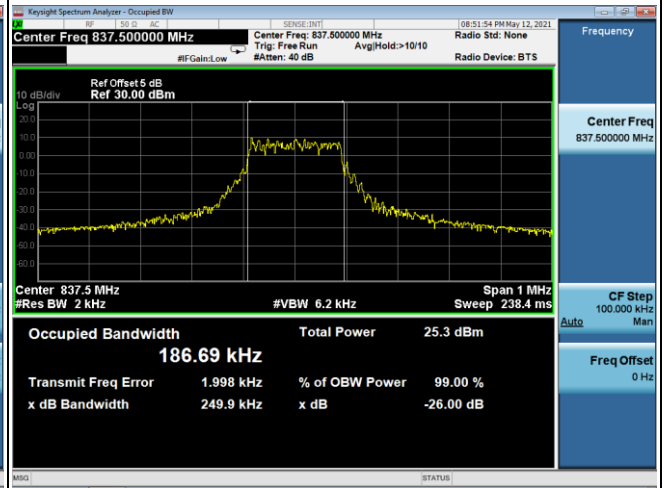

### QPSK-27039

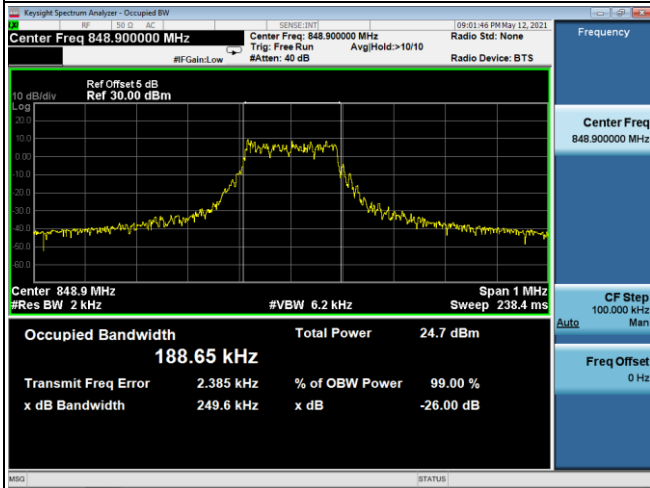

## **APPENDIX C - CONDUCTED SPURIOUS EMISSIONS**

## LTE Band 5\_BPSK\_3.75KHz Spectrum Plot

Channel	Frequency(MHz)	Channel	Frequency(MHz)
20525	836.5	20525	836.5
Channel	Frequency(MHz)	-	-
20525	836.5	-	-
		-	

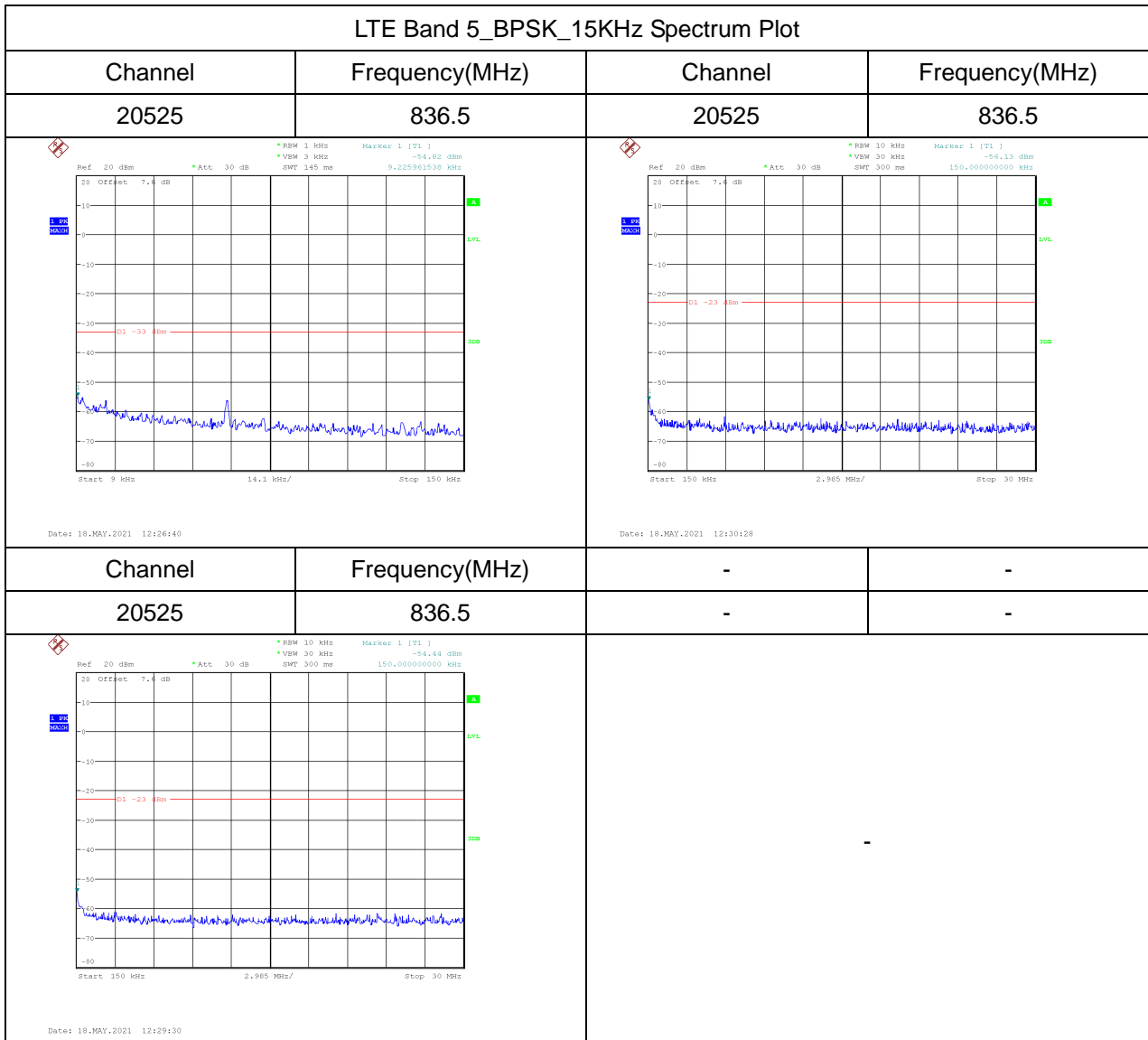

## LTE Band 26\_BPSK\_3.75KHz Spectrum Plot

Channel	Frequency(MHz)	Channel	Frequency(MHz)
26925	836.5	26925	836.5
Channel	Frequency(MHz)	-	-
26925	836.5	-	-
		-	

## LTE Band 26\_BPSK\_15KHz Spectrum Plot

Channel	Frequency(MHz)	Channel	Frequency(MHz)
26925	836.5	26925	836.5
Channel	Frequency(MHz)	-	-
26925	836.5	-	-
		-	

## LTE Band 5\_QPSK\_3.75KHz Spectrum Plot

Channel	Frequency(MHz)	Channel	Frequency(MHz)
20525	836.5	20525	836.5
Channel	Frequency(MHz)	-	-
20525	836.5	-	-
		-	



## LTE Band 5\_QPSK\_15KHz Spectrum Plot

Channel	Frequency(MHz)	Channel	Frequency(MHz)
20525	836.5	20525	836.5

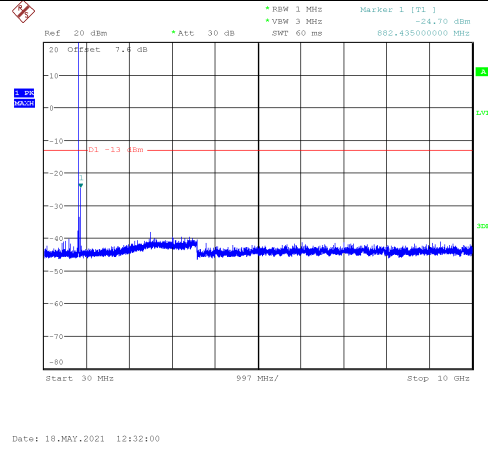
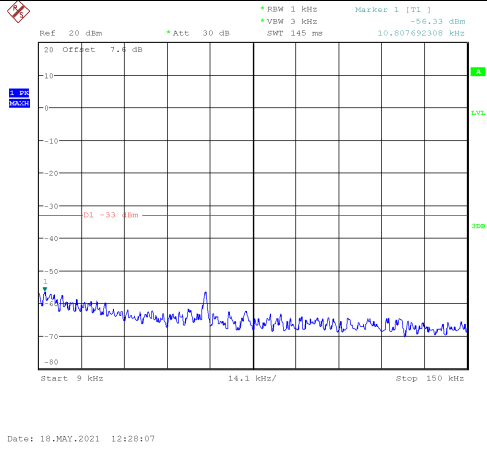

Channel	Frequency(MHz)	-	-
20525	836.5	-	-

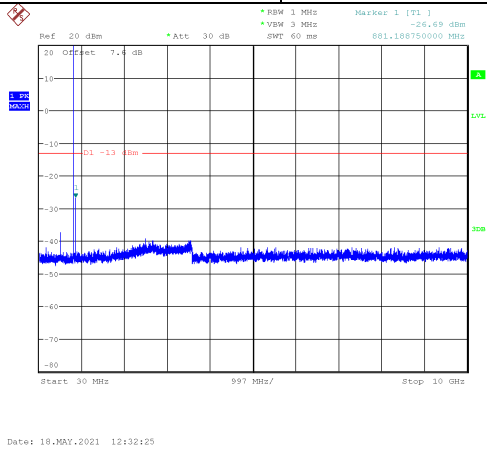

## LTE Band 26\_QPSK\_3.75KHz Spectrum Plot

Channel	Frequency(MHz)	Channel	Frequency(MHz)
26925	836.5	26925	836.5
Channel	Frequency(MHz)	-	-
26925	836.5	-	-
		-	

## LTE Band 26\_QPSK\_15KHz Spectrum Plot

Channel	Frequency(MHz)	Channel	Frequency(MHz)
26925	836.5	26925	836.5
Channel	Frequency(MHz)	-	-
26925	836.5	-	-
		-	

## **APPENDIX D - RADIATED SPURIOUS EMISSIONS (9KHZ TO 30MHZ)**

Test Mode TX Mode

Ant 0°

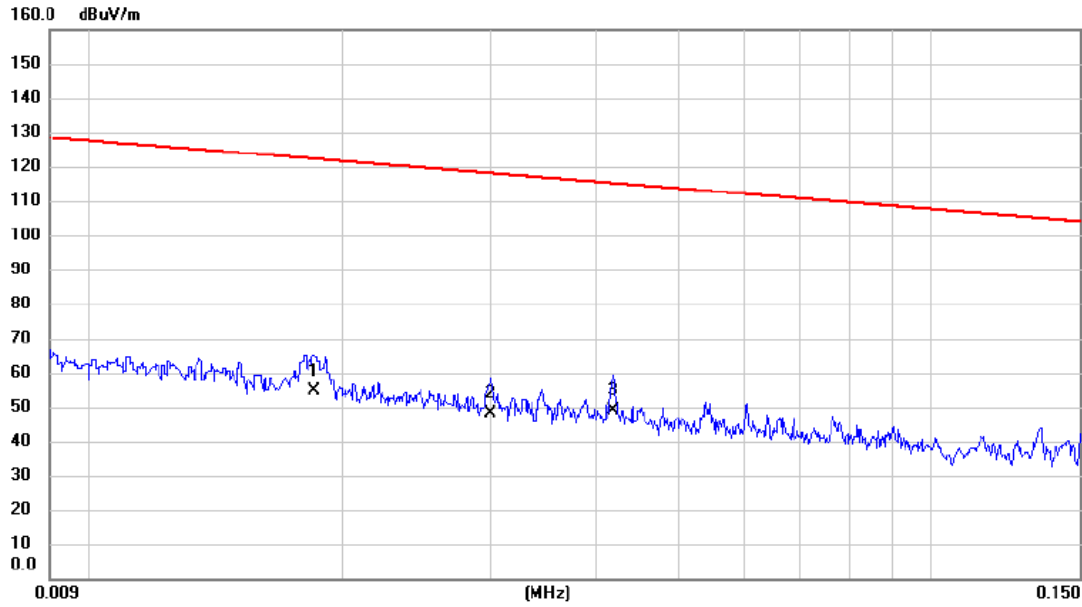

No.	Mk.	Freq.	Reading Level	Correct Factor	Measurement	Limit	Margin	Detector	Comment
		MHz	dBuV	dB	dBuV/m	dBuV/m	dB		
1		0.0185	40.88	13.68	54.56	122.26	-67.70	AVG	
2		0.0300	35.19	12.95	48.14	118.06	-69.92	AVG	
3	*	0.0420	36.24	12.63	48.87	115.14	-66.27	AVG	

Test Mode TX Mode

Ant 0°

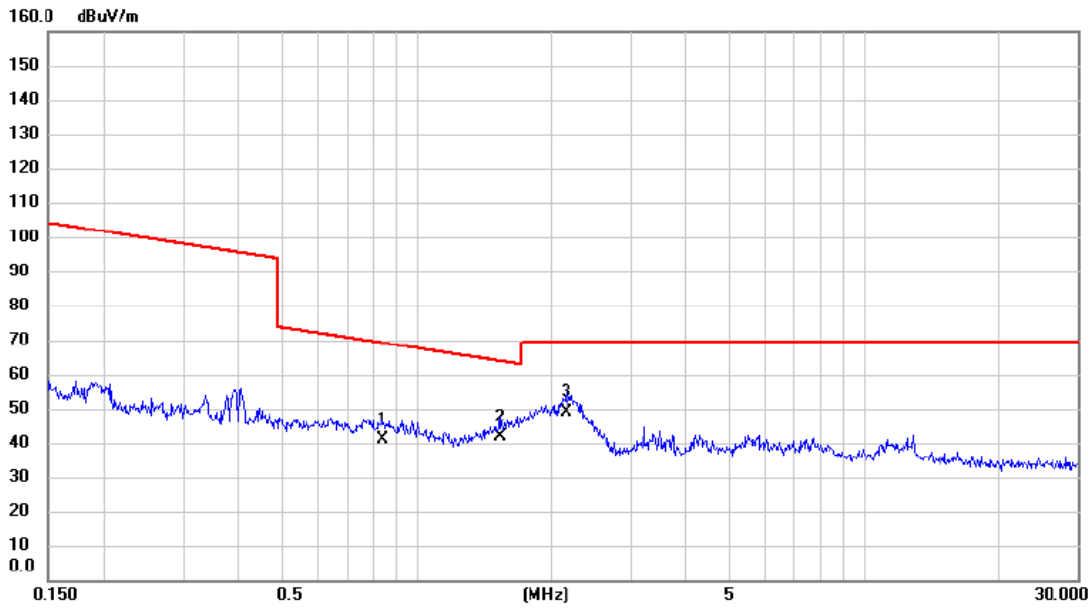

No.	Mk.	Freq. MHz	Reading Level dBuV	Correct Factor dB	Measure- ment dBuV/m	Limit dBuV/m	Margin dB	Detector	Comment
1		0.8350	28.98	11.87	40.85	69.17	-28.32	QP	
2		1.5355	30.24	11.53	41.77	63.88	-22.11	QP	
3	*	2.1552	37.65	11.23	48.88	69.54	-20.66	QP	

Test Mode TX Mode

Ant 90°

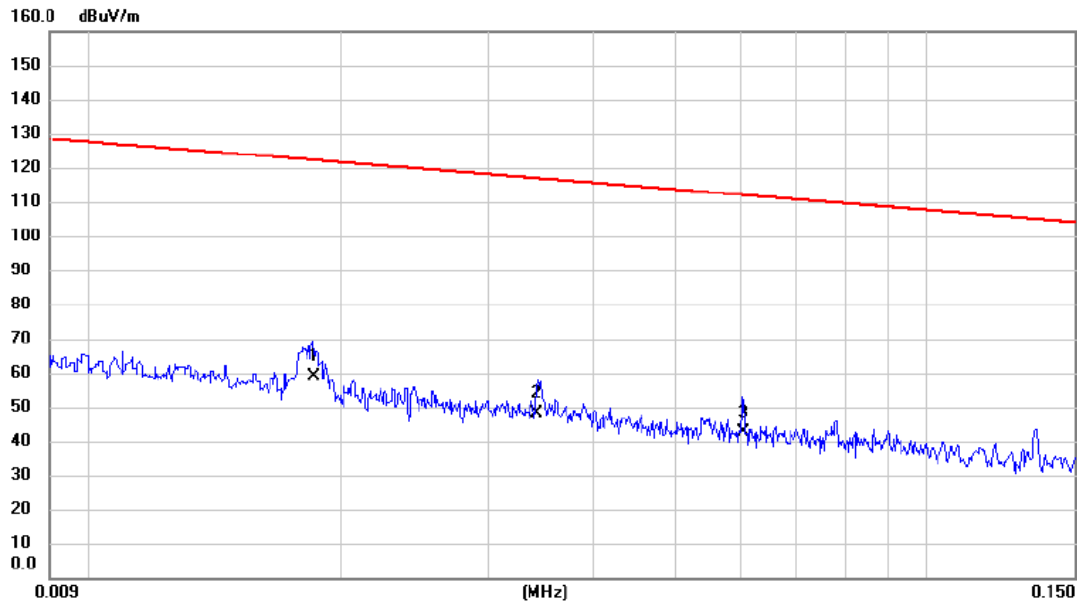

No.	Mk.	Freq.	Reading Level	Correct Factor	Measurement	Limit	Margin	Detector	Comment
		MHz	dBuV	dB	dBuV/m	dBuV/m	dB		
1	*	0.0186	45.18	13.65	58.83	122.21	-63.38	AVG	
2		0.0343	35.27	12.84	48.11	116.90	-68.79	AVG	
3		0.0603	30.06	12.48	42.54	112.00	-69.46	AVG	

Test Mode TX Mode

Ant 90°

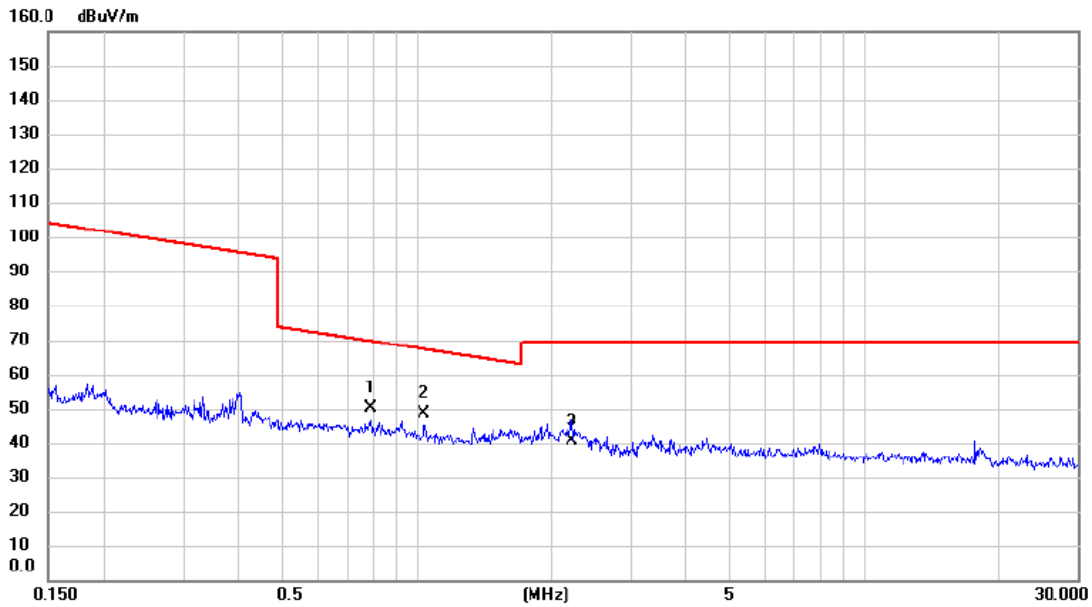

No.	Mk.	Freq. MHz	Reading Level dBuV	Correct Factor dB	Measure- ment dBuV/m	Limit dBuV/m	Margin dB	Detector	Comment
1		0.7876	38.41	11.88	50.29	69.68	-19.39	QP	
2	*	1.0374	36.74	11.78	48.52	67.29	-18.77	QP	
3		2.2250	29.25	11.20	40.45	69.54	-29.09	QP	



## **APPENDIX E - RADIATED SPURIOUS EMISSIONS (30MHZ TO 1000MHZ)**

Test Mode LTE Band 5\_BPSK\_TX CH20525\_3.75KHz

### Vertical

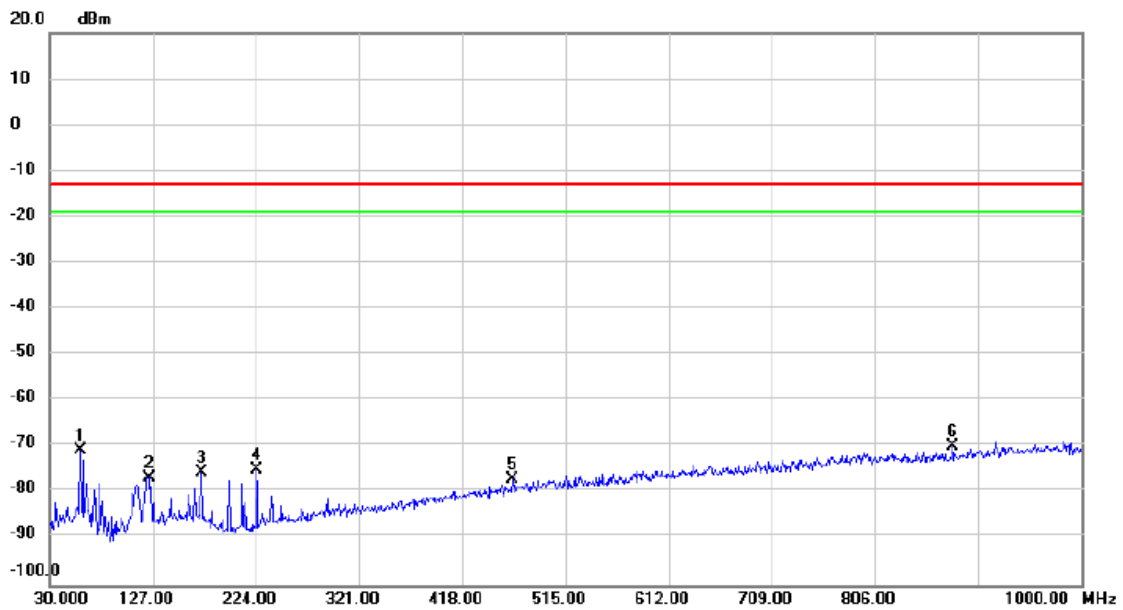

No.	Mk.	Freq. MHz	Reading Level dBm	Correct Factor dB	Measure- ment dBm	Limit dBm	Margin dB	Detector	Comment
1		59.585	-56.34	-14.42	-70.76	-13.00	-57.76	peak	
2		123.120	-62.70	-13.92	-76.62	-13.00	-63.62	peak	
3		172.590	-62.78	-12.86	-75.64	-13.00	-62.64	peak	
4		224.485	-60.64	-14.42	-75.06	-13.00	-62.06	peak	
5		464.560	-69.92	-7.15	-77.07	-13.00	-64.07	peak	
6	*	879.235	-69.85	-0.10	-69.95	-13.00	-56.95	peak	

Test Mode LTE Band 5\_BPSK\_TX CH20525\_3.75KHz

### Horizontal

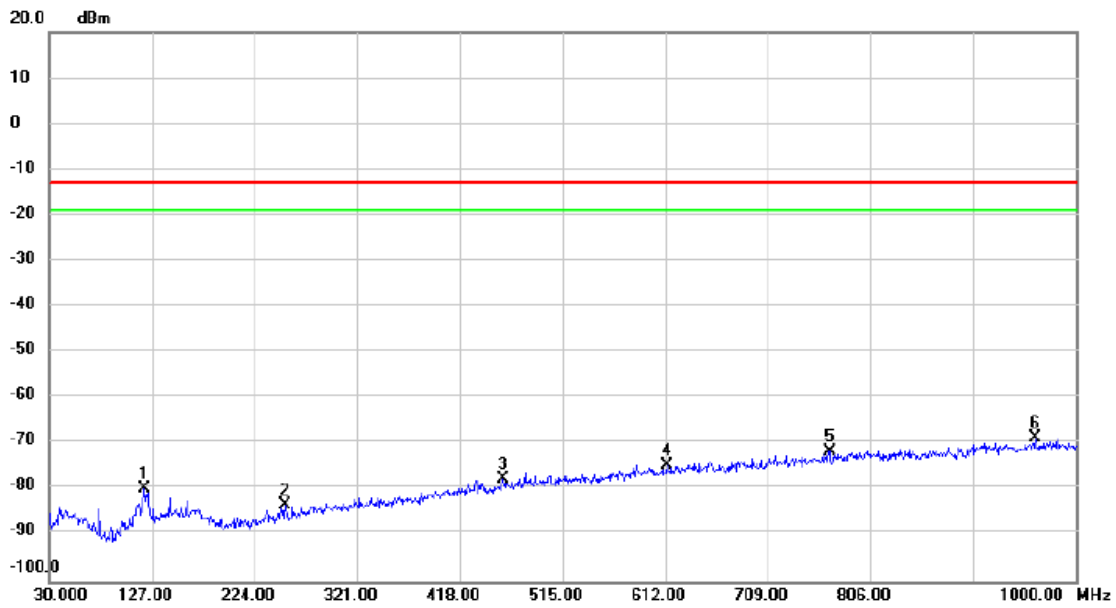

No. Mk.	Freq. MHz	Reading Level dBm	Correct Factor dB	Measurement dBm	Limit dBm	Margin dB	Detector	Comment
1	120.210	-65.53	-14.15	-79.68	-13.00	-66.68	peak	
2	253.585	-70.45	-12.80	-83.25	-13.00	-70.25	peak	
3	458.740	-70.46	-7.25	-77.71	-13.00	-64.71	peak	
4	614.425	-70.28	-4.32	-74.60	-13.00	-61.60	peak	
5	767.200	-70.18	-1.51	-71.69	-13.00	-58.69	peak	
6 *	961.200	-70.54	1.81	-68.73	-13.00	-55.73	peak	

Test Mode LTE Band 5\_BPSK\_TX CH20525\_15KHz

### Vertical

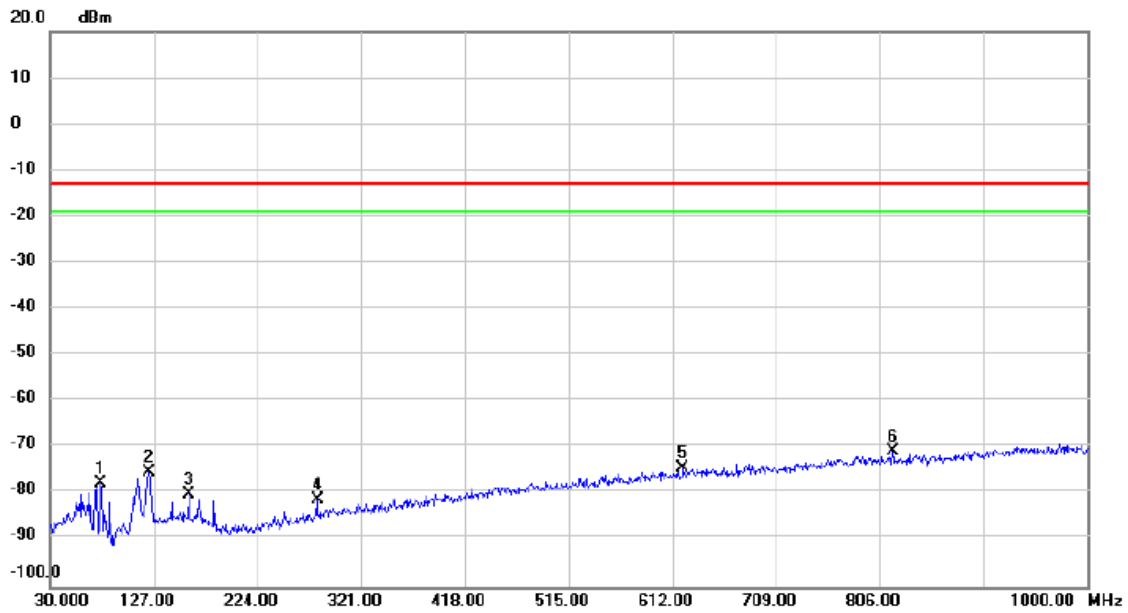

No.	Mk.	Freq. MHz	Reading Level dBm	Correct Factor dB	Measure- ment dBm	Limit dBm	Margin dB	Detector	Comment
1		77.530	-59.94	-17.86	-77.80	-13.00	-64.80	peak	
2		122.635	-61.24	-13.95	-75.19	-13.00	-62.19	peak	
3		160.465	-67.61	-12.38	-79.99	-13.00	-66.99	peak	
4		279.775	-69.58	-11.58	-81.16	-13.00	-68.16	peak	
5		622.185	-70.12	-4.19	-74.31	-13.00	-61.31	peak	
6	*	817.640	-70.11	-0.67	-70.78	-13.00	-57.78	peak	

Test Mode LTE Band 5\_BPSK\_TX CH20525\_15KHz

### Horizontal

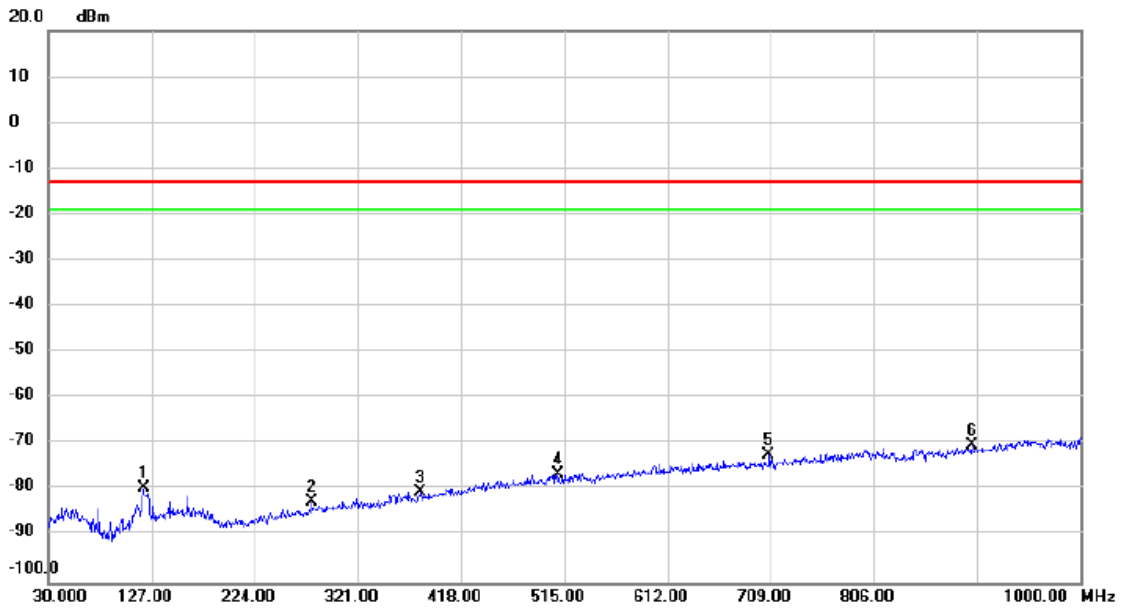

No.	Mk.	Freq. MHz	Reading Level dBm	Correct Factor dB	Measure- ment dBm	Limit dBm	Margin dB	Detector	Comment
1		119.725	-65.42	-14.18	-79.60	-13.00	-66.60	peak	
2		277.350	-70.65	-11.73	-82.38	-13.00	-69.38	peak	
3		379.200	-71.13	-9.27	-80.40	-13.00	-67.40	peak	
4		509.180	-70.13	-6.43	-76.56	-13.00	-63.56	peak	
5		707.060	-69.22	-2.92	-72.14	-13.00	-59.14	peak	
6	*	898.150	-70.46	0.24	-70.22	-13.00	-57.22	peak	

Test Mode      LTE Band 26\_BPSK\_TX CH26925\_3.75KHz

### Vertical

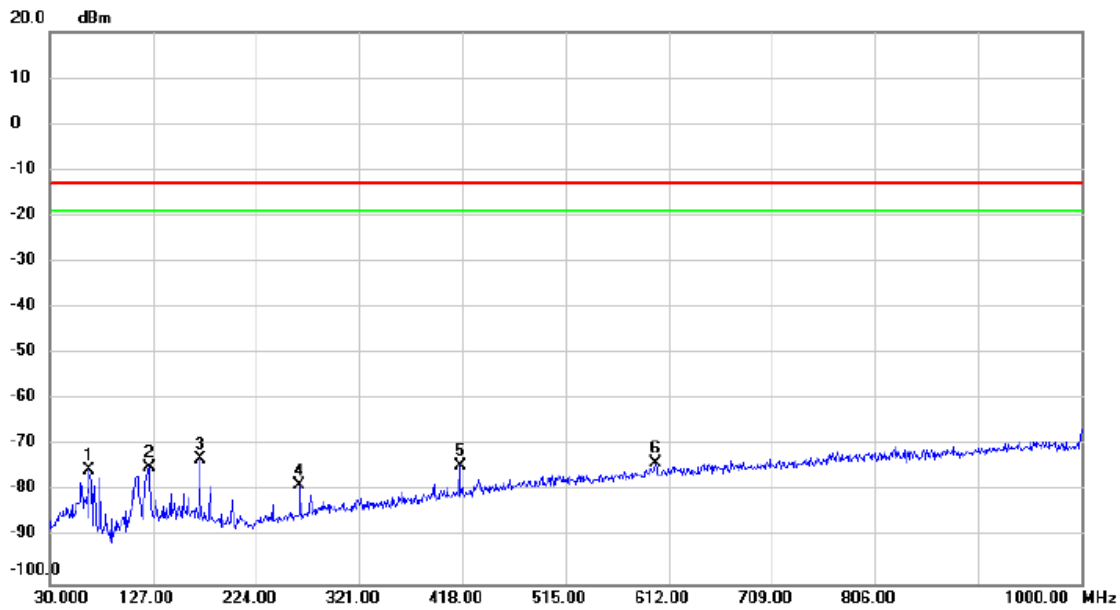

No.	Mk.	Freq. MHz	Reading Level dBm	Correct Factor dB	Measure- ment dBm	Limit dBm	Margin dB	Detector	Comment
1		67.345	-59.58	-15.68	-75.26	-13.00	-62.26	peak	
2		123.120	-60.85	-13.92	-74.77	-13.00	-61.77	peak	
3	*	171.135	-60.15	-12.70	-72.85	-13.00	-59.85	peak	
4		264.740	-66.12	-12.38	-78.50	-13.00	-65.50	peak	
5		415.575	-66.02	-8.35	-74.37	-13.00	-61.37	peak	
6		599.875	-69.24	-4.55	-73.79	-13.00	-60.79	peak	

Test Mode LTE Band 26\_BPSK\_TX CH26925\_3.75KHz

### Horizontal

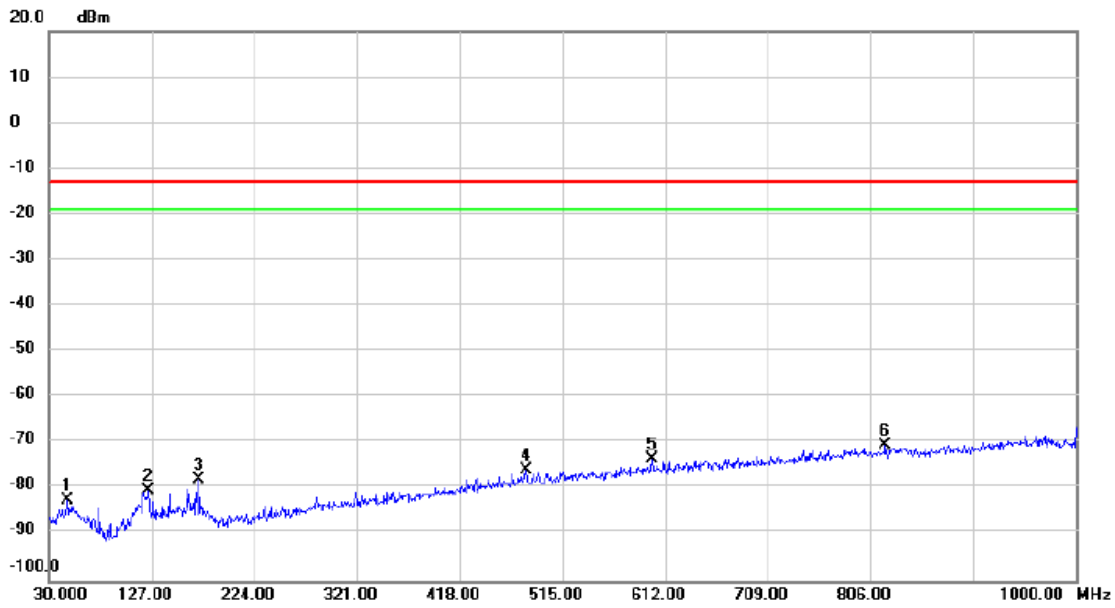

No.	Mk.	Freq. MHz	Reading Level dBm	Correct Factor dB	Measure- ment dBm	Limit dBm	Margin dB	Detector	Comment
1		47.460	-68.72	-13.86	-82.58	-13.00	-69.58	peak	
2		124.090	-66.64	-13.85	-80.49	-13.00	-67.49	peak	
3		171.620	-65.16	-12.75	-77.91	-13.00	-64.91	peak	
4		480.080	-69.09	-6.88	-75.97	-13.00	-62.97	peak	
5		599.875	-69.00	-4.55	-73.55	-13.00	-60.55	peak	
6	*	819.580	-69.74	-0.67	-70.41	-13.00	-57.41	peak	

Test Mode LTE Band 26\_BPSK\_TX CH26925\_15KHz

### Vertical

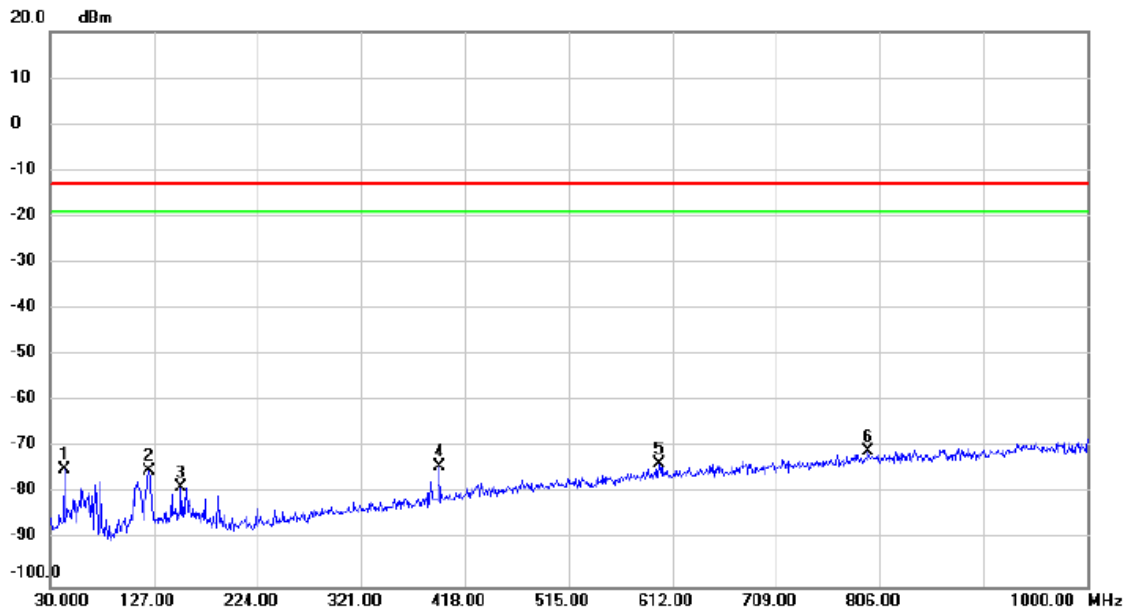

No.	Mk.	Freq. MHz	Reading Level dBm	Correct Factor dB	Measure- ment dBm	Limit dBm	Margin dB	Detector	Comment
1		43.095	-60.82	-13.95	-74.77	-13.00	-61.77	peak	
2		122.635	-60.86	-13.95	-74.81	-13.00	-61.81	peak	
3		152.705	-65.91	-12.56	-78.47	-13.00	-65.47	peak	
4		393.750	-65.01	-8.93	-73.94	-13.00	-60.94	peak	
5		599.875	-68.82	-4.55	-73.37	-13.00	-60.37	peak	
6	*	795.330	-69.86	-0.80	-70.66	-13.00	-57.66	peak	



Test Mode LTE Band 26\_BPSK\_TX CH26925\_15KHz

### Horizontal

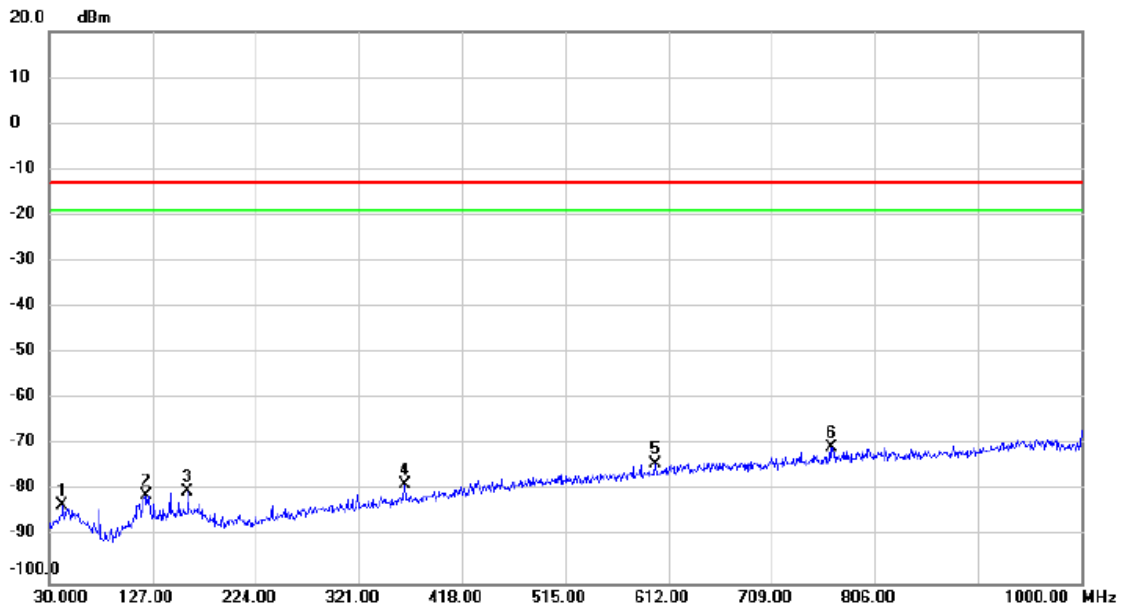

No.	Mk.	Freq. MHz	Reading Level dBm	Correct Factor dB	Measure- ment dBm	Limit dBm	Margin dB	Detector	Comment
1		42.610	-69.10	-13.95	-83.05	-13.00	-70.05	peak	
2		120.695	-66.79	-14.10	-80.89	-13.00	-67.89	peak	
3		159.980	-67.79	-12.37	-80.16	-13.00	-67.16	peak	
4		363.680	-68.97	-9.63	-78.60	-13.00	-65.60	peak	
5		599.875	-69.50	-4.55	-74.05	-13.00	-61.05	peak	
6	*	764.775	-68.79	-1.57	-70.36	-13.00	-57.36	peak	

Test Mode LTE Band 5\_QPSK\_TX CH20525\_3.75KHz

### Vertical

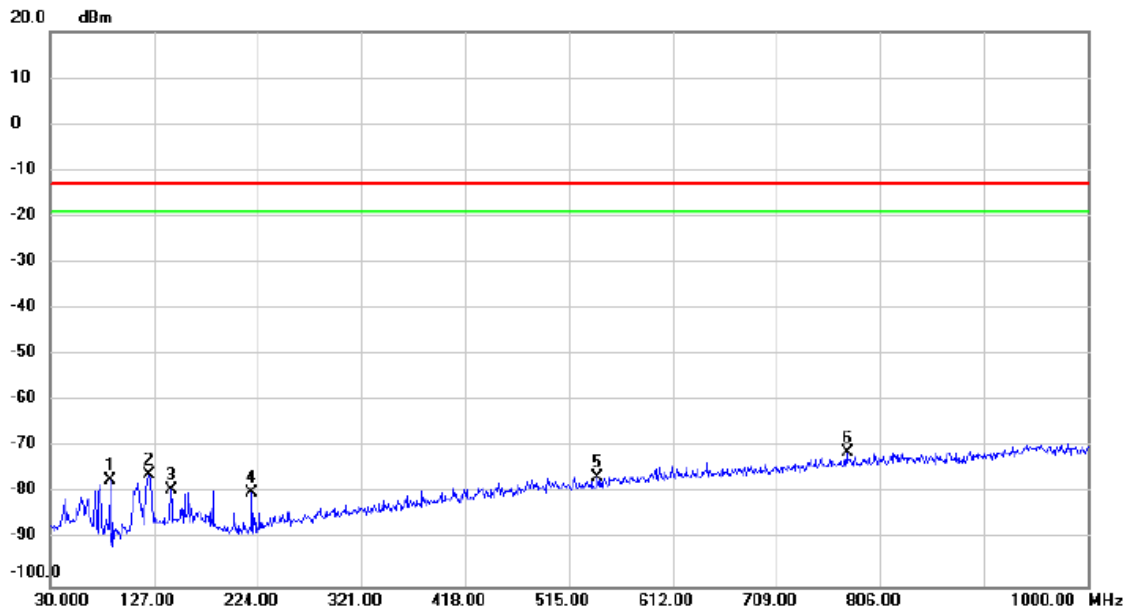

No.	Mk.	Freq. MHz	Reading Level dBm	Correct Factor dB	Measure- ment dBm	Limit dBm	Margin dB	Detector	Comment
1		85.775	-58.47	-18.65	-77.12	-13.00	-64.12	peak	
2		122.150	-61.77	-13.99	-75.76	-13.00	-62.76	peak	
3		142.520	-66.28	-12.82	-79.10	-13.00	-66.10	peak	
4		218.180	-64.86	-14.89	-79.75	-13.00	-66.75	peak	
5		541.675	-70.32	-6.00	-76.32	-13.00	-63.32	peak	
6	*	775.445	-69.89	-1.30	-71.19	-13.00	-58.19	peak	

Test Mode LTE Band 5\_QPSK\_TX CH20525\_3.75KHz

### Horizontal

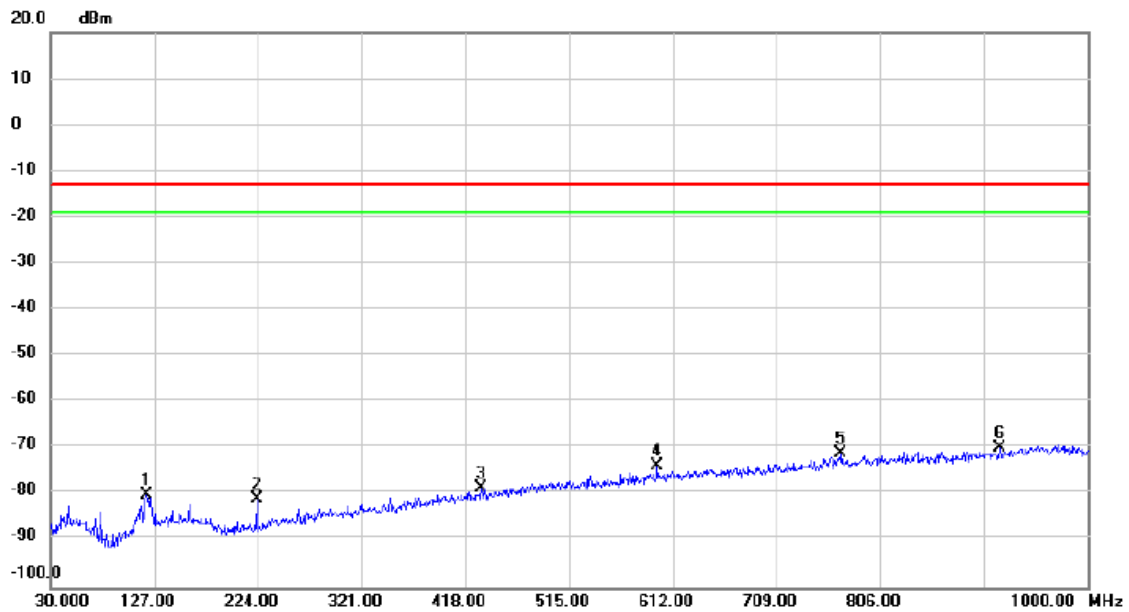

No.	Mk.	Freq. MHz	Reading Level dBm	Correct Factor dB	Measure- ment dBm	Limit dBm	Margin dB	Detector	Comment
1		120.210	-65.85	-14.15	-80.00	-13.00	-67.00	peak	
2		223.515	-66.42	-14.50	-80.92	-13.00	-67.92	peak	
3		433.035	-70.78	-7.88	-78.66	-13.00	-65.66	peak	
4		597.450	-69.25	-4.62	-73.87	-13.00	-60.87	peak	
5		769.625	-69.72	-1.44	-71.16	-13.00	-58.16	peak	
6	*	917.550	-70.78	0.81	-69.97	-13.00	-56.97	peak	

Test Mode LTE Band 5\_QPSK\_TX CH20525\_15KHz

### Vertical

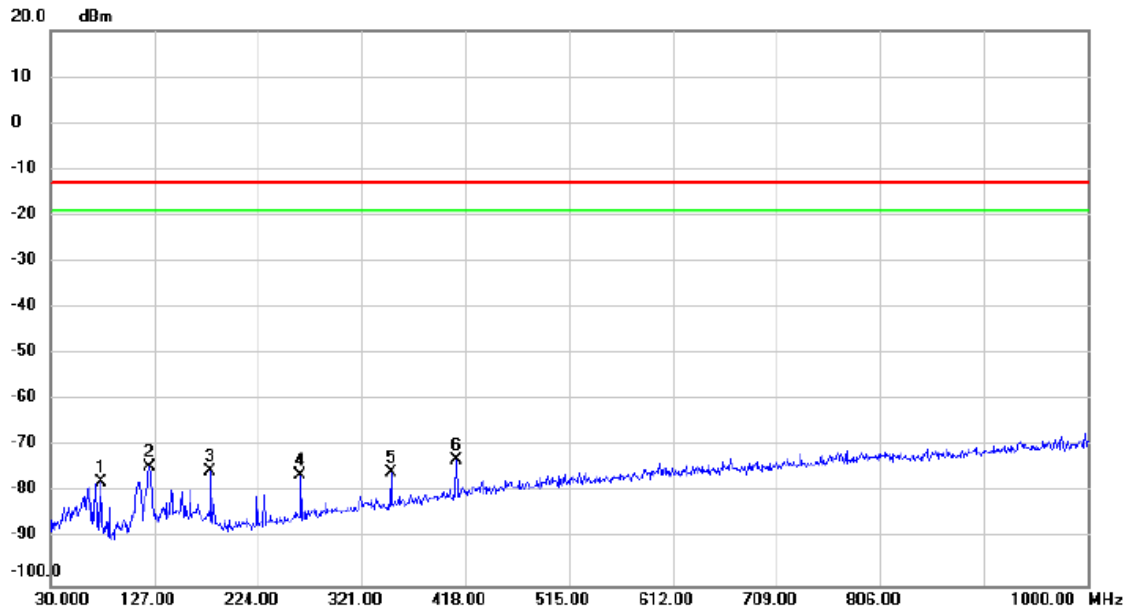

No.	Mk.	Freq. MHz	Reading Level dBm	Correct Factor dB	Measure- ment dBm	Limit dBm	Margin dB	Detector	Comment
1		77.530	-59.70	-17.86	-77.56	-13.00	-64.56	peak	
2		122.150	-60.22	-13.99	-74.21	-13.00	-61.21	peak	
3		179.865	-61.57	-13.62	-75.19	-13.00	-62.19	peak	
4		263.770	-63.84	-12.41	-76.25	-13.00	-63.25	peak	
5		348.645	-65.66	-9.99	-75.65	-13.00	-62.65	peak	
6	*	409.755	-64.48	-8.51	-72.99	-13.00	-59.99	peak	

Test Mode LTE Band 5\_QPSK\_TX CH20525\_15KHz

### Horizontal

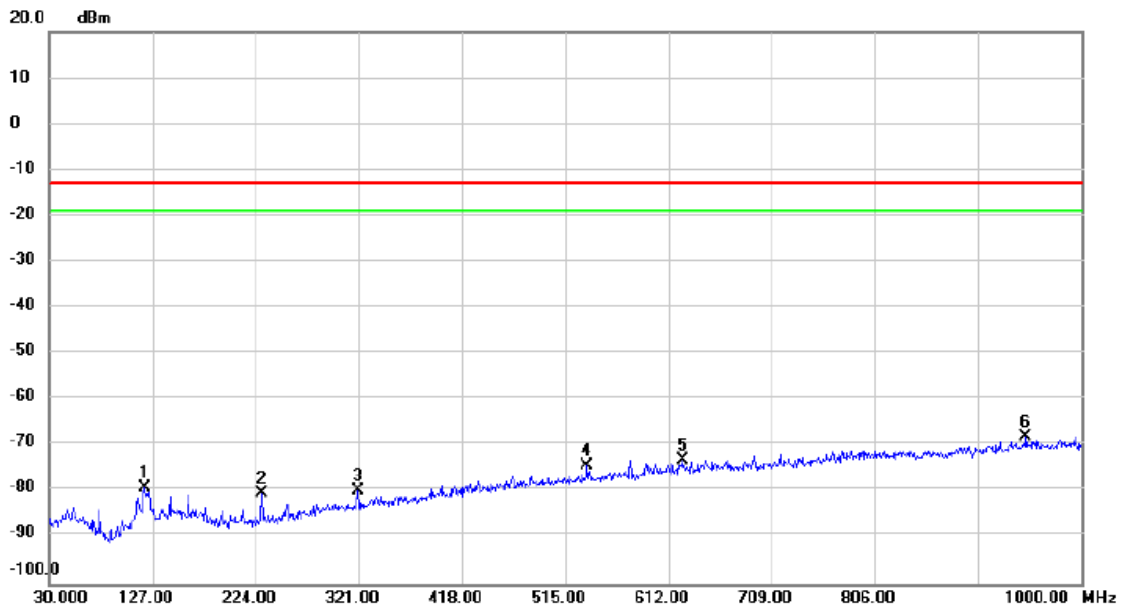

No.	Mk.	Freq. MHz	Reading Level dBm	Correct Factor dB	Measure- ment dBm	Limit dBm	Margin dB	Detector	Comment
1		120.210	-64.96	-14.15	-79.11	-13.00	-66.11	peak	
2		230.305	-66.32	-13.92	-80.24	-13.00	-67.24	peak	
3		320.030	-69.31	-10.52	-79.83	-13.00	-66.83	peak	
4		535.370	-68.31	-6.08	-74.39	-13.00	-61.39	peak	
5		625.095	-69.09	-4.14	-73.23	-13.00	-60.23	peak	
6	*	948.105	-69.77	1.74	-68.03	-13.00	-55.03	peak	

Test Mode LTE Band 26\_QPSK\_TX CH26925\_3.75KHz

### Vertical

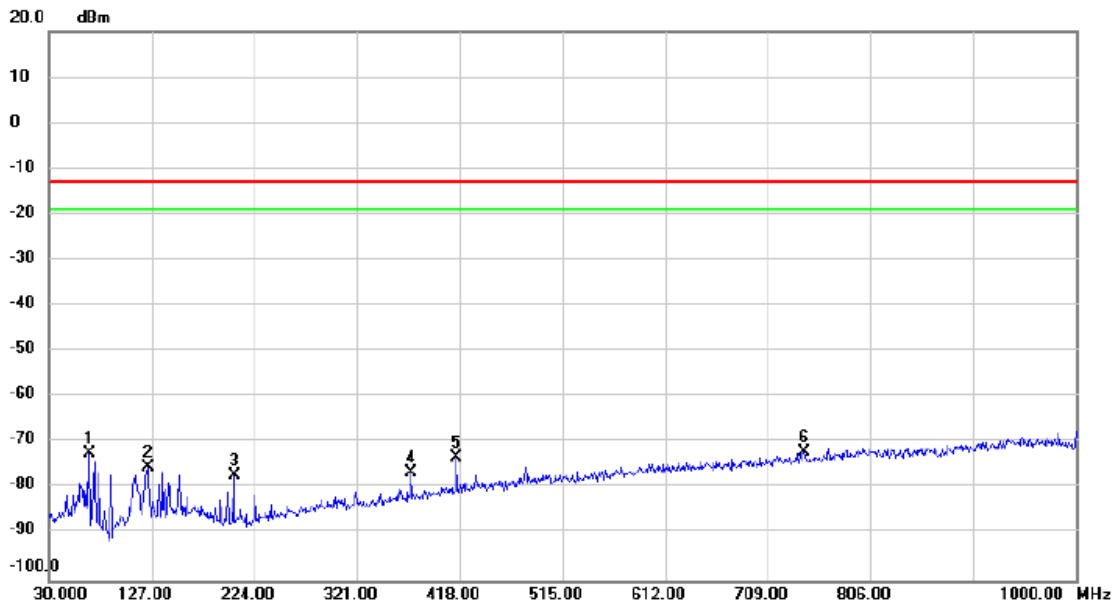

No.	Mk.	Freq. MHz	Reading Level dBm	Correct Factor dB	Measure- ment dBm	Limit dBm	Margin dB	Detector	Comment
1		67.830	-56.58	-15.77	-72.35	-13.00	-59.35	peak	
2		123.605	-61.39	-13.89	-75.28	-13.00	-62.28	peak	
3		204.600	-61.86	-15.33	-77.19	-13.00	-64.19	peak	
4		371.925	-67.13	-9.45	-76.58	-13.00	-63.58	peak	
5		415.090	-64.79	-8.37	-73.16	-13.00	-60.16	peak	
6	*	742.950	-69.80	-2.10	-71.90	-13.00	-58.90	peak	

Test Mode LTE Band 26\_QPSK\_TX CH26925\_3.75KHz

### Horizontal

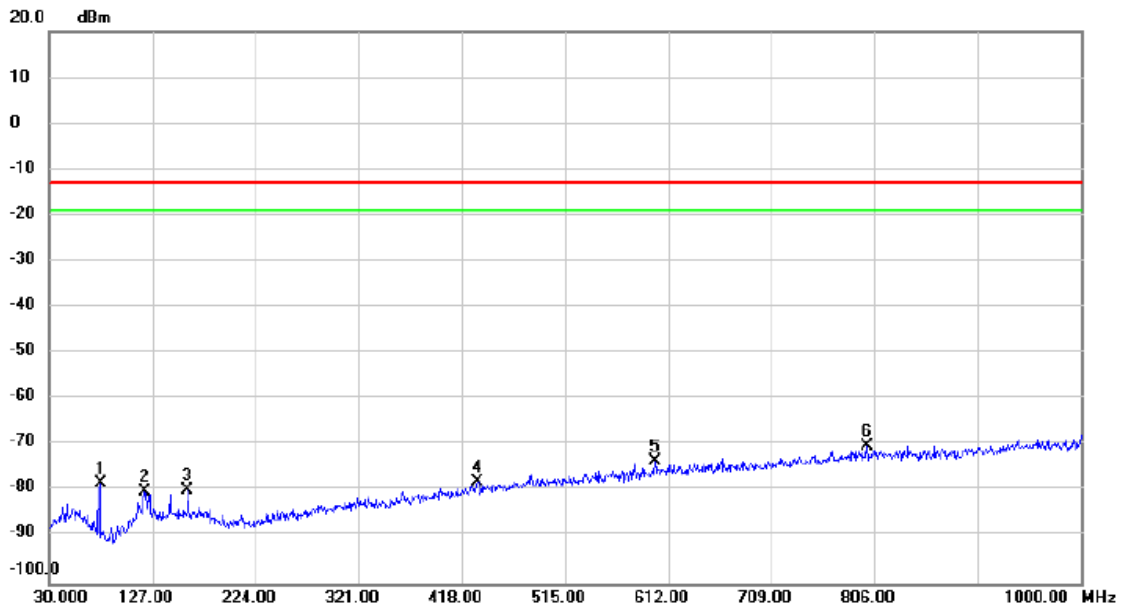

No. Mk.	Freq. MHz	Reading Level dBm	Correct Factor dB	Measure- ment dBm	Limit dBm	Margin dB	Detector	Comment
1	78.015	-60.40	-17.96	-78.36	-13.00	-65.36	peak	
2	119.240	-65.94	-14.22	-80.16	-13.00	-67.16	peak	
3	159.980	-67.45	-12.37	-79.82	-13.00	-66.82	peak	
4	433.035	-70.05	-7.88	-77.93	-13.00	-64.93	peak	
5	599.875	-68.96	-4.55	-73.51	-13.00	-60.51	peak	
6 *	798.240	-69.42	-0.73	-70.15	-13.00	-57.15	peak	

Test Mode LTE Band 26\_QPSK\_TX CH26925\_15KHz

### Vertical

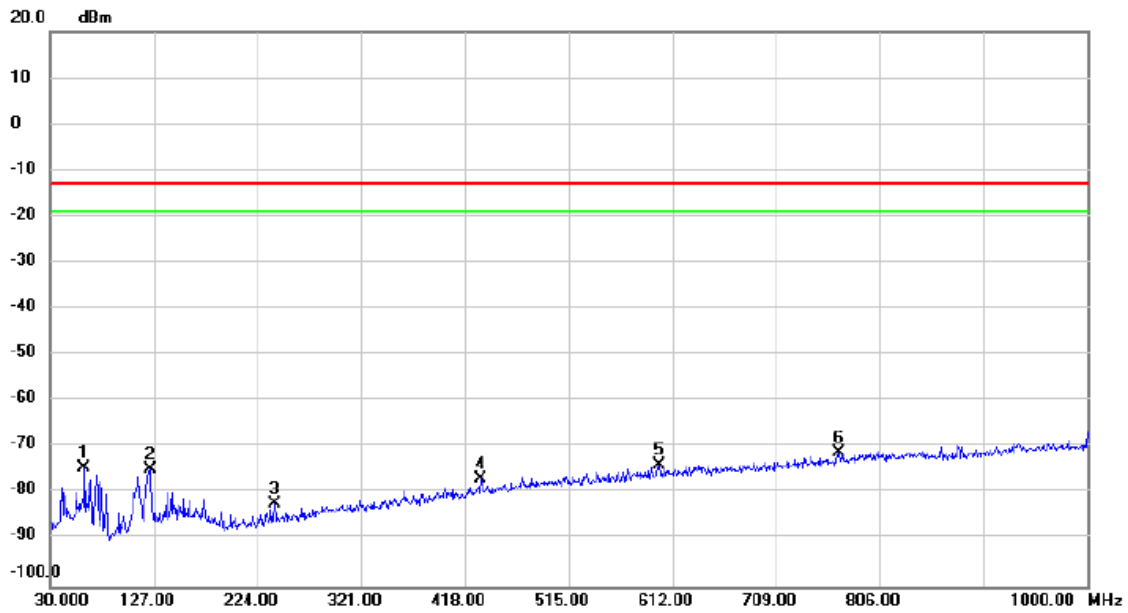

No.	Mk.	Freq. MHz	Reading Level dBm	Correct Factor dB	Measure- ment dBm	Limit dBm	Margin dB	Detector	Comment
1		62.010	-59.48	-14.77	-74.25	-13.00	-61.25	peak	
2		123.120	-60.63	-13.92	-74.55	-13.00	-61.55	peak	
3		240.005	-68.79	-13.38	-82.17	-13.00	-69.17	peak	
4		433.035	-68.93	-7.88	-76.81	-13.00	-63.81	peak	
5		599.875	-69.25	-4.55	-73.80	-13.00	-60.80	peak	
6	*	767.200	-69.51	-1.51	-71.02	-13.00	-58.02	peak	



Test Mode LTE Band 26\_QPSK\_TX CH26925\_15KHz

### Horizontal

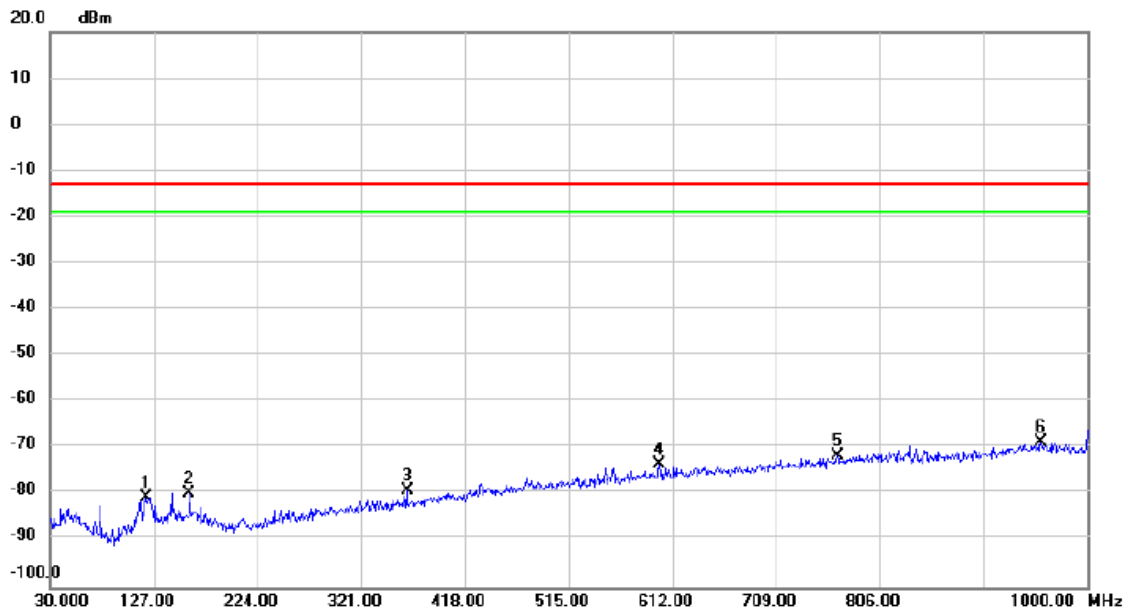

No.	Mk.	Freq. MHz	Reading Level dBm	Correct Factor dB	Measure- ment dBm	Limit dBm	Margin dB	Detector	Comment
1		119.240	-66.29	-14.22	-80.51	-13.00	-67.51	peak	
2		159.980	-67.24	-12.37	-79.61	-13.00	-66.61	peak	
3		363.680	-69.54	-9.63	-79.17	-13.00	-66.17	peak	
4		599.875	-68.84	-4.55	-73.39	-13.00	-60.39	peak	
5		766.230	-70.19	-1.53	-71.72	-13.00	-58.72	peak	
6	*	956.350	-70.32	1.80	-68.52	-13.00	-55.52	peak	

## **APPENDIX F - RADIATED SPURIOUS EMISSIONS (ABOVE 1000MHZ)**

Test Mode      LTE Band 5\_BPSK\_TX CH20525\_3.75KHz

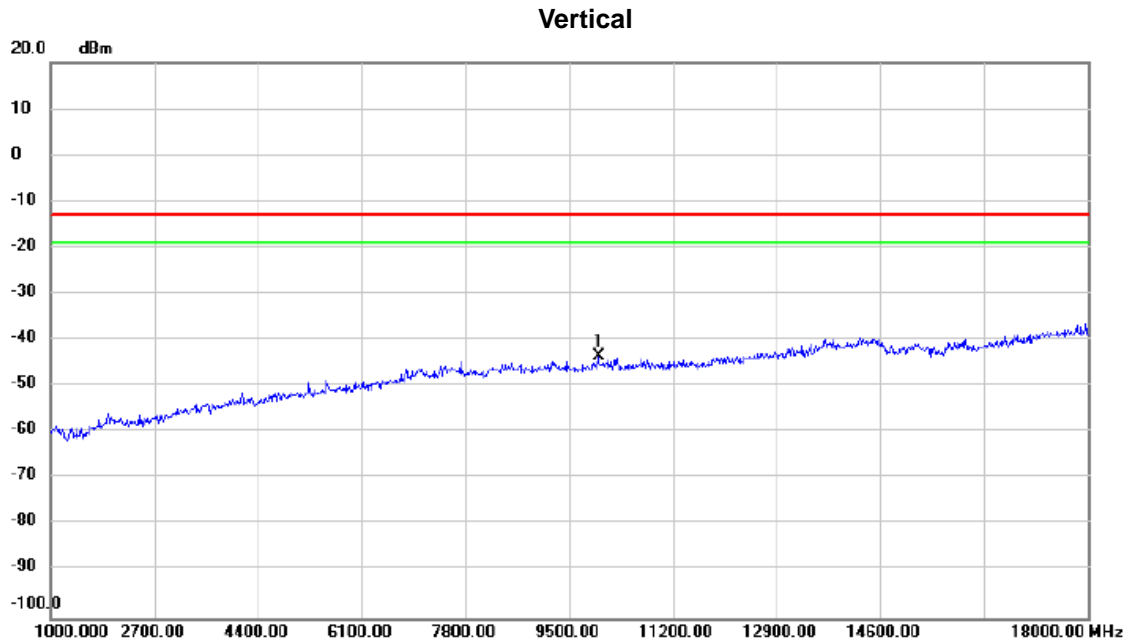

No.	Mk.	Freq. MHz	Reading Level dBm	Correct Factor dB	Measure- ment dBm	Limit dBm	Margin dB	Detector	Comment
1	*	9976.000	-55.38	12.03	-43.35	-13.00	-30.35	peak	

Test Mode      LTE Band 5\_BPSK\_TX CH20525\_3.75KHz

### Horizontal

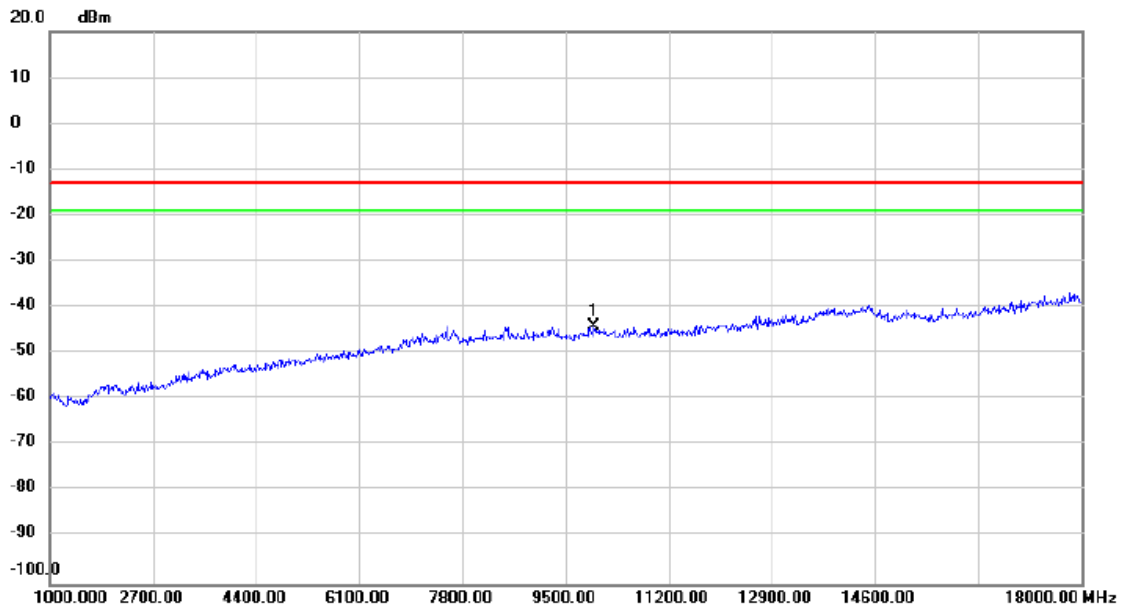

No.	Mk.	Freq. MHz	Reading Level dBm	Correct Factor dB	Measure- ment dBm	Limit dBm	Margin dB	Detector	Comment
1	*	9967.500	-56.09	12.01	-44.08	-13.00	-31.08	peak	

Test Mode LTE Band 5\_BPSK\_TX CH20525\_15KHz

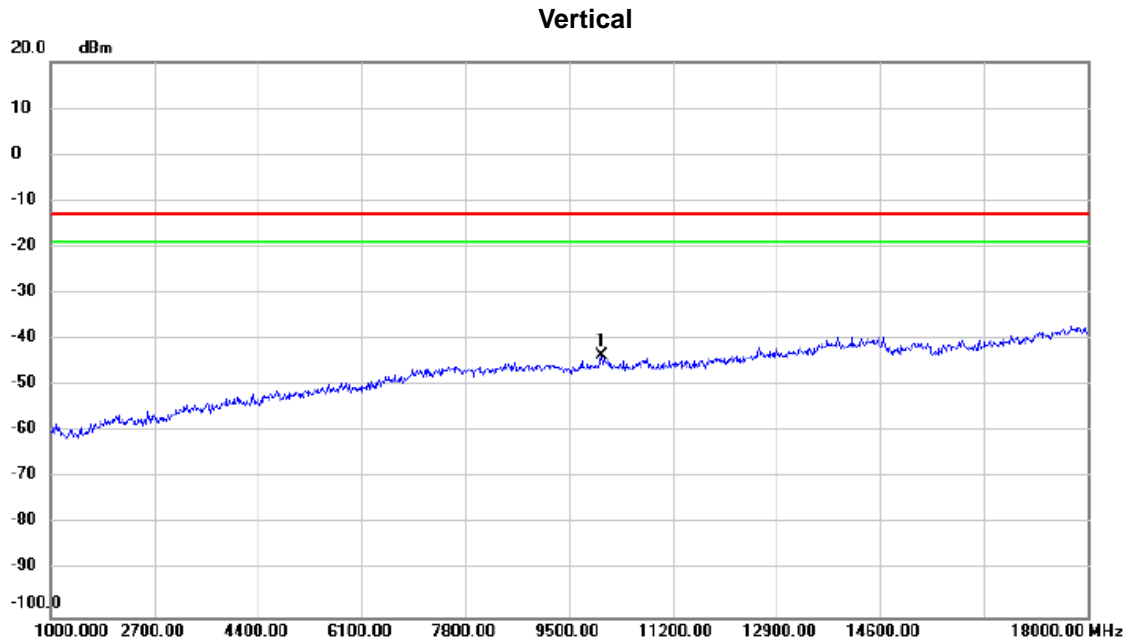

No.	Mk.	Freq. MHz	Reading Level dBm	Correct Factor dB	Measure- ment dBm	Limit dBm	Margin dB	Detector	Comment
1	*	10027.000	-55.66	12.08	-43.58	-13.00	-30.58	peak	

Test Mode      LTE Band 5\_BPSK\_TX CH20525\_15KHz

### Horizontal

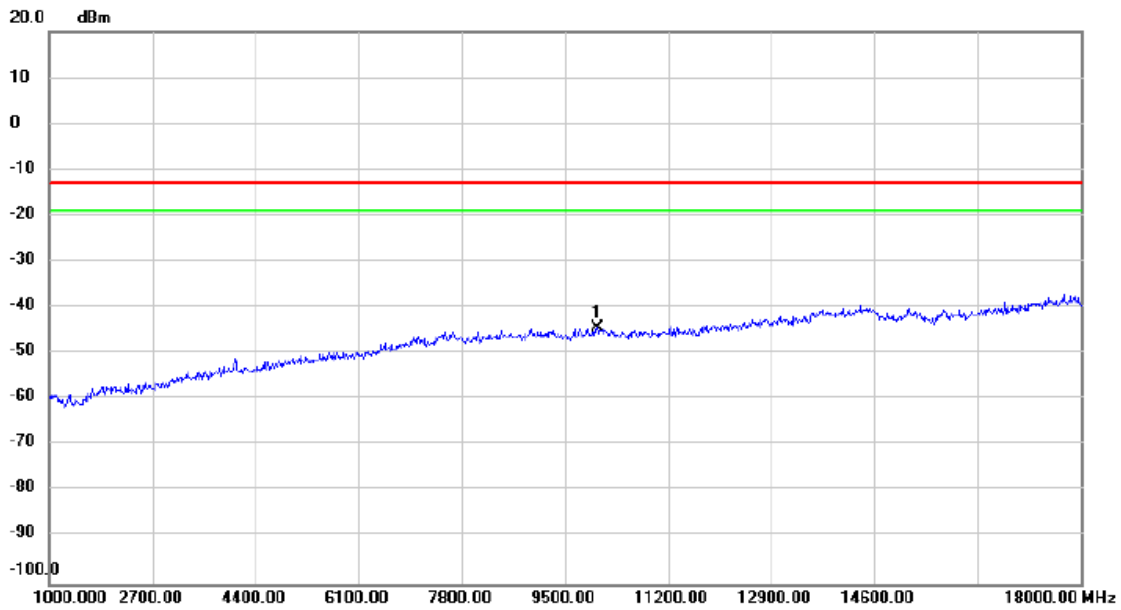

No.	Mk.	Freq. MHz	Reading Level dBm	Correct Factor dB	Measure- ment dBm	Limit dBm	Margin dB	Detector	Comment
1	*	10035.500	-56.47	12.09	-44.38	-13.00	-31.38	peak	

Test Mode      LTE Band 26\_BPSK\_TX CH26925\_3.75KHz

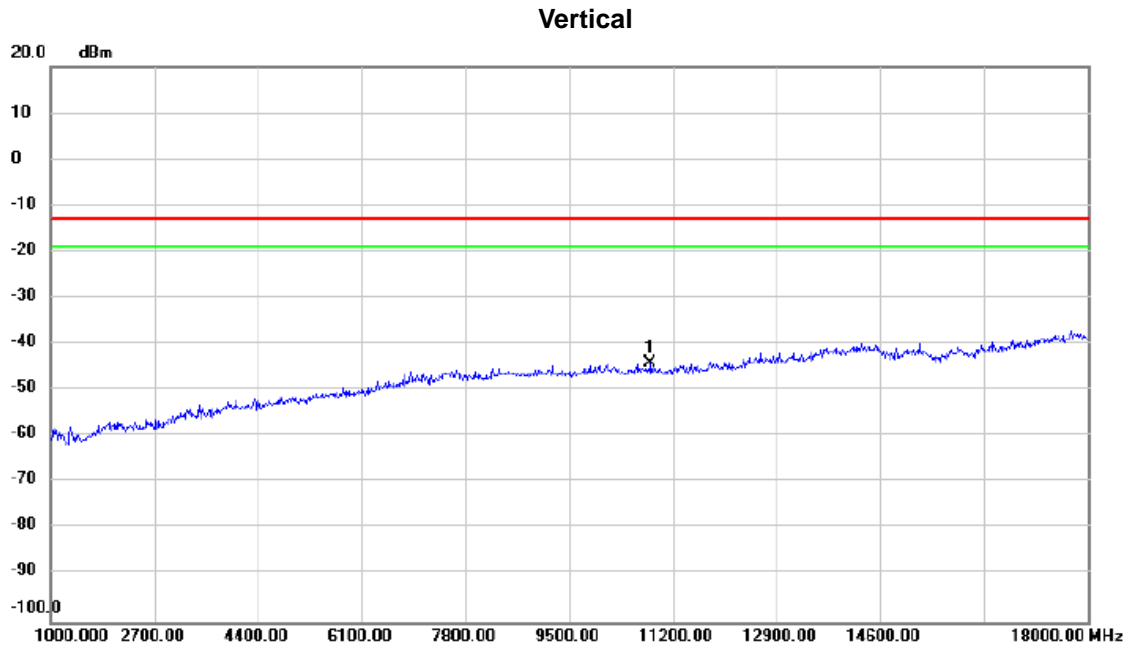

No.	Mk.	Freq. MHz	Reading Level dBm	Correct Factor dB	Measure- ment dBm	Limit dBm	Margin dB	Detector	Comment
1	*	10826.000	-56.81	12.64	-44.17	-13.00	-31.17	peak	

Test Mode LTE Band 26\_BPSK\_TX CH26925\_3.75KHz

### Horizontal

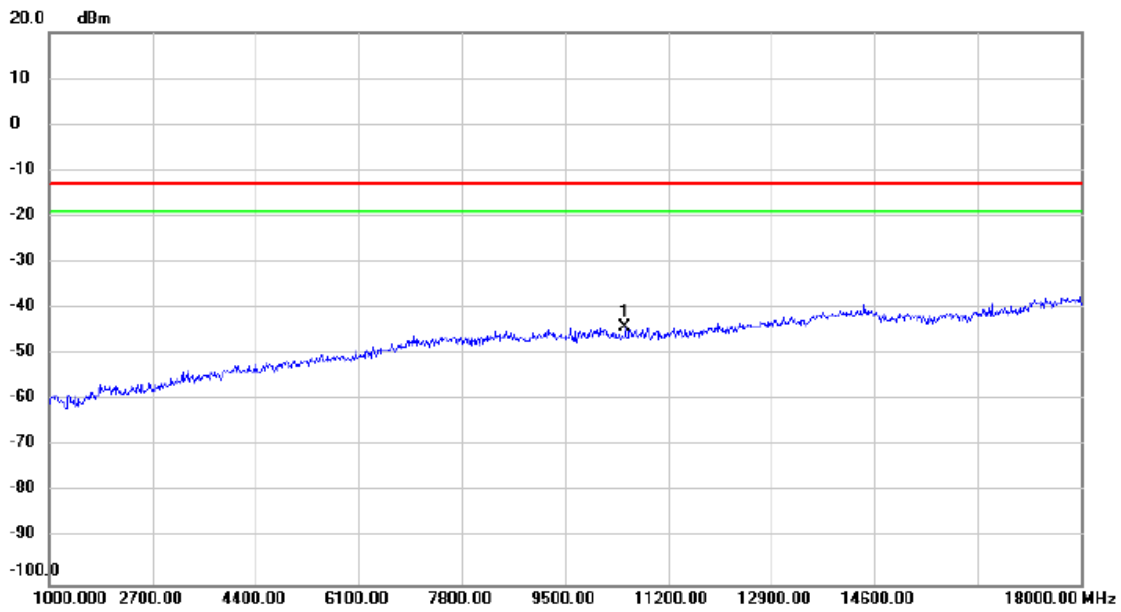

No.	Mk.	Freq. MHz	Reading Level dBm	Correct Factor dB	Measure- ment dBm	Limit dBm	Margin dB	Detector	Comment
1	*	10486.000	-56.54	12.36	-44.18	-13.00	-31.18	peak	



Test Mode LTE Band 26\_BPSK\_TX CH26925\_15KHz

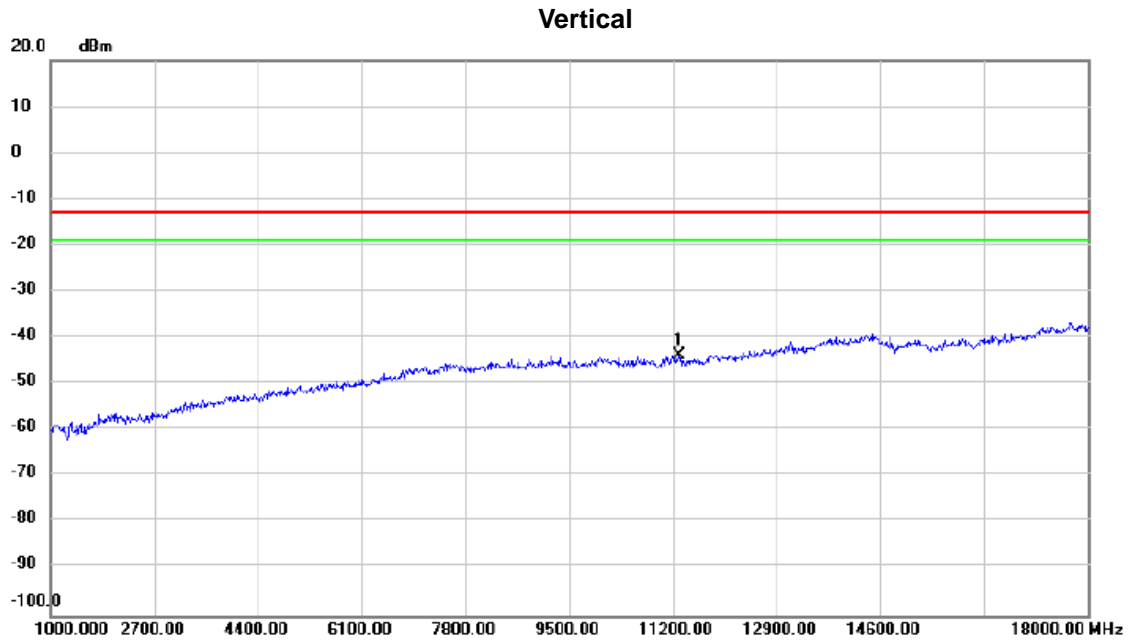

No. Mk.	Freq. MHz	Reading Level dBm	Correct Factor dB	Measure- ment dBm	Limit dBm	Margin dB	Detector	Comment
1 *	11302.000	-56.68	13.01	-43.67	-13.00	-30.67	peak	

Test Mode      LTE Band 26\_BPSK\_TX CH26925\_15KHz

### Horizontal

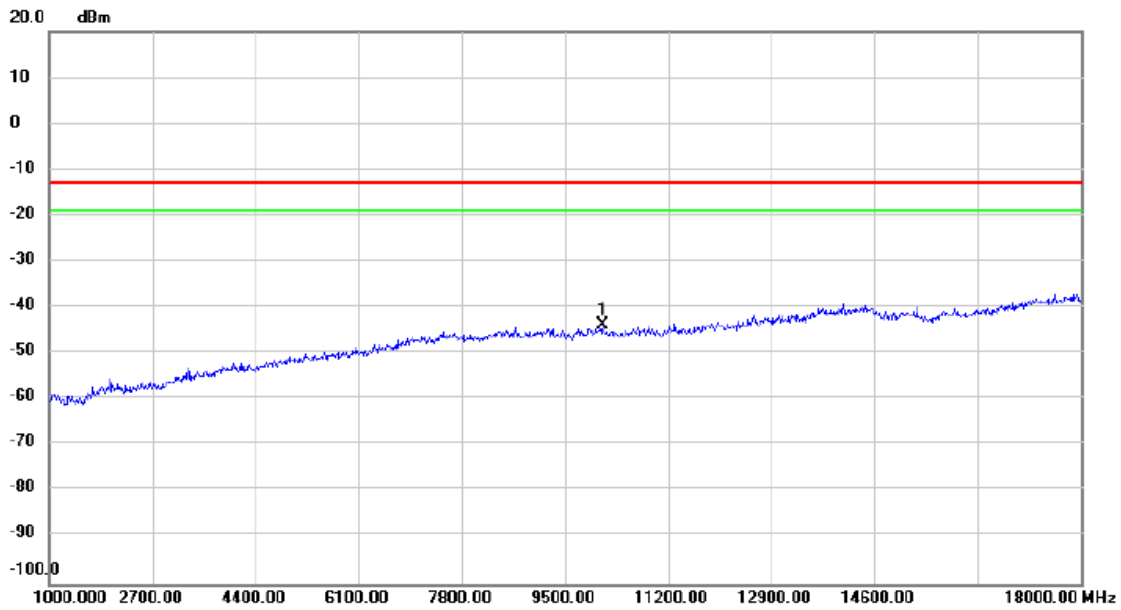

No.	Mk.	Freq. MHz	Reading Level dBm	Correct Factor dB	Measure- ment dBm	Limit dBm	Margin dB	Detector	Comment
1	*	10120.500	-56.02	12.14	-43.88	-13.00	-30.88	peak	

Test Mode LTE Band 5\_QPSK\_TX CH20525\_3.75KHz

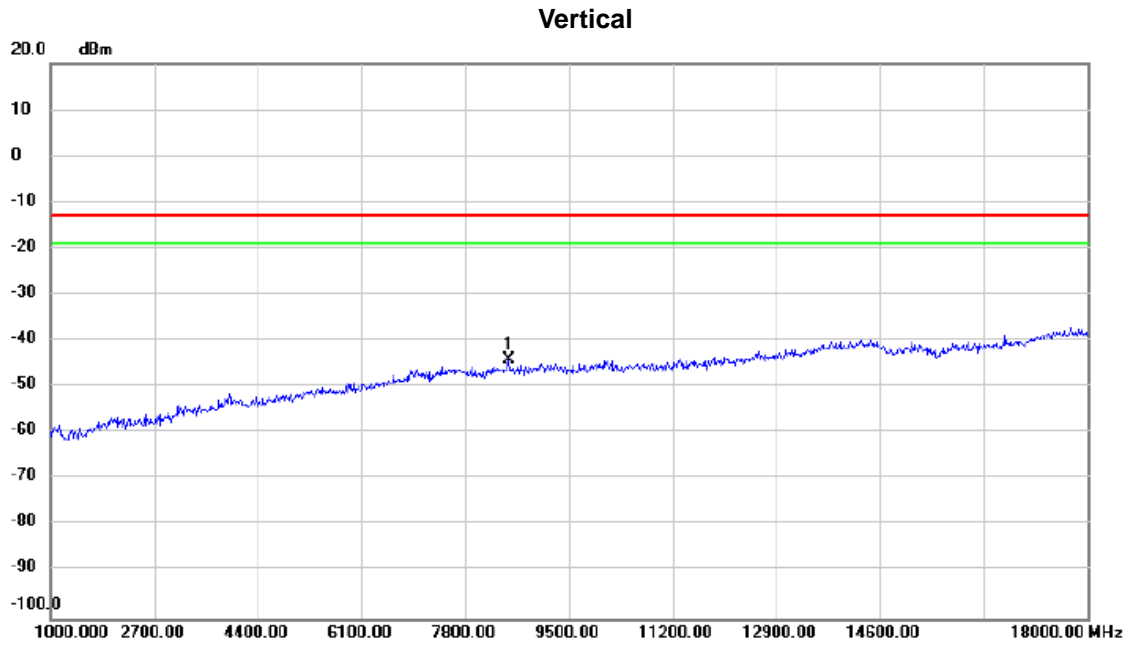

No.	Mk.	Freq. MHz	Reading Level dBm	Correct Factor dB	Measure- ment dBm	Limit dBm	Margin dB	Detector	Comment
1	*	8522.500	-55.25	11.20	-44.05	-13.00	-31.05	peak	

Test Mode      LTE Band 5\_QPSK\_TX CH20525\_3.75KHz

### Horizontal

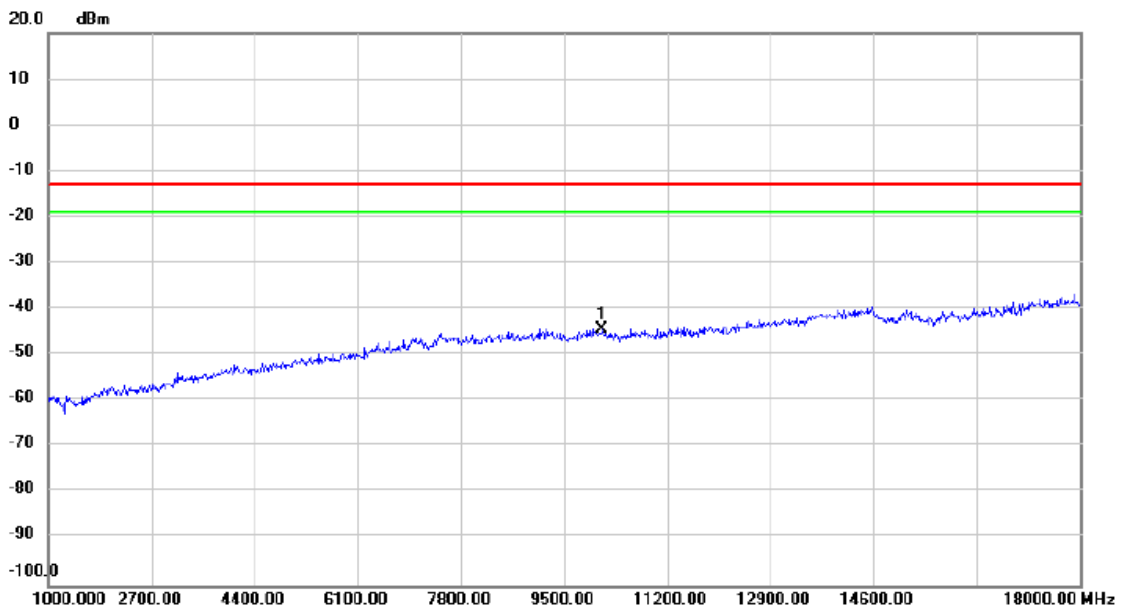

No.	Mk.	Freq. MHz	Reading Level dBm	Correct Factor dB	Measure- ment dBm	Limit dBm	Margin dB	Detector	Comment
1	*	10129.000	-56.38	12.14	-44.24	-13.00	-31.24	peak	