

# FCC Radio Test Report

## FCC ID: 2AH4HATD600

This report concerns: Original Grant

**Project No.** : 2107C193  
**Equipment** : LTE Cat-M1 Tracker  
**Brand Name** : Mobilogix  
**Test Model** : ATD600S  
**Series Model** : N/A  
**Applicant** : Mobilogix, Inc.  
**Address** : 5500 Trabuco Rd Suite 150 Irvine, CA, USA  
**Manufacturer** : Mobilogix, Inc.  
**Address** : 5500 Trabuco Rd Suite 150 Irvine, CA, USA  
**Factory** : Suga Electronics (Dongguan) Co., Ltd.  
**Address** : No.8 Fulong Road, Qingxi Town, Dongguan City  
**Date of Receipt** : Jul. 29, 2021  
**Date of Test** : Jul. 30, 2021 ~ Sep. 10, 2021  
**Issued Date** : Sep. 18, 2021  
**Report Version** : R00  
**Test Sample** : Engineering Sample No.: DG2021081225 for radiated, DG2021081224 for conducted.  
**Standard(s)** : 47 CFR FCC Part 27 Subpart L  
47 CFR FCC Part 27 Subpart M  
47 CFR FCC Part 27 Subpart C  
47 CFR FCC Part 2  
ANSI/TIA/EIA-603-E-2016  
FCC KDB 971168 D01 Power Meas License Digital Systems v03r01

The above equipment has been tested and found compliance with the requirement of the relative standards by BTL Inc.

*Vegeta Li*

Prepared by : Vegeta Li

*Steven Lu*

Approved by : Steven Lu



TESTING CERT #5123.02

Add: No. 3 Jinshagang 1st Rd. Shixia, Dalang Town, Dongguan City, Guangdong, People's Republic of China

Tel: +86-769-8318-3000

Web: [www.newbtl.com](http://www.newbtl.com)

**Declaration**

**BTL** represents to the client that testing is done in accordance with standard procedures as applicable and that test instruments used has been calibrated with standards traceable to international standard(s) and/or national standard(s).

**BTL's** reports apply only to the specific samples tested under conditions. It is manufacture's responsibility to ensure that additional production units of this model are manufactured with the identical electrical and mechanical components. **BTL** shall have no liability for any declarations, inferences or generalizations drawn by the client or others from **BTL** issued reports.

The report must not be used by the client to claim product certification, approval, or endorsement by NIST, A2LA, or any agency of the U.S. Government.

This report is the confidential property of the client. As a mutual protection to the clients, the public and ourselves, the test report shall not be reproduced, except in full, without our written approval.

**BTL's** laboratory quality assurance procedures are in compliance with the **ISO/IEC 17025** requirements, and accredited by the conformity assessment authorities listed in this test report.

**BTL** is not responsible for the sampling stage, so the results only apply to the sample as received.

The information, data and test plan are provided by manufacturer which may affect the validity of results, so it is manufacturer's responsibility to ensure that the apparatus meets the essential requirements of applied standards and in all the possible configurations as representative of its intended use.

**Limitation**

For the use of the authority's logo is limited unless the Test Standard(s)/Scope(s)/Item(s) mentioned in this test report is (are) included in the conformity assessment authorities acceptance respective.

Please note that the measurement uncertainty is provided for informational purpose only and is not use in determining the Pass/Fail results.

<b>Table of Contents</b>	<b>Page</b>
<b>REPORT ISSUED HISTORY</b>	<b>5</b>
<b>1 . SUMMARY OF TEST RESULTS</b>	<b>6</b>
1.1 TEST FACILITY	7
1.2 MEASUREMENT UNCERTAINTY	7
1.3 TEST ENVIRONMENT CONDITIONS	7
<b>2 . GENERAL INFORMATION</b>	<b>8</b>
2.1 GENERAL DESCRIPTION OF EUT	8
2.2 DESCRIPTION OF TEST MODES	11
2.3 BLOCK DIGRAM SHOWING THE CONFIGURATION OF SYSTEM TESTED	15
2.4 DESCRIPTION OF SUPPORT UNITS	15
<b>3 . TEST RESULT</b>	<b>16</b>
3.1 OUTPUT POWER MEASUREMENT	16
3.1.1 LIMIT	16
3.1.2 TEST PROCEDURE	16
3.1.3 TEST SETUP LAYOUT	16
3.1.4 TEST DEVIATION	16
3.1.5 TEST RESULTS	16
3.2 OCCUPIED BANDWIDTH MEASUREMENT	17
3.2.1 TEST PROCEDURE	17
3.2.2 TEST SETUP LAYOUT	17
3.2.3 TEST DEVIATION	17
3.2.4 TEST RESULTS	17
3.3 CONDUCTED SPURIOUS EMISSIONS MEASUREMENT	18
3.3.1 LIMIT	18
3.3.2 TEST PROCEDURES	18
3.3.3 TEST SETUP LAYOUT	18
3.3.4 TEST DEVIATION	18
3.3.5 TEST RESULTS	18
3.4 RADIATED SPURIOUS EMISSIONS MEASUREMENT	19
3.4.1 LIMIT	19
3.4.2 TEST PROCEDURES	19
3.4.3 TEST SETUP LAYOUT	20
3.4.4 TEST RESULTS (9KHZ TO 30MHZ)	21
3.4.5 TEST RESULTS (30MHZ TO 1000MHZ)	21
3.4.6 TEST RESULTS (ABOVE 1000MHZ)	21
3.5 BAND EDGE MEASUREMENT	22
3.5.1 LIMIT	22
3.5.2 TEST PROCEDURES	22
3.5.3 TEST SETUP LAYOUT	22

<b>Table of Contents</b>	<b>Page</b>
3.5.4 TEST DEVIATION	22
3.5.5 TEST RESULTS	22
3.6 PEAK TO AVERAGE RATIO MEASUREMENT	23
3.6.1 LIMIT	23
3.6.2 TEST PROCEDURES	23
3.6.3 TEST SETUP LAYOUT	23
3.6.4 TEST DEVIATION	23
3.6.5 TEST RESULTS	23
3.7 FREQUENCY STABILITY MEASUREMENT	24
3.7.1 LIMIT	24
3.7.2 TEST PROCEDURES	24
3.7.3 TEST SETUP LAYOUT	24
3.7.4 TEST DEVIATION	24
3.7.5 TEST RESULTS	24
4. LIST OF MEASUREMENT EQUIPMENTS	25
APPENDIX A - OUTPUT POWER	27
APPENDIX B - OCCUPIED BANDWIDTH	35
APPENDIX C - CONDUCTED SPURIOUS EMISSIONS	75
APPENDIX D - RADIATED SPURIOUS EMISSIONS (9KHZ TO 30MHZ)	89
APPENDIX E - RADIATED SPURIOUS EMISSIONS (30MHZ TO 1GHZ)	94
APPENDIX F - RADIATED SPURIOUS EMISSIONS (ABOVE 1GHZ)	121
APPENDIX G - BAND EDGE	148
APPENDIX H - PEAK TO AVERAGE RATIO	169
APPENDIX I - FREQUENCY STABILITY	190

**REPORT ISSUED HISTORY**

Report Version	Description	Issued Date
R00	Original Issue.	Sep. 18, 2021

## 1. SUMMARY OF TEST RESULTS

Test procedures according to the technical standard(s):

FCC Part 27 Subpart L, M, C & Part 2			
Standard(s) Section	Test Item	Judgment	Remark
2.1046	Output Power	PASS	-----
27.50(d)(4) 27.50(c)(10) 27.50(h)(2)	Equivalent Isotropic Radiated Power & Equivalent Radiated Power	PASS	-----
2.1049	Occupied Bandwidth	PASS	-----
2.1051 27.53(h) 27.53(m)(4)	Conducted Spurious Emissions	PASS	-----
2.1053 27.53(h) 27.53(m)(4)	Radiated Spurious Emissions	PASS	-----
2.1051 27.53(h) 27.53(m)(4)	Band Edge Measurements	PASS	-----
-	Peak To Average Ratio	PASS	Record Only
2.1055 27.54	Frequency Stability	PASS	-----

Note:

(1) "N/A" denotes test is not applicable in this test report.

### 1.1 TEST FACILITY

The test facilities used to collect the test data in this report is at the location of No. 3 Jinshagang 1st Rd. Shixia, Dalang Town, Dongguan City, Guangdong, People's Republic of China.  
 BTL's Test Firm Registration Number for FCC: 357015  
 BTL's Designation Number for FCC: CN1240

### 1.2 MEASUREMENT UNCERTAINTY

The measurement uncertainty figures shall be calculated according the methods described in the ETSI TR 100 028 and shall correspond to an expansion factor (coverage factor)  $k=1.96$  or  $k=2$ (which provide confidence levels of respectively 90% and 95.45% in the case where the distributions characterizing the actual measurement uncertainties are normal (Gaussian)).  
 Measurement Uncertainty for a Level of Confidence of 95 %,  $U=2xUc(y)$ .

The BTL measurement uncertainty as below table:

#### A. Radiated Measurement :

Test Site	Method	Measurement Frequency Range	Ant. H / V	U, (dB)
DG-CB03	CISPR	9kHz ~ 30MHz	-	2.36
		30MHz ~ 200MHz	V	4.36
		30MHz ~ 200MHz	H	3.32
		200MHz ~ 1,000MHz	V	4.08
		200MHz ~ 1,000MHz	H	3.96
		1GHz ~ 6GHz	-	3.80
		6GHz ~ 18GHz	-	4.82

#### B. Other Measurement:

Parameter	Uncertainty
Spectrum Bandwidth	±3.8 %
Maximum Output Power	±0.95 dB
Power Spectral Density	±0.86 dB
Frequency Stability	±0.16 dB
Temperature	±0.08 °C
Time	±0.58 %
Supply voltages	±0.3 %

Note: Unless specifically mentioned, the uncertainty of measurement has not been taken into account to declare the compliance or non-compliance to the specification.

### 1.3 TEST ENVIRONMENT CONDITIONS

Test Item	Temperature	Humidity	Test Voltage	Tested By
Output Power & ERP& EIRP	23.5°C	43%	DC 3.6 V	Tate Liu
Occupied Bandwidth	23.5°C	43%	DC 3.6 V	Tate Liu
Conducted Spurious Emissions	23.5°C	43%	DC 3.6 V	Tim Yang
Radiated Spurious Emissions	26°C	52%	DC 3.6 V	Kwok Guo
Band Edge	23.5°C	43%	DC 3.6 V	Tate Liu
Peak to Average Ratio	23.5°C	43%	DC 3.6 V	Tate Liu
Frequency Stability	Normal & Extreme	43%	Normal & Extreme	Tate Liu

## 2. GENERAL INFORMATION

### 2.1 GENERAL DESCRIPTION OF EUT

Equipment	LTE Cat-M1 Tracker				
Brand Name	Mobilogix				
Test Model	ATD600S				
Series Model	N/A				
Model Difference(s)	N/A				
Hardware Version	1.1				
Software Version	1.1.45				
Power Source	Supplied from battery.				
Power Rating	DC 3.6V				
IEMI No.	Conducted	867730051961021			
	Radiated	867730051961708			
LTE Category	M1				
Modulation Type	UL: QPSK,16QAM DL: QPSK,16QAM				
Max. EIRP	LTE	Channel Bandwidth (MHz)	QPSK (dBm)	16QAM (dBm)	
	Band 4	1.4	23.57	22.60	
		3	23.46	22.48	
		5	23.30	23.42	
		10	23.47	23.67	
		15	23.54	23.22	
		20	23.43	23.51	
	Band 66	1.4	23.18	22.43	
		3	23.20	22.68	
		5	23.58	24.07	
		10	23.62	23.91	
		15	23.56	23.66	
	Max. ERP	Band 12	1.4	22.03	21.06
			3	21.91	20.86
5			22.07	22.17	
10			22.01	22.15	
Band 13		5	21.93	22.11	
		10	21.66	21.48	
Band 85		5	19.88	19.69	
		10	19.79	19.99	



**Note:**

1. For a more detailed features description, please refer to the manufacturer's specifications or the user's manual.

**2. Channel List:**

LTE Band 4					
Test Frequency ID	Bandwidth (MHz)	N <sub>UL</sub>	Frequency of Uplink (MHz)	N <sub>DL</sub>	Frequency of Downlink (MHz)
Low Range	1.4	19957	1710.7	1957	2110.7
	3	19965	1711.5	1965	2111.5
	5	19975	1712.5	1975	2112.5
	10	20000	1715	2000	2115
	15	20025	1717.5	2025	2117.5
	20	20050	1720	2050	2120
Mid Range	1.4/3/5/10/15/20	20175	1732.5	2175	2132.5
High Range	1.4	20393	1754.3	2393	2154.3
	3	20385	1753.5	2385	2153.5
	5	20375	1752.5	2375	2152.5
	10	20350	1750	2350	2150
	15	20325	1747.5	2325	2147.5
	20	20300	1740	2300	2145

LTE Band 12			
Test Frequency ID	Bandwidth (MHz)	EARFCN	Frequency (UL and DL) (MHz)
Low Range	1.4	23017	699.7
	3	23025	700.5
	5	23035	701.5
	10	23060	704.0
Mid Range	1.4/3/5/10	23095	707.5
High Range	1.4	23173	715.3
	3	23165	714.5
	5	23155	713.5
	10	23130	711.0

LTE Band 13			
Test Frequency ID	Bandwidth (MHz)	EARFCN	Frequency (UL and DL) (MHz)
Low Range	5	23205	779.5
Mid Range	5/10	23230	782.0
High Range	5	23255	784.5

LTE Band 66					
Test Frequency ID	Bandwidth (MHz)	N <sub>UL</sub>	Frequency of Uplink (MHz)	N <sub>DL</sub>	Frequency of Downlink (MHz)
Low Range	1.4	131979	1710.7	66443	2110.7
	3	131987	1711.5	66451	2111.5
	5	131997	1712.5	66461	2112.5
	10	132022	1715	66486	2115
	15	132047	1717.5	66511	2117.5
	20	132072	1720	66536	2120
Mid Range	1.4/3/5/10/15/20	132322	1745	66786	2145
High Range	1.4	132665	1779.3	67129	2179.3
	3	132657	1778.5	67121	2178.5
	5	132647	1777.5	67111	2177.5
	10	132622	1775	67086	2175
	15	132597	1772.5	67061	2172.5
	20	132572	1770	67036	2170

LTE Band 85					
Test Frequency ID	Bandwidth (MHz)	N <sub>UL</sub>	Frequency of Uplink (MHz)	N <sub>DL</sub>	Frequency of Downlink (MHz)
Low Range	5	134027	700.5	70391	730.5
	10	134052	703	70416	733
Mid Range	5/10	134092	707	70456	737
High Range	5	134157	713.5	70521	743.5
	10	134132	711	70496	741

## 3. Table for Filed Antenna:

Brand	P/N	Antenna Type	Connector	Gain (dBi)	Note
Ethertronics	1004795	Chip	N/A	3.1	LTE Band 4
Ethertronics	1004795	Chip	N/A	1.6	LTE Band 12
Ethertronics	1004795	Chip	N/A	1.6	LTE Band 13
Ethertronics	1004795	Chip	N/A	3.1	LTE Band 66
Ethertronics	1004795	Chip	N/A	1.6	LTE Band 85

Note: The antenna gains are provided by the manufacturer.

## 2.2 DESCRIPTION OF TEST MODES

Following mode(s) is (were) found to be the worst case(s) and selected for the final test.

LTE BAND 4 MODE					
Test Item	Available Channel	Tested Channel	Channel Bandwidth	Modulation	Mode
Output Power & EIRP	19957 to 20393	19957, 20175, 20393	1.4MHz	QPSK, 16QAM	1RB/6RB
	19965 to 20385	19965, 20175, 20385	3MHz	QPSK, 16QAM	1RB/6RB
	19975 to 20375	19975, 20175, 20375	5MHz	QPSK, 16QAM	1RB/6RB
	20000 to 20350	20000, 20175, 20350	10MHz	QPSK, 16QAM	1RB/4RB
	20025 to 20325	20025, 20175, 20325	15MHz	QPSK, 16QAM	1RB/6RB
	20050 to 20300	20050, 20175, 20300	20MHz	QPSK, 16QAM	1RB/6RB
Occupied Bandwidth	19957 to 20393	19957, 20175, 20393	1.4MHz	QPSK, 16QAM	6RB
	19965 to 20385	19965, 20175, 20385	3MHz	QPSK, 16QAM	6RB
	19975 to 20375	19975, 20175, 20375	5MHz	QPSK, 16QAM	6RB
	20000 to 20350	20000, 20175, 20350	10MHz	QPSK, 16QAM	6RB
	20025 to 20325	20025, 20175, 20325	15MHz	QPSK, 16QAM	6RB
	20050 to 20300	20050, 20175, 20300	20MHz	QPSK, 16QAM	6RB
Conducted Spurious Emissions	19957 to 20393	20175	1.4MHz	QPSK	1RB
	19975 to 20375	20175	5MHz	QPSK	1RB
	20050 to 20300	20175	20MHz	QPSK	1RB
Radiated Spurious Emissions	19957 to 20393	20175	1.4MHz	QPSK	1RB
	19975 to 20375	20175	5MHz	QPSK	1RB
	20050 to 20300	20175	20MHz	QPSK	1RB
Band Edge	19957 to 20393	19957, 20393	1.4MHz	QPSK	1RB/6RB
	19965 to 20385	19965, 20385	3MHz	QPSK	1RB/6RB
	19975 to 20375	19975, 20375	5MHz	QPSK	1RB/6RB
	20000 to 20350	20000, 20350	10MHz	QPSK	1RB/6RB
	20025 to 20325	20025, 20325	15MHz	QPSK	1RB/6RB
	20050 to 20300	20050, 20300	20MHz	QPSK	1RB/6RB
Peak To Average Ratio	19957 to 20393	19957, 20175, 20393	1.4MHz	QPSK, 16QAM	1RB
	19965 to 20385	19965, 20175, 20385	3MHz	QPSK, 16QAM	1RB
	19975 to 20375	19975, 20175, 20375	5MHz	QPSK, 16QAM	1RB
	20000 to 20350	20000, 20175, 20350	10MHz	QPSK, 16QAM	1RB
	20025 to 20325	20025, 20175, 20325	15MHz	QPSK, 16QAM	1RB
	20050 to 20300	20050, 20175, 20300	20MHz	QPSK, 16QAM	1RB
Frequency Stability	19957 to 20393	20175	1.4MHz	QPSK	1RB
	19965 to 20385	20175	3MHz	QPSK	1RB
	19975 to 20375	20175	5MHz	QPSK	1RB
	20000 to 20350	20175	10MHz	QPSK	1RB
	20025 to 20325	20175	15MHz	QPSK	1RB
	20050 to 20300	20175	20MHz	QPSK	1RB

LTE BAND 12					
Test Item	Available Channel	Tested Channel	Channel Bandwidth	Modulation	Mode
Output Power & ERP	23017 to 23173	23017, 23095, 23173	1.4MHz	QPSK, 16QAM	1RB/6RB
	23025 to 23165	23025, 23095, 23165	3MHz	QPSK, 16QAM	1RB/6RB
	23035 to 23155	23035, 23095, 23155	5MHz	QPSK, 16QAM	1RB/6RB
	23060 to 23130	23060, 23095, 23130	10MHz	QPSK, 16QAM	1RB/4RB
Frequency Stability	23017 to 23173	23095	1.4MHz	QPSK	1RB
	23025 to 23165	23095	3MHz	QPSK	1RB
	23035 to 23155	23095	5MHz	QPSK	1RB
	23060 to 23130	23095	10MHz	QPSK	1RB
Occupied Bandwidth	23017 to 23173	23017, 23095, 23173	1.4MHz	QPSK, 16QAM	6RB
	23025 to 23165	23025, 23095, 23165	3MHz	QPSK, 16QAM	6RB
	23035 to 23155	23035, 23095, 23155	5MHz	QPSK, 16QAM	6RB
	23060 to 23130	23060, 23095, 23130	10MHz	QPSK, 16QAM	6RB
Peak to Average Ratio	23017 to 23173	23017, 23095, 23173	1.4MHz	QPSK, 16QAM	1RB
	23025 to 23165	23025, 23095, 23165	3MHz	QPSK, 16QAM	1RB
	23035 to 23155	23035, 23095, 23155	5MHz	QPSK, 16QAM	1RB
	23060 to 23130	23060, 23095, 23130	10MHz	QPSK, 16QAM	1RB
Band Edge	23017 to 23173	23017,23173	1.4MHz	QPSK	1RB/6RB
	23025 to 23165	23025,23165	3MHz	QPSK	1RB/6RB
	23035 to 23155	23035,23155	5MHz	QPSK	1RB/6RB
	23060 to 23130	23060,23130	10MHz	QPSK	1RB/6RB
Conducted Emission	23017 to 23173	23095	1.4MHz	QPSK	1 RB
	23035 to 23155	23095	5MHz	QPSK	1 RB
	23060 to 23130	23095	10MHz	QPSK	1 RB
Radiated Emission	23017 to 23173	23095	1.4MHz	QPSK	1 RB
	23017 to 23173	23095	5MHz	QPSK	1 RB
	23060 to 23130	23095	10MHz	QPSK	1 RB

LTE BAND 13					
Test Item	Available Channel	Tested Channel	Channel Bandwidth	Modulation	Mode
Output Power & ERP	23205 to 23255	23205, 23230, 23255	5MHz	QPSK, 16QAM	1RB/6RB
	23230	23230	10MHz	QPSK, 16QAM	1RB/4RB
Frequency Stability	23205 to 23255	23230	5MHz	QPSK	1 RB
	23230	23230	10MHz	QPSK	1 RB
Occupied Bandwidth	23205 to 23255	23205, 23230, 23255	5MHz	QPSK, 16QAM	6RB
	23230	23230	10MHz	QPSK, 16QAM	6RB
Peak to Average Ratio	23205 to 23255	23205, 23230, 23255	5MHz	QPSK, 16QAM	1RB
	23230	23230	10MHz	QPSK, 16QAM	1RB
Band Edge	23205 to 23255	23205, 23255	5MHz	QPSK	1RB/6RB
	23230	23230	10MHz	QPSK	1RB/6RB
Conducted Emission	23205 to 23255	23230	5MHz	QPSK	1RB
	23230	23230	10MHz	QPSK	1RB
Radiated Emission	23205 to 23255	23230	5MHz	QPSK	1RB
	23230	23230	10MHz	QPSK	1RB

LTE BAND 66 MODE					
Test Item	Available Channel	Tested Channel	Channel Bandwidth	Modulation	Mode
Output Power & EIRP	131979 to 132665	131979, 132322, 132665	1.4MHz	QPSK, 16QAM	1RB/6RB
	131987 to 132657	131987, 132322, 132657	3MHz	QPSK, 16QAM	1RB/6RB
	131997 to 132647	131997, 132322, 132647	5MHz	QPSK, 16QAM	1RB/6RB
	132022 to 132622	132022, 132322, 132622	10MHz	QPSK, 16QAM	1RB/4RB
	132047 to 132597	132047, 132322, 132597	15MHz	QPSK, 16QAM	1RB/6RB
	132072 to 132572	132072, 132322, 132572	20MHz	QPSK, 16QAM	1RB/6RB
Occupied Bandwidth	131979 to 132665	131979, 132322, 132665	1.4MHz	QPSK, 16QAM	6RB
	131987 to 132657	131987, 132322, 132657	3MHz	QPSK, 16QAM	6RB
	131997 to 132647	131997, 132322, 132647	5MHz	QPSK, 16QAM	6RB
	132022 to 132622	132022, 132322, 132622	10MHz	QPSK, 16QAM	6RB
	132047 to 132597	132047, 132322, 132597	15MHz	QPSK, 16QAM	6RB
	132072 to 132572	132072, 132322, 132572	20MHz	QPSK, 16QAM	6RB
Conducted Spurious Emissions	131979 to 132665	132322	1.4MHz	QPSK	1RB
	131997 to 132647	132322	5MHz	QPSK	1RB
	132072 to 132572	132322	20MHz	QPSK	1RB
Radiated Spurious Emissions	131979 to 132665	132322	1.4MHz	QPSK	1RB
	131997 to 132647	132322	5MHz	QPSK	1RB
	132072 to 132572	132322	20MHz	QPSK	1RB
Band Edge	131979 to 132665	131979, 132665	1.4MHz	QPSK	1RB/6RB
	131987 to 132657	131987, 132657	3MHz	QPSK	1RB/6RB
	131997 to 132647	131997, 132647	5MHz	QPSK	1RB/6RB
	132022 to 132622	132022, 132622	10MHz	QPSK	1RB/6RB
	132047 to 132597	132047, 132597	15MHz	QPSK	1RB/6RB
	132072 to 132572	132072, 132572	20MHz	QPSK	1RB/6RB
Peak to Average Ratio	131979 to 132665	131979, 132322, 132665	1.4MHz	QPSK, 16QAM	1RB
	131987 to 132657	131987, 132322, 132657	3MHz	QPSK, 16QAM	1RB
	131997 to 132647	131997, 132322, 132647	5MHz	QPSK, 16QAM	1RB
	132022 to 132622	132022, 132322, 132622	10MHz	QPSK, 16QAM	1RB
	132047 to 132597	132047, 132322, 132597	15MHz	QPSK, 16QAM	1RB
	132072 to 132572	132072, 132322, 132572	20MHz	QPSK, 16QAM	1RB
Frequency Stability	131979 to 132665	132322	1.4MHz	QPSK	1RB
	131987 to 132657	132322	3MHz	QPSK	1RB
	131997 to 132647	132322	5MHz	QPSK	1RB
	132022 to 132622	132322	10MHz	QPSK	1RB
	132047 to 132597	132322	15MHz	QPSK	1RB
	132072 to 132572	132322	20MHz	QPSK	1RB

LTE BAND 85 MODE					
Test Item	Available Channel	Tested Channel	Channel Bandwidth	Modulation	Mode
Output Power & EIRP	134027 to 134157	134027, 134092,134157	5MHz	QPSK, 16QAM	1RB/6RB
	134052 to 134132	134052, 134092, 134132	10MHz	QPSK, 16QAM	1RB/4RB
Occupied Bandwidth	39675 to 41565	134027, 134092,134157	5MHz	QPSK, 16QAM	6RB
	39700 to 41540	134052, 134092, 134132	10MHz	QPSK, 16QAM	6RB
Conducted Spurious Emissions	39675 to 41565	134092	5MHz	QPSK	1RB
	39750 to 41490	134092	10MHz	QPSK	1RB
Radiated Spurious Emissions	39675 to 41565	134092	5MHz	QPSK	1RB
	39750 to 41490	134092	10MHz	QPSK	1RB
Band Edge	39675 to 41565	134027,134157	5MHz	QPSK	1RB/6RB
	40090 to 41540	134052,134132	10MHz	QPSK	1RB/6RB
Peak to Average Ratio	39675 to 41565	134027, 134092,134157	5MHz	QPSK, 16QAM	1RB
	40090 to 41540	134052, 134092, 134132	10MHz	QPSK, 16QAM	1RB
Frequency Stability	39675 to 41565	134092	5MHz	QPSK	1RB
	40090 to 41540	134092	10MHz	QPSK	1RB

**2.3 BLOCK DIGRAM SHOWING THE CONFIGURATION OF SYSTEM TESTED****2.4 DESCRIPTION OF SUPPORT UNITS**

The EUT has been tested as an independent unit together with other necessary accessories or support units. The following support units or accessories were used to form a representative test configuration during the tests.

Item	Equipment	Brand	Model No.	Series No.
-	-	-	-	-

Item	Cable Type	Shielded Type	Ferrite Core	Length
-	-	-	-	-

### 3. TEST RESULT

#### 3.1 OUTPUT POWER MEASUREMENT

##### 3.1.1 LIMIT

Mobile / Portable station are limited to 1 watts e.i.r.p. (Part 27 Subpart L)

Mobile / Portable station are limited to 2 watts e.i.r.p. (Part 27 Subpart M)

Mobile / Portable station are limited to 3 watts e.r.p (Part 27 Subpart C)

##### 3.1.2 TEST PROCEDURE

The testing follows FCC KDB 971168 v03r01 Section 5.

##### EIRP:

$EIRP = \text{Output Power} + \text{Antenan gain}$

##### ERP:

$ERP = EIRP - 2.15$

##### Output Power:

The EUT was set up for the maximum power with WCDMA and LTE link data modulation and link up with simulator. Set the EUT to transmit under low, middle and high channel and record the power level shown on simulator.

##### 3.1.3 TEST SETUP LAYOUT

Output Power Measurement

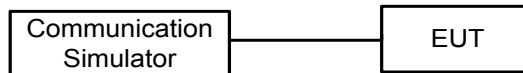

##### 3.1.4 TEST DEVIATION

No deviation

##### 3.1.5 TEST RESULTS

Please refer to the APPENDIX A.



## 3.2 OCCUPIED BANDWIDTH MEASUREMENT

### 3.2.1 TEST PROCEDURE

The testing follows FCC KDB 971168 v03r01 Section 4.

1. The EUT makes a call to the communication simulator. All measurements were done at low, middle and high operational frequency range. The communication simulator station system controlled a EUT to export maximum output power under transmission mode and specific channel frequency. Use OBW measurement function of Spectrum analyzer to measure 99 % occupied bandwidth and 26dB bandwidth.
2. The EUT was connected to spectrum analyzer and system simulator via a power divider.
3.  $RBW=(1\% \sim 5\%)*EBW$   
 $VBW \geq 3* RBW$
4. Set spectrum analyzer with Peak detector.

### 3.2.2 TEST SETUP LAYOUT

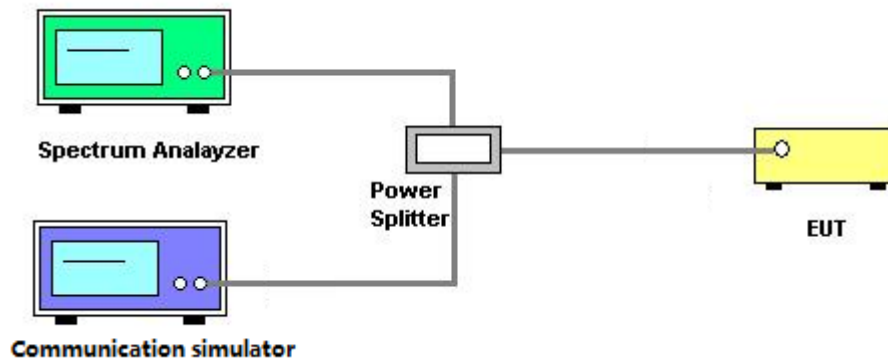

### 3.2.3 TEST DEVIATION

No deviation

### 3.2.4 TEST RESULTS

Please refer to the APPENDIX B.

### 3.3 CONDUCTED SPURIOUS EMISSIONS MEASUREMENT

#### 3.3.1 LIMIT

The power of any emission outside of the authorized operating frequency ranges must be attenuated below the transmitting power (P) by a factor of at least  $43 + 10 \log(P)$  dB. The emission limit equal to -13dBm. (Part 27 Subpart L)

The power of any emission outside of the authorized operating frequency ranges must be attenuated below the transmitting power (P) by a factor of at least  $55 + 10 \log(P)$  dB. The emission limit equal to -25dBm. (Part 27 Subpart M)

#### 3.3.2 TEST PROCEDURES

The testing follows FCC KDB 971168 v03r01 Section 6.

1. The EUT was connected to spectrum analyzer and system simulator via a power divider.
2. The band edges of low and high channels for the highest RF powers were measured. Set RBW  $\geq$  1% EBW in the 1MHz band immediately outside and adjacent to the band edge.
3. Set spectrum analyzer with Peak detector.
4. The RF fundamental frequency should be excluded against the limit line in the operating frequency band.

#### 3.3.3 TEST SETUP LAYOUT

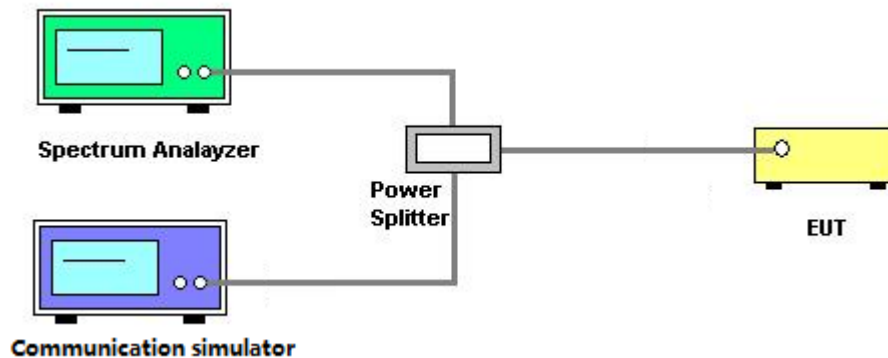

#### 3.3.4 TEST DEVIATION

No deviation

#### 3.3.5 TEST RESULTS

Please refer to the APPENDIX C.

### **3.4 RADIATED SPURIOUS EMISSIONS MEASUREMENT**

#### **3.4.1 LIMIT**

The power of any emission outside of the authorized operating frequency ranges must be attenuated below the transmitting power (P) by a factor of at least  $43 + 10 \log(P)$  dB. The emission limit equal to -13dBm. (Part 27 Subpart L)

The power of any emission outside of the authorized operating frequency ranges must be attenuated below the transmitting power (P) by a factor of at least  $55 + 10 \log(P)$  dB. The emission limit equal to -25dBm. (Part 27 Subpart M)

#### **3.4.2 TEST PROCEDURES**

The testing follows FCC KDB 971168 v03r01 Section 6.2.

1. In the semi-anechoic chamber, EUT placed on the 0.8m height of Turn Table, rotated the table around 360 degrees to search the maximum radiation power and receiver antenna shall be rotated vertical and horizontal polarization and moved height from 1m to 4m to find the maximum polar radiated power. The "Read Value" is the spectrum reading the maximum power value.
2. The substitution horn antenna is substituted for EUT at the same position and signals generator export the CW signal to the substitution antenna via a TX cable. Rotated the Turn Table and moved receiving antenna to find the maximum radiation power. Adjust output power level of S.G to get a Value of spectrum reading equal to "Read Value " of step a. Record the power level of S.G
3.  $EIRP = \text{Output power level of S.G} - \text{TX cable loss} + \text{Antenna gain of substitution horn.}$
4. ERP can be calculated form EIRP by subtracting the gain of dipole,  $ERP = EIPR - 2.15\text{dBi.}$
5. The resolution bandwidth and video bandwidth of test receiver/spectrum analyzer is 1MHz/3MHz.

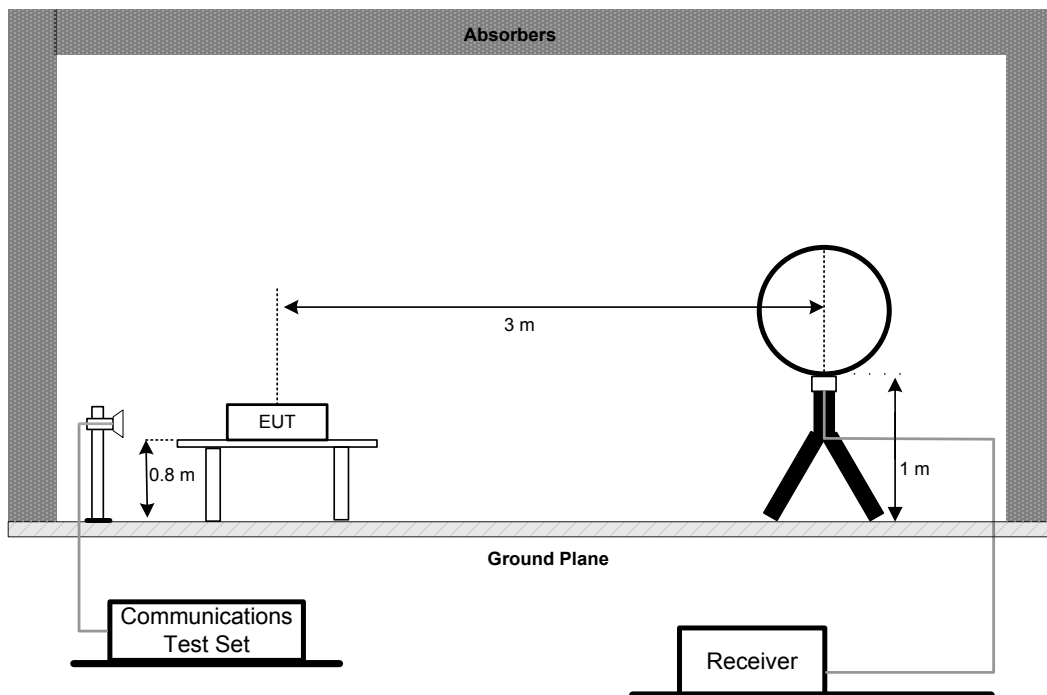
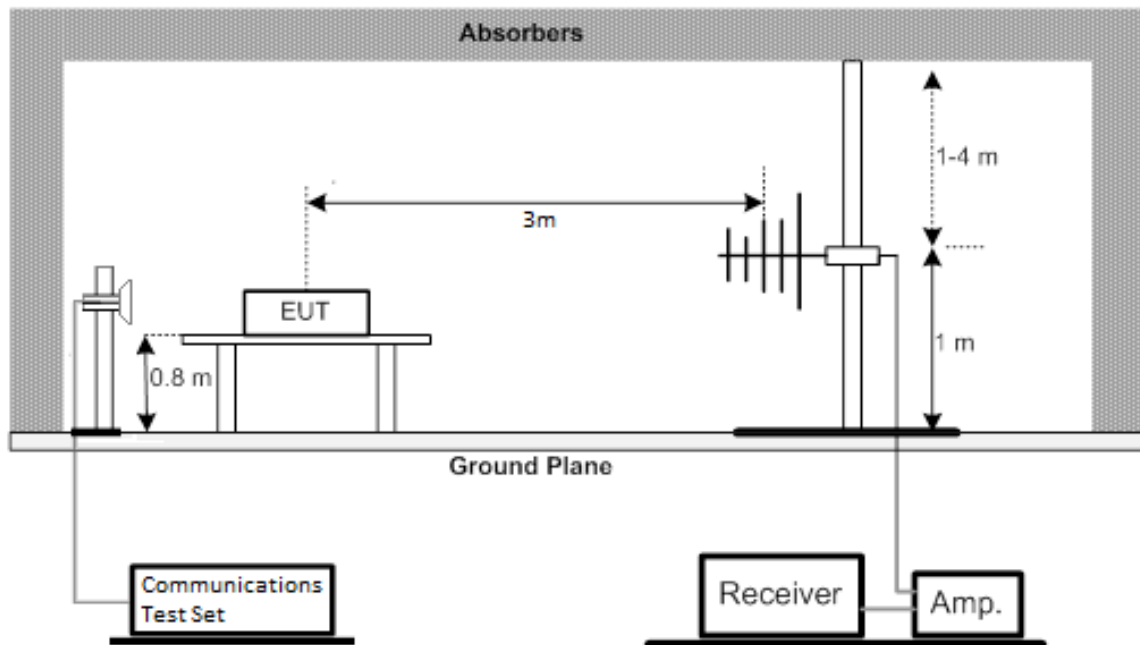
**3.4.3 TEST SETUP LAYOUT****Below 30MHz****30MHz to 1GHz**

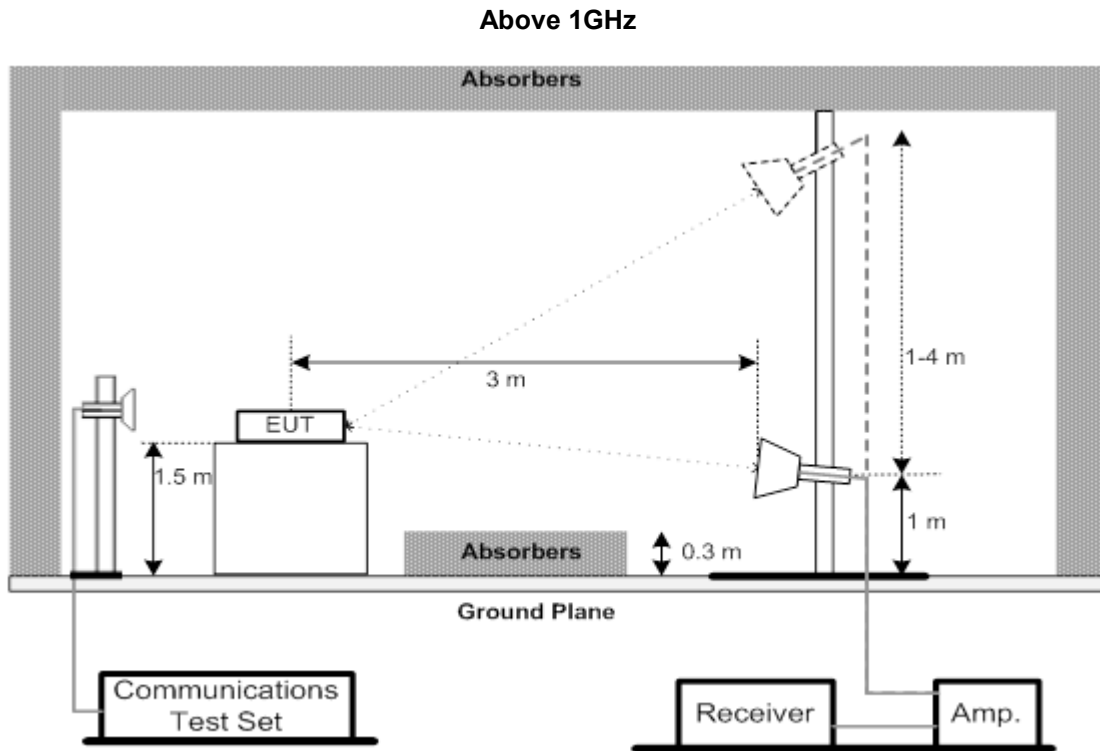

#### 3.4.4 TEST RESULTS (9KHZ TO 30MHZ)

Please refer to the APPENDIX D.

#### 3.4.5 TEST RESULTS (30MHZ TO 1000MHZ)

Please refer to the APPENDIX E.

#### 3.4.6 TEST RESULTS (ABOVE 1000MHZ)

Please refer to the APPENDIX F.

### 3.5 BAND EDGE MEASUREMENT

#### 3.5.1 LIMIT

The power of any emission outside a licensee's frequency band(s) of operation shall be attenuated below the transmitter power (P) within the licensed band(s) of operation, measured in watts, by at least  $43 + 10 \log (P)$  dB. Compliance with this provision is based on the use of measurement instrumentation employing a resolution bandwidth of 100 kilohertz or greater. However, in the 100 kilohertz bands immediately outside and adjacent to a licensee's frequency block, a resolution bandwidth of at least 30 kHz may be employed. (Part 27 Subpart L)

For mobile digital stations, the attenuation factor shall be not less than  $40 + 10 \log (P)$  dB on all frequencies between the channel edge and 5 megahertz from the channel edge,  $43 + 10 \log (P)$  dB on all frequencies between 5 megahertz and X megahertz from the channel edge, and  $55 + 10 \log (P)$  dB on all frequencies more than X megahertz from the channel edge, where X is the greater of 6 megahertz or the actual emission bandwidth as defined in paragraph (m)(6) of this section. In addition, the attenuation factor shall not be less than  $43 + 10 \log (P)$  dB on all frequencies between 2490.5 MHz and 2496 MHz and  $55 + 10 \log (P)$  dB at or below 2490.5 MHz. Mobile Satellite Service licensees operating on frequencies below 2495 MHz may also submit a documented interference complaint against BRS licensees operating on channel BRS Channel 1 on the same terms and conditions as adjacent channel BRS or EBS licensees. (Part 27 Subpart M)

#### 3.5.2 TEST PROCEDURES

The testing follows FCC KDB 971168 v03r01 Section 6.

1. All measurements were done at low and high operational frequency range.
2. Record the max trace plot into the test report.

#### 3.5.3 TEST SETUP LAYOUT

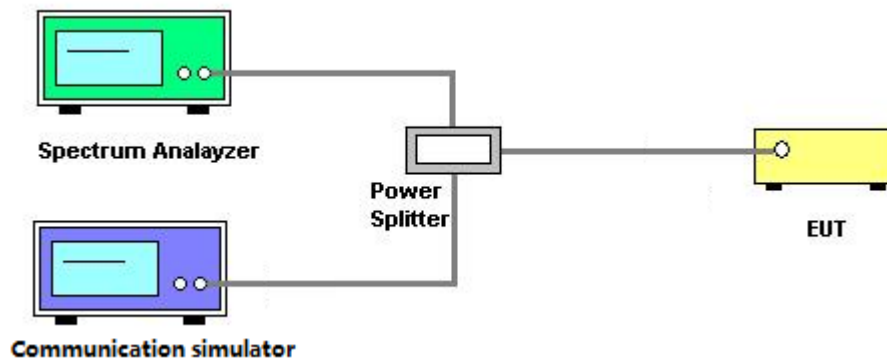

#### 3.5.4 TEST DEVIATION

No deviation

#### 3.5.5 TEST RESULTS

Please refer to the APPENDIX G.

### 3.6 PEAK TO AVERAGE RATIO MEASUREMENT

#### 3.6.1 LIMIT

In measuring transmissions in this band using an average power technique, the peak to-average ratio (PAR) of the transmission may not exceed 13 dB.

#### 3.6.2 TEST PROCEDURES

The testing follows FCC KDB 971168 v03r01 Section 5.7.

1. Set resolution/measurement bandwidth  $\geq$  signal's occupied bandwidth;
2. Set the number of counts to a value that stabilizes the measured CCDF curve;
3. Record the maximum PAPR level associated with a probability of 0.1%.

#### 3.6.3 TEST SETUP LAYOUT

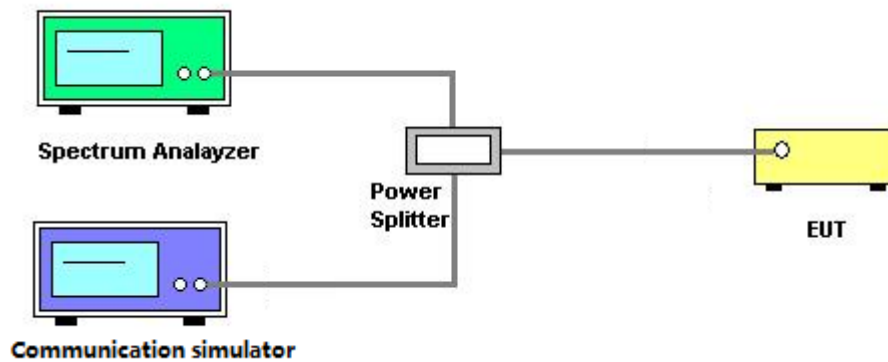

#### 3.6.4 TEST DEVIATION

No deviation

#### 3.6.5 TEST RESULTS

Please refer to the APPENDIX H.

### 3.7 FREQUENCY STABILITY MEASUREMENT

#### 3.7.1 LIMIT

$\pm 1.5$  ppm is for base and fixed station.  $\pm 2.5$  ppm is for mobile station.

#### 3.7.2 TEST PROCEDURES

The testing follows FCC KDB 971168 v03r01 Section 9.

1. Device is placed at the oven room. The oven room could control the temperatures and humidity. Power warm up is at least 15 min and power applied should perform before recording frequency error.
2. EUT is connected the external power supply to control the DC input power. The test voltage range is from minimum to maximum working voltage. Each step shall be record the frequency error rate.
3. The temperature range step is 10 degrees in this test items. All temperature levels shall be hold the  $\pm 0.5^{\circ}\text{C}$  during the measurement testing. The each temperature step shall be at least 0.5 hours, consider the EUT could be test under the stability condition.
4. The frequency error was recorded frequency error from the communication simulator.

#### 3.7.3 TEST SETUP LAYOUT

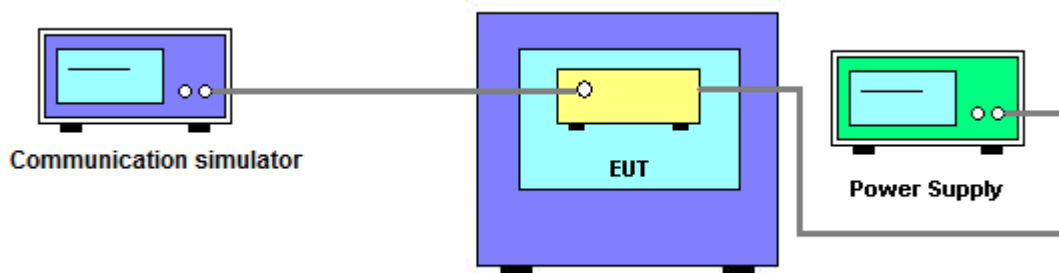

#### 3.7.4 TEST DEVIATION

No deviation

#### 3.7.5 TEST RESULTS

Please refer to the APPENDIX I.



**4. LIST OF MEASUREMENT EQUIPMENTS**

Radiated Spurious Emission Measurement					
Item	Kind of Equipment	Manufacturer	Type No.	Serial No.	Calibrated until
1	Antenna	Schwarzbeck	VULB9160	9160-3232	Mar. 15, 2022
2	Amplifier	Agilent	8449B	3008A02334	Feb. 27, 2022
3	High Pass Filter	Wairwright Instruments Gmbh	WHK 1.5/15G-10ST	11	Feb. 27, 2022
4	Band Reject Filter	Wairwright Instruments Gmbh	WRCG 1710/1785-1690/1805-60/ 12SS	38	Feb. 27, 2022
5	Band Reject Filter	Wairwright Instruments Gmbh	WRCG 824/849-810/863-60/9SS	7	Feb. 27, 2022
6	Band Reject Filter	Wairwright Instruments Gmbh	WRCG 880/915-860/935-60/9SS	14	Feb. 27, 2022
7	Band Reject Filter	Wairwright Instruments Gmbh	WRCG 1850/1910-1830/1930-60/ 10SS	17	Feb. 27, 2022
8	High Pass Filter	Wairwright Instruments Gmbh	WHK3.1/18G-10SS	24	Feb. 27, 2022
9	Wireless Communication Test SET	Agilent	E5515C	MY48364183	Feb. 28, 2022
10	Microwave Preamplifier With Adaptor	EMC INSTRUMENT	EMC2654045	980039 & HA01	Feb. 28, 2022
11	Receiver	Agilent	N9038A	MY52130039	Mar. 19, 2022
12	wideband radio communication tester	R&S	CMW500	152372	Feb. 27, 2022
13	High pass filter	KANGMAIWEI	ZHPF-M3-12.75G-3869	B2015073763	Feb. 07, 2022
14	High pass filter	KANGMAIWEI	ZHPF-M1000-4000-1	B2015073762	Feb. 07, 2022
15	High pass filter	KANGMAIWEI	ZHPF-M6-186-1727	B2015073764	Feb. 07, 2022
16	Cable	emci	LMR-400(30MHz-1GHz) (8m+5m)	N/A	May 20, 2022
17	Cable	mitron	RWLP50-4.0A-KJ-SMSM-12M	N/A	Nov. 23, 2021
18	Controller	ETS-Lindgren	2090	N/A	N/A
19	Measurement Software	Farad	EZ-EMC Ver.NB-03A1-01	N/A	N/A
20	Loop Antenna	EM	EM-6876-1	230	Apr. 28, 2022
21	Double Ridged Guide Antenna	ETS	3115	75846	Mar. 17, 2022
22	Broad-Band Horn Antenna	Schwarzbeck	BBHA 9170	9170319	Jun. 30, 2022

Conducted Measurement					
Item	Kind of Equipment	Manufacturer	Type No.	Serial No.	Calibrated until
1	Wireless Communication Test SET	Agilent	E5515C	MY48364183	Feb. 28, 2022
2	EXA Spectrum Analyzer	Agilent	N9010A	MY50520044	Feb. 28, 2022
3	POWER SPLITTER	Mini-Circuits	ZFRSC-123-S+	331000910-1	Feb. 27, 2022
4	wideband radio communication tester	R&S	CMW500	152372	Feb. 27, 2022

Frequency Stability Measurement					
Item	Kind of Equipment	Manufacturer	Type No.	Serial No.	Calibrated until
1	Wireless Communication Test SET	Agilent	E5515C	MY48364183	Feb. 28, 2022
2*	Multi-output DC Power Supply	GW Instek	GPC-3030DN	EK880675	Jul. 25, 2023
3	POWER SPLITTER	Mini-Circuits	ZFRSC-123-S+	331000910-1	Feb. 27, 2022
4	wideband radio communication tester	R&S	CMW500	152372	Feb. 27, 2022
5	Const Temp, & Humidity Chamber	Bell	BTH-50C	20170306001	Feb. 27, 2022

Remark: "N/A" denotes no model name, serial no. or calibration specified.

"\*" calibration period of equipment list is three year.

Except \* item, all calibration period of equipment list is one year.

## APPENDIX A - OUTPUT POWER

**Output Power (dBm):**

LTE Band / BW	Channel / Frequency (MHz)	RB Size	RB Offset	Index	Conducted Power (dBm)	
					QPSK	16QAM
4 / 1.4M	19957 / 1710.7	1	0	0	20.47	19.50
		6	0	0	18.28	18.21
	20175 / 1732.5	1	0	0	20.11	18.71
		6	0	0	18.02	18.04
	20393 / 1754.3	1	5	0	19.95	18.97
		6	0	0	18.03	18.11
4 / 3M	19965 / 1711.5	1	0	0	20.36	19.38
		6	0	0	18.26	18.17
	20175 / 1732.5	1	0	0	20.11	18.75
		6	0	0	18.02	18.01
	20385 / 1753.5	1	5	1	19.88	18.43
		6	0	1	18.01	18.07
4 / 5M	19975 / 1712.5	1	0	0	20.20	19.93
		6	0	0	19.03	19.01
	20175 / 1732.5	1	0	0	20.12	20.32
		6	0	0	18.82	18.83
	20375 / 1752.5	1	5	0	19.58	19.71
		6	0	3	18.62	18.66
4 / 10M	20000 / 1715	1	0	3	20.37	20.57
		4	0	0	20.10	20.13
	20175 / 1732.5	1	0	0	20.08	19.93
		4	0	0	19.93	19.94
	20350 / 1750	1	5	7	19.58	19.45
		4	2	7	19.66	19.35
4 / 15M	20025 / 1717.5	1	0	0	20.44	20.05
		6	0	0	20.01	19.99
	20175 / 1732.5	1	0	0	20.14	19.83
		6	0	0	20.00	20.12
	20325 / 1747.5	1	5	11	19.71	19.80
		6	0	11	19.87	19.86
4 / 20M	20050 / 1720	1	0	0	20.24	19.92
		6	0	0	20.11	20.22
	20175 / 1732.5	1	0	0	20.33	20.41
		6	0	0	19.97	20.16
	20300 / 1745	1	5	15	20.02	20.29
		6	0	15	19.85	19.97

LTE Band / BW	Channel / Frequency (MHz)	RB Size	RB Offset	Index	Conducted Power (dBm)	
					QPSK	16QAM
12 / 1.4M	23017 / 699.7	1	0	0	20.19	19.46
		6	0	0	18.20	18.12
	23095 / 707.5	1	0	0	20.08	18.84
		6	0	0	18.13	18.02
	23173 / 715.3	1	5	0	20.43	19.28
		6	0	0	18.39	18.32
12 / 3M	23025 / 700.5	1	0	0	20.08	19.26
		6	0	0	18.29	18.10
	23095 / 707.5	1	0	0	20.20	18.81
		6	0	0	20.20	18.08
	23165 / 714.5	1	5	1	20.31	19.07
		6	0	1	18.25	18.24
12 / 5M	23035 / 701.5	1	0	3	20.47	20.57
		6	0	0	18.99	19.27
	23095 / 707.5	1	0	0	20.39	20.31
		6	0	0	18.98	18.96
	23155 / 713.5	1	5	0	20.06	20.20
		6	0	3	19.07	19.29
12 / 10M	23060 / 704	1	0	3	20.41	20.53
		4	0	0	20.09	20.31
	23095 / 707.5	1	0	0	20.33	20.55
		4	0	0	20.15	20.21
	23130 / 711	1	5	4	20.08	20.16
		4	2	7	19.89	19.45

LTE Band / BW	Channel / Frequency (MHz)	RB Size	RB Offset	Index	Conducted Power (dBm)	
					QPSK	16QAM
13 / 5M	23205 / 779.5	1	0	0	20.12	19.82
		6	0	0	18.77	19.08
	23230 / 782	1	0	0	20.33	20.51
		6	0	0	18.77	18.83
	23255 / 784.5	1	5	3	19.94	19.85
		6	0	3	18.78	19.08
13 / 10M	23230 / 782	1	0	0	20.06	19.88
		4	0	0	19.83	19.27

LTE Band / BW	Channel / Frequency (MHz)	RB Size	RB Offset	Index	Conducted Power (dBm)	
					QPSK	16QAM
66 / 1.4M	131979 / 1710.7	1	0	0	20.03	19.25
		6	0	0	18.15	18.03
	132322 / 1745	1	0	0	20.08	19.26
		6	0	0	18.01	17.90
	132665 / 1779.3	1	5	0	19.91	19.33
		6	0	0	18.24	18.10
66 / 3M	131987 / 1711.5	1	0	0	20.10	19.40
		6	0	0	18.19	18.17
	132322 / 1745	1	0	0	19.95	19.20
		6	0	0	18.01	18.00
	132657 / 1778.5	1	5	1	20.07	19.58
		6	0	1	18.27	18.29
66 / 5M	131997 / 1712.5	1	0	3	20.48	20.43
		6	0	0	19.34	19.21
	132322 / 1745	1	0	0	20.36	20.42
		6	0	0	19.00	19.02
	132647 / 1777.5	1	5	0	20.42	20.97
		6	0	3	19.29	19.45
66 / 10M	132022 / 1715	1	0	3	20.52	20.81
		4	0	0	20.11	20.32
	132322 / 1745	1	0	0	20.33	20.69
		4	0	0	19.88	20.15
	132622 / 1775	1	5	4	20.15	20.52
		4	2	7	19.95	20.22
66 / 15M	132047 / 1717.5	1	0	3	20.46	20.56
		6	0	0	20.05	20.32
	132322 / 1745	1	0	0	20.31	20.38
		6	0	0	19.89	20.01
	132597 / 1772.5	1	5	8	19.94	20.23
		6	0	11	20.01	20.09
66 / 20M	132072 / 1720	1	0	3	20.56	20.55
		6	0	0	20.11	20.25
	132322 / 1745	1	0	0	20.14	20.12
		6	0	0	19.89	20.01
	132572 / 1770	1	5	12	19.81	20.18
		6	0	15	19.84	20.13

LTE Band / BW	Channel / Frequency (MHz)	RB Size	RB Offset	Index	Conducted Power (dBm)	
					QPSK	16QAM
85 / 5M	134027 / 700.5	1	0	0	20.43	20.24
		6	0	0	19.15	19.30
	134092 / 707	1	0	0	20.32	19.94
		6	0	0	18.79	19.07
	134157 / 713.5	1	5	3	20.12	20.07
		6	0	3	19.03	19.21
85 / 10M	132052 / 703	1	0	0	20.28	20.33
		4	0	0	20.08	19.69
	134092 / 707	1	0	0	20.34	20.54
		4	0	0	20.02	20.33
	134132 / 711	1	5	0	20.12	20.11
		4	2	0	19.84	19.34

**EIRP (dBm):**

LTE Band / BW	Channel / Frequency (MHz)	RB Size	RB Offset	Index	Conducted Power (dBm)	
					QPSK	16QAM
4 / 1.4M	19957 / 1710.7	1	0	0	23.57	22.60
		6	0	0	21.38	21.31
	20175 / 1732.5	1	0	0	23.21	21.81
		6	0	0	21.12	21.14
	20393 / 1754.3	1	5	0	23.05	22.07
		6	0	0	21.13	21.21
4 / 3M	19965 / 1711.5	1	0	0	23.46	22.48
		6	0	0	21.36	21.27
	20175 / 1732.5	1	0	0	23.21	21.85
		6	0	0	21.12	21.11
	20385 / 1753.5	1	5	1	22.98	21.53
		6	0	1	21.11	21.17
4 / 5M	19975 / 1712.5	1	0	0	23.30	23.03
		6	0	0	22.13	22.11
	20175 / 1732.5	1	0	0	23.22	23.42
		6	0	0	21.92	21.93
	20375 / 1752.5	1	5	0	22.68	22.81
		6	0	3	21.72	21.76
4 / 10M	20000 / 1715	1	0	3	23.47	23.67
		4	0	0	23.20	23.23
	20175 / 1732.5	1	0	0	23.18	23.03
		4	0	0	23.03	23.04
	20350 / 1750	1	5	7	22.68	22.55
		4	2	7	22.76	22.45
4 / 15M	20025 / 1717.5	1	0	0	23.54	23.15
		6	0	0	23.11	23.09
	20175 / 1732.5	1	0	0	23.24	22.93
		6	0	0	23.10	23.22
	20325 / 1747.5	1	5	11	22.81	22.90
		6	0	11	22.97	22.96
4 / 20M	20050 / 1720	1	0	0	23.34	23.02
		6	0	0	23.21	23.32
	20175 / 1732.5	1	0	0	23.43	23.51
		6	0	0	23.07	23.26
	20300 / 1745	1	5	15	23.12	23.39
		6	0	15	22.95	23.07

LTE Band / BW	Channel / Frequency (MHz)	RB Size	RB Offset	Index	Conducted Power (dBm)	
					QPSK	16QAM
66 / 1.4M	131979 / 1710.7	1	0	0	23.13	22.35
		6	0	0	21.25	21.13
	132322 / 1745	1	0	0	23.18	22.36
		6	0	0	21.11	21.00
	132665 / 1779.3	1	5	0	23.01	22.43
		6	0	0	21.34	21.20
66 / 3M	131987 / 1711.5	1	0	0	23.20	22.50
		6	0	0	21.29	21.27
	132322 / 1745	1	0	0	23.05	22.30
		6	0	0	21.11	21.10
	132657 / 1778.5	1	5	1	23.17	22.68
		6	0	1	21.37	21.39
66 / 5M	131997 / 1712.5	1	0	3	23.58	23.53
		6	0	0	22.44	22.31
	132322 / 1745	1	0	0	23.46	23.52
		6	0	0	22.10	22.12
	132647 / 1777.5	1	5	0	23.52	24.07
		6	0	3	22.39	22.55
66 / 10M	132022 / 1715	1	0	3	23.62	23.91
		4	0	0	23.21	23.42
	132322 / 1745	1	0	0	23.43	23.79
		4	0	0	22.98	23.25
	132622 / 1775	1	5	4	23.25	23.62
		4	2	7	23.05	23.32
66 / 15M	132047 / 1717.5	1	0	3	23.56	23.66
		6	0	0	23.15	23.42
	132322 / 1745	1	0	0	23.41	23.48
		6	0	0	22.99	23.11
	132597 / 1772.5	1	5	8	23.04	23.33
		6	0	11	23.11	23.19
66 / 20M	132072 / 1720	1	0	3	23.66	23.65
		6	0	0	23.21	23.35
	132322 / 1745	1	0	0	23.24	23.22
		6	0	0	22.99	23.11
	132572 / 1770	1	5	12	22.91	23.28
		6	0	15	22.94	23.23



**ERP (dBm):**

LTE Band / BW	Channel / Frequency (MHz)	RB Size	RB Offset	Index	Conducted Power (dBm)	
					QPSK	16QAM
12 / 1.4M	23017 / 699.7	1	0	0	21.79	21.06
		6	0	0	19.80	19.72
	23095 / 707.5	1	0	0	21.68	20.44
		6	0	0	19.73	19.62
	23173 / 715.3	1	5	0	22.03	20.88
		6	0	0	19.99	19.92
12 / 3M	23025 / 700.5	1	0	0	21.68	20.86
		6	0	0	19.89	19.70
	23095 / 707.5	1	0	0	21.80	20.41
		6	0	0	21.80	19.68
	23165 / 714.5	1	5	1	21.91	20.67
		6	0	1	19.85	19.84
12 / 5M	23035 / 701.5	1	0	3	22.07	22.17
		6	0	0	20.59	20.87
	23095 / 707.5	1	0	0	21.99	21.91
		6	0	0	20.58	20.56
	23155 / 713.5	1	5	0	21.66	21.80
		6	0	3	20.67	20.89
12 / 10M	23060 / 704	1	0	3	22.01	22.13
		4	0	0	21.69	21.91
	23095 / 707.5	1	0	0	21.93	22.15
		4	0	0	21.75	21.81
	23130 / 711	1	5	4	21.68	21.76
		4	2	7	21.49	21.05

LTE Band / BW	Channel / Frequency (MHz)	RB Size	RB Offset	Index	Conducted Power (dBm)	
					QPSK	16QAM
13 / 5M	23205 / 779.5	1	0	0	21.72	21.42
		6	0	0	20.37	20.68
	23230 / 782	1	0	0	21.93	22.11
		6	0	0	20.37	20.43
	23255 / 784.5	1	5	3	21.54	21.45
		6	0	3	20.38	20.68
13 / 10M	23230 / 782	1	0	0	21.66	21.48
		4	0	0	21.43	20.87

LTE Band / BW	Channel / Frequency (MHz)	RB Size	RB Offset	Index	Conducted Power (dBm)	
					QPSK	16QAM
85 / 5M	134027 / 700.5	1	0	0	19.88	19.69
		6	0	0	18.60	18.75
	134092 / 707	1	0	0	19.77	19.39
		6	0	0	18.24	18.52
	134157 / 713.5	1	5	3	19.57	19.52
		6	0	3	18.48	18.66
85 / 10M	132052 / 703	1	0	0	19.73	19.78
		4	0	0	19.53	19.14
	134092 / 707	1	0	0	19.79	19.99
		4	0	0	19.47	19.78
	134132 / 711	1	5	0	19.57	19.56
		4	2	0	19.29	18.79

## APPENDIX B - OCCUPIED BANDWIDTH

LTE Band 4_1.4M					
QPSK					
Channel	Frequency (MHz)	99% Occupied Bandwidth (MHz)	Channel	Frequency (MHz)	26dB Bandwidth (MHz)
19957	1710.7	1.0845	19957	1710.7	1.276
20175	1732.5	1.0936	20175	1732.5	1.296
20393	1754.3	1.0817	20393	1754.3	1.243
16QAM					
Channel	Frequency (MHz)	99% Occupied Bandwidth (MHz)	Channel	Frequency (MHz)	26dB Bandwidth (MHz)
19957	1710.7	0.9266	19957	1710.7	1.120
20175	1732.5	0.9177	20175	1732.5	1.122
20393	1754.3	0.9241	20393	1754.3	1.110

## Spectrum Plot

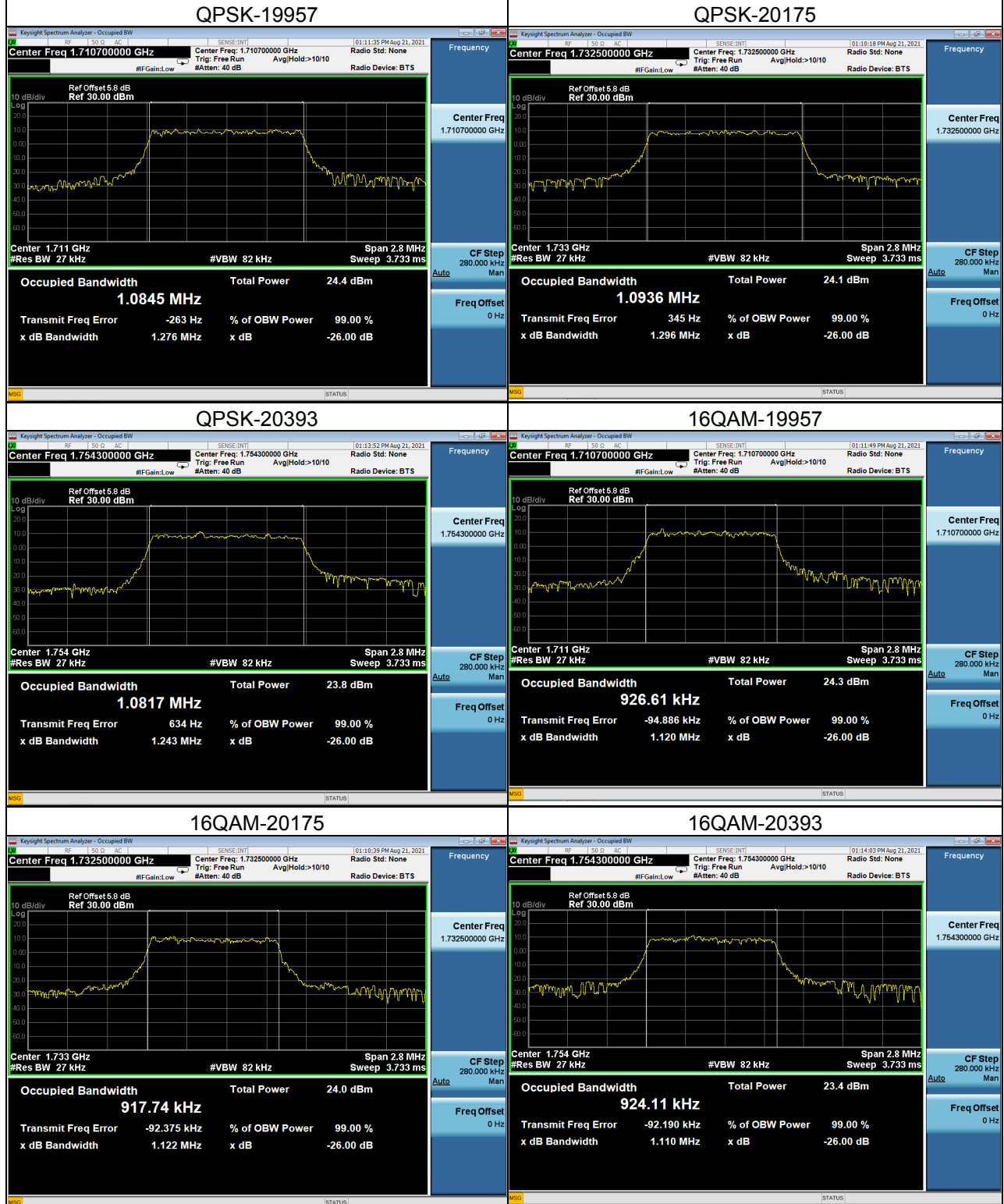

LTE Band 4_3M					
QPSK					
Channel	Frequency (MHz)	99% Occupied Bandwidth (MHz)	Channel	Frequency (MHz)	26dB Bandwidth (MHz)
19965	1711.5	1.1155	19965	1711.5	1.273
20175	1732.5	1.1163	20175	1732.5	1.330
20385	1753.5	1.1092	20385	1753.5	1.316
16QAM					
Channel	Frequency (MHz)	99% Occupied Bandwidth (MHz)	Channel	Frequency (MHz)	26dB Bandwidth (MHz)
19965	1711.5	0.9647	19965	1711.5	1.281
20175	1732.5	0.9592	20175	1732.5	1.162
20385	1753.5	0.9526	20385	1753.5	1.124

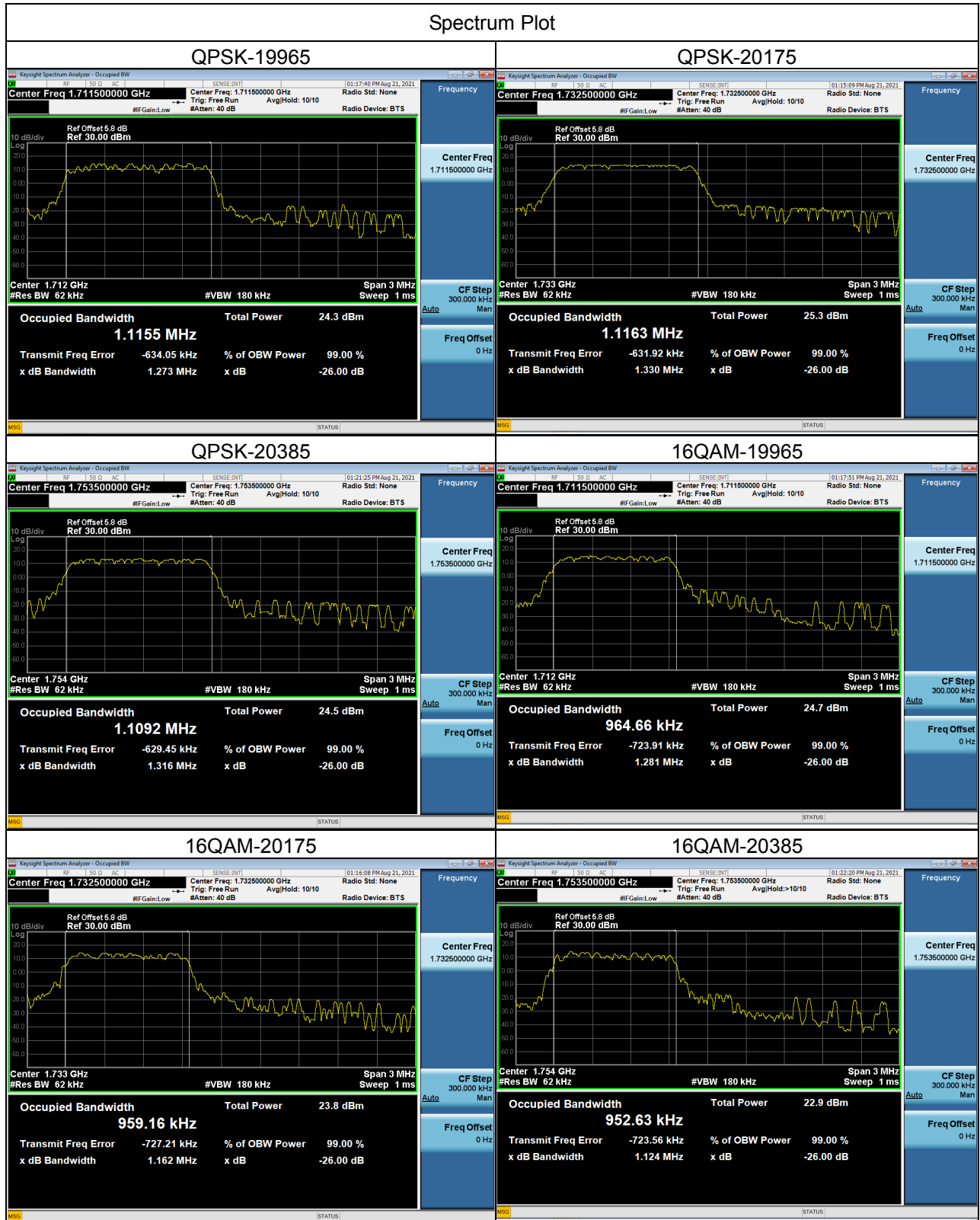

LTE Band 4_5M					
QPSK					
Channel	Frequency (MHz)	99% Occupied Bandwidth (MHz)	Channel	Frequency (MHz)	26dB Bandwidth (MHz)
19975	1712.5	1.1766	19975	1712.5	1.452
20175	1732.5	1.1833	20175	1732.5	1.476
20375	1752.5	1.2181	20375	1752.5	1.718
16QAM					
Channel	Frequency (MHz)	99% Occupied Bandwidth (MHz)	Channel	Frequency (MHz)	26dB Bandwidth (MHz)
19975	1712.5	1.0797	19975	1712.5	1.572
20175	1732.5	1.0295	20175	1732.5	1.251
20375	1752.5	1.0269	20375	1752.5	1.405



## Spectrum Plot

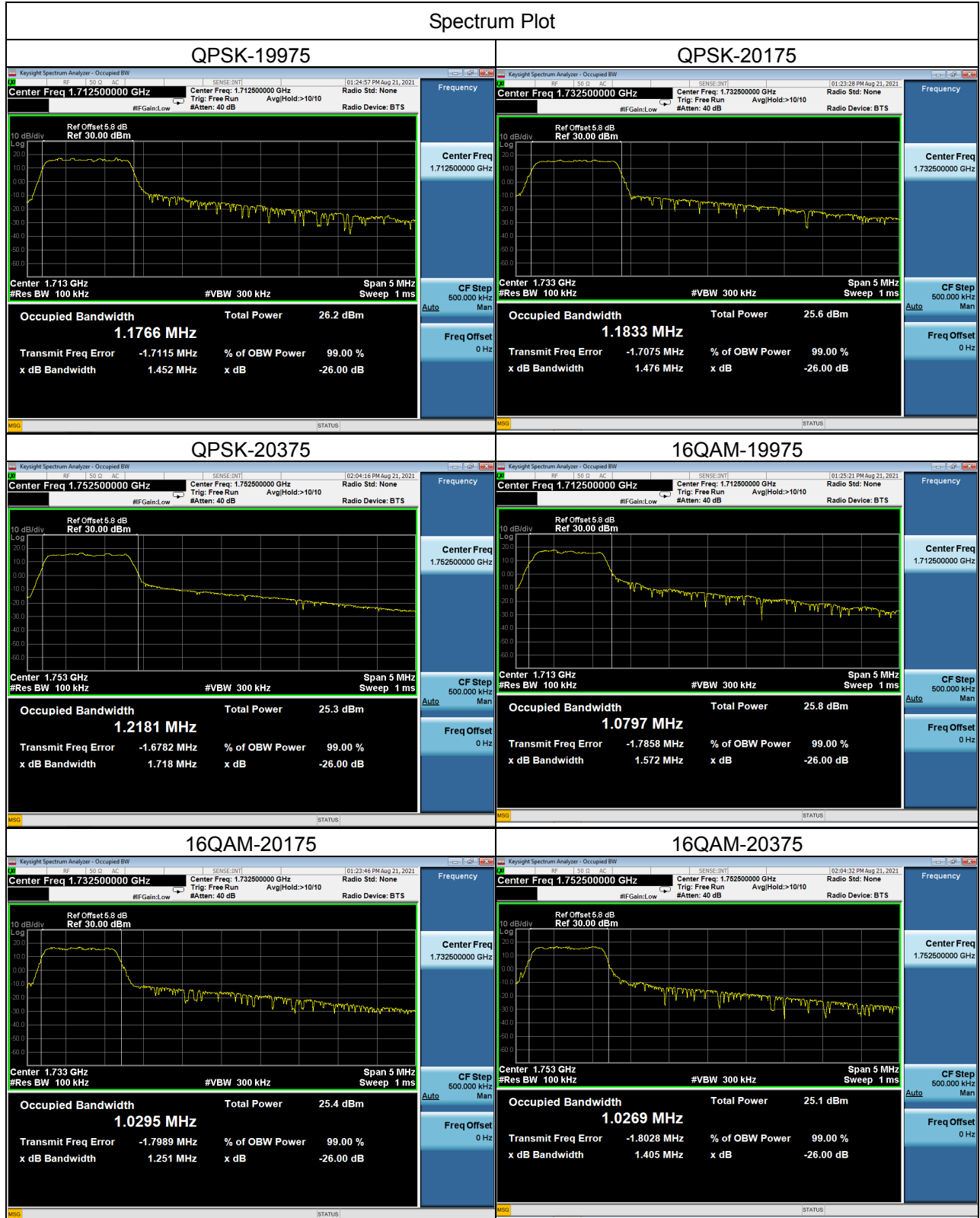

LTE Band 4_10M					
QPSK					
Channel	Frequency (MHz)	99% Occupied Bandwidth (MHz)	Channel	Frequency (MHz)	26dB Bandwidth (MHz)
20000	1715	1.3826	20000	1715	2.239
20175	1732.5	1.3827	20175	1732.5	2.733
20350	1750	1.3463	20350	1750	2.584
16QAM					
Channel	Frequency (MHz)	99% Occupied Bandwidth (MHz)	Channel	Frequency (MHz)	26dB Bandwidth (MHz)
20000	1715	1.4344	20000	1715	2.295
20175	1732.5	1.2004	20175	1732.5	1.828
20350	1750	1.1937	20350	1750	1.564

## Spectrum Plot

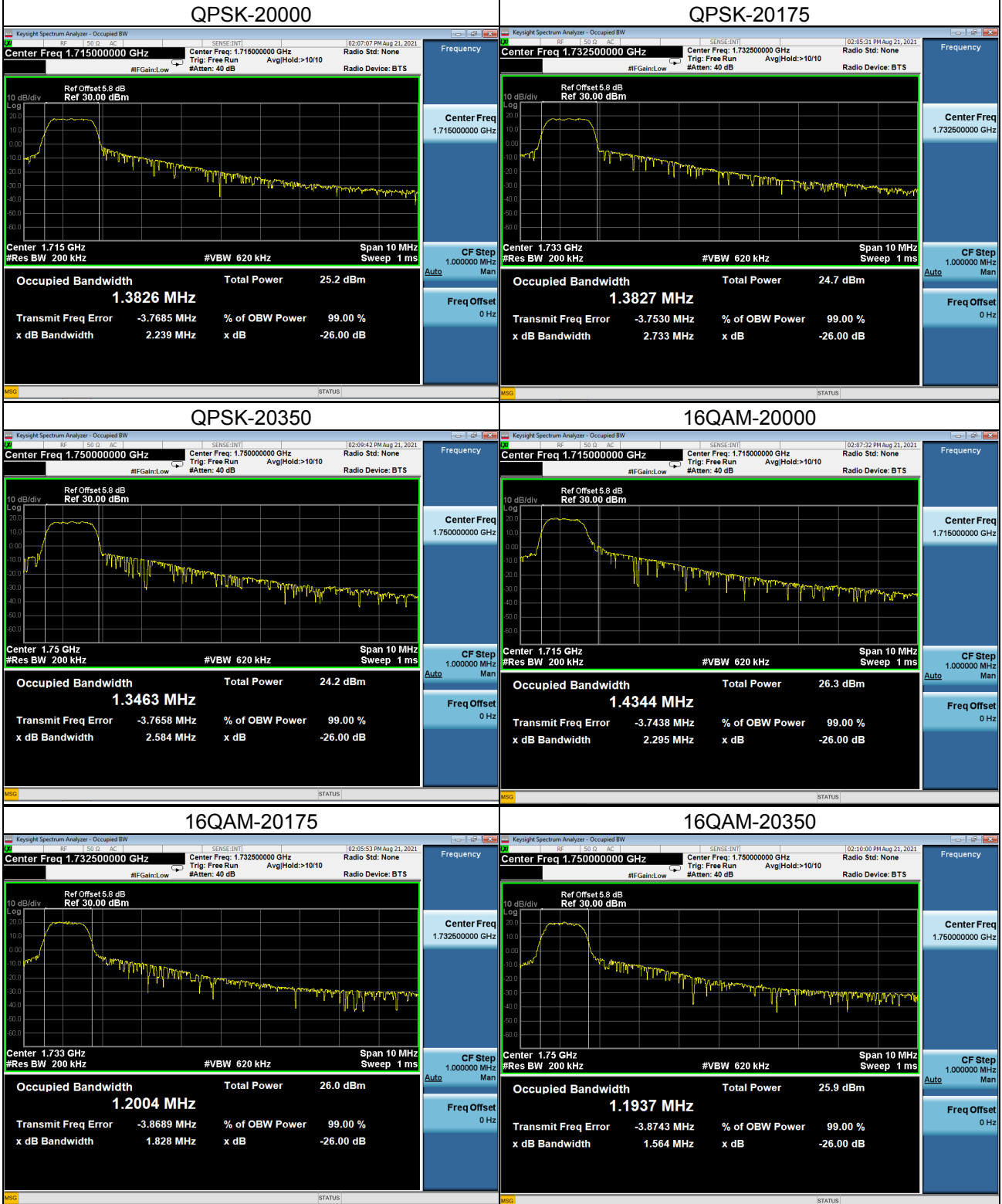

LTE Band 4_15M					
QPSK					
Channel	Frequency (MHz)	99% Occupied Bandwidth (MHz)	Channel	Frequency (MHz)	26dB Bandwidth (MHz)
20025	1717.5	1.5867	20025	1717.5	3.088
20175	1732.5	1.6207	20175	1732.5	3.407
20325	1747.5	1.7630	20325	1747.5	3.502
16QAM					
Channel	Frequency (MHz)	99% Occupied Bandwidth (MHz)	Channel	Frequency (MHz)	26dB Bandwidth (MHz)
20025	1717.5	1.6416	20025	1717.5	3.190
20175	1732.5	1.3658	20175	1732.5	2.368
20325	1747.5	1.4464	20325	1747.5	2.664

## Spectrum Plot

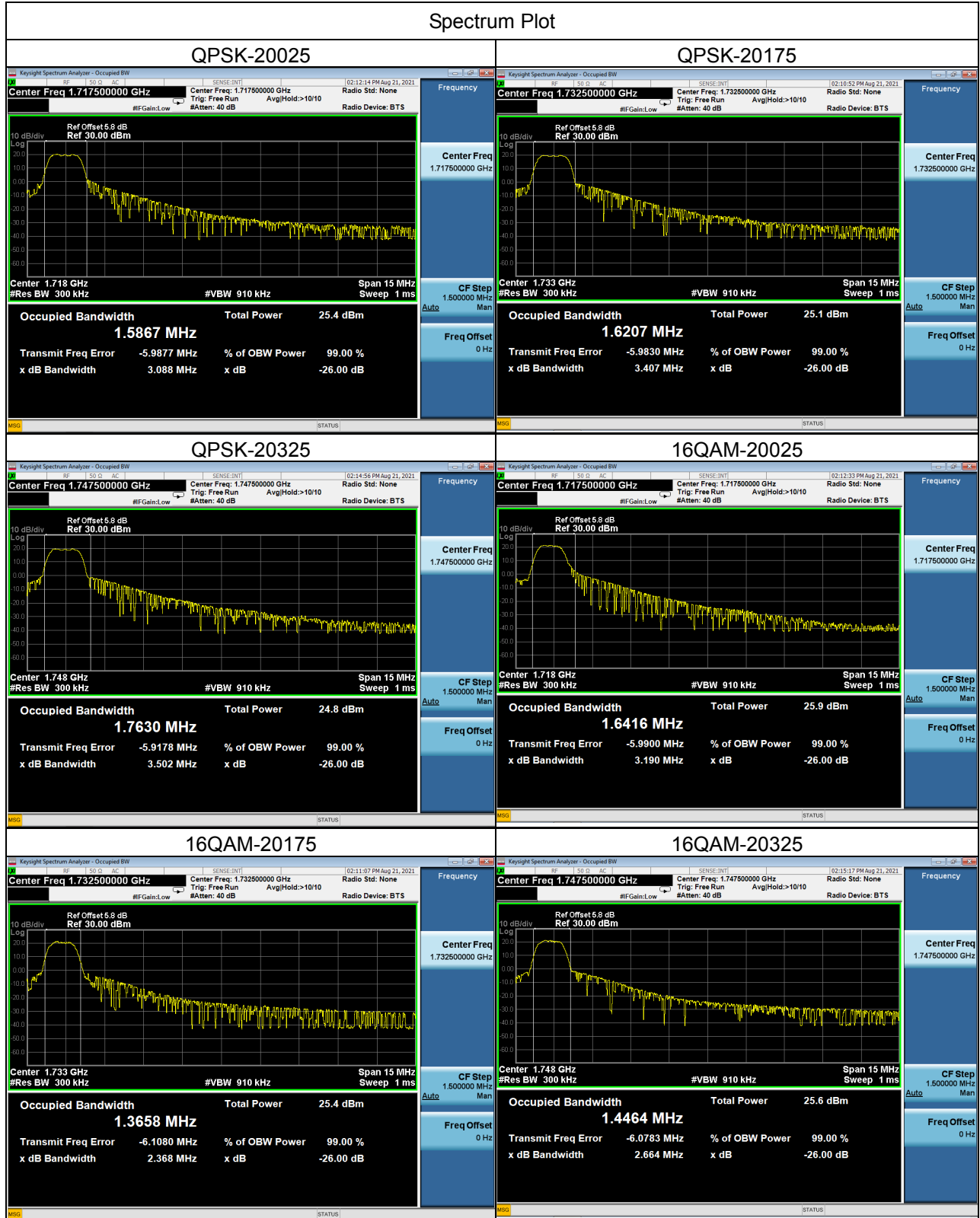

LTE Band 4_20M					
QPSK					
Channel	Frequency (MHz)	99% Occupied Bandwidth (MHz)	Channel	Frequency (MHz)	26dB Bandwidth (MHz)
20050	1720	1.9482	20050	1720	3.702
20175	1732.5	2.0226	20175	1732.5	4.282
20300	1740	2.1222	20300	1740	4.307
16QAM					
Channel	Frequency (MHz)	99% Occupied Bandwidth (MHz)	Channel	Frequency (MHz)	26dB Bandwidth (MHz)
20050	1720	1.9637	20050	1720	3.742
20175	1732.5	1.6653	20175	1732.5	3.425
20300	1740	1.8542	20300	1740	3.477

## Spectrum Plot

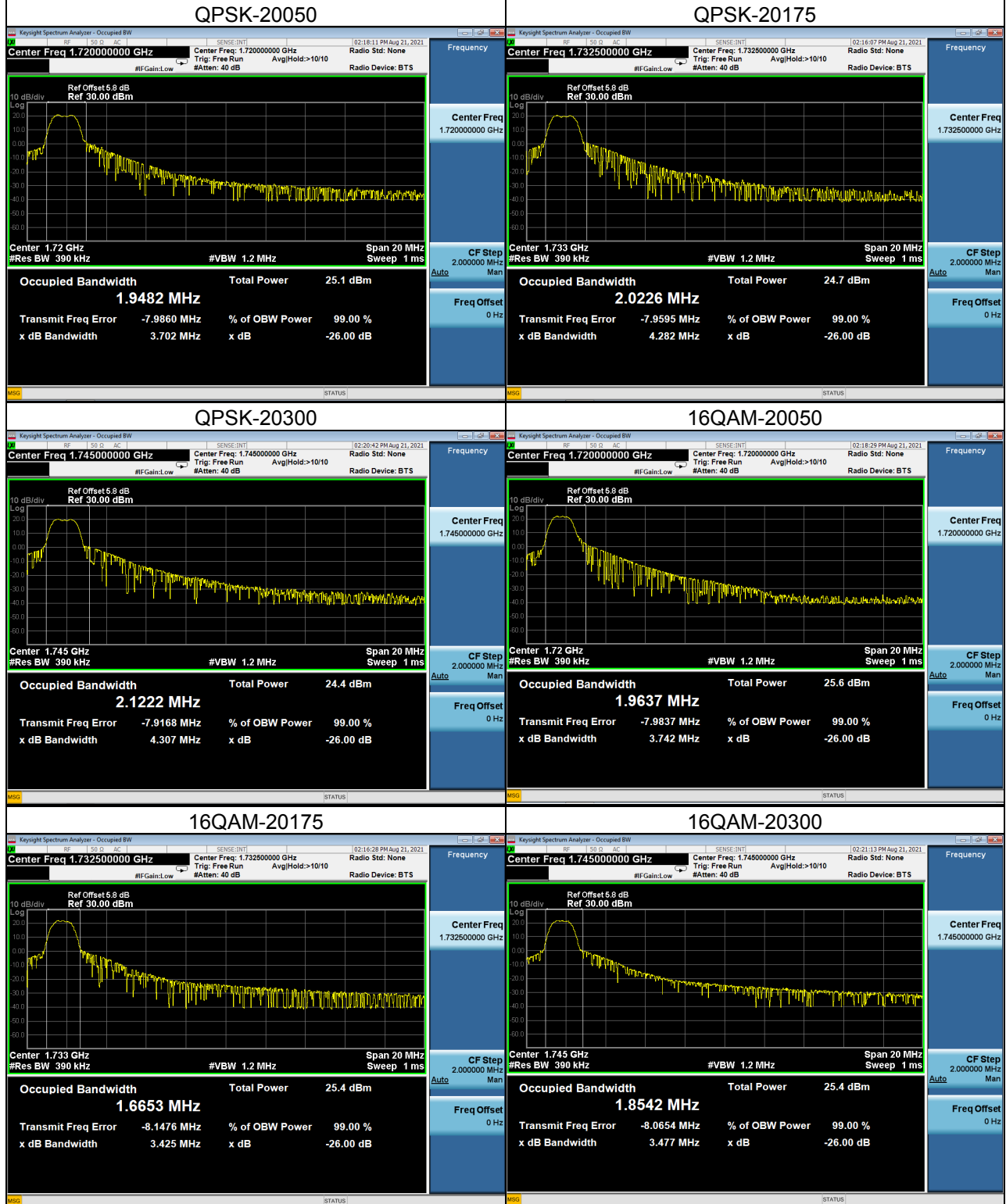

LTE Band 12_1.4M					
QPSK					
Channel	Frequency (MHz)	99% Occupied Bandwidth (MHz)	Channel	Frequency (MHz)	26dB Bandwidth (MHz)
23017	699.7	1.0935	23017	699.7	1.294
23095	707.5	1.0904	23095	707.5	1.201
23173	715.3	1.0874	23173	715.3	1.261
16QAM					
Channel	Frequency (MHz)	99% Occupied Bandwidth (MHz)	Channel	Frequency (MHz)	26dB Bandwidth (MHz)
23017	699.7	1.0500	23017	699.7	1.137
23095	707.5	0.9202	23095	707.5	1.117
23173	715.3	0.9315	23173	715.3	1.138



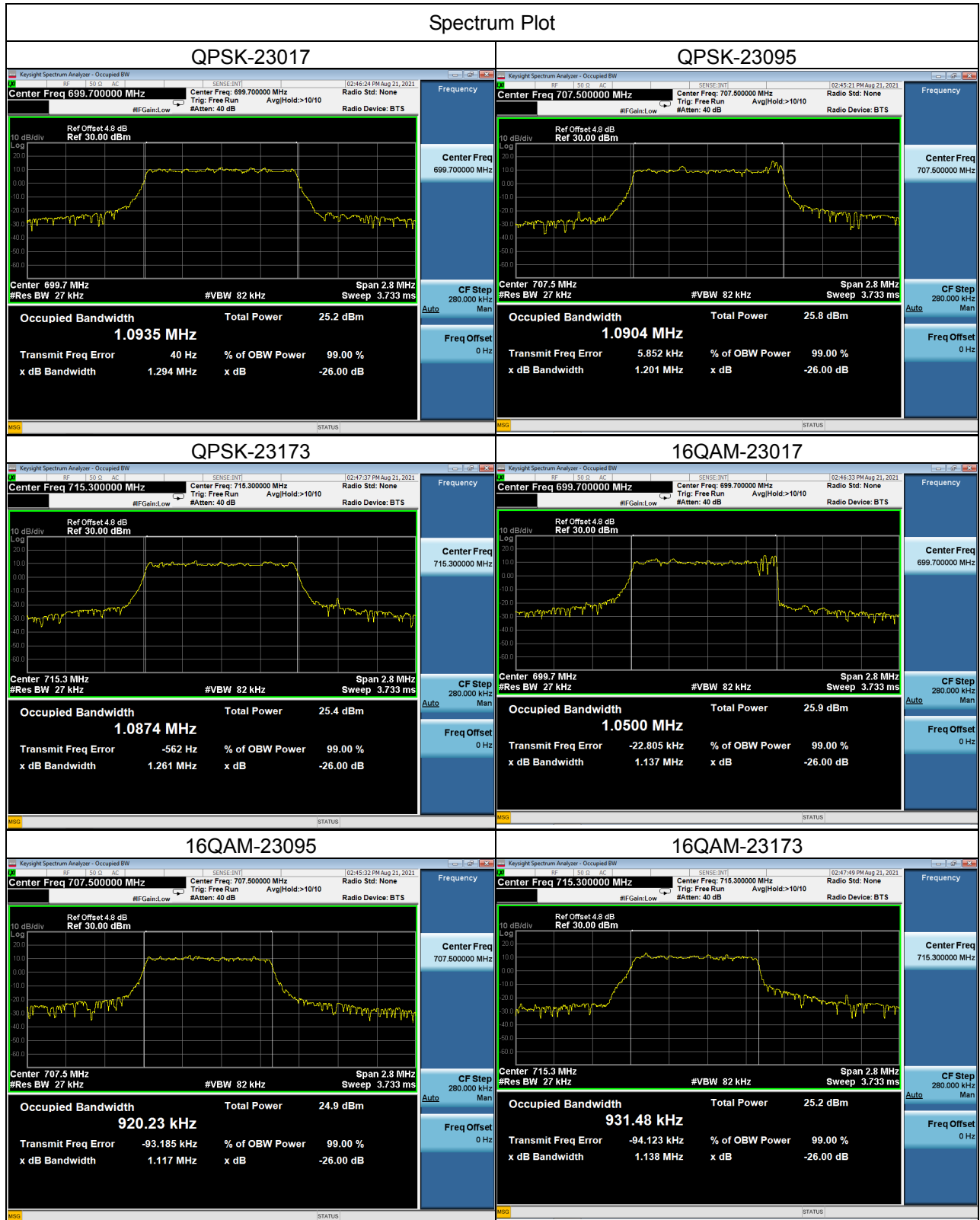

LTE Band 12_3M					
QPSK					
Channel	Frequency (MHz)	99% Occupied Bandwidth (MHz)	Channel	Frequency (MHz)	26dB Bandwidth (MHz)
23025	700.5	1.1082	23025	700.5	1.302
23095	707.5	1.1167	23095	707.5	1.320
23165	714.5	1.1113	23165	714.5	1.373
16QAM					
Channel	Frequency (MHz)	99% Occupied Bandwidth (MHz)	Channel	Frequency (MHz)	26dB Bandwidth (MHz)
23025	700.5	0.9645	23025	700.5	1.279
23095	707.5	0.9645	23095	707.5	1.148
23165	714.5	0.9714	23165	714.5	1.139

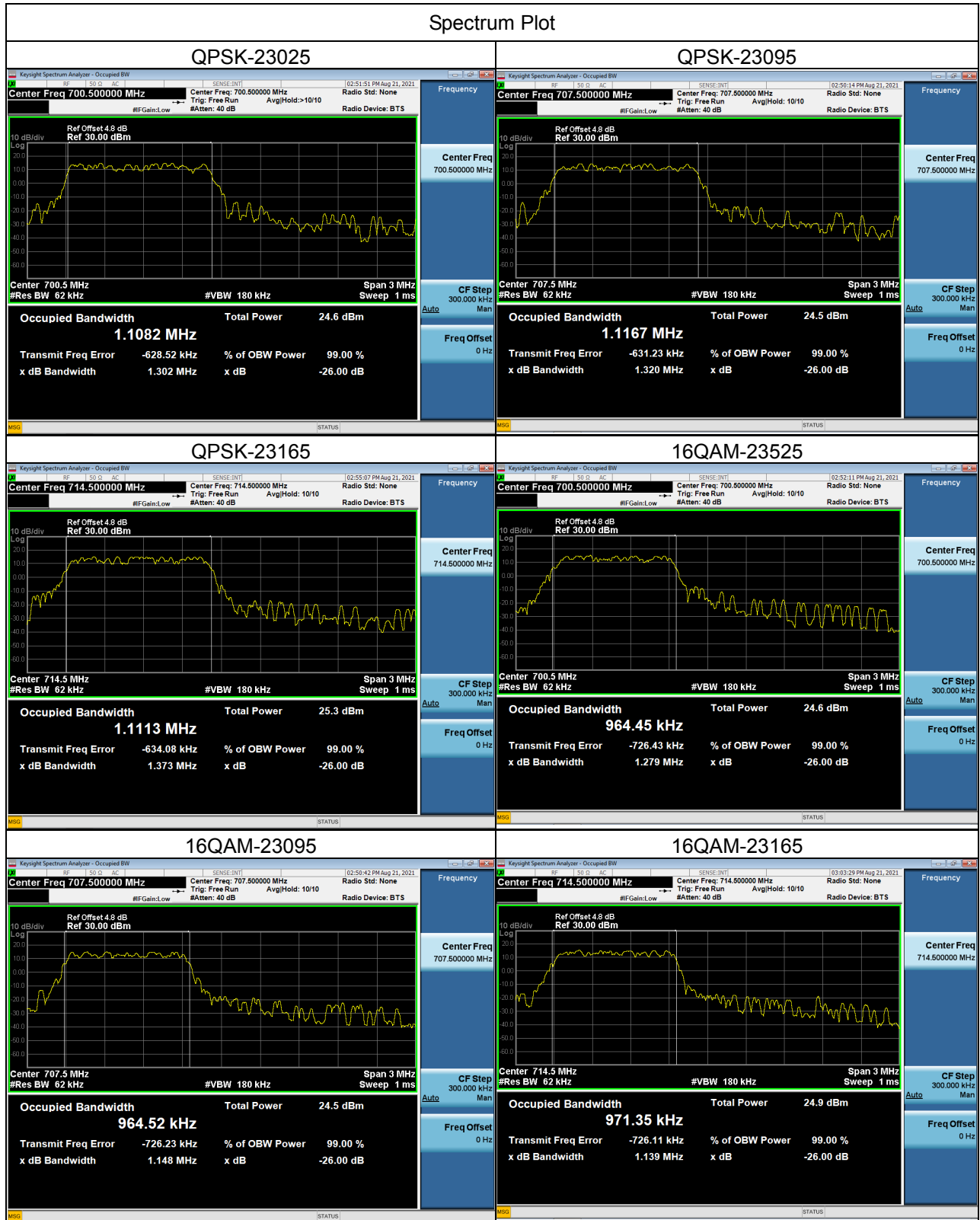

LTE Band 12_5M					
QPSK					
Channel	Frequency (MHz)	99% Occupied Bandwidth (MHz)	Channel	Frequency (MHz)	26dB Bandwidth (MHz)
23035	701.5	1.1599	23035	701.5	1.440
23095	707.5	1.1750	23095	707.5	1.475
23155	713.5	1.1702	23155	713.5	1.513
16QAM					
Channel	Frequency (MHz)	99% Occupied Bandwidth (MHz)	Channel	Frequency (MHz)	26dB Bandwidth (MHz)
23035	701.5	1.0467	23035	701.5	1.501
23095	707.5	1.0198	23095	707.5	1.308
23155	713.5	1.0209	23155	713.5	1.300

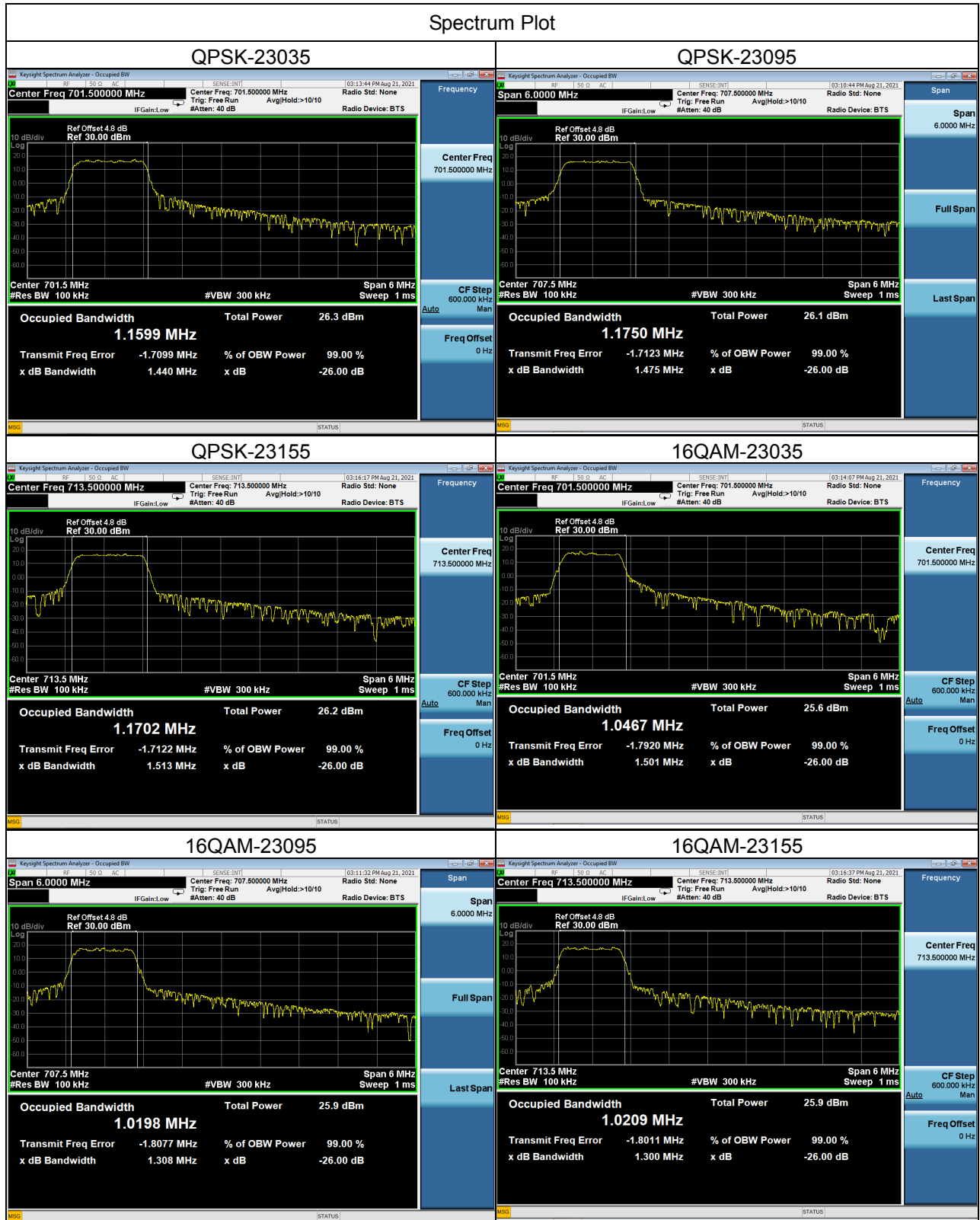

LTE Band 12_10M					
QPSK					
Channel	Frequency (MHz)	99% Occupied Bandwidth (MHz)	Channel	Frequency (MHz)	26dB Bandwidth (MHz)
23060	704.0	1.3267	23060	704.0	1.974
23095	707.5	1.3277	23095	707.5	2.272
23130	711.0	1.3220	23130	711.0	2.188
16QAM					
Channel	Frequency (MHz)	99% Occupied Bandwidth (MHz)	Channel	Frequency (MHz)	26dB Bandwidth (MHz)
23060	704.0	1.2357	23060	704.0	1.764
23095	707.5	1.1792	23095	707.5	1.652
23130	711.0	1.1701	23130	711.0	1.605

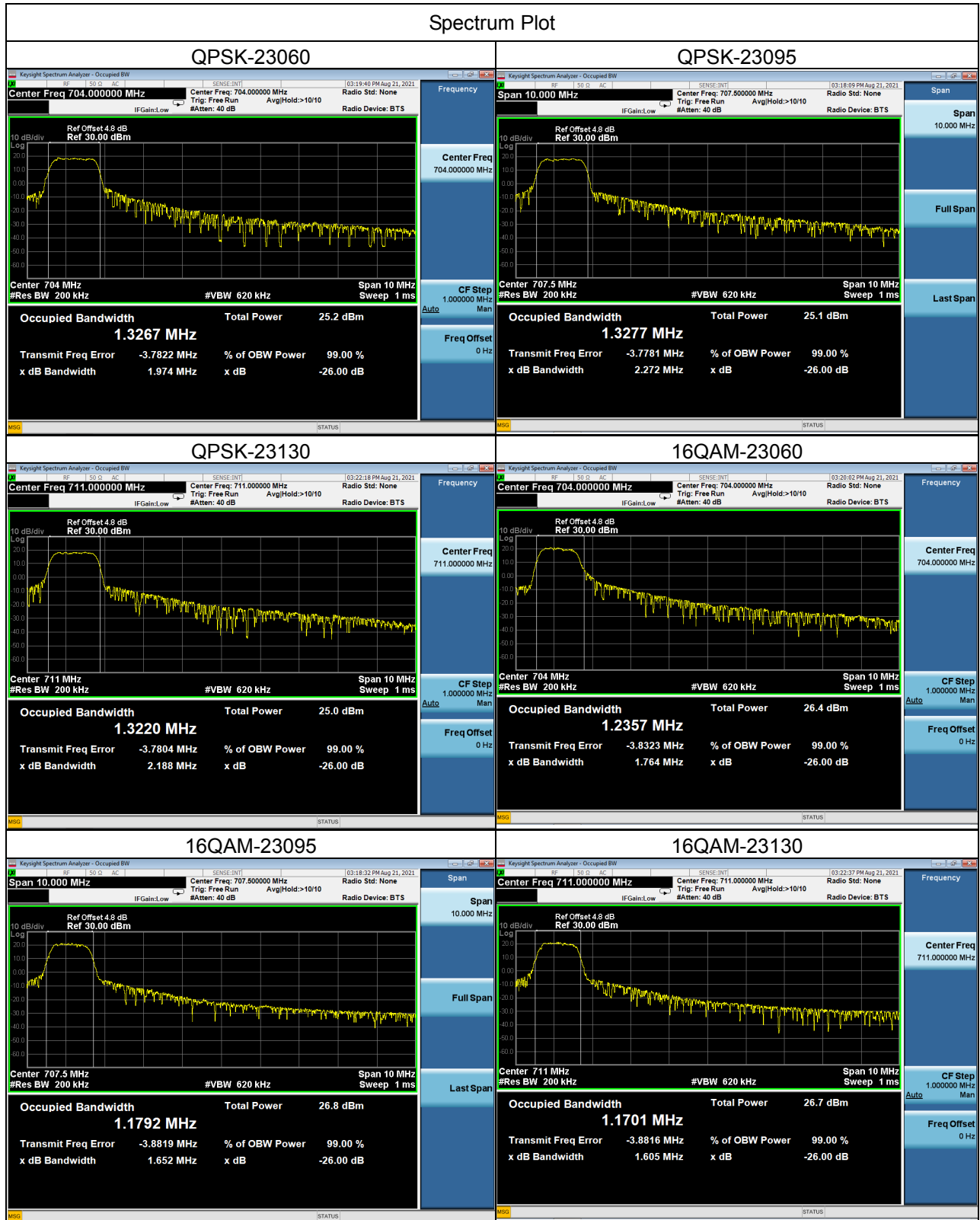

LTE Band 13_5M					
QPSK					
Channel	Frequency (MHz)	99% Occupied Bandwidth (MHz)	Channel	Frequency (MHz)	26dB Bandwidth (MHz)
23205	779.5	1.1680	23205	779.5	1.484
23230	782.0	1.1829	23230	782.0	1.635
23255	784.5	1.1776	23255	784.5	1.491
16QAM					
Channel	Frequency (MHz)	99% Occupied Bandwidth (MHz)	Channel	Frequency (MHz)	26dB Bandwidth (MHz)
23205	779.5	1.0230	23205	779.5	1.305
23230	782.0	1.0119	23230	782.0	1.375
23255	784.5	1.0222	23255	784.5	1.295



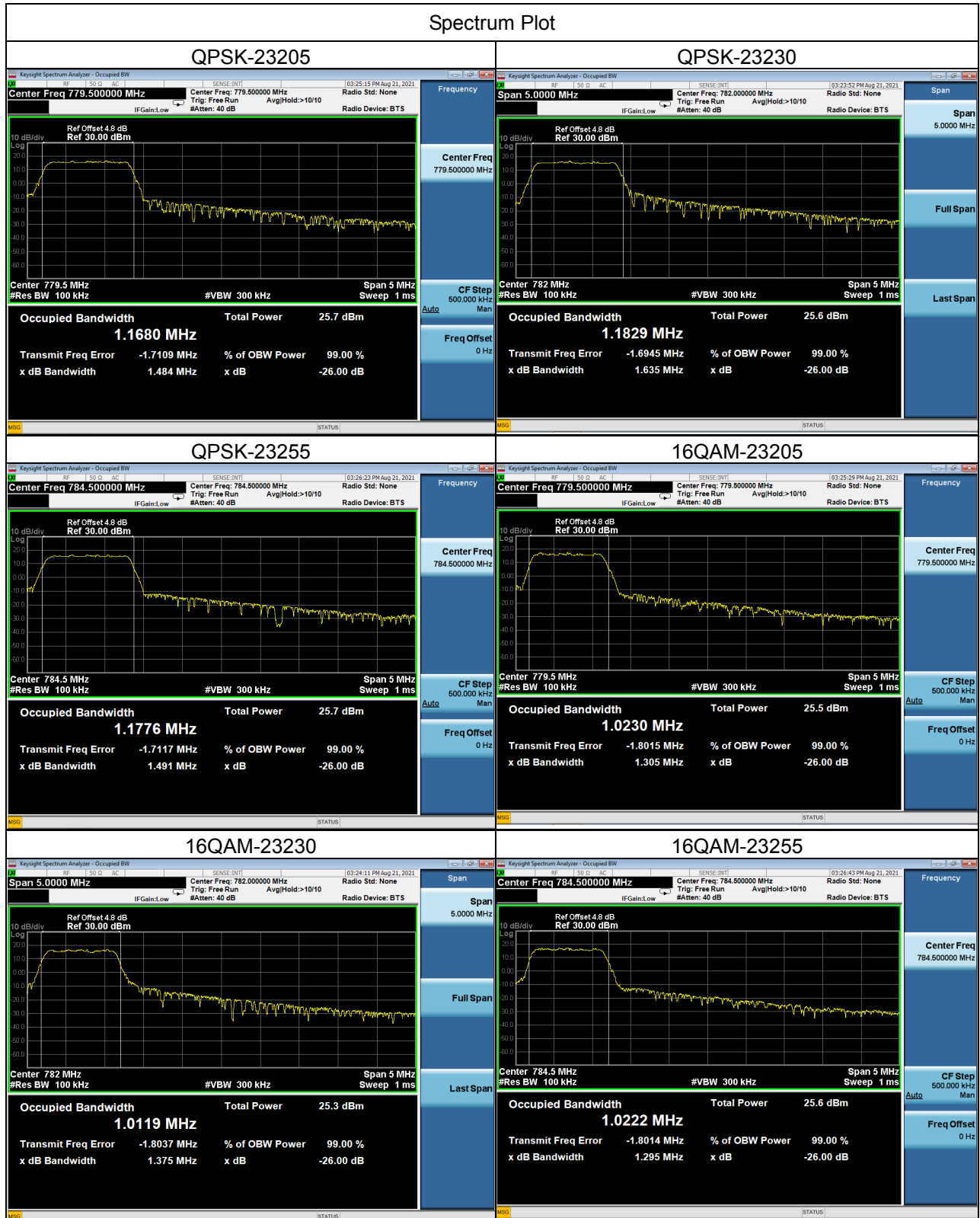

LTE Band 13_10M					
QPSK					
Channel	Frequency (MHz)	99% Occupied Bandwidth (MHz)	Channel	Frequency (MHz)	26dB Bandwidth (MHz)
23230	782.0	1.3249	23230	782.0	2.204
16QAM					
Channel	Frequency (MHz)	99% Occupied Bandwidth (MHz)	Channel	Frequency (MHz)	26dB Bandwidth (MHz)
23230	782.0	1.1760	23230	782.0	1.584

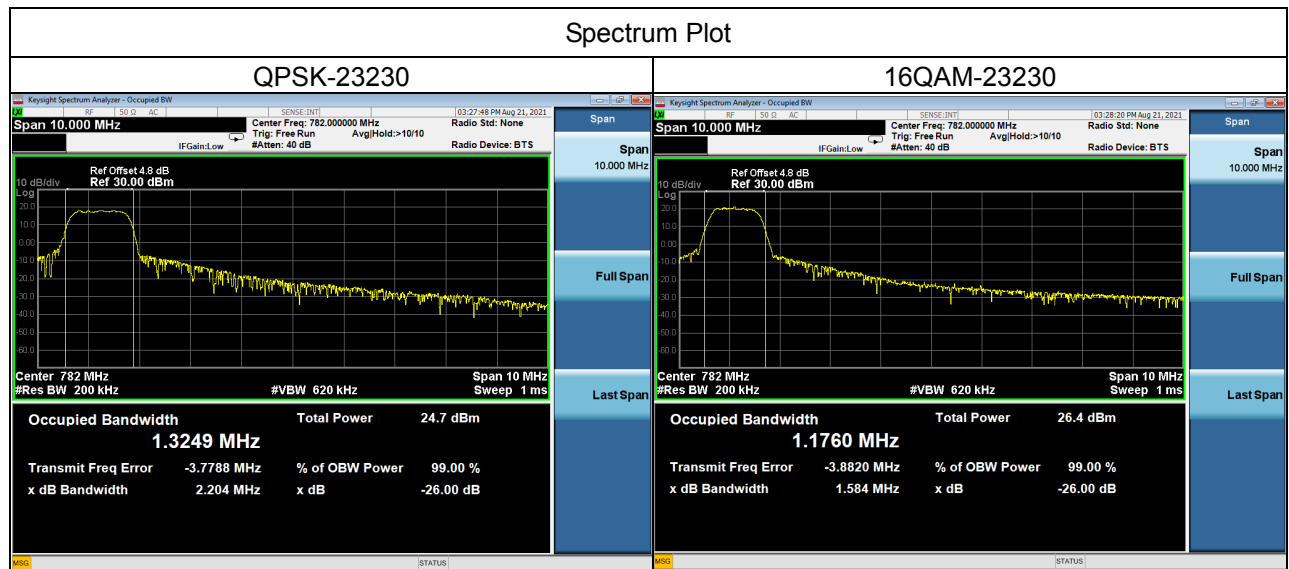

LTE Band 66_1.4M					
QPSK					
Channel	Frequency (MHz)	99% Occupied Bandwidth (MHz)	Channel	Frequency (MHz)	26dB Bandwidth (MHz)
131979	1710.7	1.0879	131979	1710.7	1.245
132322	1745	1.0861	132322	1745	1.207
132665	1779.3	1.0833	132665	1779.3	1.161
16QAM					
Channel	Frequency (MHz)	99% Occupied Bandwidth (MHz)	Channel	Frequency (MHz)	26dB Bandwidth (MHz)
131979	1710.7	0.9224	131979	1710.7	1.143
132322	1745	0.9179	132322	1745	1.115
132665	1779.3	0.9151	132665	1779.3	1.102

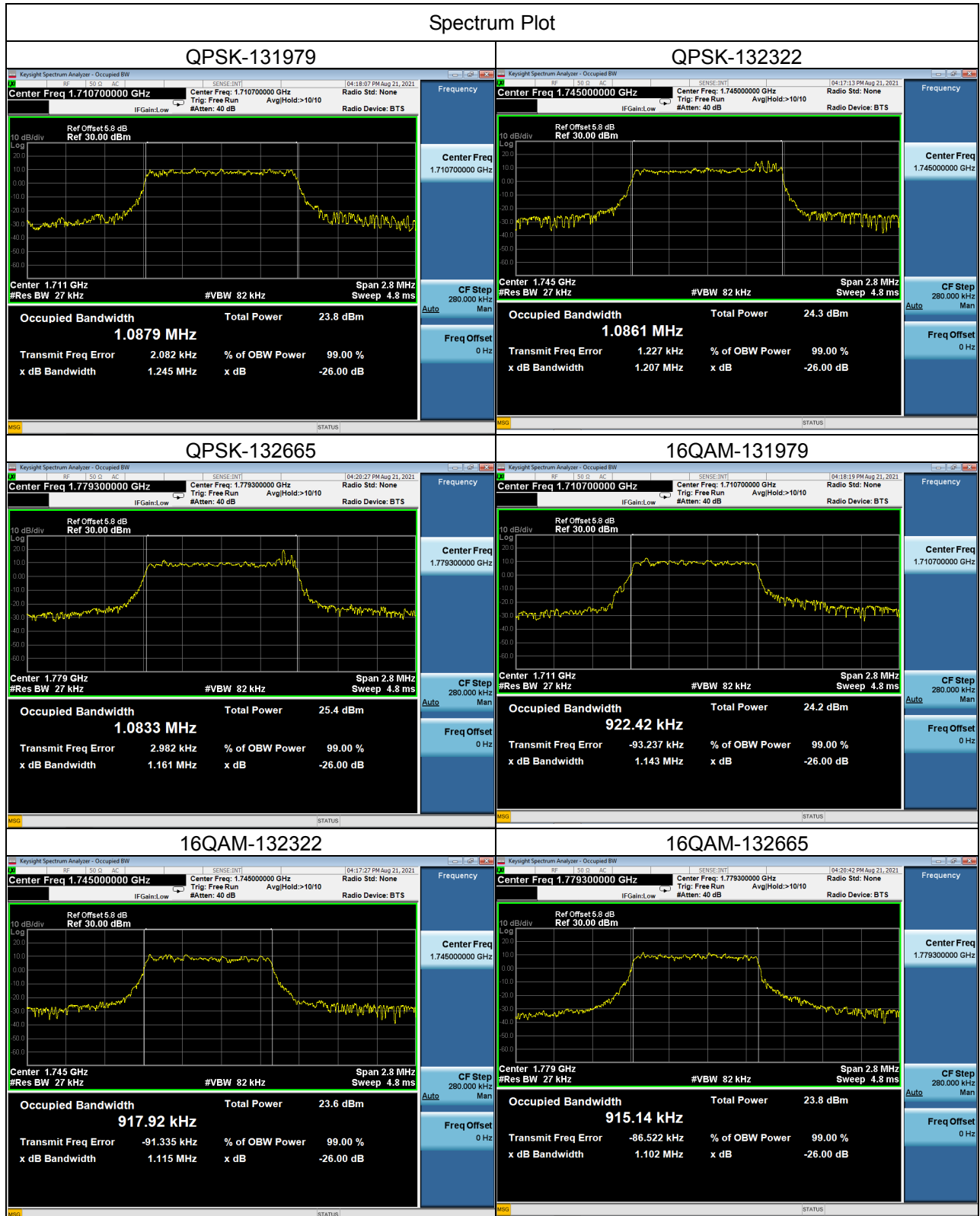

LTE Band 66_3M					
QPSK					
Channel	Frequency (MHz)	99% Occupied Bandwidth (MHz)	Channel	Frequency (MHz)	26dB Bandwidth (MHz)
131987	1711.5	1.1274	131987	1711.5	1.331
132322	1745	1.1190	132322	1745	1.268
132657	1778.5	1.1058	132657	1778.5	1.321
16QAM					
Channel	Frequency (MHz)	99% Occupied Bandwidth (MHz)	Channel	Frequency (MHz)	26dB Bandwidth (MHz)
131987	1711.5	0.9433	131987	1711.5	1.154
132322	1745	0.9491	132322	1745	1.147
132657	1778.5	0.9552	132657	1778.5	1.154

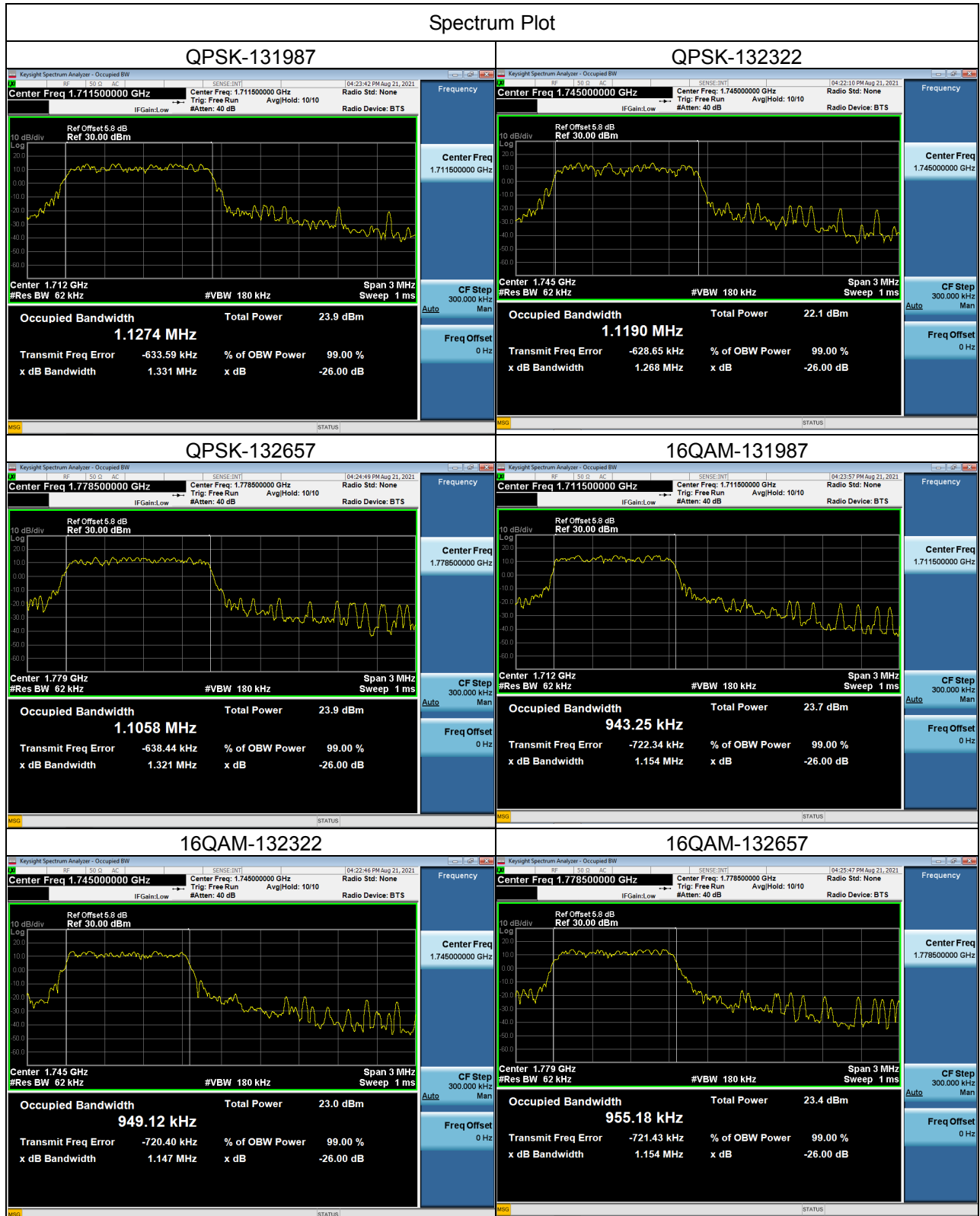

LTE Band 66_5M					
QPSK					
Channel	Frequency (MHz)	99% Occupied Bandwidth (MHz)	Channel	Frequency (MHz)	26dB Bandwidth (MHz)
131997	1712.5	1.1819	131997	1712.5	1.468
132322	1745	1.1736	132322	1745	1.487
132647	1777.5	1.1718	132647	1777.5	1.497
16QAM					
Channel	Frequency (MHz)	99% Occupied Bandwidth (MHz)	Channel	Frequency (MHz)	26dB Bandwidth (MHz)
131997	1712.5	1.0261	131997	1712.5	1.279
132322	1745	1.0265	132322	1745	1.271
132647	1777.5	1.0788	132647	1777.5	1.527

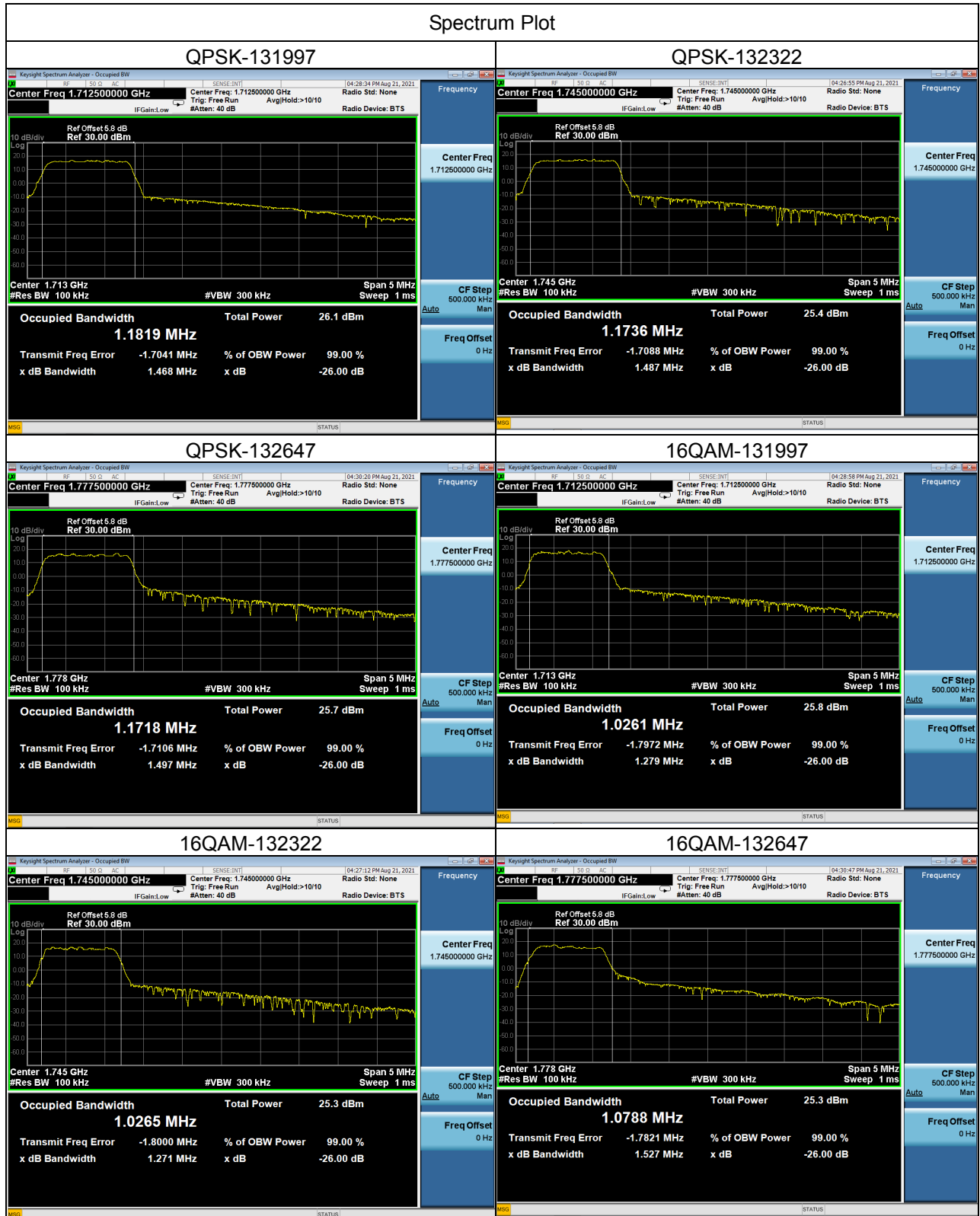



LTE Band 66_10M					
QPSK					
Channel	Frequency (MHz)	99% Occupied Bandwidth (MHz)	Channel	Frequency (MHz)	26dB Bandwidth (MHz)
132022	1715	1.3539	132022	1715	2.527
132322	1745	1.3403	132322	1745	2.464
132622	1775	1.3452	132622	1775	2.463
16QAM					
Channel	Frequency (MHz)	99% Occupied Bandwidth (MHz)	Channel	Frequency (MHz)	26dB Bandwidth (MHz)
132022	1715	1.2032	132022	1715	1.738
132322	1745	1.1909	132322	1745	1.532
132622	1775	1.1891	132622	1775	1.534

## Spectrum Plot

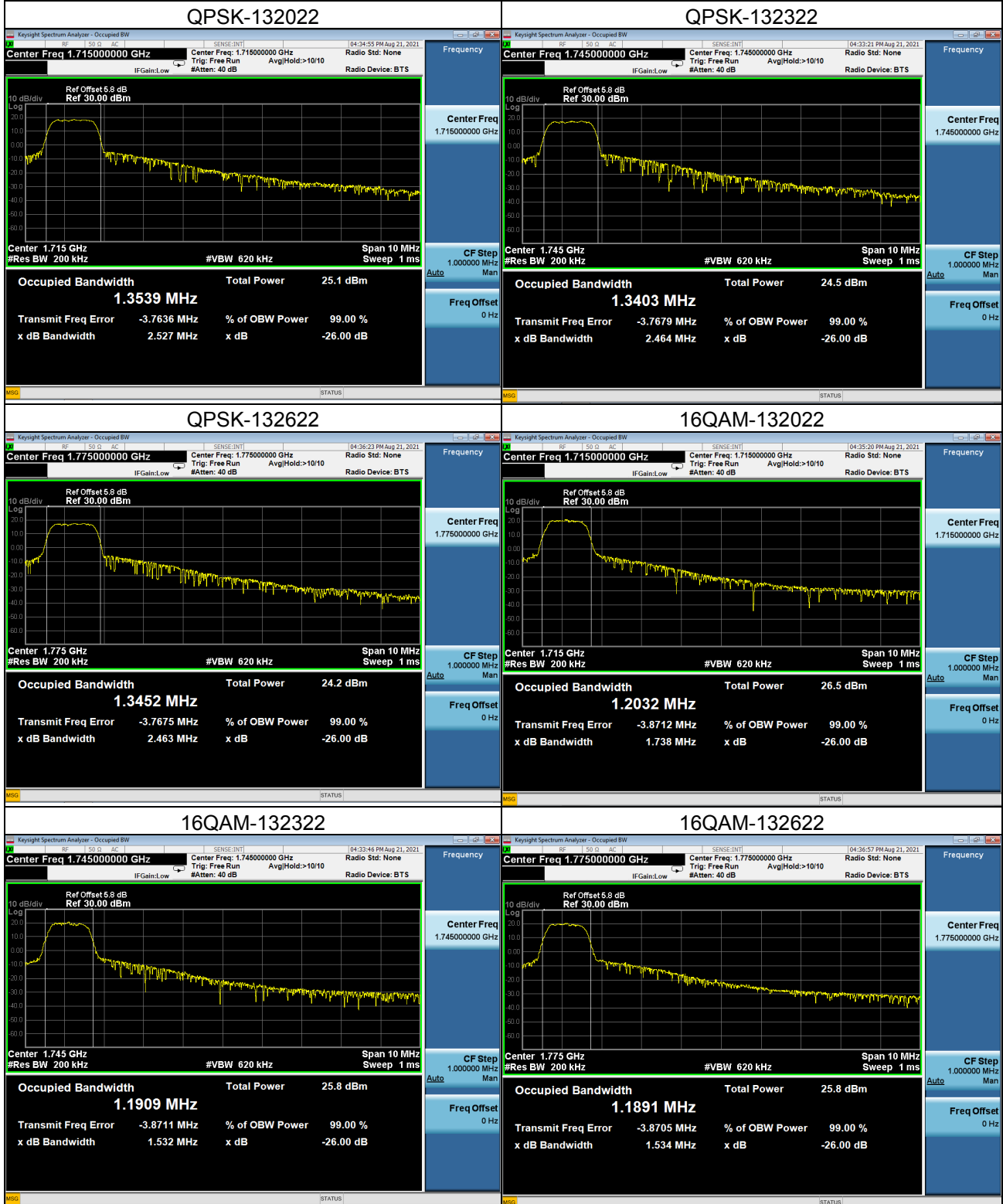

LTE Band 66_15M					
QPSK					
Channel	Frequency (MHz)	99% Occupied Bandwidth (MHz)	Channel	Frequency (MHz)	26dB Bandwidth (MHz)
132047	1717.5	1.5619	132047	1717.5	3.301
132322	1745	1.6177	132322	1745	3.349
132597	1772.5	1.6405	132597	1772.5	2.951
16QAM					
Channel	Frequency (MHz)	99% Occupied Bandwidth (MHz)	Channel	Frequency (MHz)	26dB Bandwidth (MHz)
132047	1717.5	1.3708	132047	1717.5	2.399
132322	1745	1.3747	132322	1745	2.584
132597	1772.5	1.6778	132597	1772.5	2.654

## Spectrum Plot

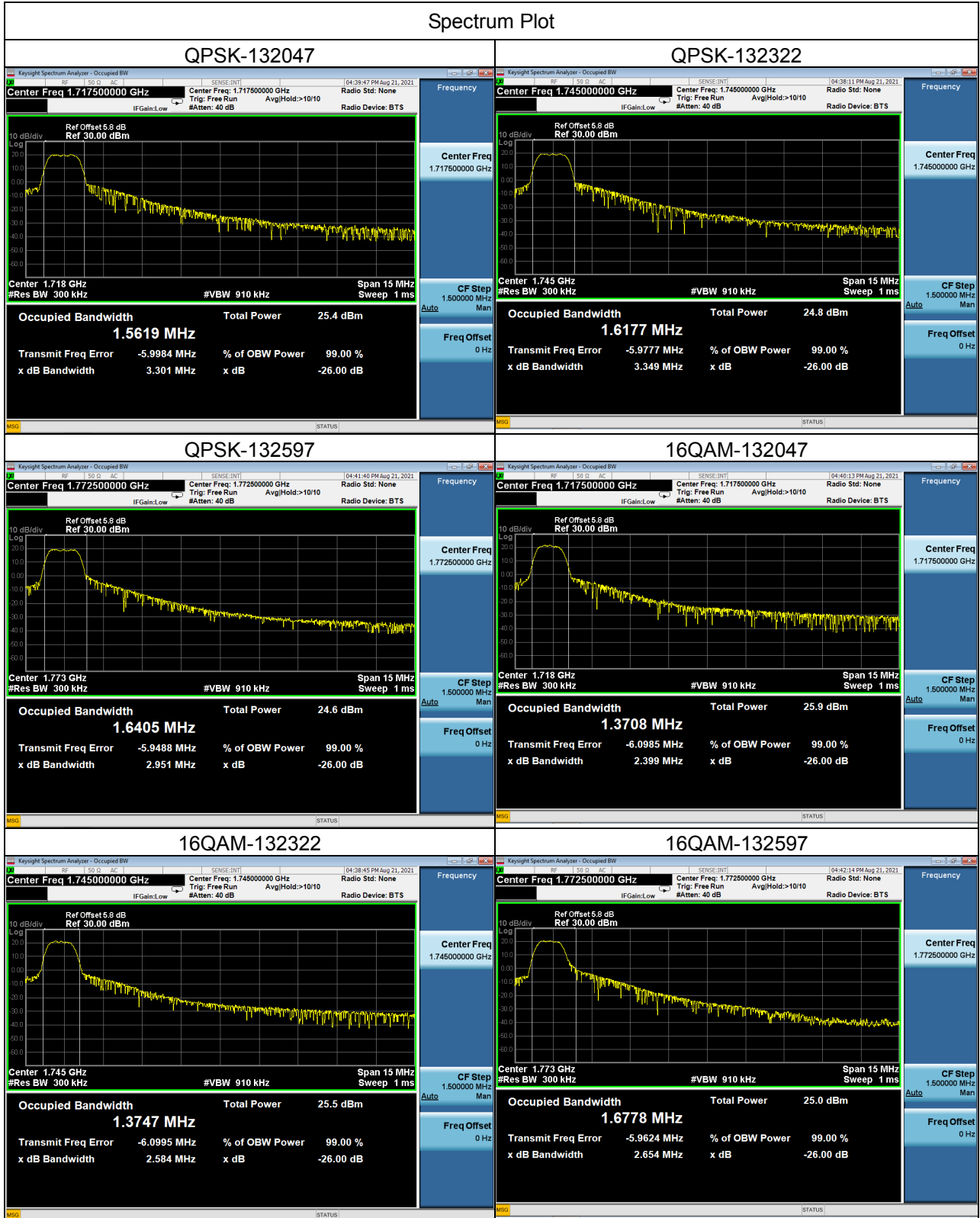

LTE Band 66_20M					
QPSK					
Channel	Frequency (MHz)	99% Occupied Bandwidth (MHz)	Channel	Frequency (MHz)	26dB Bandwidth (MHz)
132072	1720	1.9055	132072	1720	3.966
132322	1745	1.9087	132322	1745	3.982
132572	1770	1.7714	132572	1770	3.247
16QAM					
Channel	Frequency (MHz)	99% Occupied Bandwidth (MHz)	Channel	Frequency (MHz)	26dB Bandwidth (MHz)
132072	1720	1.6043	132072	1720	3.052
132322	1745	1.6274	132322	1745	3.326
132572	1770	2.0326	132572	1770	3.422

## Spectrum Plot

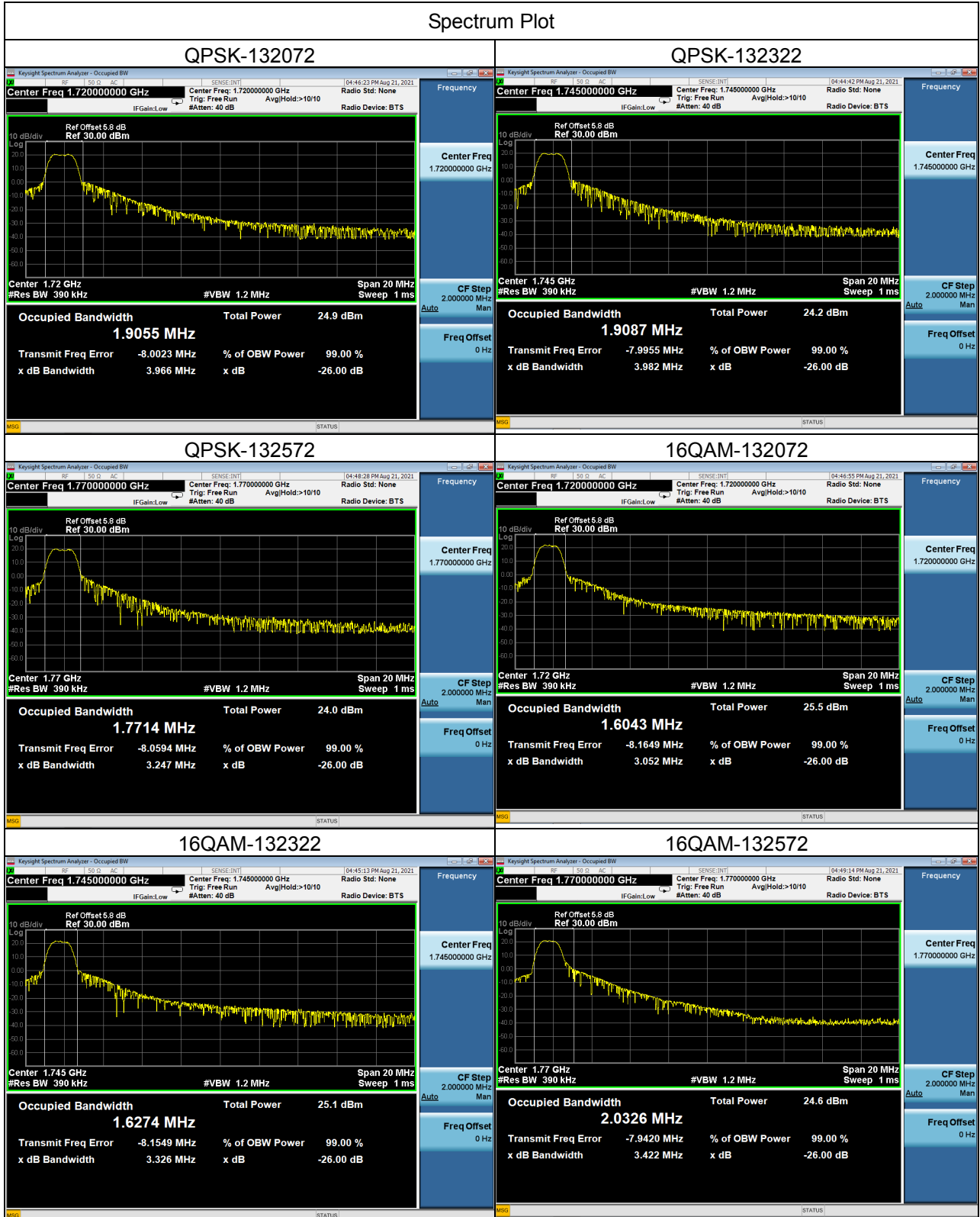

LTE Band 85_5M					
QPSK					
Channel	Frequency (MHz)	99% Occupied Bandwidth (MHz)	Channel	Frequency (MHz)	26dB Bandwidth (MHz)
134027	700.5	1.1718	134027	700.5	1.483
134092	707	1.1720	134092	707	1.458
134157	713.5	1.1763	134157	713.5	1.495
16QAM					
Channel	Frequency (MHz)	99% Occupied Bandwidth (MHz)	Channel	Frequency (MHz)	26dB Bandwidth (MHz)
134027	700.5	1.0252	134027	700.5	1.324
134092	707	1.0214	134092	707	1.301
134157	713.5	1.0246	134157	713.5	1.323

## Spectrum Plot

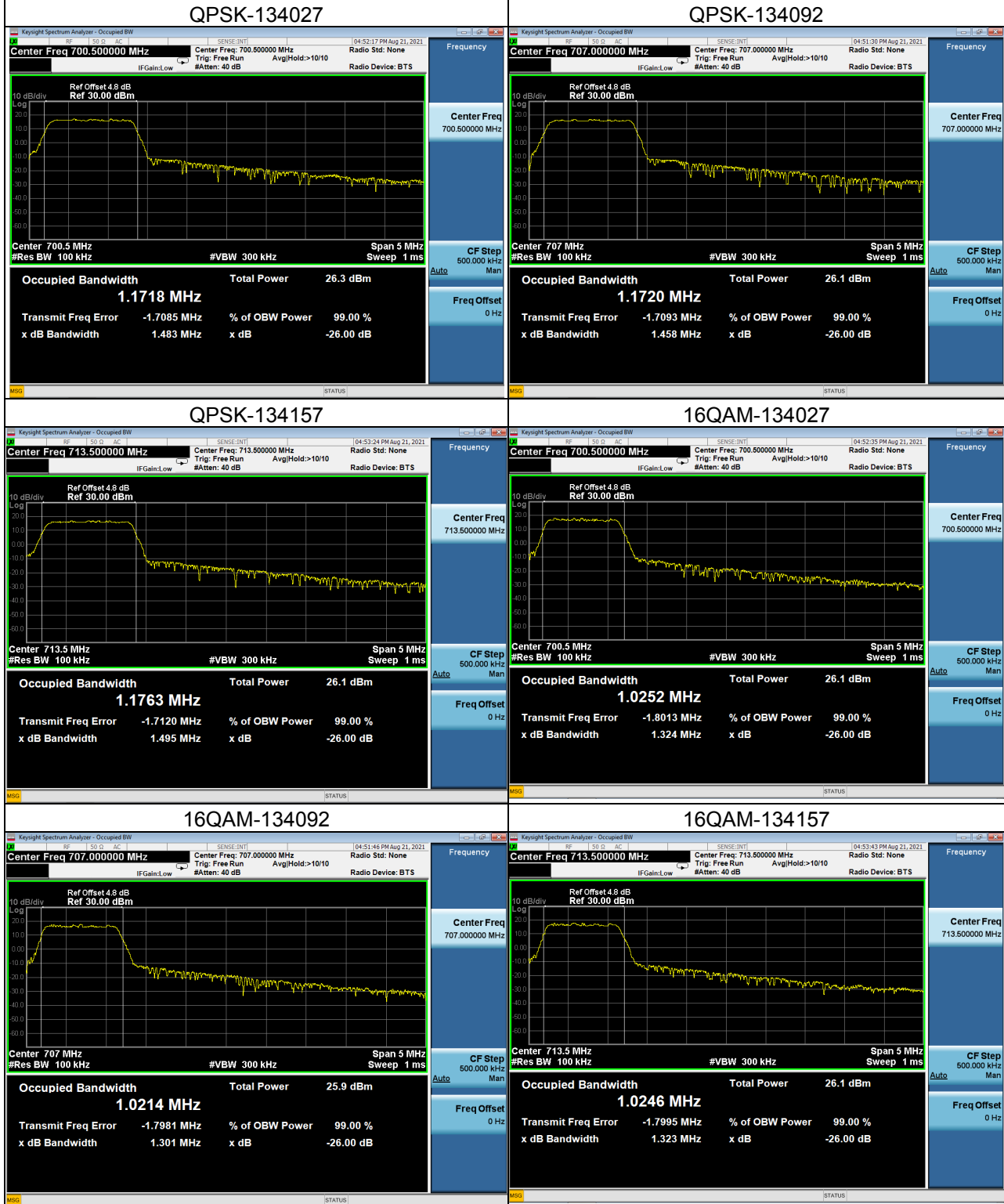



LTE Band 85_10M					
QPSK					
Channel	Frequency (MHz)	99% Occupied Bandwidth (MHz)	Channel	Frequency (MHz)	26dB Bandwidth (MHz)
134052	703	1.1706	134052	703	1.555
134092	707	1.3276	134092	707	2.311
134132	711	1.3251	134132	711	2.123
16QAM					
Channel	Frequency (MHz)	99% Occupied Bandwidth (MHz)	Channel	Frequency (MHz)	26dB Bandwidth (MHz)
134052	703	1.1703	134052	703	1.566
134092	707	1.1767	134092	707	1.608
134132	711	1.1723	134132	711	1.601

## Spectrum Plot

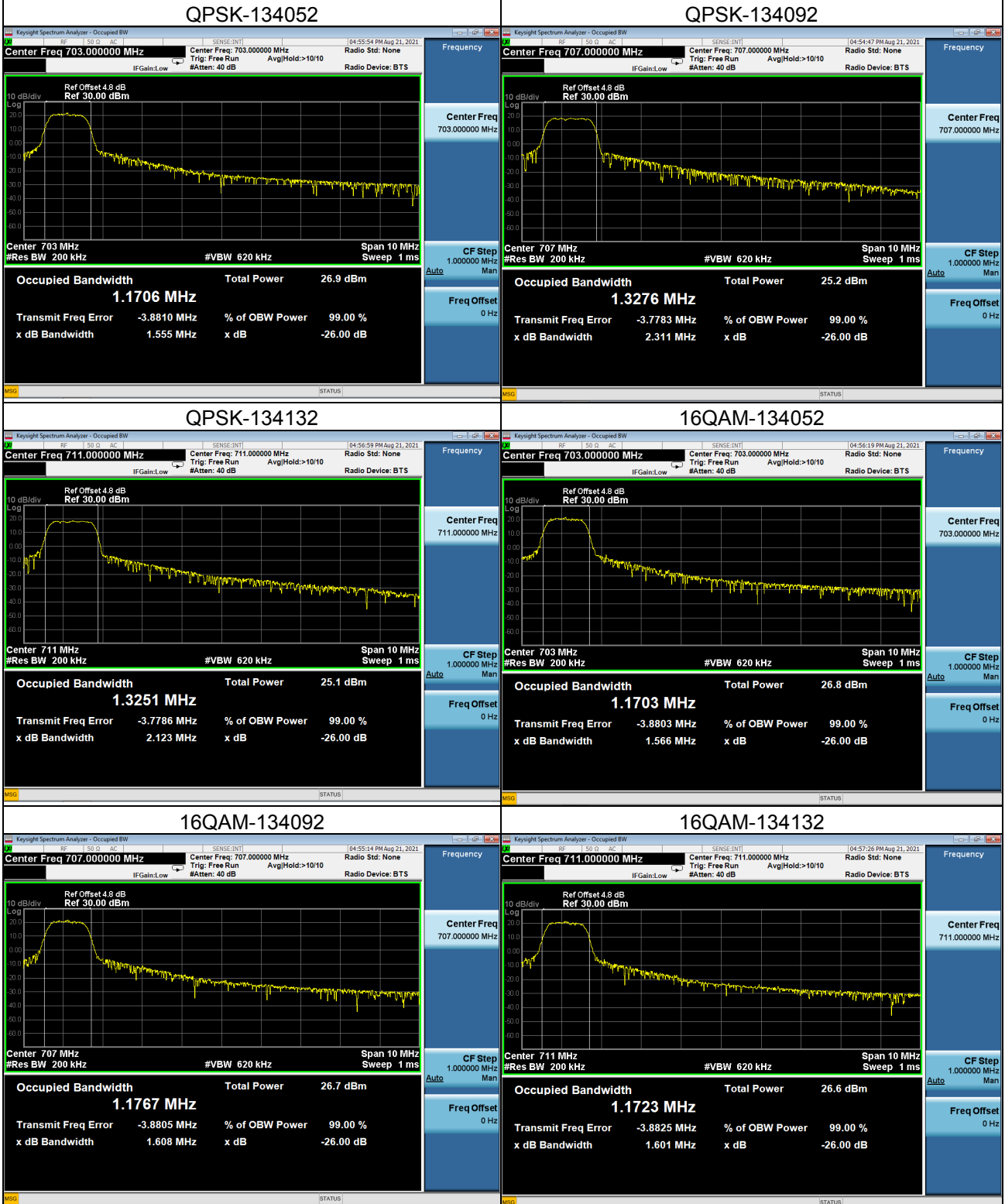

## **APPENDIX C - CONDUCTED SPURIOUS EMISSIONS**

