

FCC Radio Test Report

FCC ID: 2AH4HATD600

This report concerns: Original Grant

Project No. : 2107C193
Equipment : LTE Cat-M1 Tracker
Brand Name : Mobilogix
Test Model : ATD600S
Series Model : N/A
Applicant : Mobilogix, Inc.
Address : 5500 Trabuco Rd Suite 150 Irvine, CA, USA
Manufacturer : Mobilogix, Inc.
Address : 5500 Trabuco Rd Suite 150 Irvine, CA, USA
Factory : Suga Electronics (Dongguan) Co., Ltd.
Address : No.8 Fulong Road, Qingxi Town, Dongguan City
Date of Receipt : Jul. 29, 2021
Date of Test : Jul. 30, 2021 ~ Sep. 10, 2021
Issued Date : Sep. 18, 2021
Report Version : R00
Test Sample : Engineering Sample No.: DG2021081225 for radiated, DG2021081224 for conducted.
Standard(s) : 47 CFR FCC Part 27 Subpart L
47 CFR FCC Part 27 Subpart M
47 CFR FCC Part 27 Subpart C
47 CFR FCC Part 2
ANSI/TIA/EIA-603-E-2016
FCC KDB 971168 D01 Power Meas License Digital Systems v03r01

The above equipment has been tested and found compliance with the requirement of the relative standards by BTL Inc.

Vegeta Li

Prepared by : Vegeta Li

Steven Lu

Approved by : Steven Lu



TESTING CERT #5123.02

Add: No. 3 Jinshagang 1st Rd. Shixia, Dalang Town, Dongguan City, Guangdong, People's Republic of China

Tel: +86-769-8318-3000

Web: www.newbtl.com

Declaration

BTL represents to the client that testing is done in accordance with standard procedures as applicable and that test instruments used has been calibrated with standards traceable to international standard(s) and/or national standard(s).

BTL's reports apply only to the specific samples tested under conditions. It is manufacture's responsibility to ensure that additional production units of this model are manufactured with the identical electrical and mechanical components. **BTL** shall have no liability for any declarations, inferences or generalizations drawn by the client or others from **BTL** issued reports.

The report must not be used by the client to claim product certification, approval, or endorsement by NIST, A2LA, or any agency of the U.S. Government.

This report is the confidential property of the client. As a mutual protection to the clients, the public and ourselves, the test report shall not be reproduced, except in full, without our written approval.

BTL's laboratory quality assurance procedures are in compliance with the **ISO/IEC 17025** requirements, and accredited by the conformity assessment authorities listed in this test report.

BTL is not responsible for the sampling stage, so the results only apply to the sample as received.

The information, data and test plan are provided by manufacturer which may affect the validity of results, so it is manufacturer's responsibility to ensure that the apparatus meets the essential requirements of applied standards and in all the possible configurations as representative of its intended use.

Limitation

For the use of the authority's logo is limited unless the Test Standard(s)/Scope(s)/Item(s) mentioned in this test report is (are) included in the conformity assessment authorities acceptance respective.

Please note that the measurement uncertainty is provided for informational purpose only and is not use in determining the Pass/Fail results.

Table of Contents	Page
REPORT ISSUED HISTORY	5
1 . SUMMARY OF TEST RESULTS	6
1.1 TEST FACILITY	7
1.2 MEASUREMENT UNCERTAINTY	7
1.3 TEST ENVIRONMENT CONDITIONS	7
2 . GENERAL INFORMATION	8
2.1 GENERAL DESCRIPTION OF EUT	8
2.2 DESCRIPTION OF TEST MODES	9
2.3 BLOCK DIGRAM SHOWING THECONFIGURATIONOFSYSTEMTESTED	12
2.4 DESCRIPTION OF SUPPORT UNITS	12
3 . TEST RESULT	13
3.1 OUTPUT POWER MEASUREMENT	13
3.1.1 LIMIT	13
3.1.2 TEST PROCEDURE	13
3.1.3 TEST SETUP LAYOUT	13
3.1.4 TEST DEVIATION	13
3.1.5 TEST RESULTS	13
3.2 OCCUPIED BANDWIDTH MEASUREMENT	14
3.2.1 TEST PROCEDURE	14
3.2.2 TEST SETUP LAYOUT	14
3.2.3 TEST DEVIATION	14
3.2.4 TEST RESULTS	14
3.3 CONDUCTED SPURIOUS EMISSIONS MEASUREMENT	15
3.3.1 LIMIT	15
3.3.2 TEST PROCEDURES	15
3.3.3 TEST SETUP LAYOUT	15
3.3.4 TEST DEVIATION	15
3.3.5 TEST RESULTS	15
3.4 RADIATED SPURIOUS EMISSIONS MEASUREMENT	16
3.4.1 LIMIT	16
3.4.2 TEST PROCEDURES	16
3.4.3 TEST SETUP LAYOUT	17
3.4.4 TEST RESULTS (9KHZ TO 30MHZ)	18
3.4.5 TEST RESULTS (30MHZ TO 1000MHZ)	18
3.4.6 TEST RESULTS (ABOVE 1000MHZ)	18
3.5 BAND EDGE MEASUREMENT	19
3.5.1 LIMIT	19
3.5.2 TEST PROCEDURES	19
3.5.3 TEST SETUP LAYOUT	19

Table of Contents	Page
3.5.4 TEST DEVIATION	19
3.5.5 TEST RESULTS	19
3.6 PEAK TO AVERAGE RATIO MEASUREMENT	20
3.6.1 LIMIT	20
3.6.2 TEST PROCEDURES	20
3.6.3 TEST SETUP LAYOUT	20
3.6.4 TEST DEVIATION	20
3.6.5 TEST RESULTS	20
3.7 FREQUENCY STABILITY MEASUREMENT	21
3.7.1 LIMIT	21
3.7.2 TEST PROCEDURES	21
3.7.3 TEST SETUP LAYOUT	21
3.7.4 TEST DEVIATION	21
3.7.5 TEST RESULTS	21
4. LIST OF MEASUREMENT EQUIPMENTS	22
APPENDIX A - OUTPUT POWER	24
APPENDIX B - OCCUPIED BANDWIDTH	29
APPENDIX C - CONDUCTED SPURIOUS EMISSIONS	60
APPENDIX D - RADIATED SPURIOUS EMISSIONS (9KHZ TO 30MHZ)	85
APPENDIX E - RADIATED SPURIOUS EMISSIONS (30MHZ TO 1GHZ)	90
APPENDIX F - RADIATED SPURIOUS EMISSIONS (ABOVE 1GHZ)	139
APPENDIX G - BAND EDGE	188
APPENDIX H - PEAK TO AVERAGE RATIO	207
APPENDIX I - FREQUENCY STABILITY	220

REPORT ISSUED HISTORY

Report Version	Description	Issued Date
R00	Original Issue.	Sep. 18, 2021

1. SUMMARY OF TEST RESULTS

Test procedures according to the technical standard(s):

FCC Part 27 Subpart L, M, C & Part 2			
Standard(s) Section	Test Item	Judgment	Remark
2.1046	Output Power	PASS	-----
27.50(d)(4) 27.50(c)(10) 27.50(h)(2)	Equivalent Isotropic Radiated Power & Equivalent Radiated Power	PASS	-----
2.1049	Occupied Bandwidth	PASS	-----
2.1051 27.53(h) 27.53(m)(4)	Conducted Spurious Emissions	PASS	-----
2.1053 27.53(h) 27.53(m)(4)	Radiated Spurious Emissions	PASS	-----
2.1051 27.53(h) 27.53(m)(4)	Band Edge Measurements	PASS	-----
-	Peak To Average Ratio	PASS	Record Only
2.1055 27.54	Frequency Stability	PASS	-----

Note:

(1) "N/A" denotes test is not applicable in this test report.

1.1 TEST FACILITY

The test facilities used to collect the test data in this report is at the location of No. 3 Jinshagang 1st Rd. Shixia, Dalang Town, Dongguan City, Guangdong, People's Republic of China.
 BTL's Test Firm Registration Number for FCC: 357015
 BTL's Designation Number for FCC: CN1240

1.2 MEASUREMENT UNCERTAINTY

The measurement uncertainty figures shall be calculated according the methods described in the ETSI TR 100 028 and shall correspond to an expansion factor (coverage factor) $k=1.96$ or $k=2$ (which provide confidence levels of respectively 90% and 95.45% in the case where the distributions characterizing the actual measurement uncertainties are normal (Gaussian)).
 Measurement Uncertainty for a Level of Confidence of 95 %, $U=2xUc(y)$.

The BTL measurement uncertainty as below table:

A. Radiated Measurement :

Test Site	Method	Measurement Frequency Range	Ant. H / V	U, (dB)
DG-CB03	CISPR	9kHz ~ 30MHz	-	2.36
		30MHz ~ 200MHz	V	4.36
		30MHz ~ 200MHz	H	3.32
		200MHz ~ 1,000MHz	V	4.08
		200MHz ~ 1,000MHz	H	3.96
		1GHz ~ 6GHz	-	3.80
		6GHz ~ 18GHz	-	4.82

B. Other Measurement:

Parameter	Uncertainty
Spectrum Bandwidth	±3.8 %
Maximum Output Power	±0.95 dB
Power Spectral Density	±0.86 dB
Frequency Stability	±0.16 dB
Temperature	±0.08 °C
Time	±0.58 %
Supply voltages	±0.3 %

Note: Unless specifically mentioned, the uncertainty of measurement has not been taken into account to declare the compliance or non-compliance to the specification.

1.3 TEST ENVIRONMENT CONDITIONS

Test Item	Temperature	Humidity	Test Voltage	Tested By
Output Power & ERP	23.5°C	43%	DC 3.6 V	Tate Liu
Occupied Bandwidth	23.5°C	43%	DC 3.6 V	Tate Liu
Conducted Spurious Emissions	23.5°C	43%	DC 3.6 V	Tim Yang
Radiated Spurious Emissions	26°C	52%	DC 3.6 V	Kwok Guo
Band Edge	23.5°C	43%	DC 3.6 V	Tate Liu
Peak to Average Ratio	23.5°C	43%	DC 3.6 V	Tate Liu
Frequency Stability	Normal & Extreme	43%	Normal & Extreme	Tate Liu

2. GENERAL INFORMATION

2.1 GENERAL DESCRIPTION OF EUT

Equipment	LTE Cat-M1 Tracker			
Brand Name	Mobilogix			
Test Model	ATD600S			
Series Model	N/A			
Model Difference(s)	N/A			
Hardware Version	1.1			
Software Version	1.1.45			
Power Source	Supplied from battery.			
Power Rating	DC 3.6V			
IEMI No.	Conducted	867730051961021		
	Radiated	867730051961708		
Category	NB2			
Sub-carrier Spacing	3.75KHz, 15KHz			
Modulation Type	UL: BPSK, QPSK DL: BPSK, QPSK			
Max. EIRP	LTE Band 4	Sub-carrier Spacing (kHz)	BPSK (dBm)	QPSK (dBm)
		3.75	23.36	23.38
	Band 66	15	23.28	23.49
		3.75	23.43	23.37
	Band 12	15	23.36	23.53
		3.75	19.95	20.01
Max. ERP	Band 13	15	20.20	20.33
		3.75	19.53	19.60
	Band 71	15	19.61	19.80
		3.75	22.82	22.86
	Band 85	15	23.35	23.48
		3.75	22.27	22.38
	Band 85	15	22.60	22.73

Note:

- For a more detailed features description, please refer to the manufacturer's specifications or the user's manual.
- Table for Filed Antenna:

Brand	P/N	Antenna Type	Connector	Gain (dBi)	Note
Ethertronics	1004795	Chip	N/A	3.1	LTE Band 4
Ethertronics	1004795	Chip	N/A	1.6	LTE Band 12
Ethertronics	1004795	Chip	N/A	1.6	LTE Band 13
Ethertronics	1004795	Chip	N/A	3.1	LTE Band 66
Ethertronics	1004795	Chip	N/A	1.6	LTE Band 71
Ethertronics	1004795	Chip	N/A	1.6	LTE Band 85

Note: The antenna gain is provided by the manufacturer.

2.2 DESCRIPTION OF TEST MODES

Following mode(s) is (were) found to be the worst case(s) and selected for the final test.

LTE Band 4 MODE				
Test Item	Tested Channel	Sub-carrier Spacing(kHz)	Modulation	Mode
Output Power & EIRP	19951, 20175, 20399	3.75	BPSK, QPSK	1RB
		15		
Occupied Bandwidth	19951, 20175, 20399	3.75	BPSK, QPSK	1RB
		15		1RB/12RB
Conducted Spurious Emissions	20175	3.75	BPSK, QPSK	1RB
		15		
Radiated Spurious Emissions	20175	3.75	BPSK, QPSK	1RB
		15		
Band Edge	19952, 20398	3.75	BPSK, QPSK	1RB
		15		1RB/12RB
Peak To Average Ratio	19951, 20175, 20399	3.75	BPSK, QPSK	1RB
		15		
Frequency Stability	20175	3.75	BPSK, QPSK	1RB
		15		

LTE Band 12 MODE				
Test Item	Tested Channel	Sub-carrier Spacing(kHz)	Modulation	Mode
Output Power & ERP	23011, 23095, 23179	3.75	BPSK, QPSK	1RB
		15		
Occupied Bandwidth	23011, 23095, 23179	3.75	BPSK, QPSK	1RB
		15		1RB/12RB
Conducted Spurious Emissions	23095	3.75	BPSK, QPSK	1RB
		15		
Radiated Spurious Emissions	23095	3.75	BPSK, QPSK	1RB
		15		
Band Edge	23012, 23178	3.75	BPSK, QPSK	1RB
		15		1RB/12RB
Peak To Average Ratio	23011, 23095, 23179	3.75	BPSK, QPSK	1RB
		15		
Frequency Stability	23095	3.75	BPSK, QPSK	1RB
		15		

LTE Band 13 MODE				
Test Item	Tested Channel	Sub-carrier Spacing(kHz)	Modulation	Mode
Output Power & ERP	23181, 23230, 23279	3.75	BPSK, QPSK	1RB
		15		
Occupied Bandwidth	23181, 23230, 23279	3.75	BPSK, QPSK	1RB
		15		1RB/12RB
Conducted Spurious Emissions	23230	3.75	BPSK, QPSK	1RB
		15		
Radiated Spurious Emissions	23230	3.75	BPSK, QPSK	1RB
		15		
Band Edge	23182, 23278	3.75	BPSK, QPSK	1RB
		15		1RB/12RB
Peak To Average Ratio	23181, 23230, 23279	3.75	BPSK, QPSK	1RB
		15		
Frequency Stability	20925	3.75	BPSK, QPSK	1RB
		15		

LTE Band 66 MODE				
Test Item	Tested Channel	Sub-carrier Spacing(kHz)	Modulation	Mode
Output Power & EIRP	131974, 132322, 132670	3.75	BPSK, QPSK	1RB
		15		
Occupied Bandwidth	131974, 132322, 132670	3.75	BPSK, QPSK	1RB
		15		1RB/12RB
Conducted Spurious Emissions	132322	3.75	BPSK, QPSK	1RB
		15		
Radiated Spurious Emissions	132322	3.75	BPSK, QPSK	1RB
		15		
Band Edge	131974, 132670	3.75	BPSK, QPSK	1RB
		15		1RB/12RB
Peak To Average Ratio	131974, 132322, 132670	3.75	BPSK, QPSK	1RB
		15		
Frequency Stability	132322	3.75	BPSK, QPSK	1RB
		15		

LTE Band 71 MODE				
Test Item	Tested Channel	Sub-carrier Spacing(kHz)	Modulation	Mode
Output Power & ERP	133124, 133297, 133470	3.75	BPSK, QPSK	1RB
		15		
Occupied Bandwidth	133124, 133297, 133470	3.75	BPSK, QPSK	1RB
		15		1RB/12RB
Conducted Spurious Emissions	133297	3.75	BPSK, QPSK	1RB
		15		
Radiated Spurious Emissions	133297	3.75	BPSK, QPSK	1RB
		15		
Band Edge	133124, 133470	3.75	BPSK, QPSK	1RB
		15		1RB/12RB
Peak To Average Ratio	133124, 133297, 133470	3.75	BPSK, QPSK	1RB
		15		
Frequency Stability	133297	3.75	BPSK, QPSK	1RB
		15		

LTE Band 85 MODE				
Test Item	Tested Channel	Sub-carrier Spacing(kHz)	Modulation	Mode
Output Power & ERP	134004, 134092, 134180	3.75	BPSK, QPSK	1RB
		15		
Occupied Bandwidth	134004, 134092, 134180	3.75	BPSK, QPSK	1RB
		15		1RB/12RB
Conducted Spurious Emissions	134092	3.75	BPSK, QPSK	1RB
		15		
Radiated Spurious Emissions	134092	3.75	BPSK, QPSK	1RB
		15		
Band Edge	134004, 134180	3.75	BPSK, QPSK	1RB
		15		1RB/12RB
Peak To Average Ratio	134004, 134092, 134180	3.75	BPSK, QPSK	1RB
		15		
Frequency Stability	134092	3.75	BPSK, QPSK	1RB
		15		

2.3 BLOCK DIGRAM SHOWING THE CONFIGURATION OF SYSTEM TESTED**2.4 DESCRIPTION OF SUPPORT UNITS**

The EUT has been tested as an independent unit together with other necessary accessories or support units. The following support units or accessories were used to form a representative test configuration during the tests.

Item	Equipment	Brand	Model No.	Series No.
-	-	-	-	-

Item	Cable Type	Shielded Type	Ferrite Core	Length
-	-	-	-	-

3. TEST RESULT

3.1 OUTPUT POWER MEASUREMENT

3.1.1 LIMIT

Mobile / Portable station are limited to 1 watts e.i.r.p. (Part 27 Subpart L)

Mobile / Portable station are limited to 2 watts e.i.r.p. (Part 27 Subpart M)

Mobile / Portable station are limited to 3 watts e.r.p (Part 27 Subpart C)

3.1.2 TEST PROCEDURE

The testing follows FCC KDB 971168 v03r01 Section 5.

EIRP:

$EIRP = \text{Output Power} + \text{Antenan gain}$

ERP:

$ERP = EIRP - 2.15$

Output Power:

The EUT was set up for the maximum power with WCDMA and LTE link data modulation and link up with simulator. Set the EUT to transmit under low, middle and high channel and record the power level shown on simulator.

3.1.3 TEST SETUP LAYOUT

Output Power Measurement

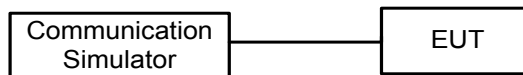

3.1.4 TEST DEVIATION

No deviation

3.1.5 TEST RESULTS

Please refer to the APPENDIX A.

3.2 OCCUPIED BANDWIDTH MEASUREMENT

3.2.1 TEST PROCEDURE

The testing follows FCC KDB 971168 v03r01 Section 4.

1. The EUT makes a call to the communication simulator. All measurements were done at low, middle and high operational frequency range. The communication simulator station system controlled a EUT to export maximum output power under transmission mode and specific channel frequency. Use OBW measurement function of Spectrum analyzer to measure 99 % occupied bandwidth and 26dB bandwidth.
2. The EUT was connected to spectrum analyzer and system simulator via a power divider.
3. $RBW=(1\% \sim 5\%)*EBW$
 $VBW \geq 3* RBW$
4. Set spectrum analyzer with Peak detector.

3.2.2 TEST SETUP LAYOUT

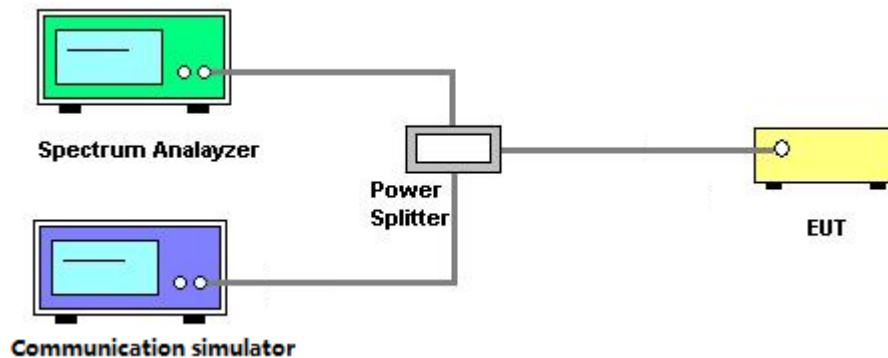

3.2.3 TEST DEVIATION

No deviation

3.2.4 TEST RESULTS

Please refer to the APPENDIX B.

3.3 CONDUCTED SPURIOUS EMISSIONS MEASUREMENT

3.3.1 LIMIT

The power of any emission outside of the authorized operating frequency ranges must be attenuated below the transmitting power (P) by a factor of at least $43 + 10 \log(P)$ dB. The emission limit equal to -13dBm. (Part 27 Subpart L)

The power of any emission outside of the authorized operating frequency ranges must be attenuated below the transmitting power (P) by a factor of at least $55 + 10 \log(P)$ dB. The emission limit equal to -25dBm. (Part 27 Subpart M)

3.3.2 TEST PROCEDURES

The testing follows FCC KDB 971168 v03r01 Section 6.

1. The EUT was connected to spectrum analyzer and system simulator via a power divider.
2. The band edges of low and high channels for the highest RF powers were measured. Set RBW \geq 1% EBW in the 1MHz band immediately outside and adjacent to the band edge.
3. Set spectrum analyzer with Peak detector.
4. The RF fundamental frequency should be excluded against the limit line in the operating frequency band.

3.3.3 TEST SETUP LAYOUT

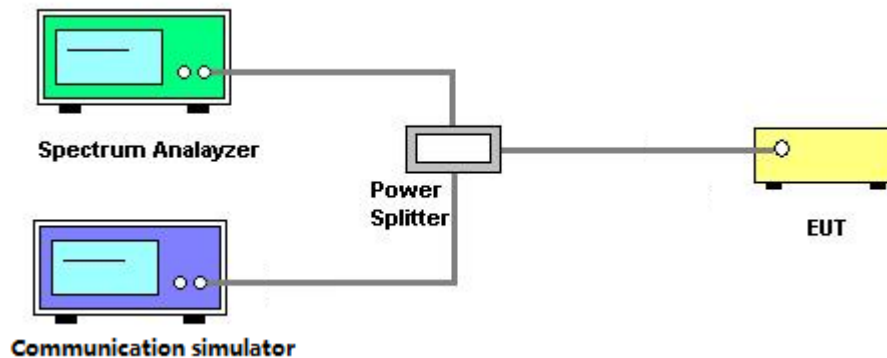

3.3.4 TEST DEVIATION

No deviation

3.3.5 TEST RESULTS

Please refer to the APPENDIX C.

3.4 RADIATED SPURIOUS EMISSIONS MEASUREMENT

3.4.1 LIMIT

The power of any emission outside of the authorized operating frequency ranges must be attenuated below the transmitting power (P) by a factor of at least $43 + 10 \log(P)$ dB. The emission limit equal to -13dBm. (Part 27 Subpart L)

The power of any emission outside of the authorized operating frequency ranges must be attenuated below the transmitting power (P) by a factor of at least $55 + 10 \log(P)$ dB. The emission limit equal to -25dBm. (Part 27 Subpart M)

3.4.2 TEST PROCEDURES

The testing follows FCC KDB 971168 v03r01 Section 6.2.

1. In the semi-anechoic chamber, EUT placed on the 0.8m height of Turn Table, rotated the table around 360 degrees to search the maximum radiation power and receiver antenna shall be rotated vertical and horizontal polarization and moved height from 1m to 4m to find the maximum polar radiated power. The "Read Value" is the spectrum reading the maximum power value.
2. The substitution horn antenna is substituted for EUT at the same position and signals generator export the CW signal to the substitution antenna via a TX cable. Rotated the Turn Table and moved receiving antenna to find the maximum radiation power. Adjust output power level of S.G to get a Value of spectrum reading equal to "Read Value " of step a. Record the power level of S.G
3. $EIRP = \text{Output power level of S.G} - \text{TX cable loss} + \text{Antenna gain of substitution horn.}$
4. ERP can be calculated form EIRP by subtracting the gain of dipole, $ERP = EIPR - 2.15\text{dBi.}$
5. The resolution bandwidth and video bandwidth of test receiver/spectrum analyzer is 1MHz/3MHz.

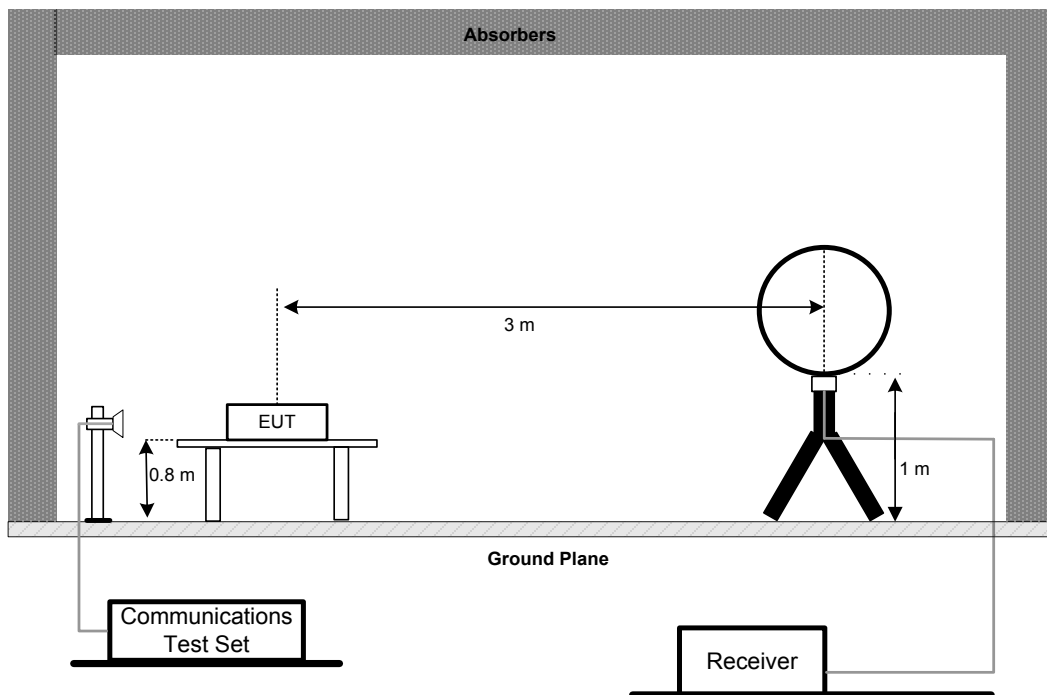
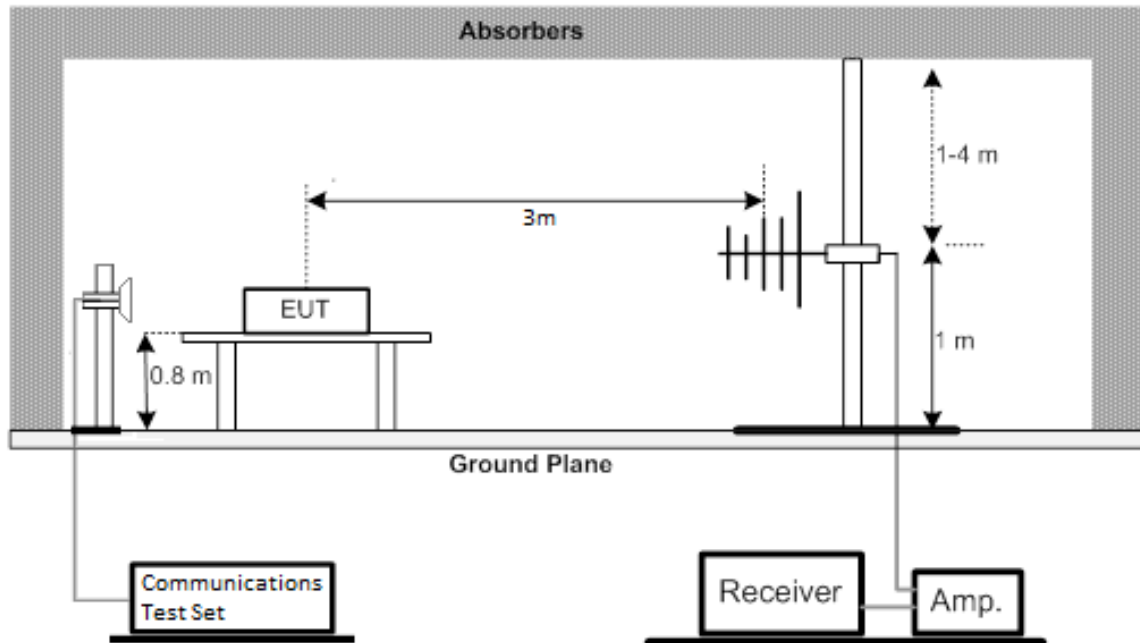
3.4.3 TEST SETUP LAYOUT**Below 30MHz****30MHz to 1GHz**

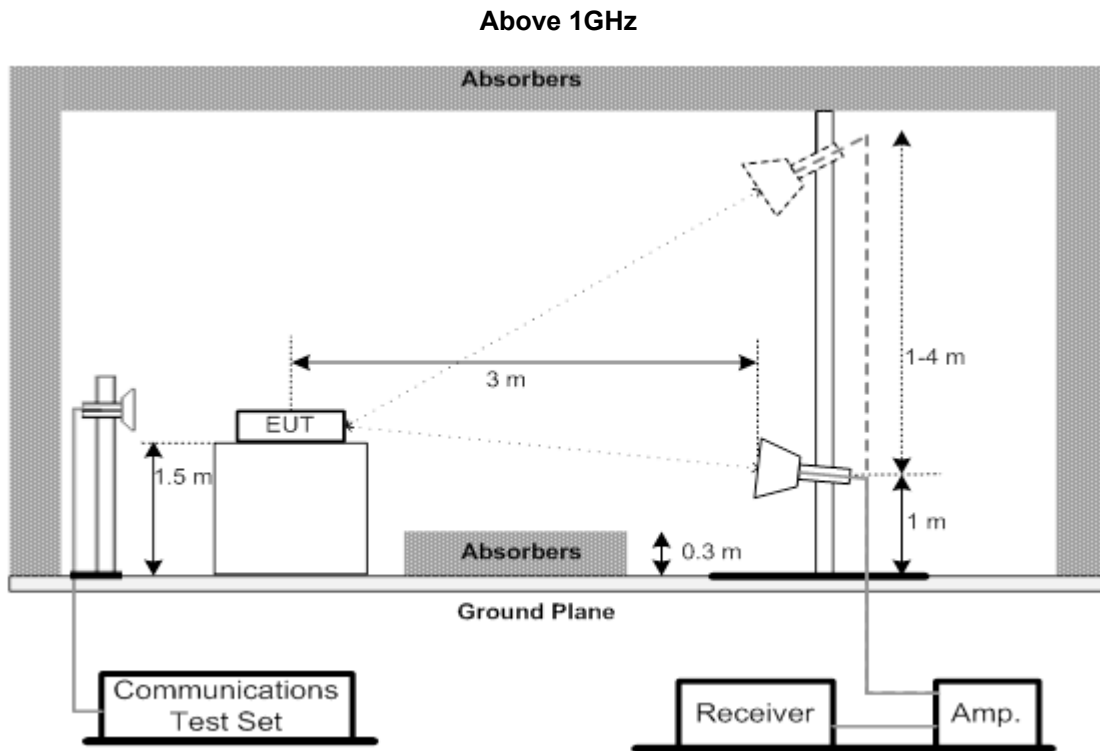

3.4.4 TEST RESULTS (9KHZ TO 30MHZ)

Please refer to the APPENDIX D.

3.4.5 TEST RESULTS (30MHZ TO 1000MHZ)

Please refer to the APPENDIX E.

3.4.6 TEST RESULTS (ABOVE 1000MHZ)

Please refer to the APPENDIX F.

3.5 BAND EDGE MEASUREMENT

3.5.1 LIMIT

The power of any emission outside a licensee's frequency band(s) of operation shall be attenuated below the transmitter power (P) within the licensed band(s) of operation, measured in watts, by at least $43 + 10 \log (P)$ dB. Compliance with this provision is based on the use of measurement instrumentation employing a resolution bandwidth of 100 kilohertz or greater. However, in the 100 kilohertz bands immediately outside and adjacent to a licensee's frequency block, a resolution bandwidth of at least 30 kHz may be employed. (Part 27 Subpart L)

For mobile digital stations, the attenuation factor shall be not less than $40 + 10 \log (P)$ dB on all frequencies between the channel edge and 5 megahertz from the channel edge, $43 + 10 \log (P)$ dB on all frequencies between 5 megahertz and X megahertz from the channel edge, and $55 + 10 \log (P)$ dB on all frequencies more than X megahertz from the channel edge, where X is the greater of 6 megahertz or the actual emission bandwidth as defined in paragraph (m)(6) of this section. In addition, the attenuation factor shall not be less than $43 + 10 \log (P)$ dB on all frequencies between 2490.5 MHz and 2496 MHz and $55 + 10 \log (P)$ dB at or below 2490.5 MHz. Mobile Satellite Service licensees operating on frequencies below 2495 MHz may also submit a documented interference complaint against BRS licensees operating on channel BRS Channel 1 on the same terms and conditions as adjacent channel BRS or EBS licensees. (Part 27 Subpart M)

3.5.2 TEST PROCEDURES

The testing follows FCC KDB 971168 v03r01 Section 6.

1. All measurements were done at low and high operational frequency range.
2. Record the max trace plot into the test report.

3.5.3 TEST SETUP LAYOUT

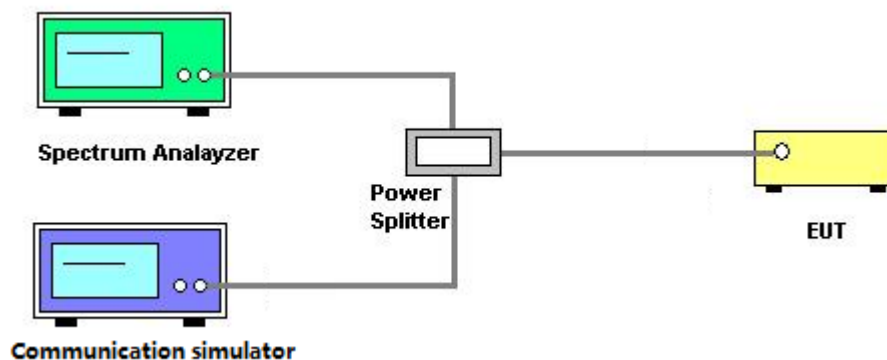

3.5.4 TEST DEVIATION

No deviation

3.5.5 TEST RESULTS

Please refer to the APPENDIX G.

3.6 PEAK TO AVERAGE RATIO MEASUREMENT

3.6.1 LIMIT

In measuring transmissions in this band using an average power technique, the peak to-average ratio (PAR) of the transmission may not exceed 13 dB.

3.6.2 TEST PROCEDURES

The testing follows FCC KDB 971168 v03r01 Section 5.7.

1. Set resolution/measurement bandwidth \geq signal's occupied bandwidth;
2. Set the number of counts to a value that stabilizes the measured CCDF curve;
3. Record the maximum PAPR level associated with a probability of 0.1%.

3.6.3 TEST SETUP LAYOUT

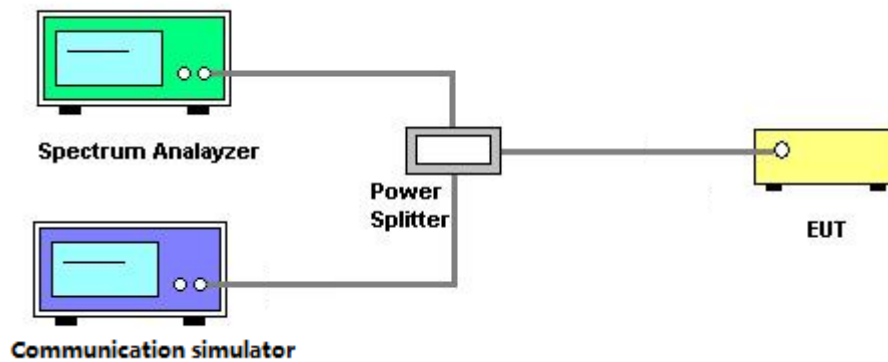

3.6.4 TEST DEVIATION

No deviation

3.6.5 TEST RESULTS

Please refer to the APPENDIX H.

3.7 FREQUENCY STABILITY MEASUREMENT

3.7.1 LIMIT

± 1.5 ppm is for base and fixed station. ± 2.5 ppm is for mobile station.

3.7.2 TEST PROCEDURES

The testing follows FCC KDB 971168 v03r01 Section 9.

1. Device is placed at the oven room. The oven room could control the temperatures and humidity. Power warm up is at least 15 min and power applied should perform before recording frequency error.
2. EUT is connected the external power supply to control the DC input power. The test voltage range is from minimum to maximum working voltage. Each step shall be record the frequency error rate.
3. The temperature range step is 10 degrees in this test items. All temperature levels shall be hold the $\pm 0.5^{\circ}\text{C}$ during the measurement testing. The each temperature step shall be at least 0.5 hours, consider the EUT could be test under the stability condition.
4. The frequency error was recorded frequency error from the communication simulator.

3.7.3 TEST SETUP LAYOUT

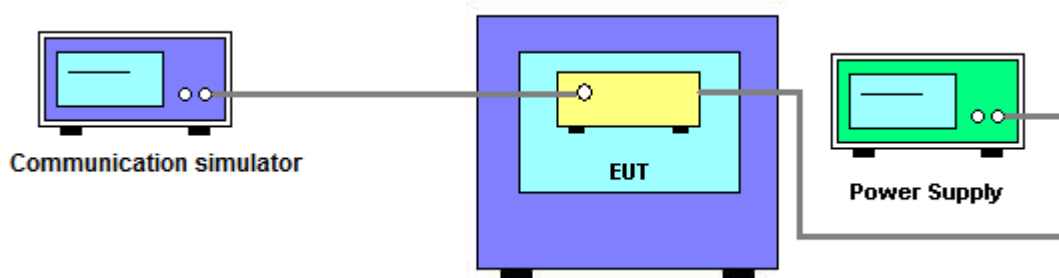

3.7.4 TEST DEVIATION

No deviation

3.7.5 TEST RESULTS

Please refer to the APPENDIX I.

4. LIST OF MEASUREMENT EQUIPMENTS

Radiated Spurious Emission Measurement					
Item	Kind of Equipment	Manufacturer	Type No.	Serial No.	Calibrated until
1	Antenna	Schwarzbeck	VULB9160	9160-3232	Mar. 15, 2022
2	Amplifier	Agilent	8449B	3008A02334	Feb. 27, 2022
3	High Pass Filter	Wairwright Instruments Gmbh	WHK 1.5/15G-10ST	11	Feb. 27, 2022
4	Band Reject Filter	Wairwright Instruments Gmbh	WRCG 1710/1785-1690/1805-60/ 12SS	38	Feb. 27, 2022
5	Band Reject Filter	Wairwright Instruments Gmbh	WRCG 824/849-810/863-60/9SS	7	Feb. 27, 2022
6	Band Reject Filter	Wairwright Instruments Gmbh	WRCG 880/915-860/935-60/9SS	14	Feb. 27, 2022
7	Band Reject Filter	Wairwright Instruments Gmbh	WRCG 1850/1910-1830/1930-60/ 10SS	17	Feb. 27, 2022
8	High Pass Filter	Wairwright Instruments Gmbh	WHK3.1/18G-10SS	24	Feb. 27, 2022
9	Wireless Communication Test SET	Agilent	E5515C	MY48364183	Feb. 28, 2022
10	Microwave Preamplifier With Adaptor	EMC INSTRUMENT	EMC2654045	980039 & HA01	Feb. 28, 2022
11	Receiver	Agilent	N9038A	MY52130039	Mar. 19, 2022
12	wideband radio communication tester	R&S	CMW500	152372	Feb. 27, 2022
13	High pass filter	KANGMAIWEI	ZHPF-M3-12.75G-3869	B2015073763	Feb. 07, 2022
14	High pass filter	KANGMAIWEI	ZHPF-M1000-4000-1	B2015073762	Feb. 07, 2022
15	High pass filter	KANGMAIWEI	ZHPF-M6-186-1727	B2015073764	Feb. 07, 2022
16	Cable	emci	LMR-400(30MHz-1GHz) (8m+5m)	N/A	May 20, 2022
17	Cable	mitron	RWLP50-4.0A-KJ-SMSM- 12M	N/A	Nov. 23, 2021
18	Controller	ETS-Lindgren	2090	N/A	N/A
19	Measurement Software	Farad	EZ-EMC Ver.NB-03A1-01	N/A	N/A
20	Loop Antenna	EM	EM-6876-1	230	Apr. 28, 2022
21	Double Ridged Guide Antenna	ETS	3115	75846	Mar. 17, 2022
22	Broad-Band Horn Antenna	Schwarzbeck	BBHA 9170	9170319	Jun. 30, 2022

Conducted Measurement					
Item	Kind of Equipment	Manufacturer	Type No.	Serial No.	Calibrated until
1	Wireless Communication Test SET	Agilent	E5515C	MY48364183	Feb. 28, 2022
2	EXA Spectrum Analyzer	Agilent	N9010A	MY50520044	Feb. 28, 2022
3	POWER SPLITTER	Mini-Circuits	ZFRSC-123-S+	331000910-1	Feb. 27, 2022
4	wideband radio communication tester	R&S	CMW500	152372	Feb. 27, 2022

Frequency Stability Measurement					
Item	Kind of Equipment	Manufacturer	Type No.	Serial No.	Calibrated until
1	Wireless Communication Test SET	Agilent	E5515C	MY48364183	Feb. 28, 2022
2*	Multi-output DC Power Supply	GW Instek	GPC-3030DN	EK880675	Jul. 25, 2023
3	POWER SPLITTER	Mini-Circuits	ZFRSC-123-S+	331000910-1	Feb. 27, 2022
4	wideband radio communication tester	R&S	CMW500	152372	Feb. 27, 2022
5	Const Temp, & Humidity Chamber	Bell	BTH-50C	20170306001	Feb. 27, 2022

Remark: "N/A" denotes no model name, serial no. or calibration specified.

"*" calibration period of equipment list is three year.

Except * item, all calibration period of equipment list is one year.

APPENDIX A - OUTPUT POWER

Output Power (dBm):

LTE Band	Sub-carrier Spacing (kHz)	Modulation	N _{tones}	Tone offset	Low CH	Mid CH	High CH
					CH19951	CH20175	CH20399
					1710.1MHz	1732.5MHz	1754.9MHz
4	3.75	BPSK	1	0	20.22	20.02	19.87
			1	47	20.26	19.97	19.88
		QPSK	1	0	20.28	20.07	19.95
			1	47	20.21	19.99	19.83
	15	BPSK	1	0	20.18	19.10	19.72
			1	11	20.15	19.00	19.60
		QPSK	1	0	20.39	19.16	19.85
			1	11	20.31	19.10	19.79

LTE Band	Sub-carrier Spacing (kHz)	Modulation	N _{tones}	Tone offset	Low CH	Mid CH	High CH
					CH23011	CH23095	CH23179
					699.1MHz	707.5MHz	715.9MHz
12	3.75	BPSK	1	0	20.50	20.27	20.42
			1	47	20.46	20.20	20.42
		QPSK	1	0	20.56	20.25	20.52
			1	47	20.45	20.21	20.36
	15	BPSK	1	0	20.75	19.98	20.57
			1	11	20.69	19.76	20.49
		QPSK	1	0	20.88	19.98	20.68
			1	11	20.82	19.89	20.63

LTE Band	Sub-carrier Spacing (kHz)	Modulation	N _{tones}	Tone offset	Low CH	Mid CH	High CH
					CH23181	CH23230	CH23279
					777.1MHz	782MHz	786.9MHz
13	3.75	BPSK	1	0	20.07	20.03	20.08
			1	47	20.00	20.03	19.99
		QPSK	1	0	20.15	20.11	20.06
			1	47	20.00	20.03	20.00
	15	BPSK	1	0	20.12	20.04	20.16
			1	11	20.04	19.94	20.09
		QPSK	1	0	20.25	20.19	20.35
			1	11	20.17	20.12	20.30

LTE Band	Sub-carrier Spacing (kHz)	Modulation	N _{tones}	Tone offset	Low CH	Mid CH	High CH
					CH131974	CH132322	CH132670
					1710.2MHz	1745MHz	132670MHz
66	3.75	BPSK	1	0	20.16	20.01	20.33
			1	47	20.12	19.96	20.22
		QPSK	1	0	20.22	20.03	20.27
			1	47	20.15	19.95	20.20
	15	BPSK	1	0	20.26	19.99	19.94
			1	11	20.24	19.93	19.85
		QPSK	1	0	20.43	20.19	20.09
			1	11	20.38	20.12	20.02

LTE Band	Sub-carrier Spacing (kHz)	Modulation	N _{tones}	Tone offset	Low CH	Mid CH	High CH
					CH133124	CH133297	CH133470
					663.2MHz	680.5MHz	697.8MHz
71	3.75	BPSK	1	0	21.22	21.17	21.08
			1	47	21.18	21.15	21.10
		QPSK	1	0	21.26	21.26	21.23
			1	47	21.23	21.20	21.15
	15	BPSK	1	0	21.15	20.36	21.75
			1	11	21.04	20.33	21.66
		QPSK	1	0	21.26	20.47	21.88
			1	11	21.22	20.42	21.84

LTE Band	Sub-carrier Spacing (kHz)	Modulation	N _{tones}	Tone offset	Low CH	Mid CH	High CH
					CH134004	CH134092	CH134180
					698.2MHz	707MHz	715.8MHz
85	3.75	BPSK	1	0	20.67	20.20	20.32
			1	47	20.63	20.12	20.24
		QPSK	1	0	20.78	20.21	20.33
			1	47	20.76	20.11	20.33
	15	BPSK	1	0	21.00	20.35	20.53
			1	11	20.97	20.26	20.44
		QPSK	1	0	21.12	20.49	20.69
			1	11	21.07	20.42	20.58

EIRP (dBm):

LTE Band	Sub-carrier Spacing (kHz)	Modulation	N _{tones}	Tone offset	Low CH	Mid CH	High CH
					CH19951	CH20175	CH20399
					1710.1MHz	1732.5MHz	1754.9MHz
4	3.75	BPSK	1	0	23.32	23.12	22.97
			1	47	23.36	23.07	22.98
		QPSK	1	0	23.38	23.17	23.05
			1	47	23.31	23.09	22.93
	15	BPSK	1	0	23.28	22.20	22.82
			1	11	23.25	22.10	22.70
		QPSK	1	0	23.49	22.26	22.95
			1	11	23.41	22.20	22.89

LTE Band	Sub-carrier Spacing (kHz)	Modulation	N _{tones}	Tone offset	Low CH	Mid CH	High CH
					CH131974	CH132322	CH132670
					1710.2MHz	1745MHz	1779.8MHz
66	3.75	BPSK	1	0	23.26	23.11	23.43
			1	47	23.22	23.06	23.32
		QPSK	1	0	23.32	23.13	23.37
			1	47	23.25	23.05	23.30
	15	BPSK	1	0	23.36	23.09	23.04
			1	11	23.34	23.03	22.95
		QPSK	1	0	23.53	23.29	23.19
			1	11	23.48	23.22	23.12

ERP (dBm):

LTE Band	Sub-carrier Spacing (kHz)	Modulation	N _{tones}	Tone offset	Low CH	Mid CH	High CH
					CH23011	CH23095	CH23179
					699.1MHz	707.5MHz	715.9MHz
12	3.75	BPSK	1	0	19.95	19.72	19.87
			1	47	19.91	19.65	19.87
		QPSK	1	0	20.01	19.70	19.97
			1	47	19.90	19.66	19.81
	15	BPSK	1	0	20.20	19.43	20.02
			1	11	20.14	19.21	19.94
		QPSK	1	0	20.33	19.43	20.13
			1	11	20.27	19.34	20.08

LTE Band	Sub-carrier Spacing (kHz)	Modulation	N _{tones}	Tone offset	Low CH	Mid CH	High CH
					CH23181	CH23230	CH23279
					777.1MHz	782MHz	786.9MHz
13	3.75	BPSK	1	0	19.52	19.48	19.53
			1	47	19.45	19.48	19.44
		QPSK	1	0	19.60	19.56	19.51
			1	47	19.45	19.48	19.45
	15	BPSK	1	0	19.57	19.49	19.61
			1	11	19.49	19.39	19.54
		QPSK	1	0	19.70	19.64	19.80
			1	11	19.62	19.57	19.75

LTE Band	Sub-carrier Spacing (kHz)	Modulation	N _{tones}	Tone offset	Low CH	Mid CH	High CH
					CH133124	CH133297	CH133470
					663.2MHz	680.5MHz	697.8MHz
71	3.75	BPSK	1	0	22.82	22.77	22.68
			1	47	22.78	22.75	22.70
		QPSK	1	0	22.86	22.86	22.83
			1	47	22.83	22.80	22.75
	15	BPSK	1	0	22.75	21.96	23.35
			1	11	22.64	21.93	23.26
		QPSK	1	0	22.86	22.07	23.48
			1	11	22.82	22.02	23.44

LTE Band	Sub-carrier Spacing (kHz)	Modulation	N _{tones}	Tone offset	Low CH	Mid CH	High CH
					CH134004	CH134092	CH134180
					698.2MHz	707MHz	715.8MHz
85	3.75	BPSK	1	0	22.27	21.80	21.92
			1	47	22.23	21.72	21.84
		QPSK	1	0	22.38	21.81	21.93
			1	47	22.36	21.71	21.93
	15	BPSK	1	0	22.60	21.95	22.13
			1	11	22.57	21.86	22.04
		QPSK	1	0	22.72	22.09	22.29
			1	11	22.67	22.02	22.18

APPENDIX B - OCCUPIED BANDWIDTH

LTE Band 4_3.75KHz					
BPSK			1RB#0		
Channel	Frequency (MHz)	99% Occupied Bandwidth (KHz)	Channel	Frequency (MHz)	26dB Bandwidth (KHz)
19951	1710.1	57.725	19951	1710.1	41.09
20175	1732.5	58.479	20175	1732.5	38.32
20399	1754.9	60.367	20399	1754.9	41.14
QPSK			1RB#0		
Channel	Frequency (MHz)	99% Occupied Bandwidth (KHz)	Channel	Frequency (MHz)	26dB Bandwidth (KHz)
19951	1710.1	65.243	19951	1710.1	40.32
20175	1732.5	67.704	20175	1732.5	39.70
20399	1754.9	67.284	20399	1754.9	42.64



LTE Band 4_15KHz					
BPSK			1RB#0		
Channel	Frequency (MHz)	99% Occupied Bandwidth (KHz)	Channel	Frequency (MHz)	26dB Bandwidth (KHz)
19951	1710.1	120.27	19951	1710.1	104.5
20175	1732.5	119.80	20175	1732.5	105.6
20399	1754.9	119.91	20399	1754.9	104.0
QPSK			1RB#0		
Channel	Frequency (MHz)	99% Occupied Bandwidth (KHz)	Channel	Frequency (MHz)	26dB Bandwidth (KHz)
19951	1710.1	122.25	19951	1710.1	116.4
20175	1732.5	124.77	20175	1732.5	116.8
20399	1754.9	123.05	20399	1754.9	129.9
QPSK			12RB#0		
Channel	Frequency (MHz)	99% Occupied Bandwidth (KHz)	Channel	Frequency (MHz)	26dB Bandwidth (KHz)
19951	1710.1	185.63	19951	1710.1	250.3
20175	1732.5	185.10	20175	1732.5	248.3
20399	1754.9	184.65	20399	1754.9	238.3

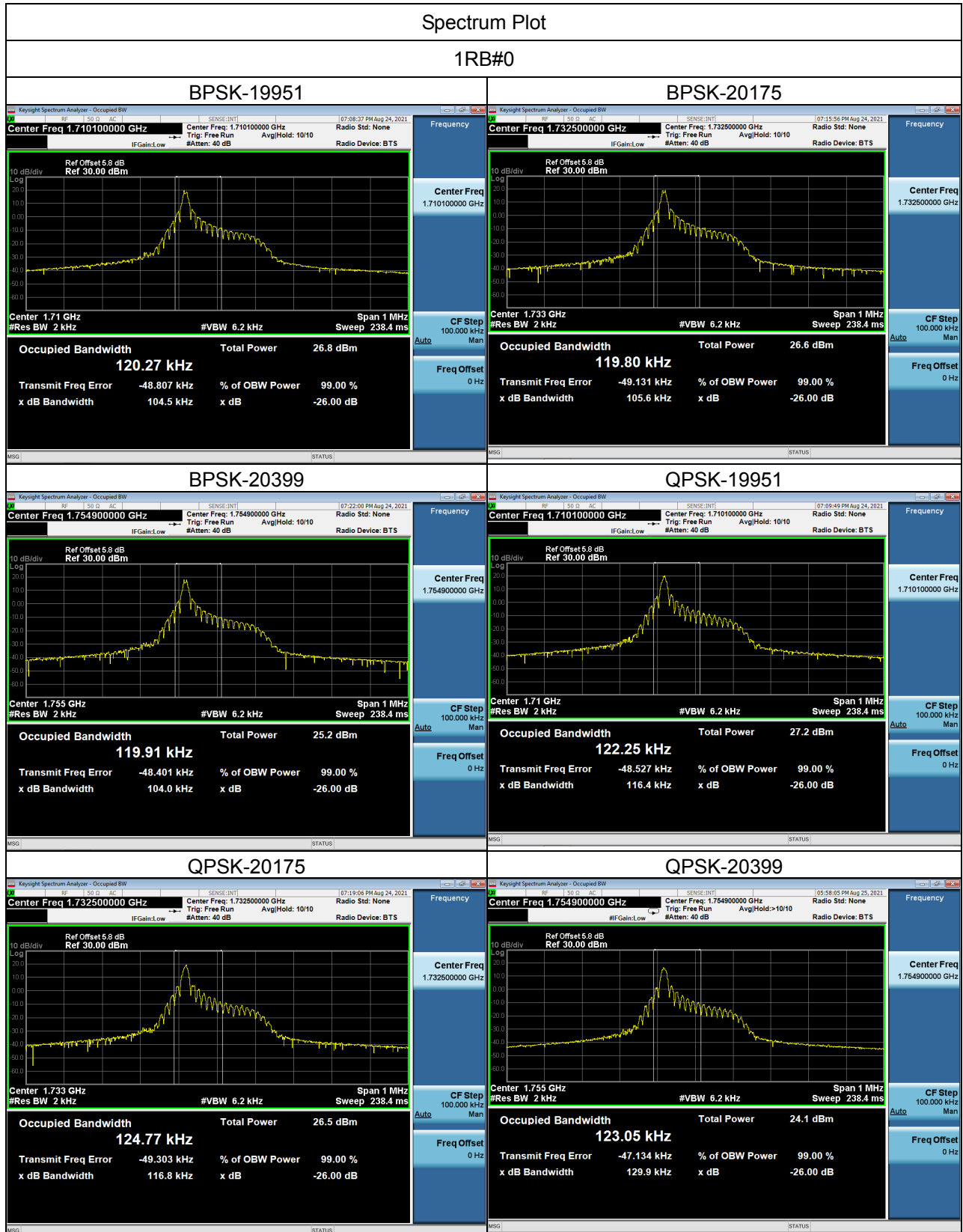

Spectrum Plot

12RB#0

QPSK-19951

QPSK-20175

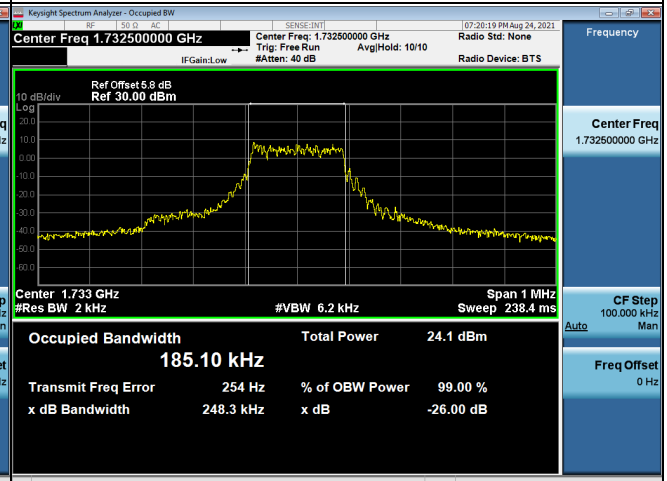
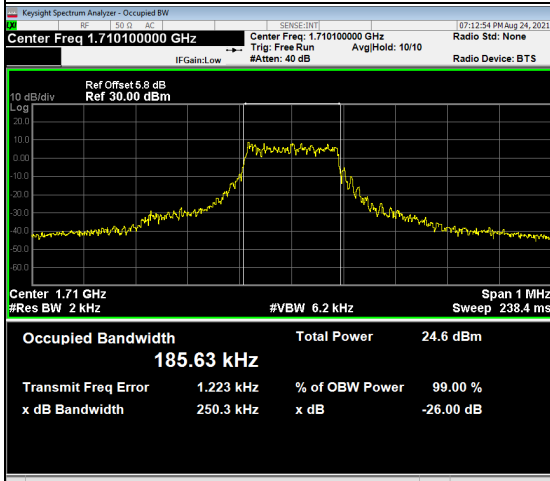

QPSK-20399

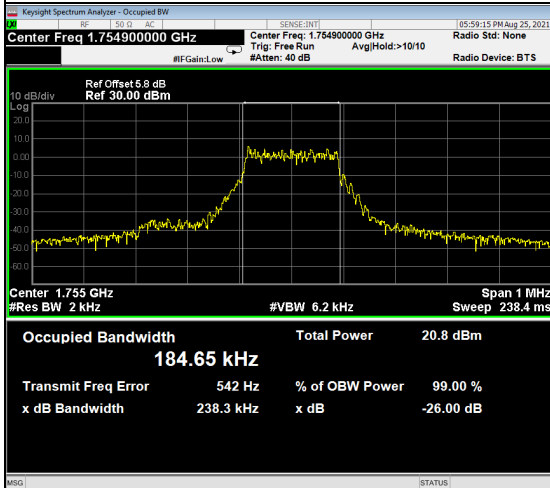

LTE Band 12_3.75KHz					
BPSK			1RB#0		
Channel	Frequency (MHz)	99% Occupied Bandwidth (KHz)	Channel	Frequency (MHz)	26dB Bandwidth (KHz)
23011	699.1	55.345	23011	699.1	40.35
23095	707.5	55.152	23095	707.5	38.10
23179	715.9	55.324	23179	715.9	40.41
QPSK			1RB#0		
Channel	Frequency (MHz)	99% Occupied Bandwidth (KHz)	Channel	Frequency (MHz)	26dB Bandwidth (KHz)
23011	699.1	64.215	23011	699.1	39.78
23095	707.5	63.044	23095	707.5	39.42
23179	715.9	63.576	23179	715.9	42.25



LTE Band 12_15KHz					
BPSK			1RB#0		
Channel	Frequency (MHz)	99% Occupied Bandwidth (KHz)	Channel	Frequency (MHz)	26dB Bandwidth (KHz)
23011	699.1	119.88	23011	699.1	106.3
23095	707.5	120.23	23095	707.5	106.4
23179	715.9	122.09	23179	715.9	105.6
QPSK			1RB#0		
Channel	Frequency (MHz)	99% Occupied Bandwidth (KHz)	Channel	Frequency (MHz)	26dB Bandwidth (KHz)
23011	699.1	125.82	23011	699.1	117.8
23095	707.5	119.83	23095	707.5	116.8
23179	715.9	125.43	23179	715.9	129.7
QPSK			12RB#0		
Channel	Frequency (MHz)	99% Occupied Bandwidth (KHz)	Channel	Frequency (MHz)	26dB Bandwidth (KHz)
23011	699.1	186.70	23011	699.1	248.2
23095	707.5	185.57	23095	707.5	251.5
23179	715.9	185.52	23179	715.9	246.8

Spectrum Plot

1RB#0

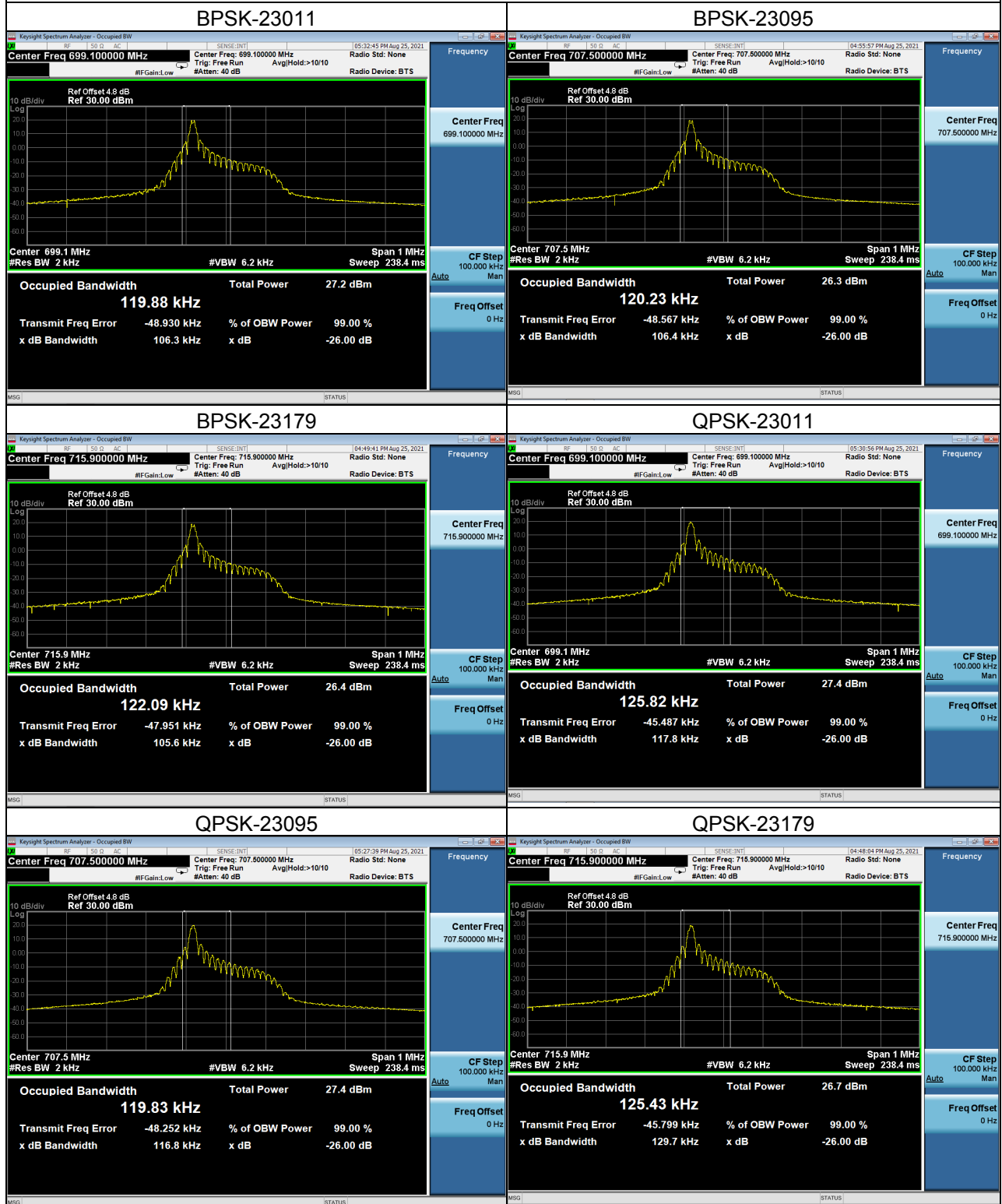

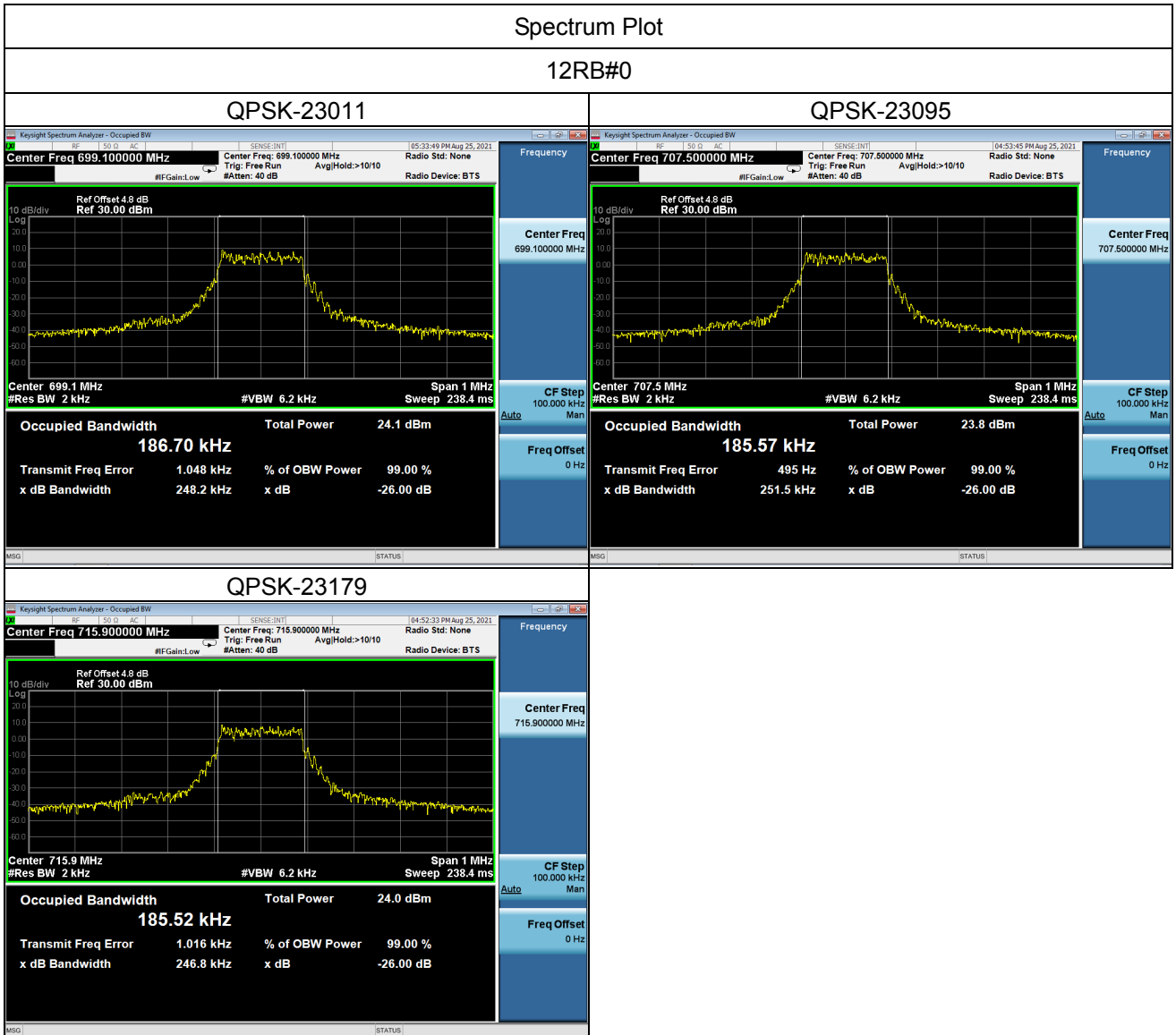

LTE Band 13_3.75KHz					
BPSK			1RB#0		
Channel	Frequency (MHz)	99% Occupied Bandwidth (KHz)	Channel	Frequency (MHz)	26dB Bandwidth (KHz)
23181	777.1	57.297	23181	777.1	41.04
23230	782	56.042	23230	782	40.47
23279	786.9	57.605	23279	786.9	40.17
QPSK			1RB#0		
Channel	Frequency (MHz)	99% Occupied Bandwidth (KHz)	Channel	Frequency (MHz)	26dB Bandwidth (KHz)
23181	777.1	65.482	23181	777.1	42.02
23230	782	63.913	23230	782	42.27
23279	786.9	66.404	23279	786.9	40.29

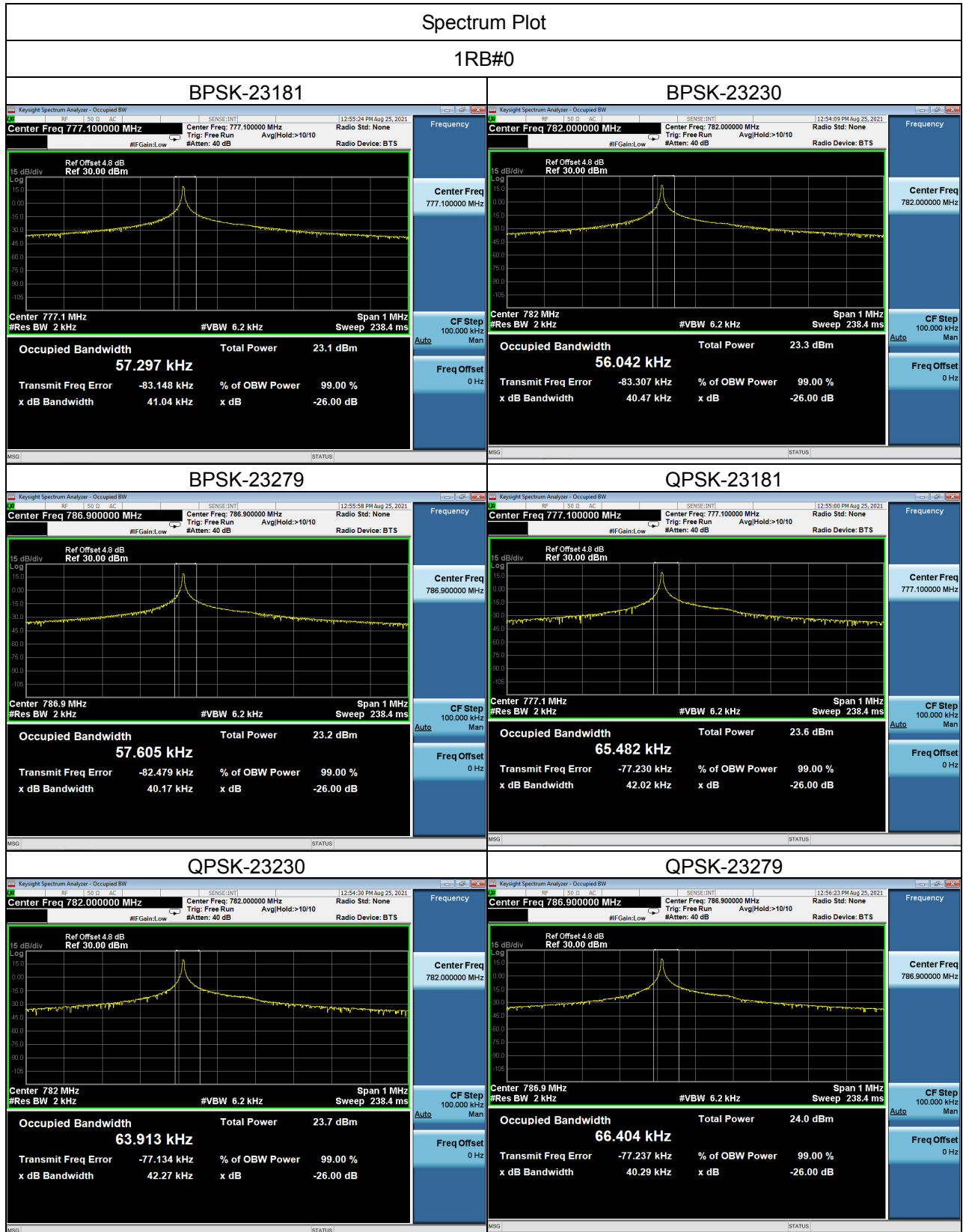

LTE Band 13_15KHz					
BPSK			1RB#0		
Channel	Frequency (MHz)	99% Occupied Bandwidth (KHz)	Channel	Frequency (MHz)	26dB Bandwidth (KHz)
23181	777.1	119.06	23181	777.1	106.4
23230	782	123.27	23230	782	106.0
23279	786.9	119.65	23279	786.9	106.2
QPSK			1RB#0		
Channel	Frequency (MHz)	99% Occupied Bandwidth (KHz)	Channel	Frequency (MHz)	26dB Bandwidth (KHz)
23181	777.1	127.81	23181	777.1	130.5
23230	782	126.41	23230	782	114.8
23279	786.9	120.60	23279	786.9	130.1
QPSK			12RB#0		
Channel	Frequency (MHz)	99% Occupied Bandwidth (KHz)	Channel	Frequency (MHz)	26dB Bandwidth (KHz)
23181	777.1	185.79	23181	777.1	238.4
23230	782	188.13	23230	782	250.1
23279	786.9	185.37	23279	786.9	248.3

Spectrum Plot

12RB#0

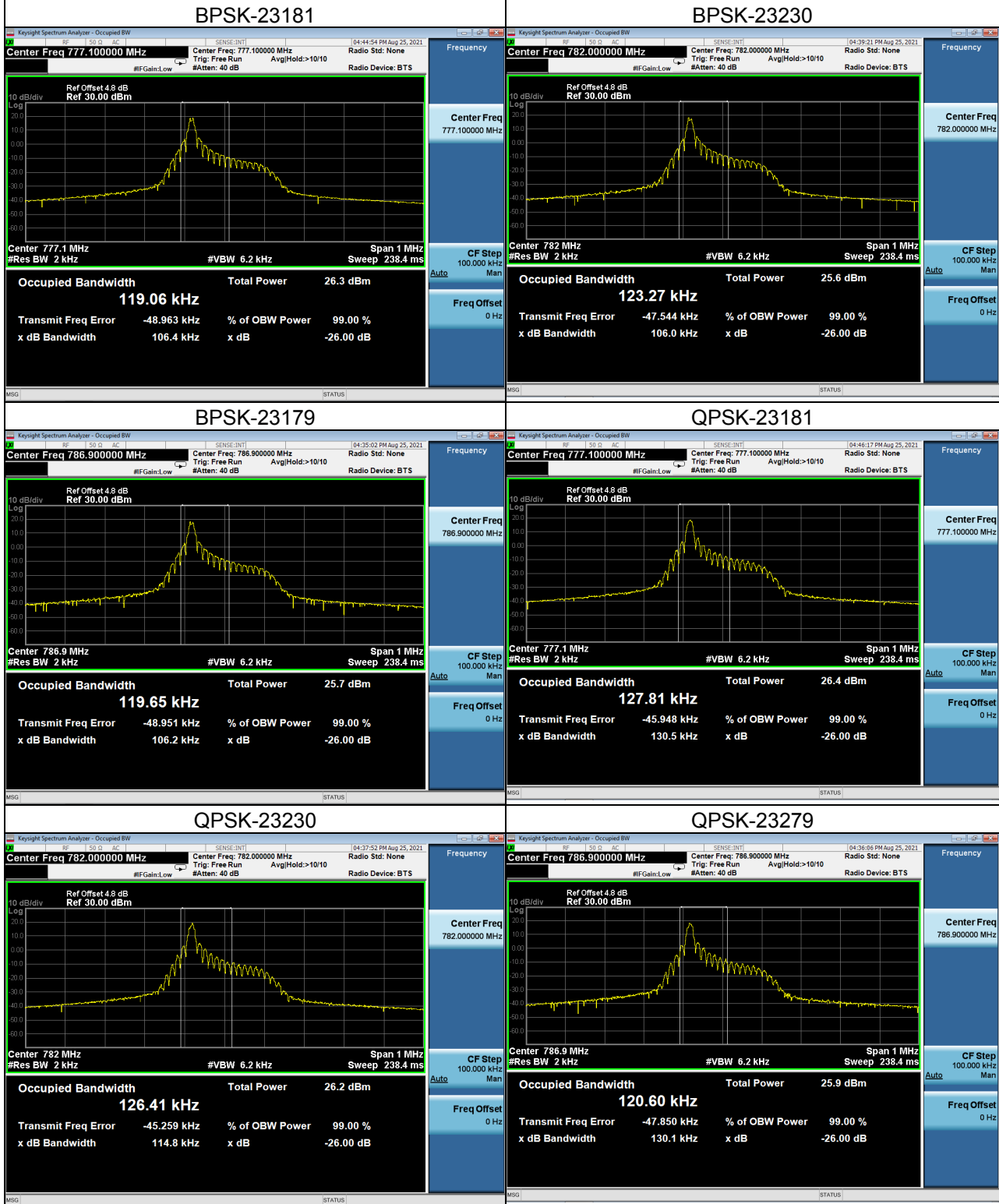

Spectrum Plot

12RB#0

QPSK-23181

QPSK-23230

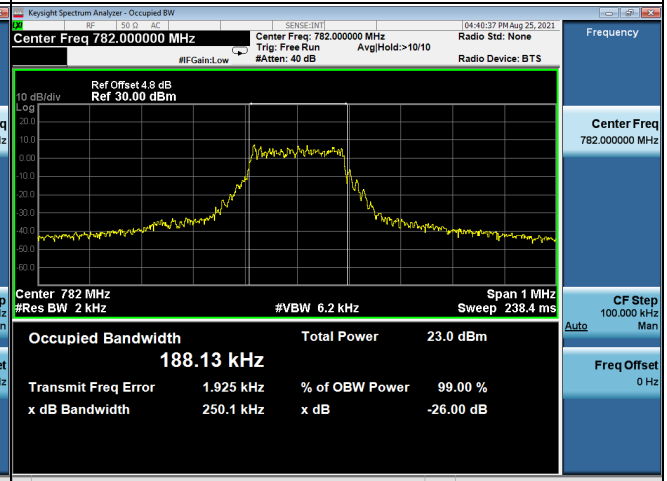
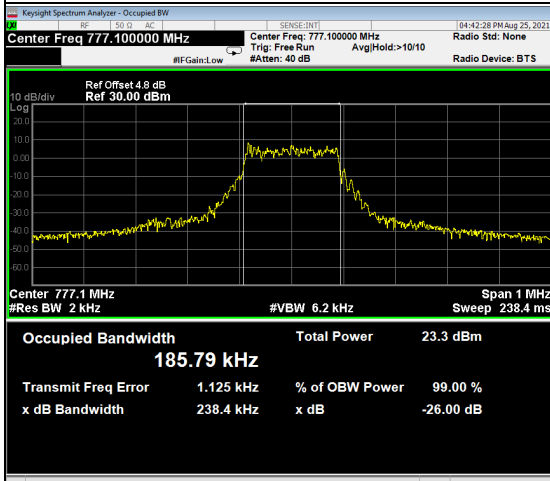

QPSK-23279

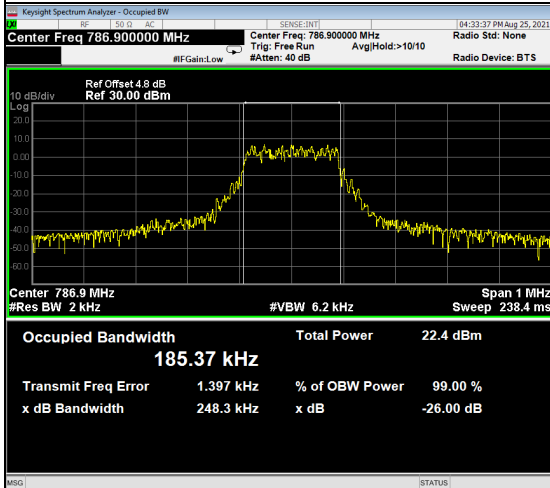

LTE Band 66_3.75KHz					
BPSK			1RB#0		
Channel	Frequency (MHz)	99% Occupied Bandwidth (KHz)	Channel	Frequency (MHz)	26dB Bandwidth (KHz)
131974	1710.2	58.787	131974	1710.2	41.28
132322	1745	56.496	132322	1745	37.92
132670	1779.8	58.329	132670	1779.8	39.78
QPSK			1RB#0		
Channel	Frequency (MHz)	99% Occupied Bandwidth (KHz)	Channel	Frequency (MHz)	26dB Bandwidth (KHz)
131974	1710.2	66.688	131974	1710.2	42.90
132322	1745	66.150	132322	1745	40.03
132670	1779.8	65.637	132670	1779.8	40.08

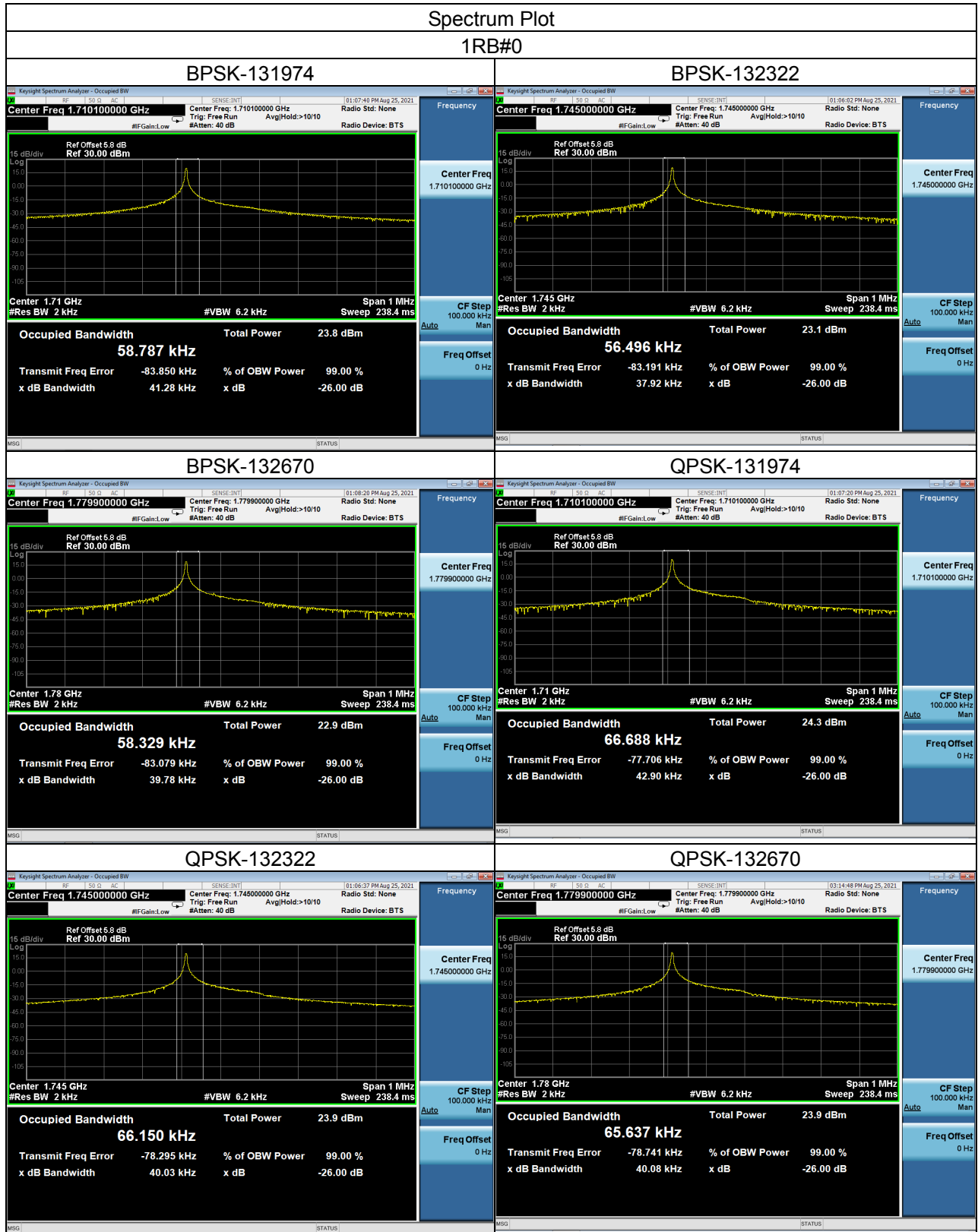

LTE Band 66_15KHz					
BPSK			1RB#0		
Channel	Frequency (MHz)	99% Occupied Bandwidth (KHz)	Channel	Frequency (MHz)	26dB Bandwidth (KHz)
131974	1710.2	118.21	131974	1710.2	104.5
132322	1745	119.52	132322	1745	104.1
132670	1779.8	119.82	132670	1779.8	111.2
QPSK			1RB#0		
Channel	Frequency (MHz)	99% Occupied Bandwidth (KHz)	Channel	Frequency (MHz)	26dB Bandwidth (KHz)
131974	1710.2	123.07	131974	1710.2	130.3
132322	1745	118.08	132322	1745	117.0
132670	1779.8	120.80	132670	1779.8	118.2
QPSK			12RB#0		
Channel	Frequency (MHz)	99% Occupied Bandwidth (KHz)	Channel	Frequency (MHz)	26dB Bandwidth (KHz)
131974	1710.2	190.03	131974	1710.2	245.7
132322	1745	184.69	132322	1745	250.2
132670	1779.8	185.90	132670	1779.8	250.9

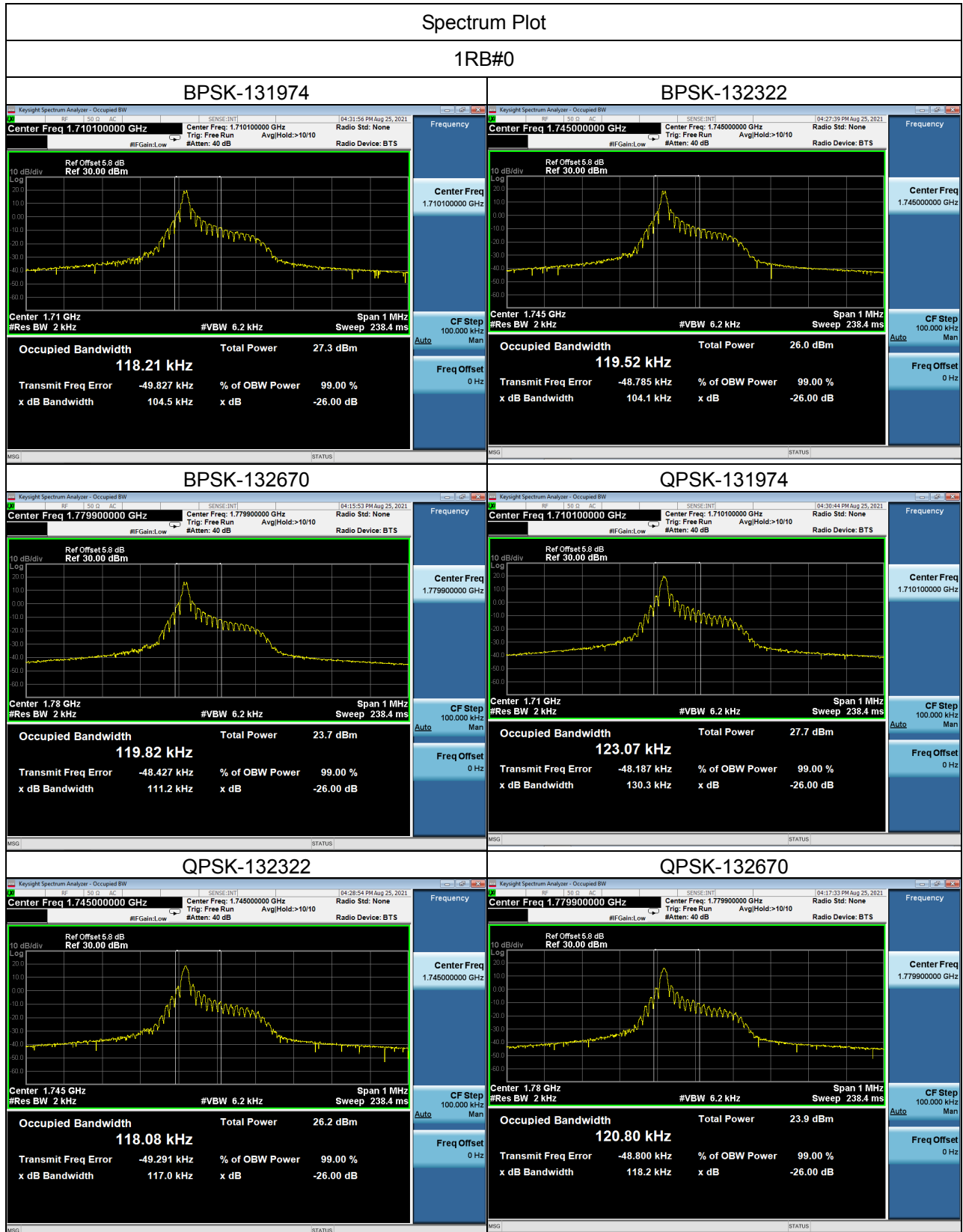

Spectrum Plot

12RB#0

QPSK-131974

QPSK-132322

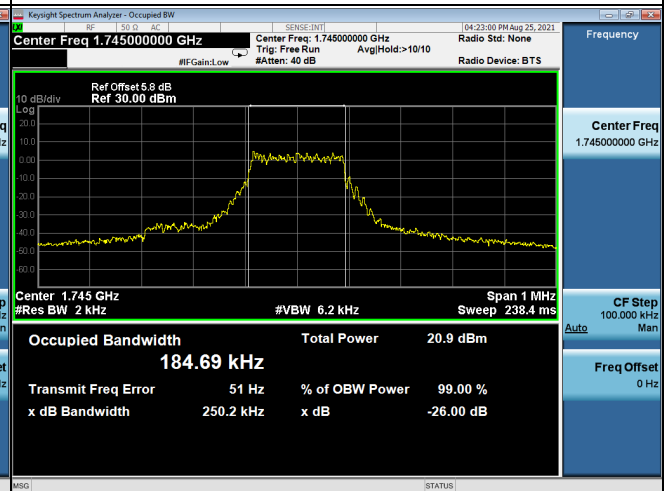
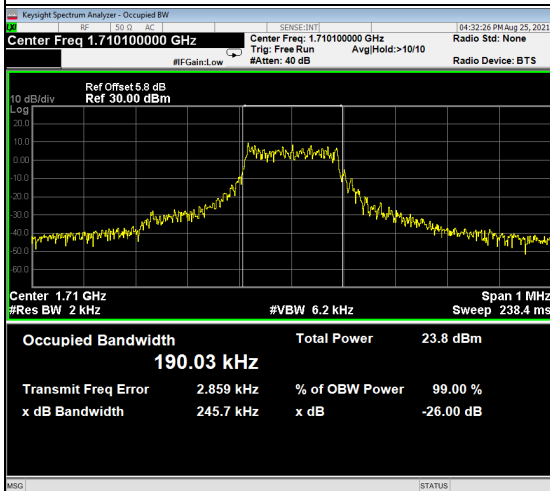

QPSK-132670

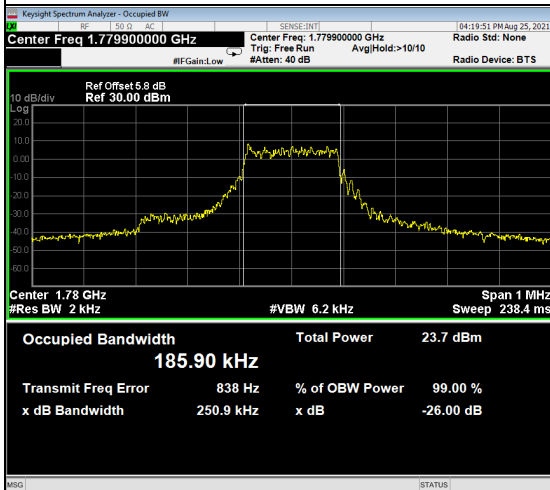

LTE Band 71_3.75KHz					
BPSK			1RB#0		
Channel	Frequency (MHz)	99% Occupied Bandwidth (KHz)	Channel	Frequency (MHz)	26dB Bandwidth (KHz)
133124	663.2	58.452	133124	663.2	41.62
133297	680.5	57.861	133297	680.5	41.48
133470	697.8	55.725	133470	697.8	39.30
QPSK			1RB#0		
Channel	Frequency (MHz)	99% Occupied Bandwidth (KHz)	Channel	Frequency (MHz)	26dB Bandwidth (KHz)
133124	663.2	68.515	133124	663.2	42.96
133297	680.5	71.252	133297	680.5	42.37
133470	697.8	66.110	133470	697.8	43.35

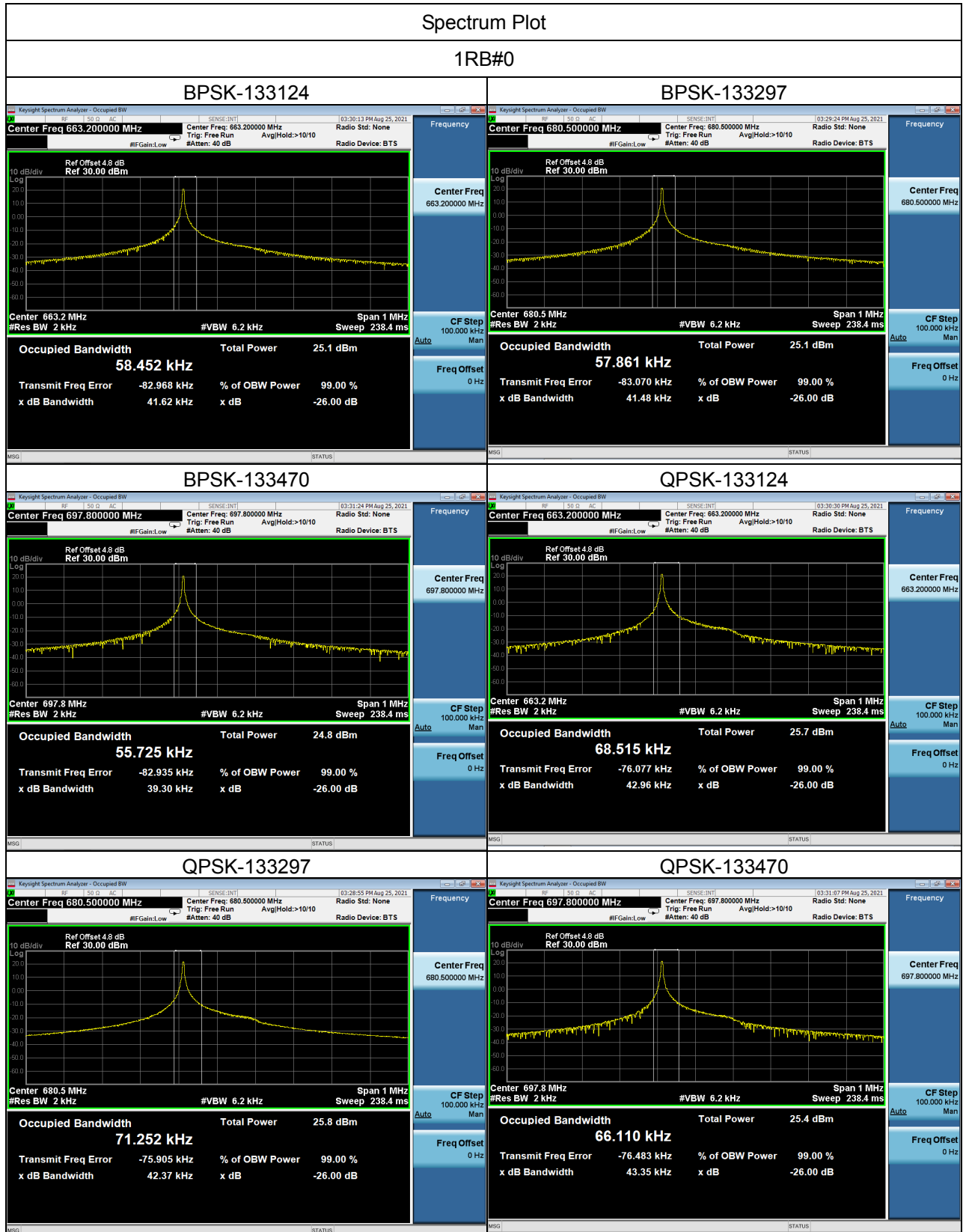

LTE Band 71_15KHz					
BPSK			1RB#0		
Channel	Frequency (MHz)	99% Occupied Bandwidth (KHz)	Channel	Frequency (MHz)	26dB Bandwidth (KHz)
133124	663.2	119.43	133124	663.2	105.3
133297	680.5	119.88	133297	680.5	105.3
133470	697.8	120.62	133470	697.8	106.6
QPSK			1RB#0		
Channel	Frequency (MHz)	99% Occupied Bandwidth (KHz)	Channel	Frequency (MHz)	26dB Bandwidth (KHz)
133124	663.2	122.97	133124	663.2	131.2
133297	680.5	122.75	133297	680.5	117.3
133470	697.8	120.03	133470	697.8	117.6
QPSK			12RB#0		
Channel	Frequency (MHz)	99% Occupied Bandwidth (KHz)	Channel	Frequency (MHz)	26dB Bandwidth (KHz)
133124	663.2	190.46	133124	663.2	263.6
133297	680.5	189.21	133297	680.5	263.6
133470	697.8	186.84	133470	697.8	248.9

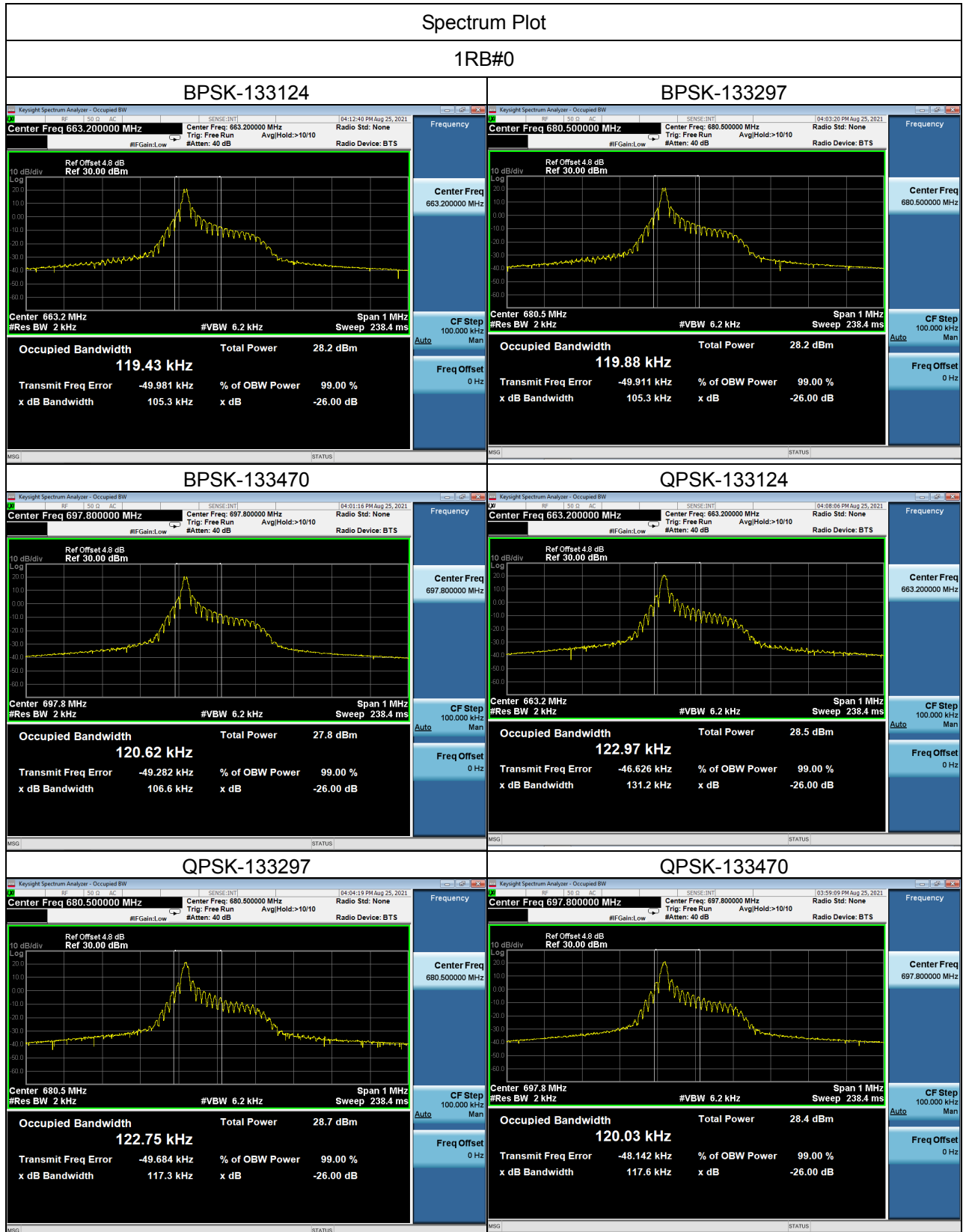

Spectrum Plot

12RB#0

QPSK-133124

QPSK-133297

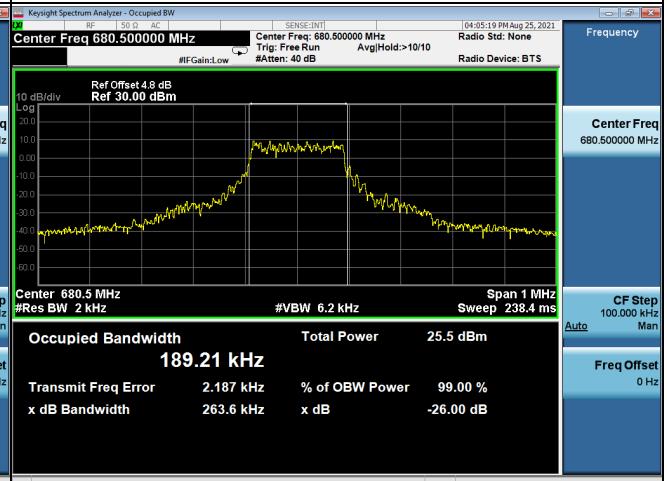
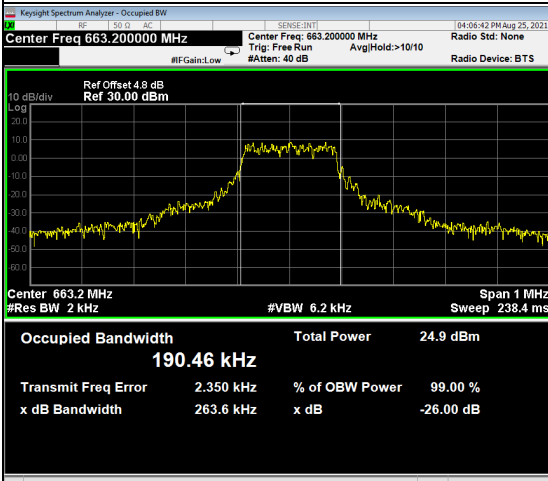

QPSK-133470

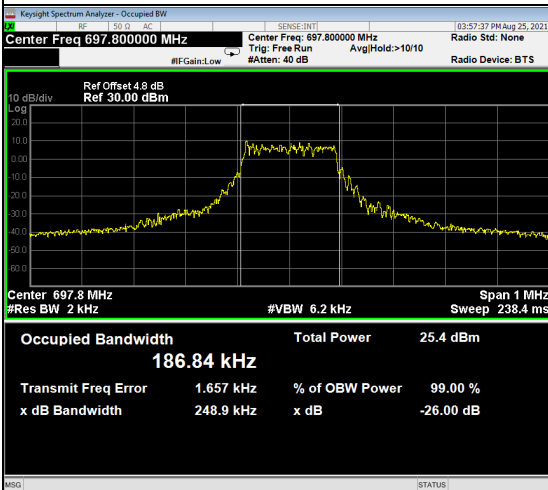

LTE Band 85_3.75KHz					
BPSK			1RB#0		
Channel	Frequency (MHz)	99% Occupied Bandwidth (KHz)	Channel	Frequency (MHz)	26dB Bandwidth (KHz)
134004	698.2	56.786	134004	698.2	41.29
134092	707	57.298	134092	707	41.52
134180	715.8	54.789	134180	715.8	40.62
QPSK			1RB#0		
Channel	Frequency (MHz)	99% Occupied Bandwidth (KHz)	Channel	Frequency (MHz)	26dB Bandwidth (KHz)
134004	698.2	63.698	134004	698.2	39.97
134092	707	63.863	134092	707	40.12
134180	715.8	60.504	134180	715.8	39.37

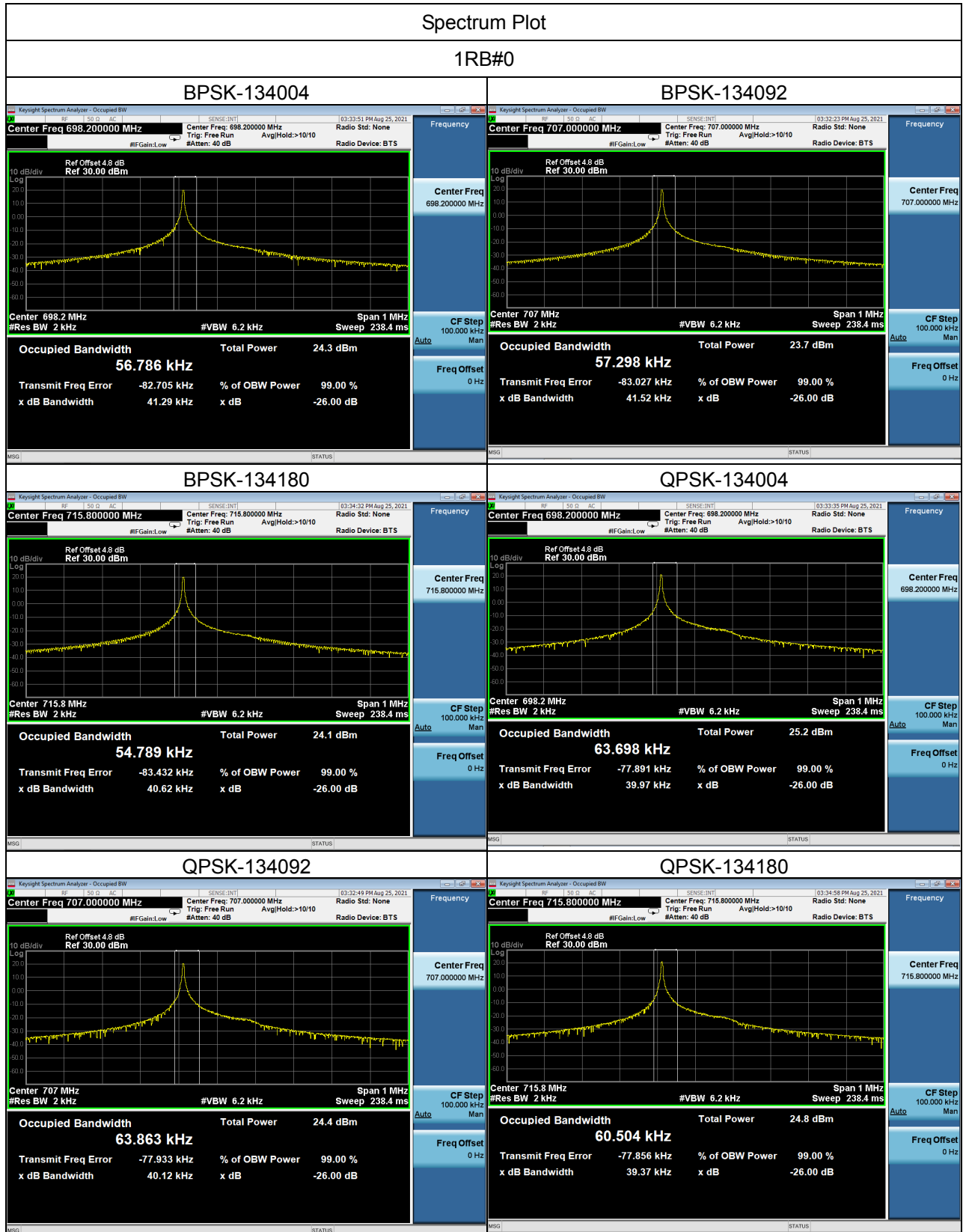

LTE Band 85_15KHz					
BPSK			1RB#0		
Channel	Frequency (MHz)	99% Occupied Bandwidth (KHz)	Channel	Frequency (MHz)	26dB Bandwidth (KHz)
134004	698.2	119.83	134004	698.2	106.4
134092	707	119.63	134092	707	105.2
134180	715.8	119.65	134180	715.8	104.9
QPSK			1RB#0		
Channel	Frequency (MHz)	99% Occupied Bandwidth (KHz)	Channel	Frequency (MHz)	26dB Bandwidth (KHz)
134004	698.2	120.29	134004	698.2	118.1
134092	707	126.47	134092	707	130.3
134180	715.8	126.72	134180	715.8	117.7
QPSK			12RB#0		
Channel	Frequency (MHz)	99% Occupied Bandwidth (KHz)	Channel	Frequency (MHz)	26dB Bandwidth (KHz)
134004	698.2	185.55	134004	698.2	250.3
134092	707	186.27	134092	707	246.9
134180	715.8	188.34	134180	715.8	248.9

Spectrum Plot

12RB#0

BPSK-134004

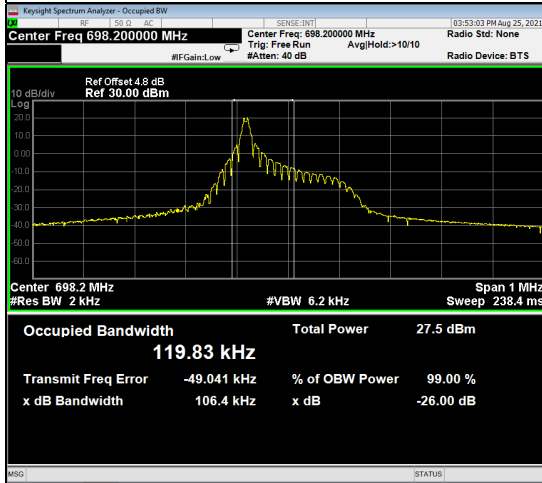

BPSK-134092

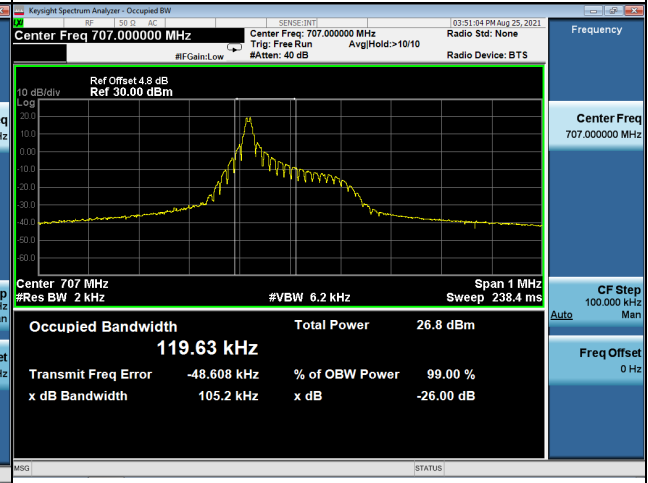

BPSK-134180

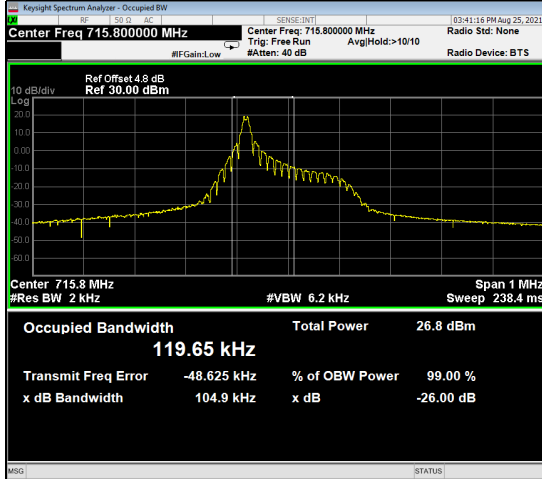

QPSK-134004

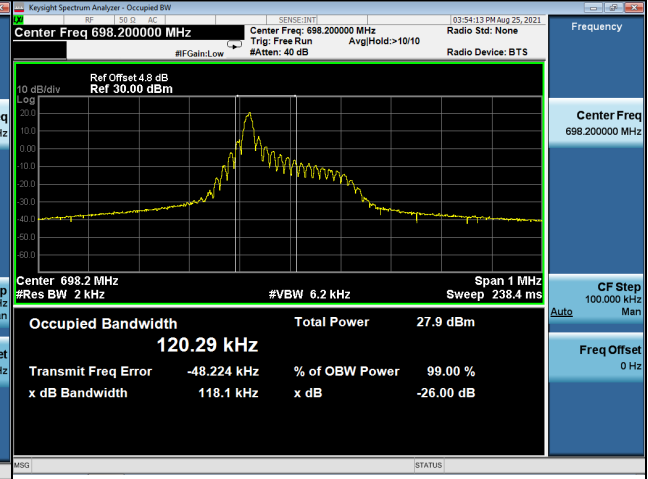

QPSK-134092

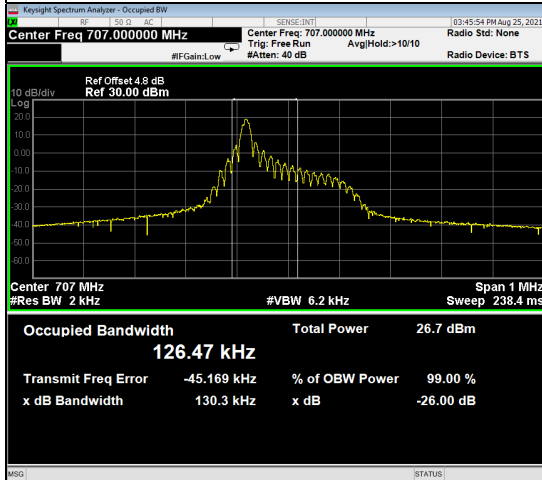

QPSK-134180



Spectrum Plot

12RB#0

QPSK-134004

QPSK-134092

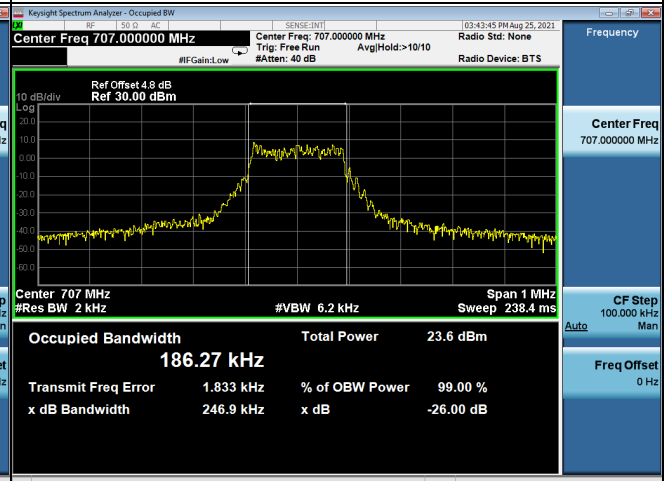
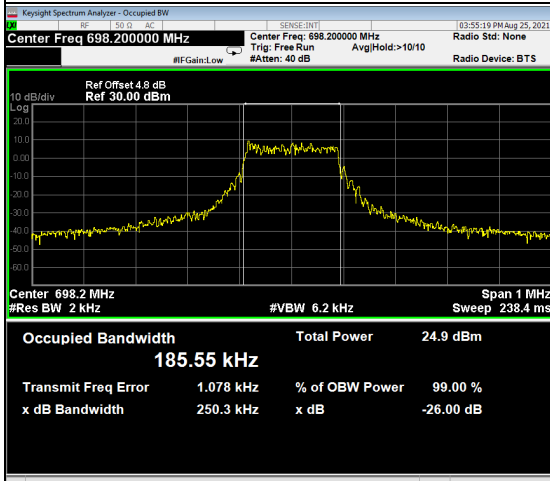

QPSK-134180

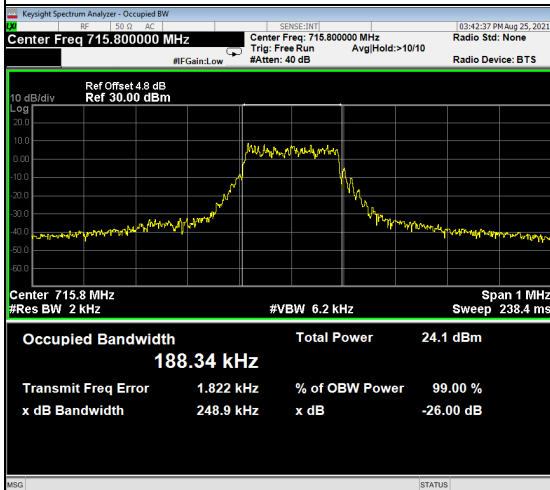

APPENDIX C - CONDUCTED SPURIOUS EMISSIONS

