



# FCC TEST REPORT

Report No: STS1807108W04

Issued for

Rapsodo Pte Ltd

Block 67, Ayer Rajah Crescent, #04-10, Singapore 139950

<b>Product Name:</b>	Rapsodo Compute Engine
<b>Brand Name:</b>	Rapsodo
<b>Model Name:</b>	RCE2.0
<b>Series Model:</b>	N/A
<b>FCC ID:</b>	2AH3ORCE20
<b>Test Standard:</b>	FCC Part 15.407

Any reproduction of this document must be done in full. No single part of this document may be reproduced without permission from STS, All Test Data Presented in this report is only applicable to presented Test sample.





### TEST RESULT CERTIFICATION

**Applicant's name** ..... : Rapsodo Pte Ltd  
 Address ..... : Block 67, Ayer Rajah Crescent, #04-10, Singapore 139950  
**Manufacture's Name**..... : Rapsodo Pte Ltd  
 Address ..... : Block 67, Ayer Rajah Crescent, #04-10, Singapore 139950

**Product description**

Product Name..... : Rapsodo Compute Engine  
 Brand Name ..... : Rapsodo  
 Model Name ..... : RCE2.0  
 Series Model..... : N/A

**Test Standards** ..... : FCC Part15.407

Test procedure..... ANSI C63.10-2013

This device described above has been tested by STS, the test results show that the equipment under test (EUT) is in compliance with the FCC&IC requirements. And it is applicable only to the tested sample identified in the report.

This report shall not be reproduced except in full, without the written approval of STS, this document only be altered or revised by STS, personal only, and shall be noted in the revision of the document.

**Date of Test** ..... :  
 Date (s) of performance of tests ..... : 11 July 2018~24 July 2018  
 Date of Issue..... : 25 July 2018  
 Test Result..... : **Pass**

Testing Engineer : *Chris chen*  
 \_\_\_\_\_  
 ( Chris chen )

Technical Manager : *Sean she*  
 \_\_\_\_\_  
 ( Sean she )

Authorized Signatory : *Vita Li*  
 \_\_\_\_\_  
 (Vita Li)





Table of Contents	Page
<b>1 . SUMMARY OF TEST RESULTS</b>	<b>5</b>
1.1 TEST FACTORY	6
1.2 MEASUREMENT UNCERTAINTY	6
<b>2 . GENERAL INFORMATION</b>	<b>7</b>
2.1 GENERAL DESCRIPTION OF EUT	7
2.2 DESCRIPTION OF TEST MODES	10
2.3 BLOCK DIGRAM SHOWING THE CONFIGURATION OF SYSTEM TESTED	11
2.4 DESCRIPTION OF SUPPORT UNITS(CONDUCTED MODE)	12
2.5 EQUIPMENTS LIST FOR ALL TEST ITEMS	13
<b>3 . EMC EMISSION TEST</b>	<b>14</b>
3.1 CONDUCTED EMISSION MEASUREMENT	14
3.2 RADIATED EMISSION AND ( BANDEGE) MEASUREMENT	18
3.2.6 FIELD STRENGTH CALCULATION	21
<b>4. CONDUCTED SPURIOUS EMISSIONS AND BANDEGE</b>	<b>42</b>
4.1 APPLIED PROCEDURES / LIMIT	42
<b>5. POWER SPECTRAL DENSITY TEST</b>	<b>44</b>
5.1 APPLIED PROCEDURES / LIMIT	44
<b>6. BANDWIDTH MEASUREMENT</b>	<b>46</b>
6.1 EMISSION BANDWIDTH (EBW) 26 BANDWID PROCEDURES / LIMIT	46
6.2 OCCUPIED BANDWIDTH ( 99%) TEST APPLIED PROCEDURES / LIMIT	47
6.3 MINIMUM EMISSION BANDWIDTH(6 DB) PROCEDURES / LIMIT	48
<b>7. MAXIMUM CONDUCTED OUTPUT POWER</b>	<b>49</b>
7.1 APPLIED PROCEDURES / LIMIT	49
<b>8. AUTOMATICALLY DISCONTINUE TRANSMISSION</b>	<b>58</b>
8.1 LIMIT OF AUTOMATICALLY DISCONTINUE TRANSMISSION	58
8.2 TEST RESULT OF AUTOMATICALLY DISCONTINUE TRANSMISSION	58
<b>9. ANTENNA REQUIREMENT</b>	<b>59</b>
9.1 STANDARD REQUIREMENT	59
9.2 EUT ANTENNA	59
<b>APPENDIX - PHOTOS OF TEST SETUP</b>	<b>60</b>



**Revision History**

Rev.	Issue Date	Report NO.	Effect Page	Contents
00	25 July 2018	STS1807108W04	ALL	Initial Issue





## 1. SUMMARY OF TEST RESULTS

Test procedures according to the technical standards:

§ 15.407, KDB 789033 D02 General U-NII Test Procedures New Rules v02r01

FCC Part 15.407		
FCC standard	Test Item	Results
15.207	AC Conducted Emission	PASS
§ 15.407 (2) (26 dB) / § 15.407 (e) (6 dB) / § 15.407 (a) (99%)	26dB/6dB & 99% Bandwidth	PASS
15.407(a) (1).(2).(3).(4).(5)	Maximum Conducted Output Power	PASS
15.407(b)	Peak Excursion Ratio	PASS
15.407(b) & 15.209	Radiated Emission And (bandedge Emissions) Measurement	PASS
15.407(b)7	Conducted Emission And (bandedge Emissions) Measurement	PASS
15.407(a) (1).(2).(3).(4).(5)	Power Spectral Density	PASS
15.407(c)	Automatically Discontinue Transmission	PASS
15.203/15.204	Antenna Requirement	PASS

**NOTE:**

(1) "N/A" denotes test is not applicable in this Test Report

(2) all tests are according to ANSI C63.10-2013



## 1.1 TEST FACTORY

Shenzhen STS Test Services Co., Ltd.

Add. : 1/F., Building B, Zhuoke Science Park, No.190, Chongqing Road,  
Fuyong Street, Bao'an District, Shenzhen, Guangdong, China

CNAS Registration No.: L7649; FCC Registration No.: 625569

IC Registration No.: 12108A; A2LA Certificate No.: 4338.01;

## 1.2 MEASUREMENT UNCERTAINTY

The reported uncertainty of measurement  $y \pm U$ , where expanded uncertainty  $U$  is based on a standard uncertainty multiplied by a coverage factor of  $k=2$ , providing a level of confidence of approximately **95 %**.

No.	Item	Uncertainty
1	Conducted Emission (9KHz-150KHz)	$\pm 2.88\text{dB}$
2	Conducted Emission (150KHz-30MHz)	$\pm 2.67\text{dB}$
3	RF power,conducted	$\pm 0.71\text{dB}$
4	Spurious emissions,conducted	$\pm 0.63\text{dB}$
5	All emissions,radiated(<1G) 30MHz-200MHz	$\pm 3.80\text{dB}$
6	All emissions,radiated(<1G) 200MHz-1000MHz	$\pm 3.97\text{dB}$
7	All emissions,radiated(>1G)	$\pm 3.03\text{dB}$



## 2. GENERAL INFORMATION

### 2.1 GENERAL DESCRIPTION OF EUT

Product Name	Rapsodo Compute Engine	
Trade Name	Rapsodo	
Model Name	RCE2.0	
Series Model	N/A	
Model Difference	N/A	
Product Description	The EUT is a Rapsodo Compute Engine	
	Operation Frequency:	IEEE 802.11a/ n/ac(HT20) 5.180GHz-5.240GHz IEEE 802.11n/ac(HT40) 5.190GHz-5.310GHz IEEE 802.11ac(HT80) 5.210GHz
		IEEE 802.11a/ n/ac(HT20)5.260GHz-5.320GHz IEEE 802.11n/ac(HT40)5.270GHz-5.310GHz IEEE 802.11ac(HT80) 5.290GHz
		IEEE 802.11a/ n/ac(HT20)5.500GHz-5.700GHz IEEE 802.11n/ac(HT40)5.510GHz-5.670GHz IEEE 802.11ac(HT80) 5.530GHz-5.610GHz
		IEEE 802.11a/ n/ac(HT20)5.745GHz-5.825GHz IEEE 802.11a/ n/ac(HT40)5.755GHz-5.795GHz IEEE 802.11ac(HT80) 5.775GHz
		Modulation Type:
Antenna Designation:		See Note 3
Max.Output Power(Conducted):	15.61dBm	
More details of EUT technical specification, please refer to the User's Manual.		
Test Channel	Please refer to the Note 2.	
Adapter	Power supply and ADP(rating): Input: AC 100V-240V, 50/60Hz, 0.5A Output: DC 5V/3A, 9V/2A, 12V/1.5A	
Battery	Battery(rating): Rated Voltage: 3.7V Charge Limit: 4.2V Capacity :6900mAh	
Hardware version number	AP6356S	
Software version number	fw_bcm4356a2_ag_mfg.bin	
Connecting I/O Port(s)	Please refer to the User's Manual	

Note: For a more detailed features description, please refer to the manufacturer's specifications or the User's Manual.



1. Operation Frequency of channel

5.180GHz-5.240GHz		5.500GHz-5.720GHz	
Channel	Frequency	Channel	Frequency
36	5180	100	5500
38	5190	102	5510
40	5200	104	5520
42	5210	108	5540
44	5220	110	5550
46	5230	112	5560
48	5240	116	5580
		118	5590
		120	5600
5.260GHz-5.320GHz			
Channel	Frequency		
52	5260	124	5620
54	5270	126	5630
56	5280	128	5640
58	5290	132	5660
60	5300	134	5670
62	5310	136	5680
64	5320	140	5700
5.745GHz-5.825GHz			
Channel	Frequency		
149	5745		
151	5755		
153	5765		
157	5785		
159	5795		
161	5805		
165	5825		

Note:

In section 15.31(m), regards to the operating frequency range over 10 MHz, the Lowest frequency, the middle frequency, and the highest frequency of channel were selected to perform the test, and the selected channel see below:

Carrier Frequency Channel

5GHz:

For 802.11a/n/ac (HT20)			
Channel	Freq.(MHz)	Channel	Freq.(MHz)
36	5180	52	5260
40	5200	60	5300
48	5240	64	5320

For 802.11a/n/ac (HT20)			
Channel	Freq.(MHz)	Channel	Freq.(MHz)
100	5500	149	5745
116	5580	157	5785
140	5700	165	5825





For 802.11n/ac (HT40)			
Channel	Freq.(MHz)	Channel	Freq.(MHz)
38	5190	54	5270
46	5230	62	5310

For 802.11n/ac (HT40)			
Channel	Freq.(MHz)	Channel	Freq.(MHz)
102	5510	151	5755
110	5550	159	5795
134	5670		

For 802.11ac (HT80)			
Channel	Freq.(MHz)	Channel	Freq.(MHz)
42	5210	58	5290

For 802.11ac (HT80)			
Channel	Freq.(MHz)	Channel	Freq.(MHz)
106	5530	155	5775
122	5610		

2. KDB 662911 D01 Multiple Transmitter Output v02r01

2) Directional Gain Calculations for In-Band Measurements

a) Basic methodology with NANT transmit antennas, each with the same directional gain  $G_{ANT}$  dBi, being driven by NANT transmitter outputs of equal power. Directional gain is to be computed as follows:

(i) If any transmit signals are correlated with each other,

$$\text{Directional gain} = G_{ANT} + 10 \log(NANT) \text{ dBi}$$

(ii) If all transmit signals are completely uncorrelated with each other,

$$\text{Directional gain} = G_{ANT}$$

ANT A=4.5 dBi

ANT B=4.5 dBi

$$G_{ANT} + 10 \log(NANT) \text{ dBi}$$

$$\text{Directional gain} = 4.5 + 10 \log 2 = 7.51 \text{ dBi}$$

Ant.	Brand	Model Name	Ant Type	Connector	Gain (dBi)	NOTE
A	Rapsodo	RCE2.0	PIFA Ant.	N/A	4.5dBi	WLAN Ant.
B	Rapsodo	RCE2.0	PIFA Ant.	N/A	4.5dBi	WLAN Ant.



## 2.2 DESCRIPTION OF TEST MODES

To investigate the maximum EMI emission characteristics generated from EUT, the test system was pre-scanning tested based on the consideration of following EUT operation mode or test configuration mode which possibly have effect on EMI emission level. Each of these EUT operation mode(s) or test configuration mode(s) mentioned above was evaluated respectively.

Worst Mode	Description	Data Rate
Mode 1	TX IEEE 802.11a HT20 CH36&CH40&CH48	6 Mbps
Mode 2	TX IEEE 802.11a HT20 CH52&CH60&CH64	6 Mbps
Mode 3	TX IEEE 802.11a HT20 CH100&CH116&CH140	6 Mbps
Mode 4	TX IEEE 802.11a HT20 CH149&CH157&CH165	6 Mbps
Mode 5	TX IEEE 802.11n HT20 CH36&CH40&CH48	MCS 0
Mode 6	TX IEEE 802.11ac HT20 CH36&CH40&CH48	NSS1 MCS0
Mode 7	TX IEEE 802.11n HT20 CH52&CH60&CH64	MCS 0
Mode 8	TX IEEE 802.11ac HT20 CH52&CH60&CH64	NSS1 MCS0
Mode 9	TX IEEE 802.11n HT20 CH100&CH116&CH140	MCS 0
Mode 10	TX IEEE 802.11ac HT20 CH100&CH116&CH140	NSS1 MCS0
Mode 11	TX IEEE 802.11n HT20 CH149&CH157&CH165	MCS 0
Mode 12	TX IEEE 802.11ac HT20 CH149&CH157&CH165	NSS1 MCS0
Mode 13	TX IEEE 802.11n HT40 CH38&CH46	MCS 0
Mode 14	TX IEEE 802.11ac HT40 CH38&CH46	NSS1 MCS0
Mode 15	TX IEEE 802.11n HT40 CH54 &CH62	MCS 0
Mode 16	TX IEEE 802.11ac HT40 CH54 &CH62	NSS1 MCS0
Mode 17	TX IEEE 802.11n HT40 CH102&CH110&CH134	MCS 0
Mode 18	TX IEEE 802.11ac HT40 CH102&CH110&CH134	NSS1 MCS0
Mode 19	TX IEEE 802.11n HT40 CH151&CH159	MCS 0
Mode 20	TX IEEE 802.11ac HT40 CH151&CH159	NSS1 MCS0
Mode 21	TX IEEE 802.11ac HT80 CH42	NSS1 MCS0
Mode 22	TX IEEE 802.11ac HT80 CH58	NSS1 MCS0
Mode 23	TX IEEE 802.11ac HT80 CH106&122	NSS1 MCS0
Mode 24	TX IEEE 802.11ac HT80 CH155	NSS1 MCS0

- Note: (1) The measurements are performed at the highest, middle, lowest available channels.  
(2) The measurements are performed at all Bit Rate of Transmitter, the worst data was reported  
(3) We have been tested for all available U.S. voltage and frequencies (For 120V, 50/60Hz and 240V, 50/60Hz) for which the device is capable of operation.

AC Conducted Emission

Test Case	
AC Conducted Emission	Mode 25: Keeping TX + WLAN Link

**2.3 BLOCK DIGRAM SHOWING THE CONFIGURATION OF SYSTEM TESTED**

Radiated Spurious Emission Test

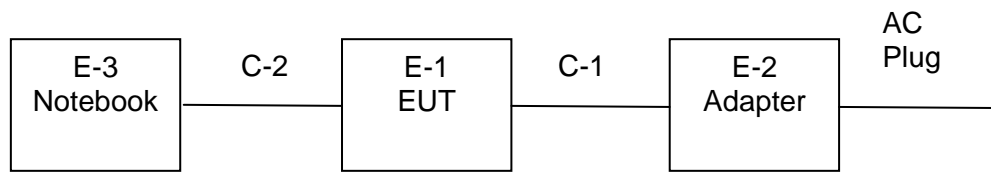

Conducted Emission Test

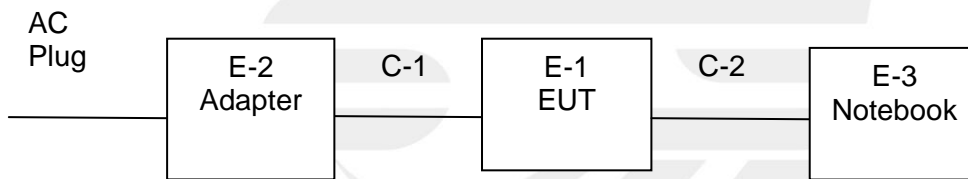



## 2.4 DESCRIPTION OF SUPPORT UNITS(CONDUCTED MODE)

The EUT has been tested as an independent unit together with other necessary accessories or support units. The following support units or accessories were used to form a representative test configuration during the tests.

Item	Equipment	Mfr/Brand	Model/Type No.	Series No.	Note
E-2	Adapter	LOGIC	X5.5T	N/A	N/A
E-3	Notebook	HP	500-320cx	N/A	N/A

Item	Shielded Type	Ferrite Core	Length	Note
C-1	DC Cable	NO	90cm	N/A
C-2	USB Cable	NO	100cm	N/A

Note:

- (1) The support equipment was authorized by Declaration of Confirmation.
- (2) For detachable type I/O cable should be specified the length in cm in 『Length』 column.
- (3) “YES” is means “shielded” “with core”; “NO” is means “unshielded” “without core”.

## 2.5 EQUIPMENTS LIST FOR ALL TEST ITEMS

### Radiation Test equipment

Kind of Equipment	Manufacturer	Type No.	Serial No.	Last calibration	Calibrated until
EMI Test Receiver	R&S	ESCI	102086	2017.10.15	2018.10.14
Bilog Antenna	TESEQ	CBL6111D	34678	2017.11.02	2018.11.01
Horn Antenna	Schwarzbeck	BBHA 9120D	9120D-1343	2017.10.27	2018.10.26
Horn Antenna	Schwarzbeck	BBHA 9170	9170-0741	2016.03.06	2019.03.03
PreAmplifier	Agilent	8449B	60538	2017.10.15	2018.10.14
Passive Loop (9K--30MHz)	ZHNAN	ZN3090C	16035	2018.03.11	2019.03.10
Low frequency cable	EM	R01	N/A	NCR	NCR
High frequency cable	SCHWARZBECK	AK9515H	SN-96286/96287	NCR	NCR
EMI Test Receiver	R&S	ESW	101535	2017.07.11	2018.07.10

### Conduction Test equipment

Kind of Equipment	Manufacturer	Type No.	Serial No.	Last calibration	Calibrated until
Test Receiver	R&S	ESCI	101427	2017.10.15	2018.10.14
LISN	R&S	ENV216	101242	2017.10.15	2018.10.14
Conduction Cable	EM	C01	N/A	2018.03.11	2019.03.10

### RF Connected Test

Kind of Equipment	Manufacturer	Type No.	Serial No.	Last calibration	Calibrated until
USB RF power sensor	DARE	RPR3006W	15I00041SNO03	2017.10.15	2018.10.14
Spectrum Analyzer	Agilent	N9020A	MY51110105	2018.03.08	2019.03.07
Signal Analyzer	Agilent	N9020A	MY49100060	2017.10.15	2018.10.14



### 3. EMC EMISSION TEST

#### 3.1 CONDUCTED EMISSION MEASUREMENT

##### 3.1.1 POWER LINE CONDUCTED EMISSION Limits (Frequency Range 150KHz-30MHz)

FREQUENCY (MHz)	Class B (dBuV)		Standard
	Quasi-peak	Average	
0.15 -0.5	66 - 56 *	56 - 46 *	CISPR
0.50 -5.0	56.00	46.00	CISPR
5.0 -30.0	60.00	50.00	CISPR

0.15 -0.5	66 - 56 *	56 - 46 *	FCC
0.50 -5.0	56.00	46.00	FCC
5.0 -30.0	60.00	50.00	FCC

Note:

- (1) The tighter limit applies at the band edges.
- (2) The limit of " \* " marked band means the limitation decreases linearly with the logarithm of the frequency in the range.

The following table is the setting of the receiver

Receiver Parameters	Setting
Attenuation	10 dB
Start Frequency	0.15 MHz
Stop Frequency	30 MHz
IF Bandwidth	9 kHz

**3.1.2 TEST PROCEDURE**

- a. The EUT was placed 0.8 meters from the horizontal ground plane with EUT being connected to the power mains through a line impedance stabilization network (LISN). All other support equipments powered from additional LISN(s). The LISN provide 50 Ohm/ 50uH of coupling impedance for the measuring instrument.
- b. Interconnecting cables that hang closer than 40 cm to the ground plane shall be folded back and forth in the center forming a bundle 30 to 40 cm long.
- c. I/O cables that are not connected to a peripheral shall be bundled in the center. The end of the cable may be terminated, if required, using the correct terminating impedance. The overall length shall not exceed 1 m.
- d. LISN at least 80 cm from nearest part of EUT chassis.
- e. For the actual test configuration, please refer to the related Item –EUT Test Photos.

**3.1.3 DEVIATION FROM TEST STANDARD**

No deviation

**3.1.4 TEST SETUP**

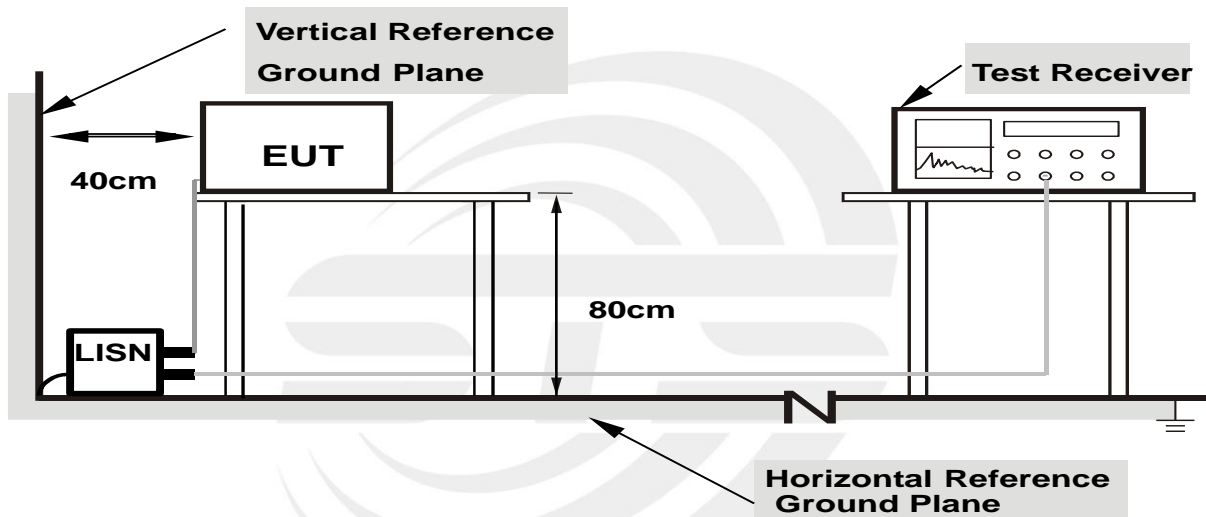

- Note: 1.Support units were connected to second LISN.**  
**2.Both of LISNs (AMN) are 80 cm from EUT and at least 80 from other units and other metal planes**

**3.1.5 EUT OPERATING CONDITIONS**

The EUT was configured for testing in a typical fashion (as a customer would normally use it). The EUT has been programmed to continuously transmit during test. This operating condition was tested and used to collect the included data.



3.1.6 TEST RESULTS

Temperature:	26.7 °C	Relative Humidity:	65%
Test Voltage:	AC 120V/60Hz	Phase:	L
Test Mode :	Mode 25		

Frequency (MHz)	Reading (dBUV)	Correct Factor(dB)	Result (dBUV)	Limit (dBUV)	Margin (dB)	Remark
0.2020	31.12	9.79	40.91	63.53	-22.62	QP
0.2020	15.67	9.79	25.46	53.53	-28.07	AVG
0.2700	27.11	10.09	37.20	61.12	-23.92	QP
0.2700	11.77	10.09	21.86	51.12	-29.26	AVG
0.8300	26.37	9.83	36.20	56.00	-19.80	QP
0.8300	10.84	9.83	20.67	46.00	-25.33	AVG
3.9780	29.47	9.83	39.30	56.00	-16.70	QP
3.9780	14.27	9.83	24.10	46.00	-21.90	AVG
16.7340	22.34	10.32	32.66	60.00	-27.34	QP
16.7340	9.27	10.32	19.59	50.00	-30.41	AVG
26.5660	28.93	10.19	39.12	60.00	-20.88	QP
26.5660	9.94	10.19	20.13	50.00	-29.87	AVG

Remark:

1. All readings are Quasi-Peak and Average values.
2. Margin = Result (Result = Reading + Factor) – Limit

100.0 dBUV

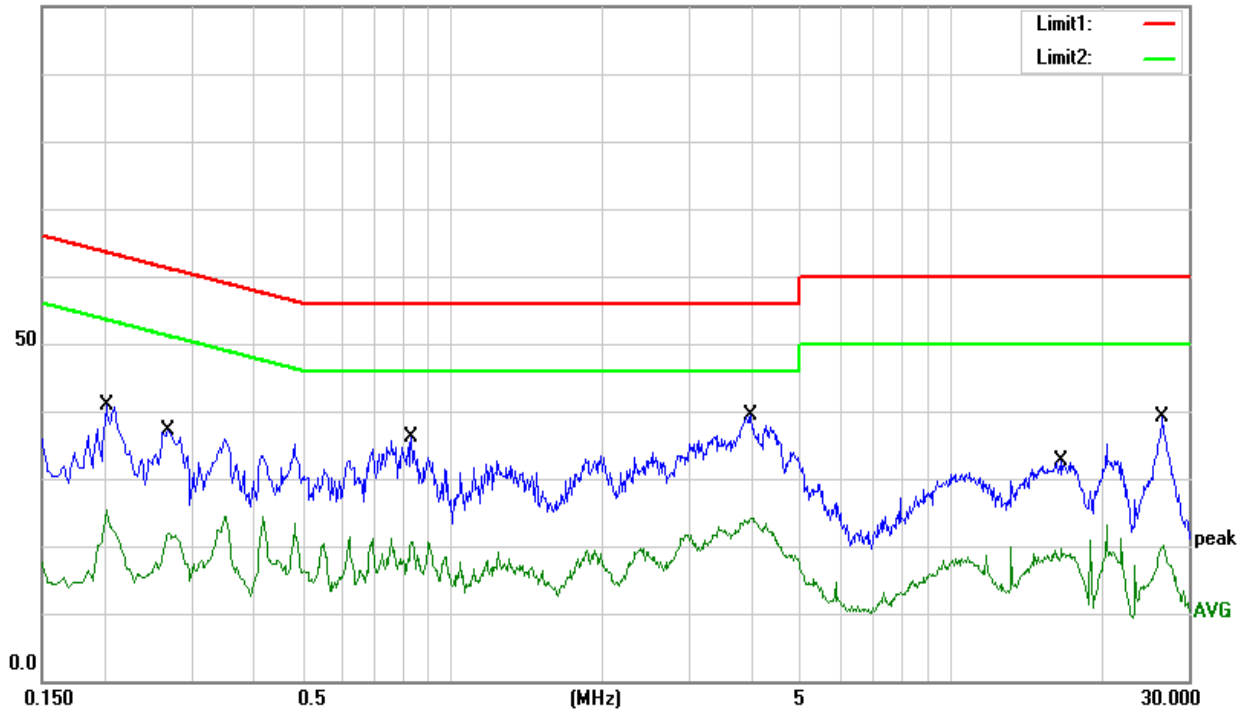





Temperature:	26.7 °C	Relative Humidity:	65%
Test Voltage:	AC 120V/60Hz	Phase:	N
Test Mode	Mode 25		

Frequency (MHz)	Reading (dBuV)	Correct Factor(dB)	Result (dBuV)	Limit (dBuV)	Margin (dB)	Remark
0.2020	32.14	9.79	41.93	63.53	-21.60	QP
0.2020	18.18	9.79	27.97	53.53	-25.56	AVG
0.2700	28.68	10.09	38.77	61.12	-22.35	QP
0.2700	14.81	10.09	24.90	51.12	-26.22	AVG
0.3420	28.96	10.14	39.10	59.15	-20.05	QP
0.3420	17.73	10.14	27.87	49.15	-21.28	AVG
0.5500	26.39	9.98	36.37	56.00	-19.63	QP
0.5500	13.33	9.98	23.31	46.00	-22.69	AVG
4.2740	25.97	9.84	35.81	56.00	-20.19	QP
4.2740	10.00	9.84	19.84	46.00	-26.16	AVG
26.7020	27.53	10.20	37.73	60.00	-22.27	QP
26.7020	9.06	10.20	19.26	50.00	-30.74	AVG

Remark:

1. All readings are Quasi-Peak and Average values.
2. Margin = Result (Result = Reading + Factor) - Limit

100.0 dBuV

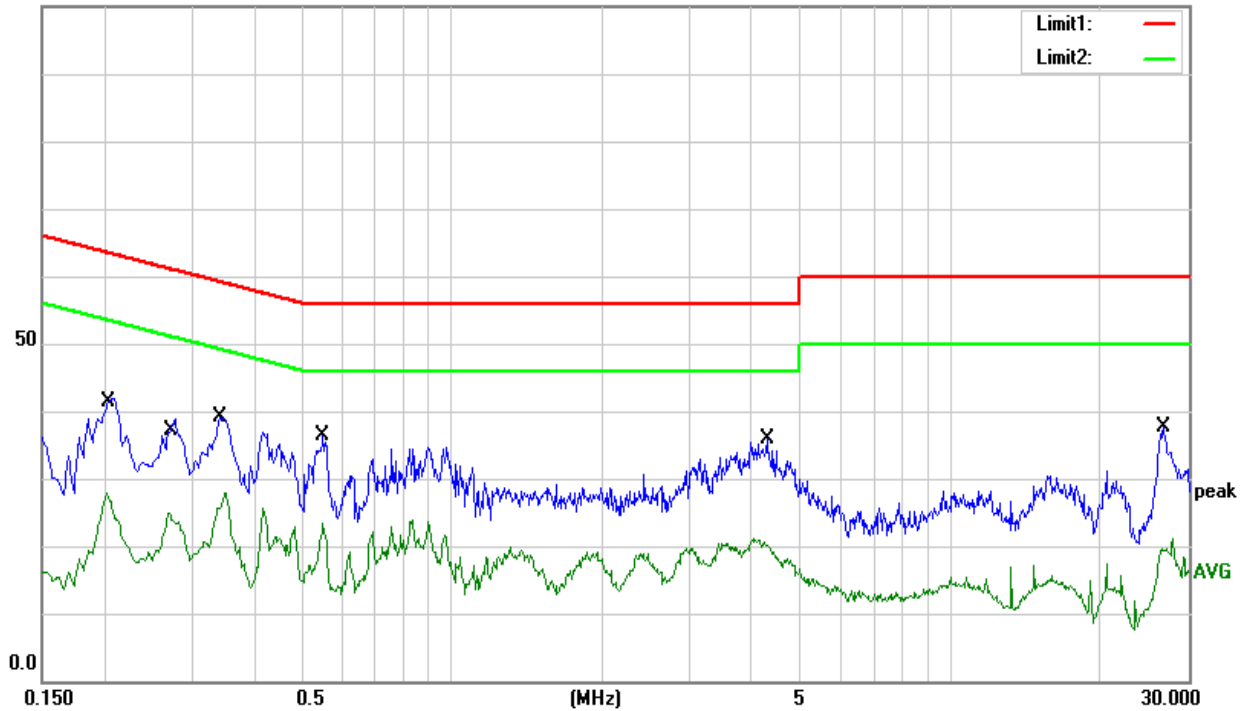

### 3.2 RADIATED EMISSION AND ( BANDEDGE) MEASUREMENT

#### 3.2.1 RADIATED EMISSION LIMITS (Frequency Range 9kHz-1000MHz)

In case the emission fall within the restricted band specified on 15.407(b)7& 15.205/209(a), then the (a); limit in the table below has to be followed.

Frequencies (MHz)	Field Strength (micorvolts/meter)	Measurement Distance (meters)
0.009~0.490	2400/F(KHz)	300
0.490~1.705	24000/F(KHz)	30
1.705~30.0	30	30
30~88	100	3
88~216	150	3
216~960	200	3
Above 960	500	3

#### LIMITS OF RADIATED EMISSION MEASUREMENT (Above 1000MHz)

FREQUENCY (MHz)	Class B (dBuV/m) (at 3M)	
	PEAK	AVERAGE
Above 1000	74	54

Notes:

- (1) The limit for radiated test was performed according to FCC PART 15E.
- (2) The tighter limit applies at the band edges.
- (3) Emission level (dBuV/m)=20log Emission level (uV/m).

Spectrum Parameter	Setting
Attenuation	Auto
Detector	Peak
Start Frequency	1000 MHz(Peak/AV)
Stop Frequency	10th carrier harmonic(Peak/AV)
RB / VB (emission in restricted band)	1 MHz / 1 MHz, AV=1 MHz /3 MHz

For Band edge

Spectrum Parameter	Setting
Detector	Peak
RB / VB (emission in restricted band)	1 MHz / 1 MHz, AV=1 MHz /3 MHz



Receiver Parameter	Setting
Attenuation	Auto
Start ~ Stop Frequency	9kHz~90kHz / RB 200Hz for PK & AV
Start ~ Stop Frequency	90kHz~110kHz / RB 200Hz for QP
Start ~ Stop Frequency	110kHz~490kHz / RB 200Hz for PK & AV
Start ~ Stop Frequency	490kHz~30MHz / RB 9kHz for QP
Start ~ Stop Frequency	30MHz~1000MHz / RB 120kHz for QP

### 3.2.2 TEST PROCEDURE

- The measuring distance of at 3 m shall be used for measurements at frequency 0.009MHz up to 1GHz. For frequencies above 1GHz, any suitable measuring distance may be used.
- The EUT was placed on the top of a rotating table 0.8 meters(above 1GHz is 1.5 m) above the ground at a 3 meter anechoic chamber. The table was rotated 360 degrees to determine the position of the highest radiation.
- The height of the equipment shall be 0.8 m(above 1GHz is 1.5 m); the height of the test antenna shall vary between 1 m to 4 m. Horizontal and vertical polarizations of the antenna are set to make the measurement
- The initial step in collecting conducted emission data is a spectrum analyzer peak detector mode pre-scanning the measurement frequency range. Significant peaks are then marked and then Quasi Peak detector mode re-measured.
- If the Peak Mode measured value compliance with and lower than Quasi Peak Mode Limit, the EUT shall be deemed to meet QP Limits and then no additional QP Mode measurement performed.
- For the actual test configuration, please refer to the related Item –EUT Test Photos.

Note:

Both horizontal and vertical antenna polarities were tested and performed test to three orthogonal axis. The worst case emissions were reported

### 3.2.3 DEVIATION FROM TEST STANDARD

No deviation

### 3.2.4 TEST SETUP

(A) Radiated Emission Test-Up Frequency Below 30MHz

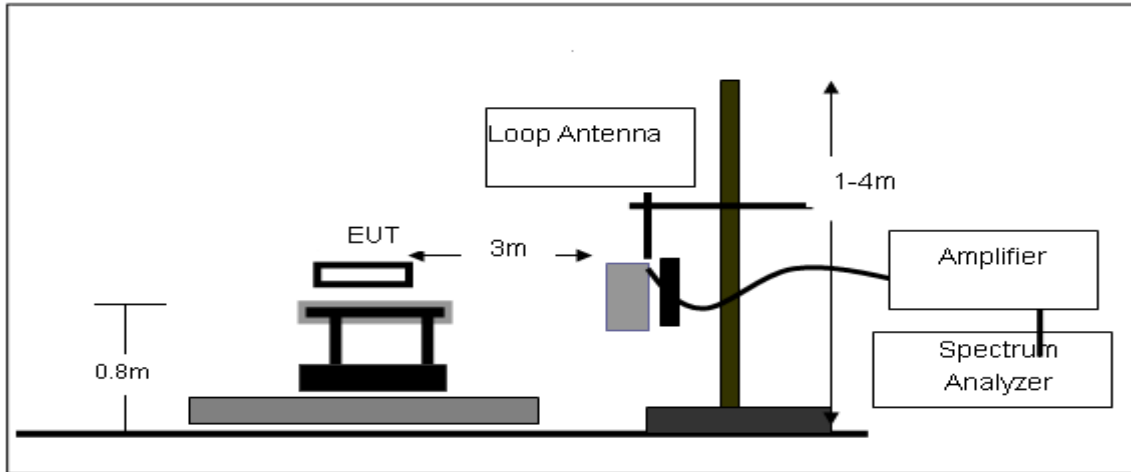

(B) Radiated Emission Test-Up Frequency 30MHz~1GHz

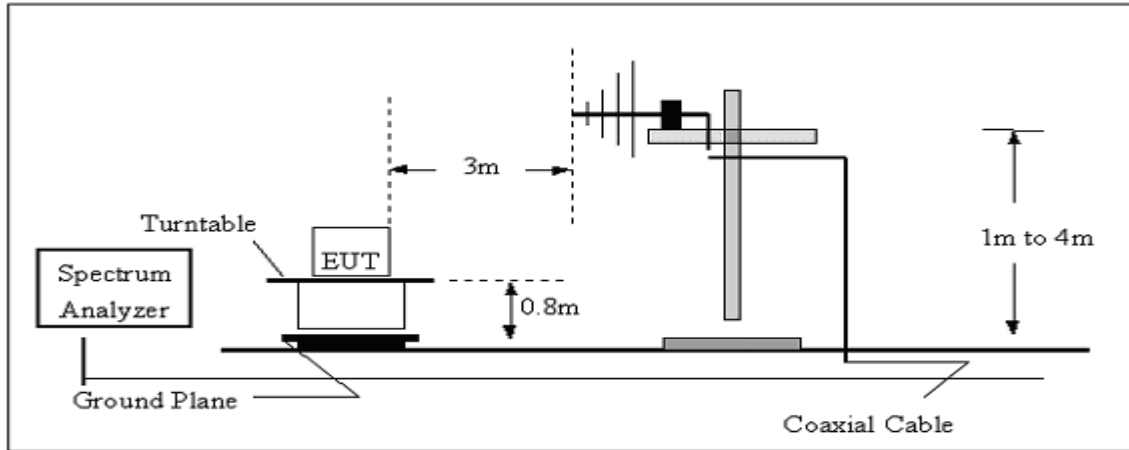

(C) Radiated Emission Test-Up Frequency Above 1GHz

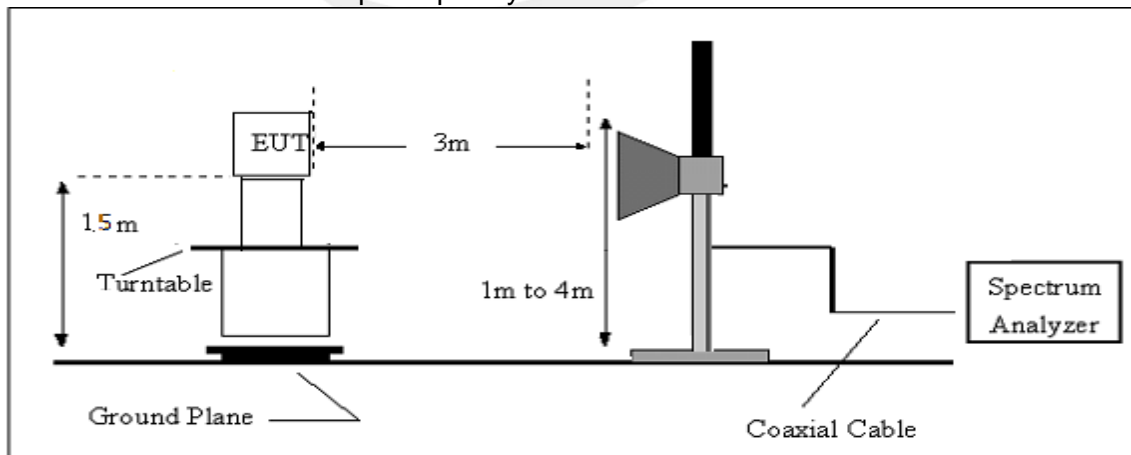

### 3.2.5 EUT OPERATING CONDITIONS

The EUT tested system was configured as the statements of 2.4 Unless otherwise a special operating condition is specified in the follows during the testing.



### 3.2.6 FIELD STRENGTH CALCULATION

The field strength is calculated by adding the Antenna Factor and Cable Factor and subtracting the Amplifier Gain and Duty Cycle Correction Factor (if any) from the measured reading. The basic equation with a sample calculation is as follows:

$$FS = RA + AF + CL - AG$$

Where

FS = Field Strength

CL = Cable Attenuation Factor (Cable Loss)

RA = Reading Amplitude

AG = Amplifier Gain

AF = Antenna Factor

For example

Frequency (MHz)	FS (dB $\mu$ V/m)	RA (dB $\mu$ V/m)	AF (dB)	CL (dB)	AG (dB)	Factor (dB)
300	40	58.1	12.2	1.6	31.9	-18.1

$$\text{Factor} = \text{AF} + \text{CL} - \text{AG}$$

### 3.2.7 TEST RESULTS (Between 9KHz – 30 MHz)

Temperature:	26.9°C	Relative Humidity:	60%
Test Voltage :	DC 3.7V from Battery	Test Mode :	TX Mode
Polarization :	--		

Freq. (MHz)	Reading (dBuV/m)	Limit (dBuV/m)	Margin (dB)	State P/F
--	--	--	--	PASS
--	--	--	--	PASS

Note:

The amplitude of spurious emissions which are attenuated by more than 20dB below the permissible value has no need to be reported.

Distance extrapolation factor =  $40 \log (\text{specific distance}/\text{test distance})(\text{dB})$ ;

Limit line = specific limits(dBuv) + distance extrapolation factor.



**3.2.8 TEST RESULTS (Between 30MHz – 1GHz)**

Temperature	26.9 °C	Relative Humidity	60%
Test Voltage	DC 3.7V from Battery	Polarization	Horizontal
Test Mode	Mode 1-24(Mode 5 worst mode)		

Frequency (MHz)	Reading (dBuV)	Correct Factor(dB/m)	Result (dBuV/m)	Limit (dBuV/m)	Margin (dB)	Remark
47.8260	47.09	-20.36	26.73	40.00	-13.27	QP
56.0007	45.14	-23.19	21.95	40.00	-18.05	QP
128.5630	41.90	-17.56	24.34	43.50	-19.16	QP
206.3976	40.46	-19.89	20.57	43.50	-22.93	QP
654.2318	33.83	-6.28	27.55	46.00	-18.45	QP
952.0937	33.14	-0.36	32.78	46.00	-13.22	QP

Remark:

1. Margin = Result (Result =Reading + Factor )–Limit

80.0 dBuV/m

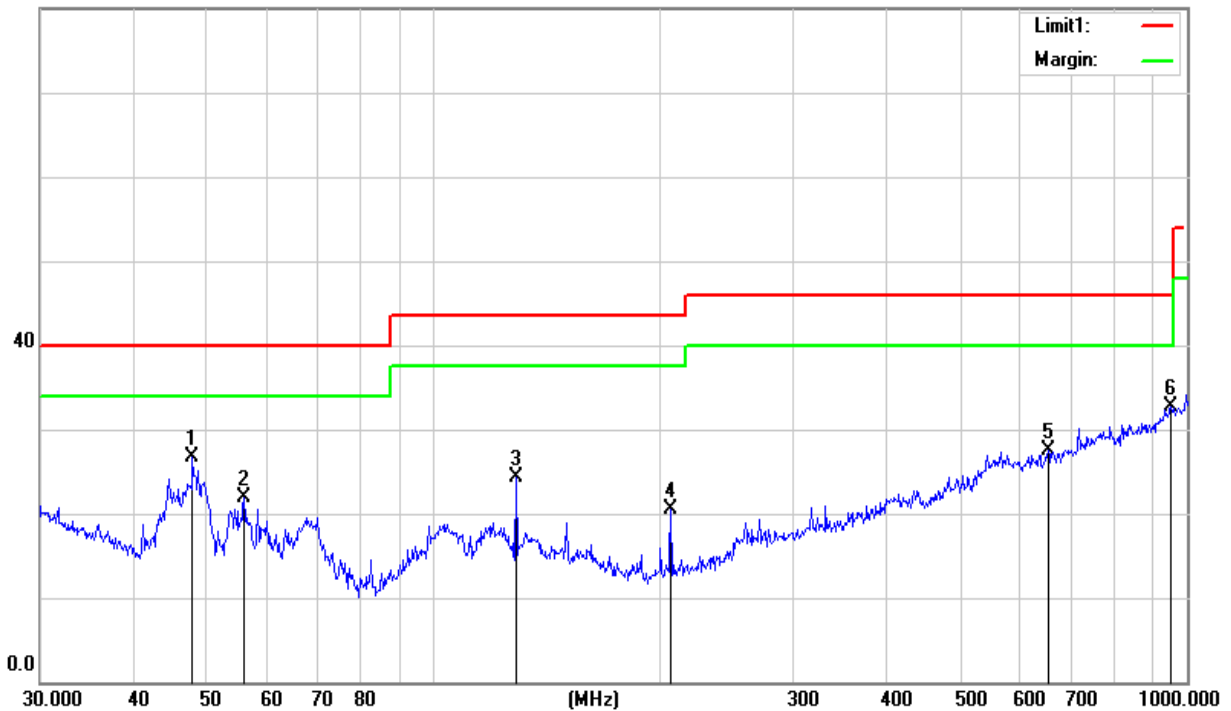



Temperature	26.9 °C	Relative Humidity	60%
Test Voltage	DC 3.7V from Battery	Polarization	Vertical
Test Mode	Mode 1-24(Mode 5 worst mode)		

Frequency (MHz)	Reading (dBuV)	Correct Factor(dB/m)	Result (dBuV/m)	Limit (dBuV/m)	Margin (dB)	Remark
40.4172	51.69	-16.55	35.14	40.00	-4.86	QP
66.4990	57.07	-24.19	32.88	40.00	-7.12	QP
130.3790	50.42	-17.55	32.87	43.50	-10.63	QP
261.0583	37.99	-15.09	22.90	46.00	-23.10	QP
455.9058	34.18	-10.29	23.89	46.00	-22.11	QP
958.7943	32.97	-0.16	32.81	46.00	-13.19	QP

Remark:

1. Margin = Result (Result =Reading + Factor )–Limit

80.0 dBuV/m

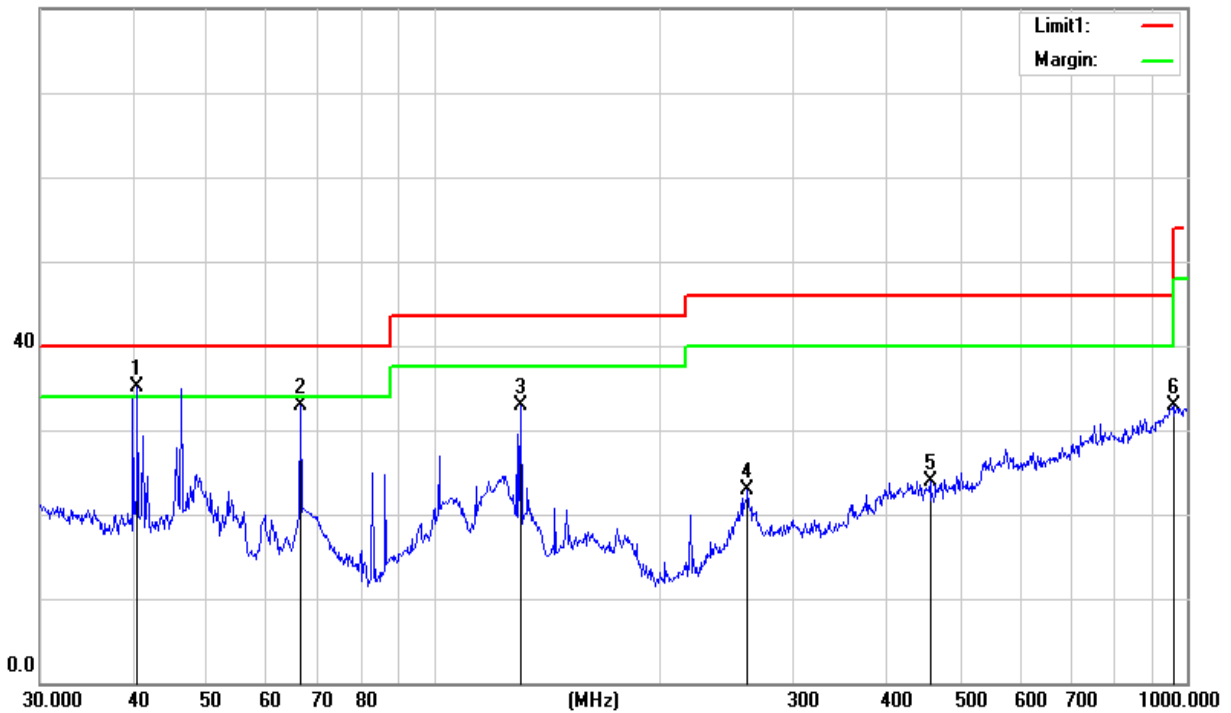



**3.2.9 TEST RESULTS (Above 1000 MHz)**

**Band I 5150-5250MHz**

Band I(5.15-5.25) GHz										
Frequency (MHz)	Reading	Amplifier	Loss	Antenna	Orrected	Emission	Limit (dBuV/m)	Margin	Detector	Comment
	(dBuV)	(dB)	(dB)	(dB/m)	Factor	Level		(dB)		
Low Channel (802.11n20/ 5180 MHz)										
3248.12	44.62	44.70	6.70	28.20	-9.80	34.82	74.00	-39.18	PK	Vertical
3248.12	41.37	44.70	6.70	28.20	-9.80	31.57	54.00	-22.43	AV	Vertical
3253.24	43.91	44.70	6.70	28.20	-9.80	34.11	74.00	-39.89	PK	Horizontal
3253.24	42.06	44.70	6.70	28.20	-9.80	32.26	54.00	-21.74	AV	Horizontal
3998.15	39.91	44.20	7.90	29.70	-6.60	33.31	74.00	-40.69	PK	Vertical
3998.15	35.97	44.20	7.90	29.70	-6.60	29.37	54.00	-24.63	AV	Vertical
3986.04	38.86	44.20	7.90	29.70	-6.60	32.26	74.00	-41.74	PK	Horizontal
3986.04	36.03	44.20	7.90	29.70	-6.60	29.43	54.00	-24.57	AV	Horizontal
7223.95	37.55	43.50	11.40	35.50	3.40	40.95	74.00	-33.05	PK	Vertical
7223.95	34.10	43.50	11.40	35.50	3.40	37.50	54.00	-16.50	AV	Vertical
7225.54	37.44	43.50	11.40	35.50	3.40	40.84	74.00	-33.16	PK	Horizontal
7225.54	34.14	43.50	11.40	35.50	3.40	37.54	54.00	-16.46	AV	Horizontal
10360.18	38.72	44.50	13.80	38.80	8.10	46.82	74.00	-27.18	PK	Vertical
10360.18	37.02	44.50	13.80	38.80	8.10	45.12	54.00	-8.88	AV	Vertical
10360.19	39.03	44.50	13.80	38.80	8.10	47.13	74.00	-26.87	PK	Horizontal
10360.19	36.41	44.50	13.80	38.80	8.10	44.51	54.00	-9.49	AV	Horizontal
11022.03	32.98	43.60	14.30	39.50	10.20	43.18	74.00	-30.82	PK	Vertical
11022.03	30.40	43.60	14.30	39.50	10.20	40.60	54.00	-13.40	AV	Vertical
11018.68	33.59	43.60	14.30	39.50	10.20	43.79	74.00	-30.21	PK	Horizontal
11018.68	30.56	43.60	14.30	39.50	10.20	40.76	54.00	-13.24	AV	Horizontal
13288.25	32.98	42.60	15.90	38.90	12.20	45.18	74.00	-28.82	PK	Vertical
13288.25	29.46	42.60	15.90	38.90	12.20	41.66	54.00	-12.34	AV	Vertical
13290.23	31.91	42.60	15.90	38.90	12.20	44.11	74.00	-29.89	PK	Horizontal
13290.23	28.59	42.60	15.90	38.90	12.20	40.79	54.00	-13.21	AV	Horizontal





Mid Channel (802.11 n20/ 5200 MHz)										
3264.66	44.01	44.70	6.70	28.20	-9.80	34.21	74.00	-39.79	PK	Vertical
3264.66	41.35	44.70	6.70	28.20	-9.80	31.55	54.00	-22.45	AV	Vertical
3261.00	43.88	44.70	6.70	28.20	-9.80	34.08	74.00	-39.92	PK	Horizontal
3261.00	41.55	44.70	6.70	28.20	-9.80	31.75	54.00	-22.25	AV	Horizontal
3995.36	40.10	44.20	7.90	29.70	-6.60	33.50	74.00	-40.50	PK	Vertical
3995.36	36.27	44.20	7.90	29.70	-6.60	29.67	54.00	-24.33	AV	Vertical
3998.33	39.59	44.20	7.90	29.70	-6.60	32.99	74.00	-41.01	PK	Horizontal
3998.33	36.94	44.20	7.90	29.70	-6.60	30.34	54.00	-23.66	AV	Horizontal
7221.94	37.14	43.50	11.40	35.50	3.40	40.54	74.00	-33.46	PK	Vertical
7221.94	34.38	43.50	11.40	35.50	3.40	37.78	54.00	-16.22	AV	Vertical
7230.58	37.59	43.50	11.40	35.50	3.40	40.99	74.00	-33.01	PK	Horizontal
7230.58	34.81	43.50	11.40	35.50	3.40	38.21	54.00	-15.79	AV	Horizontal
10400.25	39.76	44.50	13.80	38.80	8.10	47.86	74.00	-26.14	PK	Vertical
10400.25	36.65	44.50	13.80	38.80	8.10	44.75	54.00	-9.25	AV	Vertical
10400.13	39.22	44.50	13.80	38.80	8.10	47.32	74.00	-26.68	PK	Horizontal
10400.13	35.70	44.50	13.80	38.80	8.10	43.80	54.00	-10.20	AV	Horizontal
11033.45	32.76	43.60	14.30	39.50	10.20	42.96	74.00	-31.04	PK	Vertical
11033.45	30.04	43.60	14.30	39.50	10.20	40.24	54.00	-13.76	AV	Vertical
11022.86	33.58	43.60	14.30	39.50	10.20	43.78	74.00	-30.22	PK	Horizontal
11022.86	30.37	43.60	14.30	39.50	10.20	40.57	54.00	-13.43	AV	Horizontal
13291.02	32.63	42.60	15.90	38.90	12.20	44.83	74.00	-29.17	PK	Vertical
13291.02	28.75	42.60	15.90	38.90	12.20	40.95	54.00	-13.05	AV	Vertical
13287.58	32.43	42.60	15.90	38.90	12.20	44.63	74.00	-29.37	PK	Horizontal
13287.58	28.68	42.60	15.90	38.90	12.20	40.88	54.00	-13.12	AV	Horizontal



High Channel (802.11 n20/ 5240 MHz)										
3260.99	44.47	44.70	6.70	28.20	-9.80	34.67	74.00	-39.33	PK	Vertical
3260.99	41.03	44.70	6.70	28.20	-9.80	31.23	54.00	-22.77	AV	Vertical
3259.50	45.15	44.70	6.70	28.20	-9.80	35.35	74.00	-38.65	PK	Horizontal
3259.50	41.92	44.70	6.70	28.20	-9.80	32.12	54.00	-21.88	AV	Horizontal
3987.20	39.38	44.20	7.90	29.70	-6.60	32.78	74.00	-41.22	PK	Vertical
3987.20	35.75	44.20	7.90	29.70	-6.60	29.15	54.00	-24.85	AV	Vertical
3999.32	39.07	44.20	7.90	29.70	-6.60	32.47	74.00	-41.53	PK	Horizontal
3999.32	36.60	44.20	7.90	29.70	-6.60	30.00	54.00	-24.00	AV	Horizontal
7217.38	36.42	43.50	11.40	35.50	3.40	39.82	74.00	-34.18	PK	Vertical
7217.38	34.68	43.50	11.40	35.50	3.40	38.08	54.00	-15.92	AV	Vertical
7224.85	37.58	43.50	11.40	35.50	3.40	40.98	74.00	-33.02	PK	Horizontal
7224.85	34.73	43.50	11.40	35.50	3.40	38.13	54.00	-15.87	AV	Horizontal
10480.25	39.94	44.50	13.80	38.80	8.10	48.04	74.00	-25.96	PK	Vertical
10480.25	36.06	44.50	13.80	38.80	8.10	44.16	54.00	-9.84	AV	Vertical
10480.13	38.95	44.50	13.80	38.80	8.10	47.05	74.00	-26.95	PK	Horizontal
10480.13	36.67	44.50	13.80	38.80	8.10	44.77	54.00	-9.23	AV	Horizontal
11034.10	33.97	43.60	14.30	39.50	10.20	44.17	74.00	-29.83	PK	Vertical
11034.10	30.85	43.60	14.30	39.50	10.20	41.05	54.00	-12.95	AV	Vertical
11023.41	33.59	43.60	14.30	39.50	10.20	43.79	74.00	-30.21	PK	Horizontal
11023.41	30.86	43.60	14.30	39.50	10.20	41.06	54.00	-12.94	AV	Horizontal
13295.68	31.76	42.60	15.90	38.90	12.20	43.96	74.00	-30.04	PK	Vertical
13295.68	28.57	42.60	15.90	38.90	12.20	40.77	54.00	-13.23	AV	Vertical
13296.38	32.66	42.60	15.90	38.90	12.20	44.86	74.00	-29.14	PK	Horizontal
13296.38	29.76	42.60	15.90	38.90	12.20	41.96	54.00	-12.04	AV	Horizontal

**Remark:**

1. Factor = Antenna Factor + Cable Loss – Pre-amplifier.
2. Scan with 802.11a, 802.11n (HT-20), 802.11n (HT-40), 802.11ac (HT-20), 802.11ac (HT-40), 802.11ac (HT-80) the worst case is 802.11n (HT-20).
3. The frequency emission of peak points that did not show above the forms are at least 20dB below the limit, the frequency emission is mainly from the environment noise.
4. Pre-scan both the SISO and MIMO mode, only the worst-case results were reported



**Band II 5250-5350MHz**

Band II(5.25-5.35) GHz										
Frequency (MHz)	Reading	Amplifier	Loss	Antenna Factor	Orrected Factor	Emission Level	Limit (dBuV/m)	Margin	Detector	Comment
	(dBuV)	(dB)	(dB)	(dB/m)	(dB)	(dBμV/m)		(dB)		
Low Channel (802.11 ac20/ 5260 MHz)										
3253.27	44.64	44.70	6.70	28.20	-9.80	34.84	74.00	-39.16	PK	Vertical
3253.27	40.99	44.70	6.70	28.20	-9.80	31.19	54.00	-22.81	AV	Vertical
3248.90	44.47	44.70	6.70	28.20	-9.80	34.67	74.00	-39.33	PK	Horizontal
3248.90	41.10	44.70	6.70	28.20	-9.80	31.30	54.00	-22.70	AV	Horizontal
3980.74	39.38	44.20	7.90	29.70	-6.60	32.78	74.00	-41.22	PK	Vertical
3980.74	36.99	44.20	7.90	29.70	-6.60	30.39	54.00	-23.61	AV	Vertical
3985.46	38.80	44.20	7.90	29.70	-6.60	32.20	74.00	-41.80	PK	Horizontal
3985.46	36.39	44.20	7.90	29.70	-6.60	29.79	54.00	-24.21	AV	Horizontal
7227.26	36.86	43.50	11.40	35.50	3.40	40.26	74.00	-33.74	PK	Vertical
7227.26	34.64	43.50	11.40	35.50	3.40	38.04	54.00	-15.96	AV	Vertical
7222.51	37.93	43.50	11.40	35.50	3.40	41.33	74.00	-32.67	PK	Horizontal
7222.51	34.29	43.50	11.40	35.50	3.40	37.69	54.00	-16.31	AV	Horizontal
10520.36	39.50	44.50	13.90	38.80	8.20	47.70	74.00	-26.30	PK	Vertical
10520.36	36.02	44.50	13.90	38.80	8.20	44.22	54.00	-9.78	AV	Vertical
10520.15	39.86	44.50	13.90	38.80	8.20	48.06	74.00	-25.94	PK	Horizontal
10520.15	35.95	44.50	13.90	38.80	8.20	44.15	54.00	-9.85	AV	Horizontal
11028.21	33.44	43.60	14.30	39.50	10.20	43.64	74.00	-30.36	PK	Vertical
11028.21	29.93	43.60	14.30	39.50	10.20	40.13	54.00	-13.87	AV	Vertical
11024.16	32.79	43.60	14.30	39.50	10.20	42.99	74.00	-31.01	PK	Horizontal
11024.16	30.47	43.60	14.30	39.50	10.20	40.67	54.00	-13.33	AV	Horizontal
13286.23	31.59	42.60	15.90	38.90	12.20	43.79	74.00	-30.21	PK	Vertical
13286.23	29.18	42.60	15.90	38.90	12.20	41.38	54.00	-12.62	AV	Vertical
13292.84	32.43	42.60	15.90	38.90	12.20	44.63	74.00	-29.37	PK	Horizontal
13292.84	28.86	42.60	15.90	38.90	12.20	41.06	54.00	-12.94	AV	Horizontal



Mid Channel (802.11 ac20/ 5300 MHz)										
3259.89	45.22	44.70	6.70	28.20	-9.80	35.42	74.00	-38.58	PK	Vertical
3259.89	41.97	44.70	6.70	28.20	-9.80	32.17	54.00	-21.83	AV	Vertical
3256.92	44.17	44.70	6.70	28.20	-9.80	34.37	74.00	-39.63	PK	Horizontal
3256.92	41.57	44.70	6.70	28.20	-9.80	31.77	54.00	-22.23	AV	Horizontal
3988.60	39.17	44.20	7.90	29.70	-6.60	32.57	74.00	-41.43	PK	Vertical
3988.60	36.51	44.20	7.90	29.70	-6.60	29.91	54.00	-24.09	AV	Vertical
3985.05	38.90	44.20	7.90	29.70	-6.60	32.30	74.00	-41.70	PK	Horizontal
3985.05	36.03	44.20	7.90	29.70	-6.60	29.43	54.00	-24.57	AV	Horizontal
7234.91	36.95	43.50	11.40	35.50	3.40	40.35	74.00	-33.65	PK	Vertical
7234.91	34.29	43.50	11.40	35.50	3.40	37.69	54.00	-16.31	AV	Vertical
7231.61	37.16	43.50	11.40	35.50	3.40	40.56	74.00	-33.44	PK	Horizontal
7231.61	34.43	43.50	11.40	35.50	3.40	37.83	54.00	-16.17	AV	Horizontal
10600.39	38.94	44.50	13.80	38.80	8.10	47.04	74.00	-26.96	PK	Vertical
10600.39	36.82	44.50	13.80	38.80	8.10	44.92	54.00	-9.08	AV	Vertical
10600.16	38.80	44.50	13.80	38.80	8.10	46.90	74.00	-27.10	PK	Horizontal
10600.16	35.74	44.50	13.80	38.80	8.10	43.84	54.00	-10.16	AV	Horizontal
11022.01	33.99	43.60	14.30	39.50	10.20	44.19	74.00	-29.81	PK	Vertical
11022.01	30.15	43.60	14.30	39.50	10.20	40.35	54.00	-13.65	AV	Vertical
11034.04	33.70	43.60	14.30	39.50	10.20	43.90	74.00	-30.10	PK	Horizontal
11034.04	30.43	43.60	14.30	39.50	10.20	40.63	54.00	-13.37	AV	Horizontal
13297.56	32.48	42.60	15.90	38.90	12.20	44.68	74.00	-29.32	PK	Vertical
13297.56	28.87	42.60	15.90	38.90	12.20	41.07	54.00	-12.93	AV	Vertical
13294.17	31.99	42.60	15.90	38.90	12.20	44.19	74.00	-29.81	PK	Horizontal
13294.17	29.12	42.60	15.90	38.90	12.20	41.32	54.00	-12.68	AV	Horizontal



High Channel (802.11 ac20/ 5320 MHz)										
3247.04	45.09	44.70	6.70	28.20	-9.80	35.29	74.00	-38.71	PK	Vertical
3247.04	41.74	44.70	6.70	28.20	-9.80	31.94	54.00	-22.06	AV	Vertical
3255.30	44.08	44.70	6.70	28.20	-9.80	34.28	74.00	-39.72	PK	Horizontal
3255.30	41.25	44.70	6.70	28.20	-9.80	31.45	54.00	-22.55	AV	Horizontal
3982.81	39.23	44.20	7.90	29.70	-6.60	32.63	74.00	-41.37	PK	Vertical
3982.81	36.57	44.20	7.90	29.70	-6.60	29.97	54.00	-24.03	AV	Vertical
3990.08	38.90	44.20	7.90	29.70	-6.60	32.30	74.00	-41.70	PK	Horizontal
3990.08	35.99	44.20	7.90	29.70	-6.60	29.39	54.00	-24.61	AV	Horizontal
7221.60	36.68	43.50	11.40	35.50	3.40	40.08	74.00	-33.92	PK	Vertical
7221.60	33.81	43.50	11.40	35.50	3.40	37.21	54.00	-16.79	AV	Vertical
7235.73	37.53	43.50	11.40	35.50	3.40	40.93	74.00	-33.07	PK	Horizontal
7235.73	34.95	43.50	11.40	35.50	3.40	38.35	54.00	-15.65	AV	Horizontal
10640.15	38.97	44.50	13.80	38.80	8.10	47.07	74.00	-26.93	PK	Vertical
10640.15	36.59	44.50	13.80	38.80	8.10	44.69	54.00	-9.31	AV	Vertical
10640.17	40.08	44.50	13.80	38.80	8.10	48.18	74.00	-25.82	PK	Horizontal
10640.17	35.99	44.50	13.80	38.80	8.10	44.09	54.00	-9.91	AV	Horizontal
11023.13	33.70	43.60	14.30	39.50	10.20	43.90	74.00	-30.10	PK	Vertical
11023.13	30.32	43.60	14.30	39.50	10.20	40.52	54.00	-13.48	AV	Vertical
11033.32	33.22	43.60	14.30	39.50	10.20	43.42	74.00	-30.58	PK	Horizontal
11033.32	30.41	43.60	14.30	39.50	10.20	40.61	54.00	-13.39	AV	Horizontal
13284.82	32.89	42.70	18.00	37.10	12.40	45.29	74.00	-28.71	PK	Vertical
13284.82	29.47	42.70	18.00	37.10	12.40	41.87	54.00	-12.13	AV	Vertical
13284.53	32.43	42.70	18.00	37.10	12.40	44.83	74.00	-29.17	PK	Horizontal
13284.53	29.62	42.70	18.00	37.10	12.40	42.02	54.00	-11.98	AV	Horizontal

## Remark:

1. Factor = Antenna Factor + Cable Loss – Pre-amplifier.
2. Scan with 802.11a,802.11n (HT-20),802.11n (HT-40), 802.11ac (HT-20),802.11ac (HT-40), 802.11ac (HT-80) the worst case is 802.11ac (HT-20).
3. The frequency emission of peak points that did not show above the forms are at least 20dB below the limit, the frequency emission is mainly from the environment noise.
4. Pre-scan both the SISO and MIMO mode, only the worst-case results were reported



**Band III 5470-5725MHz**

Band III(5.47-5.725) GHz										
Frequency (MHz)	Reading	Amplifier	Loss	Antenna Factor	Orrected Factor	Emission Level	Limit (dBuV/m)	Margin	Detector	Comment
	(dBuV)	(dB)	(dB)	(dB/m)	(dB)	(dBμV/m)		(dB)		
Low Channel (802.11 n20/ 5500 MHz)										
3249.03	44.45	44.70	6.70	28.20	-9.80	34.65	74.00	-39.35	PK	Vertical
3249.03	41.61	44.70	6.70	28.20	-9.80	31.81	54.00	-22.19	AV	Vertical
3246.29	44.30	44.70	6.70	28.20	-9.80	34.50	74.00	-39.50	PK	Horizontal
3246.29	41.07	44.70	6.70	28.20	-9.80	31.27	54.00	-22.73	AV	Horizontal
3998.06	39.83	44.20	7.90	29.70	-6.60	33.23	74.00	-40.77	PK	Vertical
3998.06	36.26	44.20	7.90	29.70	-6.60	29.66	54.00	-24.34	AV	Vertical
3989.70	39.79	44.20	7.90	29.70	-6.60	33.19	74.00	-40.81	PK	Horizontal
3989.70	35.91	44.20	7.90	29.70	-6.60	29.31	54.00	-24.69	AV	Horizontal
7218.71	36.62	43.50	11.40	35.50	3.40	40.02	74.00	-33.98	PK	Vertical
7218.71	34.90	43.50	11.40	35.50	3.40	38.30	54.00	-15.70	AV	Vertical
7222.04	37.02	43.50	11.40	35.50	3.40	40.42	74.00	-33.58	PK	Horizontal
7222.04	34.25	43.50	11.40	35.50	3.40	37.65	54.00	-16.35	AV	Horizontal
10358.41	39.95	44.50	13.80	38.80	8.10	48.05	74.00	-25.95	PK	Vertical
10358.41	36.05	44.50	13.80	38.80	8.10	44.15	54.00	-9.85	AV	Vertical
10341.70	39.19	44.50	13.80	38.80	8.10	47.29	74.00	-26.71	PK	Horizontal
10341.70	35.75	44.50	13.80	38.80	8.10	43.85	54.00	-10.15	AV	Horizontal
11000.22	32.87	43.60	14.30	39.50	10.20	43.07	74.00	-30.93	PK	Vertical
11000.22	30.83	43.60	14.30	39.50	10.20	41.03	54.00	-12.97	AV	Vertical
11000.18	32.76	43.60	14.30	39.50	10.20	42.96	74.00	-31.04	PK	Horizontal
11000.18	30.14	43.60	14.30	39.50	10.20	40.34	54.00	-13.66	AV	Horizontal
13289.49	32.68	42.60	15.90	38.90	12.20	44.88	74.00	-29.12	PK	Vertical
13289.49	29.17	42.60	15.90	38.90	12.20	41.37	54.00	-12.63	AV	Vertical
13285.27	31.90	42.60	15.90	38.90	12.20	44.10	74.00	-29.90	PK	Horizontal
13285.27	29.23	42.60	15.90	38.90	12.20	41.43	54.00	-12.57	AV	Horizontal



Mid Channel (802.11 n20/ 5580 MHz)										
3257.47	45.07	44.70	6.70	28.20	-9.80	35.27	74.00	-38.73	PK	Vertical
3257.47	41.55	44.70	6.70	28.20	-9.80	31.75	54.00	-22.25	AV	Vertical
3248.46	45.10	44.70	6.70	28.20	-9.80	35.30	74.00	-38.70	PK	Horizontal
3248.46	40.79	44.70	6.70	28.20	-9.80	30.99	54.00	-23.01	AV	Horizontal
3992.40	39.54	44.20	7.90	29.70	-6.60	32.94	74.00	-41.06	PK	Vertical
3992.40	37.09	44.20	7.90	29.70	-6.60	30.49	54.00	-23.51	AV	Vertical
3988.25	40.08	44.20	7.90	29.70	-6.60	33.48	74.00	-40.52	PK	Horizontal
3988.25	36.85	44.20	7.90	29.70	-6.60	30.25	54.00	-23.75	AV	Horizontal
7221.80	37.02	43.50	11.40	35.50	3.40	40.42	74.00	-33.58	PK	Vertical
7221.80	33.59	43.50	11.40	35.50	3.40	36.99	54.00	-17.01	AV	Vertical
7235.06	37.30	43.50	11.40	35.50	3.40	40.70	74.00	-33.30	PK	Horizontal
7235.06	33.82	43.50	11.40	35.50	3.40	37.22	54.00	-16.78	AV	Horizontal
10388.62	39.05	44.50	13.80	38.80	8.10	47.15	74.00	-26.85	PK	Vertical
10388.62	35.72	44.50	13.80	38.80	8.10	43.82	54.00	-10.18	AV	Vertical
10384.82	38.73	44.50	13.80	38.80	8.10	46.83	74.00	-27.17	PK	Horizontal
10384.82	36.86	44.50	13.80	38.80	8.10	44.96	54.00	-9.04	AV	Horizontal
11160.35	32.76	43.60	14.30	39.50	10.20	42.96	74.00	-31.04	PK	Vertical
11160.35	30.58	43.60	14.30	39.50	10.20	40.78	54.00	-13.22	AV	Vertical
11160.40	32.79	43.60	14.30	39.50	10.20	42.99	74.00	-31.01	PK	Horizontal
11160.40	29.80	43.60	14.30	39.50	10.20	40.00	54.00	-14.00	AV	Horizontal
13285.10	33.01	42.60	15.90	38.90	12.20	45.21	74.00	-28.79	PK	Vertical
13285.10	29.97	42.60	15.90	38.90	12.20	42.17	54.00	-11.83	AV	Vertical
13290.78	32.33	42.60	15.90	38.90	12.20	44.53	74.00	-29.47	PK	Horizontal
13290.78	29.14	42.60	15.90	38.90	12.20	41.34	54.00	-12.66	AV	Horizontal



High Channel (802.11 n20/ 5700 MHz)										
3253.86	44.57	44.70	6.70	28.20	-9.80	34.77	74.00	-39.23	PK	Vertical
3253.86	41.09	44.70	6.70	28.20	-9.80	31.29	54.00	-22.71	AV	Vertical
3253.59	44.90	44.70	6.70	28.20	-9.80	35.10	74.00	-38.90	PK	Horizontal
3253.59	40.94	44.70	6.70	28.20	-9.80	31.14	54.00	-22.86	AV	Horizontal
3988.11	39.74	44.20	7.90	29.70	-6.60	33.14	74.00	-40.86	PK	Vertical
3988.11	35.92	44.20	7.90	29.70	-6.60	29.32	54.00	-24.68	AV	Vertical
3991.00	39.33	44.20	7.90	29.70	-6.60	32.73	74.00	-41.27	PK	Horizontal
3991.00	35.85	44.20	7.90	29.70	-6.60	29.25	54.00	-24.75	AV	Horizontal
7220.62	37.82	43.50	11.40	35.50	3.40	41.22	74.00	-32.78	PK	Vertical
7220.62	34.09	43.50	11.40	35.50	3.40	37.49	54.00	-16.51	AV	Vertical
7226.15	36.98	43.50	11.40	35.50	3.40	40.38	74.00	-33.62	PK	Horizontal
7226.15	34.58	43.50	11.40	35.50	3.40	37.98	54.00	-16.02	AV	Horizontal
10473.23	39.02	44.50	13.80	38.80	8.10	47.12	74.00	-26.88	PK	Vertical
10473.23	37.10	44.50	13.80	38.80	8.10	45.20	54.00	-8.80	AV	Vertical
10461.95	39.47	44.50	13.80	38.80	8.10	47.57	74.00	-26.43	PK	Horizontal
10461.95	37.12	44.50	13.80	38.80	8.10	45.22	54.00	-8.78	AV	Horizontal
11400.22	33.55	43.60	14.30	39.50	10.20	43.75	74.00	-30.25	PK	Vertical
11400.22	30.89	43.60	14.30	39.50	10.20	41.09	54.00	-12.91	AV	Vertical
11400.29	33.51	43.60	14.30	39.50	10.20	43.71	74.00	-30.29	PK	Horizontal
11400.29	29.99	43.60	14.30	39.50	10.20	40.19	54.00	-13.81	AV	Horizontal
13295.59	32.87	42.60	15.90	38.90	12.20	45.07	74.00	-28.93	PK	Vertical
13295.59	29.43	42.60	15.90	38.90	12.20	41.63	54.00	-12.37	AV	Vertical
13295.90	32.25	42.60	15.90	38.90	12.20	44.45	74.00	-29.55	PK	Horizontal
13295.90	29.48	42.60	15.90	38.90	12.20	41.68	54.00	-12.32	AV	Horizontal

**Remark:**

1. Factor = Antenna Factor + Cable Loss – Pre-amplifier.
2. Scan with 802.11a, 802.11n (HT-20), 802.11n (HT-40), 802.11ac (HT-20), 802.11ac (HT-40), 802.11ac (HT-80) the worst case is 802.11n (HT-20).
3. The frequency emission of peak points that did not show above the forms are at least 20dB below the limit, the frequency emission is mainly from the environment noise.
4. Pre-scan both the SISO and MIMO mode, only the worst-case results were reported





**Band IV(5.725-5.850) GHz**

Band IV(5.725-5.85) GHz										
Frequency (MHz)	Reading	Amplifier	Loss	Antenna	Orrected	Emission	Limit (dBuV/m)	Margin	Detector	Comment
	(dBuV)	(dB)	(dB)	(dB/m)	Factor	Factor		Level (dBμV/m)		
Low Channel (802.11 n20/ 5745 MHz)										
3265.13	44.06	44.70	6.70	28.20	-9.80	34.26	74.00	-39.74	PK	Vertical
3265.13	41.95	44.70	6.70	28.20	-9.80	32.15	54.00	-21.85	AV	Vertical
3254.92	44.59	44.70	6.70	28.20	-9.80	34.79	74.00	-39.21	PK	Horizontal
3254.92	41.34	44.70	6.70	28.20	-9.80	31.54	54.00	-22.46	AV	Horizontal
3991.39	39.73	44.20	7.90	29.70	-6.60	33.13	74.00	-40.87	PK	Vertical
3991.39	36.96	44.20	7.90	29.70	-6.60	30.36	54.00	-23.64	AV	Vertical
3991.83	38.65	44.20	7.90	29.70	-6.60	32.05	74.00	-41.95	PK	Horizontal
3991.83	37.12	44.20	7.90	29.70	-6.60	30.52	54.00	-23.48	AV	Horizontal
7219.94	37.87	43.50	11.40	35.50	3.40	41.27	74.00	-32.73	PK	Vertical
7219.94	33.78	43.50	11.40	35.50	3.40	37.18	54.00	-16.82	AV	Vertical
7229.54	37.68	43.50	11.40	35.50	3.40	41.08	74.00	-32.92	PK	Horizontal
7229.54	34.72	43.50	11.40	35.50	3.40	38.12	54.00	-15.88	AV	Horizontal
10517.89	39.37	44.50	13.90	38.80	8.20	47.57	74.00	-26.43	PK	Vertical
10517.89	35.69	44.50	13.90	38.80	8.20	43.89	54.00	-10.11	AV	Vertical
10517.55	39.13	44.50	13.90	38.80	8.20	47.33	74.00	-26.67	PK	Horizontal
10517.55	35.99	44.50	13.90	38.80	8.20	44.19	54.00	-9.81	AV	Horizontal
11490.03	33.33	43.60	14.30	39.50	10.20	43.53	74.00	-30.47	PK	Vertical
11490.03	30.52	43.60	14.30	39.50	10.20	40.72	54.00	-13.28	AV	Vertical
11490.01	33.34	43.60	14.30	39.50	10.20	43.54	74.00	-30.46	PK	Horizontal
11490.01	29.79	43.60	14.30	39.50	10.20	39.99	54.00	-14.01	AV	Horizontal
13299.60	31.59	42.60	15.90	38.90	12.20	43.79	74.00	-30.21	PK	Vertical
13299.60	28.77	42.60	15.90	38.90	12.20	40.97	54.00	-13.03	AV	Vertical
13281.55	32.19	42.60	15.90	38.90	12.20	44.39	74.00	-29.61	PK	Horizontal
13281.55	29.59	42.60	15.90	38.90	12.20	41.79	54.00	-12.21	AV	Horizontal



Mid Channel (802.11 n20/ 5785 MHz)										
3253.32	43.97	44.70	6.70	28.20	-9.80	34.17	74.00	-39.83	PK	Vertical
3253.32	41.08	44.70	6.70	28.20	-9.80	31.28	54.00	-22.72	AV	Vertical
3256.35	44.14	44.70	6.70	28.20	-9.80	34.34	74.00	-39.66	PK	Horizontal
3256.35	40.90	44.70	6.70	28.20	-9.80	31.10	54.00	-22.90	AV	Horizontal
3989.48	39.46	44.20	7.90	29.70	-6.60	32.86	74.00	-41.14	PK	Vertical
3989.48	36.66	44.20	7.90	29.70	-6.60	30.06	54.00	-23.94	AV	Vertical
3997.86	38.83	44.20	7.90	29.70	-6.60	32.23	74.00	-41.77	PK	Horizontal
3997.86	35.76	44.20	7.90	29.70	-6.60	29.16	54.00	-24.84	AV	Horizontal
7217.49	37.88	43.50	11.40	35.50	3.40	41.28	74.00	-32.72	PK	Vertical
7217.49	34.42	43.50	11.40	35.50	3.40	37.82	54.00	-16.18	AV	Vertical
7217.74	36.80	43.50	11.40	35.50	3.40	40.20	74.00	-33.80	PK	Horizontal
7217.74	33.78	43.50	11.40	35.50	3.40	37.18	54.00	-16.82	AV	Horizontal
10591.28	40.00	44.50	13.80	38.80	8.10	48.10	74.00	-25.90	PK	Vertical
10591.28	36.86	44.50	13.80	38.80	8.10	44.96	54.00	-9.04	AV	Vertical
10587.07	39.49	44.50	13.80	38.80	8.10	47.59	74.00	-26.41	PK	Horizontal
10587.07	36.49	44.50	13.80	38.80	8.10	44.59	54.00	-9.41	AV	Horizontal
11570.37	34.10	43.60	14.30	39.50	10.20	44.30	74.00	-29.70	PK	Vertical
11570.37	30.05	43.60	14.30	39.50	10.20	40.25	54.00	-13.75	AV	Vertical
11570.22	33.55	43.60	14.30	39.50	10.20	43.75	74.00	-30.25	PK	Horizontal
11570.22	31.12	43.60	14.30	39.50	10.20	41.32	54.00	-12.68	AV	Horizontal
13296.57	31.99	42.60	15.90	38.90	12.20	44.19	74.00	-29.81	PK	Vertical
13296.57	28.93	42.60	15.90	38.90	12.20	41.13	54.00	-12.87	AV	Vertical
13288.93	31.67	42.60	15.90	38.90	12.20	43.87	74.00	-30.13	PK	Horizontal
13288.93	29.59	42.60	15.90	38.90	12.20	41.79	54.00	-12.21	AV	Horizontal



High Channel (802.11 n20/ 5825 MHz)										
3258.97	44.43	44.70	6.70	28.20	-9.80	34.63	74.00	-39.37	PK	Vertical
3258.97	41.90	44.70	6.70	28.20	-9.80	32.10	54.00	-21.90	AV	Vertical
3264.24	44.25	44.70	6.70	28.20	-9.80	34.45	74.00	-39.55	PK	Horizontal
3264.24	41.77	44.70	6.70	28.20	-9.80	31.97	54.00	-22.03	AV	Horizontal
3992.30	39.44	44.20	7.90	29.70	-6.60	32.84	74.00	-41.16	PK	Vertical
3992.30	36.02	44.20	7.90	29.70	-6.60	29.42	54.00	-24.58	AV	Vertical
3985.80	38.68	44.20	7.90	29.70	-6.60	32.08	74.00	-41.92	PK	Horizontal
3985.80	37.09	44.20	7.90	29.70	-6.60	30.49	54.00	-23.51	AV	Horizontal
7233.50	36.77	43.50	11.40	35.50	3.40	40.17	74.00	-33.83	PK	Vertical
7233.50	34.68	43.50	11.40	35.50	3.40	38.08	54.00	-15.92	AV	Vertical
7230.70	37.84	43.50	11.40	35.50	3.40	41.24	74.00	-32.76	PK	Horizontal
7230.70	33.91	43.50	11.40	35.50	3.40	37.31	54.00	-16.69	AV	Horizontal
10633.85	39.91	44.50	13.80	38.80	8.10	48.01	74.00	-25.99	PK	Vertical
10633.85	36.79	44.50	13.80	38.80	8.10	44.89	54.00	-9.11	AV	Vertical
10640.21	38.95	44.50	13.80	38.80	8.10	47.05	74.00	-26.95	PK	Horizontal
10640.21	36.42	44.50	13.80	38.80	8.10	44.52	54.00	-9.48	AV	Horizontal
11649.94	32.79	43.60	14.30	39.50	10.20	42.99	74.00	-31.01	PK	Vertical
11649.94	30.86	43.60	14.30	39.50	10.20	41.06	54.00	-12.94	AV	Vertical
11650.01	33.53	43.60	14.30	39.50	10.20	43.73	74.00	-30.27	PK	Horizontal
11650.01	30.19	43.60	14.30	39.50	10.20	40.39	54.00	-13.61	AV	Horizontal
13288.06	31.53	42.70	18.00	37.10	12.40	43.93	74.00	-30.07	PK	Vertical
13288.06	29.47	42.70	18.00	37.10	12.40	41.87	54.00	-12.13	AV	Vertical
13299.26	32.55	42.70	18.00	37.10	12.40	44.95	74.00	-29.05	PK	Horizontal
13299.26	30.00	42.70	18.00	37.10	12.40	42.40	54.00	-11.60	AV	Horizontal

**Remark:**

1. Factor = Antenna Factor + Cable Loss – Pre-amplifier.
2. Scan with 802.11a, 802.11n (HT-20), 802.11n (HT-40), 802.11ac (HT-20), 802.11ac (HT-40), 802.11ac (HT-80) the worst case is 802.11n (HT-20).
3. The frequency emission of peak points that did not show above the forms are at least 20dB below the limit, the frequency emission is mainly from the environment noise.
4. Pre-scan both the SISO and MIMO mode, only the worst-case results were reported



3.2.10 Band Edge

Band I&II(5.15-5.35)GHz

Band I&II(5.15-5.35)GHz										
Frequency	Meter Reading	Amplifier	Loss	Antenna Factor	Orrected Factor	Emission Level	Limits	Margin	Detector	Comment
(MHz)	(dBμV)	(dB)	(dB)	(dB/m)	(dB)	(dBμV/m)	(dBμV/m)	(dB)	Type	
802.11a BW20MHz										
5150	41.17	44.20	8.98	31.60	-3.62	37.55	74	-36.45	Peak	Vertical
5150	30.94	44.20	8.98	31.60	-3.62	27.32	54	-26.68	AVG	Vertical
5150	40.42	44.20	8.98	31.60	-3.62	36.80	74	-37.20	Peak	Horizontal
5150	28.08	44.20	8.98	31.60	-3.62	24.46	54	-29.54	AVG	Horizontal
5350	43.14	44.20	9.35	31.60	-3.25	39.89	74	-34.11	Peak	Vertical
5350	30.40	44.20	9.35	31.60	-3.25	27.15	54	-26.85	AVG	Vertical
5350	41.90	44.20	9.35	31.60	-3.25	38.65	74	-35.35	Peak	Horizontal
5350	28.48	44.20	9.35	31.60	-3.25	25.23	54	-28.77	AVG	Horizontal
802.11n BW20MHz										
5150	40.61	44.20	8.98	31.60	-3.62	36.99	74	-37.01	Peak	Vertical
5150	27.76	44.20	8.98	31.60	-3.62	24.14	54	-29.86	AVG	Vertical
5150	41.10	44.20	8.98	31.60	-3.62	37.48	74	-36.52	Peak	Horizontal
5150	30.50	44.20	8.98	31.60	-3.62	26.88	54	-27.12	AVG	Horizontal
5350	43.16	44.20	9.35	31.60	-3.25	39.91	74	-34.09	Peak	Vertical
5350	29.44	44.20	9.35	31.60	-3.25	26.19	54	-27.81	AVG	Vertical
5350	41.61	44.20	9.35	31.60	-3.25	38.36	74	-35.64	Peak	Horizontal
5350	30.51	44.20	9.35	31.60	-3.25	27.26	54	-26.74	AVG	Horizontal
802.11n BW40MHz										
5150	41.96	44.20	8.98	31.60	-3.62	38.34	74	-35.66	Peak	Vertical
5150	30.35	44.20	8.98	31.60	-3.62	26.73	54	-27.27	AVG	Vertical
5150	37.91	44.20	8.98	31.60	-3.62	34.29	74	-39.71	Peak	Horizontal
5150	30.90	44.20	8.98	31.60	-3.62	27.28	54	-26.72	AVG	Horizontal
5350	43.78	44.20	9.35	31.60	-3.25	40.53	74	-33.47	Peak	Vertical
5350	30.69	44.20	9.35	31.60	-3.25	27.44	54	-26.56	AVG	Vertical
5350	37.73	44.20	9.35	31.60	-3.25	34.48	74	-39.52	Peak	Horizontal
5350	31.38	44.20	9.35	31.60	-3.25	28.13	54	-25.87	AVG	Horizontal



802.11ac BW20MHz										
5150	39.94	44.20	8.98	31.60	-3.62	36.32	74	-37.68	Peak	Vertical
5150	28.73	44.20	8.98	31.60	-3.62	25.11	54	-28.89	AVG	Vertical
5150	42.19	44.20	8.98	31.60	-3.62	38.57	74	-35.43	Peak	Horizontal
5150	30.37	44.20	8.98	31.60	-3.62	26.75	54	-27.25	AVG	Horizontal
5350	45.39	44.20	9.35	31.60	-3.25	42.14	74	-31.86	Peak	Vertical
5350	30.90	44.20	9.35	31.60	-3.25	27.65	54	-26.35	AVG	Vertical
5350	39.01	44.20	9.35	31.60	-3.25	35.76	74	-38.24	Peak	Horizontal
5350	30.22	44.20	9.35	31.60	-3.25	26.97	54	-27.03	AVG	Horizontal
802.11ac BW40MHz										
5150	41.61	44.20	8.98	31.60	-3.62	37.99	74	-36.01	Peak	Vertical
5150	28.10	44.20	8.98	31.60	-3.62	24.48	54	-29.52	AVG	Vertical
5150	39.49	44.20	8.98	31.60	-3.62	35.87	74	-38.13	Peak	Horizontal
5150	28.95	44.20	8.98	31.60	-3.62	25.33	54	-28.67	AVG	Horizontal
5350	45.43	44.20	9.35	31.60	-3.25	42.18	74	-31.82	Peak	Vertical
5350	31.61	44.20	9.35	31.60	-3.25	28.36	54	-25.64	AVG	Vertical
5350	38.60	44.20	9.35	31.60	-3.25	35.35	74	-38.65	Peak	Horizontal
5350	30.09	44.20	9.35	31.60	-3.25	26.84	54	-27.16	AVG	Horizontal
802.11ac BW80MHz										
5150	39.39	44.20	8.98	31.60	-3.62	35.77	74	-38.23	Peak	Vertical
5150	30.58	44.20	8.98	31.60	-3.62	26.96	54	-27.04	AVG	Vertical
5150	38.78	44.20	8.98	31.60	-3.62	35.16	74	-38.84	Peak	Horizontal
5150	27.67	44.20	8.98	31.60	-3.62	24.05	54	-29.95	AVG	Horizontal
5350	45.20	44.20	9.35	31.60	-3.25	41.95	74	-32.05	Peak	Vertical
5350	29.74	44.20	9.35	31.60	-3.25	26.49	54	-27.51	AVG	Vertical
5350	37.75	44.20	9.35	31.60	-3.25	34.50	74	-39.50	Peak	Horizontal
5350	28.65	44.20	9.35	31.60	-3.25	25.40	54	-28.60	AVG	Horizontal



**Band III 5470-5725MHz**

Band III(5.47-5.725 GHz)										
Frequency	Meter Reading	Amplifier	Loss	Antenna Factor	Orrected Factor	Emission Level	Limits	Margin	Detector	Comment
(MHz)	(dBμV)	(dB)	(dB)	(dB/m)	(dB)	(dBμV/m)	(dBμV/m)	(dB)	Type	
802.11a BW20MHz										
5470	41.86	44.20	9.67	32.00	-2.53	39.33	74	-34.67	Peak	Vertical
5470	28.52	44.20	9.67	32.00	-2.53	25.99	54	-28.01	AVG	Vertical
5470	40.71	44.20	9.67	32.00	-2.53	38.18	74	-35.82	Peak	Horizontal
5470	28.98	44.20	9.67	32.00	-2.53	26.45	54	-27.55	AVG	Horizontal
5725	45.87	44.20	10.00	32.00	-2.20	43.67	74	-30.33	Peak	Vertical
5725	30.92	44.20	10.00	32.00	-2.20	28.72	54	-25.28	AVG	Vertical
5725	40.42	44.20	10.00	32.00	-2.20	38.22	74	-35.78	Peak	Horizontal
5725	31.63	44.20	10.00	32.00	-2.20	29.43	54	-24.57	AVG	Horizontal
802.11n BW20MHz										
5470	41.43	44.20	9.67	32.00	-2.53	38.90	74	-35.10	Peak	Vertical
5470	29.68	44.20	9.67	32.00	-2.53	27.15	54	-26.85	AVG	Vertical
5470	42.31	44.20	9.67	32.00	-2.53	39.78	74	-34.22	Peak	Horizontal
5470	31.11	44.20	9.67	32.00	-2.53	28.58	54	-25.42	AVG	Horizontal
5725	43.50	44.20	10.00	32.00	-2.20	41.30	74	-32.70	Peak	Vertical
5725	29.66	44.20	10.00	32.00	-2.20	27.46	54	-26.54	AVG	Vertical
5725	39.77	44.20	10.00	32.00	-2.20	37.57	74	-36.43	Peak	Horizontal
5725	28.82	44.20	10.00	32.00	-2.20	26.62	54	-27.38	AVG	Horizontal
802.11n BW40MHz										
5470	41.28	44.20	9.67	32.00	-2.53	38.75	74	-35.25	Peak	Vertical
5470	28.70	44.20	9.67	32.00	-2.53	26.17	54	-27.83	AVG	Vertical
5470	38.49	44.20	9.67	32.00	-2.53	35.96	74	-38.04	Peak	Horizontal
5470	28.82	44.20	9.67	32.00	-2.53	26.29	54	-27.71	AVG	Horizontal
5725	43.05	44.20	10.00	32.00	-2.20	40.85	74	-33.15	Peak	Vertical
5725	31.74	44.20	10.00	32.00	-2.20	29.54	54	-24.46	AVG	Vertical
5725	38.89	44.20	10.00	32.00	-2.20	36.69	74	-37.31	Peak	Horizontal
5725	29.84	44.20	10.00	32.00	-2.20	27.64	54	-26.36	AVG	Horizontal



802.11ac BW20MHz										
5470	38.51	44.20	9.67	32.00	-2.53	35.98	74	-38.02	Peak	Vertical
5470	27.57	44.20	9.67	32.00	-2.53	25.04	54	-28.96	AVG	Vertical
5470	39.87	44.20	9.67	32.00	-2.53	37.34	74	-36.66	Peak	Horizontal
5470	29.00	44.20	9.67	32.00	-2.53	26.47	54	-27.53	AVG	Horizontal
5725	43.49	44.20	10.00	32.00	-2.20	41.29	74	-32.71	Peak	Vertical
5725	27.68	44.20	10.00	32.00	-2.20	25.48	54	-28.52	AVG	Vertical
5725	39.85	44.20	10.00	32.00	-2.20	37.65	74	-36.35	Peak	Horizontal
5725	27.71	44.20	10.00	32.00	-2.20	25.51	54	-28.49	AVG	Horizontal
802.11ac BW40MHz										
5470	41.12	44.20	9.67	32.00	-2.53	38.59	74	-35.41	Peak	Vertical
5470	30.84	44.20	9.67	32.00	-2.53	28.31	54	-25.69	AVG	Vertical
5470	38.19	44.20	9.67	32.00	-2.53	35.66	74	-38.34	Peak	Horizontal
5470	28.17	44.20	9.67	32.00	-2.53	25.64	54	-28.36	AVG	Horizontal
5725	44.62	44.20	10.00	32.00	-2.20	42.42	74	-31.58	Peak	Vertical
5725	31.52	44.20	10.00	32.00	-2.20	29.32	54	-24.68	AVG	Vertical
5725	40.69	44.20	10.00	32.00	-2.20	38.49	74	-35.51	Peak	Horizontal
5725	27.84	44.20	10.00	32.00	-2.20	25.64	54	-28.36	AVG	Horizontal
802.11ac BW80MHz										
5470	40.73	44.20	9.67	32.00	-2.53	38.20	74	-35.80	Peak	Vertical
5470	29.19	44.20	9.67	32.00	-2.53	26.66	54	-27.34	AVG	Vertical
5470	41.35	44.20	9.67	32.00	-2.53	38.82	74	-35.18	Peak	Horizontal
5470	30.43	44.20	9.67	32.00	-2.53	27.90	54	-26.10	AVG	Horizontal
5725	43.27	44.20	10.00	32.00	-2.20	41.07	74	-32.93	Peak	Vertical
5725	28.96	44.20	10.00	32.00	-2.20	26.76	54	-27.24	AVG	Vertical
5725	40.17	44.20	10.00	32.00	-2.20	37.97	74	-36.03	Peak	Horizontal
5725	30.73	44.20	10.00	32.00	-2.20	28.53	54	-25.47	AVG	Horizontal



**Band IV(5.725-5.85 GHz)**

Band IV(5.725-5.85 GHz)										
Frequency	Meter Reading	Amplifier	Loss	Antenna Factor	Orrected Factor	Emission Level	Limits	Margin	Detector	Comment
(MHz)	(dBμV)	(dB)	(dB)	(dB/m)	(dB)	(dBμV/m)	(dBμV/m)	(dB)	Type	
802.11a BW20MHz										
5725	40.52	44.20	10.00	32.00	-2.20	38.32	74	-35.68	Peak	Vertical
5725	31.28	44.20	10.00	32.00	-2.20	29.08	54	-24.92	AVG	Vertical
5725	40.24	44.20	10.00	32.00	-2.20	38.04	74	-35.96	Peak	Horizontal
5725	30.09	44.20	10.00	32.00	-2.20	27.89	54	-26.11	AVG	Horizontal
5850	42.63	44.20	10.20	32.00	-2.00	40.63	74	-33.37	Peak	Vertical
5850	30.19	44.20	10.20	32.00	-2.00	28.19	54	-25.81	AVG	Vertical
5850	41.41	44.20	10.20	32.00	-2.00	39.41	74	-34.59	Peak	Horizontal
5850	30.17	44.20	10.20	32.00	-2.00	28.17	54	-25.83	AVG	Horizontal
802.11n BW20MHz										
5725	41.89	44.20	10.00	32.00	-2.20	39.69	74	-34.31	Peak	Vertical
5725	29.63	44.20	10.00	32.00	-2.20	27.43	54	-26.57	AVG	Vertical
5725	40.49	44.20	10.00	32.00	-2.20	38.29	74	-35.71	Peak	Horizontal
5725	30.75	44.20	10.00	32.00	-2.20	28.55	54	-25.45	AVG	Horizontal
5850	46.54	44.20	10.20	32.00	-2.00	44.54	74	-29.46	Peak	Vertical
5850	27.74	44.20	10.20	32.00	-2.00	25.74	54	-28.26	AVG	Vertical
5850	41.28	44.20	10.20	32.00	-2.00	39.28	74	-34.72	Peak	Horizontal
5850	29.18	44.20	10.20	32.00	-2.00	27.18	54	-26.82	AVG	Horizontal
802.11n BW40MHz										
5725	40.49	44.20	10.00	32.00	-2.20	38.29	74	-35.71	Peak	Vertical
5725	28.81	44.20	10.00	32.00	-2.20	26.61	54	-27.39	AVG	Vertical
5725	38.79	44.20	10.00	32.00	-2.20	36.59	74	-37.41	Peak	Horizontal
5725	30.30	44.20	10.00	32.00	-2.20	28.10	54	-25.90	AVG	Horizontal
5850	44.12	44.20	10.20	32.00	-2.00	42.12	74	-31.88	Peak	Vertical
5850	31.12	44.20	10.20	32.00	-2.00	29.12	54	-24.88	AVG	Vertical
5850	37.72	44.20	10.20	32.00	-2.00	35.72	74	-38.28	Peak	Horizontal
5850	28.12	44.20	10.20	32.00	-2.00	26.12	54	-27.88	AVG	Horizontal





802.11ac BW20MHz										
5725	39.42	44.20	10.00	32.00	-2.20	37.22	74	-36.78	Peak	Vertical
5725	27.45	44.20	10.00	32.00	-2.20	25.25	54	-28.75	AVG	Vertical
5725	38.67	44.20	10.00	32.00	-2.20	36.47	74	-37.53	Peak	Horizontal
5725	28.21	44.20	10.00	32.00	-2.20	26.01	54	-27.99	AVG	Horizontal
5850	43.18	44.20	10.20	32.00	-2.00	41.18	74	-32.82	Peak	Vertical
5850	31.89	44.20	10.20	32.00	-2.00	29.89	54	-24.11	AVG	Vertical
5850	39.53	44.20	10.20	32.00	-2.00	37.53	74	-36.47	Peak	Horizontal
5850	31.84	44.20	10.20	32.00	-2.00	29.84	54	-24.16	AVG	Horizontal
802.11ac BW40MHz										
5725	41.07	44.20	10.00	32.00	-2.20	38.87	74	-35.13	Peak	Vertical
5725	28.11	44.20	10.00	32.00	-2.20	25.91	54	-28.09	AVG	Vertical
5725	38.89	44.20	10.00	32.00	-2.20	36.69	74	-37.31	Peak	Horizontal
5725	27.89	44.20	10.00	32.00	-2.20	25.69	54	-28.31	AVG	Horizontal
5850	46.42	44.20	10.20	32.00	-2.00	44.42	74	-29.58	Peak	Vertical
5850	30.49	44.20	10.20	32.00	-2.00	28.49	54	-25.51	AVG	Vertical
5850	41.66	44.20	10.20	32.00	-2.00	39.66	74	-34.34	Peak	Horizontal
5850	29.98	44.20	10.20	32.00	-2.00	27.98	54	-26.02	AVG	Horizontal
802.11ac BW80MHz										
5725	39.18	44.20	10.00	32.00	-2.20	36.98	74	-37.02	Peak	Vertical
5725	29.55	44.20	10.00	32.00	-2.20	27.35	54	-26.65	AVG	Vertical
5725	38.43	44.20	10.00	32.00	-2.20	36.23	74	-37.77	Peak	Horizontal
5725	30.26	44.20	10.00	32.00	-2.20	28.06	54	-25.94	AVG	Horizontal
5850	43.86	44.20	10.20	32.00	-2.00	41.86	74	-32.14	Peak	Vertical
5850	29.00	44.20	10.20	32.00	-2.00	27.00	54	-27.00	AVG	Vertical
5850	40.97	44.20	10.20	32.00	-2.00	38.97	74	-35.03	Peak	Horizontal
5850	29.50	44.20	10.20	32.00	-2.00	27.50	54	-26.50	AVG	Horizontal



## 4. CONDUCTED SPURIOUS EMISSIONS AND BANDEGE

### 4.1 APPLIED PROCEDURES / LIMIT

Undesirable emission limits. Except as shown in paragraph (b)(7) of this section, the maximum emissions outside of the frequency bands of operation shall be attenuated in accordance with the following limits:

- (1) For transmitters operating in the 5.15-5.25 GHz band: All emissions outside of the 5.15-5.35 GHz band shall not exceed an e.i.r.p. of  $-27$  dBm/MHz.
- (2) For transmitters operating in the 5.25-5.35 GHz band: All emissions outside of the 5.15-5.35 GHz band shall not exceed an e.i.r.p. of  $-27$  dBm/MHz.
- (3) For transmitters operating in the 5.47-5.725 GHz band: All emissions outside of the 5.47-5.725 GHz band shall not exceed an e.i.r.p. of  $-27$  dBm/MHz.
- (4) For transmitters operating in the 5.725-5.85 GHz band:
  - (i) All emissions shall be limited to a level of  $-27$  dBm/MHz at 75 MHz or more above or below the band edge increasing linearly to 10 dBm/MHz at 25 MHz above or below the band edge, and from 25 MHz above or below the band edge increasing linearly to a level of 15.6 dBm/MHz at 5 MHz above or below the band edge, and from 5 MHz above or below the band edge increasing linearly to a level of 27 dBm/MHz at the band edge.

#### 4.1.1 TEST PROCEDURE

Spectrum Parameter	Setting
Detector	Peak
Start/Stop Frequency	30 MHz to 10th carrier harmonic
RB / VB (emission in restricted band)	1000 KHz/3000 KHz
Trace-Mode:	Max hold

For Band edge

Spectrum Parameter	Setting
Detector	Peak
Start/Stop Frequency	Lower Band Edge: 5700 to 5725 MHz Upper Band Edge: 5850 to 5870 MHz
RB / VB (emission in restricted band)	1000 KHz/3000 KHz
Trace-Mode:	Max hold

#### 4.1.2 DEVIATION FROM STANDARD

No deviation.

### 4.1.3 TEST SETUP

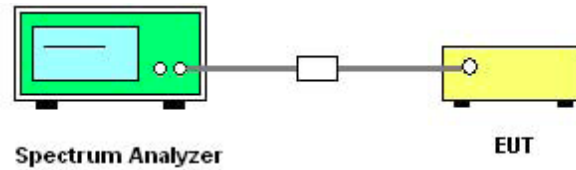

The EUT which is powered by the Battery, is coupled to the Spectrum Analyzer; the RF load attached to the EUT antenna terminal is 50Ohm; the path loss as the factor is calibrated to correct the reading.

Make the measurement with the spectrum analyzer's resolution bandwidth (RBW) = 1000 kHz. In order to make an accurate measurement, set the span greater than RBW.

### 4.1.4 EUT OPERATION CONDITIONS

The EUT tested system was configured as the statements of 2.3 Unless otherwise a special operating condition is specified in the follows during the testing.

### 4.1.5 TEST RESULTS

Data See Appendix A





## 5. POWER SPECTRAL DENSITY TEST

### 5.1 APPLIED PROCEDURES / LIMIT

1. For mobile and portable client devices in the 5.15-5.25 GHz band, , the maximum power spectral density shall not exceed 11 dBm in any 1 megahertz band. If transmitting antennas of directional gain greater than 6 dBi are used, both the maximum conducted output power and the maximum power spectral density shall be reduced by the amount in dB that the directional gain of the antenna exceeds 6 dBi.
2. For the 5.25-5.35 GHz and 5.47-5.725 GHz bands, the maximum power spectral density shall not exceed 11 dBm in any 1 megahertz band. If transmitting antennas of directional gain greater than 6 dBi are used, both the maximum conducted output power and the maximum power spectral density shall be reduced by the amount in dB that the directional gain of the antenna exceeds 6 dBi.
3. For the band 5.725-5.850 GHz, the peak power spectral density shall not exceed 30 dBm in any 500KHz band. If transmitting antenna directional gain is greater than 6 dBi, both the maximum conducted output power and the peak power spectral density shall be reduced by the amount in dB that the directional gain of the antenna exceeds 6 dBi.

### 5.1.1 TEST PROCEDURE

1. The setting follows Method SA-1 of FCC KDB D02 General UNII Test Procedures New Rules v01r03.

For devices operating in the band, the rules specify a measurement bandwidth of 500 kHz. Many spectrum analyzers do not have 500 kHz RBW, thus a narrower RBW may need to be used. The rules permit the use of a RBWs less than 1 MHz, or 500 kHz, "provided that the measured power is integrated over the full reference bandwidth" to show the total power over the specified measurement bandwidth (*i.e.*, 1 MHz, or 500 kHz). If measurements are performed using a reduced resolution bandwidth (< 1 MHz, or < 500 kHz) and integrated over 1 MHz, or 500 KHz bandwidth, the following adjustments to the procedures apply:

- a) Set  $RBW \geq 1/T$ , where  $T$  is defined in section II.B.I.a).
- b) Set  $VBW \geq 3 RBW$ .
- c) If measurement bandwidth of Maximum PSD is specified in 500 kHz, add  $10 \log (500\text{kHz}/RBW)$  to the measured result, whereas  $RBW (< 500 \text{ kHz})$  is the reduced resolution bandwidth of the spectrum analyzer set during measurement.
- d) If measurement bandwidth of Maximum PSD is specified in 1 MHz, add  $10 \log (1\text{MHz}/RBW)$  to the measured result, whereas  $RBW (< 1 \text{ MHz})$  is the reduced resolution bandwidth of spectrum analyzer set during measurement.
- e) Care must be taken to ensure that the measurements are performed during a period of continuous transmission or are corrected upward for duty cycle.

Note: As a practical matter, it is recommended to use reduced RBW of 100 kHz for the sections 5.c) and 5.d) above, since  $RBW=100 \text{ KHZ}$  is available on nearly all spectrum analyzers.

### 5.1.2 DEVIATION FROM STANDARD

No deviation.

### 5.1.3 TEST SETUP

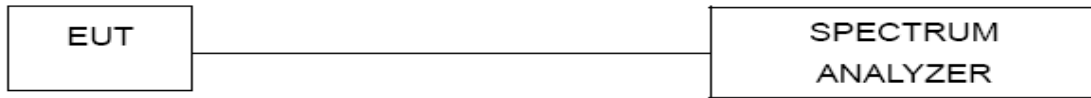

### 5.1.4 EUT OPERATION CONDITIONS

The EUT tested system was configured as the statements of 2.1 Unless otherwise a special operating condition is specified in the follows during the testing.

### 5.1.5 TEST RESULTS

Data see Appendix B



## 6. BANDWIDTH MEASUREMENT

### 6.1 EMISSION BANDWIDTH (EBW) 26 BANDWID PROCEDURES / LIMIT

See list of measuring instruments of this test report.

#### 6.1.1 TEST PROCEDURE

1. The testing follows FCC KDB 789033 D02 General UNII Test Procedures New Rules v02r01
2. Set RBW = approximately 1% of the emission bandwidth.
3. Set the VBW  $\geq$  RBW.
4. Detector = Peak.
5. Trace mode = max hold.
6. Measure the maximum width of the emission that is 26 dB down from the peak of the emission. Compare this with the RBW setting of the analyzer. Readjust RBW and repeat measurement as needed until the RBW/EBW ratio is approximately 1%.

#### 6.1.2 DEVIATION FROM STANDARD

No deviation.

#### 6.1.3 TEST SETUP

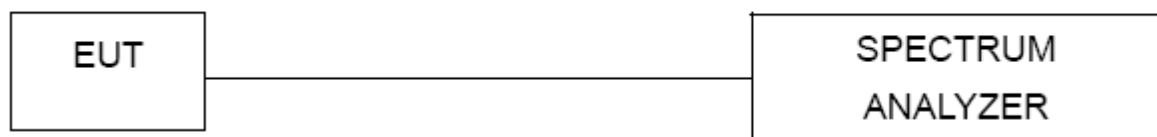

#### 6.1.4 EUT OPERATION CONDITIONS

The EUT tested system was configured as the statements of 2.4 Unless otherwise a special operating condition is specified in the follows during the testing.

#### 6.1.5 TEST RESULTS

Data see Appendix C

## 6.2 OCCUPIED BANDWIDTH ( 99%) TEST APPLIED PROCEDURES / LIMIT

The following procedure shall be used for measuring (99 %) power bandwidth:

### 6.2.1 TEST PROCEDURE

1. The testing follows FCC KDB 789033 D02 General UNII Test Procedures v02r01.

The following procedure shall be used for measuring (99 %) power bandwidth:

1. Set center frequency to the nominal EUT channel center frequency.
2. Set span = 1.5 times to 5.0 times the OBW.
3. Set RBW = 1 % to 5 % of the OBW
4. Set VBW  $\geq 3 \cdot$  RBW
5. Video averaging is not permitted. Where practical, a sample detection and single sweep mode shall be used. Otherwise, peak detection and max hold mode (until the trace stabilizes) shall be used.
6. Use the 99 % power bandwidth function of the instrument (if available).
7. If the instrument does not have a 99 % power bandwidth function, the trace data points are recovered and directly summed in power units. The recovered amplitude data points, beginning at the lowest frequency, are placed in a running sum until 0.5 % of the total is reached; that frequency is recorded as the lower frequency. The process is repeated until 99.5 % of the total is reached; that frequency is recorded as the upper frequency. The 99% occupied bandwidth is the difference between these two frequencies.

### 6.2.2 DEVIATION FROM STANDARD

No deviation.

### 6.2.3 TEST SETUP



### 6.2.4 EUT OPERATION CONDITIONS

The EUT tested system was configured as the statements of 2.4 Unless otherwise a special operating condition is specified in the follows during the testing.

### 6.2.5 TEST RESULTS

Data See Appendix C

### 6.3 MINIMUM EMISSION BANDWIDTH(6 DB) PROCEDURES / LIMIT

Section 15.407(e) specifies the minimum 6 dB emission bandwidth of at least 500 KHz for the band 5.725-5.85 GHz. The following procedure shall be used for measuring this bandwidth:

#### 6.3.1 TEST PROCEDURE

1. The testing follows FCC KDB 789033 D02 General UNII Test Procedures v02r01.
  - a) Set RBW = 100 kHz.
  - b) Set the video bandwidth (VBW)  $\geq 3 \times$  RBW.
  - c) Detector = Peak.
  - d) Trace mode = max hold.
  - e) Sweep = auto couple.
  - f) Allow the trace to stabilize.
  - g) Measure the maximum width of the emission that is constrained by the frequencies associated with the two outermost amplitude points (upper and lower frequencies) that are attenuated by 6 dB relative to the maximum level measured in the fundamental emission.

#### 6.3.2 DEVIATION FROM STANDARD

No deviation.

#### 6.3.3 TEST SETUP



#### 6.3.4 EUT OPERATION CONDITIONS

The EUT tested system was configured as the statements of 2.4 Unless otherwise a special operating condition is specified in the follows during the testing.

#### 6.3.5 TEST RESULTS

Data see Appendix D



## 7. MAXIMUM CONDUCTED OUTPUT POWER

### 7.1 APPLIED PROCEDURES / LIMIT

For mobile and portable client devices in the 5.15-5.25 GHz band, the maximum conducted output power over the frequency band of operation shall not exceed 250 mW provided the maximum antenna gain does not exceed 6 dBi. If transmitting antennas of directional gain greater than 6 dBi are used, both the maximum conducted output power and the maximum power spectral density shall be reduced by the amount in dB that the directional gain of the antenna exceeds 6 dBi.

For the 5.25-5.35 GHz and 5.47-5.725 GHz bands, the maximum conducted output power over the frequency bands of operation shall not exceed the lesser of 250 mW or 11 dBm + 10 log B, where B is the 26 dB emission bandwidth in megahertz, If transmitting antennas of directional gain greater than 6 dBi are used.

For the band 5.725-5.85 GHz, the maximum conducted output power over the frequency band of operation shall not exceed 1 W. If transmitting antennas of directional gain greater than 6 dBi are used.

FCC Part15 (15.407) , Subpart E				
Section	Test Item	Limit	Frequency Range (MHz)	Result
15.407(a) (1) (iv)	Peak Output Power	0.25 watt	5150-5250	PASS
		The lesser of 250 mW or 11 dBm + 10 log (26 dB emission bandwidth)	5250-5350 5470-5725	
15.407(a) (3)		1 watt	5725-5825	

#### 7.1.1 TEST PROCEDURE

The EUT was directly connected to the Power Sensor&PC

#### 7.1.2 DEVIATION FROM STANDARD

No deviation.

#### 7.1.3 TEST SETUP

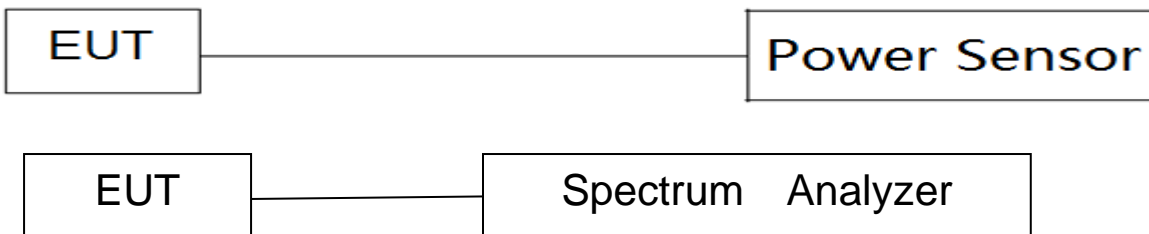

#### 7.1.4 EUT OPERATION CONDITIONS

The EUT tested system was configured as the statements of 5 Unless otherwise a special operating condition is specified in the follows during the testing.



**7.1.5 TEST RESULTS**

NOTE: 1. Antenna B Power > Antenna A Power, Both antenna A and B have been test, Only show the worst data of Antenna B.  
 2. 802.11a model can't transmit at the same time.

**Band I (5.15-5.25GHz)**

Band I (5.15-5.25GHz)								
Test Channel	Frequency (MHz)	PK Power A(dBm)	PK Power B(dBm)	PK Power Total(dBm)	AV Power (dBm)	AV Power B(dBm)	AV Power Total(dBm)	LIMIT (dBm)
802.11a								
36	5180	11.56	13.64	--	9.92	11.95	--	22.47
40	5200	11.20	13.10	--	9.29	10.70	--	22.47
48	5240	11.02	13.12	--	9.21	10.80	--	22.47
802.11n(HT20)								
36	5180	11.42	13.53	15.61	8.92	12.03	13.76	22.47
40	5200	11.33	13.24	15.40	9.35	11.16	13.36	22.47
48	5240	11.11	13.16	15.27	9.09	11.14	13.25	22.47
802.11n(HT40)								
38	5190	8.96	10.85	13.02	7.59	10.61	12.37	22.47
46	5230	9.28	11.14	13.32	7.75	10.04	12.05	22.47
802.11ac(HT20)								
36	5180	11.36	13.27	15.43	9.18	11.74	13.66	22.47
40	5200	11.39	13.30	15.46	9.84	11.67	13.86	22.47
48	5240	11.24	13.21	15.35	8.95	11.11	13.17	22.47
802.11ac(HT40)								
38	5190	8.87	10.79	12.95	8.18	10.28	12.37	22.47
46	5230	9.21	11.06	13.24	8.01	10.49	12.43	22.47
802.11ac(HT80)								
42	5210	8.56	10.22	12.48	7.02	8.72	10.96	22.47

**Note:**

1. For mobile and portable client devices in the 5.15-5.25 GHz band, the maximum conducted output power over the frequency band of operation shall not exceed the lesser of 0.25 W. The antenna gain is 7.51dBi, greater than 6dBi, the limit will reduced 1.51dBm, so the power limit is 22.47dBm.



802.11ac HT80(5210MHz)(Antenna B)

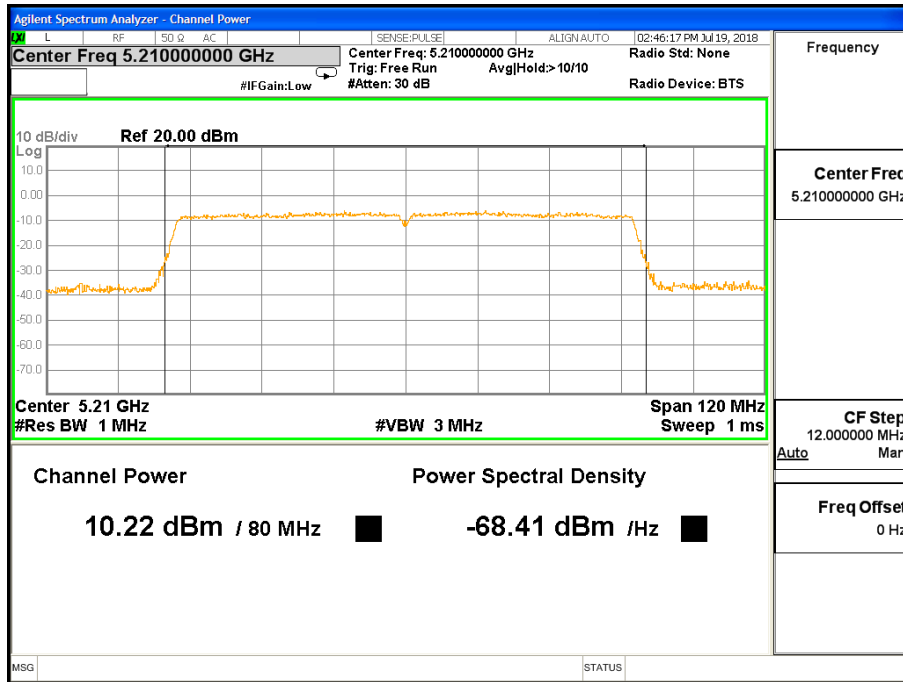



**Band II (5.25-5.35GHz)**

Band II(5.25-5.35GHz)								
Test Channel	Frequency (MHz)	PK Power A(dBm)	PK Power B(dBm)	PK Power Total(dBm)	AV Power (dBm)	AV Power B(dBm)	AV Power Total(dBm)	LIMIT (dBm)
802.11a								
52	5260	9.23	11.92	--	7.19	9.83	--	22.47
60	5300	9.42	11.64	--	7.48	9.54	--	22.47
64	5320	9.52	11.72	--	7.69	9.31	--	22.47
802.11n(HT20)								
52	5260	9.25	11.96	13.82	6.95	9.63	11.50	22.47
60	5300	9.46	11.67	13.71	7.85	9.35	11.67	22.47
64	5320	9.56	11.78	13.82	7.73	9.37	11.64	22.47
802.11n(HT40)								
54	5270	8.11	10.60	12.54	7.10	9.11	11.23	22.47
62	5310	8.21	10.33	12.41	7.36	9.72	11.71	22.47
802.11ac(HT20)								
52	5260	9.27	12.02	13.87	7.68	9.89	11.93	22.47
60	5300	9.51	11.71	13.76	7.44	9.93	11.87	22.47
64	5320	9.62	11.80	13.86	8.10	9.84	12.07	22.47
802.11ac(HT40)								
54	5270	8.15	10.63	12.57	7.25	9.50	11.53	22.47
62	5310	8.08	10.25	12.31	7.10	9.69	11.60	22.47
802.11ac(HT80)								
58	5290	7.52	9.76	11.79	6.21	9.15	10.93	22.47

**Note:**

1. For mobile and portable client devices in the 5.25-5.35 GHz band, the maximum conducted output power over the frequency band of operation shall not exceed the lesser of 0.25 W. The antenna gain is 7.51dBi, greater than 6dBi, the limit will reduced 1.51dBm, so the power limit is 22.47dBm.



802.11ac HT80(5290MHz) (Antenna B)

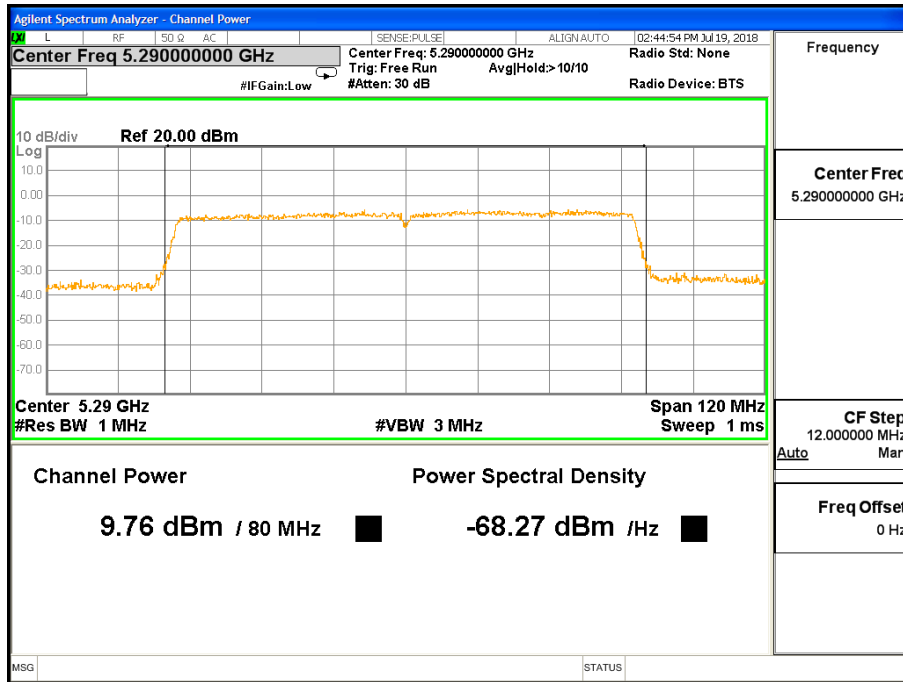

**Band III (5.47-5.725GHz)**

Band9 III(5.47-5.725GHz)								
Test Channel	Frequency (MHz)	PK Power A(dBm)	PK Power B(dBm)	PK Power Total(dBm)	AV Power (dBm)	AV Power B(dBm)	AV Power Total(dBm)	LIMIT (dBm)
802.11a								
100	5500	10.53	12.67	--	8.25	10.97	--	22.47
116	5580	9.79	11.87	--	7.80	10.35	--	22.47
140	5700	8.67	10.44	--	7.17	8.71	--	22.47
802.11n(HT20)								
100	5500	10.62	12.72	14.81	8.39	10.45	12.55	22.47
116	5580	9.89	11.90	14.02	7.67	9.88	11.92	22.47
140	5700	8.71	10.47	12.69	7.08	8.59	10.91	22.47
802.11n(HT40)								
102	5510	9.17	11.20	13.31	8.03	9.82	12.03	22.47
110	5550	8.54	10.67	12.74	7.09	9.34	11.37	22.47
134	5670	7.23	9.12	11.29	6.24	8.20	10.34	22.47
802.11ac(HT20)								
100	5500	10.67	12.75	14.84	8.54	11.18	13.07	22.47
116	5580	9.82	11.76	13.91	7.51	9.97	11.92	22.47
140	5700	8.96	10.51	12.81	7.40	8.20	10.83	22.47
802.11ac(HT40)								
102	5510	9.24	11.28	13.39	7.95	10.20	12.23	22.47
110	5550	8.64	10.53	12.70	7.40	9.28	11.45	22.47
134	5670	7.33	9.08	11.30	5.85	8.15	10.16	22.47
802.11ac(HT80)								
106	5530	6.73	8.58	10.76	5.58	7.70	9.78	22.47
122	5610	6.55	8.49	10.64	5.60	7.10	9.42	22.47

**Note:**

1. For mobile and portable client devices in the 5.47-5.725 GHz band, the maximum conducted output power over the frequency band of operation shall not exceed the lesser of 0.25 W. The antenna gain is 7.51dBi, greater than 6dBi, the limit will reduced 1.51dBm, so the power limit is 22.47dBm.



### 802.11ac HT80(5530MHz) (Antenna B)

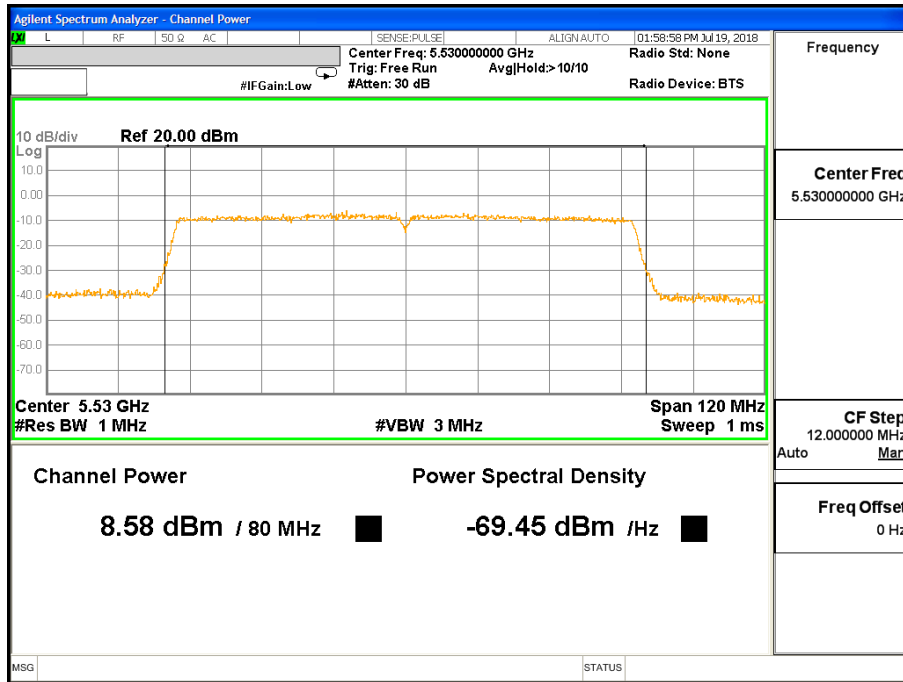

### 802.11ac HT80(5610MHz) (Antenna B)

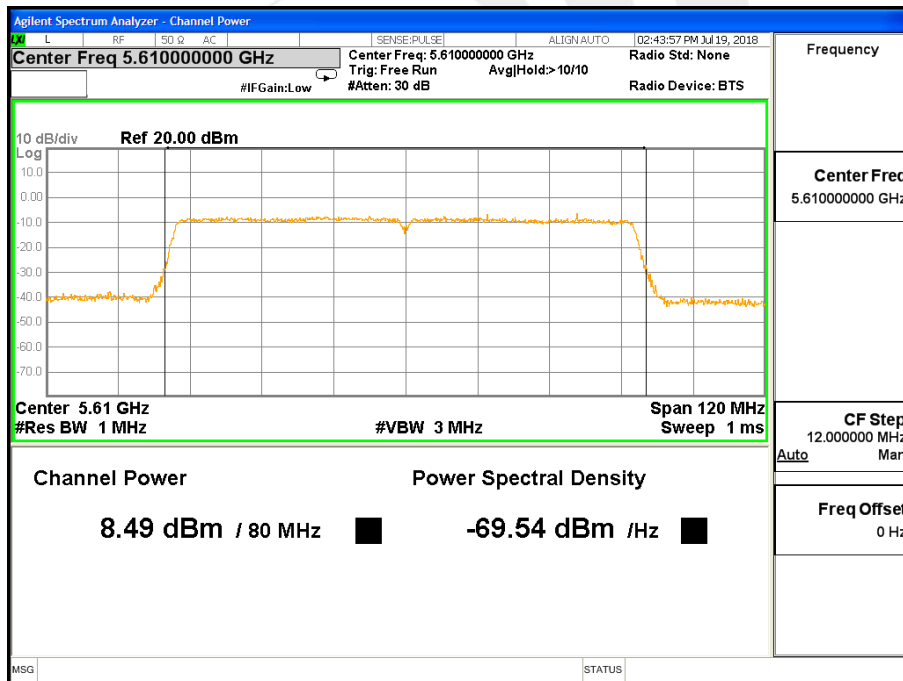

**Band IV (5.725-5.85GHz)**

Band IV (5.725-5.85GHz)								
Test Channel	Frequency (MHz)	PK Power A(dBm)	PK Power B(dBm)	PK Power Total(dBm)	AV Power (dBm)	AV Power B(dBm)	AV Power Total(dBm)	LIMIT (dBm)
802.11a								
149	5745	8.45	9.64	--	6.88	7.18	--	28.49
157	5785	7.02	8.17	--	4.83	6.12	--	28.49
165	5825	7.33	8.30	--	5.27	6.34	--	28.49
802.11n(HT20)								
149	5745	8.72	9.72	12.259	6.99	7.41	10.215	28.49
157	5785	8.12	9.02	11.604	6.50	6.57	9.545	28.49
165	5825	7.03	8.05	10.580	4.74	6.10	8.483	28.49
802.11n(HT40)								
151	5755	7.11	8.02	10.599	4.93	5.81	8.403	28.49
159	5795	7.90	7.80	10.861	6.31	5.90	9.120	28.49
802.11ac(HT20)								
149	5745	8.01	9.08	11.588	6.36	7.31	9.871	28.49
157	5785	7.88	8.92	11.441	5.71	7.06	9.448	28.49
165	5825	7.32	8.42	10.915	4.87	6.33	8.671	28.49
802.11ac(HT40)								
151	5755	7.64	7.92	10.793	5.93	6.15	9.052	28.49
159	5795	6.64	7.82	10.280	4.18	5.52	7.912	28.49
802.11ac(HT80)								
155	5775	6.58	7.75	10.215	4.63	5.85	8.293	28.49

## Note:

1. For the band 5.745-5.850 GHz, the maximum conducted output power over the frequency band of operation shall not exceed the lesser of 1 W. The antenna gain is 7.51dBi, greater than 6dBi, the limit will be reduced 1.51dBm, so the power limit is 28.49dBm.





802.11ac HT80(5775MHz) (Antenna B)

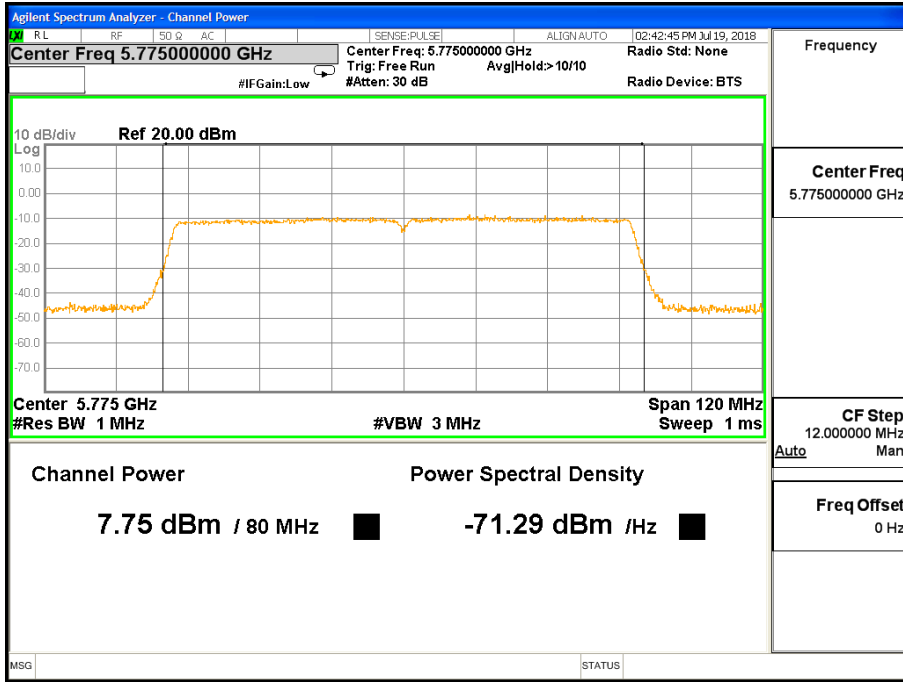



## 8. AUTOMATICALLY DISCONTINUE TRANSMISSION

### 8.1 LIMIT OF AUTOMATICALLY DISCONTINUE TRANSMISSION

The device shall automatically discontinue transmission in case of either absence of information to transmit or operational failure. These provisions are not intended to preclude the transmission of control or signaling information or the use of repetitive codes used by certain digital technologies to complete frame or burst intervals. Applicants shall include in their application for equipment authorization to describe how this requirement is met.

### 8.2 TEST RESULT OF AUTOMATICALLY DISCONTINUE TRANSMISSION

During no any information transmission, the EUT can automatically discontinue transmission and become standby mode for power saving. The EUT can detect the controlling signal of ACK message transmitting from remote device and verify whether it shall resend or discontinue transmission





## 9. ANTENNA REQUIREMENT

### 9.1 STANDARD REQUIREMENT

15.203 requirement: For intentional device, according to 15.203: an intentional radiator shall be designed to ensure that no antenna other than that furnished by the responsible party shall be used with the device.

### 9.2 EUT ANTENNA

The EUT antenna is PIFA Antenna. It comply with the standard requirement.



## APPENDIX - PHOTOS OF TEST SETUP

### Radiated Measurement Photos

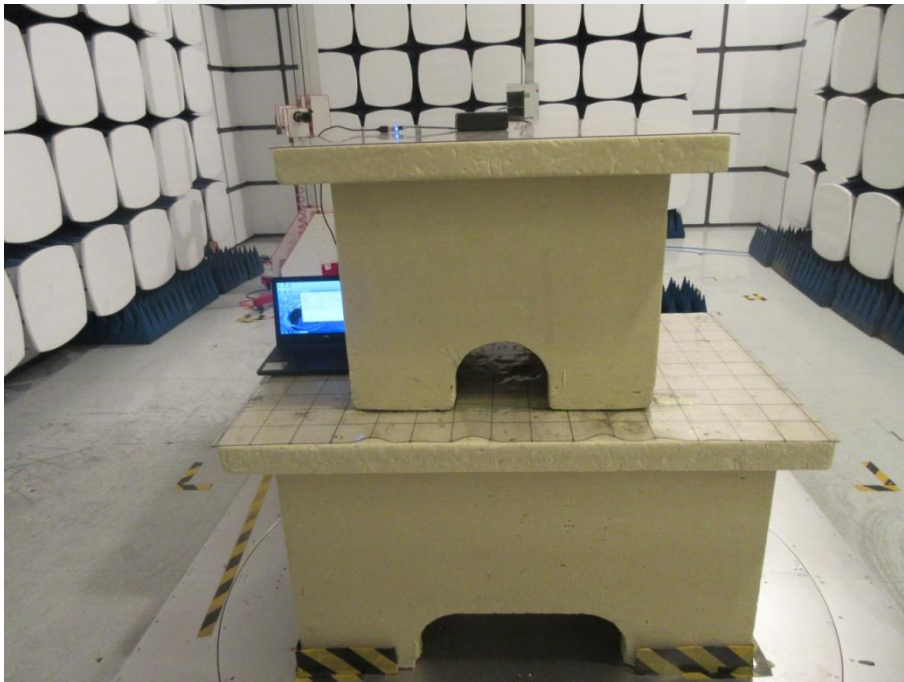
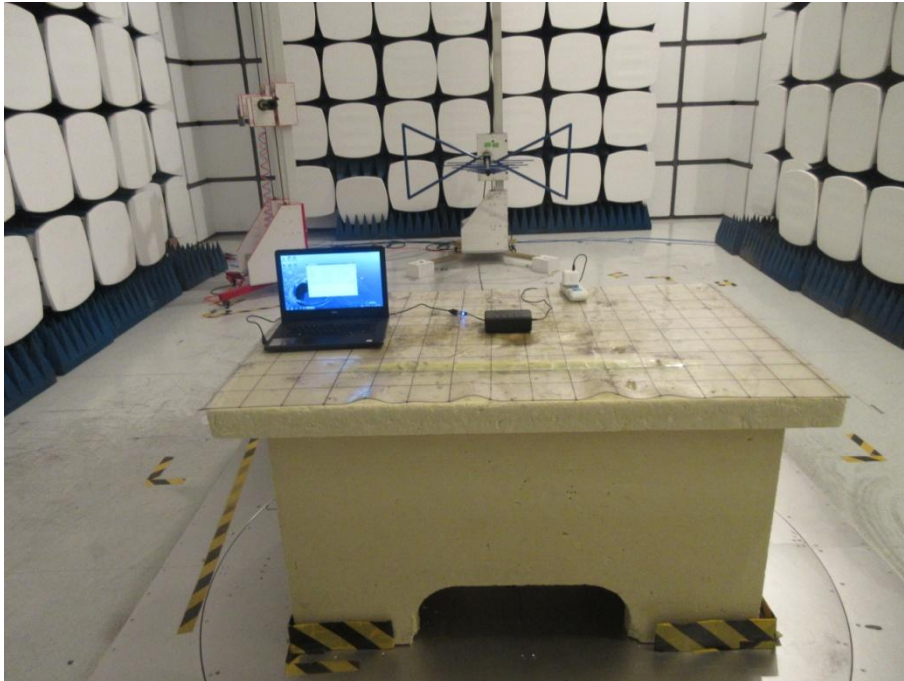

### Conducted Measurement Photos



※※※※END OF THE REPORT※※※※