

FCC 47 CFR PART 15 SUBPART C
CERTIFICATION TEST REPORT

For

LED Surface Mounted Luminaire

MODEL No.: TOPA224-LED-U-X-sensor-2, TOPA224-LED-U-X-sensor-2-W

FCC ID: 2AH36-TOPA22440W

Trade Mark: N/A

REPORT NO.: ES181015043E

ISSUE DATE: November 19, 2018

Prepared for

NINGBO TOP OPTOELECTRONIC TECHNOLOGY CO.,LTD
329 NATIONALHWY SANBEI TOWN NINGBO, ZHEJIANG 315331 CHINA

Prepared by

EMTEK (SHENZHEN) CO., LTD

Bldg 69, Majialong Industry Zone, Nanshan District,
Shenzhen, Guangdong, China
TEL: 86-755-26954280
FAX: 86-755-26954282

TABLE OF CONTENTS

1 TEST RESULT CERTIFICATION3

2 EUT TECHNICAL DESCRIPTION4

3 SUMMARY OF TEST RESULT5

4 TEST METHODOLOGY6

4.1 GENERAL DESCRIPTION OF APPLIED STANDARDS6

4.2 MEASUREMENT EQUIPMENT USED6

4.3 DESCRIPTION OF TEST MODES7

5 FACILITIES AND ACCREDITATIONS8

5.1 FACILITIES.....8

5.2 LABORATORY ACCREDITATIONS AND LISTINGS8

6 TEST SYSTEM UNCERTAINTY9

7 SETUP OF EQUIPMENT UNDER TEST10

7.1 RADIO FREQUENCY TEST SETUP 1.....10

7.2 RADIO FREQUENCY TEST SETUP 2.....10

7.3 CONDUCTED EMISSION TEST SETUP12

7.4 SUPPORT EQUIPMENT.....12

8 TEST REQUIREMENTS13

8.1 BANDWIDTH TEST13

8.2 CONDUCTED EMISSIONS TEST15

8.3 RADIATED SPURIOUS EMISSION20

8.4 BAND EDGES TEST28

8.5 ANTENNA APPLICATION31

1 TEST RESULT CERTIFICATION

Applicant: NINGBO TOP OPTOELECTRONIC TECHNOLOGY CO.,LTD
329 NATIONALHWY SANBEI TOWN NINGBO, ZHEJIANG 315331 CHINA

Manufacturer: NINGBO TOP OPTOELECTRONIC TECHNOLOGY CO.,LTD
329 NATIONALHWY SANBEI TOWN NINGBO, ZHEJIANG 315331 CHINA

EUT Description: LED Surface Mounted Luminaire

Model Number: TOPA224-LED-U-X-sensor-2, TOPA224-LED-U-X-sensor-2-W

File Number: ES181015043E

Date of Test: October 15, 2018 to November 15, 2018

Measurement Procedure Used:

APPLICABLE STANDARDS	
STANDARD	TEST RESULT
FCC 47 CFR Part 2, Subpart J FCC 47 CFR Part 15, Subpart C	PASS

The above equipment was tested by EMTEK (SHENZHEN) CO., LTD. The test data, data evaluation, test procedures, and equipment configurations shown in this report were made in accordance with the procedures given in ANSI C63.10 (2013) and the energy emitted by the sample EUT tested as described in this report is in compliance with the requirements of FCC Rules Part 2 and Part 15.249(2017)

The test results of this report relate only to the tested sample identified in this report.

Date of Test : October 15, 2018 to November 15, 2018

Prepared by : Joe Xia
Joe Xia/Editor

Reviewer : Yaping Shen
Yaping Shen/Supervisor

Approve & Authorized Signer : Lisa Wang
Lisa Wang/Manager



2 EUT TECHNICAL DESCRIPTION

Characteristics	Description
Device Type:	LED Surface Mounted Luminaire
Model:	TOPA224-LED-U-X-sensor-2, TOPA224-LED-U-X-sensor-2-W (Note: They are the same product, Except for the color of the lampshade).
Modulation:	Continuous Wave
Operating Frequency Range(s):	5725-5875MHz
Number of Channels:	1 channel
Antenna Type :	Internal Antenna
Antenna Gain:	0dBi
Power supply:	<input type="checkbox"/> DC supply: Battery DC 3*1.5V
	<input checked="" type="checkbox"/> AC 347-480V 50/60Hz

Note: for more details, please refer to the User's manual of the EUT.

3 SUMMARY OF TEST RESULT

FCC Part Clause	Test Parameter	Verdict	Remark
15.207	Conducted Emission	PASS	
15.209	Radiated Emission	PASS	
15.249	Radiated Spurious Emission	PASS	
15.249	Band edge test	PASS	
15.215(c)	20dB Bandwidth	PASS	
NOTE1: N/A (Not Applicable) NOTE2: The report use radiated measurements in the restricted frequency bands. In addition, the radiated test is also performed to ensure the emissions emanating from the device cabinet also comply with the applicable limits.			

RELATED SUBMITTAL(S) / GRANT(S):

This submittal(s) (test report) is intended for FCC ID: 2AH36-TOPA22440W filing to comply with Section 15.249 of the FCC Part 15, Subpart C Rules.

4 TEST METHODOLOGY

4.1 GENERAL DESCRIPTION OF APPLIED STANDARDS

According to its specifications, the EUT must comply with the requirements of the following standards:
 FCC 47 CFR Part 2, Subpart J
 FCC 47 CFR Part 15, Subpart C

4.2 MEASUREMENT EQUIPMENT USED

4.2.1 Conducted Emission Test Equipment

EQUIPMENT TYPE	MFR	MODEL NUMBER	SERIAL NUMBER	LAST CAL.
Test Receiver	Rohde & Schwarz	ESCS30	828985/018	05/20/2018
L.I.S.N.	Schwarzbeck	NNLK8129	8129203	05/20/2018
50Ω Coaxial Switch	Anritsu	MP59B	M20531	N/A
Pulse Limiter	Rohde & Schwarz	ESH3-Z2	100006	05/20/2018
Voltage Probe	Rohde & Schwarz	TK9416	N/A	05/20/2018
I.S.N	Rohde & Schwarz	ENY22	1109.9508.02	05/20/2018

4.2.2 Radiated Emission Test Equipment

EQUIPMENT TYPE	MFR	MODEL NUMBER	SERIAL NUMBER	LAST CAL.
EMI Test Receiver	Rohde & Schwarz	ESU	1302.6005.26	05/20/2018
Pre-Amplifier	HP	8447D	2944A07999	05/20/2018
Bilog Antenna	Schwarzbeck	VULB9163	142	05/20/2018
Loop Antenna	ARA	PLA-1030/B	1029	05/20/2018
Horn Antenna	Schwarzbeck	BBHA 9170	BBHA9170399	05/20/2018
Horn Antenna	Schwarzbeck	BBHA 9120	D143	05/20/2018
Cable	Schwarzbeck	AK9513	ACRX1	05/20/2018
Cable	Rosenberger	N/A	FP2RX2	05/20/2018
Cable	Schwarzbeck	AK9513	CRPX1	05/20/2018
Cable	Schwarzbeck	AK9513	CRRX2	05/20/2018

4.2.3 Radio Frequency Test Equipment

EQUIPMENT TYPE	MFR	MODEL NUMBER	SERIAL NUMBER	LAST CAL.
Spectrum Analyzer	Agilent	E4407B	88156318	05/20/2018
Signal Analyzer	Agilent	N9010A	My53470879	05/20/2018
Power meter	Anritsu	ML2495A	0824006	05/20/2018
Power sensor	Anritsu	MA2411B	0738172	05/20/2018

Remark: Each piece of equipment is scheduled for calibration once a year.

4.3 DESCRIPTION OF TEST MODES

The EUT has been tested under its typical operating condition.

The EUT configuration for testing is installed on RF field strength measurement to meet the Commissions requirement and operating in a manner which intends to maximize its emission characteristics in a continuous normal application.

The Transmitter was operated in the normal operating mode. The TX frequency was fixed which was for the purpose of the measurements.

Those modulation Continuous Wave were used for test.

Pre-defined engineering program for regulatory testing used to control the EUT for staying in continuous transmitting and receiving mode is programmed.

Frequency and Channel list:

Channel	Frequency (MHz)
1	5.8GHz

5 FACILITIES AND ACCREDITATIONS

5.1 FACILITIES

All measurement facilities used to collect the measurement data are located at

Bldg 69, Majialong Industry Zone District, Nanshan District, Shenzhen, China

The sites are constructed in conformance with the requirements of ANSI C63.7, ANSI C63.10 and CISPR Publication 22.

5.2 LABORATORY ACCREDITATIONS AND LISTINGS

Site Description

EMC Lab. : Accredited by CNAS, 2016.10.24
The certificate is valid until 2022.10.28
The Laboratory has been assessed and proved to be in compliance with
CNAS-CL01:2006 (identical to ISO/IEC 17025:2005)
The Certificate Registration Number is L2291.

Accredited by TUV Rheinland Shenzhen 2016.5.19
The Laboratory has been assessed according to the requirements
ISO/IEC 17025.

Accredited by FCC, August 06, 2018
The certificate is valid until August 07, 2020
Designation Number: CN1204
Test Firm Registration Number: 882943

Accredited by Industry Canada, November 24, 2015
The Certificate Registration Number is 4480A.

Accredited by A2LA, August 08, 2018
The certificate is valid until August 31, 2020
The Certificate Number is 4321.01.

Name of Firm : EMTEK (SHENZHEN) CO., LTD.
Site Location : Bldg 69, Majialong Industry Zone, Nanshan District, Shenzhen,
Guangdong, China

6 TEST SYSTEM UNCERTAINTY

The following measurement uncertainty levels have been estimated for tests performed on the apparatus:

Parameter	Uncertainty
Radio Frequency	$\pm 1 \times 10^{-5}$
Maximum Peak Output Power Test	$\pm 1.0\text{dB}$
Conducted Emissions Test	$\pm 2.0\text{dB}$
Radiated Emission Test	$\pm 2.0\text{dB}$
Power Density	$\pm 2.0\text{dB}$
Occupied Bandwidth Test	$\pm 1.0\text{dB}$
Band Edge Test	$\pm 3\text{dB}$
All emission, radiated	$\pm 3\text{dB}$
Antenna Port Emission	$\pm 3\text{dB}$
Temperature	$\pm 0.5^\circ\text{C}$
Humidity	$\pm 3\%$

Measurement Uncertainty for a level of Confidence of 95%

7 SETUP OF EQUIPMENT UNDER TEST

7.1 RADIO FREQUENCY TEST SETUP 1

The WLAN component's antenna ports(s) of the EUT are connected to the measurement instrument per an appropriate attenuator. The EUT is controlled by PC/software to emit the specified signals for the purpose of measurements.

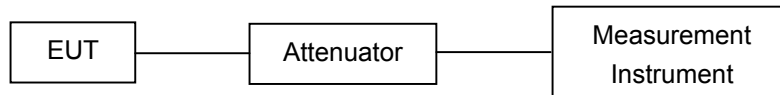

7.2 RADIO FREQUENCY TEST SETUP 2

The test site semi-anechoic chamber has met the requirement of NSA tolerance 4 dB according to the standards: ANSI C63.10. The test distance is 3m. The setup is according to the requirements in Section 13.1.4.1 of ANSI C63.10-2013 and CAN/CSA-CEI/IEC CISPR 22.

Below 30MHz:

The EUT is placed on a turntable 0.8 meters above the ground in the chamber, 3 meter away from the antenna (loop antenna). The Antenna should be positioned with its plane vertical at the specified distance from the EUT and rotated about its vertical axis for maximum response at each azimuth about the EUT. The center of the loop shall be 1 m above the ground. For certain applications, the loop antenna plane may also need to be positioned horizontally at the specified distance from the EUT.

Above 30MHz:

The EUT is placed on a turntable 0.8 meters above the ground in the chamber, 3 meter away from the antenna. The maximal emission value is acquired by adjusting the antenna height, polarisation and turntable azimuth. Normally, the height range of antenna is 1 m to 4 m, the azimuth range of turntable is 0° to 360°, and the receive antenna has two polarizations Vertical (V) and Horizontal (H).

Above 1GHz:

(Note: the FCC's permission to use 1.5m as an alternative per TCBC Conf call of Dec. 2, 2014.)

The EUT is placed on a turntable 1.5 meters above the ground in the chamber, 3 meter away from the antenna. The maximal emission value is acquired by adjusting the antenna height, polarisation and turntable azimuth. Normally, the height range of antenna is 1 m to 4 m, the azimuth range of turntable is 0° to 360°, and the receive antenna has two polarizations Vertical (V) and Horizontal (H).

(a) Radiated Emission Test Set-Up, Frequency Below 30MHz

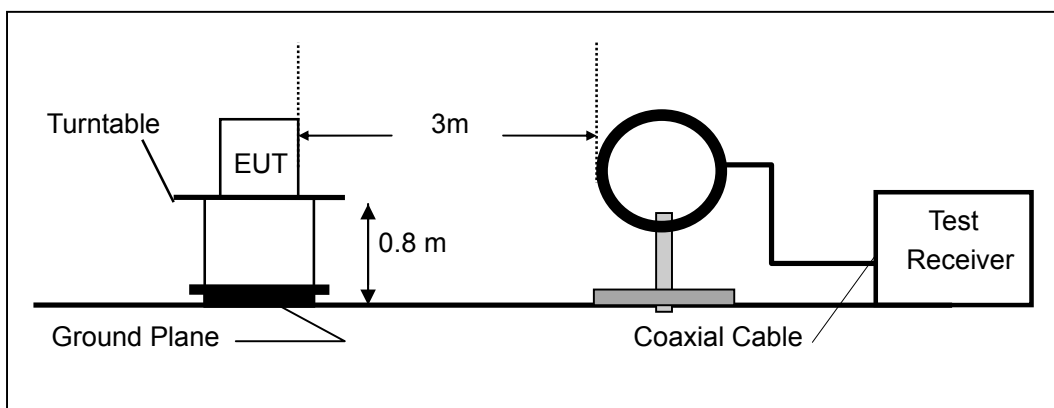

(b) Radiated Emission Test Set-Up, Frequency Below 1000MHz

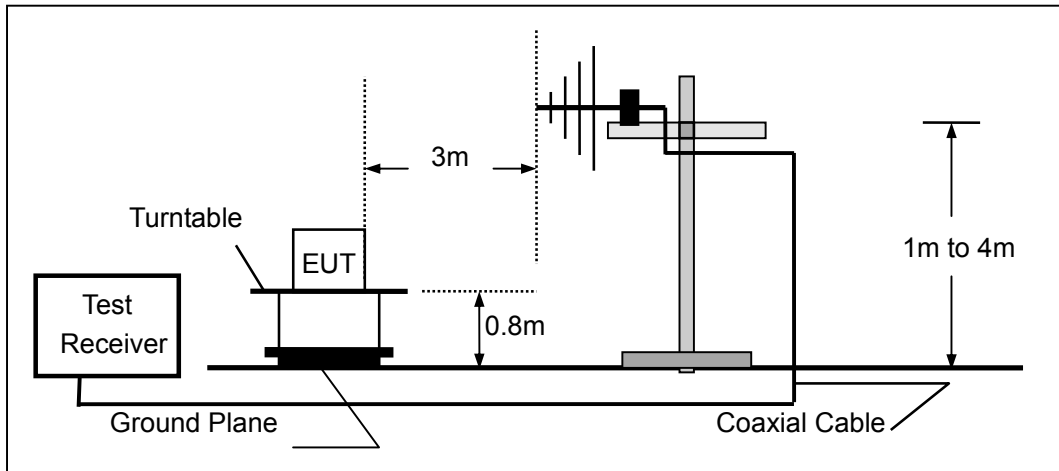

(c) Radiated Emission Test Set-Up, Frequency above 1000MHz

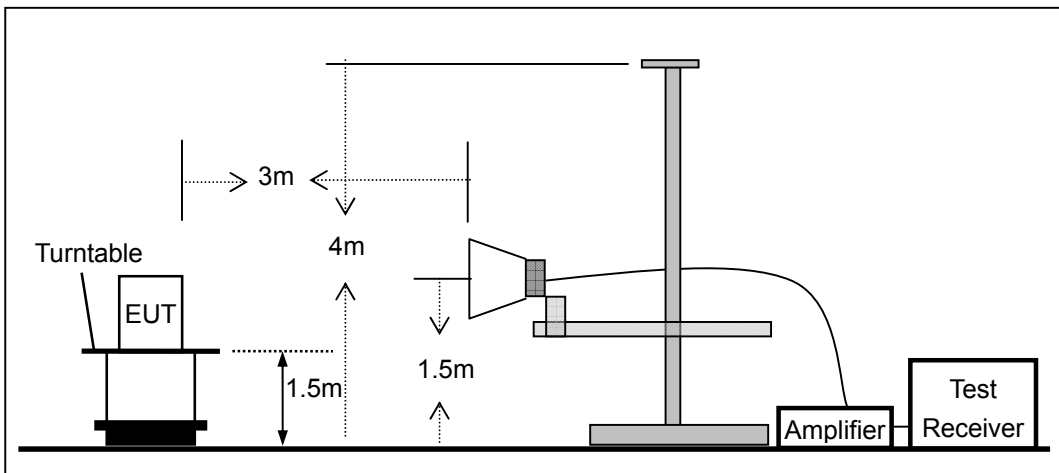

7.3 CONDUCTED EMISSION TEST SETUP

The mains cable of the EUT (maybe per AC/DC Adapter) must be connected to LISN. The LISN shall be placed 0.8 m from the boundary of EUT and bonded to a ground reference plane for LISN mounted on top of the ground reference plane. This distance is between the closest points of the LISN and the EUT. All other units of the EUT and associated equipment shall be at least 0.8m from the LISN.

Ground connections, where required for safety purposes, shall be connected to the reference ground point of the LISN and, where not otherwise provided or specified by the manufacturer, shall be of same length as the mains cable and run parallel to the mains connection at a separation distance of not more than 0.8 m.

According to the requirements in Section 13.1.4.1 of ANSI C63.10-2013 Conducted emissions from the EUT measured in the frequency range between 0.15 MHz and 30 MHz using CISPR Quasi-Peak and average detector mode.

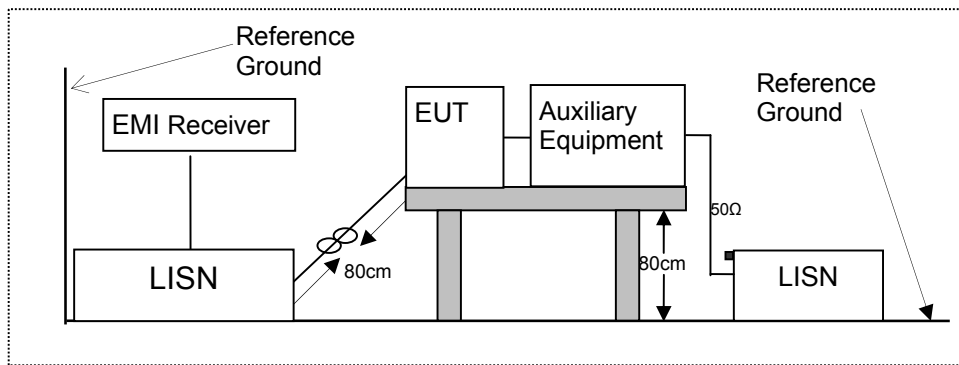

7.4 SUPPORT EQUIPMENT

Item	Equipment	Mfr/Brand	Model/Type No.	FCC ID	Series No.	Note
N/A	N/A	N/A	N/A	N/A	N/A	N/A

Notes:

1. All the equipment/cables were placed in the worst-case configuration to maximize the emission during the test.
2. Grounding was established in accordance with the manufacturer's requirements and conditions for the intended use.

8 TEST REQUIREMENTS

8.1 BANDWIDTH TEST

8.1.1 Block Diagram of Test Setup

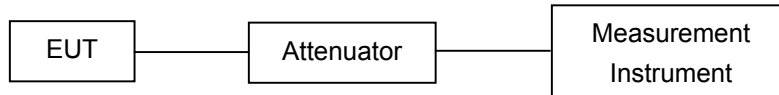

8.1.2 Applicable Standard

According to FCC Part 15.215(c)

8.1.3 Conformance Limit

Permitted band: 5725-5875 MHz

8.1.4 Test Configuration

Test according to clause 7.1 radio frequency test setup 1

8.1.5 Test Procedure

The EUT was operating in controlled its channel. Printed out the test result from the spectrum by hard copy function.

The RF output of EUT was connected to the spectrum analyzer by RF cable and attenuator. The path loss was compensated to the results for each measurement.

Set to the maximum power setting and enable the EUT transmit continuously

Set RBW = 3 kHz.

Set the video bandwidth (VBW) =10 kHz.

Set Span=2 times OBW

Set Detector = Peak.

Set Trace mode = max hold.

Set Sweep = auto couple.

Allow the trace to stabilize.

Measure the maximum width of the emission that is constrained by the frequencies associated with the two outermost amplitude points (upper and lower frequencies) that are attenuated by 20 dB relative to the maximum level measured in the fundamental emission.

Measure and record the results in the test report.

8.1.6 Test Results

Temperature :	23°C	Test Date :	Nov 12, 2018
Humidity :	52 %	Test By:	King Kong

Operation Mode	20dB bandwidth(KHz)	Permitted band (MHz)	Verdict
TX	1.489	5725-5875	PASS

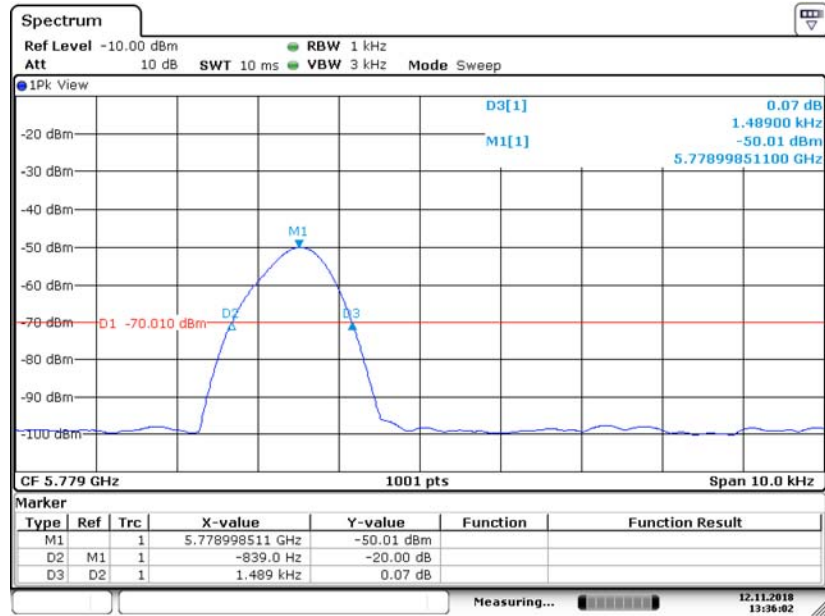

Date: 12.NOV.2018 13:36:01

8.2 CONDUCTED EMISSIONS TEST

8.2.1 Block Diagram of Test Setup

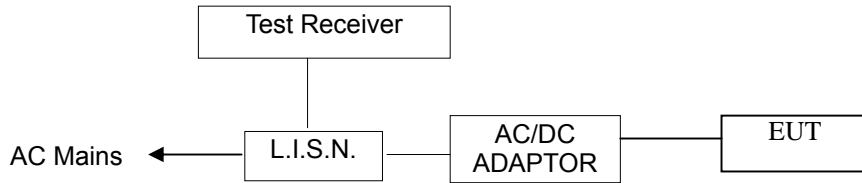

8.2.2 Applicable Standard

According to FCC Part 15.249 and 15.207

8.2.3 Conformance Limit

According to §15.207, For a Class A digital device that is designed to be connected to the public utility (AC) power line, the radio frequency voltage that is conducted back onto the AC power line on any frequency or frequencies within the band 150 kHz to 30 MHz shall not exceed the limits in the following table, as measured using a 50 µH/50 ohms LISN. Compliance with the provisions of this paragraph shall be based on the measurement of the radio frequency voltage between each power line and ground at the power terminal. The lower limit applies at the boundary between the frequency ranges.

Frequency (MHz)	Limit (dBµV)	
	Quasi-peak Level	Average Level
0.15 ~ 0.50	66.0 ~ 56.0 *	56.0 ~ 46.0 *
0.50 ~ 5.00	56.0	46.0
5.00 ~ 30.00	60.0	50.0
NOTE1-The lower limit shall apply at the transition frequencies. NOTE2-The limit decreases linearly with the logarithm of the frequency in the range 0.15MHz to 0.50MHz.		

8.2.4 Test Configuration

Test according to clause 7.3 conducted emission test setup

8.2.5 Test Procedure

The EUT is put on the plane 0.8m high above the ground by insulating support and connected to the AC mains through Line Impedance Stability Network (L.I.S.N). This provided a 50ohm coupling impedance for the tested equipments. Both sides of AC line are investigated to find out the maximum conducted emission according to the FCC regulations during conducted emission measurement. The bandwidth of the test receiver (R&S ESU) is set at 9KHz in 150KHz~30MHz and 200Hz in 9KHz~150KHz. The frequency range from 150kHz to 30MHz is investigated.

8.2.6 Test Results

PASS.

Please refer to the following pages.

Test Data:

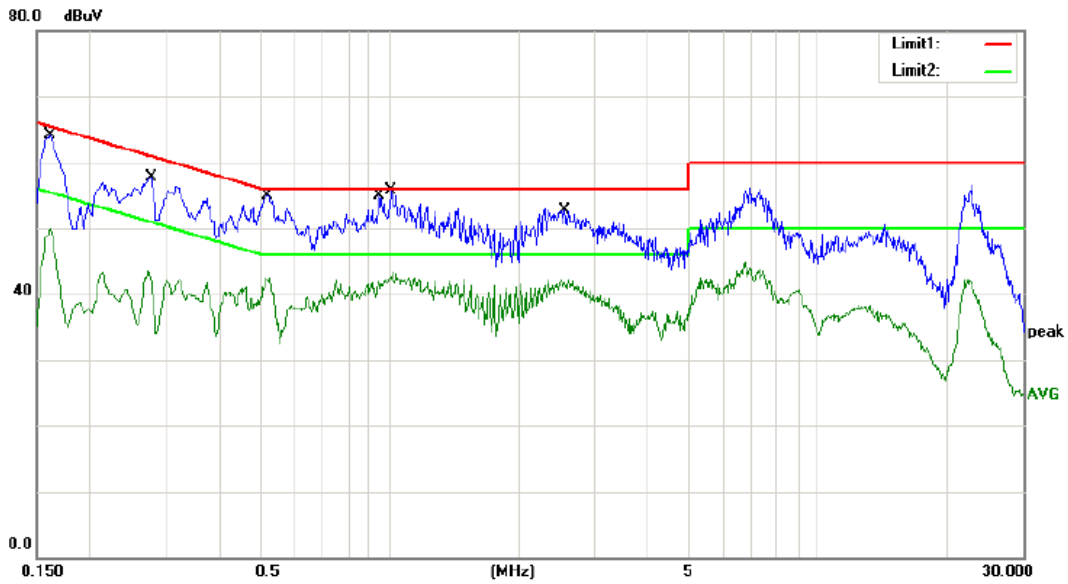

Site: site #1
 Phase: L1
 Temperature: 21
 Limit: (CE)FCC PART 15 class B_QP
 Power: AC 480V/60Hz
 Humidity: 55 %
 EUT: LED Surface Mounted Luminaire
 Mode: ON
 Note:

No.	Mk.	Freq. MHz	Reading Level dBuV	Correct Factor dB	Measure- ment dBuV	Limit dBuV	Over dB	Detector	Comment
1		0.1620	50.90	10.10	61.00	65.36	-4.36	QP	
2		0.1620	39.80	10.10	49.90	55.36	-5.46	AVG	
3		0.2780	44.50	10.09	54.59	60.88	-6.29	QP	
4		0.2780	30.60	10.09	40.69	50.88	-10.19	AVG	
5		0.5181	41.80	10.07	51.87	56.00	-4.13	QP	
6		0.5181	31.90	10.07	41.97	46.00	-4.03	AVG	
7		0.9460	41.90	10.00	51.90	56.00	-4.10	QP	
8		0.9460	31.90	10.00	41.90	46.00	-4.10	AVG	
9		1.0060	41.60	9.99	51.59	56.00	-4.41	QP	
10	*	1.0060	32.20	9.99	42.19	46.00	-3.81	AVG	
11		2.5620	39.60	10.15	49.75	56.00	-6.25	QP	
12		2.5620	31.50	10.15	41.65	46.00	-4.35	AVG	

*:Maximum data x:Over limit !:over margin Comment: Factor build in receiver. Operator: ZHANG

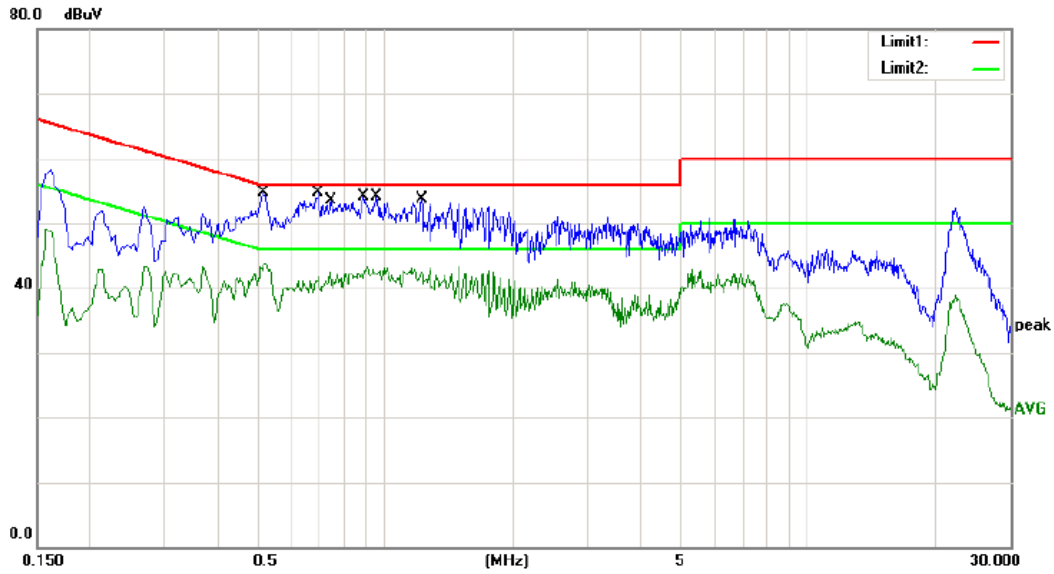

Site site #1 Phase: **L2** Temperature: 21
 Limit: (CE)FCC PART 15 class B_QP Power: AC 480V/60Hz Humidity: 55 %
 Mode: ON
 Note:

No.	Mk.	Freq.	Reading Level	Correct Factor	Measurement	Limit	Over	Detector	Comment
		MHz	dBuV	dB	dBuV	dBuV	dB		
1		0.5180	41.70	9.88	51.58	56.00	-4.42	QP	
2	*	0.5180	33.00	9.88	42.88	46.00	-3.12	AVG	
3		0.6940	41.70	9.92	51.62	56.00	-4.38	QP	
4		0.6940	31.70	9.92	41.62	46.00	-4.38	AVG	
5		0.7460	40.40	9.93	50.33	56.00	-5.67	QP	
6		0.7460	30.90	9.93	40.83	46.00	-5.17	AVG	
7		0.8860	41.00	9.96	50.96	56.00	-5.04	QP	
8		0.8860	31.60	9.96	41.56	46.00	-4.44	AVG	
9		0.9580	41.10	9.98	51.08	56.00	-4.92	QP	
10		0.9580	32.00	9.98	41.98	46.00	-4.02	AVG	
11		1.2220	40.70	10.03	50.73	56.00	-5.27	QP	
12		1.2220	32.50	10.03	42.53	46.00	-3.47	AVG	

*:Maximum data x:Over limit !:over margin Comment: Factor build in receiver. Operator: ZHANG

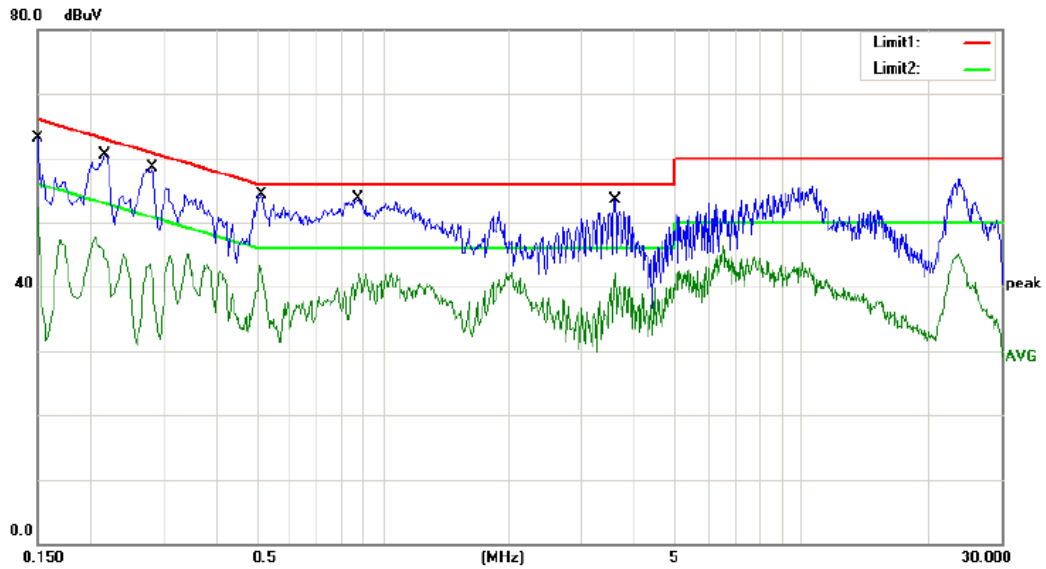

Site site #1 Phase: **L1** Temperature: 21
 Limit: (CE)FCC PART 15 class B_QP Power: AC 347V/60Hz Humidity: 55 %
 Mode: ON
 Note:

No.	Mk.	Freq.	Reading Level	Correct Factor	Measurement	Limit	Over	Detector	Comment
		MHz	dBuV	dB	dBuV	dBuV	dB		
1		0.1500	51.00	10.10	61.10	66.00	-4.90	QP	
2	*	0.1500	42.20	10.10	52.30	56.00	-3.70	AVG	
3		0.2172	48.30	10.09	58.39	62.93	-4.54	QP	
4		0.2172	34.30	10.09	44.39	52.93	-8.54	AVG	
5		0.2816	46.30	10.09	56.39	60.77	-4.38	QP	
6		0.2816	31.90	10.09	41.99	50.77	-8.78	AVG	
7		0.5127	42.10	10.07	52.17	56.00	-3.83	QP	
8		0.5127	32.00	10.07	42.07	46.00	-3.93	AVG	
9		0.8756	41.60	10.01	51.61	56.00	-4.39	QP	
10		0.8756	32.00	10.01	42.01	46.00	-3.99	AVG	
11		3.5842	41.30	10.24	51.54	56.00	-4.46	QP	
12		3.5842	31.90	10.24	42.14	46.00	-3.86	AVG	

*:Maximum data x:Over limit !:over margin Comment: Factor build in receiver. Operator: ZHANG

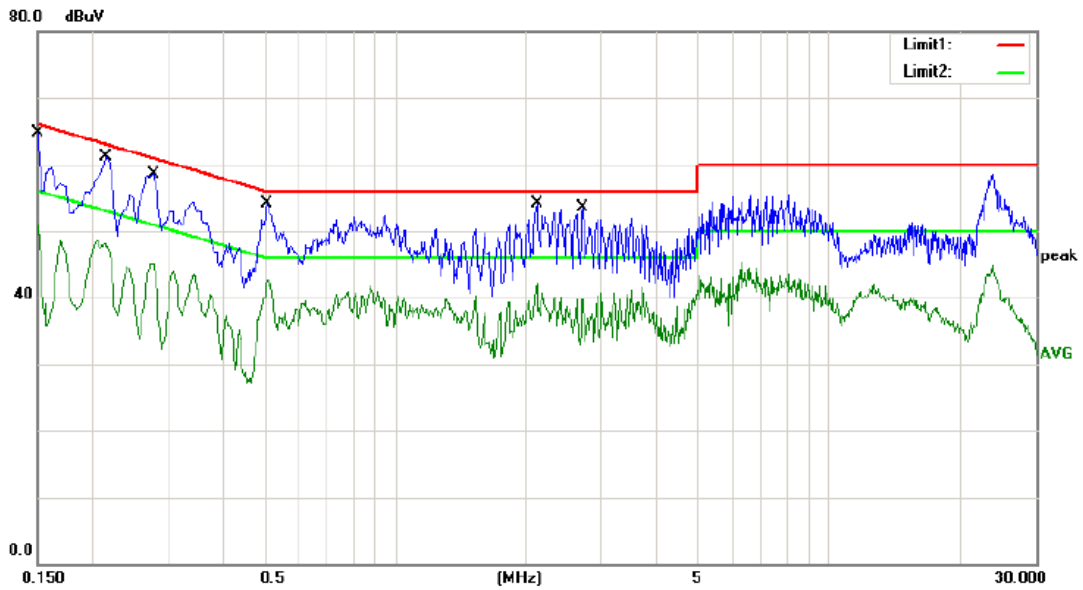

Site site #1 Phase: **L2** Temperature: 21
 Limit: (CE)FCC PART 15 class B_QP Power: AC 347V/60Hz Humidity: 55 %
 Mode: ON
 Note:

No.	Mk.	Freq.	Reading Level	Correct Factor	Measurement	Limit	Over	Detector	Comment
		MHz	dBuV	dB	dBuV	dBuV	dB		
1	*	0.1500	52.50	10.10	62.60	66.00	-3.40	QP	
2		0.1500	40.80	10.10	50.90	56.00	-5.10	AVG	
3		0.2162	49.00	10.09	59.09	62.96	-3.87	QP	
4		0.2162	37.50	10.09	47.59	52.96	-5.37	AVG	
5		0.2772	46.30	10.09	56.39	60.90	-4.51	QP	
6		0.2772	34.40	10.09	44.49	50.90	-6.41	AVG	
7		0.5072	41.90	10.07	51.97	56.00	-4.03	QP	
8		0.5072	32.50	10.07	42.57	46.00	-3.43	AVG	
9		2.1213	42.00	10.12	52.12	56.00	-3.88	QP	
10		2.1213	27.80	10.12	37.92	46.00	-8.08	AVG	
11		2.7067	41.20	10.17	51.37	56.00	-4.63	QP	
12		2.7067	29.60	10.17	39.77	46.00	-6.23	AVG	

*:Maximum data x:Over limit !:over margin Comment: Factor build in receiver. Operator: ZHANG

8.3 RADIATED SPURIOUS EMISSION

8.3.1 Block Diagram of Test Setup

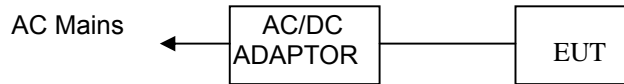

8.3.2 Applicable Standard

According to FCC Part 15.249 and 15.109

8.3.3 Conformance Limit

According to FCC Part 15.249: radiated emissions which fall in the restricted bands, as defined in §15.205(a), must also comply with the radiated emission limits specified in §15.209 (see §15.205(c)).

According to FCC Part 15.205, Restricted bands

MHz	MHz	MHz	GHz
0.090-0.110	16.42-16.423	399.9-410	4.5-5.15
10.495-0.505	16.69475-16.69525	608-614	5.35-5.46
2.1735-2.1905	16.80425-16.80475	960-1240	7.25-7.75
4.125-4.128	25.5-25.67	1300-1427	8.025-8.5
4.17725-4.17775	37.5-38.25	1435-1626.5	9.0-9.2
4.20725-4.20775	73-74.6	1645.5-1646.5	9.3-9.5
6.215-6.218	74.8-75.2	1660-1710	10.6-12.7
6.26775-6.26825	123-138	2200-2300	14.47-14.5
8.291-8.294	149.9-150.05	2310-2390	15.35-16.2
8.362-8.366	156.52475-156.52525	2483.5-2500	17.7-21.4
8.37625-8.38675	156.7-156.9	2690-2900	22.01-23.12
8.41425-8.41475	162.0125-167.17	3260-3267	23.6-24.0
12.29-12.293	167.72-173.2	3332-3339	31.2-31.8
12.51975-12.52025	240-285	3345.8-3358	36.43-36.5
12.57675-12.57725	322-335.4	3600-4400	(2)
13.36-13.41			

According to FCC Part 15.209, Except as provided elsewhere in this subpart, the emissions from an intentional radiator shall not exceed the field strength levels specified in the following table:

Frequencies (MHz)	Field Strength (micorvolts/meter)	Measurement Distance (meters)
0.009~0.490	2400/F(KHz)	300
0.490~1.705	24000/F(KHz)	30
1.705~30.0	30	30
30~88	100	3
88~216	150	3
216~960	200	3
960~1000	500	3

Remark :1. Emission level in dBuV/m=20 log (uV/m)

2. Measurement was performed at an antenna to the closed point of EUT distance of meters.

3. Distance extrapolation factor =40log(Specific distance/ test distance)(dB);

Limit line=Specific limits(dBuV) + distance extrapolation factor.

for the frequency ranges below 30 MHz, a narrower RBW is used for these ranges but the measured value should add a RBW correction factor (RBWCF) where RBWCF [dB] =10*Ig(100 [kHz]/narrower RBW [kHz]). , the narrower RBW is 1 kHz and RBWCF is 20 dB for the frequency 9 kHz to 150 kHz, and the narrower RBW is 10 kHz and RBWCF is 10 dB for the frequency 150 kHz to 30 MHz.

Field strength of fundamental and Field strength of harmonics Limit:

Fundamental frequency	Field strength of fundamental (millivolts/meter)	Field strength of harmonics (microvolts/meter)
902-928 MHz	50(94 dBV/m)	500(54 dBV/m)
2400-2483.5 MHz	50(94 dBV/m)	500(54 dBV/m)
5725-5875 MHz	50(94 dBV/m)	500(54 dBV/m)
24.0-24.25 GHz	250(108 dBV/m)	2500(68 dBV/m)

8.3.4 Test Configuration

Test according to clause 7.2 radio frequency test setup 2

8.3.5 Test Procedure

This test is required for any spurious emission that falls in a Restricted Band, as defined in Section 15.205. It must be performed with the highest gain of each type of antenna proposed for use with the EUT. Use the following spectrum analyzer settings:

For Above 1GHz:

The EUT was placed on a turn table which is 1.5m above ground plane.

Maximum procedure was performed on the highest emissions to ensure EUT compliance.

Span = wide enough to fully capture the emission being measured

RBW = 1 MHz

VBW \geq RBW

Sweep = auto

Detector function = peak

Trace = max hold

For Below 1GHz:

The EUT was placed on a turn table which is 0.8m above ground plane.

Maximum procedure was performed on the highest emissions to ensure EUT compliance.

Span = wide enough to fully capture the emission being measured

RBW = 100 kHz for

VBW \geq RBW

Sweep = auto

Detector function = peak

Trace = max hold

For Below 30MHz:

The EUT was placed on a turn table which is 0.8m above ground plane.

Maximum procedure was performed on the highest emissions to ensure EUT compliance.

Span = wide enough to fully capture the emission being measured

RBW = 9kHz

VBW \geq RBW

Sweep = auto

Detector function = peak

Trace = max hold

For Below 150KHz:

The EUT was placed on a turn table which is 0.8m above ground plane.

Maximum procedure was performed on the highest emissions to ensure EUT compliance.

Span = wide enough to fully capture the emission being measured

RBW = 200Hz

VBW \geq RBW

Sweep = auto

Detector function = peak

Trace = max hold

Follow the guidelines in ANSI C63.10-2013 with respect to maximizing the emission by rotating the EUT,

measuring the emission while the EUT is situated in three orthogonal planes (if appropriate), adjusting the measurement antenna height and polarization, etc. A pre-amp and a high pass filter are required for this test, in order to provide the measuring system with sufficient sensitivity. Allow the trace to stabilize. The peak reading of the emission, after being corrected by the antenna factor, cable loss, pre-amp gain, etc., is the peak field strength, which must comply with the limit specified in Section 15.35(b). Submit this data. Now set the VBW to 10 Hz, while maintaining all of the other instrument settings. This peak level, once corrected, must comply with the limit specified in Section 15.209. If the dwell time per channel of the hopping signal is less than 100 ms, then the reading obtained with the 10 Hz VBW may be further adjusted by a “duty cycle correction factor”, derived from $20\log(\text{dwell time}/100 \text{ ms})$, in an effort to demonstrate compliance with the 15.209 limit. Submit this data.

Repeat above procedures until all frequency measured was complete.

8.3.6 Test Results

■ Spurious Emission below 30MHz (9KHz to 30MHz)

Temperature:	22 °C	Test Date:	Nov 11, 2018
Humidity:	53 %	Test By:	King Kong
Test mode:	TX Mode		

Freq. (MHz)	Ant.Pol. X/Y/Z	Emission Level(dBuV/m)		Limit 3m(dBuV/m)		Over(dB)	
		PK	AV	PK	AV	PK	AV
--	--	--	--	--	--	--	--

Note: the amplitude of spurious emission that is attenuated by more than 20dB below the permissible limit has no need to be reported.

Distance extrapolation factor = $40\log(\text{Specific distance}/ \text{test distance})$ (dB);

Limit line=Specific limits(dBuV) + distance extrapolation factor

■ Spurious Emission below 1GHz (30MHz to 1GHz)

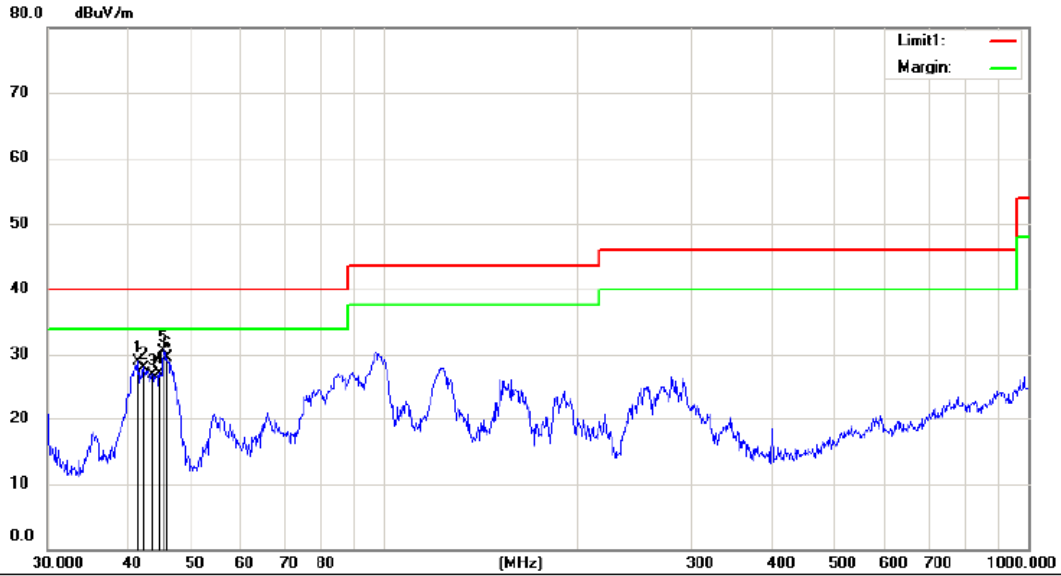

Site site #1 Polarization: *Horizontal* Temperature: 22 C
 Limit: FCC Part15 Class B 3M Radiation Power: AC 480V/50Hz Humidity: 51 %
 Mode:ON
 Note:

No.	Mk.	Freq.	Reading Level	Correct Factor	Measurement	Limit	Over	Antenna Height	Table Degree	
		MHz	dBuV	dB	dBuV/m	dBuV/m	dB	cm	degree	Comment
1		41.5670	49.35	-20.35	29.00	40.00	-11.00			QP
2		42.3022	48.22	-20.22	28.00	40.00	-12.00			QP
3		43.6584	47.07	-20.07	27.00	40.00	-13.00			QP
4		44.7433	47.01	-19.81	27.20	40.00	-12.80			QP
5	*	45.3754	50.21	-19.61	30.60	40.00	-9.40			QP
6		46.0162	48.92	-19.42	29.50	40.00	-10.50			QP

*:Maximum data x:Over limit !:over margin

Operator:

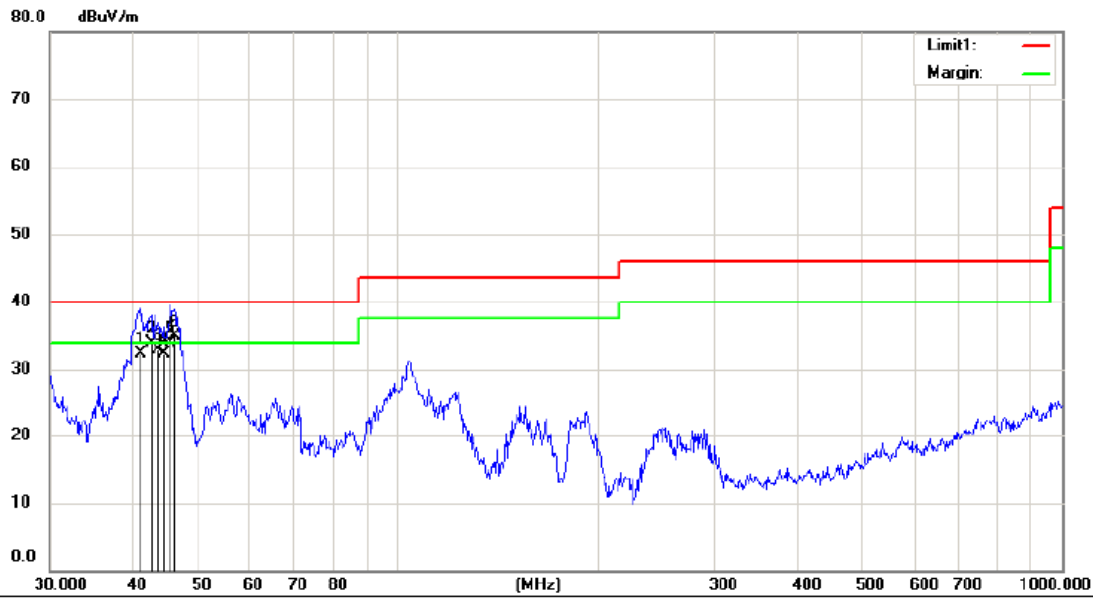

Site site #1 Polarization: *Vertical* Temperature: 22 C
 Limit: FCC Part15 Class B 3M Radiation Power: AC 480V/50Hz Humidity: 51 %
 Mode:ON
 Note:

No.	Mk.	Freq.	Reading Level	Correct Factor	Measurement	Limit	Over	Antenna Height	Table Degree	
		MHz	dBuV	dB	dBuV/m	dBuV/m	dB	cm	degree	Comment
1		41.1320	52.73	-20.43	32.30	40.00	-7.70			QP
2		42.6000	54.19	-20.19	34.00	40.00	-6.00			QP
3		43.6584	53.07	-20.07	33.00	40.00	-7.00			QP
4		44.4307	52.30	-19.90	32.40	40.00	-7.60			QP
5		45.5348	53.56	-19.56	34.00	40.00	-6.00			QP
6	*	46.1780	54.36	-19.46	34.90	40.00	-5.10			QP

*:Maximum data x:Over limit !:over margin

Operator:

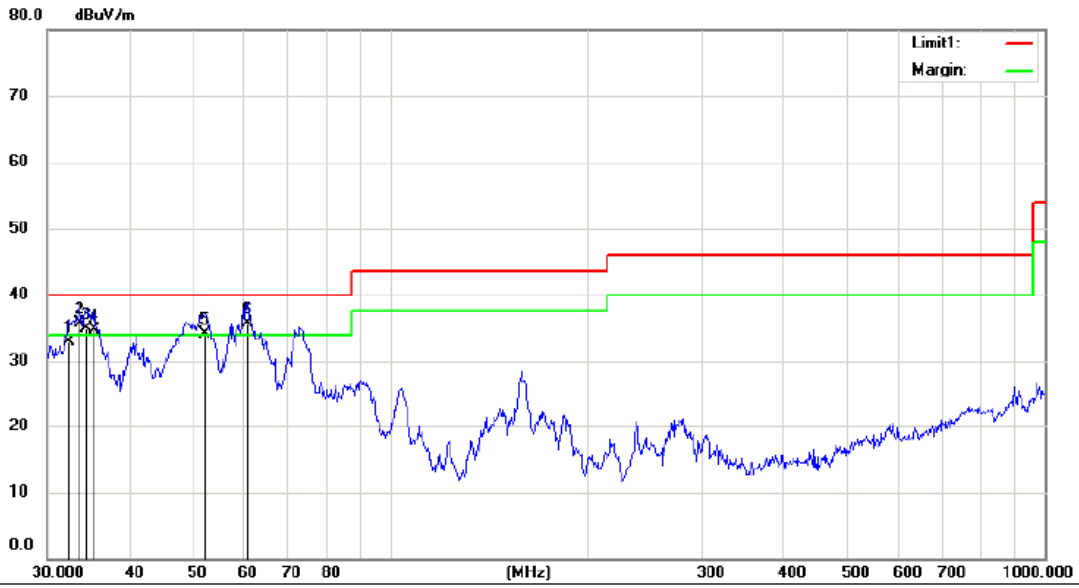

Site site #1 Polarization: **Vertical** Temperature: 22 C
 Limit: FCC Part15 Class B 3M Radiation Power: AC 347V/50Hz Humidity: 51 %
 Mode:ON
 Note:

No.	Mk.	Freq.	Reading Level	Correct Factor	Measurement	Limit	Over	Antenna Height	Table Degree	
		MHz	dBuV	dB	dBuV/m	dBuV/m	dB	cm	degree	Comment
1		32.4060	56.08	-23.08	33.00	40.00	-7.00			QP
2	!	33.5623	58.25	-22.55	35.70	40.00	-4.30			QP
3	!	34.3962	57.40	-22.40	35.00	40.00	-5.00			QP
4	!	35.3750	57.24	-22.54	34.70	40.00	-5.30			QP
5	!	52.2077	53.67	-19.57	34.10	40.00	-5.90			QP
6	*	60.7043	57.76	-21.96	35.80	40.00	-4.20			QP

*:Maximum data x:Over limit !:over margin

Operator:

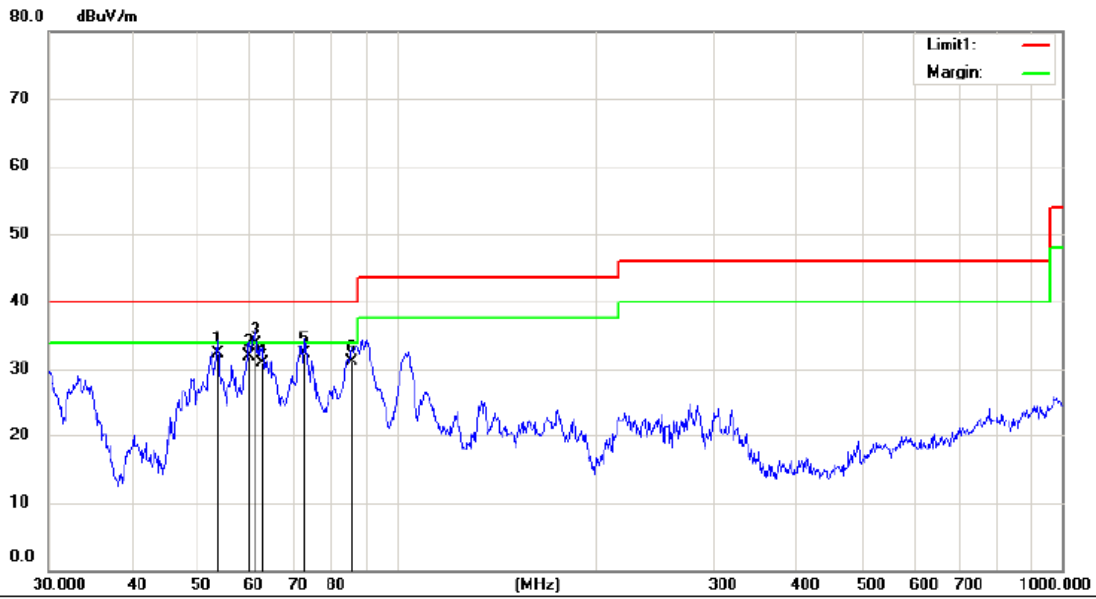

Site site #1 Polarization: **Horizontal** Temperature: 22 C
 Limit: FCC Part15 Class B 3M Radiation Power: AC 347V/50Hz Humidity: 51 %
 Mode:ON
 Note:

No.	Mk.	Freq.	Reading Level	Correct Factor	Measurement	Limit	Over	Antenna Height	Table Degree	
		MHz	dBuV	dB	dBuV/m	dBuV/m	dB	cm	degree	Comment
1		53.8817	51.85	-19.55	32.30	40.00	-7.70			QP
2		60.0690	53.83	-21.83	32.00	40.00	-8.00			QP
3	*	61.5617	55.92	-22.12	33.80	40.00	-6.20			QP
4		62.8706	53.38	-22.38	31.00	40.00	-9.00			QP
5		72.8465	57.42	-25.02	32.40	40.00	-7.60			QP
6		85.5973	56.22	-25.12	31.10	40.00	-8.90			QP

*:Maximum data x:Over limit !:over margin

Operator:

■ Spurious Emission Above 1GHz (1GHz to 40GHz)

Temperature :	22°C	Test Date :	Nov 11, 2018
Humidity :	53 %	Test By:	King Kong

Freq. (MHz)	Ant.Pol. H/V	Emission Level(dBuV/m)		Limit 3m(dBuV/m)		Over(dB)	
		PK	AV	PK	AV	PK	AV
3992.000	V	48.06	29.70	74.00	54.00	-25.94	-24.30
5196.875	V	49.52	30.40	74.00	54.00	-24.48	-23.60
11542.125	V	70.29	50.40	74.00	54.00	-3.71	-3.60
17313.625	V	69.34	50.80	74.00	54.00	-4.66	-3.20
--	--	--	--	--	--	--	--
5220.250	H	49.16	30.20	74.00	54.00	-24.84	-23.80
6308.250	H	50.34	31.50	74.00	54.00	-23.66	-22.50
11542.125	H	69.93	50.20	74.00	54.00	-4.07	-3.80
17313.625	H	70.06	49.50	74.00	54.00	-3.94	-4.50

- Note:**
- (1) All Readings are Peak Value (VBW=3MHz) and Peak Value (VBW=10Hz).
 - (2) Emission Level= Reading Level+Probe Factor +Cable Loss.
 - (3) Data of measurement within this frequency range shown “ -- ” in the table above means the reading of emissions are attenuated more than 20dB below the permissible limits or the field strength is too small to be measured.

8.4 BAND EDGES TEST

8.4.1 Applicable Standard

According to 15.249(d), out band emission except for harmonics shall be comply with §15.209 or at least attenuated by 50 dB below the level of the fundamental.

8.4.2 Test Configuration

Test according to clause 7.1 radio frequency test setup 1

8.4.3 Test Procedure

Test according to clause 8.2.4

8.4.4 Test Results

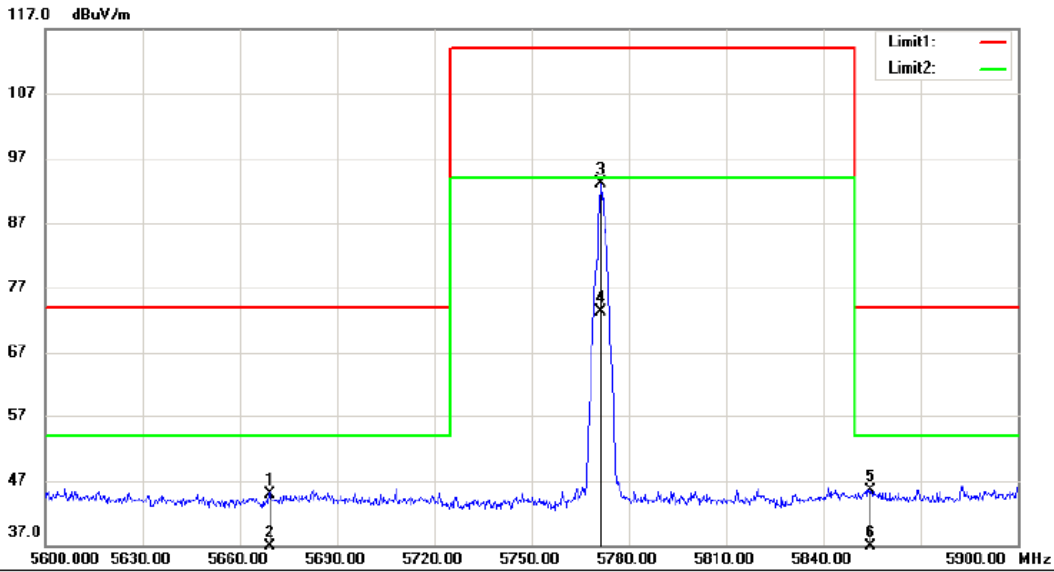

Site site #1 Polarization: **Horizontal** Temperature: 24 C
 Limit: (RE)FCC PART 15 CLASS C(Bandedge)-Peak Power: AC 480V/60Hz Humidity: 53 %
 Mode:TX
 Note:

No.	Mk.	Freq.	Reading Level	Correct Factor	Measurement	Limit	Over	Antenna Height	Table Degree	Comment
		MHz	dBuV	dB	dBuV/m	dBuV/m	dB	cm	degree	
1		5669.300	58.31	-13.48	44.83	74.00	-29.17	peak		
2		5669.300	38.24	-13.48	24.76	54.00	-29.24	AVG		
3		5771.300	106.46	-13.31	93.15	114.00	-20.85	peak		
4	*	5771.300	86.52	-13.31	73.21	94.00	-20.79	AVG		
5		5854.400	58.72	-13.17	45.55	74.00	-28.45	peak		
6		5854.400	38.82	-13.17	25.65	54.00	-28.35	AVG		

*:Maximum data x:Over limit !:over margin

Operator: KK

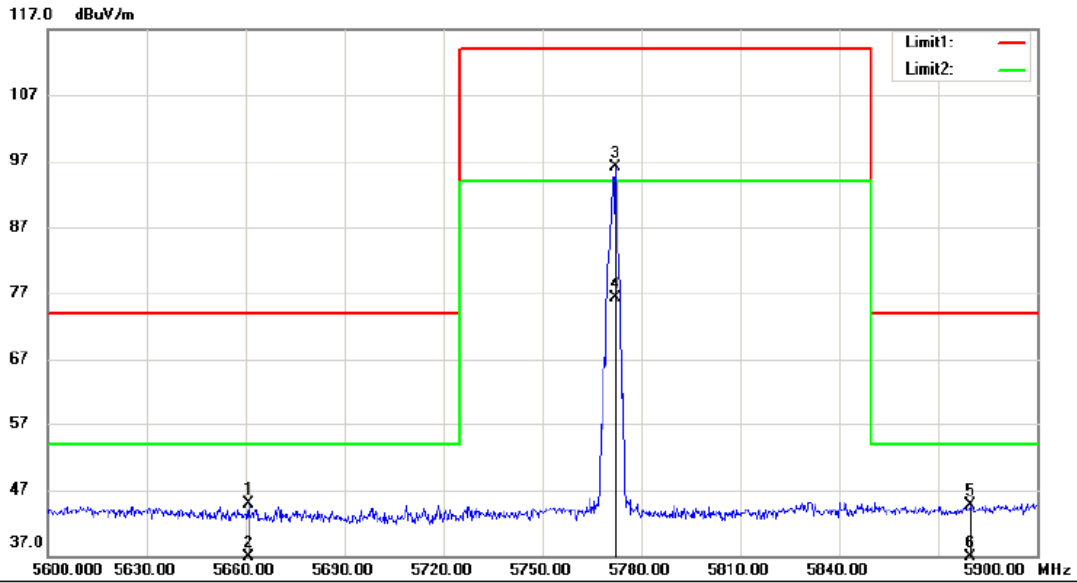

Site site #1 Polarization: *Vertical* Temperature: 24 C
 Limit: (RE)FCC PART 15 CLASS C(Bandedge)-Peak Power: AC 480V/60Hz Humidity: 53 %
 Mode:TX
 Note:

No.	Mk.	Freq.	Reading Level	Correct Factor	Measurement	Limit	Over	Antenna Height	Table Degree	Comment
		MHz	dBuV	dB	dBuV/m	dBuV/m	dB	cm	degree	
1		5660.900	58.31	-13.49	44.82	74.00	-29.18			peak
2		5660.900	38.28	-13.49	24.79	54.00	-29.21			AVG
3		5772.200	109.41	-13.31	96.10	114.00	-17.90			peak
4	*	5772.200	89.52	-13.31	76.21	94.00	-17.79			AVG
5		5879.600	57.81	-13.12	44.69	74.00	-29.31			peak
6		5879.600	37.70	-13.12	24.58	54.00	-29.42			AVG

*:Maximum data x:Over limit !:over margin

Operator: KK

8.5 ANTENNA APPLICATION

8.5.1 Antenna Requirement

Standard	Requirement
FCC CRF Part 15.203	An intentional radiator shall be designed to ensure that no antenna other than that furnished by the responsible party shall be used with the device. The use of a permanently attached antenna or of an antenna that uses a unique coupling to the intentional radiator shall be considered sufficient to comply with the provisions of this section. The manufacturer may design the unit so that a broken antenna can be replaced by the user, but the use of a standard antenna jack or electrical connector is prohibited. This requirement does not apply to carrier current devices or to devices operated under the provisions of §15.211, §15.213, §15.217, §15.219, or §15.221. Further, this requirement does not apply to intentional radiators that must be professionally installed, such as perimeter protection systems and some field disturbance sensors, or to other intentional radiators which, in accordance with §15.31(d), must be measured at the installation site. However, the installer shall be responsible for ensuring that the proper antenna is employed so that the limits in this part are not exceeded.

For intentional device, according to FCC 47 CFR Section 15.203, an intentional radiator shall be designed to ensure that no antenna other than that furnished by the responsible party shall be used with the device.

8.5.2 Result

PASS.

- Note:
- Antenna use a permanently attached antenna which is not replaceable.
 - Not using a standard antenna jack or electrical connector for antenna replacement
 - The antenna has to be professionally installed (please provide method of installation)

which in accordance to section 15.203, please refer to the internal photos.