

**ELECTROMAGNETIC EMISSIONS COMPLIANCE REPORT
INTENTIONAL RADIATOR CERTIFICATION TO
FCC PART 15 SUBPART B & C REQUIREMENT**

OF

LED Surface Mounted Luminaire

MODEL No.: TOP8232-LED-U-X-Sensor, TOPA224-LED-U-X-Sensor

FCC ID: 2AH36-SENSOR

REPORT NO: ES160325016E

ISSUE DATE: May 3, 2016

Prepared for
NINGBO TOP OPTOELECTRONIC TECHNOLOGY CO.,LTD
329 NATIONALHWY SANBEI TOWN NINGBO, ZHEJIANG 315331 CHINA

Prepared by
EMTEK (SHENZHEN) CO., LTD.
Building 69, Majialong Industry Zone, Nanshan District, Shenzhen, Guangdong, China
Tel: +86-755-26954280
Fax: +86-755-26954282

VERIFICATION OF COMPLIANCE

Applicant:	NINGBO TOP OPTOELECTRONIC TECHNOLOGY CO.,LTD 329 NATIONALHWY SANBEI TOWN NINGBO, ZHEJIANG 315331 CHINA
Product Description:	LED Surface Mounted Luminaire
Model Number:	TOP8232-LED-U-X-Sensor, TOPA224-LED-U-X-Sensor (Note: 'X' indicates CCT, between 2700K and 6500K. We prepared TOPA224-LED-U-4000K-Sensor for test.)
File Number:	ES160325016E
Date of Test:	March 21, 2016 to April 30, 2016

We hereby certify that:

The above equipment was tested by EMTEK (SHENZHEN) CO., LTD. The test data, data evaluation, test procedures, and equipment configurations shown in this report were made in accordance with the procedures given in ANSI C63.10 (2013) and the energy emitted by the sample EUT tested as described in this report is in compliance with conducted and radiated emission limits of FCC Rules Part 15.249(2015).

The test results of this report relate only to the tested sample identified in this report.

Date of Test : March 21, 2016 to April 30, 2016

Prepared by : 
Joe Xia /Editor

Reviewer : 
Yaping Shen /Supervisor

Approve & Authorized Signer : 
Lisa Wang/Manager

TABLE OF CONTENTS

1. GENERAL INFORMATION.....	4
1.1. Product Description.....	4
1.2. Related Submittal(s) / Grant (s)	4
1.3. Test Methodology	4
1.4. Special Accessories	4
1.5. Equipment Modifications.....	4
1.6. Test Facility.....	5
1.7. Measurement Uncertainty	5
2. SYSTEM TEST CONFIGURATION	6
2.1. EUT Configuration	6
2.2. EUT Exercise	6
2.3. Requirement for Compliance	6
2.4. Configuration of Tested System.....	8
2.5. Description of support units.....	8
3. SUMMARY OF TEST RESULTS	9
4. DESCRIPTION OF TEST MODES.....	9
5. BANDWIDTH TEST.....	10
5.1. Measurement Procedure.....	10
5.2. Measurement Equipment Used	10
5.3. Test Procedure.....	10
5.4. Test Results	11
6. CONDUCTED EMISSIONS TEST	12
6.1. Measurement Procedure.....	12
6.2. Test SET-UP	12
6.3. Measurement Equipment Used	12
6.4. Conducted Measurement Result	12
7. RADIATED EMISSION TEST	17
7.1. Measurement Procedure.....	17
7.2. Measurement Equipment Used	17
7.3. Test SET-UP.....	18
7.4. Radiated Measurement Result	18
8. BAND EDGES MEASUREMENT.....	24
8.1. Standard Applicable	24
8.2. Measurement Procedure.....	24
8.3. Measurement Equipment	24
8.4. Test Setup.....	24
8.5. Test Results	24
9. ANTENNA APPLICATION.....	29
9.1. Standard Applicable	29
9.2. Antenna Construction	29

1. GENERAL INFORMATION

1.1. Product Description

The EUT is a short range, lower power, Details of technical specification, refers to the description in follows:

- a. Operating frequency: 5772.0MHz
- b. Number of Channel: 1
- c. Antenna Designation: Integral antenna
- d. Modulation: Continuous Wave
- e. Antenna Gain: 0dbi
- f. Power Supply: 120-277V/AC, 50/60Hz

1.2. Related Submittal(s) / Grant (s)

This submittal(s) (test report) is intended for FCC ID: 2AH36-SENSOR filing to comply with Section 15.249 of the FCC Part 15 Subpart C Rules.

1.3. Test Methodology

Both conducted and radiated testing were performed according to the procedures in ANSI C63.10 -2013. Radiated testing was performed at an antenna to EUT distance 3 meters.

1.4. Special Accessories

Not available for this EUT intended for grant.

1.5. Equipment Modifications

Not available for this EUT intended for grant.

1.6. Test Facility

Site Description	
EMC Lab.	<p>: Accredited by CNAS, 2013.10.29 The certificate is valid until 2016.10.29 The Laboratory has been assessed and proved to be in compliance with CNAS-CL01:2006(identical to ISO/IEC17025:2005) The Certificate Registration Number is L2291.</p> <p>Accredited by TUV Rheinland Shenzhen 2010.5.25 The Laboratory has been assessed according to the requirements ISO/IEC 17025.</p> <p>Accredited by FCC, April 17, 2013 The Certificate Registration Number is 406365.</p> <p>Accredited by Industry Canada, November 29, 2012 The Certificate Registration Number is 46405-4480.</p>
Name of Firm	: EMTEK (SHENZHEN) CO., LTD
Site Location	: Bldg 69, Majialong Industry Zone, Nanshan District, Shenzhen, Guangdong, China

1.7. Measurement Uncertainty

Conducted Emission Uncertainty	: 2.96dB(9k~150kHz Conduction 1#) 2.74dB(150k-30MHz Conduction 1#)
Radiated Emission Uncertainty (3m Chamber)	: 3.78dB (30M~1GHz Polarize: H) 4.27dB (30M~1GHz Polarize: V) 4.46dB (1~6GHz) 4.96dB (6~40GHz)

2. SYSTEM TEST CONFIGURATION

2.1.EUT Configuration

The EUT configuration for testing is installed on RF field strength measurement to meet the Commissions requirement and operating in a manner which intends to maximize its emission characteristics in a continuous normal application.

2.2.EUT Exercise

The EUT (LED Surface Mounted Luminaire) has been tested under Normal Operating and standby condition. No software used to control the EUT for staying in continuous transmitting and receiving mode for testing.

2.3.Requirement for Compliance

2.3.1.Conducted Emissions

According to §15.107, For a Class A digital device that is designed to be connected to the public utility (AC) power line, the radio frequency voltage that is conducted back onto the AC power line on any frequency or frequencies within the band 150 kHz to 30 MHz shall not exceed the limits in the following table, as measured using a 50 μ H/50 ohms LISN.Compliance with the provisions of this paragraph shall be based on the measurement of the radio frequency voltage between each power line and ground at the power terminal. The lower limit applies at the boundary between the frequency ranges.

Frequency(MHz)	Quasi-peak	Average
0.15-0.5	79	66
0.5-30.0	73	60
Note: 1. The lower limit shall apply at the transition frequencies.		

2.3.2. Radiated Emissions

(a) FCC Part 15, Subpart C Section 15.109 The field strength of radiated emissions from a Class A digital device, as determined at a distance of 10 meters, shall not exceed the following:

Frequency (MHz)	Field strength $\mu\text{V/m}$	Distance(m)	Field strength at 3m $\text{dB}\mu\text{V/m}$
30-88	90	10	49.5
88-216	150	10	54.0
216-960	210	10	56.9
Above 960	300	10	60.0

Remark:

1. Emission level in $\text{dB}\mu\text{V/m} = 20 \log (\mu\text{V/m})$
2. Measurement was performed at an antenna to the closed point of EUT distance of meters.

(b) FCC Part 15, Section 15.35(b) limit of radiated emission for frequency above 1000MHz

Frequency(MHz)	$\text{dB}\mu\text{V/m}$ (at 3m)	
	PEAK	AVERAGE
Above 1000	74.0	54.0

(c) FCC Part 15, Subpart C Section 15.249(a). The field strength of emissions from intentional radiators operated within these frequency bands shall comply with the following:

Frequency(MHz)	Filed Strength of Fundamental(at 3m)		Filed Strength of Harmonics (at 3m)	
	PEAK	AVERAGE	PEAK	AVERAGE
902-928	114.0	94.0	74.0	54.0
2400-2483.5	114.0	94.0	74.0	54.0
5725-5875	114.0	94.0	74.0	54.0
24000-24250	128.0	108.0	88.0	68.0

(d) Band edge

Emission radiated outside of the specified frequency bands, except for harmonics, shall be attenuated by at least 50dB below the level of the fundamental or to the general radiated emission limits in section 15.209, whichever is the lesser attenuation.

Frequency Range(MHz)	Limit($\text{dB}\mu\text{V/m}$)	
	Peak	AV
902-928	74.0	54.0
2400-2483.5		
5725-5850		
24000-24250		

2.3.3. Antenna Requirement

For intentional device, according to §15.203, an intentional radiator shall be designed to ensure that no antenna other than that furnished by the responsible party shall be used with the device.

2.4. Configuration of Tested System

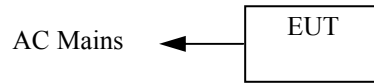

2.5. Description of support units

The EUT has been tested as an independent unit together with other necessary accessories or support units. The following support units or accessories were used to form a representative test configuration during the tests.

Item	Equipment	Mfr/Brand	Model/Type No.	FCC ID	Series No.	Note
1.	N/A	N/A	N/A	N/A	N/A	N/A

Note: Unless otherwise denoted as EUT in 『Remark』 column , device(s) used in tested system is a support equipment.

3. SUMMARY OF TEST RESULTS

FCC Rules	Description Of Test	Result
§ 15.249(a), § 15.249(d) § 15.249(e), § 15.109	Radiated Emission	Compliant
§15.107	Conducted Emission	Compliant
§15.249	Band Edge	Compliant
§15.203	Antenna Requirement	Compliant

4. DESCRIPTION OF TEST MODES

Continuously operating mode

Test Mode	Frequency(MHz)
TX	5772.0
\	\

5. BANDWIDTH TEST

5.1.Measurement Procedure

The WLAN component's antenna ports(s) of the EUT are connected to the measurement instrument per an appropriate attenuator.

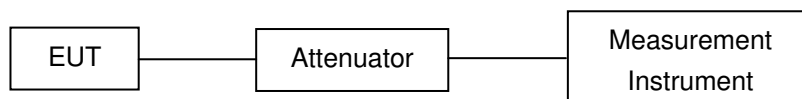

5.2.Measurement Equipment Used

EQUIPMENT TYPE	MFR	MODEL NUMBER	SERIAL NUMBER	Last Cal.	Cal. Interval
Signal Analyzer	Agilent	N9010A	My53470879	05/16/2015	1 Year

5.3.Test Procedure

The EUT was operating in controlled its channel. Printed out the test result from the spectrum by hard copy function.

The RF output of EUT was connected to the spectrum analyzer by RF cable and attenuator. The path loss was compensated to the results for each measurement.

Set to the maximum power setting and enable the EUT transmit continuously

Set RBW = 30 kHz.

Set the video bandwidth (VBW) =100 kHz.

Set Span=2 times OBW

Set Detector = Peak.

Set Trace mode = max hold.

Set Sweep = auto couple.

Allow the trace to stabilize.

Measure the maximum width of the emission that is constrained by the frequencies associated with the two outermost amplitude points (upper and lower frequencies) that are attenuated by 20 dB relative to the maximum level measured in the fundamental emission.

Measure and record the results in the test report.

5.4. Test Results

Temperature :	24°C	Test Date :	April 30, 2016
Humidity :	54 %	Test By:	King Kong

Operation Mode	Channel Frequency (MHz)	Measurement Bandwidth (KHz)	Verdict
TX	5772.0	166.8	PASS

Test Model	Bandwidth Test TX
------------	----------------------

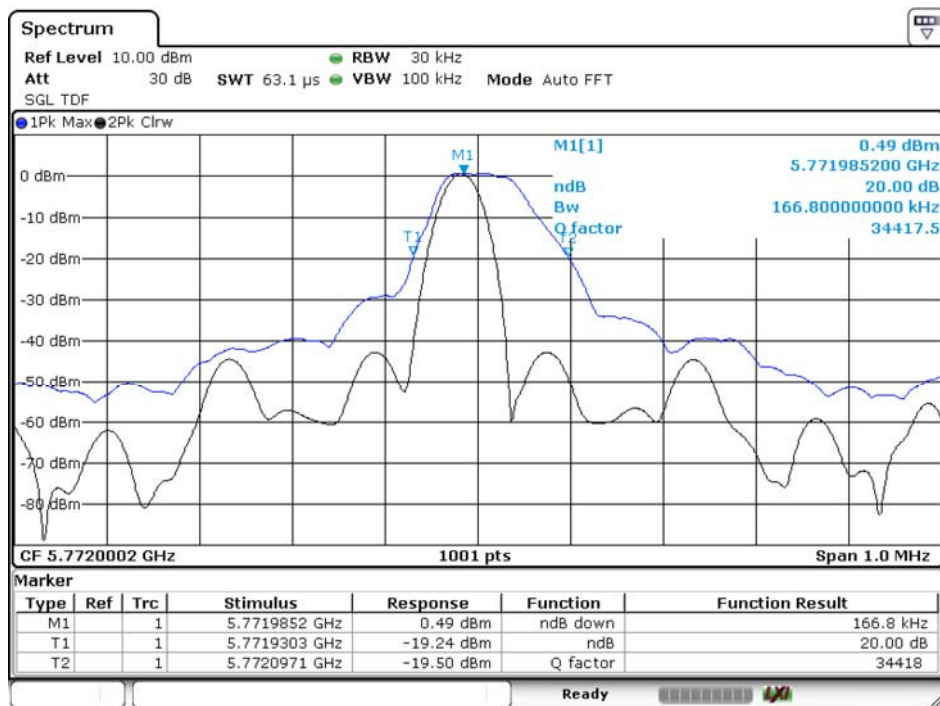

6. CONDUCTED EMISSIONS TEST

6.1. Measurement Procedure

- The EUT was placed on a table which is 0.8m above ground plane.
- Maximum procedure was performed on the three highest emissions to ensure EUT compliance.
- Repeat above procedures until all frequency measured were complete.

6.2. Test SET-UP

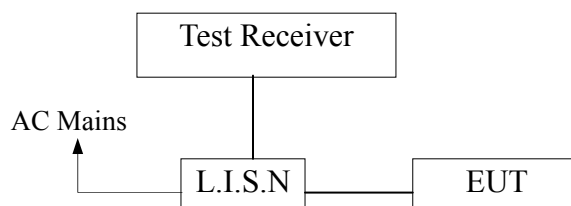

6.3. Measurement Equipment Used

EQUIPMENT TYPE	MFR	MODEL NUMBER	SERIAL NUMBER	Last Cal.	Cal. Interval
Test Receiver	Rohde & Schwarz	ESCS30	828985/018	05/16/2015	1 Year
L.I.S.N.	Rohde & Schwarz	ENV216	101161	05/16/2015	1 Year
50Ω Coaxial Switch	Anritsu	MP59B	M20531	05/16/2015	1 Year
Pulse Limiter	Rohde & Schwarz	ESH3-Z2	100006	05/16/2015	1 Year

6.4. Conducted Measurement Result

Pass.

Please refer to the following data.

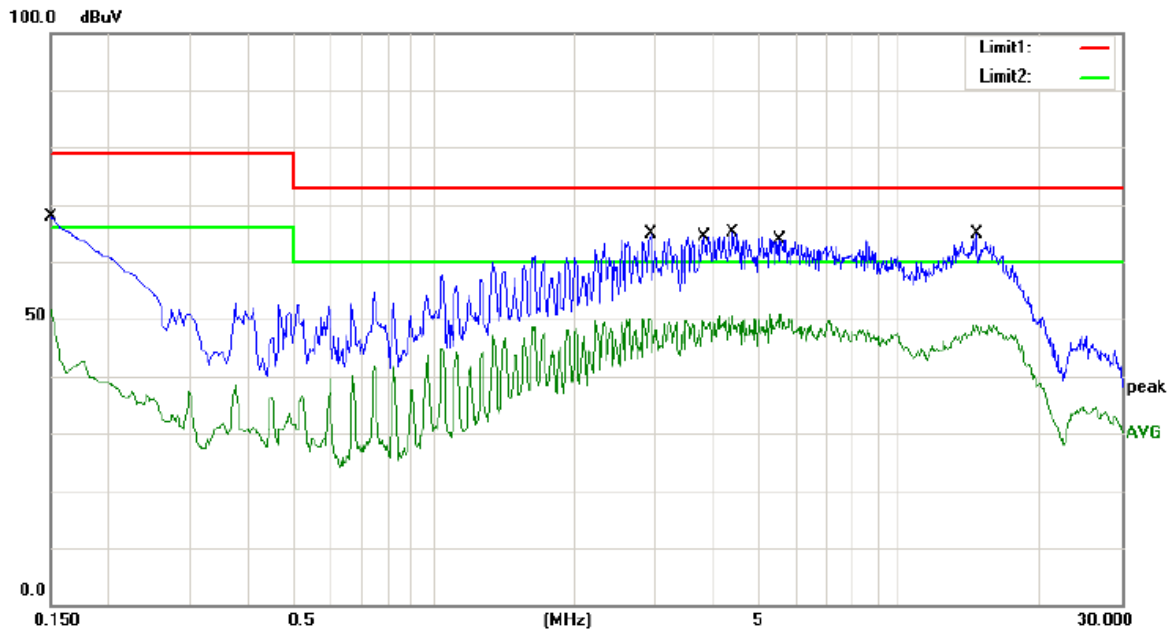

Site site #1 Phase: **L1** Temperature: 22
 Limit: (CE)FCC PART 15 class A_QP Power: AC 277V/60Hz Humidity: 50 %
 Mode: Sensor
 Note:

No. Mk.	Freq. MHz	Reading Level dBuV	Correct Factor dB	Measure- ment dBuV	Limit dBuV	Over dB	Detector	Comment
1	0.1500	56.70	11.00	67.70	79.00	-11.30	QP	
2	0.1500	40.60	11.00	51.60	66.00	-14.40	AVG	
3	2.8940	52.80	11.00	63.80	73.00	-9.20	QP	
4	2.8940	39.10	11.00	50.10	60.00	-9.90	AVG	
5	3.8140	53.40	11.00	64.40	73.00	-8.60	QP	
6	3.8140	38.40	11.00	49.40	60.00	-10.60	AVG	
7 *	4.3860	54.20	11.00	65.20	73.00	-7.80	QP	
8	4.3860	38.60	11.00	49.60	60.00	-10.40	AVG	
9	5.5800	52.40	11.00	63.40	73.00	-9.60	QP	
10	5.5800	39.80	11.00	50.80	60.00	-9.20	AVG	
11	14.6440	53.90	11.00	64.90	73.00	-8.10	QP	
12	14.6440	37.50	11.00	48.50	60.00	-11.50	AVG	

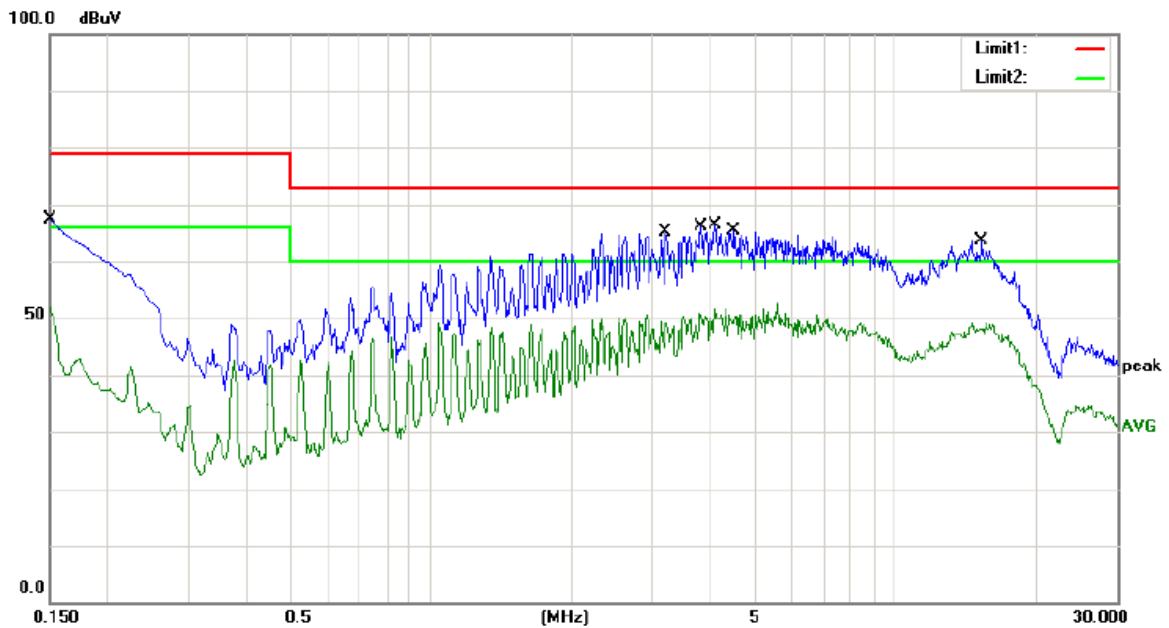

Site site #1 Phase: **N** Temperature: 22
 Limit: (CE)FCC PART 15 class A_QP Power: AC 277V/60Hz Humidity: 50 %
 Mode: Sensor
 Note:

No.	Mk.	Freq. MHz	Reading Level dBuV	Correct Factor dB	Measure- ment dBuV	Limit dBuV	Over dB	Detector	Comment
1		0.1500	56.40	11.00	67.40	79.00	-11.60	QP	
2		0.1500	40.80	11.00	51.80	66.00	-14.20	AVG	
3		3.2020	54.10	11.00	65.10	73.00	-7.90	QP	
4		3.2020	38.10	11.00	49.10	60.00	-10.90	AVG	
5		3.8020	55.17	11.00	66.17	73.00	-6.83	QP	
6		3.8020	39.51	11.00	50.51	60.00	-9.49	AVG	
7	*	4.0900	55.40	11.00	66.40	73.00	-6.60	QP	
8		4.0900	40.50	11.00	51.50	60.00	-8.50	AVG	
9		4.4940	54.30	11.00	65.30	73.00	-7.70	QP	
10		4.4940	38.00	11.00	49.00	60.00	-11.00	AVG	
11		15.3160	52.60	11.00	63.60	73.00	-9.40	QP	
12		15.3160	37.00	11.00	48.00	60.00	-12.00	AVG	

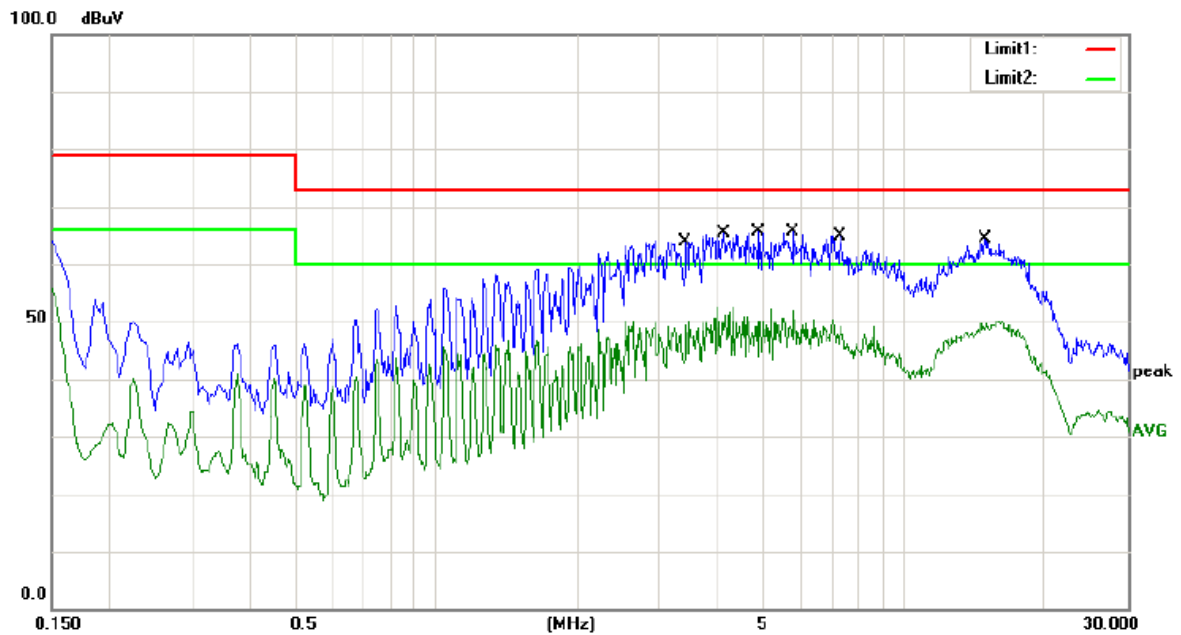

Site site #1 Phase: **N** Temperature: 22
 Limit: (CE)FCC PART 15 class A_QP Power: AC 120V/60Hz Humidity: 50 %
 Mode: Sensor
 Note:

No.	Mk.	Freq. MHz	Reading Level dBuV	Correct Factor dB	Measure- ment dBuV	Limit dBuV	Over dB	Detector	Comment
1		3.4140	52.90	11.00	63.90	73.00	-9.10	QP	
2		3.4140	38.30	11.00	49.30	60.00	-10.70	AVG	
3		4.1340	54.30	11.00	65.30	73.00	-7.70	QP	
4		4.1340	37.50	11.00	48.50	60.00	-11.50	AVG	
5	*	4.8940	54.50	11.00	65.50	73.00	-7.50	QP	
6		4.8940	39.20	11.00	50.20	60.00	-9.80	AVG	
7		5.7840	54.50	11.00	65.50	73.00	-7.50	QP	
8		5.7840	40.80	11.00	51.80	60.00	-8.20	AVG	
9		7.2640	53.90	11.00	64.90	73.00	-8.10	QP	
10		7.2640	37.10	11.00	48.10	60.00	-11.90	AVG	
11		14.8920	53.20	11.00	64.20	73.00	-8.80	QP	
12		14.8920	37.70	11.00	48.70	60.00	-11.30	AVG	

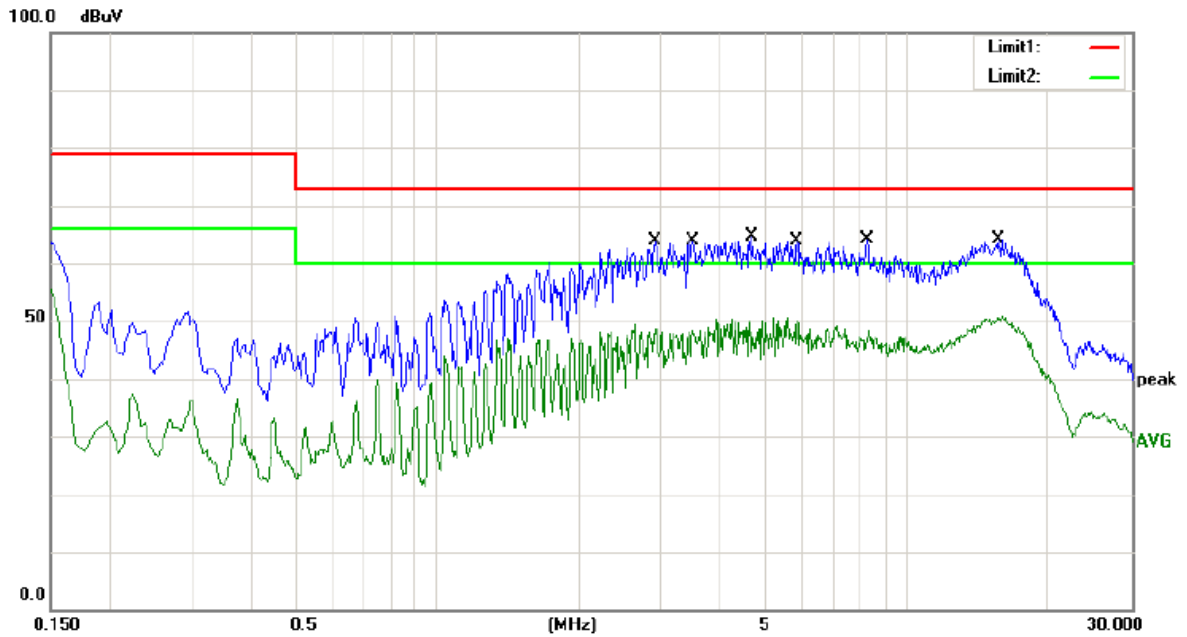

Site site #1 Phase: **L1** Temperature: 22
 Limit: (CE)FCC PART 15 class A_QP Power: AC 120V/60Hz Humidity: 50 %
 Mode: Sensor
 Note:

No.	Mk.	Freq. MHz	Reading Level dBuV	Correct Factor dB	Measure- ment dBuV	Limit dBuV	Over dB	Detector	Comment
1		2.9060	52.90	11.00	63.90	73.00	-9.10	QP	
2		2.9060	37.60	11.00	48.60	60.00	-11.40	AVG	
3		3.4940	52.90	11.00	63.90	73.00	-9.10	QP	
4		3.4940	37.40	11.00	48.40	60.00	-11.60	AVG	
5	*	4.6860	53.60	11.00	64.60	73.00	-8.40	QP	
6		4.6860	37.20	11.00	48.20	60.00	-11.80	AVG	
7		5.8120	52.90	11.00	63.90	73.00	-9.10	QP	
8		5.8120	39.10	11.00	50.10	60.00	-9.90	AVG	
9		8.2320	53.10	11.00	64.10	73.00	-8.90	QP	
10		8.2320	36.00	11.00	47.00	60.00	-13.00	AVG	
11		15.5560	53.00	11.00	64.00	73.00	-9.00	QP	
12		15.5560	39.20	11.00	50.20	60.00	-9.80	AVG	

7. RADIATED EMISSION TEST

7.1.Measurement Procedure

- d. All measurements were made at 3 meters.
- e. The EUT was placed on the top of a rotating table 0.8 meters above the ground at a 3m meter open area test site. The table was rotated 360 degrees to determine the position of the highest radiation.
- f. The height of the equipment or of the substitution antenna shall be 0.8 m; the height of the test antenna shall vary between 1 m to 4 m. Both horizontal and vertical polarizations of the antenna are set to make the measurement.

The frequency range from 30MHz to 1000MHz was pre-scanned with a peak detector (RBW=100kHz, VBW=300kHz) and all final readings of measurement from Test Receiver are Quasi-Peak values(Quasi Peak detector used with a bandwidth of 120 kHz).

The frequency range above 1GHz the measuring instrument use RBW=1 MHz and VBW=3 MHz with Peak Detector for Peak Values, and use RBW=1 MHz and VBW=10 Hz with Peak Detector for Average Values.

7.2.Measurement Equipment Used

EQUIPMENT TYPE	MFR	MODEL NUMBER	SERIAL NUMBER	Last Cal.	Cal. Interval
EMI Test Receiver	Rohde & Schwarz	ESCI	101414	May 16, 2015	1 Year
EMI Test Receiver	Rohde & Schwarz	FSV40	132.1-3008K39-10 0967-AP	May 16, 2015	1 Year
Loop Antenna	Schwarzbeck	FMZB 1519	1519-012	May 16, 2015	1 Year
Bilog Antenna	Schwarzbeck	VULB9163	660	May 16, 2015	1 Year
Horn Antenna	Schwarzbeck	BBHA 9120	1178	May 16, 2015	1 Year
Horn Antenna	Schwarzbeck	BBHA 9170	RS1307229170547	May 16, 2015	1 Year
Horn Antenna	AHS/USA	SAS-573	184	May 16, 2015	1 Year
Pre-Amplifier	LUNAR-EM	LNA30M3G-25	J10100000071	May 16, 2015	1 Year
Pre-Amplifier	Lunar EM	LNA1G18-48	J1011131010001	May 16, 2015	1 Year
Pre-Amplifier	Lunar EM	LNA18G26-40	J1012131010001	May 16, 2015	1 Year
Pre-Amplifier	Lunar EM	LNA26G40-40	J1013131028001	May 16, 2015	1 Year
Cable	H+B	NmSm-2-C15201	\	May 16, 2015	1 Year
Cable	H+B	NmNm-7-C15702	\	May 16, 2015	1 Year
Cable	H+B	NmSm-05-C15052	\	May 16, 2015	1 Year
Cable	H+B	SUCOFLEX104	MY14871/4	May 16, 2015	1 Year
Cable	H+B	BLU18A-NmSm-6500	D8501	May 16, 2015	1 Year
Cable	A.H	SAC-40G-1	414	May 16, 2015	1 Year
Cable	A.H	SAC-40G-1	413	May 16, 2015	1 Year

7.3. Test SET-UP

(a) Radiated Emission Test Set-Up, Frequency Below 30MHz

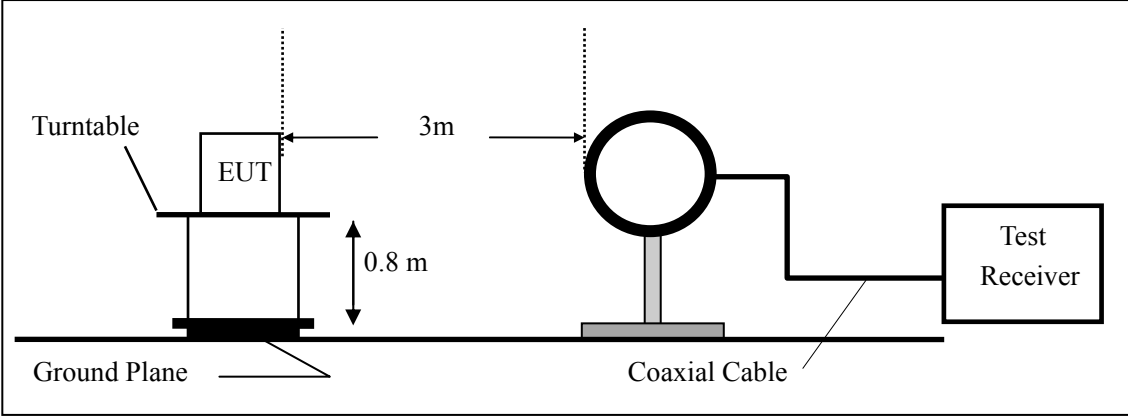

(b) Radiated Emission Test Set-Up, Frequency Below 1000MHz

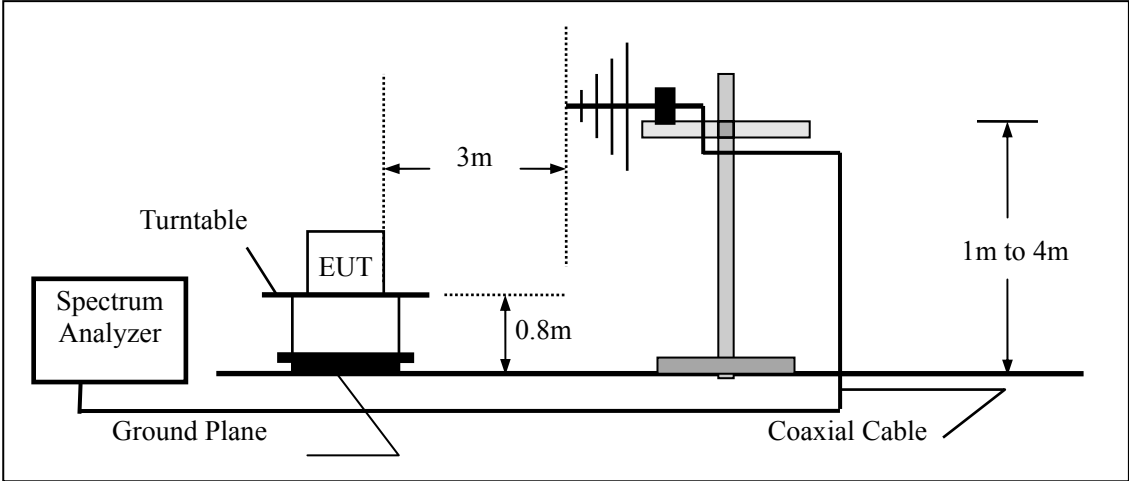

(c) Radiated Emission Test Set-Up, Frequency Above 1000MHz

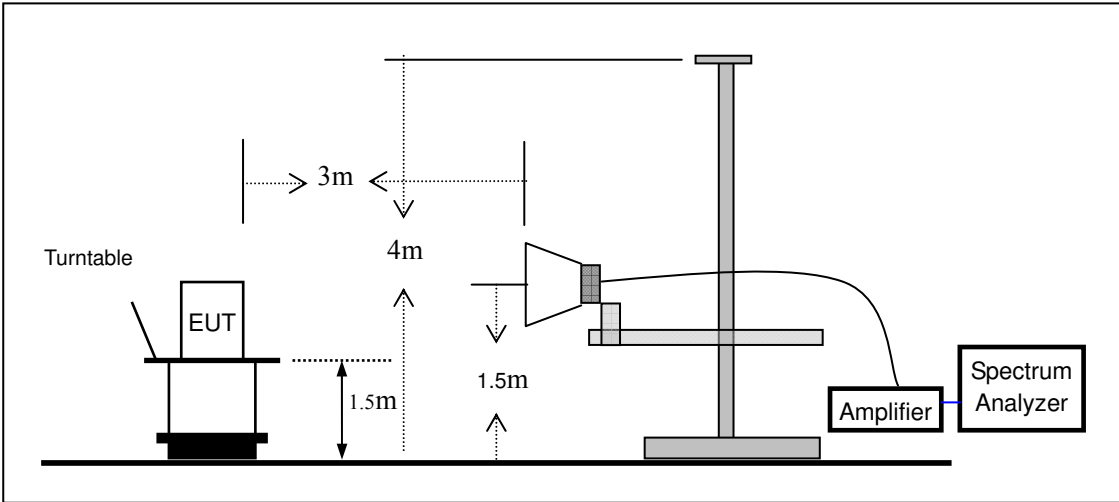

7.4. Radiated Measurement Result

30MHz-1GHz:

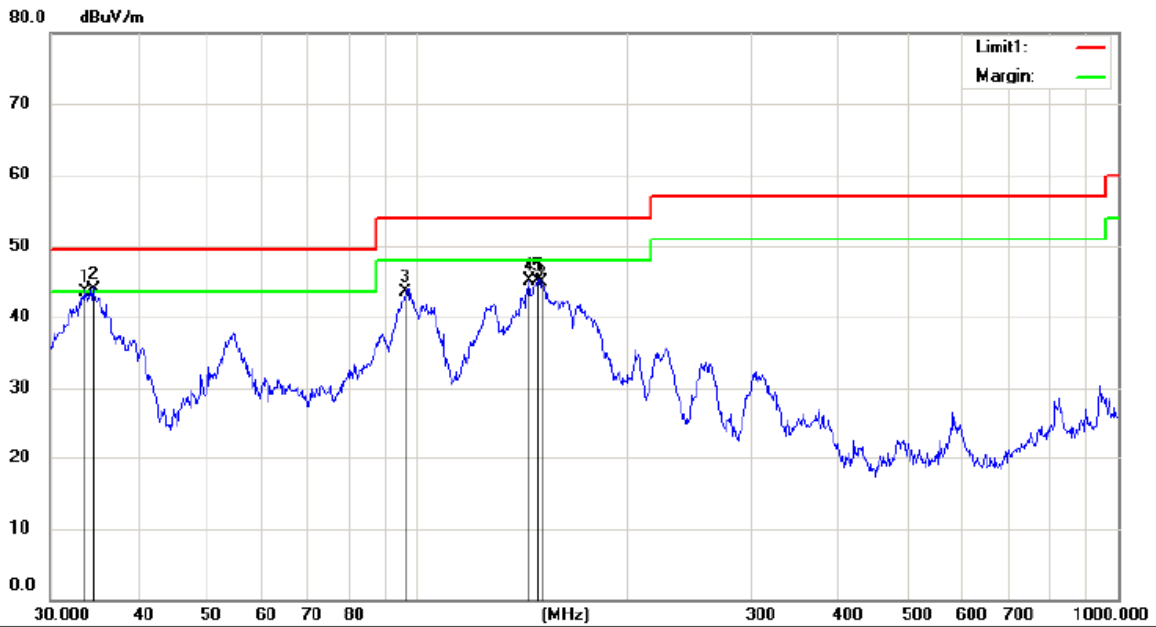

Site site #1

Polarization: **Vertical**

Temperature: 20 C

Limit: FCC Part15 Class A 3m Radiation

Power: AC 120V/60Hz

Humidity: 52 %

Mode:SENSOR

Note:

No.	Mk.	Freq. MHz	Reading Level dBuV	Correct Factor dB	Measure- ment dBuV/m	Limit dBuV/m	Over dB	Detector	Antenna Height cm	Table Degree	Comment
1	!	33.5623	66.15	-22.55	43.60	49.50	-5.90	QP			
2	*	34.5172	66.42	-22.42	44.00	49.50	-5.50	QP			
3		96.4360	66.15	-22.55	43.60	54.00	-10.40	QP			
4		144.3346	71.20	-26.10	45.10	54.00	-8.90	QP			
5		148.4410	70.39	-25.19	45.20	54.00	-8.80	QP			
6		150.5377	69.86	-24.86	45.00	54.00	-9.00	QP			

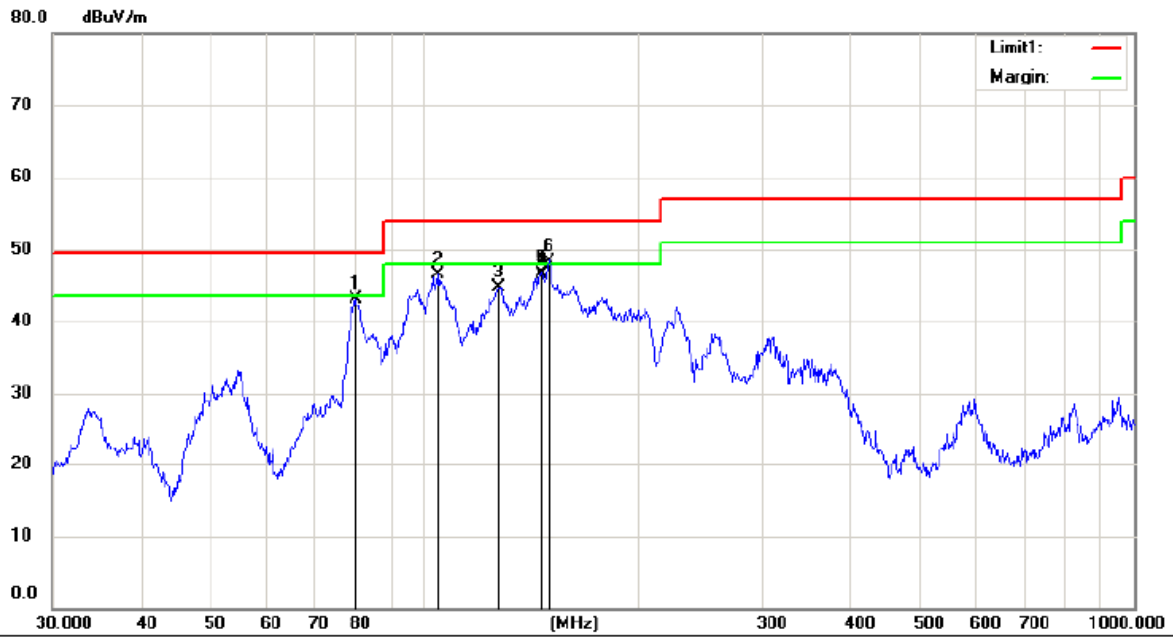

Site site #1 Polarization: **Horizontal** Temperature: 20 C
 Limit: FCC Part15 Class A 3m Radiation Power: AC 120V/60Hz Humidity: 52 %
 Mode:SENSOR
 Note:

No.	Mk.	Freq. MHz	Reading Level dBuV	Correct Factor dB	Measure- ment dBuV/m	Limit dBuV/m	Over dB	Antenna Height cm	Table Degree	Comment
1		80.0805	69.29	-26.19	43.10	49.50	-6.40	QP		
2		104.9032	67.86	-21.26	46.60	54.00	-7.40	QP		
3		127.2176	69.19	-24.49	44.70	54.00	-9.30	QP		
4		145.8611	72.47	-25.87	46.60	54.00	-7.40	QP		
5		146.3734	72.53	-25.73	46.80	54.00	-7.20	QP		
6	*	150.0108	73.17	-24.77	48.40	54.00	-5.60	QP		

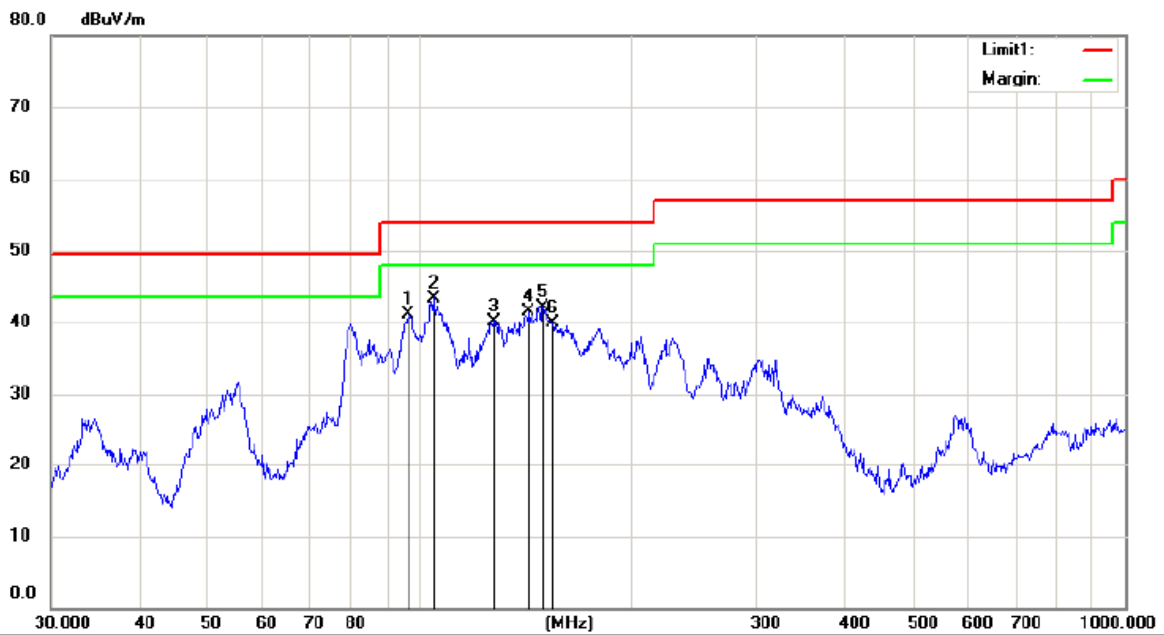

Site site #1 Polarization: **Horizontal** Temperature: 20 C
 Limit: FCC Part15 Class A 3m Radiation Power: AC 277V/60Hz Humidity: 52 %
 Mode:SENSOR
 Note:

No.	Mk.	Freq.	Reading Level	Correct Factor	Measurement	Limit	Over	Antenna Height	Table Degree	
		MHz	dBuV	dB	dBuV/m	dBuV/m	dB	cm	degree	Comment
1		96.0985	63.80	-22.70	41.10	54.00	-12.90	QP		
2	*	104.5360	64.63	-21.23	43.40	54.00	-10.60	QP		
3		127.6645	64.81	-24.61	40.20	54.00	-13.80	QP		
4		142.8243	67.64	-26.14	41.50	54.00	-12.50	QP		
5		149.4857	67.10	-24.90	42.20	54.00	-11.80	QP		
6		154.2785	65.34	-25.44	39.90	54.00	-14.10	QP		

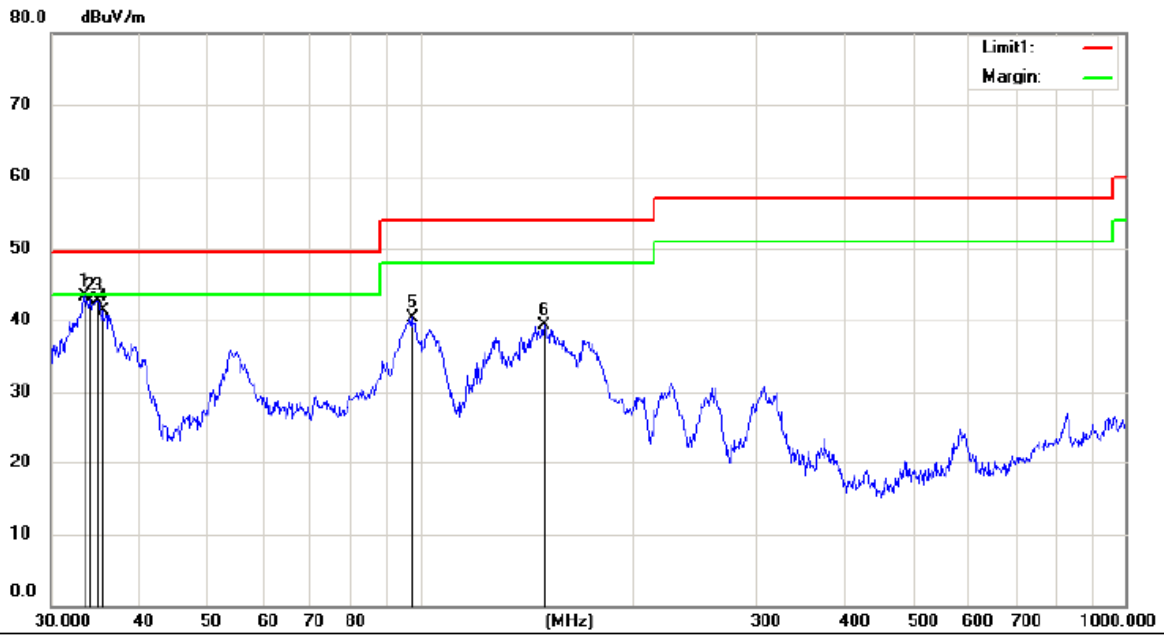

Site site #1 Polarization: *Vertical* Temperature: 20 C
 Limit: FCC Part15 Class A 3m Radiation Power: AC 277V/60Hz Humidity: 52 %
 Mode:SENSOR
 Note:

No.	Mk.	Freq. MHz	Reading Level dBuV	Correct Factor dB	Measure- ment dBuV/m	Limit dBuV/m	Over dB	Detector	Antenna Height cm	Table Degree	Comment
1	*	33.4450	66.00	-22.60	43.40	49.50	-6.10	QP			
2		34.0365	65.15	-22.35	42.80	49.50	-6.70	QP			
3		34.8823	65.16	-22.46	42.70	49.50	-6.80	QP			
4		35.4993	63.85	-22.55	41.30	49.50	-8.20	QP			
5		97.4560	62.47	-22.07	40.40	54.00	-13.60	QP			
6		150.0108	64.07	-24.77	39.30	54.00	-14.70	QP			

8. BAND EDGES MEASUREMENT

8.1. Standard Applicable

According to 15.249(d), out band emission except for harmonics shall be comply with §15.209 or at least attenuated by 50 dB below the level of the fundamental.

8.2. Measurement Procedure

Same as 6.1 Radiated Emission Measurement.

8.3. Measurement Equipment

Same as 6.2 Radiated Emission Measurement.

8.4. Test Setup

Same as 6.3 Radiated Emission Measurement.

8.5. Test Results

Pass

The test plots as following:

Lower band edge

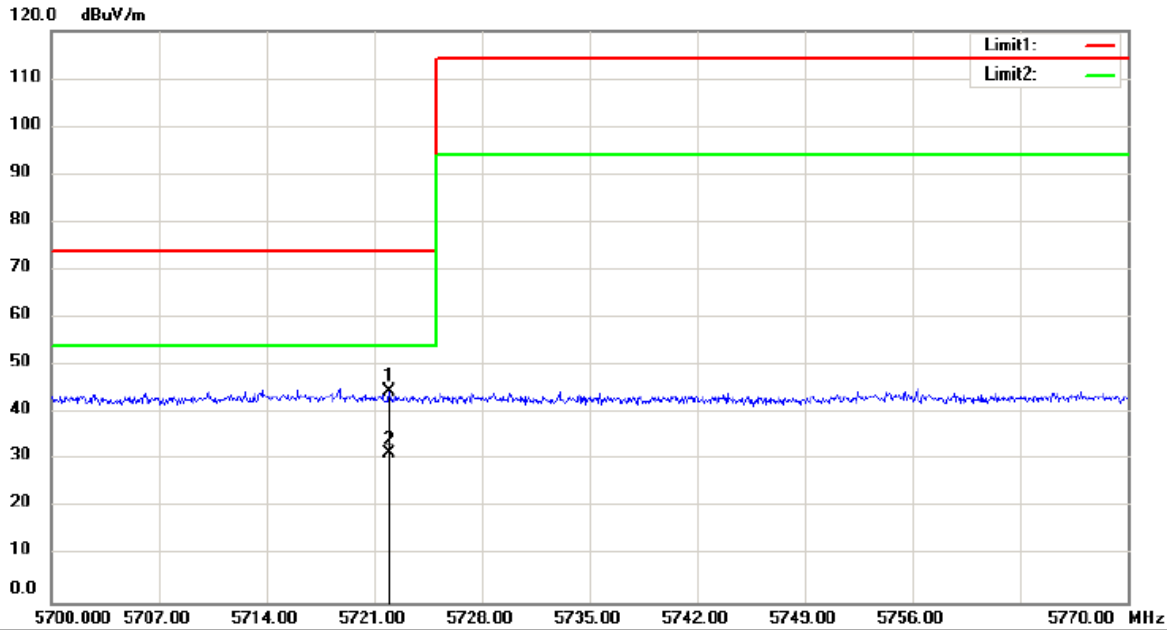

Site site #1 Polarization: **Vertical** Temperature: 24 C
 Limit: (RE)FCC PART 5G(Band edge) Power: AC 120V/60Hz Humidity: 53 %
 Mode:ON
 Note:

No.	Mk.	Freq.	Reading Level	Correct Factor	Measurement	Limit	Over	Antenna Height	Table Degree	
		MHz	dBuV	dB	dBuV/m	dBuV/m	dB	cm	degree	Comment
1		5721.980	58.35	-13.67	44.68	74.00	-29.32			peak
2	*	5721.980	45.07	-13.67	31.40	54.00	-22.60			AVG

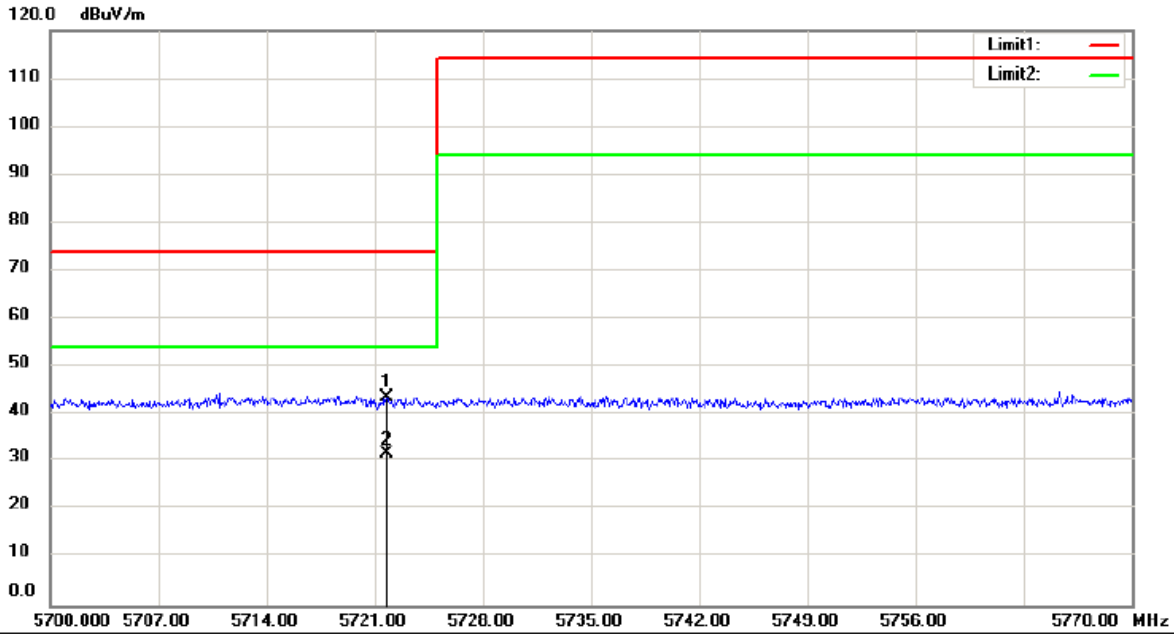

Site site #1 Polarization: *Horizontal* Temperature: 24 C
 Limit: (RE)FCC PART 5G(Band edge) Power: AC 120V/60Hz Humidity: 53 %
 Mode:ON
 Note:

No.	Mk.	Freq.	Reading Level	Correct Factor	Measurement	Limit	Over	Antenna Height	Table Degree		
		MHz	dBuV	dB	dBuV/m	dBuV/m	dB	Detector	cm	degree	Comment
1		5721.770	57.26	-13.67	43.59	74.00	-30.41	peak			
2	*	5721.770	45.27	-13.67	31.60	54.00	-22.40	AVG			

Upper band edge

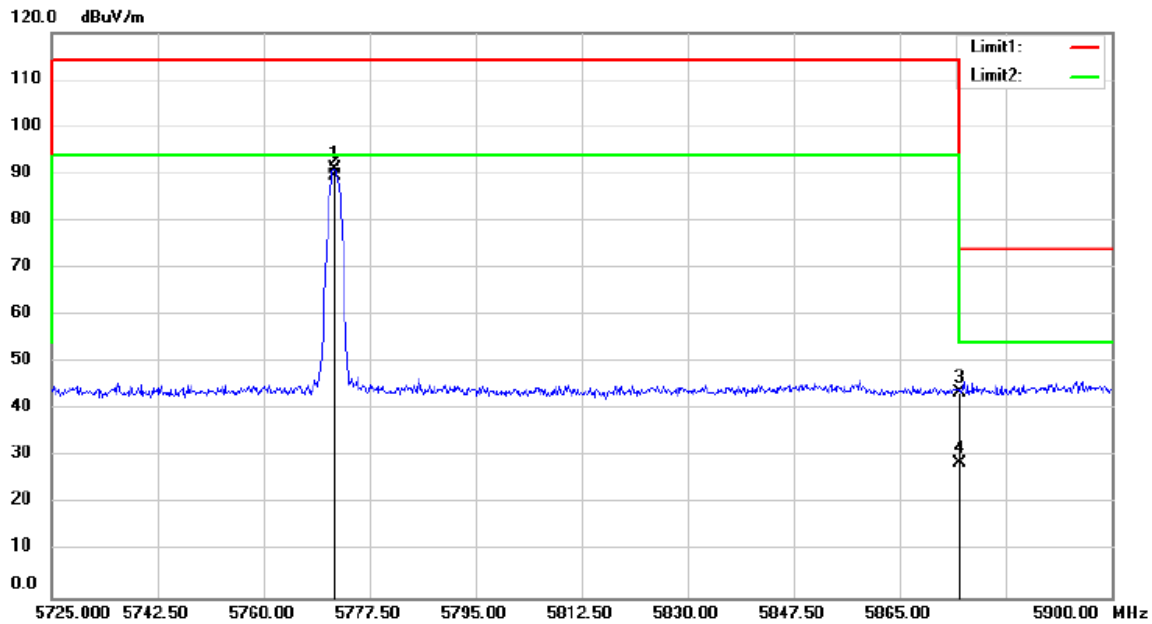

Site site #1 Polarization: *Horizontal* Temperature: 24 C
 Limit: (RE)FCC PART 5G(Band Edge) Power: AC120V/60Hz Humidity: 53 %
 Mode:ON
 Note:

No.	Mk.	Freq.	Reading Level	Correct Factor	Measurement	Limit	Over	Antenna Height	Table Degree	
		MHz	dBuV	dB	dBuV/m	dBuV/m	dB	cm	degree	Comment
1		5772.000	104.49	-13.59	90.90	114.00	-23.10			peak
2	*	5772.000	103.19	-13.59	89.60	94.00	-4.40			AVG
3		5875.000	57.21	-13.41	43.80	74.00	-30.20			peak
4		5875.000	42.01	-13.41	28.60	54.00	-25.40			AVG

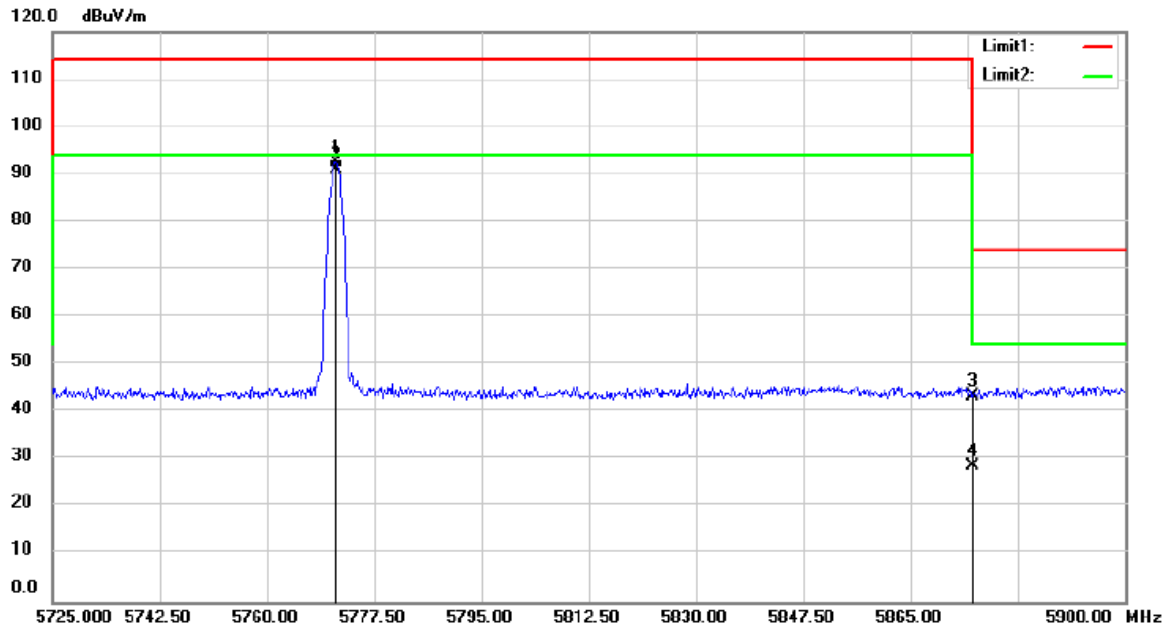

Site site #1 Polarization: **Vertical** Temperature: 24 C
 Limit: (RE)FCC PART 5G(Band Edge) Power: AC 120V/60Hz Humidity: 53 %
 Mode:ON
 Note:

No.	Mk.	Freq. MHz	Reading Level dBuV	Correct Factor dB	Measure- ment dBuV/m	Limit dBuV/m	Over dB	Antenna Height cm	Table Degree	Detector	Comment
1		5772.000	106.20	-13.59	92.61	114.00	-21.39			peak	
2	*	5772.000	104.79	-13.59	91.20	94.00	-2.80			AVG	
3		5875.000	56.84	-13.41	43.43	74.00	-30.57			peak	
4		5875.000	42.01	-13.41	28.60	54.00	-25.40			AVG	

9. ANTENNA APPLICATION

9.1. Standard Applicable

According to §15.203, an intentional radiator shall be designed to ensure that no antenna other than that furnished by the responsible party shall be used with the device.

9.2. Antenna Construction

The EUT'S antenna is permanently integrated on the main EUT, no consideration of replacement. The antenna's gain is 0dBi and meets the requirement.

---The End--