



## SAR Test Report

Product Name : GEYE 500  
Model No. : 8387341, 117823, 2224489  
FCC ID : 2AH2PGR0017WB

Applicant : DECATHLON USA LLC  
Address : 2415 3rd Street, Suite 231  
San Francisco  
94107, California  
United States of America

Date of Receipt : July. 13, 2017  
Test Date : Mar. 14, 2018~ Mar. 14, 2018  
Issued Date : Aug. 13, 2018  
Report No. : 1772084R-HP-US-P03V01  
Report Version : V1.2

The test results relate only to the samples tested.

The test results shown in the test report are traceable to the national/international standard through the calibration of the equipment and evaluated measurement uncertainty herein.

This report must not be used to claim product endorsement by TAF, A2LA any agency of the government.

The test report shall not be reproduced without the written approval of DEKRA Testing and Certification (Suzhou) Co., Ltd.

# Test Report Certification

Issued Date: Aug. 13, 2018

Report No: 1772084R-HP-US-P03V01



Product Name : GEYE 500  
Applicant : DECATHLON USA LLC  
Address : 2415 3rd Street, Suite 231  
San Francisco  
94107, California  
United States of America  
Manufacturer : DECATHLON SA  
Address : 4 Boulevard de Mons- 59650 Villeneuve D'Ascq-FRANCE  
Model No. : 8390837, 117826, 2245339  
FCC ID : 2AH2PGR0017WB  
Brand Name : Decathlon  
EUT Voltage : 3.8 V dc  
Applicable Standard : FCC KDB Publication 248227 D01v02r02  
FCC KDB Publication 447498 D01v06  
FCC KDB Publication 865664 D01v01r04  
IEEE Std. 1528-2013  
FCC 47CFR §2.1093  
ANSI C95.1-2005  
Test Result : Max. SAR Measurement (1g)  
Body: **0.773** W/kg  
Performed Location : DEKRA Testing and Certification (Suzhou) Co., Ltd.  
No.99 Hongye Rd., Suzhou Industrial Park, Suzhou,215006,  
Jiangsu,China  
TEL: +86-512-6251-5088 / FAX: +86-512-6251-5098  
FCC Designation Number: CN1199  
IC Lab Code: 4075B

Documented By :   
\_\_\_\_\_  
(Project Assistant: Kathy Feng )

Reviewed By :   
\_\_\_\_\_  
(Senior Engineer: Jack Zhang )

Approved By :   
\_\_\_\_\_  
( Engineering Manager: Harry Zhao )

## TABLE OF CONTENTS

Description	Page
<b>1. GENERAL INFORMATION .....</b>	<b>6</b>
1.1. EUT Description.....	6
1.2. Test Environment.....	9
1.3. Power Reduction for SAR.....	9
1.4. Guidance Documents .....	9
<b>2. SAR MEASUREMENT SYSTEM .....</b>	<b>10</b>
2.1. DASY5 System Description .....	10
2.1.1. Applications .....	11
2.1.2. Area Scans .....	11
2.1.3. Zoom Scan (Cube Scan Averaging) .....	11
2.1.4. Uncertainty of Inter-/Extrapolation and Averaging .....	11
2.2. DASY5 E-Field Probe .....	12
2.2.1. Isotropic E-Field Probe Specification .....	12
2.3. Boundary Detection Unit and Probe Mounting Device.....	13
2.4. DATA Acquisition Electronics (DAE) and Measurement Server .....	13
2.5. Robot .....	14
2.6. Light Beam Unit .....	14
2.7. Device Holder .....	15
2.8. SAM Twin Phantom .....	15
<b>3. TISSUE SIMULATING LIQUID .....</b>	<b>16</b>
3.1. The composition of the tissue simulating liquid.....	16
3.2. Tissue Calibration Result.....	17
3.3. Tissue Dielectric Parameters for Head and Body Phantoms .....	18
<b>4. SAR MEASUREMENT PROCEDURE .....</b>	<b>19</b>
4.1. SAR System Validation.....	19
4.1.1. Validation Dipoles .....	19
4.1.2. Validation Result.....	20
4.2. SAR Measurement Procedure.....	21
4.3. SAR Measurement Conditions for 802.11 Device.....	22
4.3.1. Duty Factor Control.....	22
4.3.2. Initial Test Position SAR Test Reduction Procedure .....	22
<b>5. SAR EXPOSURE LIMITS .....</b>	<b>23</b>

---

<b>6. TEST EQUIPMENT LIST .....</b>	<b>24</b>
<b>7. MEASUREMENT UNCERTAINTY .....</b>	<b>25</b>
<b>8. CONDUCTED POWER MEASUREMENT .....</b>	<b>26</b>
<b>9. TEST PROCEDURES .....</b>	<b>28</b>
9.1. SAR Test Results Summary .....	28
9.2. Test position and configuration .....	29
<b>APPENDIX A. SAR SYSTEM VALIDATION DATA .....</b>	<b>30</b>
<b>APPENDIX B. SAR MEASUREMENT DATA .....</b>	<b>31</b>
<b>APPENDIX C. PROBE CALIBRATION DATA .....</b>	<b>41</b>
<b>APPENDIX D. DIPOLE CALIBRATION DATA .....</b>	<b>52</b>
<b>APPENDIX E. DAE CALIBRATION DATA .....</b>	<b>60</b>

**History of This Test Report**

<b>REPORT NO.</b>	<b>VERSION</b>	<b>DESCRIPTION</b>	<b>ISSUED DATE</b>
1772084R-HP-US-P03V01	V1.0	Initial Issued Report	Jun. 20, 2018
1772084R-HP-US-P03V01	V1.1	Add Test 802.11g 2437 Add Simultaneous explanation Modified Power Modified product information	Jul. 25, 2018
1772084R-HP-US-P03V01	V1.2	Modified form	Aug. 13, 2018

## 1. General Information

### 1.1. EUT Description

<b>WIFI</b>	
Product Name	GEYE 500
Model No.	8387341, 117823, 2224489
Working Voltage	3.8 V DC
Test Voltage	AC120V/60Hz
Frequency Range	For 2.4GHz Band 802.11b/g/n(20MHz): 2412~2462MHz
Channel Number	For 2.4GHz Band 802.11b/g/n(20MHz): 11
Type of Modulation	802.11b: DSSS 802.11g: OFDM
Data Rate	802.11g: 6/9/12/18/24/36/48/54 Mbps 802.11b: 1/2/5.5/11 Mbps 802.11n: up to 72.2 Mbps
Antenna Type	Reference to Antenna List
Peak Antenna Gain	Reference to Antenna List
<b>BT</b>	
Bluetooth Specification	V4.0
Frequency Range	2402- 2480 MHz
Channel Number	V4.0: 40
Channel Separation	V4.0: 2MHz
Type of Modulation	V4.0: GFSK
Data Rate	V4.0: 1Mbps(GFSK)
Antenna Type	Reference to Antenna List
Peak Antenna Gain	Reference to Antenna List

Note: The 2.4G WLAN and BT cannot transmit simultaneously.

**Channel List:**  
**WIFI**

802.11b/g/n(20MHz) Working Frequency of Each Channel:							
Channel	Frequency	Channel	Frequency	Channel	Frequency	Channel	Frequency
01	2412 MHz	02	2417 MHz	03	2422 MHz	04	2427 MHz
05	2432 MHz	06	2437 MHz	07	2442 MHz	08	2447 MHz
09	2452 MHz	10	2457 MHz	11	2462 MHz	N/A	N/A

**BT 4.0**

Bluetooth Working Frequency of Each Channel: (For V4.0)							
Channel	Frequency	Channel	Frequency	Channel	Frequency	Channel	Frequency
00	2402 MHz	01	2404 MHz	02	2406 MHz	03	2408 MHz
04	2410 MHz	05	2412 MHz	06	2414 MHz	07	2416 MHz
08	2418 MHz	09	2420 MHz	10	2422 MHz	11	2424 MHz
12	2426 MHz	13	2428 MHz	14	2430 MHz	15	2432 MHz
16	2434 MHz	17	2436 MHz	18	2438 MHz	19	2440 MHz
20	2442 MHz	21	2444 MHz	22	2446 MHz	23	2448 MHz
24	2450 MHz	25	2452 MHz	26	2454 MHz	27	2456 MHz
28	2458 MHz	29	2460 MHz	30	2462 MHz	31	2464 MHz
32	2466 MHz	33	2468 MHz	34	2470 MHz	35	2472 MHz
36	2474 MHz	37	2476 MHz	38	2478 MHz	39	2480 MHz

**Antenna List**

Antenna manufacturer	N/A						
Antenna Delivery	<input checked="" type="checkbox"/>	1*TX+1*RX	<input type="checkbox"/>	2*TX+2*RX	<input type="checkbox"/>	3*TX+3*RX	
Antenna technology	<input checked="" type="checkbox"/>	SISO					
	<input type="checkbox"/>	MIMO	<input type="checkbox"/>	Basic			
			<input type="checkbox"/>	Sectorized antenna systems			
			<input type="checkbox"/>	Cross-polarized antennas			
			<input type="checkbox"/>	Unequal antenna gains, with equal transmit powers			
			<input type="checkbox"/>	Spatial Multiplexing			
			<input type="checkbox"/>	CDD			
<input type="checkbox"/>	Beam-forming						
Antenna Type	<input type="checkbox"/>	External	<input type="checkbox"/>	Dipole			
	<input checked="" type="checkbox"/>	Internal	<input checked="" type="checkbox"/>	PIFA			
			<input type="checkbox"/>	PCB			
			<input type="checkbox"/>	Monopole Antenna			
			<input type="checkbox"/>	Metal plate type F antenna			
			<input type="checkbox"/>	Cross-polarize Antenna			
Antenna Gain #0	2.5dBi						



## 1.2. Test Environment

Ambient conditions in the laboratory:

Items	Required	Actual
Temperature (°C)	18-25	21.5± 2
Humidity (%RH)	30-70	52

## 1.3. Power Reduction for SAR

There is no power reduction used for any band/mode implemented in this device for SAR purposes.

## 1.4. Guidance Documents

- 1) FCC KDB Publication 447498 D01v06 (General SAR Guidance)
- 2) FCC KDB Publication 865664 D01v01r04(SAR measurement 100 MHz to 6 GHz)
- 3) FCC KDB Publication 248227 D01v02r02 (SAR Considerations for 802.11 Devices)
- 4) IEEE Std. 1528-2013 (IEEE Recommended Practice for Determining the Peak Spatial-Average Specific Absorption Rate (SAR) in the Human Head from Wireless Communications Devices: Measurement Techniques)
- 5) FCC 47CFR §2.1093 Radiofrequency radiation exposure evaluation: portable devices
- 6) ANSI C95.1-2005 - IEEE Standard for Safety Levels with Respect to Human Exposure to Radio Frequency Electromagnetic Fields, 3 kHz to 300 GHz

## 2. SAR Measurement System

### 2.1. DASY5 System Description

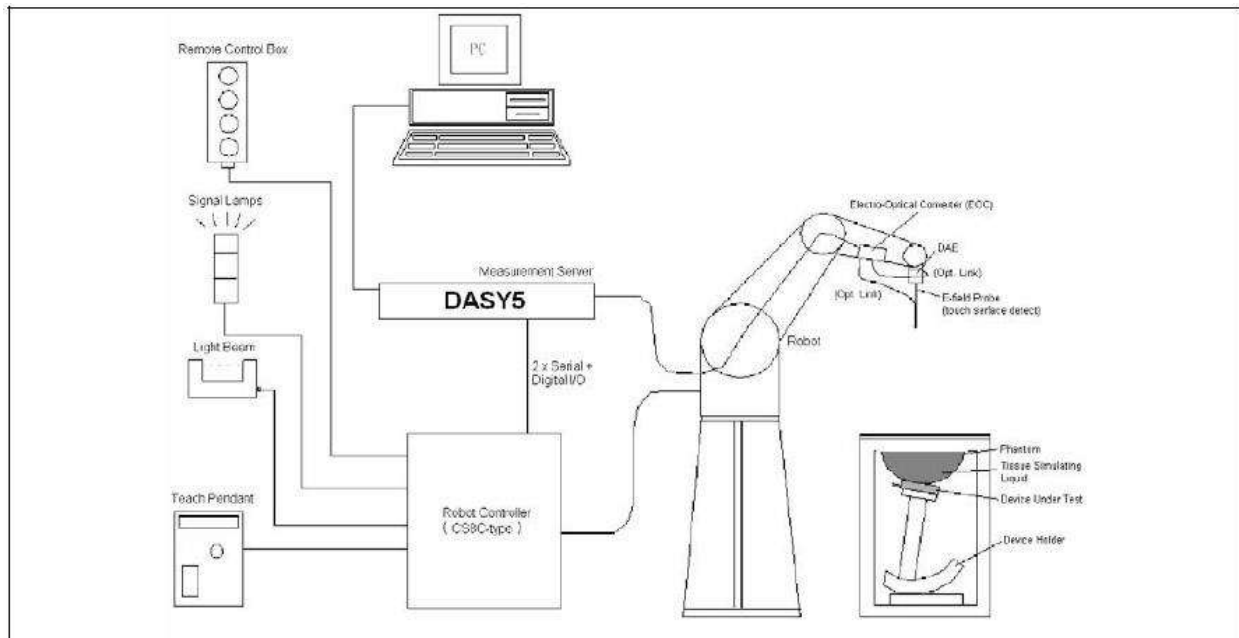

The DASY5 system for performing compliance tests consists of the following items:

- A standard high precision 6-axis robot with controller, teach pendant and software. An arm extension for accommodating the data acquisition electronics (DAE).
- A data acquisition electronics (DAE) which performs the signal amplification, signal multiplexing, AD-conversion, offset measurements, mechanical surface detection, collision detection, etc. The unit is battery powered with standard or rechargeable batteries. The signal is optically transmitted to the EOC.
- The Electro-optical converter (EOC) performs the conversion from optical to electrical signals for the digital communication to the DAE. To use optical surface detection, a special version of the EOC is required. The EOC signal is transmitted to the measurement server.
- The Light Beam used is for probe alignment. This improves the (absolute) accuracy of the probe positioning.
- A computer running WinXP and the DASY5 software.
- Remote control and teach pendant as well as additional circuitry for robot safety such as warning lamps, etc.
- The phantom, the device holder and other accessories according to the targeted measurement.

### **2.1.1. Applications**

Predefined procedures and evaluations for automated compliance testing with all worldwide standards, e.g., IEEE 1528, OET 65, IEC 62209-1, IEC 62209-2, EN 50360, EN 50383 and others.

### **2.1.2. Area Scans**

Area scans are defined prior to the measurement process being executed with a user defined variable spacing between each measurement point (integral) allowing low uncertainty measurements to be conducted. Scans defined for FCC applications utilize a 10mm<sup>2</sup> step integral, with 1mm interpolation used to locate the peak SAR area used for zoom scan assessments.

When an Area Scan has measured all reachable points, it computes the field maxima found in the scanned area, within a range of the global maximum. The range (in dB) is specified in the standards for compliance testing. For example, a 2 dB range is required in IEEE 1528-2003, EN 50361 and IEC 62209 standards, whereby 3 dB is a requirement when compliance is assessed in accordance with the ARIB standard (Japan).

### **2.1.3. Zoom Scan (Cube Scan Averaging)**

Zoom Scans are used to assess the peak spatial SAR values within a cubic averaging volume containing 1 g and 10 g of simulated tissue. A density of 1000 kg/m<sup>3</sup> is used to represent the head and body tissue density and not the phantom liquid density, in order to be consistent with the definition of the liquid dielectric properties, i.e. the side length of the 1 g cube is 10mm, with the side length of the 10 g cube 21,5mm.

The zoom scan integer steps can be user defined so as to reduce uncertainty, but normal practice for typical test applications utilize a physical step of 7x7x7 (5mmx5mmx5mm) providing a volume of 30mm in the X & Y axis, and 30mm in the Z axis.

### **2.1.4. Uncertainty of Inter-/Extrapolation and Averaging**

In order to evaluate the uncertainty of the interpolation, extrapolation and averaged SAR calculation algorithms of the Postprocessor, DASY5 allows the generation of measurement grids which are artificially predefined by analytically based test functions. Therefore, the grids of area scans and zoom scans can be filled with uncertainty test data, according to the SAR benchmark functions of IEEE 1528. The three analytical functions shown in equations as below are used to describe the possible range of the expected SAR distributions for the tested handsets. The field gradients are covered by the spatially flat distribution f1, the spatially steep distribution f3 and f2 accounts for H-field cancellation on the phantom/tissue surface.

$$f_1(x, y, z) = Ae^{-\frac{z}{2a}} \cos^2 \left( \frac{\pi}{2} \frac{\sqrt{x'^2 + y'^2}}{5a} \right)$$

$$f_2(x, y, z) = Ae^{-\frac{z}{a}} \frac{a^2}{a^2 + x'^2} \left( 3 - e^{-\frac{2z}{a}} \right) \cos^2 \left( \frac{\pi}{2} \frac{y'}{3a} \right)$$

$$f_3(x, y, z) = A \frac{a^2}{\frac{a^2}{4} + x'^2 + y'^2} \left( e^{-\frac{2z}{a}} + \frac{a^2}{2(a + 2z)^2} \right)$$

## 2.2. DASYS E-Field Probe

The SAR measurement is conducted with the dosimetric probe manufactured by SPEAG. The probe is specially designed and calibrated for use in liquid with high permittivity. The dosimetric probe has special calibration in liquid at different frequency.

SPEAG conducts the probe calibration in compliance with international and national standards (e.g. IEEE 1528, EN 62209-1, IEC 62209, etc.) under ISO 17025. The calibration data are in Appendix D.

### 2.2.1. Isotropic E-Field Probe Specification

<b>Model</b>	EX3DV4	
<b>Construction</b>	Symmetrical design with triangular core Built-in shielding against static charges PEEK enclosure material (resistant to organic solvents, e.g., DGBE)	
<b>Frequency</b>	10 MHz to 6 GHz Linearity: ± 0.2 dB (30 MHz to 6 GHz)	
<b>Directivity</b>	± 0.3 dB in HSL (rotation around probe axis) ± 0.5 dB in tissue material (rotation normal to probe axis)	
<b>Dynamic Range</b>	10 µW/g to 100 mW/g Linearity: ± 0.2 dB (noise: typically < 1 µW/g)	
<b>Dimensions</b>	Overall length: 330 mm (Tip: 20 mm) Tip diameter: 2.5 mm (Body: 12 mm) Typical distance from probe tip to dipole centers: 1 mm	
<b>Application</b>	High precision dosimetric measurements in any exposure scenario (e.g., very strong gradient fields). Only probe which enables compliance testing for frequencies up to 6 GHz with precision of better 30%.	

### 2.3. Boundary Detection Unit and Probe Mounting Device

The DASY probes use a precise connector and an additional holder for the probe, consisting of a plastic tube and a flexible silicon ring to center the probe. The connector at the DAE is flexibly mounted and held in the default position with magnets and springs. Two switching systems in the connector mount detect frontal and lateral probe collisions and trigger the necessary software response.



### 2.4. DATA Acquisition Electronics (DAE) and Measurement Server

The data acquisition electronics (DAE) consists of a highly sensitive electrometer-grade preamplifier with auto-zeroing, a channel and gain-switching multiplexer, a fast 16 bit AD-converter and a command decoder and control logic unit.

Transmission to the measurement server is accomplished through an optical downlink for data and status information as well as an optical uplink for commands and the clock.

The input impedance of the DAE4 is 200M Ohm; the inputs are symmetrical and floating. Common mode rejection is above 80dB.



The DASY5 measurement server is based on a PC/104 CPU board with a 400MHz intel ULV Celeron, 128MB chipdisk and 128MB RAM. The necessary circuits for communication with the DAE electronics box, as well as the 16 bit AD converter system for optical detection and digital I/O interface are contained on the DASY5 I/O board, which is directly connected to the PC/104 bus of the CPU board.



## 2.5. Robot

The DASY5 system uses the high precision robots TX90 XL type out of the newer series from Stäubli SA (France). For the 6-axis controller DASY5 system, the CS8C robot controller version from Stäubli is used.

The XL robot series have many features that are important for our application:

- High precision (repeatability 0.02 mm)
- High reliability (industrial design)
- Jerk-free straight movements
- Low ELF interference (the closed metallic construction shields against motor control fields)
- 6-axis controller



## 2.6. Light Beam Unit

The light beam switch allows automatic "tooling" of the probe. During the process, the actual position of the probe tip with respect to the robot arm is measured, as well as the probe length and the horizontal probe offset. The software then corrects all movements, such that the robot coordinates are valid for the probe tip.

The repeatability of this process is better than 0.1 mm. If a position has been taught with an aligned probe, the same position will be reached with another aligned probe within 0.1 mm, even if the other probe has different dimensions. During probe rotations, the probe tip will keep its actual position.



## 2.7. Device Holder

The DASY5 device holder is designed to cope with different positions given in the standard. It has two scales for the device rotation (with respect to the body axis) and the device inclination (with respect to the line between the ear reference points). The rotation center for both scales is the ear reference point (EPR).

Thus the device needs no repositioning when changing the angles.

The DASY5 device holder has been made out of low-loss POM material having the following dielectric parameters: relative permittivity  $\epsilon_r = 3$  and loss tangent  $\delta = 0.02$ . The amount of dielectric material has been reduced in the closest vicinity of the device, since measurements have suggested that the influence of the clamp on the test results could thus be lowered.



## 2.8. SAM Twin Phantom

The SAM twin phantom is a fiberglass shell phantom with 2mm shell thickness (except the ear region where shell thickness increases to 6mm). It has three measurement areas:

- Left head
- Right head
- Flat phantom



The bottom plate contains three pair of bolts for locking the device holder. The device holder positions are adjusted to the standard measurement positions in the three sections. A white cover is provided to tap the phantom during off-periods to prevent water evaporation and changes in the liquid parameters. On the phantom tip, three reference markers are provided to identify the phantom position with respect to the robot.

### 3. Tissue Simulating Liquid

#### 3.1. The composition of the tissue simulating liquid

INGREDIENT (% Weight)	2450MHz Body
Water	73.2
Salt	0.04
Sugar	0.00
HEC	0.00
Preventol	0.00
DGBE	26.4
Triton X-100	0.00



### 3.2. Tissue Calibration Result

The dielectric parameters of the liquids were verified prior to the SAR evaluation using DASY5 Dielectric Probe Kit and Agilent Vector Network Analyzer E5071C

Body Tissue Simulant Measurement				
Frequency [MHz]	Description	Dielectric Parameters		Tissue Temp. [°C]
		$\epsilon_r$	$\sigma$ [s/m]	
2450 MHz	Reference result $\pm 5\%$ window	52.7 50.07 to 55.34	1.95 1.85 to 2.05	N/A
	03-14-2018	52.04	1.95	21.0

### 3.3. Tissue Dielectric Parameters for Head and Body Phantoms

The head tissue dielectric parameters recommended by the IEEE SCC-34/SC-2 in P1528 have been incorporated in the following table. These head parameters are derived from planar layer models simulating the highest expected SAR for the dielectric properties and tissue thickness variations in a human head. Other head and body tissue parameters that have not been specified in P1528 are derived from the tissue dielectric parameters computed from the 4-Cole-Cole equations described in Reference [12] and extrapolated according to the head parameters specified in P1528.

Target Frequency (MHz)	Head		Body	
	$\epsilon_r$	$\sigma$ (S/m)	$\epsilon_r$	$\sigma$ (S/m)
150	52.3	0.76	61.9	0.80
300	45.3	0.87	58.2	0.92
450	43.5	0.87	56.7	0.94
835	41.5	0.90	55.2	0.97
900	41.5	0.97	55.0	1.05
915	41.5	0.98	55.0	1.06
1450	40.5	1.20	54.0	1.30
1610	40.3	1.29	53.8	1.40
1800 – 2000	40.0	1.40	53.3	1.52
<b>2450</b>	39.2	1.80	<b>52.7</b>	<b>1.95</b>
3000	38.5	2.40	52.0	2.73
5800	35.3	5.27	48.2	6.00

( $\epsilon_r$  = relative permittivity,  $\sigma$  = conductivity and  $\rho = 1000 \text{ kg/m}^3$ )

## 4. SAR Measurement Procedure

### 4.1. SAR System Validation

#### 4.1.1. Validation Dipoles

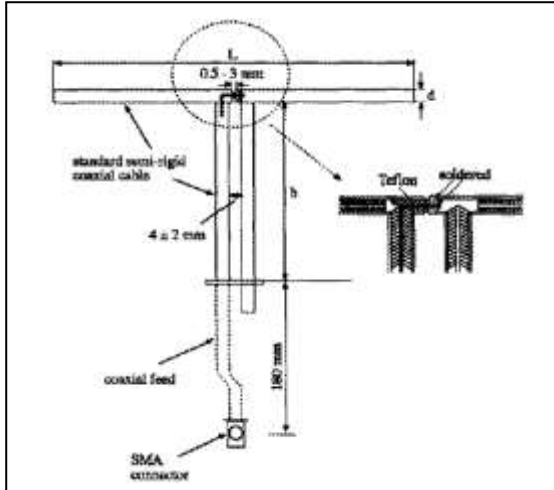

The dipoles used is based on the IEEE-1528 standard, and is complied with mechanical and electrical specifications in line with the requirements of both IEEE and FCC Supplement C. the table below provides details for the mechanical and electrical specifications for the dipoles.

Frequency	L (mm)	h (mm)	d (mm)
2450MHz	53.5	30.4	3.6

#### 4.1.2. Validation Result

<b>System Performance Check at 2450MHz</b>				
<b>Validation Dipole: D2450V2, SN: 839 Body</b>				
Frequency [MHz]	Description	SAR [w/kg] 1g	SAR [w/kg] 10g	Tissue Temp. [°C]
2450 MHz	Reference result ± 10% window	49.8 44.82 to 54.78	23.3 20.97 to 25.63	N/A
	03-14-2018	50.0	22.76	21.0

Note: All SAR values are normalized to 1W forward power.

## 4.2. SAR Measurement Procedure

The DASY 5 calculates SAR using the following equation,

$$SAR = \frac{\sigma |E|^2}{\rho}$$

$\sigma$ : represents the simulated tissue conductivity

$\rho$ : represents the tissue density

The EUT is set to transmit at the required power in line with product specification, at each frequency relating to the LOW, MID, and HIGH channel settings.

Pre-scans are made on the device to establish the location for the transmitting antenna, using a large area scan in either air or tissue simulation fluid.

The EUT is placed against the Universal Phantom where the maximum area scan dimensions are larger than the physical size of the resonating antenna. When the scan size is not large enough to cover the peak SAR distribution, it is modified by either extending the area scan size in both the X and Y directions, or the device is shifted within the predefined area.

The area scan is then run to establish the peak SAR location (interpolated resolution set at 1mm<sup>2</sup>) which is then used to orient the center of the zoom scan. The zoom scan is then executed and the 1g and 10g averages are derived from the zoom scan volume (interpolated resolution set at 1mm<sup>3</sup>).

### **4.3. SAR Measurement Conditions for 802.11 Device**

#### **4.3.1. Duty Factor Control**

Unless it is permitted by specific KDB procedures or continuous transmission is specifically restricted by the device, the reported SAR must be scaled to 100% transmission duty factor to determine compliance at the maximum tune-up tolerance limit.

#### **4.3.2. Initial Test Position SAR Test Reduction Procedure**

DSSS and OFDM configurations are considered separately according to the required SAR procedures. SAR is measured in the initial test position using the 802.11 transmission mode configuration required by the DSSS procedure or initial test configuration and subsequent test configuration(s) according to the OFDM procedures.<sup>16</sup> The initial test position procedure is described in the following:

When the reported SAR of the initial test position is  $\leq 0.4$  W/kg, further SAR measurement is not required for the other (remaining) test positions in that exposure configuration and 802.11 transmission mode combinations within the frequency band or aggregated band. SAR is also not required for that exposure configuration in the subsequent test configuration(s).

a) When the reported SAR of the initial test position is  $> 0.4$  W/kg, SAR is repeated for the 802.11 transmission mode configuration tested in the initial test position using subsequent highest extrapolated or estimated 1-g SAR conditions determined by area scans or next closest/smallest test separation distance and maximum RF coupling test positions based on manufacturer justification, on the highest maximum output power channel, until the reported SAR is  $\leq 0.8$  W/kg or all required test positions (left, right, touch, tilt or subsequent surfaces and edges) are tested.

b) For all positions/configurations tested using the initial test position and subsequent test positions, when the reported SAR is  $> 0.8$  W/kg, SAR is measured for these test positions/configurations on the subsequent next highest measured output power channel(s) until the reported SAR is  $\leq 1.2$  W/kg or all required channels are tested. Additional power measurements may be required for this step, which should be limited to those necessary for identifying the subsequent highest output power channels.

## 5. SAR Exposure Limits

SAR assessments have been made in line with the requirements of IEEE-1528, FCC Supplement C, and comply with ANSI/IEEE C95.1-1992 “Uncontrolled Environments” limits. These limits apply to a location which is deemed as “Uncontrolled Environment” which can be described as a situation where the general public may be exposed to an RF source with no prior knowledge or control over their exposure.

### Limits for General Population/Uncontrolled Exposure (W/kg)

Type Exposure	Uncontrolled Environment Limit
Spatial Peak SAR (1g cube tissue for brain or body)	1.60 W/kg
Spatial Average SAR (whole body)	0.08 W/kg
Spatial Peak SAR (10g for hands, feet, ankles and wrist)	4.00 W/kg

## 6. Test Equipment List

Instrument	Manufacturer	Model No.	Serial No.	Cali. Due Date
Stäubli Robot TX60L	Stäubli	TX60L	F10/5C90A1/A/01	N/A
Controller	Stäubli	SP1	S-0034	N/A
Dipole Validation Kits	Speag	D2450V2	839	2019.02.08
SAM Twin Phantom	Speag	SAM	TP-1561/1562	N/A
Device Holder	Speag	SD 000 H01 HA	N/A	N/A
Data Acquisition Electronic	Speag	DAE4	905	2018.06.19
E-Field Probe	Speag	EX3DV4	3661	2018.05.04
SAR Software	Speag	DASY5	V5.2 Build 162	N/A
Power Amplifier	Mini-Circuit	ZVA-183-S+	N657400950	N/A
Directional Coupler	Agilent	778D	20160	N/A
Universal Radio Communication Tester	R&S	CMU 200	117088	2019.03.10
Vector Network	Agilent	E5071C	MY48367267	2019.03.10
Signal Generator	Agilent	E4438C	MY49070163	2019.03.10
Power Meter	Anritsu	ML2495A	0905006	2018.10.14
Wide Bandwidth Sensor	Anritsu	MA2411B	0846014	2018.10.14



## 7. Measurement Uncertainty

DASY5 Uncertainty according to IEEE std. 1528-2013								
Measurement uncertainty for 300 MHz to 3 GHz averaged over 1 gram / 10 gram.								
Error Description	Uncert. value	Prob. Dist.	Div.	(c <sub>i</sub> ) 1g	(c <sub>i</sub> ) 10g	Std. Unc. (1g)	Std. Unc. (10g)	(v <sub>i</sub> ) v <sub>eff</sub>
<b>Measurement System</b>								
Probe Calibration	±6.0%	N	1	1	1	±6.0%	±6.0%	∞
Axial Isotropy	±4.7%	R	√3	0.7	0.7	±1.9%	±1.9%	∞
Hemispherical Isotropy	±9.6%	R	√3	0.7	0.7	±3.9%	±3.9%	∞
Boundary Effects	±1.0%	R	√3	1	1	±0.6%	±0.6%	∞
Linearity	±4.7%	R	√3	1	1	±2.7%	±2.7%	∞
System Detection Limits	±1.0%	R	√3	1	1	±0.6%	±0.6%	∞
Readout Electronics	±0.3%	N	1	1	1	±0.3%	±0.3%	∞
Response Time	±0.8%	R	√3	1	1	±0.5%	±0.5%	∞
Integration Time	±2.6%	R	√3	1	1	±1.5%	±1.5%	∞
RF Ambient Noise	±3.0%	R	√3	1	1	±1.7%	±1.7%	∞
RF Ambient Reflections	±3.0%	R	√3	1	1	±1.7%	±1.7%	∞
Probe Positioner	±0.4%	R	√3	1	1	±0.2%	±0.2%	∞
Probe Positioning	±2.9%	R	√3	1	1	±1.7%	±1.7%	∞
Max. SAR Eval.	±1.0%	R	√3	1	1	±0.6%	±0.6%	∞
<b>Test Sample Related</b>								
Device Positioning	±2.9%	N	1	1	1	±2.9%	±2.9%	145
Device Holder	±3.6%	N	1	1	1	±3.6%	±3.6%	5
Power Drift	±5.0%	R	√3	1	1	±2.9%	±2.9%	∞
<b>Phantom and Setup</b>								
Phantom Uncertainty	±4.0%	R	√3	1	1	±2.3%	±2.3%	∞
Liquid Conductivity (target)	±5.0%	R	√3	0.64	0.43	±1.8%	±1.2%	∞
Liquid Conductivity (meas.)	±2.5%	N	1	0.64	0.43	±1.6%	±1.1%	∞
Liquid Permittivity (target)	±5.0%	R	√3	0.6	0.49	±1.7%	±1.4%	∞
Liquid Permittivity (meas.)	±2.5%	N	1	0.6	0.49	±1.5%	±1.2%	∞
<b>Combined Std. Uncertainty</b>						±11.0%	±10.8%	387
<b>Expanded STD Uncertainty</b>						±22.0%	±21.5%	

## 8. Conducted Power Measurement

### For WIFI

Test Mode	Frequency (MHz)	Avg. Burst Power (dBm)	Max. Power (dBm)	Scaling Factor
802.11b	2412	18.01	18.5	1.119
	2437	18.89	19.0	1.026
	2462	19.18	19.5	1.076
802.11g	2412	21.98	22.5	1.127
	2437	22.28	22.5	1.052
	2462	22.12	22.5	1.091
802.11n20	2412	22.01	22.5	1.119
	2437	21.86	22.5	1.159
	2462	21.85	22.5	1.161

### For BT 4.0

Test Mode	Frequency (MHz)	Avg. Burst Power (dBm)	Max. Power (dBm)	Scaling Factor
1Mbps( GFSK)	2402	7.92	8.0	1.019
	2440	7.88	8.0	1.028
	2480	7.61	8.0	1.094

**Duty cycle:**

<b>Test Mode</b>	<b>Duty Cycle(%)</b>
<b>802.11b</b>	<b>100</b>
<b>802.11g</b>	<b>97.74</b>
<b>802.11n</b>	<b>97.8</b>

Note1: All the conducted power had already scaled to 100% duty cycle.

2: The maximum duty cycle which transmit by the RF tool is showed above, so each modes of the SAR was needed scaled to 100% duty cycle.

## 9. Test Procedures

### 9.1. SAR Test Results Summary

SAR MEASUREMENT									
Ambient Temperature (°C) : 21.5 ± 2					Relative Humidity (%): 52				
Liquid Temperature (°C) : 21.0 ± 2					Depth of Liquid (cm):>15				
Product: GEYE 500									
Frequency: 2412 ~ 2462MHz									
Test Mode: 802.11b									
Test Position Body (0mm gap)	Antenna Position	Frequency (MHz)	Conducted Power (dBm)	Power Drift (<±0.2)	SAR 1g (W/kg)	Scaling Factor	Duty Factor	Reported SAR 1g (W/kg)	Limit (W/kg)
Front	Fixed	2437	18.89	0.13	0.566	1.026	1	0.581	1.6
Edge1	Fixed	2437	18.89	0.06	0.673	1.026	1	0.690	1.6
Edge2	Fixed	2437	18.89	-0.03	0.713	1.026	1	0.732	1.6
Edge3	Fixed	2437	18.89	0.13	0.660	1.026	1	0.677	1.6
Edge4	Fixed	2437	18.89	0.10	0.377	1.026	1	0.387	1.6
Edge2	Fixed	2412	18.01	-0.07	0.691	1.119	1	0.773	1.6
Edge2	Fixed	2462	19.18	0.09	0.705	1.076	1	0.759	1.6
Test Mode: 802.11g									
Edge2	Fixed	2437	22.28	-0.01	0.702	1.052	1.023	0.755	1.6
Test Mode:BLE									
Edge2	Fixed	2440	7.88	0.11	0.183	1.028	1.607	0.302	1.6

Note 1: \* - Repeated at the highest measured SAR according to the FCC KDB 865664

2: When the reported SAR of the initial test position is > 0.4 W/kg, on the highest maximum output power channel, until the reported SAR is ≤ 0.8 W/kg or all required test positions (Front and edges) are tested.

3: For all positions/configurations tested using the initial test position and subsequent test positions, when the reported SAR is > 0.8 W/kg, SAR is measured for these test positions/configurations on the subsequent next highest measured output power channel(s) until the reported SAR is ≤ 1.2 W/kg or all required channels are tested.

4: The 2.4G WLAN and BT cannot transmit simultaneously.

---

## **9.2. Test position and configuration**

1. Liquid tissue depth was at least 15.0 cm for all frequencies.
2. The manufacturer has confirmed that the device(s) tested have the same physical, mechanical and thermal characteristics and are within operational tolerances expected for production units.
3. SAR results were scaled to the maximum allowed power to demonstrate compliance per FCC KDB Publication 447498 D01v06.

## Appendix A. SAR System Validation Data

Date/Time: 03/14/2018

Test Laboratory: DEKRA Lab

System Check body 2450MHz

**DUT: Dipole 2450 MHz D2450V2; Type: D2450V2**

Communication System: UID 0, CW; Communication System Band: D2450(2450MHz); Duty Cycle: 1:1;

Frequency: 2450 MHz; Medium parameters used:  $f = 2450$  MHz;  $\sigma = 1.95$  S/m;  $\epsilon_r = 52.04$ ;  $\rho = 1000$  kg/m<sup>3</sup> ;

Phantom section: Flat Section ; Input Power=250mW

Ambient temperature (°C): 21.5, Liquid temperature (°C): 21.0

DASY5 Configuration:

- Probe: EX3DV4 - SN3661; ConvF(7.54, 7.54, 7.54); Calibrated: 05/05/2017;
- Sensor-Surface: 4mm (Mechanical Surface Detection)
- Electronics: DAE4 Sn905; Calibrated: 20/06/2017
- Phantom: SAM1; Type: SAM; Serial: TP1561
- Measurement SW: DASY52, Version 52.8 (8); SEMCAD X Version 14.6.10 (7331)

**Configuration/System Check Body 2450MHz/Area Scan (7x11x1):** Measurement grid: dx=10mm, dy=10mm; Maximum value of SAR (measured) = 12.8 W/kg

**Configuration/System Check Body 2450MHz/Zoom Scan (7x7x7)/Cube 0:** Measurement grid: dx=5mm, dy=5mm, dz=5mm; Reference Value = 81.40 V/m; Power Drift = 0.18 dB

Peak SAR (extrapolated) = 25.3 W/kg

**SAR(1 g) = 12.5 W/kg; SAR(10 g) = 5.69 W/kg;** Maximum value of SAR (measured) = 14.4 W/kg

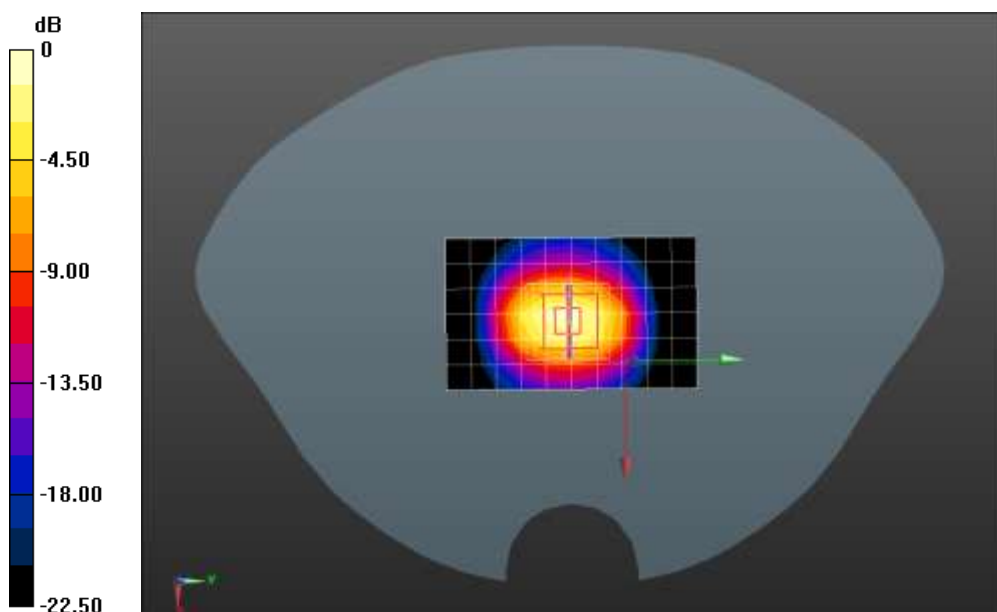

0 dB = 14.4 W/kg = 11.58 dBW/kg

## Appendix B. SAR measurement Data

Date/Time: 03/14/2018

Test Laboratory: DEKRA Lab

WIFI 802.11b 2437MHz body Front

**DUT: GEYE 500; Type: 8387341**

Communication System: UID 0, Wi-Fi (0); Communication System Band: 802.11b; Duty Cycle: 1:1.0;

Frequency: 2437 MHz; Medium parameters used:  $f = 2437$  MHz;  $\sigma = 1.91$  S/m;  $\epsilon_r = 51.1$ ;  $\rho = 1000$  kg/m<sup>3</sup> ;

Phantom section: Flat Section

Ambient temperature (°C): 21.5, Liquid temperature (°C): 21.0

DASY5 Configuration:

- Probe: EX3DV4 - SN3661; ConvF(7.54, 7.54, 7.54); Calibrated: 05/05/2017;
- Sensor-Surface: 4mm (Mechanical Surface Detection)
- Electronics: DAE4 Sn905; Calibrated: 20/06/2017
- Phantom: SAM1; Type: SAM; Serial: TP1561
- Measurement SW: DASY52, Version 52.8 (8); SEMCAD X Version 14.6.10 (7331)

**Configuration/WIFI 2437MHz Body Front/Area Scan (7x7x1):** Measurement grid: dx=12mm, dy=12mm

Maximum value of SAR (measured) = 0.587 W/kg

**Configuration/WIFI 2437MHz Body Front/Zoom Scan (5x5x7)/Cube 0:** Measurement grid: dx=8mm,

dy=8mm, dz=5mm; Reference Value = 15.48 V/m; Power Drift = 0.13 dB

Peak SAR (extrapolated) = 1.39 W/kg

**SAR(1 g) = 0.566 W/kg; SAR(10 g) = 0.230 W/kg;**Maximum value of SAR (measured) = 0.604 W/kg

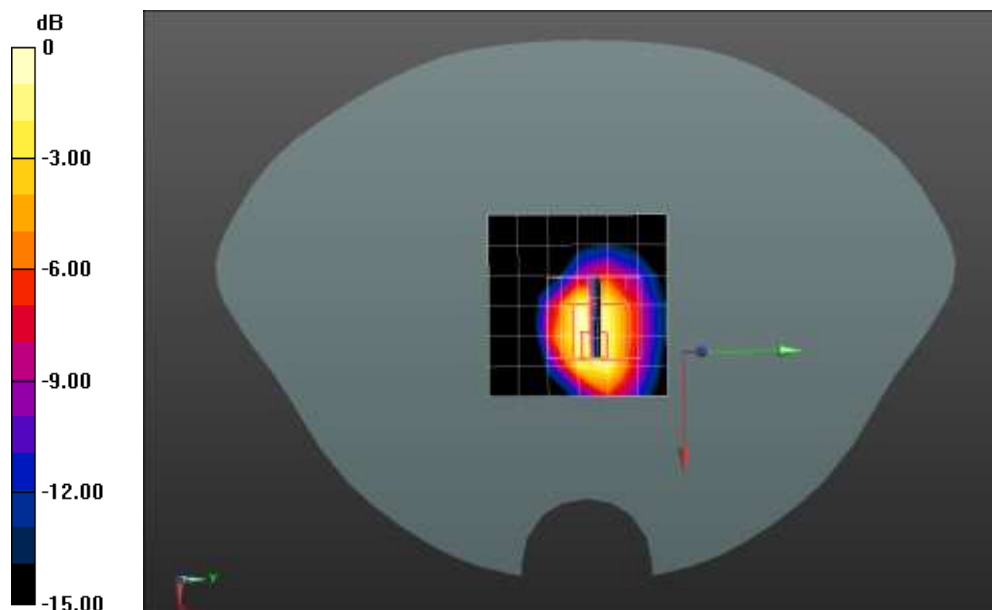

0 dB = 0.604 W/kg = -2.19 dBW/kg

Date/Time: 03/14/2018

Test Laboratory: DEKRA Lab

WIFI 802.11b 2437MHz body edge1

**DUT: GEYE 500; Type: 8387341**

Communication System: UID 0, Wi-Fi (0); Communication System Band: 802.11b; Duty Cycle: 1:1.0;

Frequency: 2437 MHz; Medium parameters used:  $f = 2437$  MHz;  $\sigma = 1.91$  S/m;  $\epsilon_r = 51.1$ ;  $\rho = 1000$  kg/m<sup>3</sup> ;

Phantom section: Flat Section

Ambient temperature (°C): 21.5, Liquid temperature (°C): 21.0

DASY5 Configuration:

- Probe: EX3DV4 - SN3661; ConvF(7.54, 7.54, 7.54); Calibrated: 05/05/2017;
- Sensor-Surface: 4mm (Mechanical Surface Detection)
- Electronics: DAE4 Sn905; Calibrated: 20/06/2017
- Phantom: SAM1; Type: SAM; Serial: TP1561
- Measurement SW: DASY52, Version 52.8 (8); SEMCAD X Version 14.6.10 (7331)

**Configuration/WIFI 2437MHz Body edge1/Area Scan (7x7x1):** Measurement grid: dx=12mm, dy=12mm

Maximum value of SAR (measured) = 0.682 W/kg

**Configuration/WIFI 2437MHz Body edge1/Zoom Scan (5x5x7)/Cube 0:** Measurement grid: dx=8mm, dy=8mm, dz=5mm

Reference Value = 18.70 V/m; Power Drift = 0.06 dB

Peak SAR (extrapolated) = 1.783 W/kg

**SAR(1 g) = 0.673 W/kg; SAR(10 g) = 0.273 W/kg**

Maximum value of SAR (measured) = 0.704 W/kg

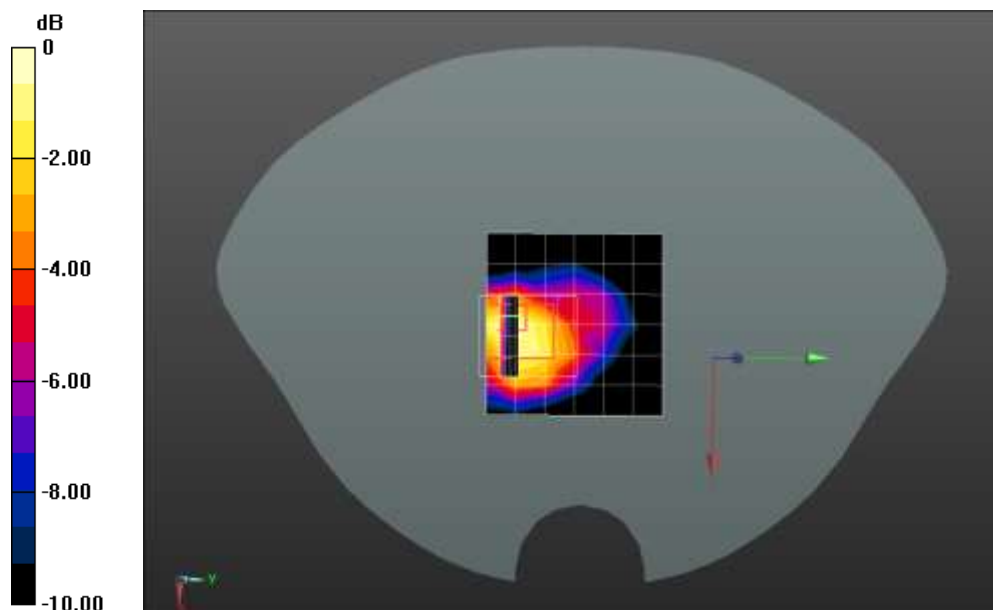

0 dB = 0.164 W/kg = -7.85 dBW/kg



Date/Time: 03/14/2018

Test Laboratory: DEKRA Lab

WIFI 802.11b 2437MHz body Edge2

**DUT: GEYE 500; Type: 8387341**

Communication System: UID 0, Wi-Fi (0); Communication System Band: 802.11b; Duty Cycle: 1:1.0;

Frequency: 2437 MHz; Medium parameters used:  $f = 2437$  MHz;  $\sigma = 1.91$  S/m;  $\epsilon_r = 51.1$ ;  $\rho = 1000$  kg/m<sup>3</sup> ;

Phantom section: Flat Section

Ambient temperature (°C): 21.5, Liquid temperature (°C): 21.0

DASY5 Configuration:

- Probe: EX3DV4 - SN3661; ConvF(7.54, 7.54, 7.54); Calibrated: 05/05/2017;
- Sensor-Surface: 4mm (Mechanical Surface Detection)
- Electronics: DAE4 Sn905; Calibrated: 20/06/2017
- Phantom: SAM1; Type: SAM; Serial: TP1561
- Measurement SW: DASY52, Version 52.8 (8); SEMCAD X Version 14.6.10 (7331)

**Configuration/WIFI 2437MHz Body Edge2/Area Scan (7x7x1):** Measurement grid: dx=12mm, dy=12mm

Maximum value of SAR (measured) = 0.749 W/kg

**Configuration/WIFI 2437MHz Body Edge2/Zoom Scan (5x5x7)/Cube 0:** Measurement grid: dx=8mm, dy=8mm, dz=5mm

Reference Value = 21.72 V/m; Power Drift = -0.03 dB

Peak SAR (extrapolated) = 2.15 W/kg

**SAR(1 g) = 0.713 W/kg; SAR(10 g) = 0.324 W/kg**

Maximum value of SAR (measured) = 0.835 W/kg

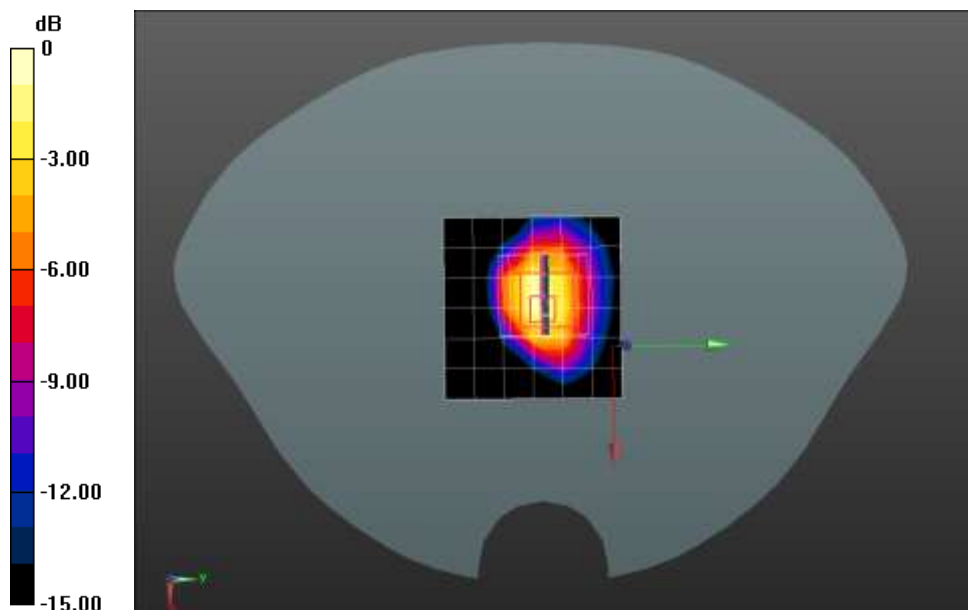

0 dB = 0.835 W/kg = -0.78 dBW/kg

Date/Time: 03/14/2018

Test Laboratory: DEKRA Lab

WIFI 802.11b 2437MHz body Edge3

**DUT: GEYE 500; Type: 8387341**

Communication System: UID 0, Wi-Fi (0); Communication System Band: 802.11b; Duty Cycle: 1:1.0;

Frequency: 2437 MHz; Medium parameters used:  $f = 2437$  MHz;  $\sigma = 1.91$  S/m;  $\epsilon_r = 51.1$ ;  $\rho = 1000$  kg/m<sup>3</sup> ;

Phantom section: Flat Section

Ambient temperature (°C): 21.5, Liquid temperature (°C): 21.0

DASY5 Configuration:

- Probe: EX3DV4 - SN3661; ConvF(7.54, 7.54, 7.54); Calibrated: 05/05/2017;
- Sensor-Surface: 4mm (Mechanical Surface Detection)
- Electronics: DAE4 Sn905; Calibrated: 20/06/2017
- Phantom: SAM1; Type: SAM; Serial: TP1561
- Measurement SW: DASY52, Version 52.8 (8); SEMCAD X Version 14.6.10 (7331)

**Configuration/WIFI 2437MHz Body Edge3/Area Scan (7x7x1):** Measurement grid: dx=12mm, dy=12mm

Maximum value of SAR (measured) = 0.642 W/kg

**Configuration/WIFI 2437MHz Body Edge3/Zoom Scan (5x5x7)/Cube 0:** Measurement grid: dx=8mm, dy=8mm, dz=5mm

Reference Value = 20.26 V/m; Power Drift = 0.13 dB

Peak SAR (extrapolated) = 1.73 W/kg

**SAR(1 g) = 0.660 W/kg; SAR(10 g) = 0.298 W/kg**

Maximum value of SAR (measured) = 0.755 W/kg

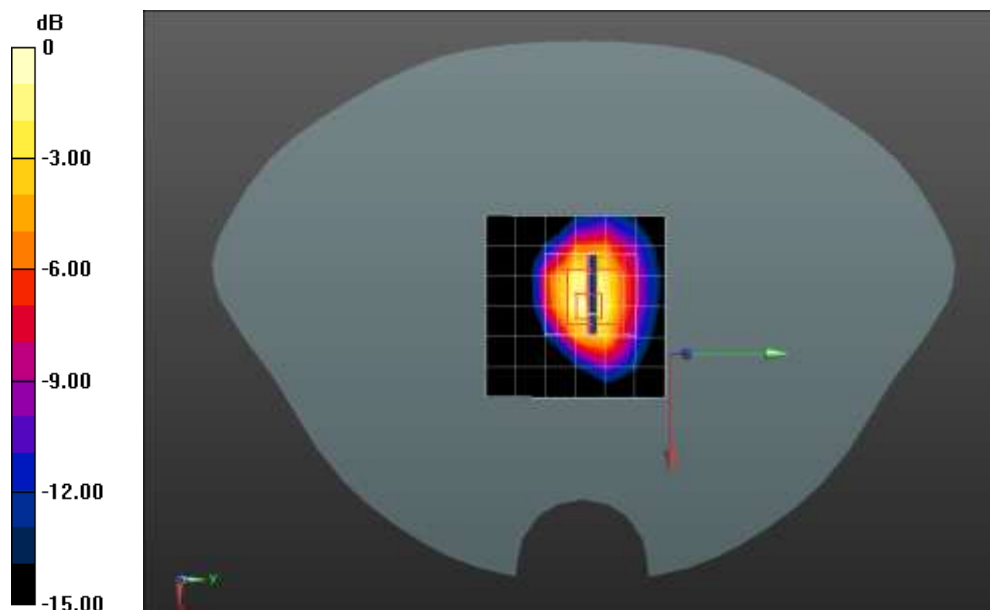

0 dB = 0.755 W/kg = -1.22 dBW/kg

Date/Time: 03/14/2018

Test Laboratory: DEKRA Lab

WIFI 802.11b 2437MHz Body edge4

**DUT: GEYE 500; Type: 8387341**

Communication System: UID 0, Wi-Fi (0); Communication System Band: 802.11b; Duty Cycle: 1:1.0;

Frequency: 2437 MHz; Medium parameters used:  $f = 2437$  MHz;  $\sigma = 1.91$  S/m;  $\epsilon_r = 51.1$ ;  $\rho = 1000$  kg/m<sup>3</sup> ;

Phantom section: Flat Section

Ambient temperature (°C): 21.5, Liquid temperature (°C): 21.0

DASY5 Configuration:

- Probe: EX3DV4 - SN3661; ConvF(7.54, 7.54, 7.54); Calibrated: 05/05/2017;
- Sensor-Surface: 4mm (Mechanical Surface Detection)
- Electronics: DAE4 Sn905; Calibrated: 20/06/2017
- Phantom: SAM1; Type: SAM; Serial: TP1561
- Measurement SW: DASY52, Version 52.8 (8); SEMCAD X Version 14.6.10 (7331)

**Configuration/WIFI 2437MHz Body Edge4/Area Scan (7x7x1):** Measurement grid: dx=12mm, dy=12mm

Maximum value of SAR (measured) = 0.380 W/kg

**Configuration/WIFI 2437MHz Body Edge4/Zoom Scan (5x5x7)/Cube 0:** Measurement grid: dx=8mm, dy=8mm, dz=5mm

Reference Value = 5.915 V/m; Power Drift = 0.10 dB

Peak SAR (extrapolated) = 0.846 W/kg

**SAR(1 g) = 0.377 W/kg; SAR(10 g) = 0.170 W/kg**

Maximum value of SAR (measured) = 0.417 W/kg

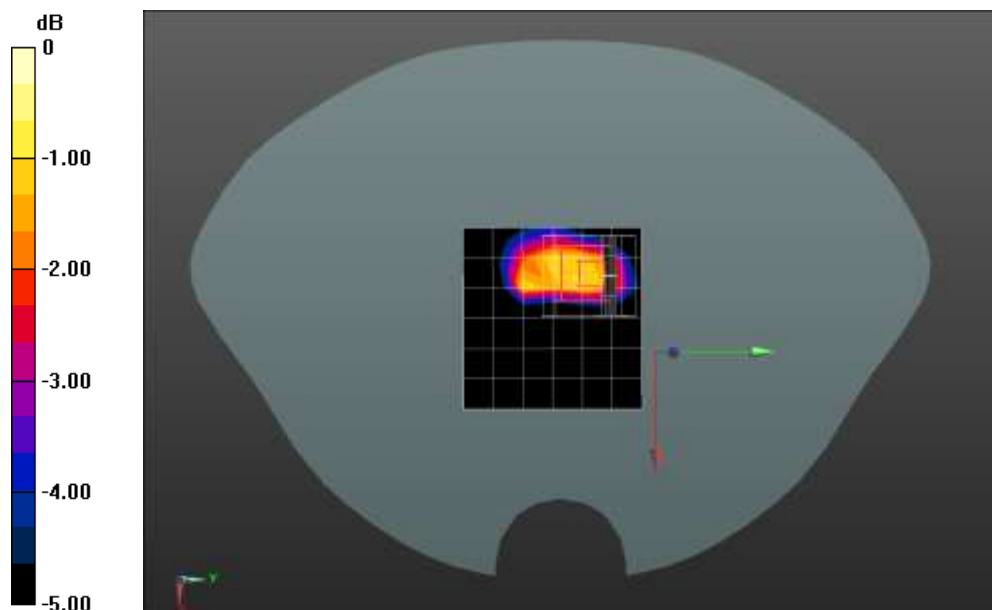

0 dB = 0.417 W/kg = -3.80 dBW/kg

Date/Time: 03/14/2018

Test Laboratory: DEKRA Lab

WIFI 802.11b 2412MHz body Edge2

**DUT: GEYE 500; Type: 8387341**

Communication System: UID 0, Wi-Fi (0); Communication System Band: 802.11b; Duty Cycle: 1:1.0;

Frequency: 2412 MHz; Medium parameters used:  $f = 2412$  MHz;  $\sigma = 1.88$  S/m;  $\epsilon_r = 51.2$ ;  $\rho = 1000$  kg/m<sup>3</sup> ;

Phantom section: Flat Section

Ambient temperature (°C): 21.5, Liquid temperature (°C): 21.0

DASY5 Configuration:

- Probe: EX3DV4 - SN3661; ConvF(7.54, 7.54, 7.54); Calibrated: 05/05/2017;
- Sensor-Surface: 4mm (Mechanical Surface Detection)
- Electronics: DAE4 Sn905; Calibrated: 20/06/2017
- Phantom: SAM1; Type: SAM; Serial: TP1561
- Measurement SW: DASY52, Version 52.8 (8); SEMCAD X Version 14.6.10 (7331)

**Configuration/WIFI 2412MHz Body Edge2/Area Scan (7x7x1):** Measurement grid: dx=12mm, dy=12mm

Maximum value of SAR (measured) = 0.714 W/kg

**Configuration/WIFI 2412MHz Body Edge2/Zoom Scan (5x5x7)/Cube 0:** Measurement grid: dx=8mm, dy=8mm, dz=5mm

Reference Value = 17.90 V/m; Power Drift = -0.07 dB

Peak SAR (extrapolated) = 1.72 W/kg

**SAR(1 g) = 0.691 W/kg; SAR(10 g) = 0.309 W/kg**

Maximum value of SAR (measured) = 0.711 W/kg

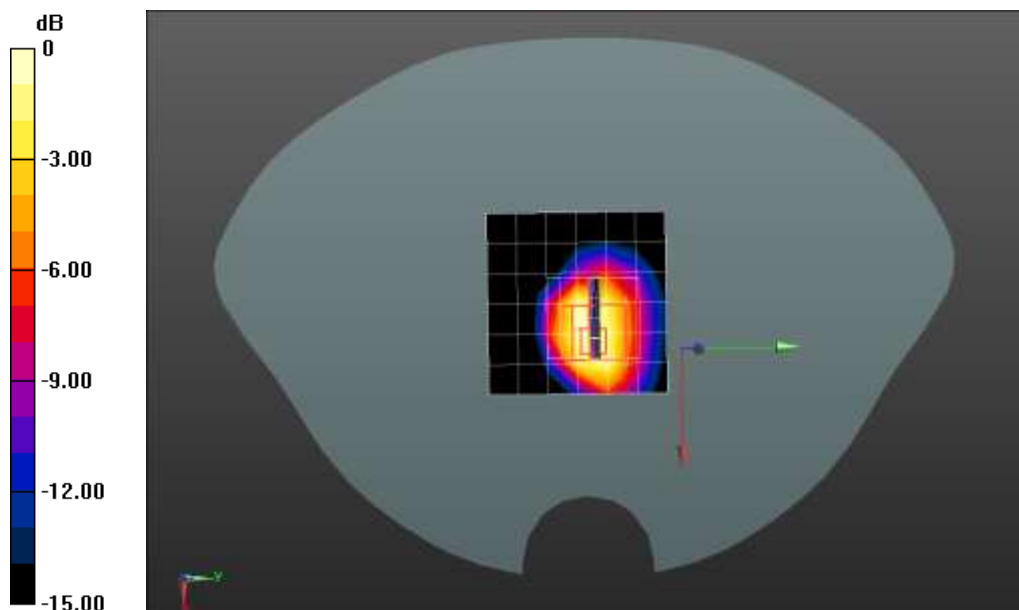

0 dB = 0.711 W/kg = -1.48 dBW/kg

Date/Time: 03/14/2018

Test Laboratory: DEKRA Lab

WIFI 802.11b 2462MHz body Edge2

**DUT: GEYE 500; Type: 8387341**

Communication System: UID 0, Wi-Fi (0); Communication System Band: 802.11b; Duty Cycle: 1:1.0;

Frequency: 2437 MHz; Medium parameters used:  $f = 2437$  MHz;  $\sigma = 1.91$  S/m;  $\epsilon_r = 51.1$ ;  $\rho = 1000$  kg/m<sup>3</sup> ;

Phantom section: Flat Section

Ambient temperature (°C): 21.5, Liquid temperature (°C): 21.0

DASY5 Configuration:

- Probe: EX3DV4 - SN3661; ConvF(7.54, 7.54, 7.54); Calibrated: 05/05/2017;
- Sensor-Surface: 4mm (Mechanical Surface Detection)
- Electronics: DAE4 Sn905; Calibrated: 20/06/2017
- Phantom: SAM1; Type: SAM; Serial: TP1561
- Measurement SW: DASY52, Version 52.8 (8); SEMCAD X Version 14.6.10 (7331)

**Configuration/WIFI 2462MHz Body Edge2/Area Scan (7x7x1):** Measurement grid: dx=12mm, dy=12mm

Maximum value of SAR (measured) = 0.737 W/kg

**Configuration/WIFI 2462MHz Body Edge2/Zoom Scan (5x5x7)/Cube 0:** Measurement grid: dx=8mm, dy=8mm, dz=5mm

Reference Value = 18.31 V/m; Power Drift = 0.09 dB

Peak SAR (extrapolated) = 1.69 W/kg

**SAR(1 g) = 0.705 W/kg; SAR(10 g) = 0.316 W/kg**

Maximum value of SAR (measured) = 0.765 W/kg

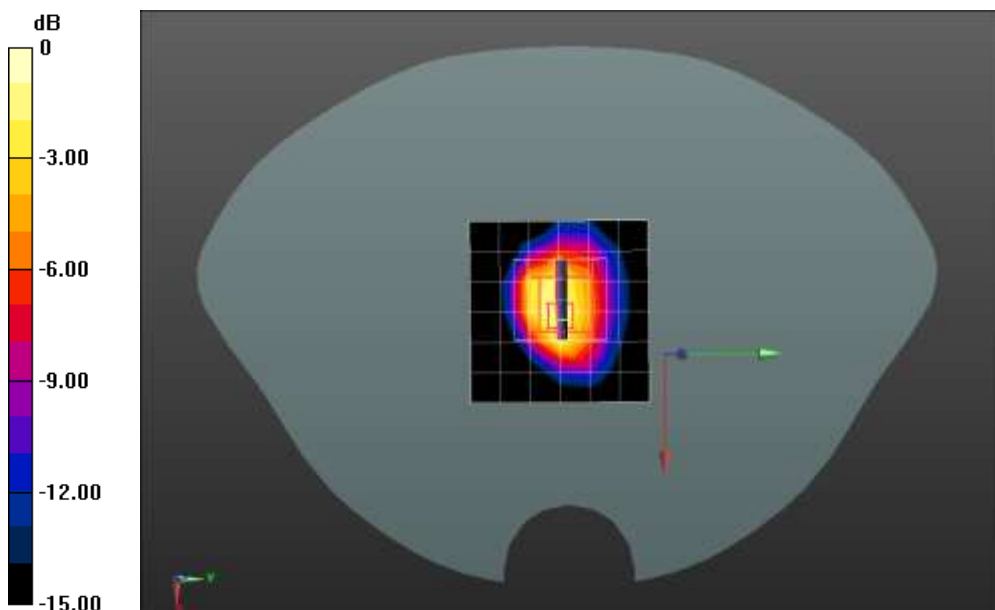

0 dB = 0.765 W/kg = -1.16 dBW/kg

Date/Time: 03/14/2018

Test Laboratory: DEKRA Lab

WIFI 802.11g 2437MHz body Edge2

**DUT: GEYE 500; Type: 8387341**

Communication System: UID 0, Wi-Fi (0); Communication System Band: 802.11g; Duty Cycle: 1:1.0;

Frequency: 2437 MHz; Medium parameters used:  $f = 2437$  MHz;  $\sigma = 1.91$  S/m;  $\epsilon_r = 52.1$ ;  $\rho = 1000$  kg/m<sup>3</sup> ;

Phantom section: Flat Section

Ambient temperature (°C): 21.5, Liquid temperature (°C): 21.0

DASY5 Configuration:

- Probe: EX3DV4 - SN3661; ConvF(7.54, 7.54, 7.54); Calibrated: 05/05/2017;
- Sensor-Surface: 4mm (Mechanical Surface Detection)
- Electronics: DAE4 Sn905; Calibrated: 20/06/2017
- Phantom: SAM1; Type: SAM; Serial: TP1561
- Measurement SW: DASY52, Version 52.8 (8); SEMCAD X Version 14.6.10 (7331)

**Configuration/WIFI 2437MHz Body Edge2/Area Scan (7x7x1):** Measurement grid: dx=12mm, dy=12mm

Maximum value of SAR (measured) = 0.718 W/kg

**Configuration/WIFI 2437MHz Body Edge2/Zoom Scan (5x5x7)/Cube 0:** Measurement grid: dx=8mm, dy=8mm, dz=5mm; Reference Value = 20.21 V/m; Power Drift = -0.01 dB

Peak SAR (extrapolated) = 1.90 W/kg

**SAR(1 g) = 0.702 W/kg; SAR(10 g) = 0.312 W/kg**

Maximum value of SAR (measured) = 0.807 W/kg

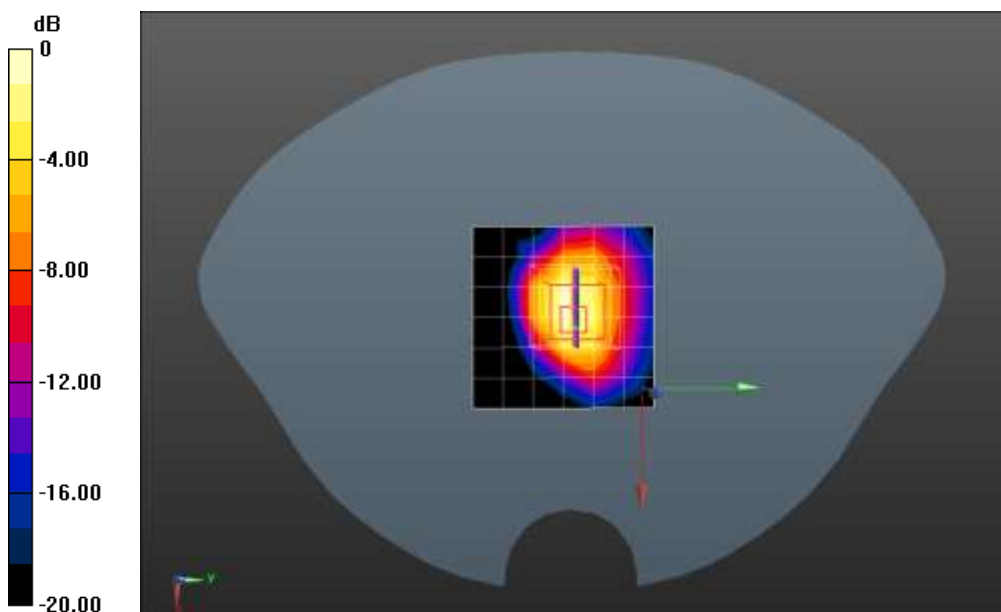

0 dB = 0.807 W/kg = -0.93 dBW/kg

Date/Time: 03/14/2018

Test Laboratory: DEKRA Lab

Bluetooth 2440MHz Body BLE Edge2

**DUT: GEYE 500; Type: 8387341**

Communication System: UID 0, Bluetooth (0); Communication System Band: BLE; Duty Cycle: 1:1.0;

Frequency: 2440 MHz; Medium parameters used:  $f = 2440$  MHz;  $\sigma = 1.94$  S/m;  $\epsilon_r = 52.04$ ;  $\rho = 1000$  kg/m<sup>3</sup> ;

Phantom section: Flat Section

Ambient temperature (°C): 21.5, Liquid temperature (°C): 21.0

DASY5 Configuration:

- Probe: EX3DV4 - SN3661; ConvF(7.54, 7.54, 7.54); Calibrated: 05/05/2017;
- Sensor-Surface: 4mm (Mechanical Surface Detection)
- Electronics: DAE4 Sn905; Calibrated: 20/06/2017
- Phantom: SAM1; Type: SAM; Serial: TP1561
- Measurement SW: DASY52, Version 52.8 (8); SEMCAD X Version 14.6.10 (7331)

**Configuration/Bluetooth 2440MHz BLE Body Edge2/Area Scan (7x7x1):** Measurement grid: dx=12mm, dy=12mm; Maximum value of SAR (measured) = 0.147 W/kg

**Configuration/Bluetooth 2440MHz BLE Body Edge2/Zoom Scan (5x5x7)/Cube 0:** Measurement grid: dx=8mm, dy=8mm, dz=5mm

Reference Value = 2.054 V/m; Power Drift = 0.05 dB

Peak SAR (extrapolated) = 0.522 W/kg

**SAR(1 g) = 0.183 W/kg; SAR(10 g) = 0.070 W/kg**

Maximum value of SAR (measured) = 0.23 W/kg

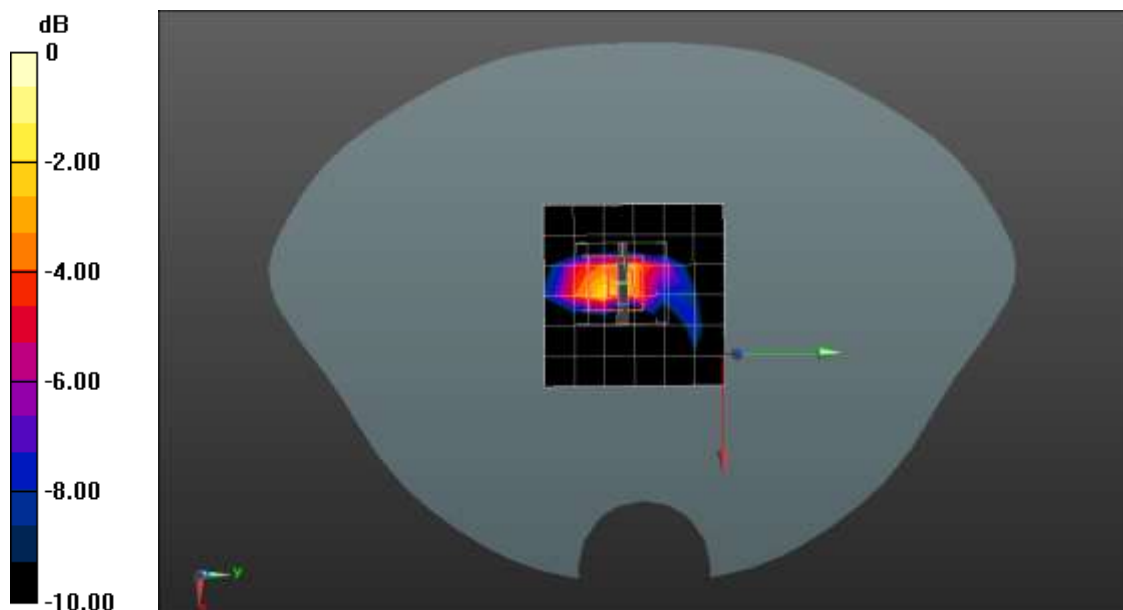

0 dB = 0.23 W/kg = -6.38 dBW/kg

### 2450 Body

Calibrated return loss: -23.882 dB; Measured return loss: -23.349dB (within 20%)

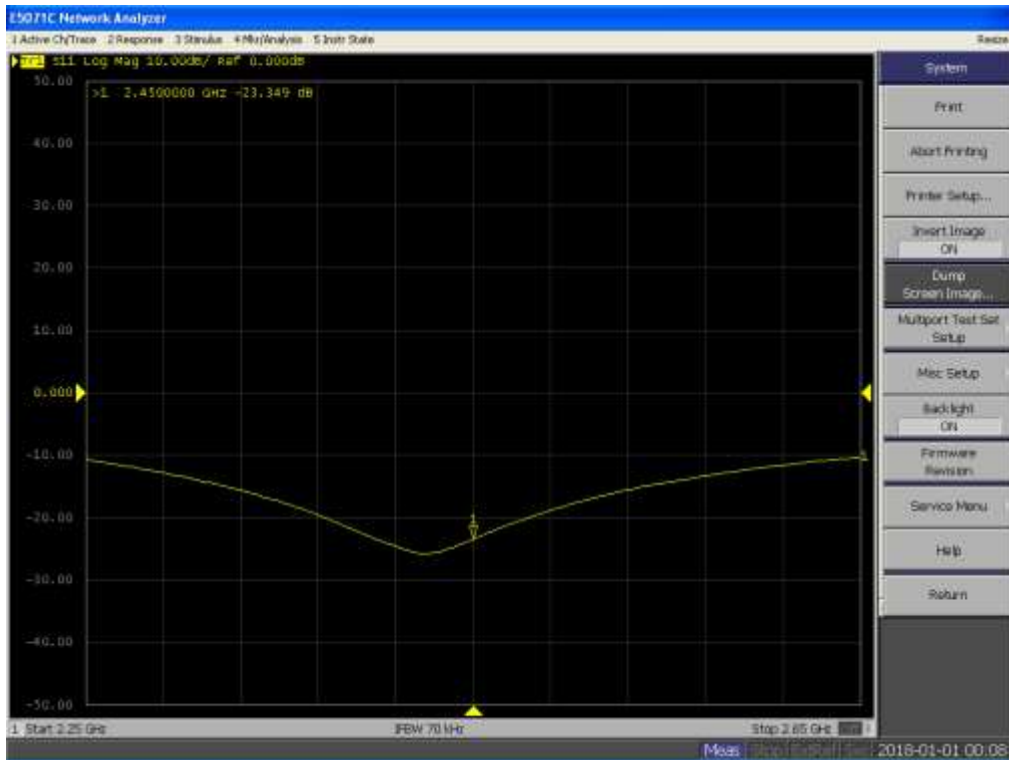

Calibrated impedance: 50.244 Ω; Measured impedance: 49.316Ω (within 5Ω)

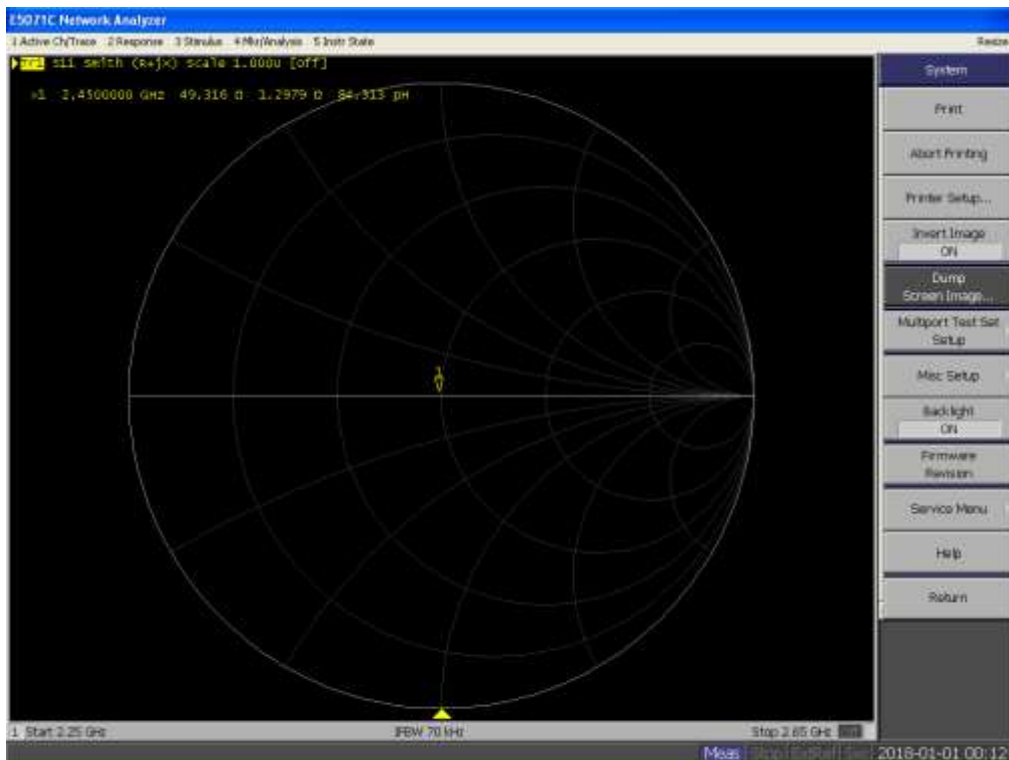



### Appendix C. Probe Calibration Data



Add: No.51 Xueyuan Road, Haidian District, Beijing, 100191, China  
 Tel: +86-10-62304633-2218 Fax: +86-10-62304633-2209  
 E-mail: ctll@chinattl.com Http://www.chinattl.cn



中国认可  
 国际互认  
 校准  
 CALIBRATION  
 CNAS L0570

Client **Auden**

Certificate No: **Z17-97051**

#### CALIBRATION CERTIFICATE

Object: **EX3DV4 - SN:3661**

Calibration Procedure(s): **FF-Z11-004-01**  
**Calibration Procedures for Dosimetric E-field Probes**



Calibration date: **May 05, 2017**

This calibration Certificate documents the traceability to national standards, which realize the physical units of measurements(SI). The measurements and the uncertainties with confidence probability are given on the following pages and are part of the certificate.

All calibrations have been conducted in the closed laboratory facility: environment temperature(22±3)°C and humidity<70%.

Calibration Equipment used (M&TE critical for calibration)

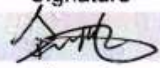
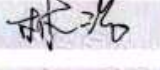
Primary Standards	ID #	Cal Date(Calibrated by, Certificate No.)	Scheduled Calibration
Power Meter NRP2	101919	27-Jun-16 (CTTL, No.J16X04777)	Jun-17
Power sensor NRP-Z91	101547	27-Jun-16 (CTTL, No.J16X04777)	Jun-17
Power sensor NRP-Z91	101548	27-Jun-16 (CTTL, No.J16X04777)	Jun-17
Reference10dBAttenuator	18N50W-10dB	13-Mar-16(CTTL,No.J16X01547)	Mar-18
Reference20dBAttenuator	18N50W-20dB	13-Mar-16(CTTL, No.J16X01548)	Mar-18
Reference Probe EX3DV4	SN 7433	26-Sep-16(SPEAG,No.EX3-7433_Sep16)	Sep-17
DAE4	SN 549	13-Dec-16(SPEAG, No.DAE4-549_Dec16)	Dec -17
Secondary Standards	ID #	Cal Date(Calibrated by, Certificate No.)	Scheduled Calibration
SignalGeneratorMG3700A	6201052605	27-Jun-16 (CTTL, No.J16X04776)	Jun-17
Network Analyzer E5071C	MY46110673	13-Jan-17 (CTTL, No.J17X00285)	Jan -18

	Name	Function	Signature
Calibrated by:	Yu Zongying	SAR Test Engineer	
Reviewed by:	Lin Hao	SAR Test Engineer	
Approved by:	Qi Dianyuan	SAR Project Leader	

Issued: May 06, 2017

This calibration certificate shall not be reproduced except in full without written approval of the laboratory.





Add: No.51 Xueyuan Road, Haidian District, Beijing, 100191, China  
Tel: +86-10-62304633-2218 Fax: +86-10-62304633-2209  
E-mail: cttl@chinattl.com [Http://www.chinattl.cn](http://www.chinattl.cn)

### Glossary:

TSL	tissue simulating liquid
NORM <sub>x,y,z</sub>	sensitivity in free space
ConvF	sensitivity in TSL / NORM <sub>x,y,z</sub>
DCP	diode compression point
CF	crest factor (1/duty_cycle) of the RF signal
A,B,C,D	modulation dependent linearization parameters
Polarization $\Phi$	$\Phi$ rotation around probe axis
Polarization $\theta$	$\theta$ rotation around an axis that is in the plane normal to probe axis (at measurement center), $\theta=0$ is normal to probe axis

Connector Angle information used in DASY system to align probe sensor X to the robot coordinate system

### Calibration is Performed According to the Following Standards:

- IEEE Std 1528-2013, "IEEE Recommended Practice for Determining the Peak Spatial-Averaged Specific Absorption Rate (SAR) in the Human Head from Wireless Communications Devices: Measurement Techniques", June 2013
- IEC 62209-1, "Procedure to measure the Specific Absorption Rate (SAR) for hand-held devices used in close proximity to the ear (frequency range of 300MHz to 3GHz)", February 2005
- IEC 62209-2, "Procedure to determine the Specific Absorption Rate (SAR) for wireless communication devices used in close proximity to the human body (frequency range of 30 MHz to 6 GHz)", March 2010
- KDB 865664, "SAR Measurement Requirements for 100 MHz to 6 GHz"

### Methods Applied and Interpretation of Parameters:

- NORM<sub>x,y,z</sub>**: Assessed for E-field polarization  $\theta=0$  ( $f \leq 900\text{MHz}$  in TEM-cell;  $f > 1800\text{MHz}$ : waveguide). NORM<sub>x,y,z</sub> are only intermediate values, i.e., the uncertainties of NORM<sub>x,y,z</sub> does not effect the  $E^2$ -field uncertainty inside TSL (see below ConvF).
- NORM(f)<sub>x,y,z</sub>** = NORM<sub>x,y,z</sub> \* frequency\_response (see Frequency Response Chart). This linearization is implemented in DASY4 software versions later than 4.2. The uncertainty of the frequency response is included in the stated uncertainty of ConvF.
- DCP<sub>x,y,z</sub>**: DCP are numerical linearization parameters assessed based on the data of power sweep (no uncertainty required). DCP does not depend on frequency nor media.
- PAR**: PAR is the Peak to Average Ratio that is not calibrated but determined based on the signal characteristics.
- A<sub>x,y,z</sub>; B<sub>x,y,z</sub>; C<sub>x,y,z</sub>; VR<sub>x,y,z</sub>**: A,B,C are numerical linearization parameters assessed based on the data of power sweep for specific modulation signal. The parameters do not depend on frequency nor media. VR is the maximum calibration range expressed in RMS voltage across the diode.
- ConvF and Boundary Effect Parameters**: Assessed in flat phantom using E-field (or Temperature Transfer Standard for  $f \leq 800\text{MHz}$ ) and inside waveguide using analytical field distributions based on power measurements for  $f > 800\text{MHz}$ . The same setups are used for assessment of the parameters applied for boundary compensation (alpha, depth) of which typical uncertainty valued are given. These parameters are used in DASY4 software to improve probe accuracy close to the boundary. The sensitivity in TSL corresponds to NORM<sub>x,y,z</sub>\* ConvF whereby the uncertainty corresponds to that given for ConvF. A frequency dependent ConvF is used in DASY version 4.4 and higher which allows extending the validity from  $\pm 50\text{MHz}$  to  $\pm 100\text{MHz}$ .
- Spherical isotropy (3D deviation from isotropy)**: in a field of low gradients realized using a flat phantom exposed by a patch antenna.
- Sensor Offset**: The sensor offset corresponds to the offset of virtual measurement center from the probe tip (on probe axis). No tolerance required.
- Connector Angle**: The angle is assessed using the information gained by determining the NORM<sub>x</sub> (no uncertainty required).



Add: No.51 Xueyuan Road, Haidian District, Beijing, 100191, China  
Tel: +86-10-62304633-2218 Fax: +86-10-62304633-2209  
E-mail: [cttl@chinattl.com](mailto:cttl@chinattl.com) [Http://www.chinattl.cn](http://www.chinattl.cn)

# Probe EX3DV4

## SN: 3661

Calibrated: May 05, 2017

Calibrated for DASY/EASY Systems

(Note: non-compatible with DASY2 system!)



Add: No.51 Xueyuan Road, Haidian District, Beijing, 100191, China  
 Tel: +86-10-62304633-2218 Fax: +86-10-62304633-2209  
 E-mail: [ctl@chinattl.com](mailto:ctl@chinattl.com) [Http://www.chinattl.cn](http://www.chinattl.cn)

## DASY/EASY – Parameters of Probe: EX3DV4 – SN: 3661

### Basic Calibration Parameters

	Sensor X	Sensor Y	Sensor Z	Unc (k=2)
Norm( $\mu\text{V}/(\text{V}/\text{m})^2$ ) <sup>A</sup>	0.48	0.52	0.48	±10.0%
DCP(mV) <sup>B</sup>	101.6	100.2	102.2	

### Modulation Calibration Parameters

UID	Communication System Name		A dB	B dB $\sqrt{\mu\text{V}}$	C	D dB	VR mV	Unc <sup>E</sup> (k=2)
0	CW	X	0.0	0.0	1.0	0.00	201.4	±2.0%
		Y	0.0	0.0	1.0		213.0	
		Z	0.0	0.0	1.0		202.8	

The reported uncertainty of measurement is stated as the standard uncertainty of Measurement multiplied by the coverage factor k=2, which for a normal distribution Corresponds to a coverage probability of approximately 95%.

<sup>A</sup> The uncertainties of Norm X, Y, Z do not affect the E<sup>2</sup>-field uncertainty inside TSL (see Page 5 and Page 6).  
<sup>B</sup> Numerical linearization parameter: uncertainty not required.  
<sup>E</sup> Uncertainty is determined using the max. deviation from linear response applying rectangular distribution and is expressed for the square of the field value.





Add: No.51 Xueyuan Road, Haidian District, Beijing, 100191, China  
 Tel: +86-10-62304633-2218 Fax: +86-10-62304633-2209  
 E-mail: [cttl@chinattl.com](mailto:cttl@chinattl.com) [Http://www.chinattl.cn](http://www.chinattl.cn)

## DASY/EASY – Parameters of Probe: EX3DV4 – SN: 3661

### Calibration Parameter Determined in Head Tissue Simulating Media

f [MHz] <sup>C</sup>	Relative Permittivity <sup>F</sup>	Conductivity (S/m) <sup>F</sup>	ConvF X	ConvF Y	ConvF Z	Alpha <sup>G</sup>	Depth <sup>G</sup> (mm)	Unct. (k=2)
750	41.9	0.89	9.89	9.89	9.89	0.30	0.85	± 12.1%
835	41.5	0.90	9.57	9.57	9.57	0.13	1.40	± 12.1%
900	41.5	0.97	9.73	9.73	9.73	0.13	1.36	± 12.1%
1750	40.1	1.37	8.47	8.47	8.47	0.17	1.36	± 12.1%
1900	40.0	1.40	8.10	8.10	8.10	0.21	1.10	± 12.1%
2000	40.0	1.40	8.09	8.09	8.09	0.20	1.11	± 12.1%
2300	39.5	1.67	7.93	7.93	7.93	0.39	0.83	± 12.1%
2450	39.2	1.80	7.64	7.64	7.64	0.43	0.82	± 12.1%
2600	39.0	1.96	7.35	7.35	7.35	0.55	0.71	± 12.1%
3500	37.9	2.91	7.23	7.23	7.23	0.53	0.84	± 13.3%
5250	35.9	4.71	5.36	5.36	5.36	0.40	1.30	± 13.3%
5600	35.5	5.07	4.88	4.88	4.88	0.40	1.50	± 13.3%
5750	35.4	5.22	4.87	4.87	4.87	0.40	1.50	± 13.3%

<sup>C</sup> Frequency validity above 300 MHz of ±100MHz only applies for DASY v4.4 and higher (Page 2), else it is restricted to ±50MHz. The uncertainty is the RSS of ConvF uncertainty at calibration frequency and the uncertainty for the indicated frequency band. Frequency validity below 300 MHz is ± 10, 25, 40, 50 and 70 MHz for ConvF assessments at 30, 64, 128, 150 and 220 MHz respectively. Above 5 GHz frequency validity can be extended to ± 110 MHz.

<sup>F</sup> At frequency below 3 GHz, the validity of tissue parameters ( $\epsilon$  and  $\sigma$ ) can be relaxed to ±10% if liquid compensation formula is applied to measured SAR values. At frequencies above 3 GHz, the validity of tissue parameters ( $\epsilon$  and  $\sigma$ ) is restricted to ±5%. The uncertainty is the RSS of the ConvF uncertainty for indicated target tissue parameters.

<sup>G</sup> Alpha/Depth are determined during calibration. SPEAG warrants that the remaining deviation due to the boundary effect after compensation is always less than ± 1% for frequencies below 3 GHz and below ± 2% for the frequencies between 3-6 GHz at any distance larger than half the probe tip diameter from the boundary.



Add: No.51 Xueyuan Road, Haidian District, Beijing, 100191, China  
 Tel: +86-10-62304633-2218 Fax: +86-10-62304633-2209  
 E-mail: [ctl@chinatl.com](mailto:ctl@chinatl.com) [Http://www.chinatl.cn](http://www.chinatl.cn)

## DASY/EASY – Parameters of Probe: EX3DV4 – SN: 3661

### Calibration Parameter Determined in Body Tissue Simulating Media

f [MHz] <sup>C</sup>	Relative Permittivity <sup>F</sup>	Conductivity (S/m) <sup>F</sup>	ConvF X	ConvF Y	ConvF Z	Alpha <sup>G</sup>	Depth <sup>G</sup> (mm)	Unct. (k=2)
750	55.5	0.96	9.85	9.85	9.85	0.30	0.90	±12.1%
835	55.2	0.97	9.60	9.60	9.60	0.16	1.43	±12.1%
900	55.0	1.05	9.69	9.69	9.69	0.20	1.19	±12.1%
1750	53.4	1.49	8.26	8.26	8.26	0.22	1.11	±12.1%
1900	53.3	1.52	7.88	7.88	7.88	0.15	1.55	±12.1%
2000	53.3	1.52	7.92	7.92	7.92	0.21	1.24	±12.1%
2300	52.9	1.81	7.81	7.81	7.81	0.37	1.05	±12.1%
2450	52.7	1.95	7.54	7.54	7.54	0.29	1.46	±12.1%
2600	52.5	2.16	7.45	7.45	7.45	0.32	1.19	±12.1%
3500	51.3	3.31	6.67	6.67	6.67	0.59	0.94	±13.3%
5250	48.9	5.36	4.94	4.94	4.94	0.50	1.45	±13.3%
5600	48.5	5.77	4.32	4.32	4.32	0.55	1.35	±13.3%
5750	48.3	5.94	4.52	4.52	4.52	0.55	1.75	±13.3%

<sup>C</sup> Frequency validity above 300 MHz of ±100MHz only applies for DASY v4.4 and higher (Page 2), else it is restricted to ±50MHz. The uncertainty is the RSS of ConvF uncertainty at calibration frequency and the uncertainty for the indicated frequency band. Frequency validity below 300 MHz is ± 10, 25, 40, 50 and 70 MHz for ConvF assessments at 30, 64, 128, 150 and 220 MHz respectively. Above 5 GHz frequency validity can be extended to ± 110 MHz.

<sup>F</sup> At frequency below 3 GHz, the validity of tissue parameters ( $\epsilon$  and  $\sigma$ ) can be relaxed to ±10% if liquid compensation formula is applied to measured SAR values. At frequencies above 3 GHz, the validity of tissue parameters ( $\epsilon$  and  $\sigma$ ) is restricted to ±5%. The uncertainty is the RSS of the ConvF uncertainty for indicated target tissue parameters.

<sup>G</sup> Alpha/Depth are determined during calibration. SPEAG warrants that the remaining deviation due to the boundary effect after compensation is always less than ± 1% for frequencies below 3 GHz and below ± 2% for the frequencies between 3-6 GHz at any distance larger than half the probe tip diameter from the boundary.





Add: No.51 Xueyuan Road, Haidian District, Beijing, 100191, China  
Tel: +86-10-62304633-2218 Fax: +86-10-62304633-2209  
E-mail: cttl@chinattl.com [Http://www.chinattl.cn](http://www.chinattl.cn)

### Frequency Response of E-Field (TEM-Cell: ifi110 EXX, Waveguide: R22)

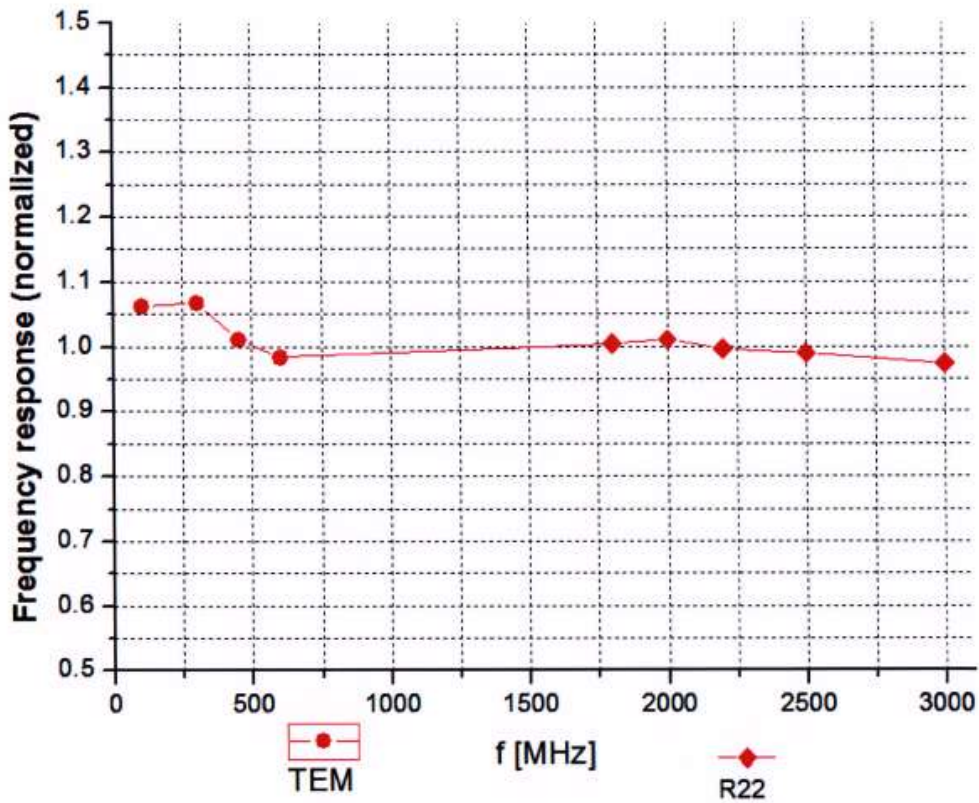

Uncertainty of Frequency Response of E-field:  $\pm 7.4\%$  (k=2)



Add: No.51 Xueyuan Road, Haidian District, Beijing, 100191, China  
 Tel: +86-10-62304633-2218 Fax: +86-10-62304633-2209  
 E-mail: cttl@chinattl.com [Http://www.chinattl.cn](http://www.chinattl.cn)

### Receiving Pattern ( $\Phi$ ), $\theta=0^\circ$

**f=600 MHz, TEM**

**f=1800 MHz, R22**

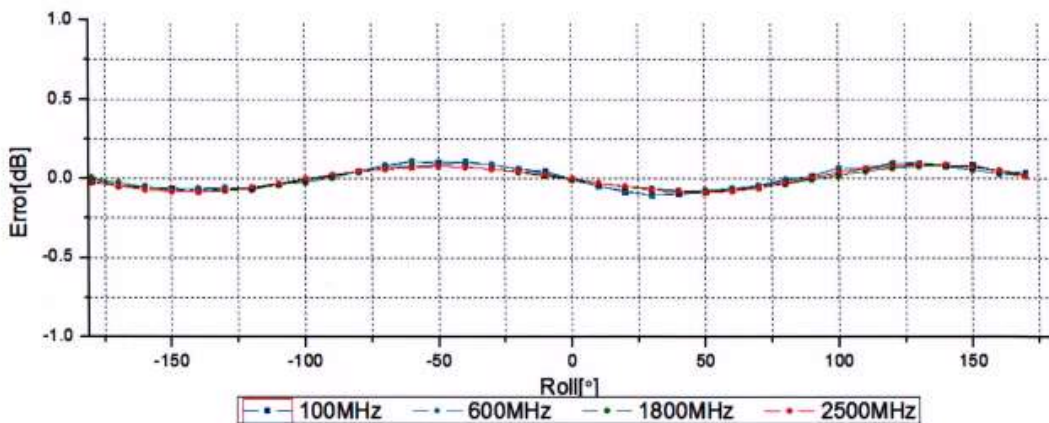
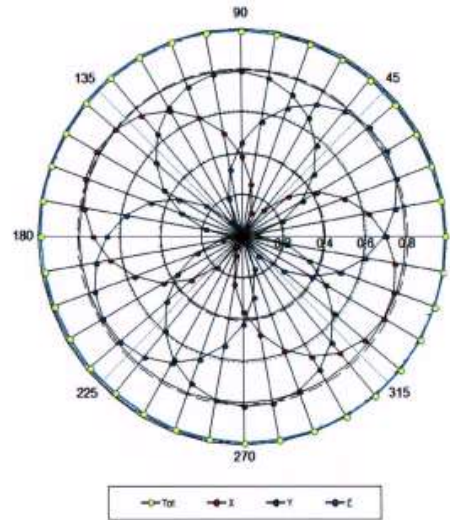
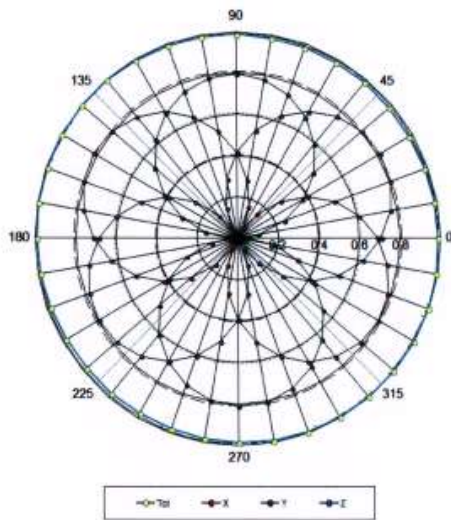

**Uncertainty of Axial Isotropy Assessment:  $\pm 1.2\%$  (k=2)**





Add: No.51 Xueyuan Road, Haidian District, Beijing, 100191, China  
 Tel: +86-10-62304633-2218 Fax: +86-10-62304633-2209  
 E-mail: cttl@chinattl.com [Http://www.chinattl.cn](http://www.chinattl.cn)

### Dynamic Range f(SAR<sub>head</sub>) (TEM cell, f = 900 MHz)

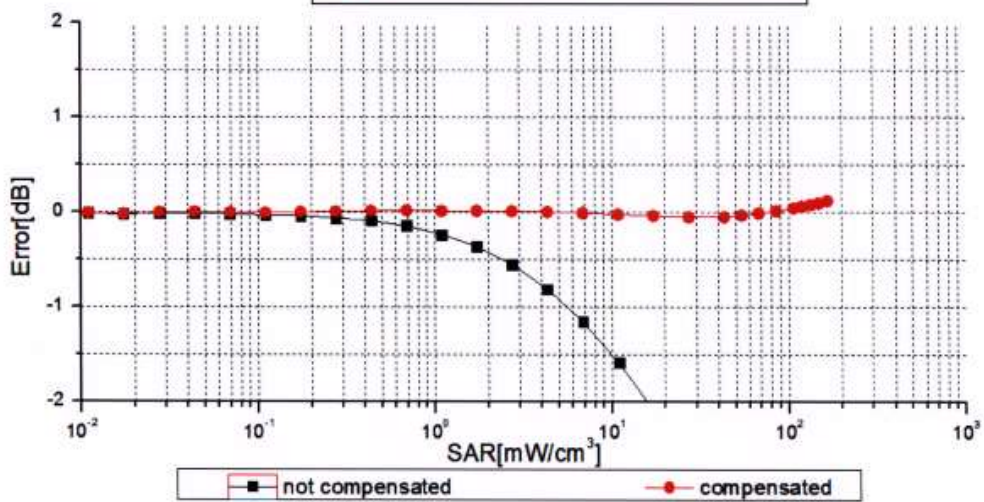
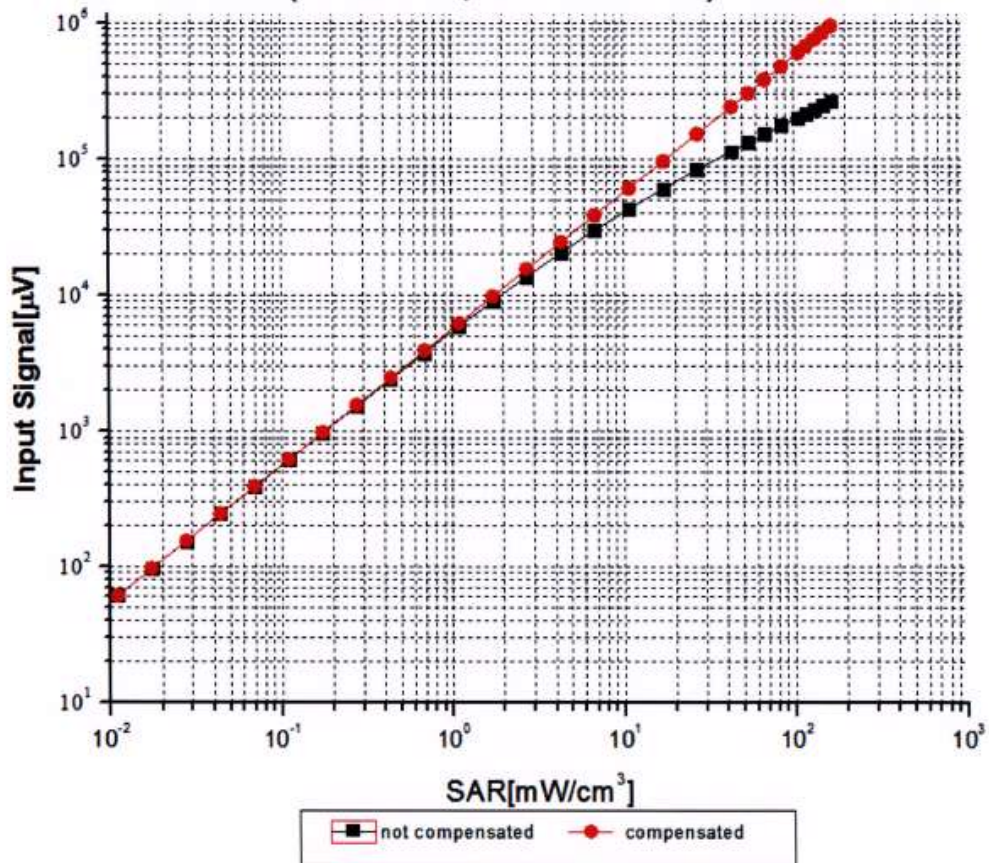

Uncertainty of Linearity Assessment: ±0.9% (k=2)



Add: No.51 Xueyuan Road, Haidian District, Beijing, 100191, China  
 Tel: +86-10-62304633-2218 Fax: +86-10-62304633-2209  
 E-mail: cttl@chinattl.com [Http://www.chinattl.cn](http://www.chinattl.cn)

### Conversion Factor Assessment

f=900 MHz, WGLS R9(H\_convF)

f=1750 MHz, WGLS R22(H\_convF)

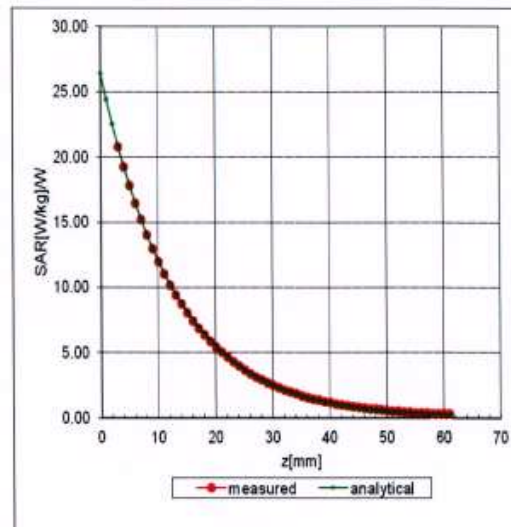
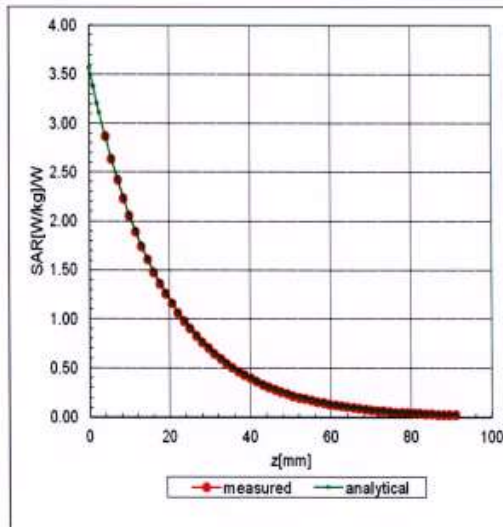

### Deviation from Isotropy in Liquid

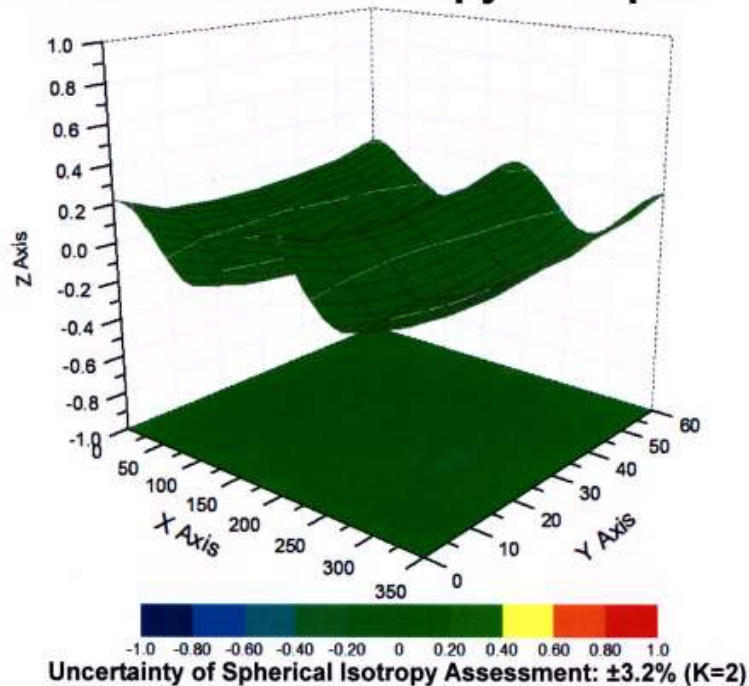



Add: No.51 Xueyuan Road, Haidian District, Beijing, 100191, China  
Tel: +86-10-62304633-2218 Fax: +86-10-62304633-2209  
E-mail: [cttl@chinattl.com](mailto:cttl@chinattl.com) [Http://www.chinattl.cn](http://www.chinattl.cn)

## DASY/EASY – Parameters of Probe: EX3DV4 – SN: 3661

### Other Probe Parameters

<b>Sensor Arrangement</b>	<b>Triangular</b>
<b>Connector Angle (°)</b>	<b>129.5</b>
<b>Mechanical Surface Detection Mode</b>	<b>enabled</b>
<b>Optical Surface Detection Mode</b>	<b>disable</b>
<b>Probe Overall Length</b>	<b>337mm</b>
<b>Probe Body Diameter</b>	<b>10mm</b>
<b>Tip Length</b>	<b>9mm</b>
<b>Tip Diameter</b>	<b>2.5mm</b>
<b>Probe Tip to Sensor X Calibration Point</b>	<b>1mm</b>
<b>Probe Tip to Sensor Y Calibration Point</b>	<b>1mm</b>
<b>Probe Tip to Sensor Z Calibration Point</b>	<b>1mm</b>
<b>Recommended Measurement Distance from Surface</b>	<b>1.4mm</b>



## Appendix D. Dipole Calibration Data

**Calibration Laboratory of  
Schmid & Partner  
Engineering AG**  
Zeughausstrasse 43, 8004 Zurich, Switzerland



**S** Schweizerischer Kalibrierdienst  
**C** Service suisse d'étalonnage  
**S** Servizio svizzero di taratura  
**S** Swiss Calibration Service

Accredited by the Swiss Accreditation Service (SAS)  
The Swiss Accreditation Service is one of the signatories to the EA  
Multilateral Agreement for the recognition of calibration certificates

Accreditation No.: **SCS 0108**

Client **QTK-CN (Auden)**

Certificate No: **D2450V2-839\_Feb16**

### CALIBRATION CERTIFICATE

Object **D2450V2 - SN: 839**

Calibration procedure(s) **QA CAL-05.v9  
Calibration procedure for dipole validation kits above 700 MHz**



Calibration date: **February 09, 2016**

This calibration certificate documents the traceability to national standards, which realize the physical units of measurements (SI).  
The measurements and the uncertainties with confidence probability are given on the following pages and are part of the certificate.

All calibrations have been conducted in the closed laboratory facility: environment temperature (22 ± 3)°C and humidity < 70%.

Calibration Equipment used (M&TE critical for calibration)

Primary Standards	ID #	Cal Date (Certificate No.)	Scheduled Calibration
Power meter EPM-442A	GB37480704	07-Oct-15 (No. 217-02222)	Oct-16
Power sensor HP 8481A	US37292783	07-Oct-15 (No. 217-02222)	Oct-16
Power sensor HP 8481A	MY41092317	07-Oct-15 (No. 217-02223)	Oct-16
Reference 20 dB Attenuator	SN: 5058 (20k)	01-Apr-15 (No. 217-02131)	Mar-16
Type-N mismatch combination	SN: 5047.2 / 06327	01-Apr-15 (No. 217-02134)	Mar-16
Reference Probe EX3DV4	SN: 7349	31-Dec-15 (No. EX3-7349_Dec15)	Dec-16
DAE4	SN: 601	30-Dec-15 (No. DAE4-601_Dec15)	Dec-16
Secondary Standards	ID #	Check Date (in house)	Scheduled Check
RF generator R&S SMT-06	100972	15-Jun-15 (in house check Jun-15)	In house check: Jun-18
Network Analyzer HP 8753E	US37390585 S4206	18-Oct-01 (in house check Oct-15)	In house check: Oct-16

	Name	Function	Signature
Calibrated by:	Michael Weber	Laboratory Technician	
Approved by:	Katja Pokovic	Technical Manager	
			Issued: February 10, 2016

This calibration certificate shall not be reproduced except in full without written approval of the laboratory.

**Calibration Laboratory of  
Schmid & Partner  
Engineering AG**  
Zeughausstrasse 43, 8004 Zurich, Switzerland



**S** Schweizerischer Kalibrierdienst  
**S** Service suisse d'étalonnage  
**C** Servizio svizzero di taratura  
**S** Swiss Calibration Service

Accredited by the Swiss Accreditation Service (SAS)  
The Swiss Accreditation Service is one of the signatories to the EA  
Multilateral Agreement for the recognition of calibration certificates

Accreditation No.: **SCS 0108**

**Glossary:**

TSL tissue simulating liquid  
ConvF sensitivity in TSL / NORM x,y,z  
N/A not applicable or not measured

**Calibration is Performed According to the Following Standards:**

- a) IEEE Std 1528-2013, "IEEE Recommended Practice for Determining the Peak Spatial-Averaged Specific Absorption Rate (SAR) in the Human Head from Wireless Communications Devices: Measurement Techniques", June 2013
- b) IEC 62209-1, "Procedure to measure the Specific Absorption Rate (SAR) for hand-held devices used in close proximity to the ear (frequency range of 300 MHz to 3 GHz)", February 2005
- c) IEC 62209-2, "Procedure to determine the Specific Absorption Rate (SAR) for wireless communication devices used in close proximity to the human body (frequency range of 30 MHz to 6 GHz)", March 2010
- d) KDB 865664, "SAR Measurement Requirements for 100 MHz to 6 GHz"

**Additional Documentation:**

- e) DASY4/5 System Handbook

**Methods Applied and Interpretation of Parameters:**

- *Measurement Conditions:* Further details are available from the Validation Report at the end of the certificate. All figures stated in the certificate are valid at the frequency indicated.
- *Antenna Parameters with TSL:* The dipole is mounted with the spacer to position its feed point exactly below the center marking of the flat phantom section, with the arms oriented parallel to the body axis.
- *Feed Point Impedance and Return Loss:* These parameters are measured with the dipole positioned under the liquid filled phantom. The impedance stated is transformed from the measurement at the SMA connector to the feed point. The Return Loss ensures low reflected power. No uncertainty required.
- *Electrical Delay:* One-way delay between the SMA connector and the antenna feed point. No uncertainty required.
- *SAR measured:* SAR measured at the stated antenna input power.
- *SAR normalized:* SAR as measured, normalized to an input power of 1 W at the antenna connector.
- *SAR for nominal TSL parameters:* The measured TSL parameters are used to calculate the nominal SAR result.

The reported uncertainty of measurement is stated as the standard uncertainty of measurement multiplied by the coverage factor  $k=2$ , which for a normal distribution corresponds to a coverage probability of approximately 95%.

### Measurement Conditions

DASY system configuration, as far as not given on page 1.

DASY Version	DASY5	V52.8.8
Extrapolation	Advanced Extrapolation	
Phantom	Modular Flat Phantom	
Distance Dipole Center - TSL	10 mm	with Spacer
Zoom Scan Resolution	dx, dy, dz = 5 mm	
Frequency	2450 MHz $\pm$ 1 MHz	

### Head TSL parameters

The following parameters and calculations were applied.

	Temperature	Permittivity	Conductivity
Nominal Head TSL parameters	22.0 °C	39.2	1.80 mho/m
Measured Head TSL parameters	(22.0 $\pm$ 0.2) °C	38.7 $\pm$ 6 %	1.84 mho/m $\pm$ 6 %
Head TSL temperature change during test	< 0.5 °C	----	----

### SAR result with Head TSL

SAR averaged over 1 cm <sup>3</sup> (1 g) of Head TSL	Condition	
SAR measured	250 mW input power	13.0 W/kg
SAR for nominal Head TSL parameters	normalized to 1W	<b>51.3 W/kg <math>\pm</math> 17.0 % (k=2)</b>

SAR averaged over 10 cm <sup>3</sup> (10 g) of Head TSL	condition	
SAR measured	250 mW input power	6.03 W/kg
SAR for nominal Head TSL parameters	normalized to 1W	<b>23.9 W/kg <math>\pm</math> 16.5 % (k=2)</b>

### Body TSL parameters

The following parameters and calculations were applied.

	Temperature	Permittivity	Conductivity
Nominal Body TSL parameters	22.0 °C	52.7	1.95 mho/m
Measured Body TSL parameters	(22.0 $\pm$ 0.2) °C	52.9 $\pm$ 6 %	2.00 mho/m $\pm$ 6 %
Body TSL temperature change during test	< 0.5 °C	----	----

### SAR result with Body TSL

SAR averaged over 1 cm <sup>3</sup> (1 g) of Body TSL	Condition	
SAR measured	250 mW input power	12.6 W/kg
SAR for nominal Body TSL parameters	normalized to 1W	<b>49.8 W/kg <math>\pm</math> 17.0 % (k=2)</b>

SAR averaged over 10 cm <sup>3</sup> (10 g) of Body TSL	condition	
SAR measured	250 mW input power	5.87 W/kg
SAR for nominal Body TSL parameters	normalized to 1W	<b>23.3 W/kg <math>\pm</math> 16.5 % (k=2)</b>

## Appendix (Additional assessments outside the scope of SCS 0108)

### Antenna Parameters with Head TSL

Impedance, transformed to feed point	55.4 $\Omega$ + 2.0 j $\Omega$
Return Loss	- 25.2 dB

### Antenna Parameters with Body TSL

Impedance, transformed to feed point	50.2 $\Omega$ + 6.4 j $\Omega$
Return Loss	- 23.9 dB

### General Antenna Parameters and Design

Electrical Delay (one direction)	1.143 ns
----------------------------------	----------

After long term use with 100W radiated power, only a slight warming of the dipole near the feedpoint can be measured.

The dipole is made of standard semirigid coaxial cable. The center conductor of the feeding line is directly connected to the second arm of the dipole. The antenna is therefore short-circuited for DC-signals. On some of the dipoles, small end caps are added to the dipole arms in order to improve matching when loaded according to the position as explained in the "Measurement Conditions" paragraph. The SAR data are not affected by this change. The overall dipole length is still according to the Standard.

No excessive force must be applied to the dipole arms, because they might bend or the soldered connections near the feedpoint may be damaged.

### Additional EUT Data

Manufactured by	SPEAG
Manufactured on	July 20, 2009



**DASY5 Validation Report for Head TSL**

Date: 08.02.2016

Test Laboratory: SPEAG, Zurich, Switzerland

**DUT: Dipole 2450 MHz; Type: D2450V2; Serial: D2450V2 - SN: 839**

Communication System: UID 0 - CW; Frequency: 2450 MHz

Medium parameters used:  $f = 2450$  MHz;  $\sigma = 1.84$  S/m;  $\epsilon_r = 38.7$ ;  $\rho = 1000$  kg/m<sup>3</sup>

Phantom section: Flat Section

Measurement Standard: DASY5 (IEEE/IEC/ANSI C63.19-2011)

DASY52 Configuration:

- Probe: EX3DV4 - SN7349; ConvF(7.76, 7.76, 7.76); Calibrated: 31.12.2015;
- Sensor-Surface: 1.4mm (Mechanical Surface Detection)
- Electronics: DAE4 Sn601; Calibrated: 30.12.2015
- Phantom: Flat Phantom 5.0 (front); Type: QD000P50AA; Serial: 1001
- DASY52 52.8.8(1258); SEMCAD X 14.6.10(7372)

**Dipole Calibration for Head Tissue/Pin=250 mW, d=10mm/Zoom Scan (7x7x7)/Cube 0:**

Measurement grid: dx=5mm, dy=5mm, dz=5mm

Reference Value = 113.0 V/m; Power Drift = 0.00 dB

Peak SAR (extrapolated) = 26.2 W/kg

**SAR(1 g) = 13 W/kg; SAR(10 g) = 6.03 W/kg**

Maximum value of SAR (measured) = 21.2 W/kg

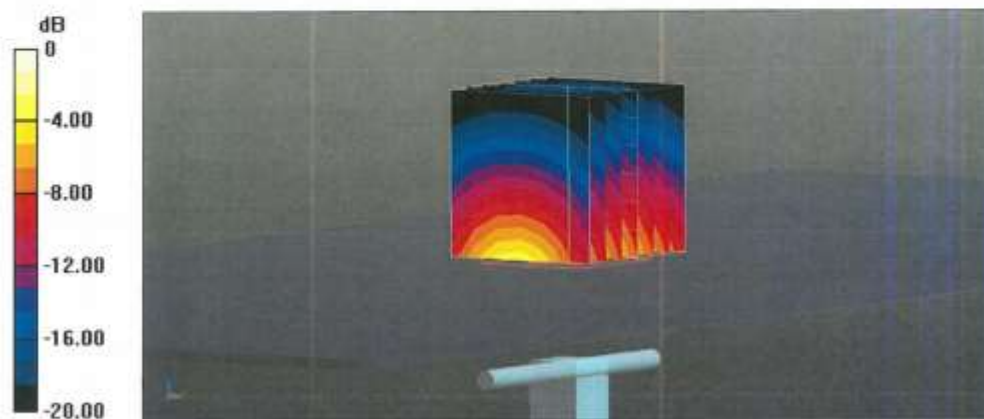

0 dB = 21.2 W/kg = 13.26 dBW/kg



### Impedance Measurement Plot for Head TSL

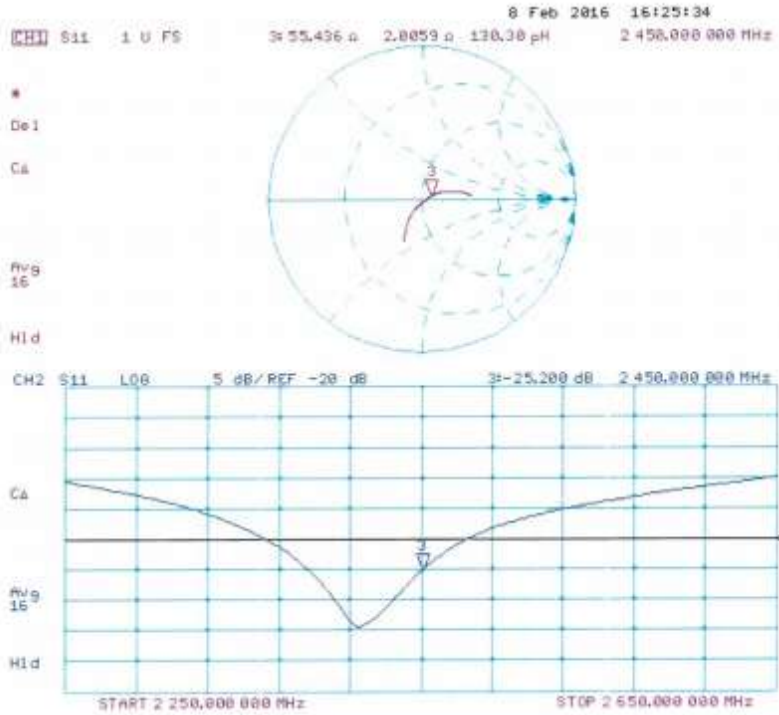

**DASY5 Validation Report for Body TSL**

Date: 09.02.2016

Test Laboratory: SPEAG, Zurich, Switzerland

**DUT: Dipole 2450 MHz; Type: D2450V2; Serial: D2450V2 - SN: 839**

Communication System: UID 0 - CW; Frequency: 2450 MHz

Medium parameters used:  $f = 2450$  MHz;  $\sigma = 2$  S/m;  $\epsilon_r = 52.9$ ;  $\rho = 1000$  kg/m<sup>3</sup>

Phantom section: Flat Section

Measurement Standard: DASY5 (IEEE/IEC/ANSI C63.19-2011)

DASY52 Configuration:

- Probe: EX3DV4 - SN7349; ConvF(7.79, 7.79, 7.79); Calibrated: 31.12.2015;
- Sensor-Surface: 1.4mm (Mechanical Surface Detection)
- Electronics: DAE4 Sn601; Calibrated: 30.12.2015
- Phantom: Flat Phantom 5.0 (back); Type: QD000P50AA; Serial: 1002
- DASY52 52.8.8(1258); SEMCAD X 14.6.10(7372)

**Dipole Calibration for Body Tissue/Pin=250 mW, d=10mm/Zoom Scan (7x7x7)/Cube 0:**

Measurement grid: dx=5mm, dy=5mm, dz=5mm

Reference Value = 105.1 V/m; Power Drift = 0.02 dB

Peak SAR (extrapolated) = 25.0 W/kg

**SAR(1 g) = 12.6 W/kg; SAR(10 g) = 5.87 W/kg**

Maximum value of SAR (measured) = 20.4 W/kg

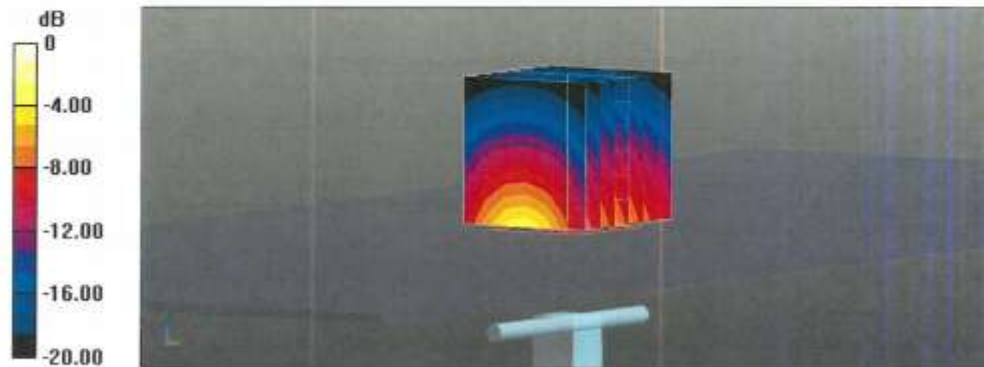

0 dB = 20.4 W/kg = 13.10 dBW/kg

### Impedance Measurement Plot for Body TSL

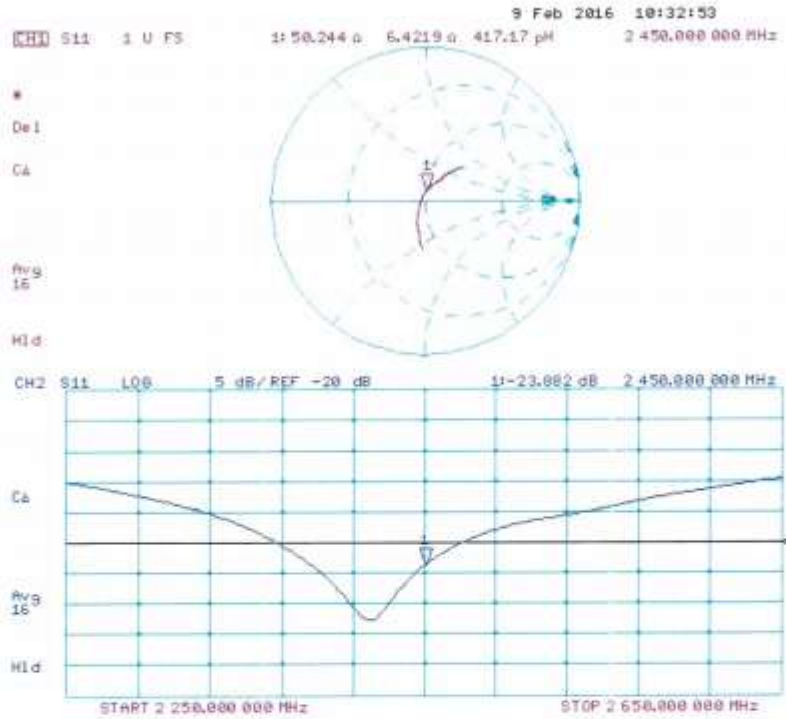

## Appendix E. DAE Calibration Data

**Calibration Laboratory of  
Schmid & Partner  
Engineering AG**  
Zeughausstrasse 43, 8004 Zurich, Switzerland



**S** Schweizerischer Kalibrierdienst  
**C** Service suisse d'étalonnage  
**S** Servizio svizzero di taratura  
**S** Swiss Calibration Service

Accredited by the Swiss Accreditation Service (SAS)  
The Swiss Accreditation Service is one of the signatories to the EA  
Multilateral Agreement for the recognition of calibration certificates

Accreditation No.: **SCS 0108**

Client **Auden**

Certificate No: **DAE4-905\_Jun17**

### CALIBRATION CERTIFICATE

Object **DAE4 - SD 000 D04 BK - SN: 905**

Calibration procedure(s) **QA CAL-06.v29  
Calibration procedure for the data acquisition electronics (DAE)**



Calibration date: **June 20, 2017**

This calibration certificate documents the traceability to national standards, which realize the physical units of measurements (SI).  
The measurements and the uncertainties with confidence probability are given on the following pages and are part of the certificate.

All calibrations have been conducted in the closed laboratory facility: environment temperature (22 ± 3)°C and humidity < 70%.

Calibration Equipment used (M&TE critical for calibration)

Primary Standards	ID #	Cal Date (Certificate No.)	Scheduled Calibration
Keithley Multimeter Type 2001	SN: 0810278	09-Sep-16 (No:19065)	Sep-17
Secondary Standards	ID #	Check Date (in house)	Scheduled Check
Auto DAE Calibration Unit	SE UWS 053 AA 1001	05-Jan-17 (in house check)	In house check: Jan-18
Calibrator Box V2.1	SE UMS 006 AA 1002	05-Jan-17 (in house check)	In house check: Jan-18

Calibrated by:	Name <b>Adrian Gehring</b>	Function <b>Technician</b>	Signature 
Approved by:	Name <b>Fin Bomholt</b>	Function <b>Deputy Technical Manager</b>	Signature 

Issued: June 20, 2017

This calibration certificate shall not be reproduced except in full without written approval of the laboratory.

**Calibration Laboratory of  
Schmid & Partner  
Engineering AG**  
Zeughausstrasse 43, 8004 Zurich, Switzerland



**S** Schweizerischer Kalibrierdienst  
**C** Service suisse d'étalonnage  
**S** Servizio svizzero di taratura  
**S** Swiss Calibration Service

Accredited by the Swiss Accreditation Service (SAS)  
The Swiss Accreditation Service is one of the signatories to the EA  
Multilateral Agreement for the recognition of calibration certificates

Accreditation No.: **SCS 0108**

### Glossary

DAE data acquisition electronics  
Connector angle information used in DASY system to align probe sensor X to the robot coordinate system.

### Methods Applied and Interpretation of Parameters

- *DC Voltage Measurement*: Calibration Factor assessed for use in DASY system by comparison with a calibrated instrument traceable to national standards. The figure given corresponds to the full scale range of the voltmeter in the respective range.
- *Connector angle*: The angle of the connector is assessed measuring the angle mechanically by a tool inserted. Uncertainty is not required.
- The following parameters as documented in the Appendix contain technical information as a result from the performance test and require no uncertainty.
  - *DC Voltage Measurement Linearity*: Verification of the Linearity at +10% and -10% of the nominal calibration voltage. Influence of offset voltage is included in this measurement.
  - *Common mode sensitivity*: Influence of a positive or negative common mode voltage on the differential measurement.
  - *Channel separation*: Influence of a voltage on the neighbor channels not subject to an input voltage.
  - *AD Converter Values with inputs shorted*: Values on the internal AD converter corresponding to zero input voltage
  - *Input Offset Measurement*: Output voltage and statistical results over a large number of zero voltage measurements.
  - *Input Offset Current*: Typical value for information; Maximum channel input offset current, not considering the input resistance.
  - *Input resistance*: Typical value for information: DAE input resistance at the connector, during internal auto-zeroing and during measurement.
  - *Low Battery Alarm Voltage*: Typical value for information. Below this voltage, a battery alarm signal is generated.
  - *Power consumption*: Typical value for information. Supply currents in various operating modes.

**DC Voltage Measurement**

A/D - Converter Resolution nominal

High Range: 1LSB = 6.1µV, full range = -100...+300 mV  
 Low Range: 1LSB = 61nV, full range = -1.....+3mV

DASY measurement parameters: Auto Zero Time: 3 sec; Measuring time: 3 sec

Calibration Factors	X	Y	Z
High Range	404.721 ± 0.02% (k=2)	405.268 ± 0.02% (k=2)	404.851 ± 0.02% (k=2)
Low Range	3.98068 ± 1.50% (k=2)	4.00246 ± 1.50% (k=2)	3.99754 ± 1.50% (k=2)

**Connector Angle**

Connector Angle to be used in DASY system	354.5 ° ± 1 °
---	---------------



**Appendix (Additional assessments outside the scope of SCS0108)**

**1. DC Voltage Linearity**

High Range	Reading ( $\mu\text{V}$ )	Difference ( $\mu\text{V}$ )	Error (%)
Channel X + Input	199996.25	-0.60	-0.00
Channel X + Input	20001.67	0.52	0.00
Channel X - Input	-19998.88	2.53	-0.01
Channel Y + Input	199996.33	-0.75	-0.00
Channel Y + Input	19998.79	-2.45	-0.01
Channel Y - Input	-20002.09	-0.62	0.00
Channel Z + Input	199995.15	-1.57	-0.00
Channel Z + Input	19996.71	-4.45	-0.02
Channel Z - Input	-20001.98	-0.37	0.00

Low Range	Reading ( $\mu\text{V}$ )	Difference ( $\mu\text{V}$ )	Error (%)
Channel X + Input	2000.79	0.11	0.01
Channel X + Input	201.36	0.33	0.17
Channel X - Input	-198.42	0.41	-0.20
Channel Y + Input	2000.79	-0.01	-0.00
Channel Y + Input	200.91	-0.27	-0.13
Channel Y - Input	-199.35	-0.63	0.32
Channel Z + Input	2001.00	0.33	0.02
Channel Z + Input	199.44	-1.66	-0.83
Channel Z - Input	-199.14	-0.37	0.19

**2. Common mode sensitivity**

DASY measurement parameters: Auto Zero Time: 3 sec; Measuring time: 3 sec

	Common mode Input Voltage (mV)	High Range Average Reading ( $\mu\text{V}$ )	Low Range Average Reading ( $\mu\text{V}$ )
Channel X	200	9.41	7.73
	- 200	-6.56	-8.41
Channel Y	200	8.46	8.23
	- 200	-9.72	-9.42
Channel Z	200	1.58	1.34
	- 200	-2.91	-3.32

**3. Channel separation**

DASY measurement parameters: Auto Zero Time: 3 sec; Measuring time: 3 sec

	Input Voltage (mV)	Channel X ( $\mu\text{V}$ )	Channel Y ( $\mu\text{V}$ )	Channel Z ( $\mu\text{V}$ )
Channel X	200	-	5.63	-1.36
Channel Y	200	9.50	-	7.28
Channel Z	200	9.85	6.92	-

**4. AD-Converter Values with inputs shorted**

DASY measurement parameters: Auto Zero Time: 3 sec; Measuring time: 3 sec

	High Range (LSB)	Low Range (LSB)
Channel X	15903	17398
Channel Y	16151	16064
Channel Z	16372	16417

**5. Input Offset Measurement**

DASY measurement parameters: Auto Zero Time: 3 sec; Measuring time: 3 sec  
Input 10MΩ

	Average (μV)	min. Offset (μV)	max. Offset (μV)	Std. Deviation (μV)
Channel X	1.16	0.21	1.96	0.29
Channel Y	-0.77	-1.64	-0.02	0.31
Channel Z	-0.55	-3.10	1.08	0.51

**6. Input Offset Current**

Nominal Input circuitry offset current on all channels: <25fA

**7. Input Resistance** (Typical values for information)

	Zeroing (kOhm)	Measuring (MOhm)
Channel X	200	200
Channel Y	200	200
Channel Z	200	200

**8. Low Battery Alarm Voltage** (Typical values for information)

Typical values	Alarm Level (VDC)
Supply (+ Vcc)	+7.9
Supply (- Vcc)	-7.6

**9. Power Consumption** (Typical values for information)

Typical values	Switched off (mA)	Stand by (mA)	Transmitting (mA)
Supply (+ Vcc)	+0.01	+6	+14
Supply (- Vcc)	-0.01	-8	-9