



TEST REPORT

No. I23N01197-NFC

for

Shanghai Sunmi Technology Co., Ltd.

Wireless data POS System

Model Name: T5711

with

Hardware Version: Bgf6d

Software Version: SP6610A_V003_20230409_sunmi_CS

FCC ID: 2AH25V3MIX

ISED Number: 22621-V3MIX

Issued Date: 2023-08-01

Designation Number: CN1210

Note:

The test results in this test report relate only to the devices specified in this report. This report shall not be reproduced except in full without the written approval of SAICT.

Test Laboratory:

Shenzhen Academy of Information and Communications Technology

Building G, Shenzhen International Innovation Center, No.1006 Shennan Road, Futian District, Shenzhen, Guangdong, P. R. China 518000.

Tel: +86(0)755-33322000, Fax: +86(0)755-33322001

Email: yewu@caict.ac.cn, www.saict.ac.cn

©Copyright. All rights reserved by SAICT.



REPORT HISTORY

Report Number	Revision	Description	Issue Date
I23N01197-NFC	Rev.0	1st edition	2023-08-01

Note: the latest revision of the test report supersedes all previous versions.

CONTENTS

1. Summary of Test Report.....	4
1.1. TEST ITEMS.....	4
1.2. TEST STANDARDS	4
1.3. TEST RESULT	4
1.4. TESTING LOCATION	4
1.5. PROJECT DATA	4
1.6. SIGNATURE	4
2. Client Information	5
2.1. APPLICANT INFORMATION.....	5
2.2. MANUFACTURER INFORMATION	5
3. Equipment Under Test (EUT) and Ancillary Equipment (AE)	6
3.1. ABOUT EUT	6
3.2. INTERNAL IDENTIFICATION OF EUT USED DURING THE TEST	6
3.3. INTERNAL IDENTIFICATION OF AE USED DURING THE TEST.....	6
3.4. GENERAL DESCRIPTION.....	6
3.5. EUT SET-UPS.....	7
4. Reference Documents	8
4.1. DOCUMENTS SUPPLIED BY APPLICANT	8
4.2. REFERENCE DOCUMENTS FOR TESTING.....	8
5. Test Results	9
5.1. TESTING ENVIRONMENT.....	9
5.2. TEST RESULTS	9
5.3. STATEMENTS.....	9
6. Test Equipments Utilized.....	10
7. Laboratory Environment	11
8. Measurement Uncertainty	12
ANNEX A: MEASUREMENT RESULTS	13
A.1. ELECTRIC FIELD STRENGTH OF FUNDAMENTAL AND OUTSIDE THE ALLOCATED BANDS.....	13
A.2. ELECTRIC FIELD RADIATED EMISSIONS (<30MHz)	15
A.3. ELECTRIC FIELD RADIATED EMISSIONS (≥30MHz)	17
A.4. FREQUENCY TOLERANCE.....	19
A.5. 20DB BANDWIDTH.....	21
A.6. CONDUCTED EMISSION	23
A.7. OCCUPIED BANDWIDTH.....	27



1. Summary of Test Report

1.1. Test Items

Description	Wireless data POS System
Model Name	T5711
Applicant's name	Shanghai Sunmi Technology Co., Ltd.
Manufacturer's Name	Shanghai Sunmi Technology Co., Ltd.

1.2. Test Standards

FCC Part15-2021; ANSI C63.4-2014; RSS-210 Issue 10; RSS-Gen Issue 5

1.3. Test Result

Pass

Please refer to 5.2 Test Results.

1.4. Testing Location

Address: Building G, Shenzhen International Innovation Center, No.1006 Shennan Road, Futian District, Shenzhen, Guangdong, P. R. China 518000

1.5. Project data

Testing Start Date:	2023-06-05
Testing End Date:	2023-06-05

1.6. Signature

Lin Kanfeng
(Prepared this test report)

An Ran
(Reviewed this test report)

Zhang Bojun
(Approved this test report)



2. Client Information

2.1. Applicant Information

Company Name: Shanghai Sunmi Technology Co., Ltd.
Address/Post: Room 505, No.388, Song Hu Road, Yang Pu District, Shanghai,
China
Contact: Fang Lu
Email: fang.lu@sunmi.com
Tel.: +86 18501703215
Fax: /

2.2. Manufacturer Information

Company Name: Shanghai Sunmi Technology Co., Ltd.
Address/Post: Room 505, No.388, Song Hu Road, Yang Pu District, Shanghai,
China
Contact: Fang Lu
Email: fang.lu@sunmi.com
Tel.: +86 18501703215
Fax: /



3. Equipment Under Test (EUT) and Ancillary Equipment (AE)

3.1. About EUT

Description	Wireless data POS System
Model Name	T5711
Frequency	13.56MHz
Equipment type	Near Field Communication (NFC)
Type of Modulation	ASK
Antenna type	Integrated antenna
Extreme Temperature	0°C/+45°C
Operation Voltage	6.8VDC to 8VDC (nominal: 7.2VDC)
Power source	Battery
FCC ID	2AH25V3MIX
ISED Number	22621-V3MIX

Condition of EUT as received No abnormality in appearance

Note: Components list, please refer to documents of the manufacturer; it is also included in the original test record of Shenzhen Academy of Information and Communications Technology.

3.2. Internal Identification of EUT used during the test

EUT ID*	SN or IMEI	HW Version	SW Version	Date of Receipt
UT01aa	868189060008663	Bgf6d	SP6610A_V003_20230409 _sunmi_CS	2023-05-16
UT07aa	865506060003027	Bgf6d	SP6610A_V003_20230409 _sunmi_CS	2023-05-30

*EUT ID: is used to identify the test sample in the lab internally.

*UT01aa is used for Conduction test; UT07aa is used for radiation test.

3.3. Internal Identification of AE used during the test

AE ID*	Description	SN
AE1	Power Supply	/
AE2	NFC Card	/

*AE ID: is used to identify the test sample in the lab internally.

3.4. General Description

Equipment under Test (EUT) is a model of Wireless data POS System with integrated antenna and battery. It consists of normal options: Lithium Battery and Charger. Manual and specifications of the EUT were provided to fulfil the test. Samples undergoing test were selected by the client.



3.5. EUT Set-ups

EUT Set-up No.	Combination of EUT and AE	Remarks
Set. NFC01	EUT1+AE1+AE2	NFC RF, TX test
Set. NFC02	EUT1+AE1	NFC RF, RX test

CE_test.apk is installed in the EUT which helps to control the NFC signal transmitting.

The Transmit State of NFC: the NFC function is on. The EUT will transmit the NFC data and command continuously during the test.

The Transmit State without modulation: The EUT will transmit the CW signal at the operating frequency.



4. Reference Documents

4.1. Documents supplied by applicant

EUT feature information is supplied by the applicant or manufacturer, which is the basis of testing.

4.2. Reference Documents for testing

The following documents listed in this section are referred for testing.

Reference	Title	Version
CFR 47 Part 15	FCC CFR 47, Part 15, Subpart C	2021
ANSI C63.4	American National Standard for Methods of Measurement of Radio-Noise Emissions from Low-Voltage Electrical and Electronic Equipment in the Range of 9 kHz to 40 GHz.	2014
RSS-210	License-exempt Radio Apparatus (All Frequency Bands): Category I Equipment Annex 2 - Devices Operating in Frequency Bands for Any Application	Issue 10 2020, A1
RSS-Gen	Spectrum Management and Telecommunications Radio Standards Specification General Requirements for Compliance of Radio Apparatus	Issue 5 2021, A2

5. Test Results

5.1. Testing Environment

Normal Temperature: 15~35°C

Relative Humidity: 20~75%

5.2. Test Results

No	Test Cases	Sub-clause of Part 15C	Sub-clause of IC	Verdict
1	Electric Field Strength of Fundamental and Outside the Allocated bands	15.225 (a) 15.225 (b) 15.225 (c)	RSS-210 A2.6	P
2	Electric Field Radiated Emissions	15.209,15.225 (d)	RSS-210 A2.6	P
3	Frequency Tolerance	15.225 (e)	RSS-210 A2.6	P
4	20dB Bandwidth	15.215 (c)	/	P
5	Conducted Emissions	15.207	RSS-Gen 8.8	P
6	Occupied Bandwidth	/	RSS-Gen 6.6	P

The measurement is carried out according to ANSI C63.10 and ANSI C63.4.

See **ANNEX A** for details.

5.3. Statements

The test cases listed in Section 5.2 of this report for the EUT specified in Section 3 were performed by SAICT according to the reference documents in Section 4. The EUT meets all applicable requirements of the regulations and standards in Section 4.2. This report only deals with the NFC function among the features described in section 3.

Disclaimer:

A. After confirmation with the customer, the sample information provided by the customer may affect the validity of the measurement results in this report, and the impact and consequences arising therefrom shall be borne by the customer.

B. The samples in this report are provided by the customer, and the test results are only applicable to the samples received.

6. Test Equipments Utilized

Conducted test system

No.	Equipment	Model	Serial Number	Manufacturer	Calibration Due date	Calibration Period
1	Vector Signal Analyzer	FSV40	100903	Rohde & Schwarz	2023-12-28	1 year
2	DC Power Supply	NGSM	5425	Rohde & Schwarz	2023-11-06	1 year
3	Shielding Room	S81	CT000986-1 344	ETS-Lindgren	2026-09-12	5 years

Climate chamber

No.	Equipment	Model	Serial Number	Manufacturer	Calibration Due date	Calibration Period
1	Climate chamber	SU-242	93008165	ESPEC	2024-03-12	1 year

Radiated emission test system

No.	Equipment	Model	Serial Number	Manufacturer	Calibration Due date	Calibration Period
1	Test Receiver	ESR7	101676	Rohde & Schwarz	2023-11-23	1 year
2	BiLog Antenna	3142E	0224831	ETS-lindgren	2024-05-27	3 years
3	Anechoic Chamber	FACT3-2.0	1285	ETS-Lindgren	2025-05-28	2 years
4	Loop Antenna	HLA6120	35779	TESEQ	2025-05-12	3 years
5	Test Receiver	ESCI	100702	Rohde & Schwarz	2024-01-11	1 year
6	LISN	ENV216	102067	Rohde & Schwarz	2024-07-13	1 year
7	Software	EMC32	10.50.40	Rohde & Schwarz	/	/

7. Laboratory Environment

Shielded room

Temperature	Min. = 15 °C, Max. = 35 °C
Relative humidity	Min. = 20 %, Max. = 75 %
Shielding effectiveness	0.014MHz-1MHz> 60 dB; 1MHz-18000MHz>90 dB
Electrical insulation	> 2 MΩ
Ground system resistance	< 4 Ω

Anechoic chamber

Temperature	Min. = 15 °C, Max. = 35 °C
Relative humidity	Min. = 20 %, Max. = 75 %
Shielding effectiveness	0.014MHz-1MHz> 60 dB; 1MHz-18000MHz>90 dB
Electrical insulation	> 2 MΩ
Ground system resistance	< 4 Ω
Normalised site attenuation (NSA)	< ±4 dB, 3 m distance, from 30 to 1000 MHz
Voltage Standing Wave Ratio (VSWR)	≤ 6 dB, from 1 to 18 GHz, 3 m distance
Uniformity of field strength	Between 0 and 6 dB, from 80 to 6000 MHz



8. Measurement Uncertainty

Test Name	Uncertainty ($k=2$)
1. Electric Field Strength of Fundamental and Outside the Allocated bands	1.79dB
2. Electric Field Radiated Emissions (<30MHz)	1.79dB
3. Electric Field Radiated Emissions (≥ 30 MHz)	4.86dB
4. Frequency Tolerance	4.56kHz
5. 20dB Bandwidth	4.56kHz
6. Conducted emission	2.62dB

ANNEX A: MEASUREMENT RESULTS

A.1. Electric Field Strength of Fundamental and Outside the Allocated bands

A.1.1. Reference

See Clause 13.5, Clause 13.4, Clause 8, and Annex E of ANSI C63.4-2014 specifically

See Clause 4, Clause 5, and Clause 6 of ANSI C63.4-2014 generally

See CFR 47 § 15.225(a)

See RSS-210 A2.6

A.1.2. Measurement Methods

The transmitter carrier output levels (E-Field) from the EUT are measured in a semi-anechoic chamber. The EUT is placed on a non-conductive stand of 80cm high, and at a measurement distance of 3m from the receiving antenna. The center of the receiving loop antenna is 1.0 meter above the ground. The E-field is measured with a shielded loop antenna connected to a measurement receiver. Detected E-field was maximized by rotating the EUT through 360° and adjusting the receiving antenna polarizations. The maximization processes were repeated with the EUT positioned respectively in its three orthogonal axes. The measurements were performed with the peak detector and if required, the quasi-peak detector.

The measurement bandwidth is:

Frequency of Emission (MHz)	RBW/VBW
12.56-14.56	10/30 kHz

The E-field measured at 3m is calculated as:

$$\text{E-field (dB}\mu\text{V/m)} = \text{Rx (dB}\mu\text{V)} + \text{Cable Loss (dB)} + \text{AF@3m (dB/m)}$$

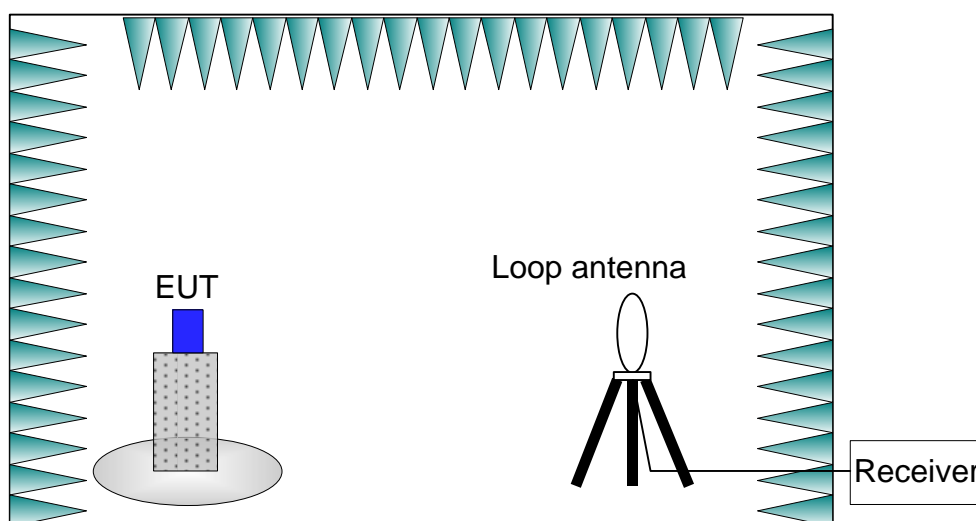

A.1.3. EUT Operating Mode and Test Conditions

The measurement of EUT is carried out under the transmit state of NFC (See 3.5).

The EUT is powered by a travel adapter.

During the measurements, the ambient temperature of the electromagnetic anechoic chamber is in the range of 15 ~ 25°C.

A.1.4. Limits

Frequency Range (MHz)	E-field Strength Limit @ 30 m (μV/m)	E-field Strength Limit @ 3 m (dBμV/m)
13.560 ± 0.007	+15,848	124
13.410 to 13.553 13.567 to 13.710	+334	90
13.110 to 13.410 13.710 to 14.010	+106	81

Note: Where the limits have been defined at one distance, and a signal level measured at another, the limits have been extrapolated using the following formula:
 Extrapolation (dB) = 40 * log₁₀(Measurement Distance / Specification Distance)

A.1.5. Measurement Results

Measurement results of normal conditions see Figure A-1 for different set-ups of EUT. The result displayed take into account applicable antenna factors and cable losses.

Conclusions: PASS

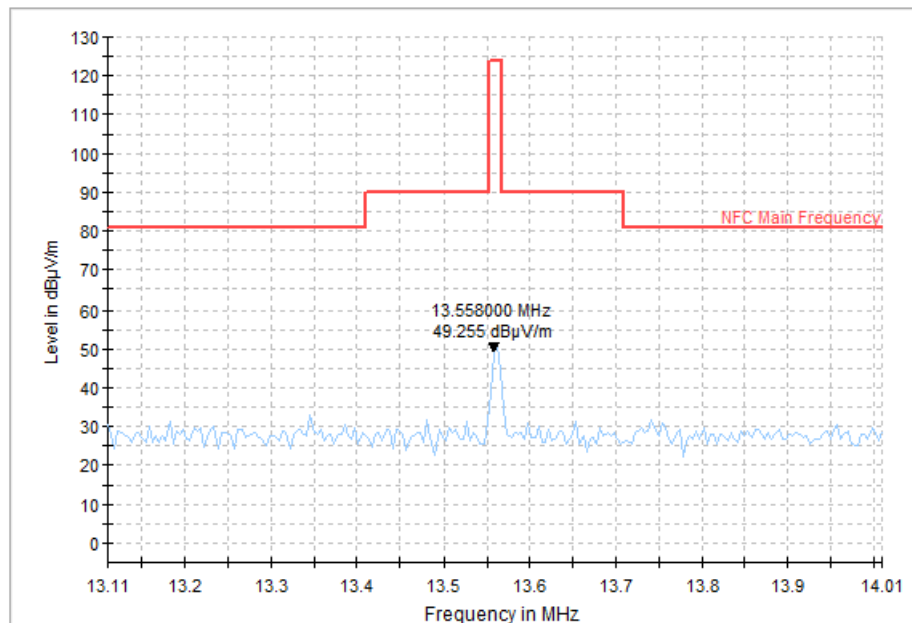

Figure A-1 Electric Field Strength

A.2. Electric Field Radiated Emissions (<30MHz)

A.2.1. Reference

See Clause 13.4, Clause 8 and Annex E of ANSI C63.4-2014 specifically
 See Clause 4, Clause 5, and Clause 6 of ANSI C63.4-2014 generally
 See CFR 47 § 15.225(b)
 See CFR 47 § 15.225(c)
 See RSS-210 A2.6

A.2.2. Measurement Methods

The transmitter carrier output levels (E-Field) from the EUT are measured in a semi-anechoic chamber. The EUT is placed on a non-conductive stand of 80cm high, and at a measurement distance of 3m from the receiving antenna. The center of the receiving loop antenna is 1.0 meter above the ground. The E-field is measured with a shielded loop antenna connected to a measurement receiver. Detected E-field was maximized by rotating the EUT through 360° and adjusting the receiving antenna polarizations. The maximization processes were repeated with the EUT positioned respectively in its three orthogonal axes. The measurements were performed with the peak detector and if required, the quasi-peak detector.

The measurement bandwidth is:

Frequency of Emission (MHz)	RBW/VBW
0.009-0.15	100/300 Hz
0.15-30	10/30 kHz

The E-field measured at 3m is calculated as:

$$\text{E-field (dB}\mu\text{V/m)} = \text{Rx (dB}\mu\text{V)} + \text{Cable Loss (dB)} + \text{AF@3m (dB/m)}$$

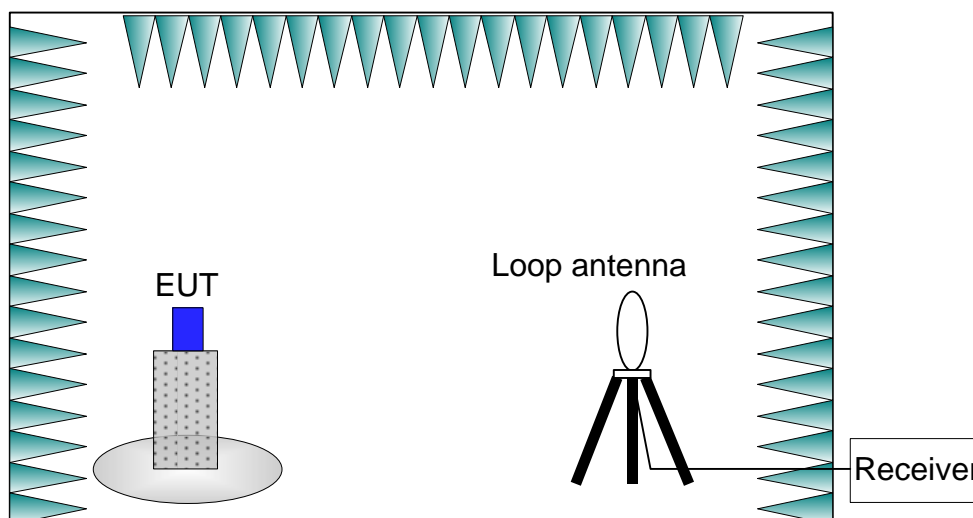

A.2.3. EUT Operating Mode and Test Conditions

The measurement of EUT is carried out under the transmit state of NFC (See 3.5).

The EUT is powered by a travel adapter.

During the measurements, the ambient temperature of the electromagnetic anechoic chamber is in the range of 15 ~ 25°C.

A.2.4. Limits

Frequency Range (MHz)	E-field Strength Limit @ 30m (mV/m)	E-field Strength Limit @ 3m (dBµV/m)
0.009-0.490	2400/F(kHz)	129-94
0.490-1.705	24000/F(kHz)	74-63
1.705-30	30	70

Note: Where the limits have been defined at one distance, and a signal level measured at another, the limits have been extrapolated using the following formula:
 Extrapolation (dB) = 40 * log₁₀(Measurement Distance / Specification Distance)

A.2.5. Measurement Results

Measurement results of normal conditions see Figure A-2 for different set-ups of EUT. The result displayed take into account applicable antenna factors and cable losses.

Conclusions: PASS

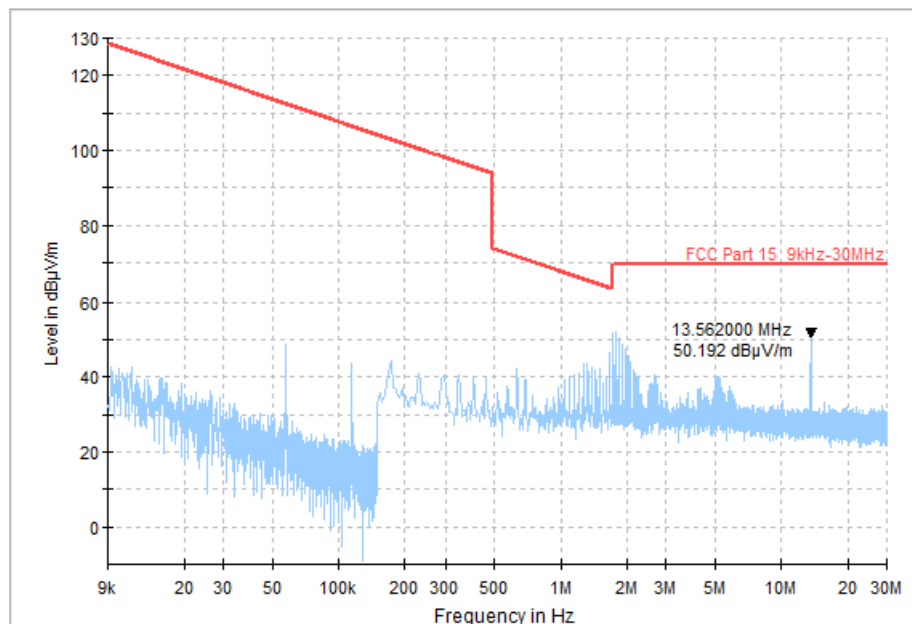

Figure A-2 Transmit State (9k-30M)

A.3. Electric Field Radiated Emissions ($\geq 30\text{MHz}$)

A.3.1. Reference

See Clause 13.4, Clause 8, and Annex E of ANSI C63.4-2014 specifically

See Clause 4, Clause 5, and Clause 6 of ANSI C63.4-2014 generally

See CFR 47 § 15.209

See CFR 47 § 15.225(d)

See RSS-210 A2.6

A.3.2. Measurement Methods

The electric field radiated emissions from the EUT are measured in a semi-anechoic chamber. The EUT is placed on a non-conductive stand of 80cm high, and at a measurement distance of 10m from the receiving antenna. The receiving antennas connected to a measurement receiver comply with Clause 15 of ANSI C63.2-1996 and Clause 4.1.5 of ANSI C63.4-2014. In order to search for maximum field strength emitted from the EUT, the receiving antenna can be moved between the height of 1.0 m to 4.0 m. Detected E-field was maximized at each frequency by rotating the EUT through 360° and adjusting the receiving antenna positions for both vertical and horizontal antenna polarizations. The maximization processes were repeated with the EUT positioned respectively in its three orthogonal axes. The measurements were performed with the peak detector and if required, the quasi-peak detector.

The measurement bandwidth is:

Frequency of Emission (MHz)	RBW/VBW
30-1000	120kHz

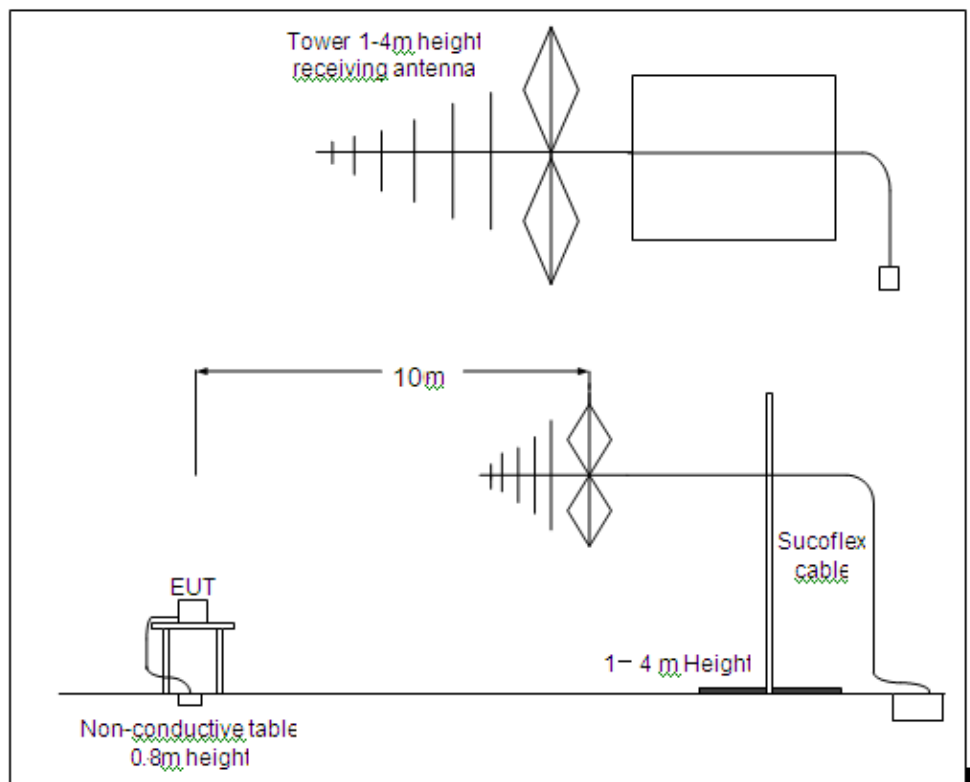

A.3.3. EUT Operating Mode and Test Conditions

The measurement of EUT is carried out under the transmit state of NFC (See 3.5).

EUT had been connected to a travel adapter.

During the measurements, the ambient temperature of the electromagnetic anechoic chamber is in the range of 15 ~ 25°C.

A.3.4. Limits

Frequency Range (MHz)	E-field Strength Limit @ 3m (mV/m)	E-field Strength Limit @ 3m (dB μ V/m)	E-field Strength Limit @ 10m (dB μ V/m)
30-88	100	40	30
88-216	150	43.5	33.5
216-960	200	46	36
960-1000	500	54	44

A.3.5. Measurement Results

Measurement results of normal conditions see Figure A-3 for different set-ups of EUT. The result displayed take into account applicable antenna factors and cable losses.

Conclusions: PASS

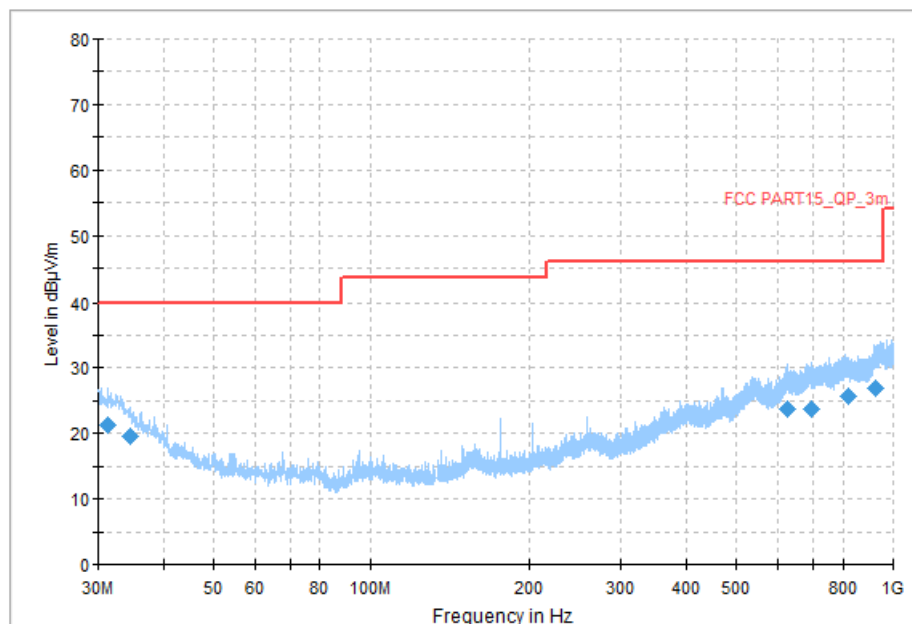

Figure A-3 Transmit State (30M-1G)

A.4. Frequency Tolerance

A.4.1. Reference

See Clause 13.6 of ANSI C63.4-2014 specifically

See Clause 4, Clause 5, and Clause 6 of ANSI C63.4-2014 generally

See CFR 47 § 15.225(e)

See RSS-210 A2.6

A.4.2. Measurement Methods

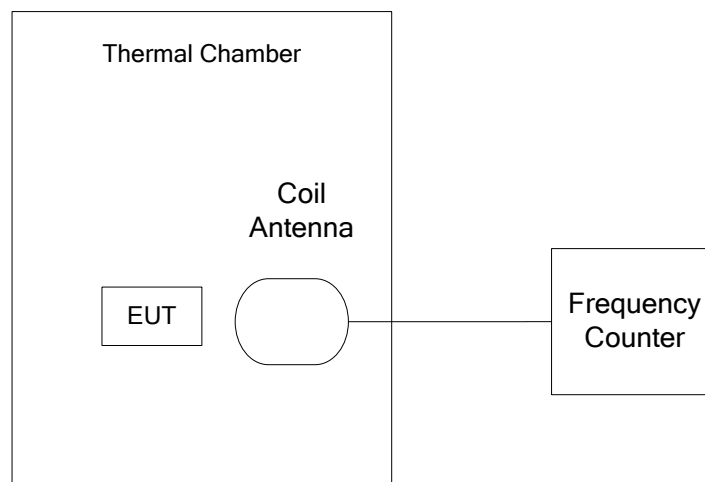

The transmitter output signal was picked up by coil antenna connected to the frequency counter. The center frequency was measured with 30Hz RBW and 1kHz span. During the test, the EUT was placed in a thermal chamber until thermal balance and lasting appropriate time.

A.4.3. EUT Operating Mode and Test Conditions

The measurement of EUT is carried out under the transmit state of without modulation (See 3.5).

EUT had been not connected to a travel adapter.

Operation Temperature: T min, T nom, and T max with V nom.

Operation Voltage: V min and V max with T nom.

A.4.4. Test Layouts

See A.4.2.

A.4.5. Limits

The frequency tolerance of the carrier signal shall be maintained within +/- 0.01% of the operating frequency.

A.4.6. Measurement Results

Measurement results see Table A-1 for different test conditions.

Conclusions: PASS.

**Table A-1: Frequency Stability VS Temperature and Voltage**

Temperature	Voltage	Frequency Error (MHz)			
		Startup	2 Min Later	5 Min Later	10 Min Later
T min	V nom	13.560000	13.560000	13.560000	13.560000
T max	V nom	13.560000	13.560000	13.560000	13.560000
T nom	V nom	13.560000	13.560000	13.560000	13.560000
T nom	V min	13.560000	13.560000	13.560000	13.560000
T nom	V max	13.560000	13.560000	13.560000	13.560000

Temperature	Voltage	Frequency Error (%)			
		Startup	2 Min Later	5 Min Later	10 Min Later
T min	V nom	0.000	0.000	0.000	0.000
T max	V nom	0.000	0.000	0.000	0.000
T nom	V nom	0.000	0.000	0.000	0.000
T nom	V min	0.000	0.000	0.000	0.000
T nom	V max	0.000	0.000	0.000	0.000

A.5. 20dB Bandwidth

A.5.1. Reference

See Clause 13.7 of ANSI C63.4-2014 specifically

See Clause 4, Clause 5, and Clause 6 of ANSI C63.4-2014 generally

See CFR 47 § 15.215(c)

A.5.2. Measurement Methods

The transmitter output signal was picked up by coil antenna to the spectrum analyzer.

The transmitter output signal was picked up by coil antenna connected to the spectrum analyzer.

The bandwidth of the center frequency was measured with 140Hz RBW, 420Hz VBW and 14kHz span.

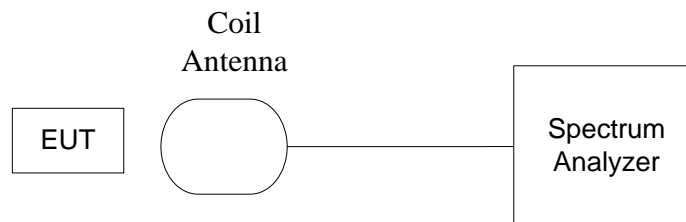

A.5.3. EUT Operating Mode and Test Conditions

The measurement of EUT is carried out under the transmit state of NFC and without modulation (See 3.5).

EUT had been not connected to a travel adapter.

During the measurements, the ambient temperature is in the range of 15 ~ 25°C.

A.5.4. Test Layouts

See A.5.2.

A.5.5. Limits

The 20dB bandwidth shall be less than 80% of the permitted frequency band. For 13.56 MHz NFC, the permitted frequency band is 14 kHz, so the limit is 11.2 kHz.

A.5.6. Measurement Results

Measurement results see Figure A-4.

Conclusions: PASS.

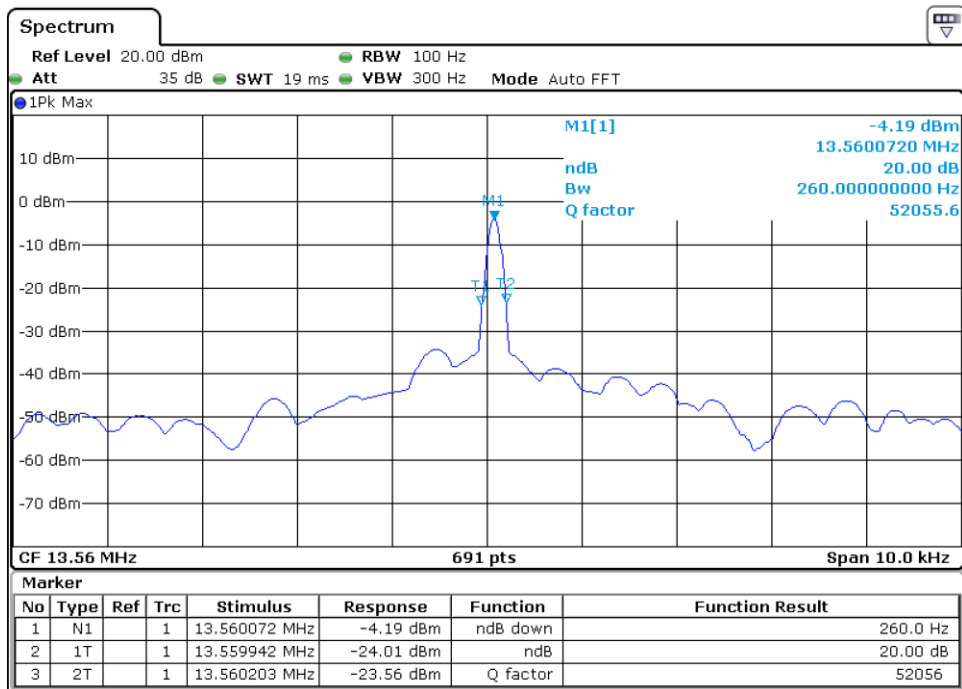

Figure A-4 20dB Bandwidth

A.6. Conducted emission

A.6.1. Reference

See Clause 13.3 and Clause 7 of ANSI C63.4-2014 specifically

See Clause 4, Clause 5, and Clause 6 of ANSI C63.4-2014 generally

See CFR 47 § 15.207

See RSS-Gen 8.8

A.6.2. Measurement Methods

The conducted emissions from the AC port of the EUT are measured in a shielding room. The EUT is connected to a Line Impedance Stabilization Network (LISN). An overview sweep with peak detection was performed. The measurements were performed with a quasi-peak detector and if required, an average detector.

The conducted emission measurements were made with the following detector of the test receiver:

Quasi-Peak / Average Detector.

The measurement bandwidth is:

Frequency of Emission (MHz)	RBW/VBW
0.15-30	9kHz

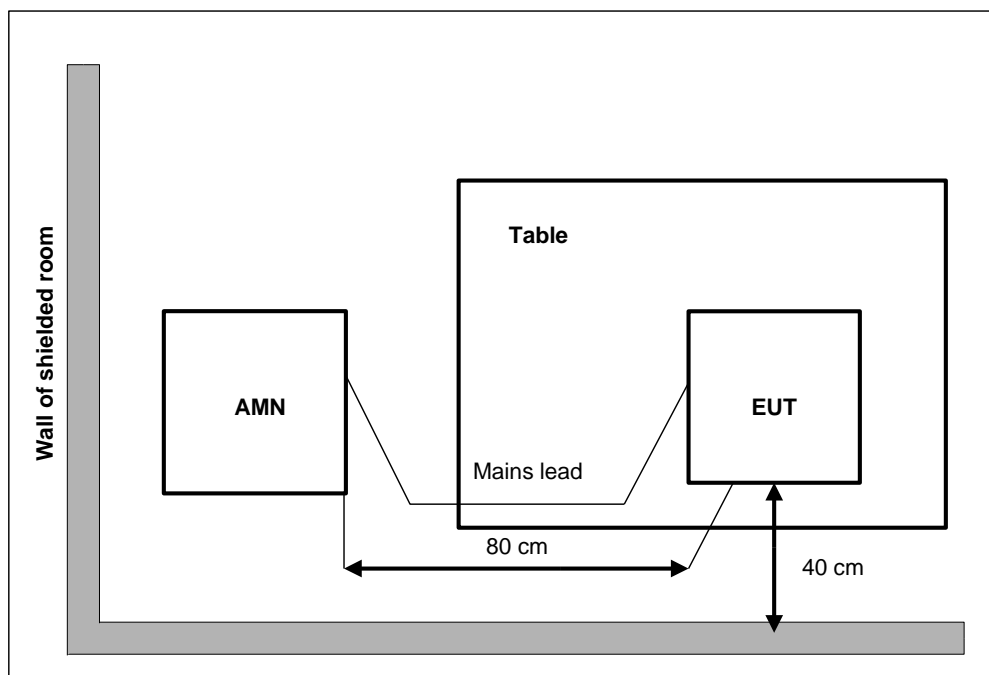

A.6.3. EUT Operating Mode and Test Conditions

The measurement of EUT is carried out under the transmit state of NFC (See 3.5).

The EUT is powered by a travel adapter.

During the measurements, the ambient temperature is in the range of 15 ~ 25°C.



A.6.4. Limits

Frequency range(MHz)	Quasi-peak Limit (dB μ V)	Average Limit (dB μ V)
0.15 to 0.5	66 to 56	56 to 46
0.5 to 5	56	46
5 to 30	60	50

A.6.5. Measurement Results

Measurement results see Figure A-5, Figure A-6.

Conclusions: PASS.

Note: The measurement result at 13.56MHz is the fundamental emission of NFC signal.

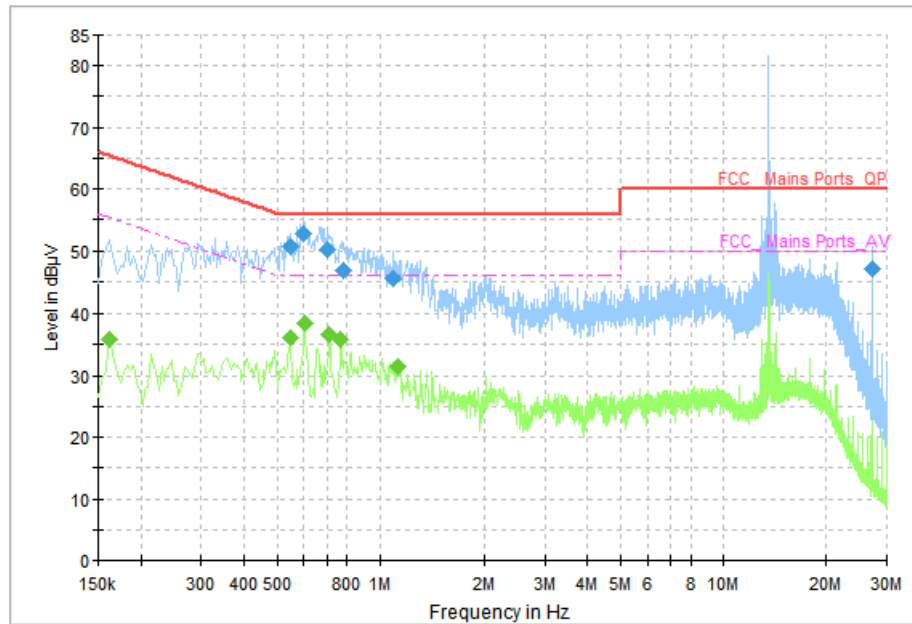

Figure A-5 Test result (Traffic)

Final Result 1

Frequency (MHz)	QuasiPeak (dBµV)	Limit (dBµV)	Margin (dB)	Line	Filter	Corr. (dB)
0.546000	50.77	56.00	5.23	L1	ON	10
0.598000	52.66	56.00	3.34	N	ON	10
0.702000	50.24	56.00	5.76	N	ON	10
0.782000	46.90	56.00	9.10	N	ON	10
1.098000	45.57	56.00	10.43	N	ON	10
27.118000	46.96	60.00	13.04	N	ON	11

Final Result 2

Frequency (MHz)	Average (dBµV)	Limit (dBµV)	Margin (dB)	Line	Filter	Corr. (dB)
0.162000	35.78	55.36	19.58	N	ON	10
0.546000	36.01	46.00	9.99	L1	ON	10
0.602000	38.43	46.00	7.57	N	ON	10
0.710000	36.64	46.00	9.36	N	ON	10
0.766000	35.99	46.00	10.01	N	ON	10
1.126000	31.56	46.00	14.44	N	ON	10

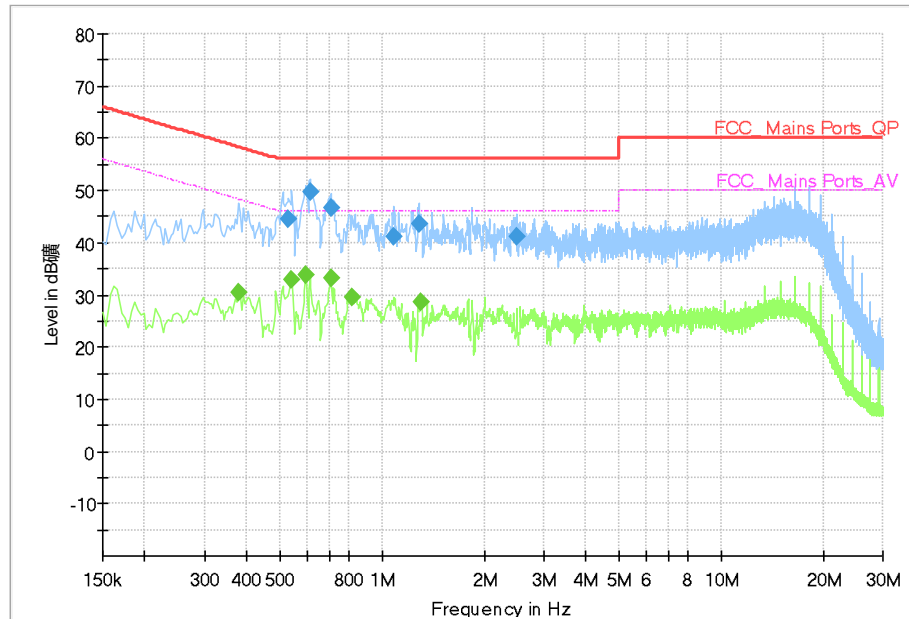

Figure A-6 Test result (Idle)

Final Result 1

Frequency (MHz)	QuasiPeak (dBμV)	Limit (dBμV)	Margin (dB)	Line	Filter	Corr. (dB)
0.530000	44.57	56.00	11.43	N	ON	10
0.614000	49.85	56.00	6.15	N	ON	10
0.706000	46.80	56.00	9.20	N	ON	10
1.086000	41.24	56.00	14.76	N	ON	10
1.282000	43.60	56.00	12.40	N	ON	10
2.502000	41.12	56.00	14.88	N	ON	10

Final Result 2

Frequency (MHz)	Average (dBμV)	Limit (dBμV)	Margin (dB)	Line	Filter	Corr. (dB)
0.378000	30.36	48.32	17.97	N	ON	10
0.542000	32.75	46.00	13.25	N	ON	10
0.598000	33.76	46.00	12.24	N	ON	10
0.706000	33.33	46.00	12.67	N	ON	10
0.814000	29.61	46.00	16.39	N	ON	10
1.306000	28.50	46.00	17.50	N	ON	10

A.6.6. Measurement Uncertainty

Measurement uncertainty: $U = 3.0$ dB, $k=2$

A.7. Occupied Bandwidth

A.7.1. Reference

See Clause 13.7 of ANSI C63.4-2014 specifically

See Clause 4, Clause 5, and Clause 6 of ANSI C63.4-2014 generally

See RSS-Gen 6.6

A.7.2. Measurement Methods

The transmitter output signal was picked up by coil antenna to the spectrum analyzer.

The transmitter output signal was picked up by coil antenna connected to the spectrum analyzer.

The bandwidth of the center frequency was measured with 140Hz RBW, 420Hz VBW and 14kHz span.

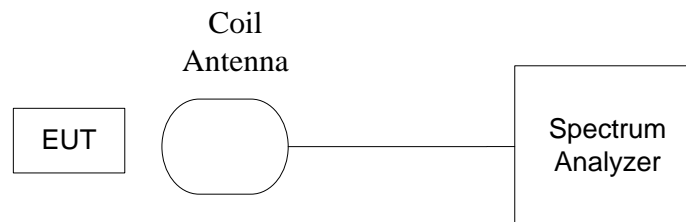

A.7.3. EUT Operating Mode and Test Conditions

The measurement of EUT is carried out under the transmit state of NFC and without modulation (See 3.5).

EUT had been not connected to a travel adapter.

During the measurements, the ambient temperature is in the range of 15 ~ 25°C.

A.7.4. Test Layouts

See A.7.2.

A.7.5. Limits

When the occupied bandwidth limit is not stated in the applicable RSS or reference measurement method, the transmitted signal bandwidth shall be reported as the 99% emission bandwidth, as calculated or measured.

A.7.6. Measurement Results

Measurement results see Figure A-7.

Conclusions: PASS

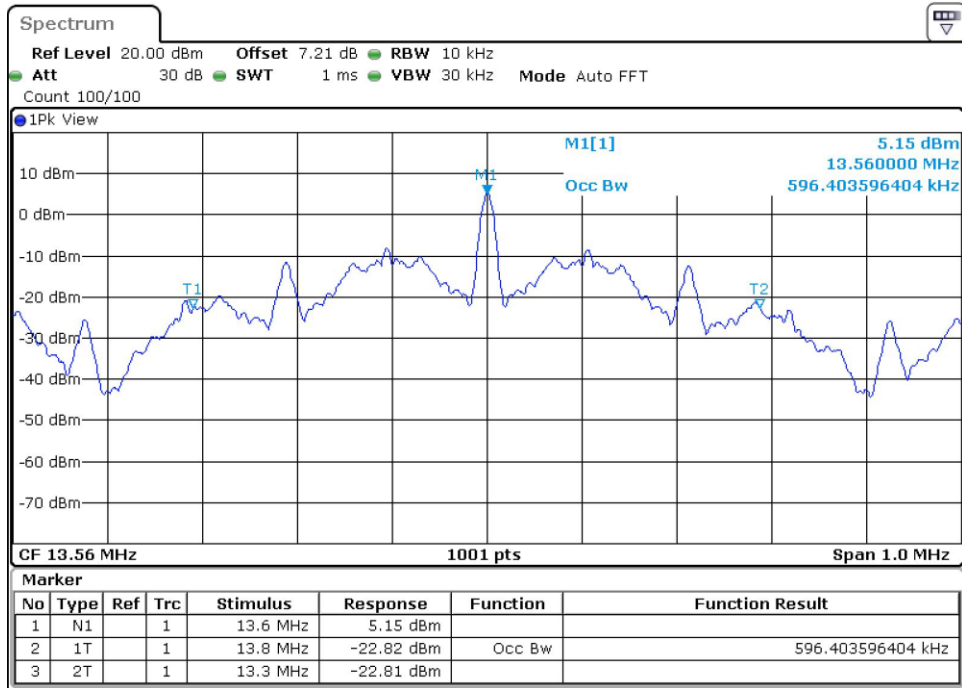

Figure A-7 Occupied Bandwidth

END OF REPORT