



# TEST REPORT

No. I23N01197-DFS

for

**Shanghai Sunmi Technology Co., Ltd.**

**Wireless data POS System**

**Model Name: T5711**

with

**Hardware Version: Bgf6d**

**Software Version: SP6610A\_V003\_20230409\_sunmi\_CS**

**FCC ID: 2AH25V3MIX**

**ISED Number: 22621-V3MIX**

**Issued Date: 2023-08-01**

**Designation Number: CN1210**

**Note:**

The test results in this test report relate only to the devices specified in this report. This report shall not be reproduced except in full without the written approval of SAICT.

**Test Laboratory:**

**Shenzhen Academy of Information and Communications Technology**

Building G, Shenzhen International Innovation Center, No.1006 Shennan Road, Futian District, Shenzhen, Guangdong, P. R. China 518000.

Tel: +86(0)755-33322000, Fax: +86(0)755-33322001

Email: yewu@caict.ac.cn, www.saict.ac.cn

©Copyright. All rights reserved by SAICT.



## **REPORT HISTORY**

<b>Report Number</b>	<b>Revision</b>	<b>Description</b>	<b>Issue Date</b>
I23N01197-DFS	Rev.0	1st edition	2023-08-01

Note: the latest revision of the test report supersedes all previous versions.



## **CONTENTS**

<b>1.</b>	<b>SUMMARY OF TEST REPORT.....</b>	<b>4</b>
1.1.	TEST ITEMS.....	4
1.2.	TEST STANDARDS .....	4
1.3.	TEST RESULT .....	4
1.4.	TESTING LOCATION .....	4
1.5.	PROJECT DATA .....	4
1.6.	SIGNATURE .....	4
<b>2.</b>	<b>CLIENT INFORMATION.....</b>	<b>5</b>
2.1.	APPLICANT INFORMATION.....	5
2.2.	MANUFACTURER INFORMATION .....	5
<b>3.</b>	<b>EQUIPMENT UNDER TEST (EUT) AND ANCILLARY EQUIPMENT(AE) .....</b>	<b>6</b>
3.1.	ABOUT EUT .....	6
3.2.	INTERNAL IDENTIFICATION OF EUT .....	6
3.3.	INTERNAL IDENTIFICATION OF AE.....	6
3.4.	GENERAL DESCRIPTION.....	6
<b>4.</b>	<b>REFERENCE DOCUMENTS .....</b>	<b>7</b>
4.1.	DOCUMENTS SUPPLIED BY APPLICANT .....	7
4.2.	REFERENCE DOCUMENTS FOR TESTING.....	7
<b>5.</b>	<b>TEST RESULTS.....</b>	<b>8</b>
5.1.	TESTING ENVIRONMENT.....	8
5.2.	TEST RESULTS .....	8
5.3.	STATEMENTS.....	8
<b>6.</b>	<b>TEST EQUIPMENTS UTILIZED .....</b>	<b>9</b>
<b>7.</b>	<b>LABORATORY ENVIRONMENT .....</b>	<b>10</b>
	<b>ANNEX A: MEASUREMENT RESULTS.....</b>	<b>11</b>
A.1.	PARAMETERS OF DFS TEST SIGNAL .....	11
A.2.	CHANNEL MOVE TIME AND CHANNEL CLOSING TRANSMISSION TIME .....	13
A.3.	NON-OCCUPANCY PERIOD .....	14
	<b>ANNEX B: DFS TEST SET-UP .....</b>	<b>15</b>



## 1. Summary of Test Report

### 1.1. Test Items

Description	Wireless data POS System
Model Name	T5711
Applicant's name	Shanghai Sunmi Technology Co., Ltd.
Manufacturer's Name	Shanghai Sunmi Technology Co., Ltd.

### 1.2. Test Standards

FCC Part15-2021; RSS-247 Issue 2; RSS-Gen Issue 5; KDB 905462-D02

### 1.3. Test Result

**Pass**

Please refer to 5.2 Test Results.

### 1.4. Testing Location

Address: Building G, Shenzhen International Innovation Center, No.1006 Shennan Road, Futian District, Shenzhen, Guangdong, P. R. China 518000

### 1.5. Project data

Testing Start Date:	2023-05-23
Testing End Date:	2023-06-15

### 1.6. Signature

---

Lin Kanfeng

(Prepared this test report)

---

An Ran

(Reviewed this test report)

---

Zhang Bojun

(Approved this test report)



## **2. Client Information**

### **2.1. Applicant Information**

Company Name: Shanghai Sunmi Technology Co., Ltd.  
Address: Room 505, No.388, Song Hu Road, Yang Pu District, Shanghai,  
China  
Contact Person Fang Lu  
E-Mail fang.lu@sunmi.com  
Telephone: +86 18501703215  
Fax: /

### **2.2. Manufacturer Information**

Company Name: Shanghai Sunmi Technology Co., Ltd.  
Address: Room 505, No.388, Song Hu Road, Yang Pu District, Shanghai,  
China  
Contact Person Fang Lu  
E-Mail fang.lu@sunmi.com  
Telephone: +86 18501703215  
Fax: /



### **3. Equipment Under Test (EUT) and Ancillary Equipment(AE)**

#### **3.1. About EUT**

Description	Wireless data POS System
Model name	T5711
WLAN Frequency Range	ISM Band: 5250MHz~5350MHz; 5470MHz~5725MHz
WLAN Protocol	IEEE 802.11a, 802.11n-HT20/40, 802.11ac-VHT20/40/80
Type of modulation	OFDM
Antenna	Integrated
Antenna Gain	5150MHz~5725MHz: 3.0 dBi; 5725MHz~5850MHz: 3.1 dBi
Power Supply	7.2V DC by Battery
FCC ID	2AH25V3MIX
ISED Number	22621-V3MIX
Device Type (DFS)	Client without radar detection (only support client mode)
TPC feature available	No
Condition of EUT as received	No abnormality in appearance

Note: Components list, please refer to documents of the manufacturer; it is also included in the original test record of Shenzhen Academy of Information and Communications Technology.

#### **3.2. Internal Identification of EUT**

EUT ID*	SN or IMEI	HW Version	SW Version	Date of Receipt
UT01aa	868189060008663	Bgf6d	SP6610A_V003_20230409 _sunmi_CS	2023-05-16

\*EUT ID: is used to identify the test sample in the lab internally.

#### **3.3. Internal Identification of AE**

AE No.	Description	AE ID*
AE1	Battery	/
AE2	Charger	/
AE3	Data Cable	/

\*AE ID: is used to identify the test sample in the lab internally.

#### **3.4. General Description**

The Equipment under Test (EUT) is a model of Wireless data POS System with integrated antenna and battery. It consists of normal options: Lithium Battery and Charger. Manual and specifications of the EUT were provided to fulfil the test. Samples undergoing test were selected by the client.

## **4. Reference Documents**

### **4.1. Documents supplied by applicant**

EUT feature information is supplied by the applicant or manufacturer, which is the basis of testing.

### **4.2. Reference Documents for testing**

The following documents listed in this section are referred for testing.

<b>Reference</b>	<b>Title</b>	<b>Version</b>
FCC Part15	Title 47 of the Code of Federal Regulations; Chapter I Part 15 - Radio frequency devices Subpart E - UNII Devices	2021
RSS-247	Spectrum Management and Telecommunications Radio Standards Specification Digital Transmission Systems (DTSS), Frequency Hopping Systems (FHSs) and License-Exempt Local Area Network (LE-LAN) Devices	Issue 2 February, 2017
RSS-Gen	Spectrum Management and Telecommunications Radio Standards Specification General Requirements for Compliance of Radio Apparatus	Issue 5 A2 February, 2021
KDB 905462	Compliance Measurement Procedures for Unlicensed-national Information Infrastructure Devices Operating in the 5250-5350 MHz and 5470-5725 MHz Bands Incorporating Dynamic Frequency Selection	D02

Note: This report is only for DFS.



## 5. Test Results

### 5.1. Testing Environment

Normal Temperature: 15~35°C

Relative Humidity: 20~75%

### 5.2. Test Results

No	Test cases	Sub-clause of Part15E	Verdict
1	Channel move time and channel closing transmission time	15.407 (h)(2)(iii)	P
2	Non-Occupancy Period	15.407 (h)(2) (iv)	P

Please refer to **ANNEX A** for detail.

### 5.3. Statements

SAICT has evaluated the test cases requested by the applicant/manufacture as listed in section 5.2 of this report, for the EUT specified in section 3, according to the standards or reference documents listed in section 4.2.

This report only deals with the UNII DFS functions among the features described in section 3, and The EUT met all requirements of the reference documents.

The end user is not available to get and modify the parameters of the detected Radar Waveforms in this product.

Disclaimer:

A. After confirmation with the customer, the sample information provided by the customer may affect the validity of the measurement results in this report, and the impact and consequences arising therefrom shall be borne by the customer.

B. The samples in this report are provided by the customer, and the test results are only applicable to the samples received.

According to the customer's description, T5711 (I23N01197) is a variant product of T6721 (I23N00836). All results were from the initial model.



## 6. Test Equipments Utilized

### Conducted test system

No.	Equipment	Model	Serial Number	Manufacturer	Calibration Due date	Calibration Period
1	Vector Signal Analyzer	FSV40	100903	Rohde & Schwarz	2023-12-28	1 year
2	Vector Signal General	SMU200A	104096	Rohde & Schwarz	2023-12-28	1 year
3	Shielding Room	S81	CT0009 86-1344	ETS-Lindgren	2026-09-12	5 years
No.	Equipment	Model	FCC ID	Manufacturer	Calibration Due date	Calibration Period
4	Master AP	BCM94709R	QDS-BR CM1091	BROADCOM	/	/

## 7. Laboratory Environment

Measurement is performed in shielding room.

### Shielded room

Temperature	Min. = 15 °C, Max. = 35 °C
Relative humidity	Min. = 20 %, Max. = 75 %
Shielding effectiveness	0.014 MHz - 1 MHz, > 60 dB; 1 MHz - 18000 MHz, > 90 dB.
Electrical insulation	> 2 M $\Omega$
Ground system resistance	< 4 $\Omega$

## **ANNEX A: MEASUREMENT RESULTS**

### **A.1. Parameters of DFS test signal**

1). Interference threshold values, master or client incorporation in service monitoring. For device Power less than 23 dBm (E.I.R.P.), the threshold level is -62 dBm at the antenna port after Correction for antenna gain and procedural adjustments.

Because of conducted measurement performed, the calibration power from radar signal generator to antenna port of DFS test equipment is -62 dBm.

<b>Maximum Transmit Power</b>	<b>Value</b>
> 200 mW	-64 dBm
< 200 mW	-62 dBm

2). DFS requirement values

The required values are as the following table.

<b>Parameter</b>	<b>Value</b>
Non-occupancy	> 1800 s
Channel Availability Check Time	60 s
Channel Move Time	10 s
Channel Closing Transmission Time	200 ms + 60 ms
U-NII Detection Bandwidth	Minimum 80% of the 99% transmission power bandwidth

As the EUT is IP based system, the MPEG video file from NTIA website is used to stream to EUT via the Master device.

3). Radar waveform

<b>Pulse width W (μs)</b>	<b>Pulse repetition frequency PRF (PPS)</b>	<b>Pulses per burst (PPB)</b>
1	700	18

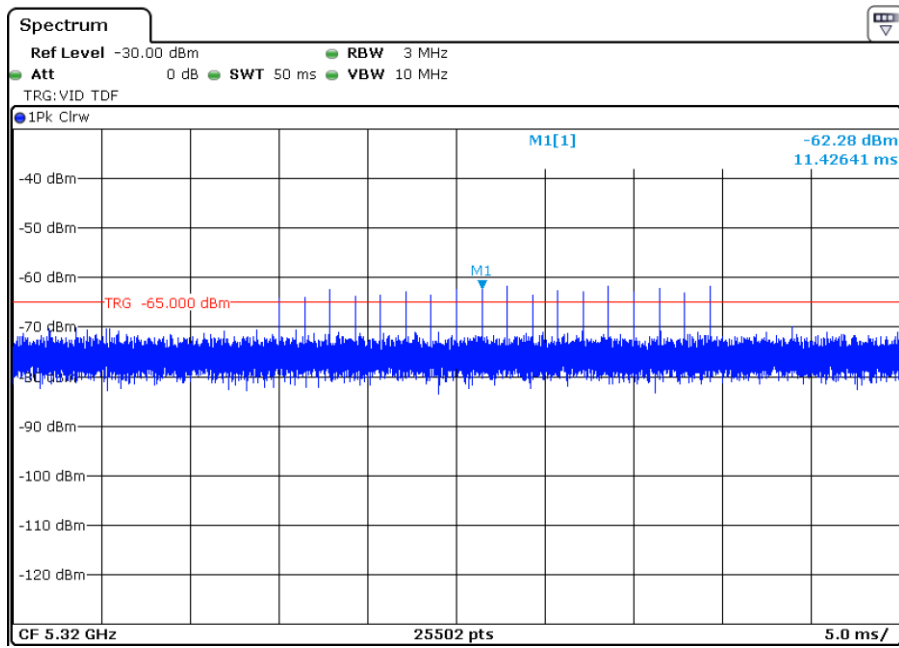

**Radar Signal (Type 0)**

4). Channel Loading

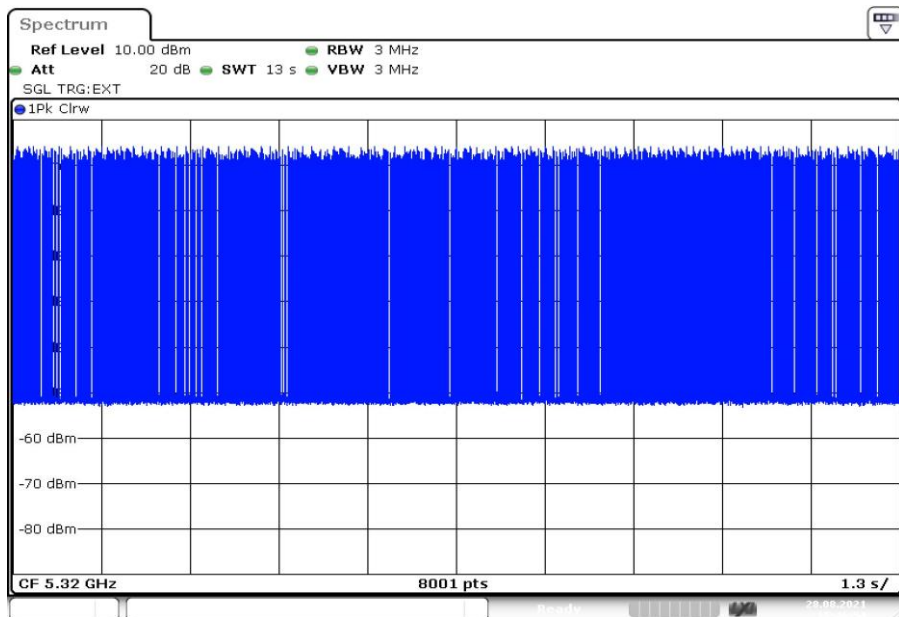

**Channel load timing plot**

The level of traffic loading on the channel by EUT is > 17%.

5). IP Based Systems

The channel loading data file will be transferred from the Master Device to the Client Device for all test configurations.

## A.2. Channel move time and channel closing transmission time

### Measurement Limit:

Test Items	Limit
channel closing transmission time	< 200 ms + 60 ms
Channel move time	< 10 s

### Measurement Results:

Mode	Channel	Test Results	Conclusion
802.11a	5320MHz (CH64)	Fig.1	P
802.11ac-VHT80	5530MHz (CH106)	Fig.2	P

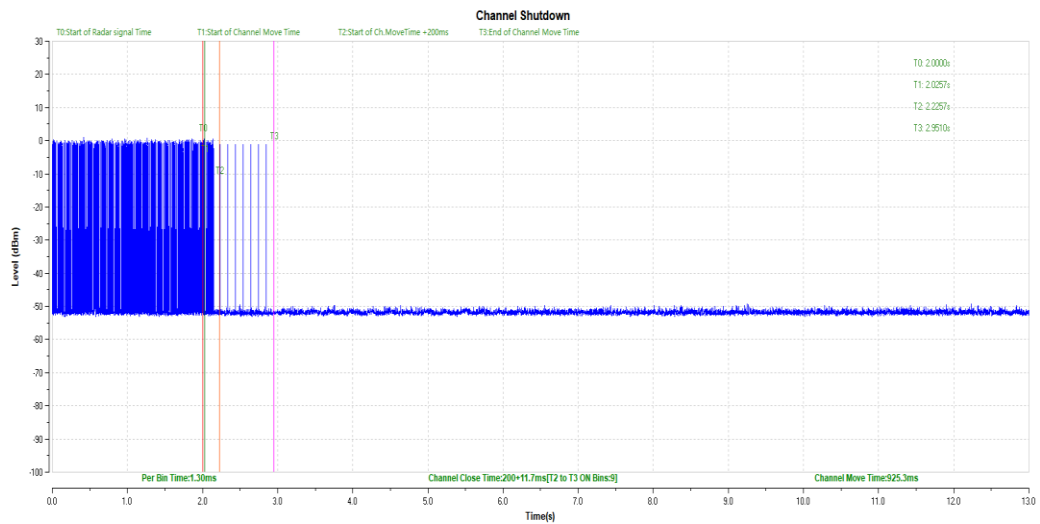

Fig.1 Channel Shutdown (HT20 Frequency Band: 5250MHz ~ 5350MHz)

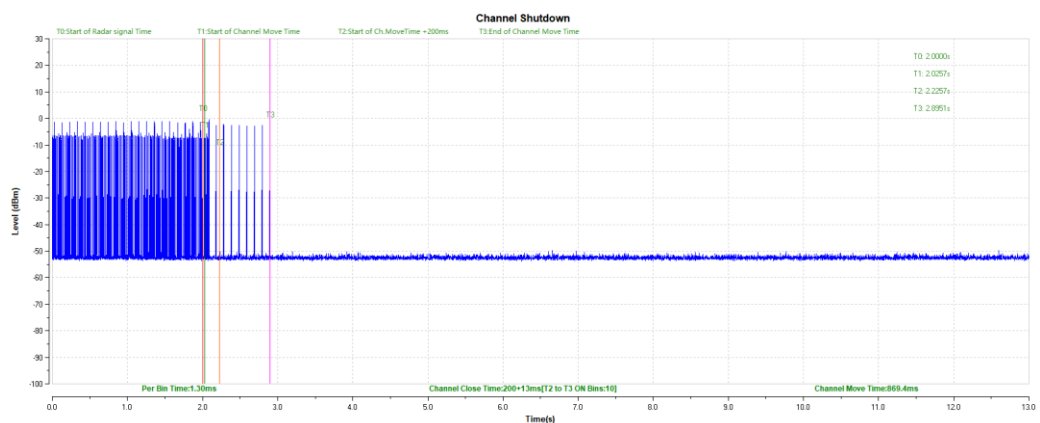

Fig.2 Channel Shutdown (VHT80 Frequency Band: 5470MHz ~ 5725MHz)

### A.3. Non-Occupancy Period

**Measurement Limit:**

Test Items	Limit
Non-Occupancy Period	> 1800 s

**Measurement Results:**

Mode	Channel	Test Results	Conclusion
802.11a	5320MHz (CH64)	Fig.3	P
802.11ac-VHT80	5530MHz (CH106)	Fig.4	P

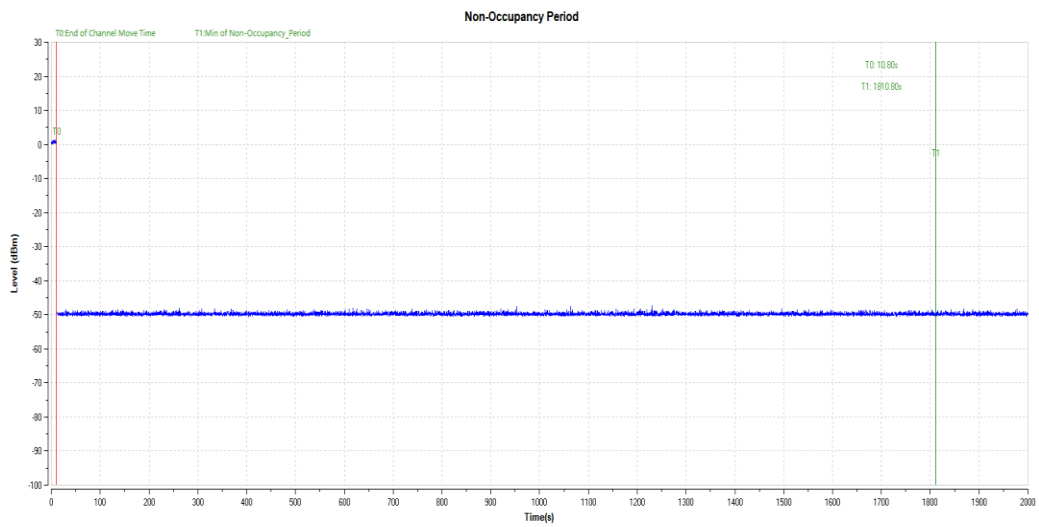

**Fig.3 Non-Occupancy Period (HT20 Frequency Band: 5250MHz ~ 5350MHz)**

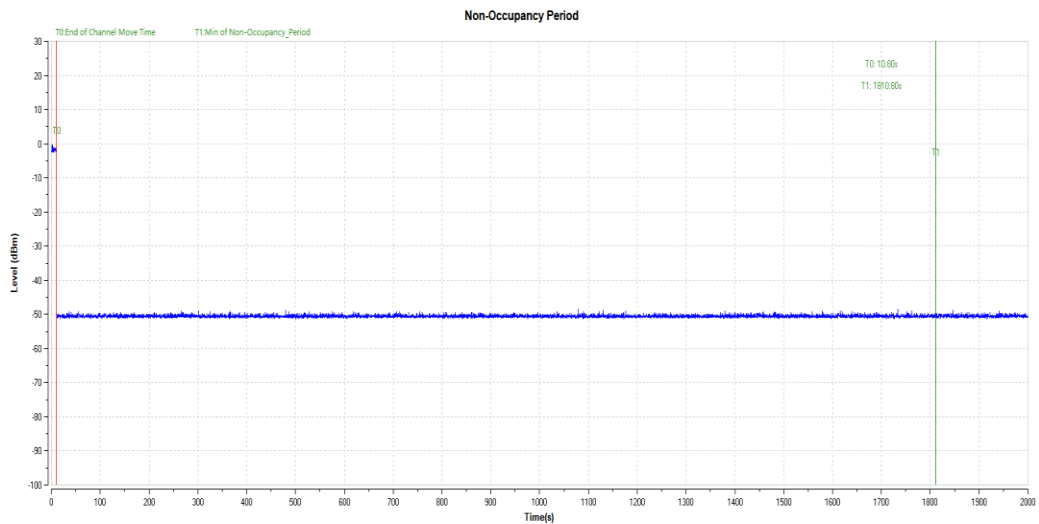
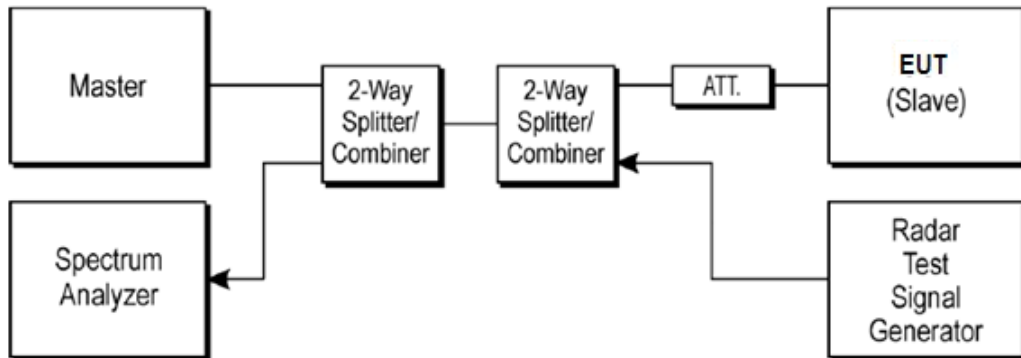

**Fig.4 Non-Occupancy Period (VHT80 Frequency Band: 5470MHz ~ 5725MHz)**

## **ANNEX B: DFS TEST SET-UP**

### **Measurement Method**

The below figure shows the DFS setup, where the EUT is a WLAN device operating in slave mode, without Radar Interference Detection function. This setup also contains a device operating in master mode. The radar test signals are injected into the master device. The EUT (slave device) is associated with the master device. WLAN traffic is generated by streaming the mpeg file from the master to the slave in full monitor video mode using the media player.



\*\*\* END OF REPORT \*\*\*