

FCC
SAR
TEST REPORT

ISSUED BY
Shenzhen BALUN Technology Co., Ltd.



FOR
Wireless data POS System

ISSUED TO
Shanghai Sunmi Technology Co.,Ltd.

Room 505, Block 7, KIC Plaza, No.388 Song Hu Road, Yang Pu District,
Shanghai, China



Tested by: *Zong Liyao*
Zong Liyao
(Engineer)

Date: *Jan. 29, 2019*

Approved by: *Wei Yanquan*
Wei Yanquan
(Chief Engineer)

Date: *Jan. 29, 2019*



Report No.: BL-SZ1910024-701

EUT Name: Wireless data POS System

Model Name: T5930

Brand Name: SUNMI

FCC ID: 2AH25V2

Test Standard: FCC 47 CFR Part 2.1093

ANSI C95.1: 1999

IEEE 1528: 2013

Maximum SAR: Body (1 g): 0.497 W/kg

Hand-held (10 g): 0.610 W/kg

Test Conclusion: Pass

Test Date: Jan. 04, 2019

Date of Issue: Jan. 29, 2019

NOTE: This test report of test results only related to testing samples, which can be duplicated completely for the legal use with the approval of the applicant; it shall not be reproduced except in full, without the written approval of Shenzhen BALUN Technology Co., Ltd. Any objections should be raised within thirty days from the date of issue. To validate the report, please contact us.

Revision History

<u>Version</u>	<u>Issue Date</u>	<u>Revisions Content</u>
<u>Rev. 01</u>	<u>Jan. 29, 2019</u>	<u>Initial Issue</u>

TABLE OF CONTENTS

1	ADMINISTRATIVE DATA (GENERAL INFORMATION)	4
1.1	Identification of the Testing Laboratory	4
1.2	Identification of the Responsible Testing Location	4
1.3	Test Environment Condition	4
1.4	Announce	4
2	PRODUCT INFORMATION	5
2.1	Applicant Information	5
2.2	Manufacturer Information	5
2.3	Factory Information	5
2.4	General Description for Equipment under Test (EUT)	5
2.5	Ancillary Equipment	6
2.6	Technical Information	7
3	SUMMARY OF TEST RESULTS	8
3.1	Test Standards	8
3.2	Device Category and SAR Limit	8
3.3	Test Result Summary	10
3.4	Test Uncertainty	11
4	SAR MEASUREMENT SYSTEM	12
4.1	Definition of Specific Absorption Rate (SAR)	12
4.2	SATIMO SAR System	12
5	SYSTEM VERIFICATION	21
5.1	Antenna Port Test Requirement	21
5.2	Purpose of System Check	21
5.3	System Check Setup	21
6	EUT TEST POSITION CONFIGURATIONS	22
6.1	Head Exposure Conditions	22

6.2	Body-worn Position Conditions	23
6.3	Hotspot Mode Exposure Position Conditions	24
7	SAR MEASUREMENT PROCEDURES.....	25
7.1	SAR Measurement Process Diagram	25
7.2	SAR Scan General Requirements	26
7.3	SAR Measurement Procedure	27
7.4	Area & Zoom Scan Procedures	27
8	CONDUCTED RF OUPUT POWER	28
8.1	WIFI.....	28
9	EUT ANTENNA LOCATION SKETCH	29
9.1	SAR Test Exclusion Consider Table	30
10	TEST RESULTS.....	32
10.1	WIFI 5GHz.....	32
11	SAR Measurement Variability	33
12	SIMULTANEOUS TRANSMISSION.....	34
13	TEST EQUIPMENTS LIST	35
ANNEX A	SIMULATING LIQUID VERIFICATION RESULT	36
ANNEX B	SYSTEM CHECK RESULT	37
ANNEX C	TEST DATA.....	42
ANNEX D	EUT EXTERNAL PHOTOS	46
ANNEX E	SAR TEST SETUP PHOTOS	51
ANNEX F	CALIBRATION REPORT	51

1 ADMINISTRATIVE DATA (GENERAL INFORMATION)

1.1 Identification of the Testing Laboratory

Company Name	Shenzhen BALUN Technology Co., Ltd.
Address	Block B, 1st FL, Baisha Science and Technology Park, Shahe Xi Road, Nanshan District, Shenzhen, Guangdong Province, P. R. China
Phone Number	+86 755 6685 0100

1.2 Identification of the Responsible Testing Location

Test Location	Shenzhen BALUN Technology Co., Ltd.
Address	Block B, 1st FL, Baisha Science and Technology Park, Shahe Xi Road, Nanshan District, Shenzhen, Guangdong Province, P. R. China
Accreditation Certificate	<p>The laboratory has been listed by Industry Canada to perform electromagnetic emission measurements. The recognition numbers of test site are 11524A-1.</p> <p>The laboratory is a testing organization accredited by FCC as a accredited testing laboratory. The designation number is CN1196.</p> <p>The laboratory is a testing organization accredited by American Association for Laboratory Accreditation (A2LA) according to ISO/IEC 17025. The accreditation certificate is 4344.01.</p> <p>The laboratory is a testing organization accredited by China National Accreditation Service for Conformity Assessment (CNAS) according to ISO/IEC 17025. The accreditation certificate number is L6791.</p>
Description	All measurement facilities used to collect the measurement data are located at Block B, FL 1, Baisha Science and Technology Park, Shahe Xi Road, Nanshan District, Shenzhen, Guangdong Province, P. R. China 518055

1.3 Test Environment Condition

Ambient Temperature	21°C to 23°C
Ambient Relative Humidity	45% to 55%
Ambient Pressure	100 to 102KPa

1.4 Announce

- (1) The test report reference to the report template version v2.3.
- (2) The test report is invalid if not marked with the signatures of the persons responsible for preparing and approving the test report.
- (3) The test report is invalid if there is any evidence and/or falsification.
- (4) The results documented in this report apply only to the tested sample, under the conditions and modes of operation as described herein.
- (5) This document may not be altered or revised in any way unless done so by BALUN and all revisions are duly noted in the revisions section.
- (6) Content of the test report, in part or in full, cannot be used for publicity and/or promotional purposes without prior written approval from the laboratory.

2 PRODUCT INFORMATION

2.1 Applicant Information

Applicant	Shanghai Sunmi Technology Co.,Ltd.
Address	Room 505, Block 7, KIC Plaza,No.388 Song Hu Road, Yang Pu District, Shanghai, China

2.2 Manufacturer Information

Manufacturer	Shanghai Sunmi Technology Co.,Ltd.
Address	Room 505, Block 7, KIC Plaza,No.388 Song Hu Road, Yang Pu District, Shanghai, China

2.3 Factory Information

Factory	N/A
Address	N/A

2.4 General Description for Equipment under Test (EUT)

EUT Name	Wireless data POS System
Model Name Under Test	T5930
Series Model Name	N/A
Description of Model Name Differentiation	N/A
Hardware Version	V3
Software Version	ZAP1522_769_DEV_dailybuild_20181205071714_userdebug_DCC
Dimensions (Approx.)	N/A
Weight (Approx.)	N/A

2.5 Ancillary Equipment

Ancillary Equipment 1	Battery	
	Brand Name	SUNMI
	Model No.	ZAP1522
	Serial No.	N/A
	Capacitance	2500mAh
	Rated Voltage	7.6 V
	Limit Charge Voltage	N/A
Ancillary Equipment 2	Adapter	
	Brand Name	N/A
	Model No.	TPA-23A050200UU01
	Serial No.	N/A
	Rated Input	100-240 V~, 0.3 A, 50/60 Hz
	Rated Output	5 V= 2 A
Ancillary Equipment 3	USB Cable	
	Model No.	N/A
	Length (Approx.)	1.0 m

2.6 Technical Information

Network and Wireless connectivity	2G Network GSM 850/ 900/ 1800/ 1900, GPRS, EGPRS; 3G Network WCDMA Band 1/ 2/ 5/ 8, HSDPA, HSUPA; 4G Network LTE FDD Band 2/ 3/ 4/ 7/17/ 28; WLAN; Bluetooth; GPS;
-----------------------------------	---

The requirement for the following technical information of the EUT was tested in this report:

Operating Mode	5G WLAN	
	802.11a/ /n(HT20/HT40)	5150 ~ 5250 MHz
		5725 ~ 5850 MHz
Antenna Type	WLAN: PIFA Antenna	
Exposure Category	General Population/Uncontrolled exposure	
EUT Stage	Portable Device	
Product	Type	
	<input checked="" type="checkbox"/> Production unit	<input type="checkbox"/> Identical prototype
Note: Only 5G WLAN was tested in this report.		

3 SUMMARY OF TEST RESULTS

3.1 Test Standards

No.	Identity	Document Title
1	47 CFR Part 2	Frequency Allocations and Radio Treaty Matters; General Rules and Regulations
2	ANSI/IEEE Std. C95.1-1999	IEEE Standard for Safety Levels with Respect to Human Exposure to Radio Frequency Electromagnetic Fields, 3 kHz to 300 GHz
3	IEEE Std. 1528-2013	Recommended Practice for Determining the Peak Spatial-Average Specific Absorption Rate (SAR) in the Human Head from Wireless Communications Devices: Measurement Techniques
4	FCC KDB 447498 D01 v06	Mobile and Portable Device RF Exposure Procedures and Equipment Authorization Policies
5	KDB 248227 D01 v02r02	SAR Guidance for IEEE 802.11 (Wi-Fi) Transmitters
6	FCC KDB 648474 D04 v01r03	SAR Evaluation Considerations for Wireless Handsets
7	FCC KDB 865664 D01 v01r04	SAR Measurement 100 MHz to 6 GHz
8	FCC KDB 865664 D02 v01r02	RF Exposure Reporting

3.2 Device Category and SAR Limit

This device belongs to portable device category because its radiating structure is allowed to be used within 20 centimeters of the body of the user. Limit for General Population/Uncontrolled exposure should be applied for this device, it is 1.6 W/kg as averaged over any 1 gram of tissue and 4.0W/Kg as averaged over any 10 gram of tissue.

Table of Exposure Limits:

Body Position	SAR Value (W/Kg)	
	General Population/ Uncontrolled Exposure	Occupational/ Controlled Exposure
Whole-Body SAR (averaged over the entire body)	0.08	0.4
Partial-Body SAR (averaged over any 1 gram of tissue)	1.60	8.0
SAR for hands, wrists, feet and ankles (averaged over any 10 grams of tissue)	4.0	20.0

NOTE:

General Population/Uncontrolled: Locations where there is the exposure of individuals who have no knowledge or control of their exposure. General population/uncontrolled exposure limits are applicable to situations in which the general public may be exposed or in which persons who are exposed as a consequence of their employment may not be made fully aware of the potential for exposure or cannot exercise control over their exposure. Members of the general public would come under this category when exposure is not employment-related; for example, in the case of a wireless transmitter that exposes persons in its vicinity.

Occupational/Controlled: Locations where there is exposure that may be incurred by persons who are aware of the potential for exposure. In general, occupational/controlled exposure limits are applicable to situations in which persons are exposed as a consequence of their employment, who have been made fully aware of the potential for exposure and can exercise control over their exposure. This exposure category is also applicable when the exposure is of a transient nature due to incidental passage through a location where the exposure levels may be higher than the general population/uncontrolled limits, but the exposed person is fully aware of the potential for exposure and can exercise control over his or her exposure by leaving the area or by some other appropriate means.

3.3 Test Result Summary

3.3.1 Highest SAR

Band	Maximum Scaled SAR (W/kg)		Maximum Report SAR (W/kg)	
	1g Body	10g Hand-held	1g Body	10g Hand-held
5.2G WLAN	0.610	0.497	0.610	0.497
5.8G WLAN	0.544	0.419		
Limit (W/kg)	1.6	4.0	1.6	4.0
Verdict	PASS			

3.4 Test Uncertainty

According to KDB 865664 D01, when the highest measured 1 g SAR within a frequency band is < 1.5 W/kg, the extensive SAR measurement uncertainty analysis is not required in SAR reports submitted for equipment approval. The equivalent ratio ($1.5/1.6$ 10 g SAR < 3.75 W/kg) should be applied to extremity exposure condition.

The maximum 1 g SAR for the EUT in this report is 0.610 W/kg, which is lower than 1.5 W/kg, and the maximum 10 g SAR for the EUT in this report is 0.497 W/kg, which is lower than 3.75 W/kg, so the extensive SAR measurement uncertainty analysis is not required in this report.

4 SAR MEASUREMENT SYSTEM

4.1 Definition of Specific Absorption Rate (SAR)

SAR is related to the rate at which energy is absorbed per unit mass in an object exposed to a radio field. The SAR distribution in a biological body is complicated and is usually carried out by experimental techniques or numerical modeling. The standard recommends limits for two tiers of groups, occupational/controlled and general population/uncontrolled, based on a person's awareness and ability to exercise control over his or her exposure. In general, occupational / controlled exposure limits are higher than the limits for general population /uncontrolled.

The SAR definition is the time derivative (rate) of the incremental energy (dW) absorbed by (dissipated in) an incremental mass (dm) contained in a volume element (dv) of a given density (ρ). The equation description is as below:

$$\text{SAR} = \frac{d}{dt} \left(\frac{dW}{dm} \right) = \frac{d}{dt} \left(\frac{dW}{\rho dv} \right)$$

SAR is expressed in units of Watts per kilogram (W/kg) SAR measurement can be related to the electrical field in the tissue by

$$\text{SAR} = \frac{\sigma E^2}{\rho}$$

Where: σ is the conductivity of the tissue,

ρ is the mass density of the tissue and E is the RMS electrical field strength.

4.2 SATIMO SAR System

4.2.1 SATIMO SAR System Diagram

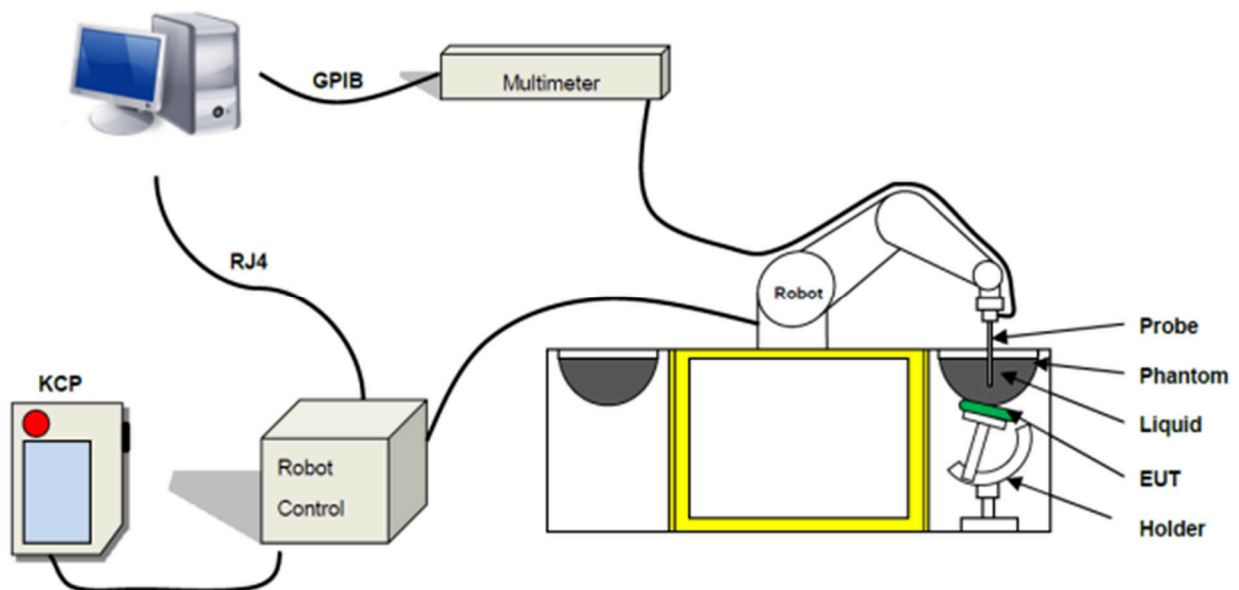

These measurements were performed with the automated near-field scanning system OPENSAR from SATIMO.

The system is based on a high precision robot (working range: 850 mm), which positions the probes with a positional repeatability of better than ± 0.02 mm. Special E- and H-field probes have been developed for measurements close to material discontinuity, the sensors of which are directly loaded with a Schottky diode and connected via highly resistive lines to the data acquisition unit.

The SAR measurements were conducted with dosimetric probe (manufactured by SATIMO), designed in the classical triangular configuration and optimized for dosimetric evaluation. The probe has been calibrated according to the procedure described in SAR standard with accuracy of better than $\pm 10\%$. The spherical isotropy was evaluated with the procedure described in SAR standard and found to be better than ± 0.25 dB. The phantom used was the SAM Phantom as described in FCC supplement C, IEEE P1528.

4.2.2 Robot

The SATIMO SAR system uses the high precision robots from KUKA. For the 6-axis controller system, the robot controller version (KUKA) from KUKA is used. The KUKA robot series have many features that are important for our application:



- High precision (repeatability ± 0.035 mm)
- High reliability (industrial design)
- Jerk-free straight movements
- Low ELF interference (the closed metallic construction shields against motor control fields)

4.2.3 E-Field Probe

For the measurements the Specific Dosimetric E-Field Probe SN 31 /17 EPGO 321 with following specifications is used

- Dynamic range: 0.01-100 W/kg
 - Tip Diameter : 2.5 mm
 - Lower detection limit : 10 mW/kg
(repeatability better than +/- 1mm)
 - Probe linearity: +/- 0.07 dB
 - Calibration range: 300 MHz to 6000 MHz for head & body simulating liquid.
- Angle between probe axis (evaluation axis) and surface normal line: less than 30°



E-Field Probe Calibration Process

Probe calibration is realized, in compliance with CENELEC EN 62209-1/-2 and IEEE 1528 std, with CALISAR, Antennessa proprietary calibration system. The calibration is performed with the IEC62209-1/2 annexe technique using reference guide at the five frequencies.

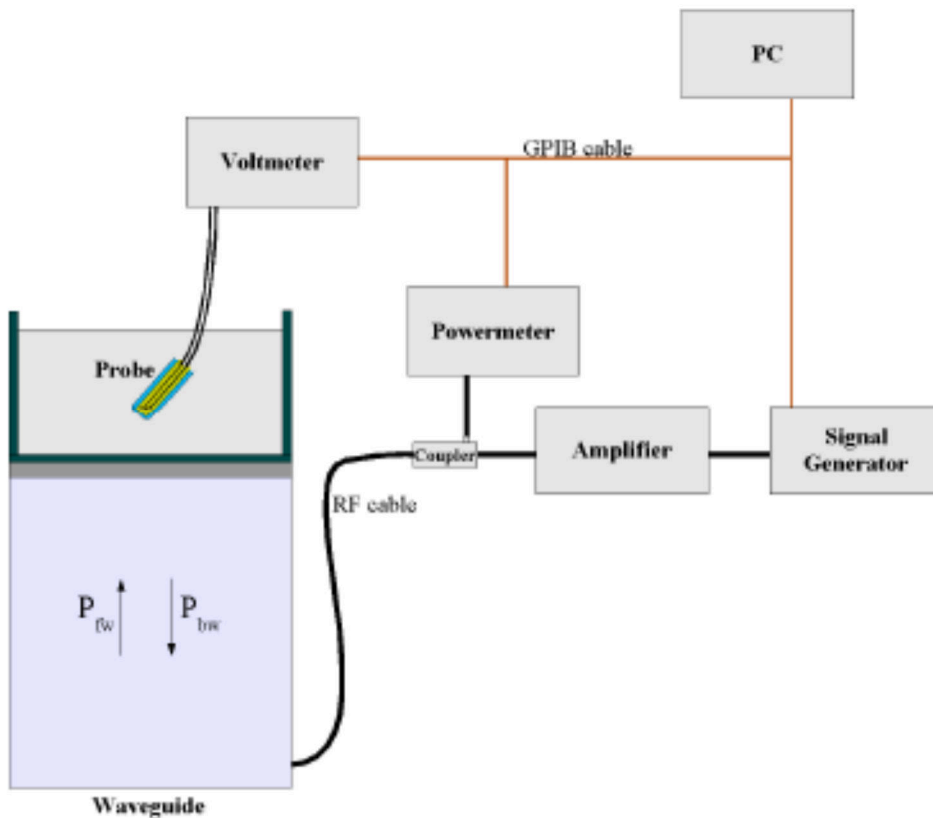

$$SAR = \frac{4(P_{fw} - P_{bw})}{ab\sigma} \cos^2 \left(\pi \frac{y}{a} \right) c^{(2\pi/\sigma)}$$

Where :

- Pfw = Forward Power
- Pbw = Backward Power
- a and b = Waveguide Dimensions
- δ = Skin Depth

Keithley configuration

Rate = Medium; Filter = ON; RDGS=10; FILTER TYPE = MOVING AVERAGE; RANGE AUTO After each calibration, a SAR measurement is performed on a validation dipole and compared with a NPL calibrated probe, to verify it.

The calibration factors, CF(N), for the 3 sensors corresponding to dipole 1, dipole 2 and dipole 3 are:

$$CF(N) = SAR(N) / V_{lin}(N) \quad (N=1,2,3)$$

The linearised output voltage $V_{lin}(N)$ is obtained from the displayed output voltage $V(N)$ using

$$V_{lin}(N) = V(N) * (1 + V(N) / DCP(N)) \quad (N=1,2,3)$$

Where the DCP is the diode compression point in mV.

4.2.4 Phantoms

For the measurements the Specific Anthropomorphic Mannequin (SAM) defined by the IEEE SCC-34/SC2 group is used. The phantom is a polyurethane shell integrated in a wooden table. The thickness of the phantom amounts to 2mm +/- 0.2mm. It enables the dosimetric evaluation of left and right phone usage and includes an additional flat phantom part for the simplified performance check. The phantom set-up includes a cover, which prevents the evaporation of the liquid.

Photo of Phantom SN 30/13 SAM103



Photo of Phantom SN 30/13 SAM104



Serial Number	Positionner Material	Permittivity	Loss Tangent
SN 30/13 SAM103	Gelcoat with fiberglass	3.4	0.02
SN 30/13 SAM104	Gelcoat with fiberglass	3.4	0.02

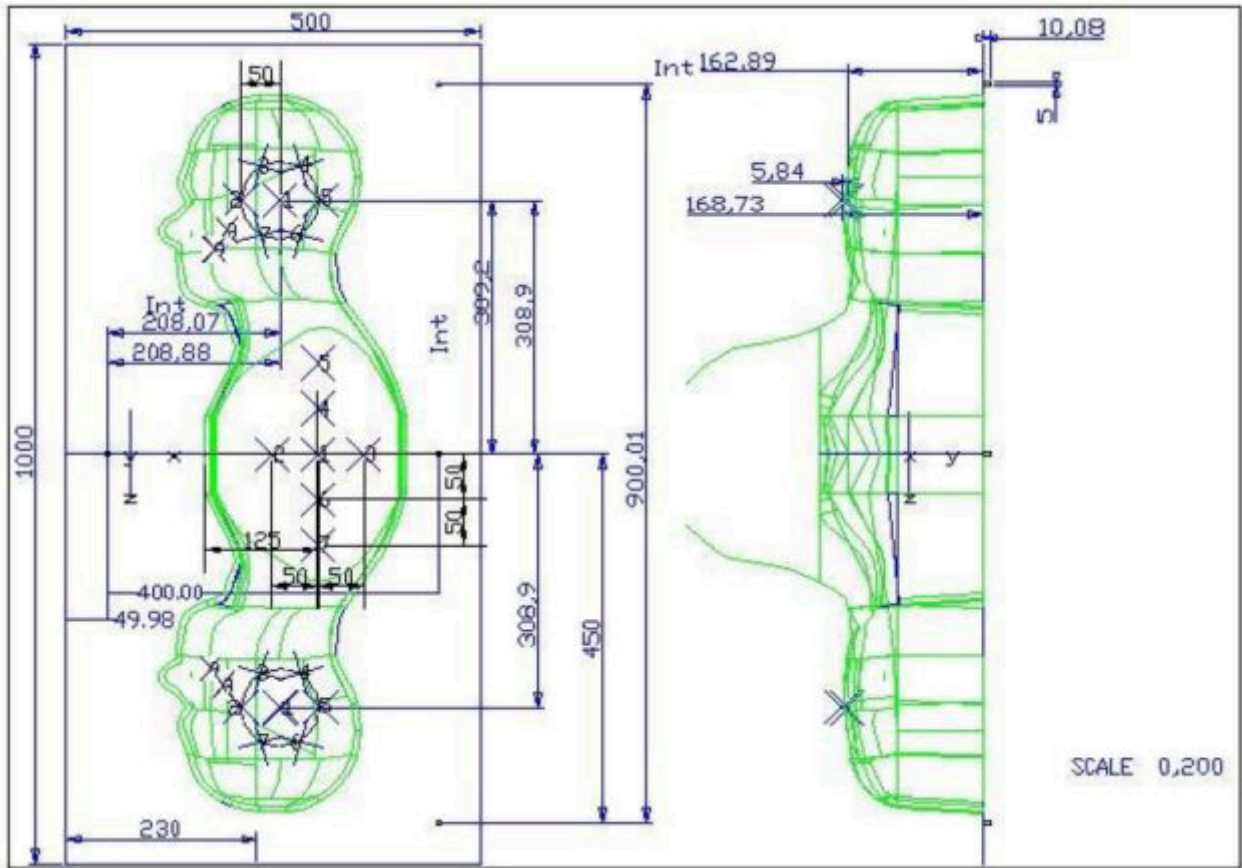

Serial Number	Left Head		Right Head		Flat Part	
SN 30/13 SAM103	2	2.00	2	2.03	1	2.09
	3	2.02	3	2.05	2	2.10
	4	2.04	4	2.04	3	2.09
	5	2.04	5	2.07	4	2.11
	6	2.02	6	2.07	5	2.11
	7	2.01	7	2.09	6	2.09
	8	2.04	8	2.10	7	2.11
	9	2.02	9	2.09	-	-
	SN 30/13 SAM104	2	2.05	2	2.06	1
3		2.08	3	2.03	2	2.03
4		2.05	4	2.03	3	2.01
5		2.06	5	2.02	4	2.03
6		2.08	6	2.02	5	2.03
7		2.06	7	2.04	6	2.00
8		2.07	8	2.04	7	1.98
9		2.07	9	2.05	-	-

4.2.5 Device Holder

The SAR in the phantom is approximately inversely proportional to the square of the distance between the source and the liquid surface. For a source at 5 mm distance, a positioning uncertainty of ± 0.5 mm would produce a SAR uncertainty of ± 20 %. Accurate device positioning is therefore crucial for accurate and repeatable measurements. The positions in which the devices must be measured are defined by the standards.

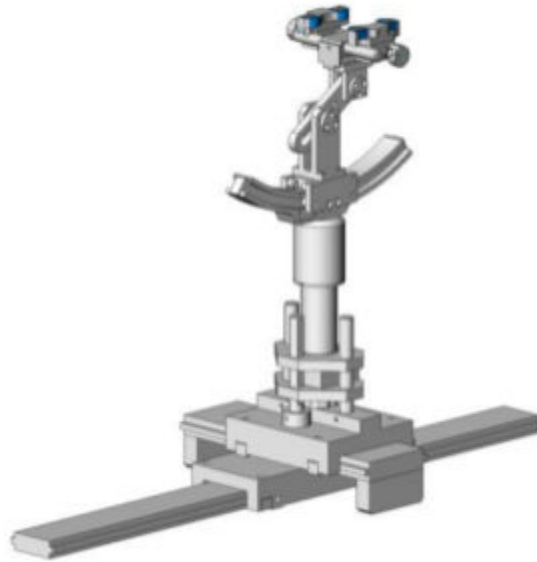

Serial Number	Holder Material	Permittivity	Loss Tangent
SN 25/13 MSH87	Deirin	3.7	0.005
SN 25/13 MSH88	Deirin	3.7	0.005

The positioning system allows obtaining cheek and tilting position with a very good accuracy. In compliance with CENELEC, the tilt angle uncertainty is lower than 1° .

4.2.6 Simulating Liquid

For SAR measurement of the field distribution inside the phantom, the phantom must be filled with homogeneous tissue simulating liquid to a depth of at least 15 cm. For head SAR testing, the liquid height from the ear reference point (ERP) of the phantom to the liquid top surface is larger than 15 cm. For body SAR testing, the liquid height from the center of the flat phantom to the liquid top surface is larger than 15 cm. The nominal dielectric values of the tissue simulating liquids in the phantom and the tolerance of 5%.

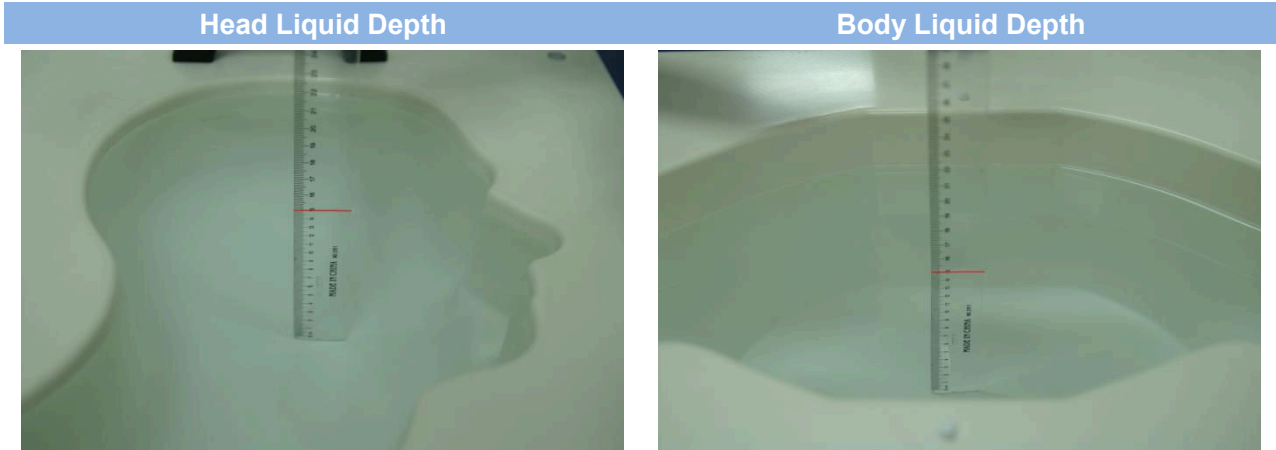

The following table gives the recipes for tissue simulating liquid and the theoretical Conductivity/Permittivity.

Head (Reference IEEE1528)								
Frequency (MHz)	Water (%)	Sugar (%)	Cellulose (%)	Salt (%)	Preventol (%)	DGBE (%)	Conductivity σ (S/m)	Permittivity ϵ
750	41.1	57.0	0.2	1.4	0.2	0	0.89	41.9
835	40.3	57.9	0.2	1.4	0.2	0	0.90	41.5
900	40.3	57.9	0.2	1.4	0.2	0	0.97	41.5
1800, 1900, 2000	55.2	0	0	0.3	0	44.5	1.4	40.0
2450	55.0	0	0	0.1	0	44.9	1.80	39.2
2600	54.9	0	0	0.1	0	45.0	1.96	39.0
Frequency(MHz)	Water (%)	Hexyl Carbitol (%)			Triton X-100 (%)		Conductivity σ (S/m)	Permittivity ϵ
5200	62.52	17.24			17.24		4.66	36.0
5800	62.52	17.24			17.24		5.27	35.3
Body (From instrument manufacturer)								
Frequency (MHz)	Water (%)	Sugar (%)	Cellulose (%)	Salt (%)	Preventol (%)	DGBE (%)	Conductivity σ (S/m)	Permittivity ϵ
750	51.7	47.2	0	0.9	0.1	0	0.96	55.5
835	50.8	48.2	0	0.9	0.1	0	0.97	55.2
900	50.8	48.2	0	0.9	0.1	0	1.05	55.0
1800, 1900, 2000	70.2	0	0	0.4	0	29.4	1.52	53.3
2450	68.6	0	0	0.1	0	31.3	1.95	52.7
2600	68.2	0	0	0.1	0	31.7	2.16	52.5

Frequency(MHz)	Water	DGBE (%)	Salt (%)	Conductivity σ (S/m)	Permittivity ϵ
5200	78.60	21.40	/	5.54	47.86
5800	78.50	21.40	0.1	6.0	48.20

5 SYSTEM VERIFICATION

5.1 Antenna Port Test Requirement

The SATIMO SAR system is equipped with one or more system validation kits. These units together with the predefined measurement procedures within the SATIMO software enable the user to conduct the system performance check and system validation. System validation kit includes a dipole, tripod holder to fix it underneath the flat phantom and a corresponding distance holder.

5.2 Purpose of System Check

The system performance check verifies that the system operates within its specifications. System and operator errors can be detected and corrected. It is recommended that the system performance check be performed prior to any usage of the system in order to guarantee reproducible results. The system performance check uses normal SAR measurements in a simplified setup with a well characterized source. This setup was selected to give a high sensitivity to all parameters that might fail or vary over time. The system check does not intend to replace the calibration of the components, but indicates situations where the system uncertainty is exceeded due to drift or failure.

5.3 System Check Setup

In the simplified setup for system evaluation, the EUT is replaced by a calibrated dipole and the power source is replaced by a continuous wave that comes from a signal generator. The calibrated dipole must be placed beneath the flat phantom section of the SAM twin phantom with the correct distance holder. The distance holder should touch the phantom surface with a light pressure at the reference marking and be oriented parallel to the long side of the phantom. The equipment setup is shown below:

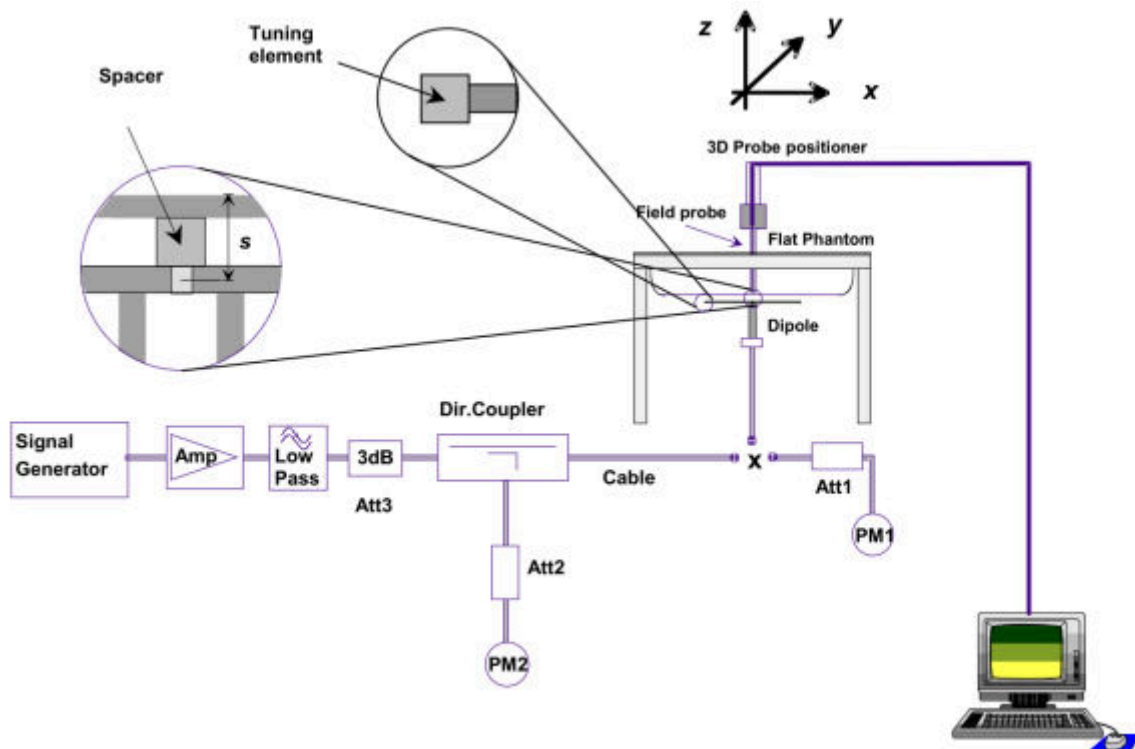

6 EUT TEST POSITION CONFIGURATIONS

According to KDB 648474 D04 Handset, handsets are tested for SAR compliance in head, body-worn accessory and other use configurations described in the following subsections.

6.1 Head Exposure Conditions

Head exposure is limited to next to the ear voice mode operations. Head SAR compliance is tested according to the test positions defined in IEEE Std 1528-2013 using the SAM phantom illustrated as below.

6.1.1 Define two imaginary lines on the handset

- The vertical center line passes through two points on the front side of the handset - the midpoint of the width w_t of the handset at the level of the acoustic output, and the midpoint of the width w_b of the bottom of the handset.
- The horizontal line is perpendicular to the vertical centerline and passes through the center of the acoustic output. The horizontal line is also tangential to the face of the handset at point A.
- The two lines intersect at point A. Note that for many handsets, point A coincides with the center of the acoustic output; however, the acoustic output may be located elsewhere on the horizontal line. Also note that the vertical centerline is not necessarily parallel to the front face of the handset, especially for clamshell handsets, handsets with flip covers, and other irregularly shaped handsets.

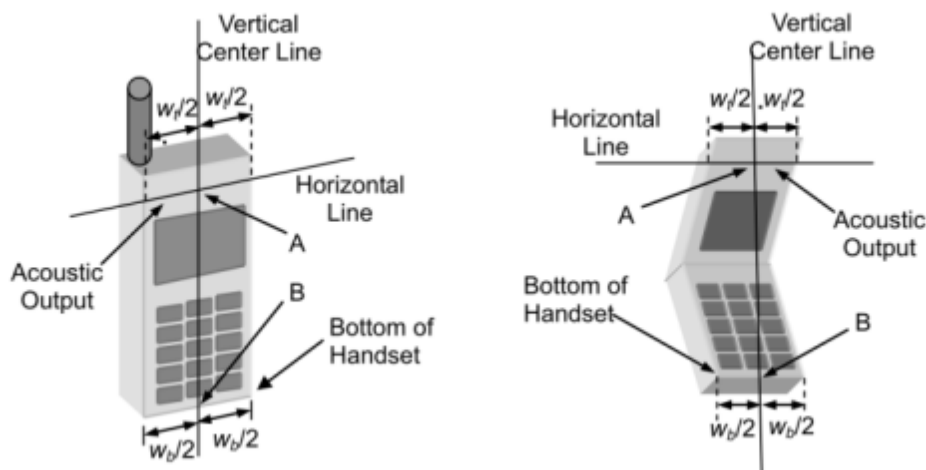

6.1.2 Cheek Position

- To position the device with the vertical center line of the body of the device and the horizontal line crossing the center piece in a plane parallel to the sagittal plane of the phantom. While maintaining the device in this plane, align the vertical center line with the reference plane containing the three ear and mouth reference point (M: Mouth, RE: Right Ear, and LE: Left Ear) and align the center of the ear piece with the line RE-LE.
- To move the device towards the phantom with the ear piece aligned with the line LE-RE until the phone touched the ear. While maintaining the device in the reference plane and maintaining the phone contact with the ear, move the bottom of the phone until any point on the front side is in contact with the cheek of the phantom or until contact with the ear is lost.

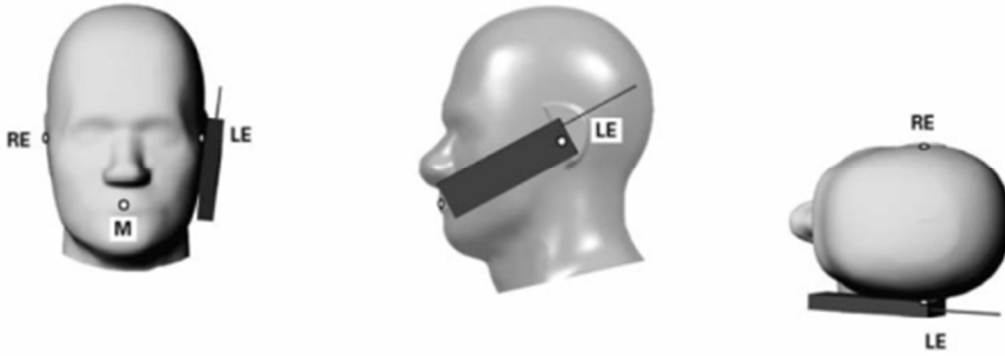

6.1.3 Tilted Position

- (a) To position the device in the “cheek” position described above.
- (b) While maintaining the device the reference plane described above and pivoting against the ear, moves it outward away from the mouth by an angle of 15 degrees or until contact with the ear is lost.

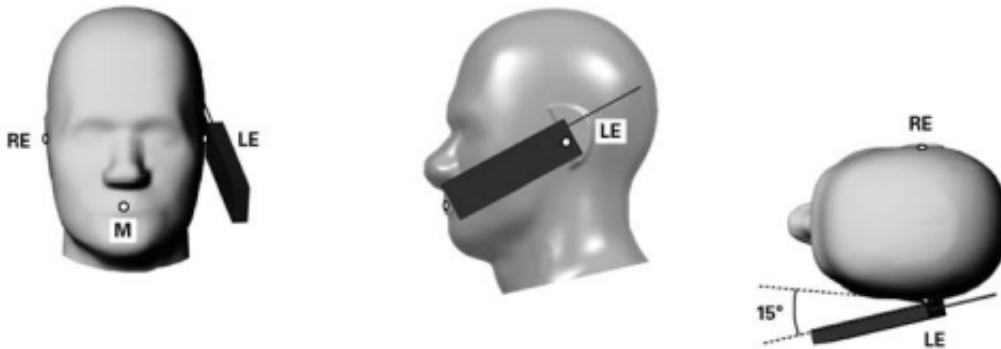

6.2 Body-worn Position Conditions

Body-worn accessory exposure is typically related to voice mode operations when handsets are carried in body-worn accessories. The body-worn accessory procedures in KDB 447498 are used to test for body-worn accessory SAR compliance, without a headset connected to it. This enables the test results for such configuration to be compatible with that required for hotspot mode when the body-worn accessory test separation distance is greater than or equal to that required for hotspot mode. When the reported SAR for a body-worn accessory, measured without a headset connected to the handset, is $> 1.2 \text{ W/kg}$, the highest reported SAR configuration for that wireless mode and frequency band should be repeated for that body-worn accessory with a headset attached to the handset.

Body-worn accessories that do not contain metallic or conductive components may be tested according to worst-case exposure configurations, typically according to the smallest test separation distance required for the group of body-worn accessories with similar operating and exposure characteristics. All body-worn accessories containing metallic components are tested in conjunction with the host device.

Body-worn accessory SAR compliance is based on a single minimum test separation distance for all wireless and operating modes applicable to each body-worn accessory used by the host, and according to the relevant voice and/or data mode transmissions and operations. If a body-worn accessory supports voice only operations in its normal and expected use conditions, testing of data mode for body-worn compliance is not required. A conservative minimum test separation distance for supporting off-the-shelf body-worn accessories that may be acquired by

users of consumer handsets is used to test for body-worn accessory SAR compliance. This distance is determined by the handset manufacturer, according to the requirements of Supplement C 01-01. Devices that are designed to operate on the body of users using lanyards and straps, or without requiring additional body-worn accessories, will be tested using a conservative minimum test separation distance ≤ 5 mm to support compliance.

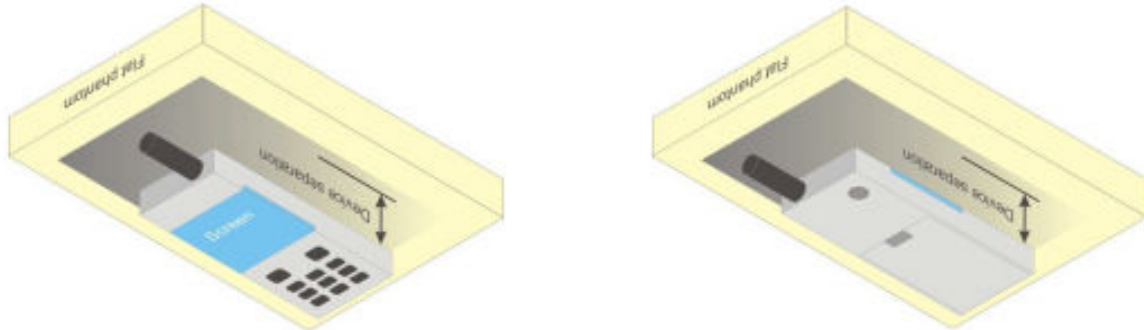

6.3 Hotspot Mode Exposure Position Conditions

For handsets that support hotspot mode operations, with wireless router capabilities and various web browsing functions, the relevant hand and body exposure conditions are tested according to the hotspot SAR procedures in KDB 941225. A test separation distance of 10 mm is required between the phantom and all surfaces and edges with a transmitting antenna located within 25 mm from that surface or edge. When the form factor of a handset is smaller than 9 cm x 5 cm, a test separation distance of 5 mm (instead of 10 mm) is required for testing hotspot mode. When the separation distance required for body-worn accessory testing is larger than or equal to that tested for hotspot mode, in the same wireless mode and for the same surface of the phone, the hotspot mode SAR data may be used to support body-worn accessory SAR compliance for that particular configuration (surface).

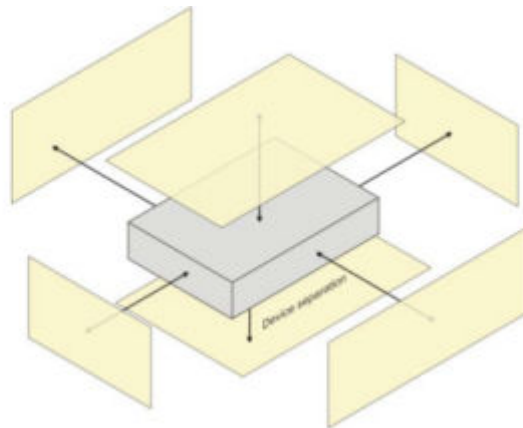

7 SAR MEASUREMENT PROCEDURES

7.1 SAR Measurement Process Diagram

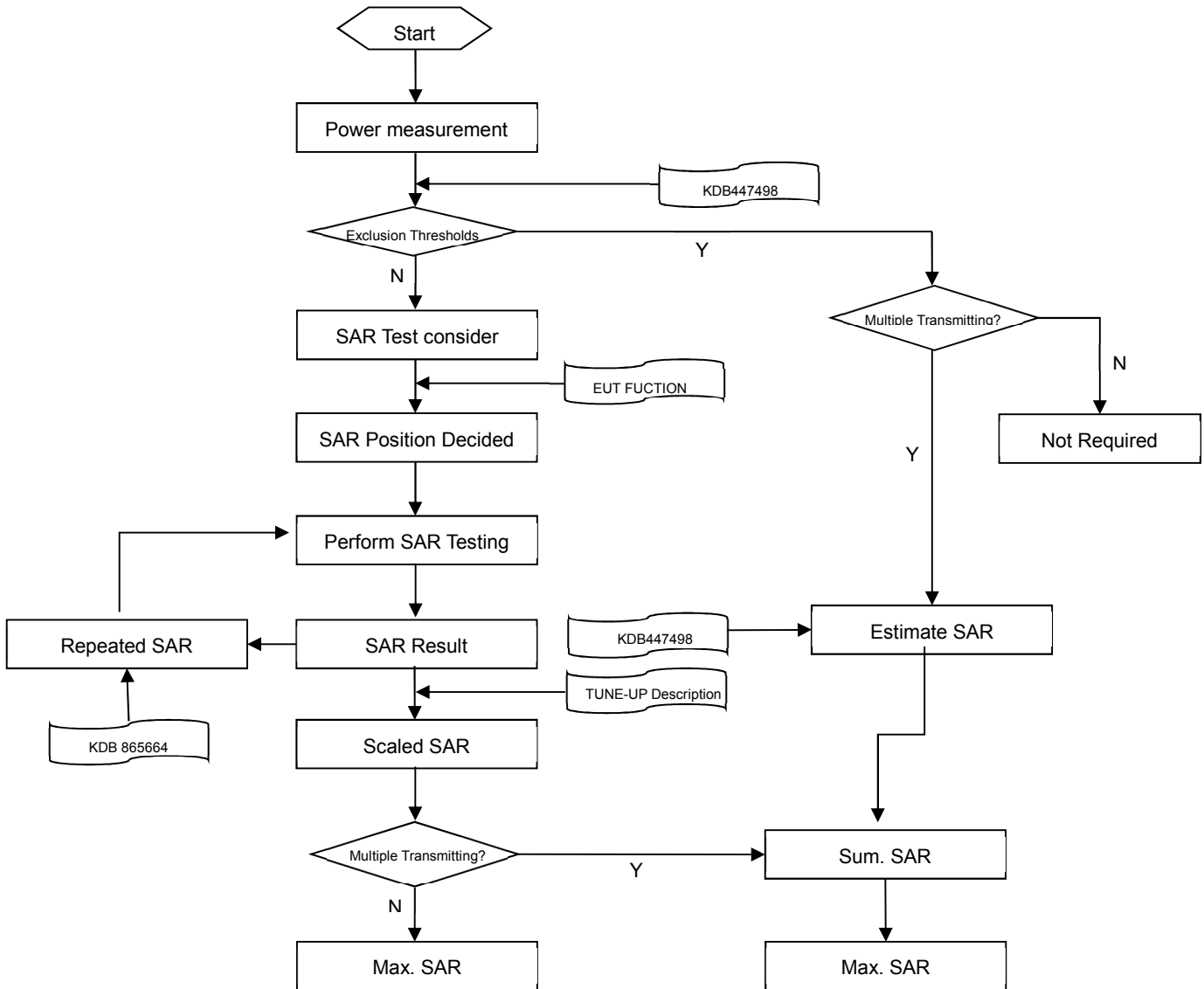

7.2 SAR Scan General Requirements

Probe boundary effect error compensation is required for measurements with the probe tip closer than half a probe tip diameter to the phantom surface. Both the probe tip diameter and sensor offset distance must satisfy measurement protocols; to ensure probe boundary effect errors are minimized and the higher fields closest to the phantom surface can be correctly measured and extrapolated to the phantom surface for computing 1-g SAR. Tolerances of the post-processing algorithms must be verified by the test laboratory for the scan resolutions used in the SAR measurements, according to the reference distribution functions specified in IEEE Std 1528-2013.

			≤3GHz	>3GHz
Maximum distance from closest measurement point (geometric center of probe sensors) to phantom surface			5±1 mm	$\frac{1}{2} \cdot \delta \cdot \ln(2) \pm 0.5$ mm
Maximum probe angle from probe axis to phantom surface normal at the measurement location			30°±1°	20°±1°
Maximum area scan spatial resolution: Δx Area , Δy Area			≤ 2 GHz: ≤ 15 mm 2 – 3 GHz: ≤ 12 mm	3–4 GHz: ≤ 12 mm 4 – 6 GHz: ≤ 10 mm
			When the x or y dimension of the test device, in the measurement plane orientation, is smaller than the above, the measurement resolution must be ≤ the corresponding x or y dimension of the test device with at least one measurement point on the test device.	
Maximum zoom scan spatial resolution: Δx Zoom , Δy Zoom			≤ 2 GHz: ≤ 8 mm 2 – 3 GHz: ≤ 5 mm*	3–4 GHz: ≤ 5 mm* 4 – 6 GHz: ≤ 4 mm*
Maximum zoom scan spatial resolution, normal to phantom surface	uniform grid: Δz Zoom (n)		≤ 5 mm	3–4 GHz: ≤ 4 mm
				4–5 GHz: ≤ 3 mm
				5–6 GHz: ≤ 2 mm
	graded grid	Δz Zoom (1): between 1st two points closest to phantom surface	≤ 4 mm	3–4 GHz: ≤ 3 mm
Δz Zoom (n>1): between subsequent points		4–5 GHz: ≤ 2.5 mm		
			5–6 GHz: ≤ 2 mm	
			≤ 1.5· Δz Zoom (n-1)	
Minimum zoom scan volume	x, y, z		≥30 mm	3–4 GHz: ≥ 28 mm
				4–5 GHz: ≥ 25 mm
				5–6 GHz: ≥ 22 mm

Note:

- δ is the penetration depth of a plane-wave at normal incidence to the tissue medium; see draft standard IEEE P1528-2011 for details.
- * When zoom scan is required and the reported SAR from the area scan based 1-g SAR estimation procedures of KDB 447498 is ≤ 1.4 W/kg, ≤ 8 mm, ≤ 7 mm and ≤ 5 mm zoom scan resolution may be applied, respectively, for 2 GHz to 3GHz, 3 GHz to 4 GHz and 4 GHz to 6 GHz.

7.3 SAR Measurement Procedure

The following steps are used for each test position

- Establish a call with the maximum output power with a base station simulator. The connection between the mobile and the base station simulator is established via air interface
- Measurement of the local E-field value at a fixed location. This value serves as a reference value for calculating a possible power drift.
- Measurement of the SAR distribution with a grid of 8 to 16mm * 8 to 16 mm and a constant distance to the inner surface of the phantom. Since the sensors cannot directly measure at the inner phantom surface, the values between the sensors and the inner phantom surface are extrapolated. With these values the area of the maximum SAR is calculated by an interpolation scheme.
- Around this point, a cube of 30 * 30 * 30 mm or 32 * 32 * 32 mm is assessed by measuring 5 or 8 * 5 or 8*4 or 5 mm. With these data, the peak spatial-average SAR value can be calculated.

7.4 Area & Zoom Scan Procedures

First Area Scan is used to locate the approximate location(s) of the local peak SAR value(s). The measurement grid within an Area Scan is defined by the grid extent, grid step size and grid offset. Next, in order to determine the EM field distribution in a three-dimensional spatial extension, Zoom Scan is required. The Zoom Scan is performed around the highest E-field value to determine the averaged SAR-distribution over 10 g. Area scan and zoom scan resolution setting follows KDB 865664 D01 quoted below.

When the 1-g SAR of the highest peak is within 2 dB of the SAR limit, additional zoom scans are required for other peaks within 2 dB of the highest peak that have not been included in any zoom scan to ensure there is no increase in SAR.

8 CONDUCTED RF OUPUT POWER

8.1 WIFI

8.1.1 5GWIFI

Band (GHz)	Mode	Channel	Freq. (MHz)	Avg. Power (dBm)	SAR Test Require.
5.2 (5.15~5.25)	802.11a	36	5180	15.50	NO
		40	5200	15.09	NO
		48	5240	14.74	NO
	802.11n(HT20)	36	5180	15.55	NO
		40	5200	15.11	NO
		48	5240	14.77	NO
	802.11n(HT40)	38	5190	16.60	YES
		46	5230	16.12	NO
	5.8 (5.725~5.850)	802.11a	149	5745	14.89
157			5785	14.51	NO
165			5825	14.26	NO
802.11n(HT20)		149	5745	14.78	NO
		157	5785	14.54	NO
		165	5825	14.31	NO
802.11n(HT40)		151	5755	16.26	YES
		159	5795	15.81	NO

9 EUT ANTENNA LOCATION SKETCH

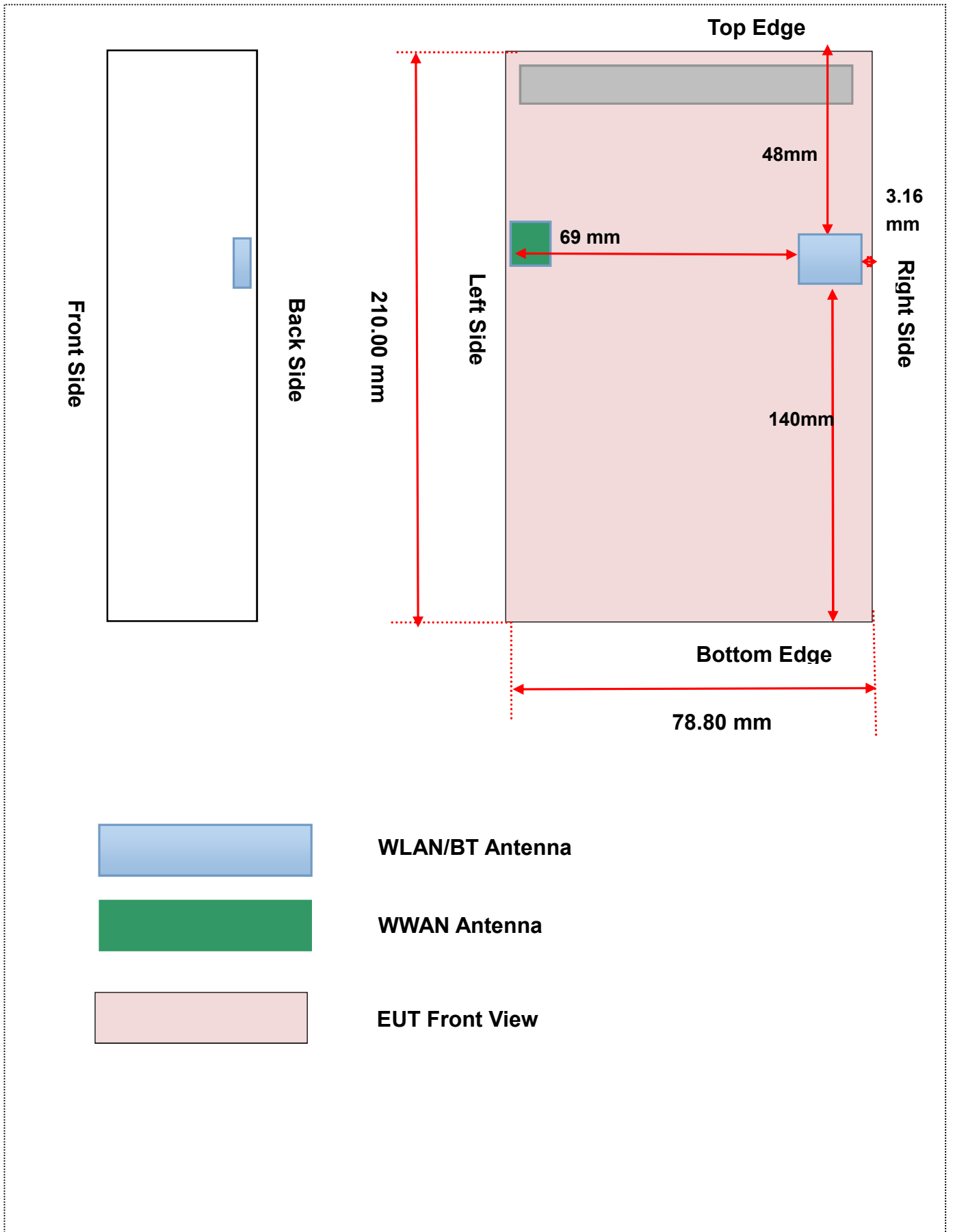

9.1 SAR Test Exclusion Consider Table

According with FCC KDB 447498 D01, Appendix A, <SAR Test Exclusion Thresholds for 100 MHz - 6 GHz and ≤ 50 mm> Table, this Device SAR test configurations consider as following :

Band	Mode	Max. Peak Power		Test Position Configurations					
		dBm	mW	Front	Back	Left Edge	Right Edge	Top Edge	Bottom Edge
WLAN 5.2 G	Distance to User			<5mm	<5mm	69mm	3.16mm	48mm	140 mm
	802.11a	16	39.81	Yes	Yes	No	Yes	No	No
	802.11n(HT20)	16	39.81	No	No	No	No	No	No
	802.11n(HT40)	17	50.12	No	No	No	No	No	No
WLAN 5.8 G	Distance to User			<5mm	<5mm	69mm	3.16mm	48mm	140 mm
	802.11a	16	39.81	Yes	Yes	No	Yes	No	No
	802.11n(HT20)	16	39.81	No	No	No	No	No	No
	802.11n(HT40)	16.5	44.67	No	No	No	No	No	No

Note:

- Maximum power is the source-based time-average power and represents the maximum RF output power among production units.
- Per KDB 447498 D01, for larger devices, the test separation distance of adjacent edge configuration is determined by the closest separation between the antenna and the user.
- Per KDB 447498 D01, standalone SAR test exclusion threshold is applied; If the distance of the antenna to the user is < 5mm, 5mm is used to determine SAR exclusion threshold
- Per KDB 447498 D01, the 1-g and 10-g SAR test exclusion thresholds for 100 MHz to 6 GHz at test separation distances ≤ 50 mm are determined by:

$$[(\text{max. power of channel, including tune-up tolerance, mW}) / (\text{min. test separation distance, mm})] \cdot [\sqrt{f(\text{GHz})}] \leq 3.0$$
 for 1-g SAR and ≤ 7.5 for 10-g extremity SAR
 - f(GHz) is the RF channel transmit frequency in GHz
 - Power and distance are rounded to the nearest mW and mm before calculation
 - The result is rounded to one decimal place for comparison
 - For < 50 mm distance, we just calculate mW of the exclusion threshold value (3.0) to do compare.
 This formula is $[3.0] / [\sqrt{f(\text{GHz})}] \cdot [(\text{min. test separation distance, mm})] = \text{exclusion threshold of mW}$
- Per KDB 447498 D01, at 100 MHz to 6 GHz and for test separation distances > 50 mm, the SAR test exclusion threshold is determined according to the following:
 - [Threshold at 50 mm in step 1) + (test separation distance - 50 mm) · (f(MHz)/150)] mW, at 100 MHz to 1500 MHz
 - [Threshold at 50 mm in step 1) + (test separation distance - 50 mm) · 10] mW at > 1500 MHz and ≤ 6 GHz
- Per KDB 248227 D01 SAR is not required for the following 2.4 GHz OFDM conditions.
 - When the reported SAR of the highest measured maximum output power channel for the exposure configuration is ≤ 0.8 W/kg, no further SAR testing is required for 802.11b DSSS in that exposure configuration.
 - When the reported SAR is > 0.8 W/kg, SAR is required for that exposure configuration using the next highest measured output power channel. When any reported SAR is > 1.2 W/kg, SAR is required for the third channel.
- Per KDB 248227 D01 SAR is not required for the following U-NII-1 and U-NII-2A bands conditions.
 - When the same maximum output power is specified for both bands, begin SAR measurement in U-NII-2A band by applying the OFDM SAR requirements. If the highest reported SAR for a test configuration is ≤ 1.2 W/kg, SAR is not required for U-NII-1 band for that configuration (802.11 mode and exposure condition); otherwise, each band is

tested independently for SAR.

- b. When different maximum output power is specified for the bands, begin SAR measurement in the band with higher specified maximum output power. The highest reported SAR for the tested configuration is adjusted by the ratio of lower to higher specified maximum output power for the two bands. When the adjusted SAR is ≤ 1.2 W/kg, SAR is not required for the band with lower maximum output power in that test configuration; otherwise, each band is tested independently for SAR.

8. Per KDB 248227 D01 5G WLAN Subsequent Test Configuration Procedures

SAR measurement requirements for the remaining 802.11 transmission mode configurations that have not been tested in the initial test configuration are determined separately for each standalone and aggregated frequency band, in each exposure condition, according to the maximum output power specified for production units.

- a. When SAR test exclusion provisions of KDB Publication 447498 D01 are applicable and SAR measurement is not required for the initial test configuration, SAR is also not required for the next highest maximum output power transmission mode subsequent test configuration(s) in that frequency band or aggregated band and exposure configuration.
- b. When the highest reported SAR for the initial test configuration (when applicable, include subsequent highest output channels), according to the initial test position or fixed exposure position requirements, is adjusted by the ratio of the subsequent test configuration to initial test configuration specified maximum output power and the adjusted SAR is ≤ 1.2 W/kg, SAR is not required for that subsequent test configuration.

10 TEST RESULTS

10.1 WIFI 5GHz

Fre. Band	Mode	Position	Dist. (mm)	Ch.	Freq. (MHz)	Power Drift (%)	1 g Meas. SAR (W/Kg)	Meas. Power (dBm)	Max. tune-up Power (dBm)	Scaling Factor	Duty Cycle (%)	Duty cycle Factor	1 g Scaled SAR (W/Kg)	Meas. No.
1g Body														
5.2G	802.11 n40	Front Side	5mm	38	5190	1.22	0.151	16.60	17.00	1.096	95.06	1.052	0.174	/
		Back Side	5mm	38	5190	0.08	0.029	16.60	17.00	1.096	95.06	1.052	0.033	/
		Right Side	5mm	38	5190	-2.12	0.529	16.60	17.00	1.096	95.06	1.052	0.610	1#
5.8G	802.11 n40	Front Side	5mm	151	5755	2.35	0.326	16.26	16.50	1.057	95.06	1.052	0.362	/
		Back Side	5mm	151	5755	-1.23	0.050	16.26	16.50	1.057	95.06	1.052	0.056	/
		Right Side	5mm	151	5755	3.86	0.489	16.26	16.50	1.057	95.06	1.052	0.544	2#
Fre. Band	Mode	Position	Dist. (mm)	Ch.	Freq. (MHz)	Power Drift (%)	10 g Meas. SAR (W/Kg)	Meas. Power (dBm)	Max. tune-up Power (dBm)	Scaling Factor	Duty Cycle (%)	Duty cycle Factor	10 g Scaled SAR (W/Kg)	Meas. No.
10g Hand-held														
5.2G	802.11 n40	Front Side	0mm	38	5190	-0.22	0.115	16.60	17.00	1.096	95.06	1.052	0.133	/
		Back Side	0mm	38	5190	1.13	0.045	16.60	17.00	1.096	95.06	1.052	0.052	/
		Right Side	0mm	38	5190	0.40	0.431	16.60	17.00	1.096	95.06	1.052	0.497	3#
5.8G	802.11 n40	Front Side	0mm	151	5755	-3.32	0.183	16.26	16.50	1.057	95.06	1.052	0.203	/
		Back Side	0mm	151	5755	0.26	0.022	16.26	16.50	1.057	95.06	1.052	0.024	/
		Right Side	0mm	151	5755	1.43	0.377	16.26	16.50	1.057	95.06	1.052	0.419	4#

11 SAR Measurement Variability

According to KDB 865664 D01, SAR measurement variability was assessed for each frequency band, which is determined by the SAR probe calibration point and tissue-equivalent medium used for the device measurements. When both head and body tissue-equivalent media are required for SAR measurements in a frequency band, the variability measurement procedures should be applied to the tissue medium with the highest measured SAR, using the highest measured SAR configuration for that tissue-equivalent medium. Alternatively, if the highest measured SAR for both head and body tissue-equivalent media are ≤ 1.45 W/kg and the ratio of these highest SAR values, i.e., largest divided by smallest value, is ≤ 1.10 , the highest SAR configuration for either head or body tissue-equivalent medium may be used to perform the repeated measurement. These additional measurements are repeated after the completion of all measurements requiring the same head or body tissue-equivalent medium in a frequency band. The test device should be returned to ambient conditions (normal room temperature) with the battery fully charged before it is re-mounted on the device holder for the repeated measurement(s) to minimize any unexpected variations in the repeated results.

SAR repeated measurement procedure:

1. When the highest measured SAR is < 0.80 W/kg, repeated measurement is not required.
2. When the highest measured SAR is ≥ 0.80 W/kg, repeat that measurement once.
3. If the ratio of largest to smallest SAR for the original and first repeated measurements is > 1.20 , or when the original or repeated measurement is ≥ 1.45 W/kg, perform a second repeated measurement.
4. If the ratio of largest to smallest SAR for the original, first and second repeated measurements is > 1.20 , and the original, first or second repeated measurement is ≥ 1.5 W/kg, perform a third repeated measurement.

The highest measured 1g SAR is 0.610 W/kg less than 0.80 W/kg, so the repeated measurement is not required.

The highest measured 10 g SAR is 0.497 W/kg less than 2.0 W/kg, so the repeated measurement is not required.

12 SIMULTANEOUS TRANSMISSION

Only 5G WLAN was tested in this report, about simultaneous transmission SAR please refer to the report of No. I18D00236-SAR01.

13 TEST EQUIPMENTS LIST

Description	Manufacturer	Model	Serial No.	Cal. Date	Cal. Due
Waveguide	SATIMO	SWG5500	S/N 49/16 DIP WGA42	2017/03/22	2020/03/21
E-Field Probe	MVG	SSE2	S/N 31/17 EPGO 321	2018/03/16	2019/03/15
MultiMeter	Keithley	MultiMeter 2000	4024022	2018/06/15	2019/06/14
Signal Generator	R&S	SMBV100A	260592	2018/06/12	2019/06/11
Power Meter	Agilent	E4419B	GB40201833	2018/11/02	2019/11/01
Power Sensor	Agilent	E9300A	MY41498012	2018/11/02	2019/11/01
Power Sensor	Agilent	E9300A	MY41499891	2018/11/02	2019/11/01
Network Analyzer	Agilent	5071B	MY42404001	2018/06/15	2019/06/14
Thermometer	Elitech	RC-4HC	N/A	2018/11/13	2019/11/12
Power Amplifier	SATIMO	6552B	22374	N/A	N/A
Dielectric Probe Kit	SATIMO	SCLMP	SN 25/13 OCPG56	N/A	N/A
Antenna	SATIMO	ANTA3	SN 17/13 ZNTA45	N/A	N/A
Phantom1	SATIMO	SAM	SN 30/13 SAM103	N/A	N/A
Phantom2	SATIMO	SAM	SN 30/13 SAM104	N/A	N/A
Attenuator	COM-MW	ZA-S1-31	1305003187	N/A	N/A
Directional coupler	AA-MCS	AAMCS-UDC	000272	N/A	N/A

Note: Per KDB 865664 Dipole SAR Validation Verification, BALUN LAB has adopted 3 years calibration intervals. On annual basis, every measurement dipole has been evaluated and is in compliance with the following criteria:

1. There is no physical damage on the dipole;
2. System validation with specific dipole is within 10% of calibrated value;
3. Return-loss in within 20% of calibrated measurement.
4. Impedance (real or imaginary parts) in within 5 Ohms of calibrated measurement.

ANNEX A SIMULATING LIQUID VERIFICATION RESULT

The dielectric parameters of the liquids were verified prior to the SAR evaluation using an SCLMP Dielectric Probe Kit.

Date	Liquid Type	Fre. (MHz)	Temp. (°C)	Meas. Conductivity (σ) (S/m)	Meas. Permittivity (ϵ)	Target Conductivity (σ) (S/m)	Target Permittivity (ϵ)	Conductivity Tolerance (%)	Permittivity Tolerance (%)
2019.01.04	Body	5200	21.3	5.15	50.31	5.30	49.00	-2.83	2.67
2019.01.04	Body	5800	21.3	6.14	47.02	6.00	48.20	2.33	-2.45

Note: The tolerance limit of Conductivity and Permittivity is $\pm 5\%$.

ANNEX B SYSTEM CHECK RESULT

Comparing to the original SAR value provided by SATIMO, the validation data should be within its specification of 10%(for 1 g).

Date	Liquid Type	Freq. (MHz)	Power (mW)	Measured SAR (W/kg)	Normalized SAR (W/kg)	Dipole SAR (W/kg)	Tolerance (%)	Targeted SAR(W/kg)	Tolerance (%)
2019.01.04	Body	5200	100	16.45	164.5	158.91	3.52	159.00	3.46
2019.01.04	Body	5800	100	18.45	184.5	177.09	4.18	181.20	1.82

Note: The tolerance limit of System validation $\pm 10\%$.

Comparing to the original SAR value provided by SATIMO, the validation data should be within its specification of 10%(for 10 g).

Date	Liquid Type	Freq. (MHz)	Power (mW)	Measured SAR (W/kg)	Normalized SAR (W/kg)	Dipole SAR (W/kg)	Tolerance (%)	Targeted SAR(W/kg)	Tolerance (%)
2019.01.04	Body	5200	100	5.57	55.7	56.35	-1.15	56.90	-2.11
2019.01.04	Body	5800	100	5.88	58.8	61.19	-3.91	61.50	-4.39

Note: The tolerance limit of System validation $\pm 10\%$.

System Performance Check Data(5200MHz Body)

Type: Phone measurement (Complete)
 E-Field Probe: SN 3117 EPG0321
 Area scan resolution: dx=8 mm,dy=8 mm
 Zoom scan resolution: dx=4 mm, dy=4 mm, dz=2 mm
 Date of measurement: 2019.01.04
 Measurement duration: 29 minutes 49 seconds

Experimental conditions.

Phantom File	surf_sam_plan.txt
Phantom	Validation plane
Band	5200 MHz
Signal	CW
Frequency (MHz)	5200.000000
Relative permittivity (real part)	50.312843
Conductivity (S/m)	5.152642
Power drift (%)	-0.530000
Ambient Temperature:	22.6°C
Liquid Temperature:	21.3°C
ConvF:	2.26
Crest factor:	1:1

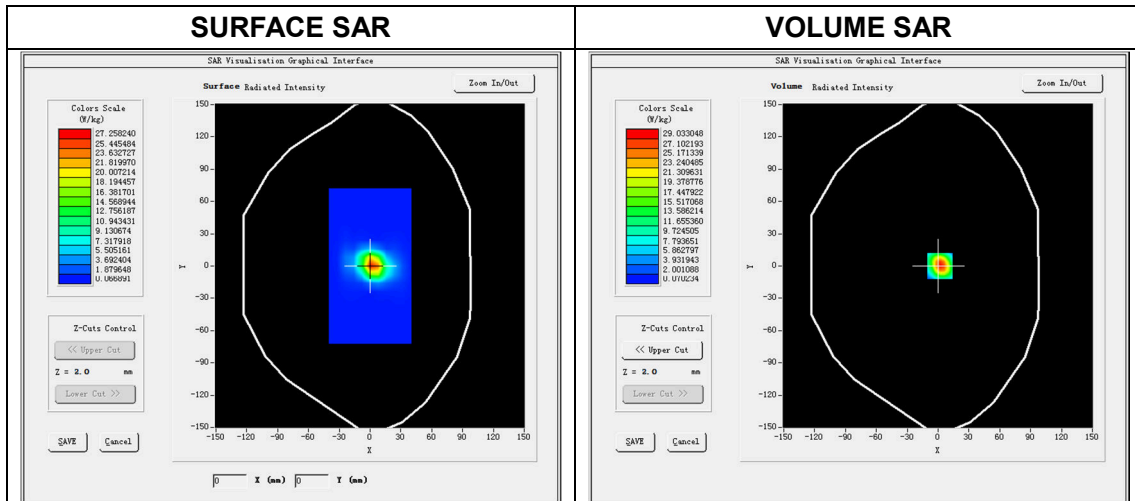

Maximum location: X=0.00, Y=0.00
 SAR Peak: 46.37 W/kg

SAR 10 g (W/Kg)	5.566391
SAR 1 g (W/Kg)	16.453157

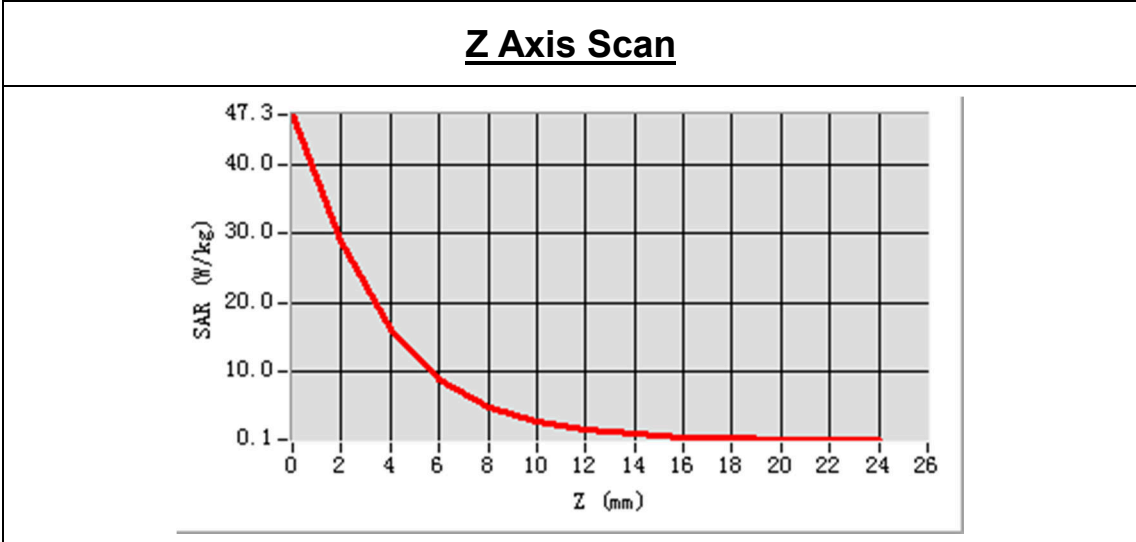

3D screen shot	Hot spot position

System Performance Check Data(5800MHz Body)

Type: Phone measurement (Complete)
 E-Field Probe: SN 3117 EPG0321
 Area scan resolution: dx=8 mm,dy=8 mm
 Zoom scan resolution: dx=4 mm, dy=4 mm, dz=2 mm
 Date of measurement: 2019.01.04
 Measurement duration: 30 minutes 27 seconds

Experimental conditions.

Phantom File	surf_sam_plan.txt
Phantom	Validation plane
Band	5800 MHz
Signal	CW
Frequency (MHz)	5800.000000
Relative permittivity (real part)	47.017963
Conductivity (S/m)	6.138426
Power drift (%)	0.170000
Ambient Temperature:	22.6°C
Liquid Temperature:	21.3°C
ConvF:	2.39
Crest factor:	1:1

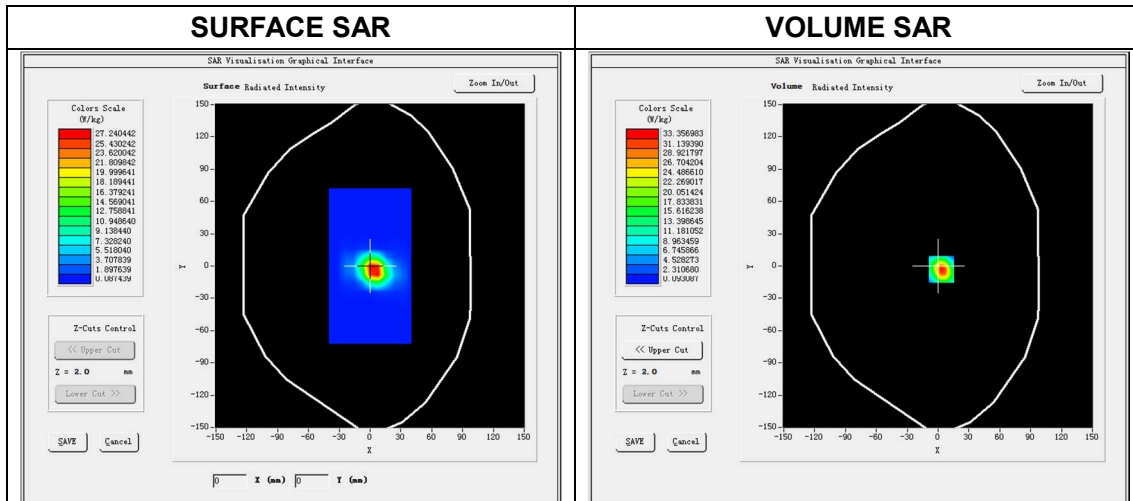

Maximum location: X=3.00, Y=-3.00
 SAR Peak: 57.43 W/kg

SAR 10 g (W/Kg)	5.875152
SAR 1 g (W/Kg)	18.450354

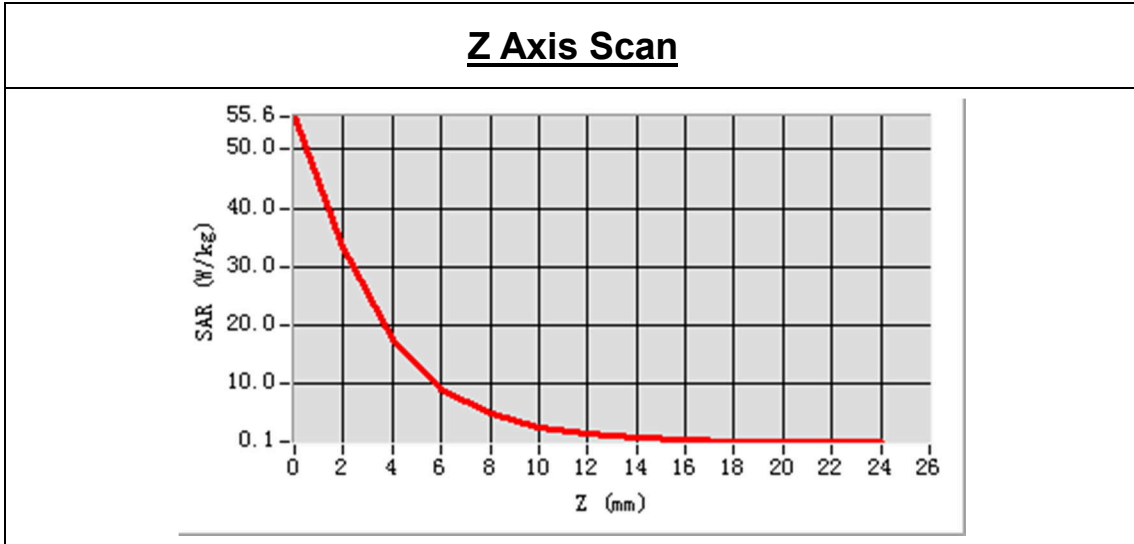

3D screen shot	Hot spot position

ANNEX C TEST DATA

MEAS. 1 Body Plane with Right Side 5mm on Channel 38 in IEEE 802.n40 mode

Test Date: 4/1/2019
Measurement duration: 27 minutes 33 seconds
Signal: WLAN, f=5190.0 MHz, Duty Cycle: 1:1.052
Liquid Parameters: Permittivity: 50.45; Conductivity: 5.14 S/m
Test condition: Ambient Temperature: 22.6°C, Liquid Temperature: 21.3°C
Probe: SN 3117 EPGO321, ConvF: 2.26
Area Scan: sam_direct_droit2_surf10mm.txt, h= 5.00 mm
Zoom Scan: 7x7x12,dx=4mm, dy=4mm, dz=2mm,Complete
Maximum location: X=0.000000, Y=28.000000
SAR 10g (W/Kg): 0.152964
SAR 1g (W/Kg): 0.528628
Power drift (%): -2.12
3D screen shot

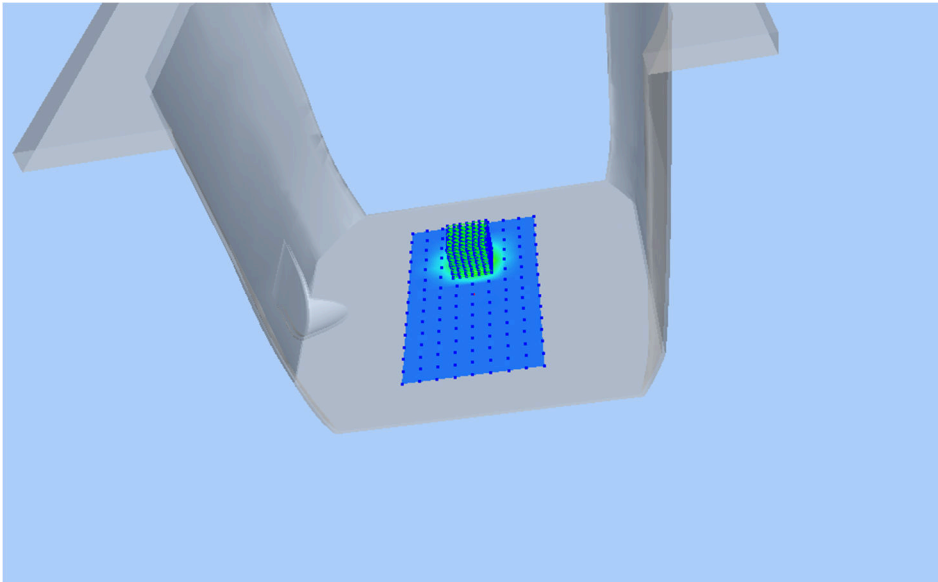

Z Axis Scan

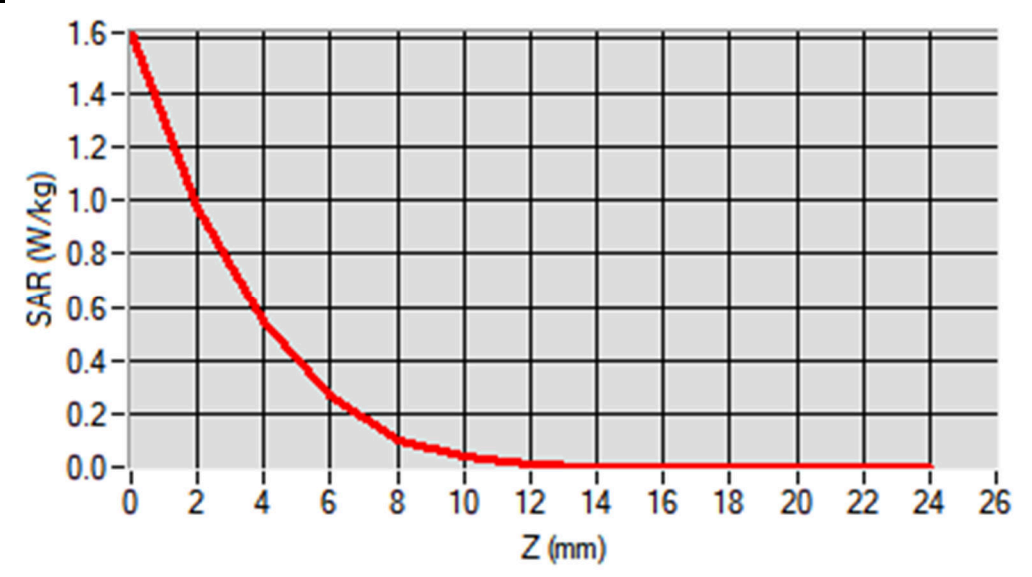

MEAS. 2 Body Plane with Right Side 5mm on Channel 151 in IEEE 802.n40 mode

Test Date: 4/1/2019
Measurement duration: 27 minutes 30 seconds
Signal: WLAN, f=5755.0 MHz, Duty Cycle: 1:1.052
Liquid Parameters: Permittivity: 47.32; Conductivity: 6.02 S/m
Test condition: Ambient Temperature: 22.6°C, Liquid Temperature: 21.3°C
Probe: SN 3117 EPGO321, ConvF: 2.39
Area Scan: sam_direct_droit2_surf10mm.txt, h= 5.00 mm
Zoom Scan: 7x7x12,dx=4mm, dy=4mm, dz=2mm,Complete
Maximum location: X=0.000000, Y=28.000000
SAR 10g (W/Kg): 0.135160
SAR 1g (W/Kg): 0.489052
Power drift (%): 3.86

3D screen shot

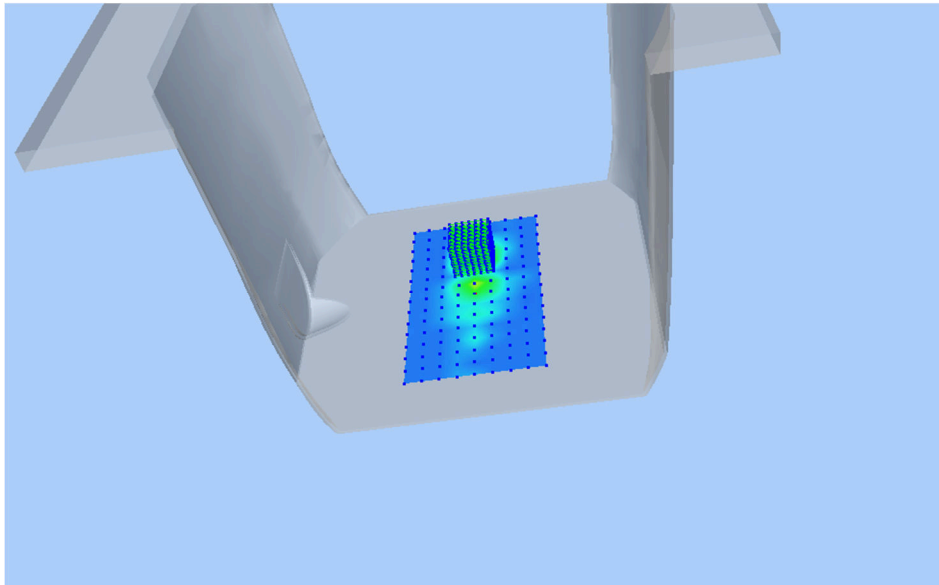

Z Axis Scan

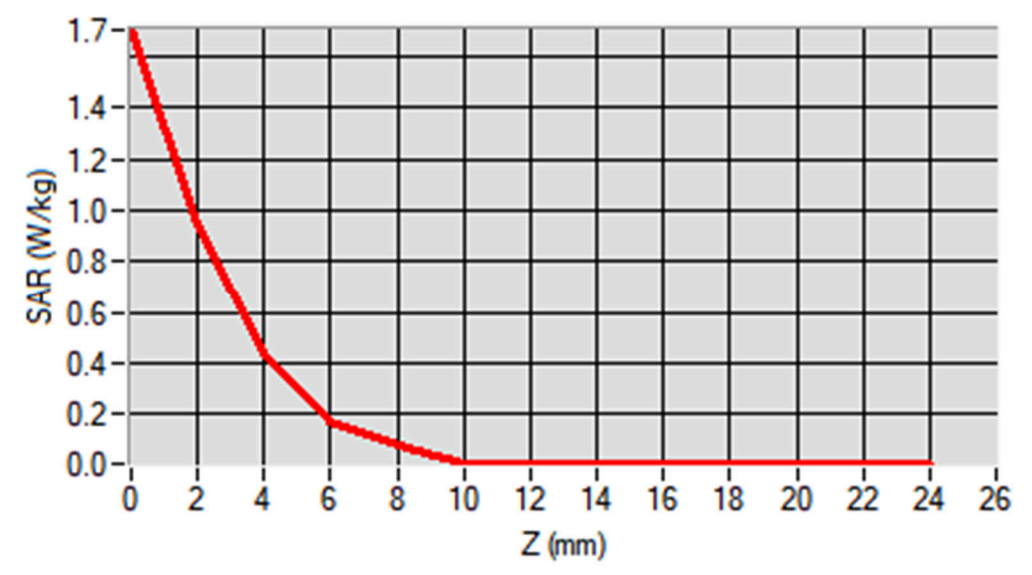

MEAS. 3 Body Plane with Right Side 0mm on Channel 38 in IEEE 802.n40 mode

Test Date: 4/1/2019
Measurement duration: 28 minutes 11 seconds
Signal: WLAN, f=5190.0 MHz, Duty Cycle: 1:1.052
Liquid Parameters: Permittivity: 50.45; Conductivity: 5.14 S/m
Test condition: Ambient Temperature: 22.6°C, Liquid Temperature: 21.3°C
Probe: SN 3117 EPGO321, ConvF: 2.26
Area Scan: sam_direct_droit2_surf10mm.txt, h= 5.00 mm
Zoom Scan: 7x7x12,dx=4mm, dy=4mm, dz=2mm,Complete
Maximum location: X=0.000000, Y=28.000000
SAR 10g (W/Kg): 0.431472
SAR 1g (W/Kg): 2.030303
Power drift (%): 0.40
3D screen shot

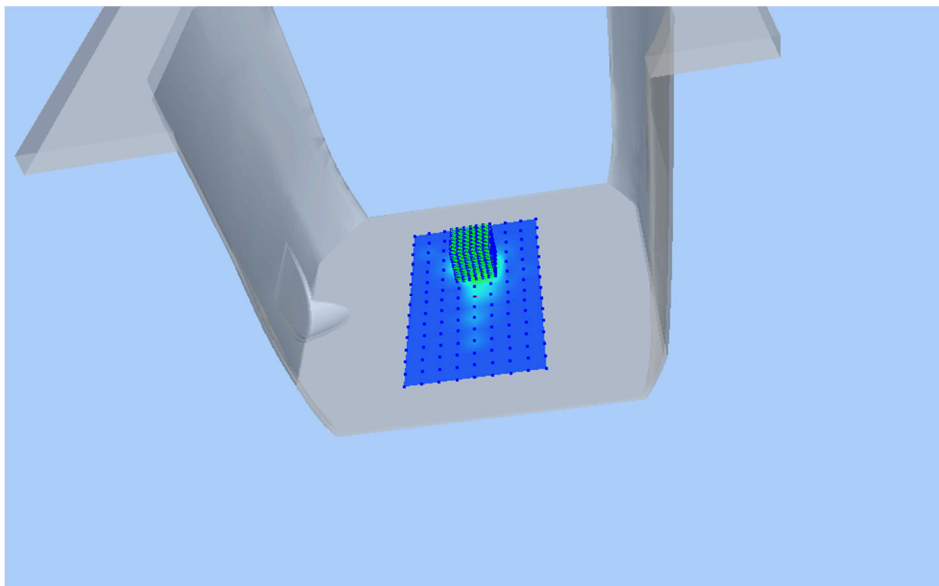
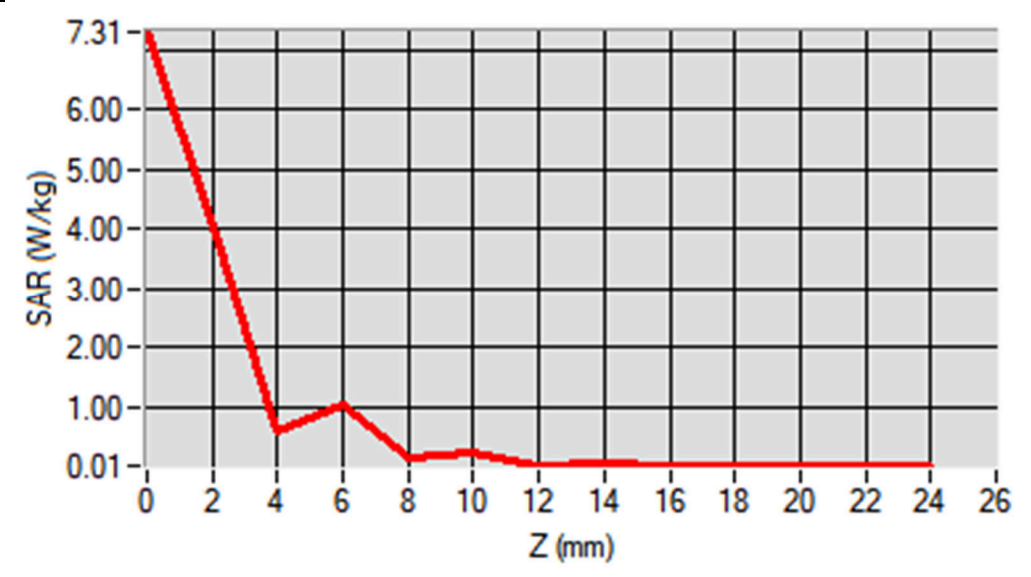
**Z Axis Scan**

MEAS. 4 Body Plane with Right Side 0mm on Channel in 151 IEEE 802.n40 mode

Test Date: 4/1/2019
Measurement duration: 28 minutes 5 seconds
Signal: WLAN, f=5755.0 MHz, Duty Cycle: 1:1.052
Liquid Parameters: Permittivity: 47.32; Conductivity: 6.02 S/m
Test condition: Ambient Temperature: 22.6°C, Liquid Temperature: 21.3°C
Probe: SN 3117 EPGO321, ConvF: 2.39
Area Scan: sam_direct_droit2_surf10mm.txt, h= 5.00 mm
Zoom Scan: 7x7x12,dx=4mm, dy=4mm, dz=2mm,Complete
Maximum location: X=0.000000, Y=28.000000
SAR 10g (W/Kg): 0.376750
SAR 1g (W/Kg): 1.819080
Power drift (%): 1.43

3D screen shot

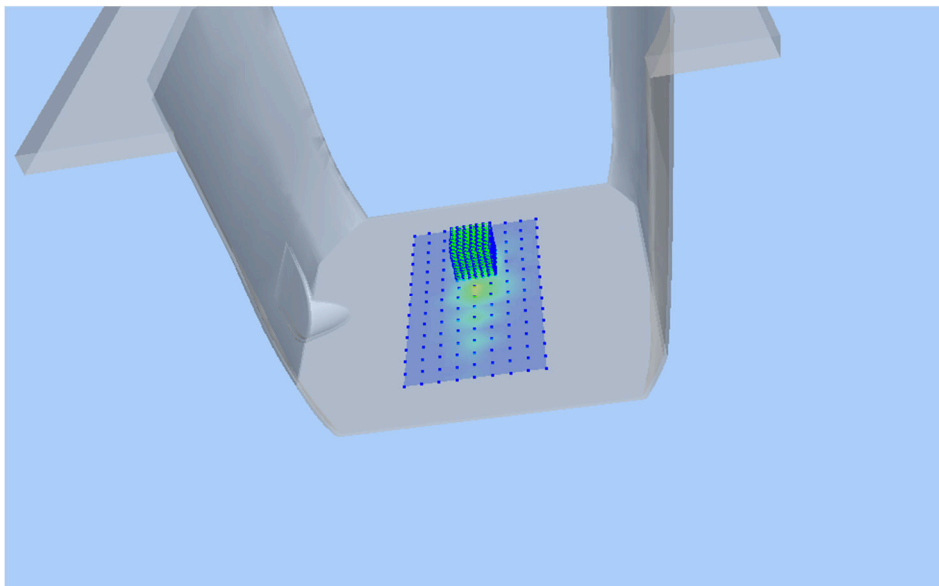

Z Axis Scan

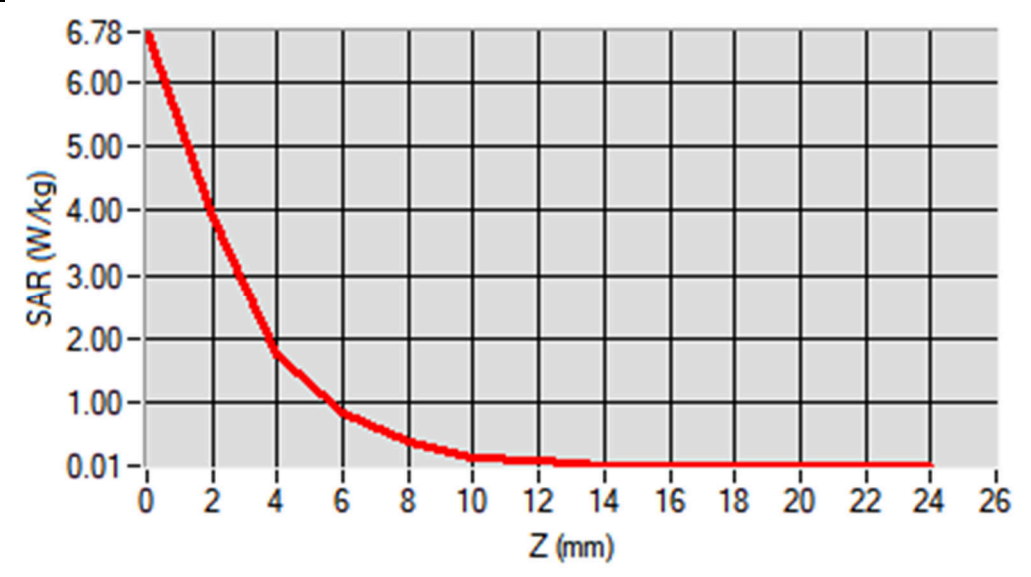

ANNEX D EUT EXTERNAL PHOTOS

FRONT VIEW OF EUT



REAR VIEW OF EUT

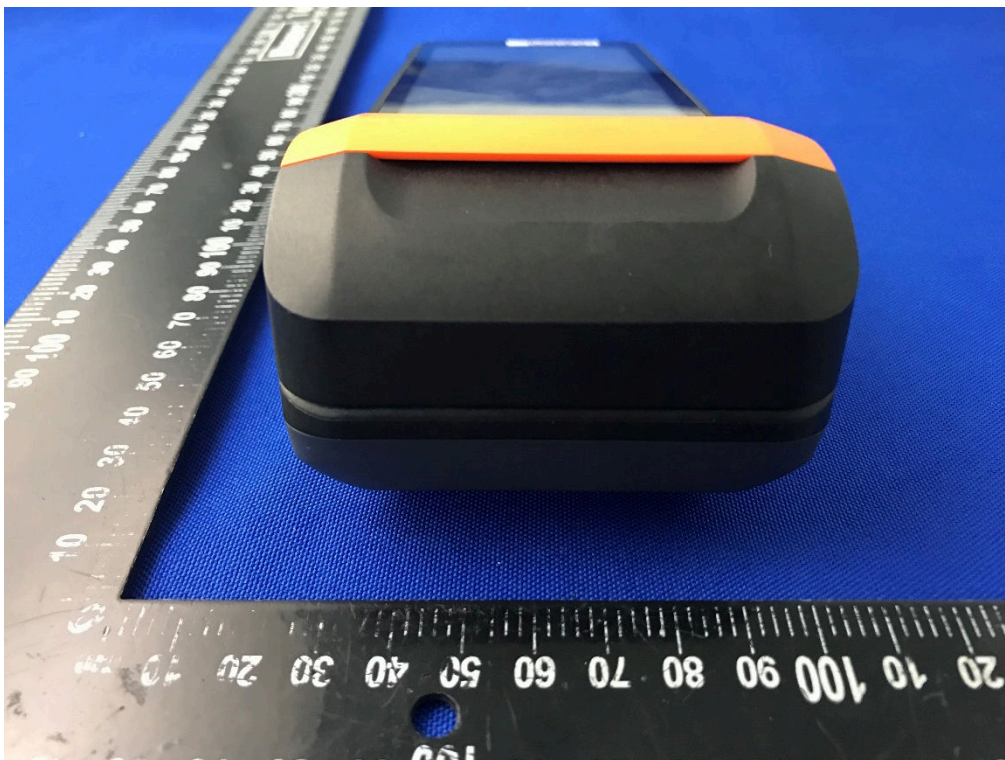

LEFT SIDE VIEW OF EUT



RIGHT SIDE OF EUT



TOP VIEW OF EUT



BOTTOM VIEW OF EUT



Accessory-Power Adapter

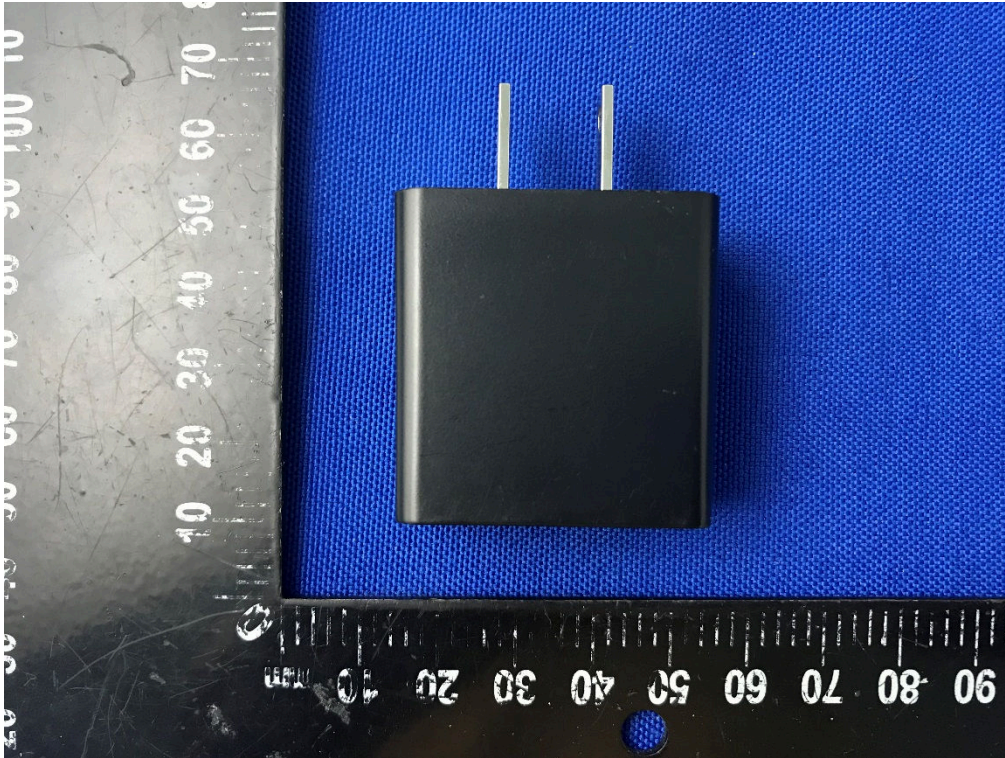

CLOSE-UP



Accessory-USB Cable

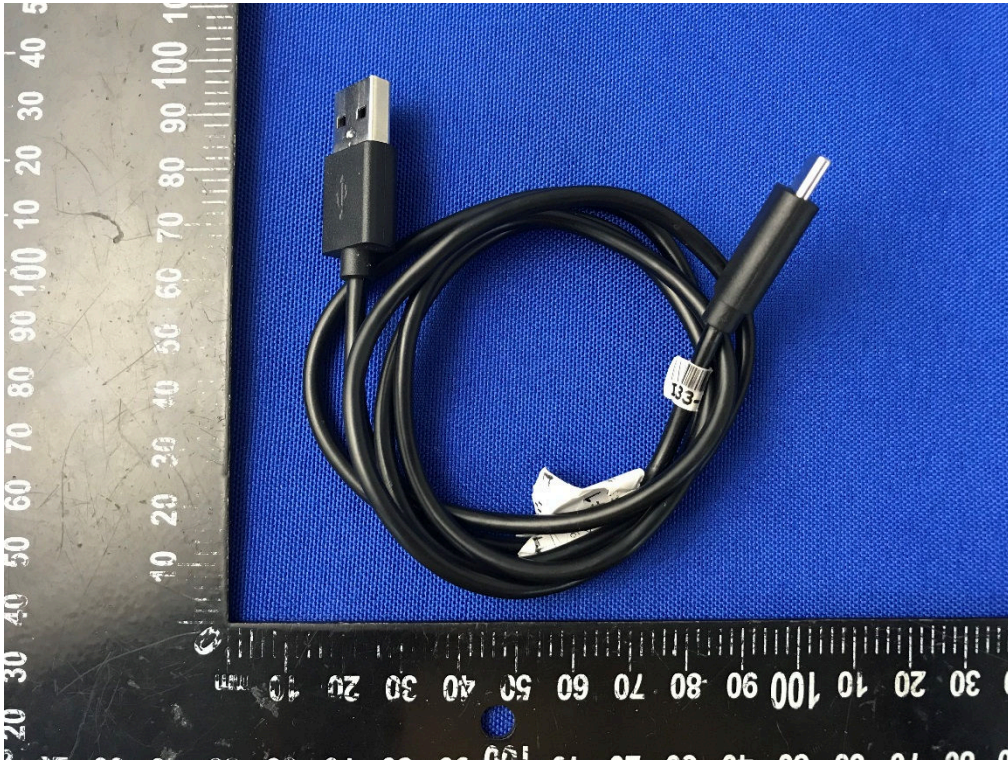

ANNEX E SAR TEST SETUP PHOTOS

Please refer the document "BL-SZ1910024-AS.pdf".

ANNEX F CALIBRATION REPORT

Please refer the document "CALIBRATION REPORT.pdf".

--END OF REPORT--