



## TEST REPORT

No. I18D00236-SAR01

*For*

**Client:** Shanghai Sunmi Technology Co.,Ltd.

**Production:** Wireless data POS System

**Model Name:** T5930

**Brand Name:** SUNMI

**FCC ID:** 2AH25V2

**Hardware Version:** V3

**Software Version:** ZAP1522\_769\_DEV\_dailybuild14  
\_201812050717\_userdebug\_DCC

**Issued date:** 2019-01-28

## NOTE

1. The test results in this test report relate only to the devices specified in this report.
2. This report shall not be reproduced except in full without the written approval of East China Institute of Telecommunications.
3. KDB has not been approved by A2LA.
4. For the test results, the uncertainty of measurement is not taken into account when judging the compliance with specification, and the results of measurement or the average value of measurement results are taken as the criterion of the compliance with specification directly.

### **Test Laboratory:**

East China Institute of Telecommunications

Add: 7-8F, G Area, No.668, Beijing East Road, Huangpu District, Shanghai, P. R. China

Tel: +86 21 63843300

FAX: +86 21 63843301

E-Mail: [welcome@ecit.org.cn](mailto:welcome@ecit.org.cn)

**Revision Version**

<b>Report Number</b>	<b>Revision</b>	<b>Date</b>	<b>Memo</b>
I18D00236-SAR01	00	2019-01-28	Initial creation of test report

---

## CONTENTS

NOTE.....	2
1. TEST LABORATORY .....	7
1.1. TESTING LOCATION .....	7
1.2. TESTING ENVIRONMENT.....	7
1.3. PROJECT DATA.....	7
1.4. SIGNATURE .....	7
2. STATEMENT OF COMPLIANCE .....	8
3. CLIENT INFORMATION .....	10
3.1. APPLICANT INFORMATION .....	10
3.2. MANUFACTURER INFORMATION .....	10
4. EQUIPMENT UNDER TEST (EUT) AND ANCILLARY EQUIPMENT (AE).....	11
4.1. ABOUT EUT .....	11
4.2. INTERNAL IDENTIFICATION OF EUT USED DURING THE TEST.....	12
4.3. INTERNAL IDENTIFICATION OF AE USED DURING THE TEST .....	12
5. TEST METHODOLOGY .....	13
5.1. APPLICABLE LIMIT REGULATIONS .....	13
5.2. APPLICABLE MEASUREMENT STANDARDS .....	13
6. SPECIFIC ABSORPTION RATE (SAR).....	14
6.1. INTRODUCTION .....	14
6.2. SAR DEFINITION .....	14
7. TISSUE SIMULATING LIQUIDS .....	15
7.1. TARGETS FOR TISSUE SIMULATING LIQUID.....	15
7.2. DIELECTRIC PERFORMANCE .....	16
8. SYSTEM VERIFICATION .....	17
8.1. SYSTEM SETUP .....	17

8.2.	SYSTEM VERIFICATION .....	18
9.	MEASUREMENT PROCEDURES .....	19
9.1.	TESTS TO BE PERFORMED .....	19
9.2.	GENERAL MEASUREMENT PROCEDURE.....	19
9.3.	WCDMA MEASUREMENT PROCEDURES FOR SAR .....	20
9.4.	BLUETOOTH & WIFI MEASUREMENT PROCEDURES FOR SAR.....	21
9.5.	POWER DRIFT .....	22
10.	AREA SCAN BASED 1-G SAR .....	23
11.	CONDUCTED OUTPUT POWER .....	24
	MANUFACTURING TOLERANCE.....	24
11.1.	GSM MEASUREMENT RESULT .....	31
11.2.	WCDMA MEASUREMENT RESULT .....	33
11.3.	LTE MEASUREMENT RESULT .....	34
11.4.	WIFI AND BT MEASUREMENT RESULT .....	43
12.	SIMULTANEOUS TX SAR CONSIDERATIONS.....	46
12.1.	INTRODUCTION .....	46
12.2.	TRANSMIT ANTENNA SEPARATION DISTANCES.....	47
12.3.	STANDALONE SAR TEST EXCLUSION CONSIDERATIONS .....	48
12.4.	SAR MEASUREMENT POSITIONS .....	48
13.	SAR TEST RESULT .....	49
14.	EVALUATION OF SIMULTANEOUS.....	63
15.	SAR MEASUREMENT VARIABILITY.....	65
16.	MEASUREMENT UNCERTAINTY .....	66
17.	MAIN TEST INSTRUMENT .....	68
	ANNEX A. HIGHEST SAR GRAPH RESULTS.....	69
	ANNEX B. SYSTEM VALIDATION RESULTS .....	89

**ANNEX C. SAR MEASUREMENT SETUP ..... 95**

**ANNEX D. POSITION OF THE WIRELESS DEVICE IN RELATION TO THE PHANTOM..... 104**

**ANNEX E. EQUIVALENT MEDIA RECIPES ..... 108**

**ANNEX F. SYSTEM VALIDATION ..... 109**

**ANNEX G. PROBE AND DAE CALIBRATION CERTIFICATE..... 110**

**ANNEX H. ACCREDITATION CERTIFICATE ..... 174**

## 1. Test Laboratory

### 1.1. Testing Location

Company Name:	ECIT Shanghai, East China Institute of Telecommunications
Address:	7-8F, G Area, No. 668, Beijing East Road, Huangpu District, Shanghai, P. R. China
Postal Code:	200001
Telephone:	(+86)-021-63843300
Fax:	(+86)-021-63843301
FCC registration No:	958356

### 1.2. Testing Environment

Normal Temperature:	18-25°C
Relative Humidity:	25-75%
Ambient noise & Reflection:	< 0.012 W/kg

### 1.3. Project Data

Project Leader:	Zhou Yan
Testing Start Date:	2018-12-24
Testing End Date:	2018-12-28

### 1.4. Signature



Yan Hang  
(Prepared this test report)



Fu Erliang  
(Reviewed this test report)

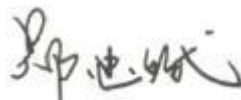

Zheng Zhongbin  
(Approved this test report)

## 2. Statement of Compliance

The maximum results of Specific Absorption Rate (SAR) found during testing for **T5930** are as follows .

**Table 2.1: Max. Reported SAR (1g/10g)**

Band	SAR 1g(W/Kg)		SAR 10g(W/Kg)
	Body worn(5mm)	Hotspot(5mm)	Limb
GSM 850	0.561	0.561	0.741
GSM 1900	0.476	0.983	1.042
WCDMA Band2	0.392	0.922	0.942
WCDMA Band4	0.466	0.932	0.874
WCDMA Band5	0.415	0.415	0.486
LTE Band2	0.368	0.759	0.949
LTE Band4	0.419	0.772	0.890
LTE Band7	0.050	0.371	0.845
LTE Band17	0.266	0.354	0.376
2.4G WiFi	0.158	0.335	0.325
5G WiFi	0.362	0.610	0.497

The SAR values found for the Mobile Phone are below the maximum recommended levels of 1.6 W/Kg as averaged over any 1g tissue, 4.0 W/Kg as averaged over any 10g tissue according to the ANSI C95.1-1999.

For body worn operation, this device has been tested and meets FCC RF exposure guidelines when used with any accessory that contains no metal. Use of other accessories may not ensure compliance with FCC RF exposure guidelines.

Note: Original 5G test results are obtained from the **Shenzhen BALUN Technology Co., Ltd.** Report and report No. is **BL-SZ1010024-701**.



**Table 2.2: Simultaneous SAR**

Simultaneous multi-band transmission									
Test Position		2G	3G	4G	2.4GHz		5GHz	SUM	
					BT	WiFi	WiFi	2.4GHz	5GHz
Hotspot &Body- worn 5 mm(1g)	Phantom Side	0.561	0.466	0.419	0.418	0.158	0.362	0.979	0.923
	Ground Side	0.462	0.338	0.368	0.418	0.051	0.056	0.88	0.518
Hotspot 5 mm(1g)	Left Side	0.983	0.932	0.772	0.418	0.101	-	1.401	0.983
	Right Side	0.246	0.168	0.123	0.418	0.335	0.61	0.664	0.856
	Top Side	0.03	0.126	0.015	0.418	0.007	-	0.544	0.126
	Bottom Side	-	-	-	-	-	-	-	-
Limb (10g)	Phantom Side	0.741	0.486	0.349	0.167	0.002	0.203	0.908	0.944
	Ground Side	0.392	0.332	0.333	0.167	0.034	0.052	0.559	0.444
	Left Side	1.042	0.942	0.949	0.167	0.099	-	1.209	1.042
	Right Side	0.207	0.112	0.076	0.167	0.325	0.497	0.532	0.704
	Top Side	0.024	0.016	0.008	0.167	0.004	-	0.191	0.024
	Bottom Side	-	-	-	-	-	-	-	-

According to the above table, the maximum sum of reported SAR values for GSM/WCDMA/LTE and BT/WiFi is **1.401 W/kg** (1g). GSM/WCDMA/LTE and BT/WiFi is **1.209 W/kg** (10g)

### 3. Client Information

#### 3.1. Applicant Information

Company Name: Shanghai Sunmi Technology Co.,Ltd.  
Address: Room 505, KIC Plaza, No.388 Song Hu Road, Yang Pu District, Shanghai, China  
Telephone: 86-18721763396  
Postcode: /

#### 3.2. Manufacturer Information

Company Name: Shanghai Sunmi Technology Co.,Ltd.  
Address: Room 505, KIC Plaza, No.388 Song Hu Road, Yang Pu District, Shanghai, China  
Telephone: 86-18721763396  
Postcode: /

## 4. Equipment Under Test (EUT) and Ancillary Equipment (AE)

### 4.1. About EUT

Description:	Wireless data POS System
Model name:	T5930
Operation Model(s):	GSM850/GSM900/GSM1800/GSM1900 WCDMA Band I/Band II/Band IV/Band V LTE 2/3/4/7/17/28; BT4.0;WiFi 802.11a,b,g,n,
Tx Frequency:	824.2-848.8MHz(GSM850) 1850.2-1909.8MHz (GSM1900) 1852.4-1907.6 MHz (WCDMA Band II) 1712.4-1752.6 MHz (WCDMA Band IV) 826.4-846.6MHz (WCDMA Band V) 1850.7 -1909.3 MHz (LTE Band 2) 1710.7 -1754.3 MHz (LTE Band 4) 2502.5 – 2567.5 MHz (LTE Band 7) 706.5 -713.5 MHz (LTE Band 17) 2412- 2462 MHz (WiFi) 5150~5250 MHz(U-NII-1) 5745~5825 MHz(U-NII-3) 2402 – 2480 MHz (BT)
Test device Production information:	Production unit
GPRS/EGPRS Class Mode:	B
GPRS/ EGPRS Multislot Class:	12
Device type:	Portable device
UE category:	3
Antenna type:	Inner antenna
Accessories/Body-worn configurations:	Battery
Dimensions:	215x75x55mm
Hotspot Mode:	Support
FCC ID:	2AH25V2

#### 4.2. Internal Identification of EUT used during the test

EUT ID*	SN or IMEI	HW Version	SW Version	Receive Date
N04	861741040017375	V3	ZAP1522_769_DEV_dailybuild _20181205071714_userdebug _DCC	2018-12-18

\*EUT ID: is used to identify the test sample in the lab internally.

#### 4.3. Internal Identification of AE used during the test

AE ID*	Description	Model	SN	Manufacturer
N/A	N/A	N/A	N/A	N/A

\*AE ID: is used to identify the test sample in the lab internally.

Battery using wireless charging battery cover.

## 5. TEST METHODOLOGY

### 5.1. Applicable Limit Regulations

**ANSI C95.1–1999:**IEEE Standard for Safety Levels with Respect to Human Exposure to Radio Frequency Electromagnetic Fields, 3 kHz to 300 GHz.

It specifies the maximum exposure limit of **1.6 W/kg** as averaged over any 1 gram of tissue and **4.0 W/kg** as averaged over any 10 gram of tissue for portable devices being used within 20 cm of the user in the uncontrolled environment.

### 5.2. Applicable Measurement Standards

**IEEE 1528–2013:** Recommended Practice for Determining the Peak Spatial-Average Specific Absorption Rate (SAR) in the Human Body Due to Wireless Communications Devices:

Experimental Techniques.

**KDB648474 D04 Handset SAR v01r03:**SAR Evaluation Considerations for Wireless Handsets.

**KDB248227 D01 802.11 WiFi SAR v02r02:** SAR measurement procedures for 802.112abg transmitters.

**KDB447498 D01 General RF Exposure Guidance v06:**Mobile and Portable Devices RF Exposure Procedures and Equipment Authorization Policies.

**KDB865664 D01 SAR Measurement 100 MHz to 6 GHz v01r04:**SAR Measurement Requirements for 100 MHz to 6 GHz

**KDB865664 D02 RF Exposure Reporting v01r02:**provides general reporting requirements as well as certain specific information required to support MPE and SAR compliance.

**KDB941225 D01 3G SAR Procedures v03r01:** 3G SAR Measurement Procedures.

**KDB 941225 D05 SAR for LTE Devices v02r04:** SAR Evaluation Considerations for LTE Devices

**KDB 648474 D03 Wireless Chargers Battery Cover v01r04:** Evaluation and approval considerations for handsets with specific wireless charging battery covers

**KDB941225 D06 hotspot SAR v02r01:**SAR Evaluation Procedures for Portable Devices with Wireless Router Capabilities.

NOTE: KDB is not in A2LA Scope List.

## 6. Specific Absorption Rate (SAR)

### 6.1. Introduction

SAR is related to the rate at which energy is absorbed per unit mass in an object exposed to a radio field. The SAR distribution in a biological body is complicated and is usually carried out by experimental techniques or numerical modeling. The standard recommends limits for two tiers of groups, occupational/controlled and general population/uncontrolled, based on a person's awareness and ability to exercise control over his or her exposure. In general, occupational/controlled exposure limits are higher than the limits for general population/uncontrolled.

### 6.2. SAR Definition

The SAR definition is the time derivative (rate) of the incremental energy ( $dW$ ) absorbed by (dissipated in) an incremental mass ( $dm$ ) contained in a volume element ( $dv$ ) of a given density ( $\rho$ ). The equation description is as below:

$$SAR = \frac{d}{dt} \left( \frac{dW}{dm} \right) = \frac{d}{dt} \left( \frac{dW}{\rho dv} \right)$$

SAR is expressed in units of Watts per kilogram (W/kg)

SAR measurement can be either related to the temperature elevation in tissue by

$$SAR = c \left( \frac{\delta T}{\delta t} \right)$$

Where:  $C$  is the specific heat capacity,  $\delta T$  is the temperature rise and  $\delta t$  is the exposure duration, or related to the electrical field in the tissue by

$$SAR = \frac{\sigma |E|^2}{\rho}$$

Where:  $\sigma$  is the conductivity of the tissue,  $\rho$  is the mass density of tissue and  $E$  is the RMS electrical field strength.

However for evaluating SAR of low power transmitter, electrical field measurement is typically applied.

## 7. Tissue Simulating Liquids

### 7.1. Targets for tissue simulating liquid

Table 7.1: Targets for tissue simulating liquid

Frequency(MHz)	Liquid Type	Conductivity( $\sigma$ )	$\pm 5\%$ Range	Permittivity( $\epsilon$ )	$\pm 5\%$ Range
750	Body	0.96	0.91~1.01	55.5	52.7~58.3
835	Body	0.97	0.92~1.02	55.2	52.4~58.0
1800	Body	1.52	1.44~1.60	53.3	50.6~56.0
1900	Body	1.52	1.44~1.60	53.3	50.6~56.0
2450	Body	1.95	1.85~2.05	52.7	50.1~55.3
2600	Body	2.16	2.05~2.27	52.5	50.1~55.3
5200	Body	5.30	5.04~5.57	49.0	46.6~51.5
5800	Body	6.00	5.70~6.30	48.2	45.8~50.6

## 7.2. Dielectric Performance

**Table 7.2: Dielectric Performance of Tissue Simulating Liquid**

Measurement Value						
Liquid Temperature: 22.5 °C						
Type	Frequency	Permittivity $\epsilon$	Drift (%)	Conductivity $\sigma$	Drift (%)	Test Date
Body	750 MHz	57.696	3.96%	0.915	-4.69%	2018-12-24
Body	835 MHz	56.715	2.74%	0.998	2.89%	2018-12-25
Body	1800 MHz	55.227	3.62%	1.479	-2.70%	2018-12-26
Body	1900 MHz	52.078	-2.29%	1.556	2.37%	2018-12-27
Body	2450 MHz	52.926	0.43%	1.976	1.33%	2018-12-28
Body	2600 MHz	53.660	2.21%	2.113	-2.18%	2018-12-24



## 8. System verification

### 8.1. System Setup

In the simplified setup for system evaluation, the DUT is replaced by a calibrated dipole and the power source is replaced by a continuous wave that comes from a signal generator. The calibrated dipole must be placed beneath the flat phantom section of the SAM twin phantom with the correct distance holder. The distance holder should touch the phantom surface with a light pressure at the reference marking and be oriented parallel to the long side of the phantom. The equipment setup is shown below:

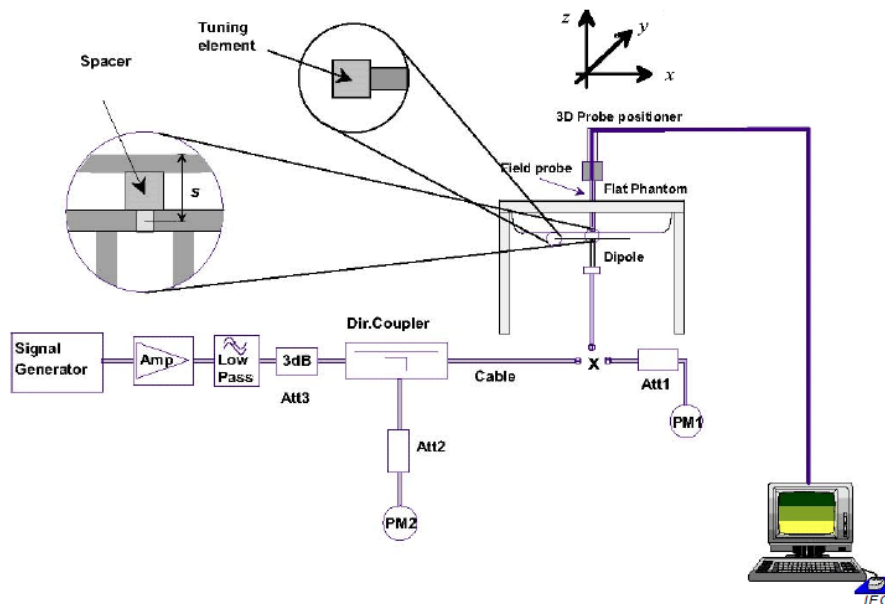

Picture 8.1 System Setup for System Evaluation



Picture 8.2 Photo of Dipole Setup

## 8.2. System Verification

SAR system verification is required to confirm measurement accuracy, according to the tissue dielectric media, probe calibration points and other system operating parameters required for measuring the SAR of test device. The system verification must be performed for each frequency band and within the valid range of each probe calibration point required for testing the device.

Table 8.1: System Verification of Body

Verification Results							
Input power level: 1W							
Frequency	Target value (W/kg)		Measured value (W/kg)		Deviation		Test date
	10 g Average	1 g Average	10 g Average	1 g Average	10 g Average	1 g Average	
750 MHz	5.7	8.55	5.68	8.44	-0.35%	-1.29%	2018-12-24
835 MHz	6.4	9.75	6.64	9.92	3.75%	1.74%	2018-12-25
1750 MHz	19.9	37.4	20.56	38.52	3.32%	2.99%	2018-12-26
1900 MHz	21.2	40.4	21.36	40	0.75%	-0.99%	2018-12-27
2450 MHz	23.5	50.5	24.44	52.8	4.00%	4.55%	2018-12-28
2600 MHz	24.1	54.3	24.8	56.8	2.90%	4.60%	2018-12-24

## 9. Measurement Procedures

### 9.1. Tests to be performed

According to the SAR test standard, the recommended procedure for assessing the peak spatial-average SAR value consists of the following steps:

- (a) Power reference measurement
- (b) Area scan
- (c) Zoom scan
- (d) Power drift measurement

The SAR measurement procedures for each of test conditions are as follows:

- (a) Make EUT to transm it maximum output power
- (b) Measure conducted output power through RF cable
- (c) Place the EUT in the specific position of phantom as Appendix D demonstrates.
- (d) Measure SAR results for Middle channel or the highest power channel on each testing position.
- (e) Measure SAR results for other channels in worst SAR testing position if the reported SAR of highest power channel is larger than 0.8 W/kg
- (f) Record the SAR value

### 9.2. General Measurement Procedure

The area and zoom scan resolutions specified in the table below must be applied to the SAR measurements and fully documented in SAR reports to qualify for TCB approval. Probe boundary effect error compensation is required for measurements with the probe tip closer than half a probe tip diameter to the phantom surface. Both the probe tip diameter and sensor offset distance must satisfy measurement protocols; to ensure probe boundary effect errors are minimized and the higher fields closest to the phantom surface can be correctly measured and extrapolated to the phantom surface for computing 1-g SAR. Tolerances of the post-processing algorithms must be verified by the test laboratory for the scan resolutions used in the SAR measurements, according to the reference distribution functions specified in IEEE Std 1528-2013. The results should be documented as part of the system validation records and may be requested to support test results when all the measurement parameters in the following table are not satisfied.

		$\leq 3$ GHz	$> 3$ GHz
Maximum distance from closest measurement point (geometric center of probe sensors) to phantom surface		$5 \text{ mm} \pm 1 \text{ mm}$	$\frac{1}{2} \cdot \delta \cdot \ln(2) \text{ mm} \pm 0.5 \text{ mm}$
Maximum probe angle from probe axis to phantom surface normal at the measurement location		$30^\circ \pm 1^\circ$	$20^\circ \pm 1^\circ$
Maximum area scan spatial resolution: $\Delta x_{Area}$ , $\Delta y_{Area}$		$\leq 2$ GHz: $\leq 15 \text{ mm}$ 2 – 3 GHz: $\leq 12 \text{ mm}$	3 – 4 GHz: $\leq 12 \text{ mm}$ 4 – 6 GHz: $\leq 10 \text{ mm}$
		When the x or y dimension of the test device, in the measurement plane orientation, is smaller than the above, the measurement resolution must be $\leq$ the corresponding x or y dimension of the test device with at least one measurement point on the test device.	
Maximum zoom scan spatial resolution: $\Delta x_{Zoom}$ , $\Delta y_{Zoom}$		$\leq 2$ GHz: $\leq 8 \text{ mm}$ 2 – 3 GHz: $\leq 5 \text{ mm}^*$	3 – 4 GHz: $\leq 5 \text{ mm}^*$ 4 – 6 GHz: $\leq 4 \text{ mm}^*$
Maximum zoom scan spatial resolution, normal to phantom surface	uniform grid: $\Delta z_{Zoom}(n)$	$\leq 5 \text{ mm}$	3 – 4 GHz: $\leq 4 \text{ mm}$ 4 – 5 GHz: $\leq 3 \text{ mm}$ 5 – 6 GHz: $\leq 2 \text{ mm}$
	graded grid	$\Delta z_{Zoom}(1)$ : between 1 <sup>st</sup> two points closest to phantom surface	$\leq 4 \text{ mm}$
		$\Delta z_{Zoom}(n>1)$ : between subsequent points	$\leq 1.5 \cdot \Delta z_{Zoom}(n-1) \text{ mm}$
Minimum zoom scan volume	x, y, z	$\geq 30 \text{ mm}$	3 – 4 GHz: $\geq 28 \text{ mm}$ 4 – 5 GHz: $\geq 25 \text{ mm}$ 5 – 6 GHz: $\geq 22 \text{ mm}$
Note: $\delta$ is the penetration depth of a plane-wave at normal incidence to the tissue medium; see IEEE Std 1528-2013 for details. * When zoom scan is required and the <i>reported</i> SAR from the <i>area scan based 1-g SAR estimation</i> procedures of KDB Publication 447498 is $\leq 1.4 \text{ W/kg}$ , $\leq 8 \text{ mm}$ , $\leq 7 \text{ mm}$ and $\leq 5 \text{ mm}$ zoom scan resolution may be applied, respectively, for 2 GHz to 3 GHz, 3 GHz to 4 GHz and 4 GHz to 6 GHz.			

### 9.3. WCDMA Measurement Procedures for SAR

The following procedures are applicable to WCDMA handsets operating under 3GPP Release99, Release 5 and Release 6. The default test configuration is to measure SAR with an established radio link between the DUT and a communication test set using a 12.2kbps RMC (reference measurement channel) configured in Test Loop Mode 1. SAR is selectively confirmed for other physical channel configurations (DPCCH & DPDCH<sub>n</sub>), HSDPA and HSPA (HSUPA/HSDPA) modes according to output power, exposure conditions and device operating capabilities. Both uplink and downlink should be configured with the same RMC or AMR, when required. SAR for Release 5 HSDPA and Release 6 HSPA are measured using the applicable FRC (fixed reference channel) and E-DCH reference channel configurations. Maximum output power is verified according to applicable versions of 3GPP TS 34.121 and SAR must be measured according to these maximum output conditions. When Maximum Power Reduction (MPR) is not implemented

according to Cubic Metric (CM) requirements for Release 6 HSPA, the following procedures do not apply.

**For Release 5 HSDPA Data Devices:**

Sub-test	$\beta_c$	$\beta_d$	$\beta_d$ (SF)	$\beta_c / \beta_d$	$\beta_{hs}$	CM/dB	MPR (dB)
1	2/15	15/15	64	2/15	4/15	1.5	0.5
2	12/15	15/15	64	12/15	24/25	2.0	1
3	15/15	8/15	64	15/8	30/15	2.0	1
4	15/15	4/15	64	15/4	30/15	2.0	1

**For Release 6 HSUPA Data Devices**

Sub-test	$\beta_c$	$\beta_d$	$\beta_d$ (SF)	$\beta_c / \beta_d$	$\beta_{hs}$	$\beta_{ec}$	$\beta_{ed}$	$\beta_{ed}$ (SF)	$\beta_{ed}$ (codes)	CM (dB)	MPR (dB)	AG Index	E-TFCI
1	11/15	15/15	64	11/15	22/15	209/225	1039/225	4	1	2.0	1.0	20	75
2	6/15	15/15	64	6/15	12/15	12/15	12/15	4	1	3.0	2.0	12	67
3	15/15	9/15	64	15/9	30/15	30/15	$\beta_{ed1}:47/15$ $\beta_{ed2}:47/15$	4	2	3.0	2.0	15	92
4	2/15	15/15	64	2/15	4/15	4/15	56/75	4	1	2.0	1.0	17	71
5	15/15	15/15	64	15/15	24/15	30/15	134/15	4	1	2.0	1.0	21	81

#### 9.4. Bluetooth & WiFi Measurement Procedures for SAR

Normal network operating configurations are not suitable for measuring the SAR of 802.11 transmitters in general. Unpredictable fluctuations in network traffic and antenna diversity conditions can introduce undesirable variations in SAR results. The SAR for these devices should be measured using chipset based test mode software to ensure that the results are consistent and reliable.

Chipset based test mode software is hardware dependent and generally varies among manufacturers. The device operating parameters established in a test mode for SAR measurements must be identical to those programmed in production units, including output power levels, amplifier gain settings and other RF performance tuning parameters. The test frequencies should correspond to actual channel frequencies defined for

domestic use. SAR for devices with switched diversity should be measured with only one antenna transmitting at a time during each SAR measurement, according to a fixed modulation and data rate. The same data pattern should be used for all measurements.

### **9.5. Power Drift**

To control the output power stability during the SAR test, DASY4 system calculates the power drift by measuring the E-field at the same location at the beginning and at the end of the measurement for each test position. These drift values can be found in Section 13 labeled as: (Power Drift [dB]). This ensures that the power drift during one measurement is within 5%.

## **10. Area Scan Based 1-g SAR**

### **10.1 Requirement of KDB**

According to the KDB447498 D01 v06, when the implementation is based the specific polynomial fit algorithm as presented at the 29th Bioelectromagnetics Society meeting (2007) and the estimated 1-g SAR is  $\leq 1.2$  W/kg, a zoom scan measurement is not required provided it is also not needed for any other purpose; for example, if the peak SAR location required for simultaneous transmission SAR test exclusion can be determined accurately by the SAR system or manually to discriminate between distinctive peaks and scattered noisy SAR distributions from area scans.

There must not be any warning or alert messages due to various measurement concerns identified by the SAR system; for example, noise in measurements, peaks too close to scan boundary, peaks are too sharp, spatial resolution and uncertainty issues etc. The SAR system verification must also demonstrate that the area scan estimated 1-g SAR is within 3% of the zoom scan 1-g SAR (See Annex B). When all the SAR results for each exposure condition in a frequency band and wireless mode are based on estimated 1-g SAR, the 1-g SAR for the highest SAR configuration must be determined by a zoom scan.

### **10.2 Fast SAR Algorithms**

The approach is based on the area scan measurement applying a frequency dependent attenuation parameter. This attenuation parameter was empirically determined by analyzing a large number of phones. The MOTOROLA FAST SAR was developed and validated by the MOTOROLA Research Group in Ft. Lauderdale.

In the initial study, an approximation algorithm based on Linear fit was developed. The accuracy of the algorithm has been demonstrated across a broad frequency range (136-2450 MHz) and for both 1- and 10-g averaged SAR using a sample of 264 SAR measurements from 55 wireless handsets. For the sample size studied, the root-mean-squared errors of the algorithm are 1.2% and 5.8% for 1- and 10-g averaged SAR, respectively. The paper describing the algorithm in detail is expected to be published in August 2004 within the Special Issue of Transactions on MTT.

In the second step, the same research group optimized the fitting algorithm to an Polynomial fit whereby the frequency validity was extended to cover the range 30-6000MHz. Details of this study can be found in the BEMS 2007 Proceedings.

Both algorithms are implemented in DASY software.

## 11. Conducted Output Power

### Manufacturing tolerance

**Table 11.1: GPRS (GMSK Modulation)**

GSM 850				
Channel		128	190	251
1 Txslots	Maximum Target Value (dBm)	32	32	32
2 Txslots	Maximum Target Value (dBm)	31.5	31.5	31.5
3 Txslots	Maximum Target Value (dBm)	30	30	30
4 Txslots	Maximum Target Value (dBm)	28.5	28.5	28.5
GSM 1900				
Channel		512	661	810
1 Txslots	Maximum Target Value (dBm)	30	30	30
2 Txslots	Maximum Target Value (dBm)	28.5	28.5	28.5
3 Txslots	Maximum Target Value (dBm)	27	27	27
4 Txslots	Maximum Target Value (dBm)	26	26	26



**Table 11.2: EGPRS (8-PSK Modulation)**

GSM 850				
Channel		128	190	251
1 Txslots	Maximum Target Value (dBm)	27	27	27
2 Txslots	Maximum Target Value (dBm)	26	26	26
3 Txslots	Maximum Target Value (dBm)	26	26	26
4 Txslots	Maximum Target Value (dBm)	26	26	26
GSM 1900				
Channel		512	661	810
1 Txslots	Maximum Target Value (dBm)	26.5	26.5	26.5
2 Txslots	Maximum Target Value (dBm)	25	25	25
3 Txslots	Maximum Target Value (dBm)	23	23	23
4 Txslots	Maximum Target Value (dBm)	22	22	22

**Table 11.3: WCDMA**

WCDMA Band II			
Channel	Channel 9262	Channel 9400	Channel 9538
Maximum Target Value (dBm)	23	23	23

WCDMA Band II HSDPA					MPR (dB)
Channel	9262	9400	9538		
1	Maximum Target Value (dBm)	22	22	22	0
2	Maximum Target Value (dBm)	22	22	22	1
3	Maximum Target Value (dBm)	21	21	21	1
4	Maximum Target Value (dBm)	21	21	21	1
WCDMA Band II HSUPA					MPR (dB)
Channel	9262	9400	9538		
1	Maximum Target Value (dBm)	21	21	21	1
2	Maximum Target Value (dBm)	21	21	21	0
3	Maximum Target Value (dBm)	21	21	21	1
4	Maximum Target Value (dBm)	21	21	21	1
5	Maximum Target Value (dBm)	21	21	21	1

**Table 11.4: WCDMA**

WCDMA Band IV			
Channel	1312	1413	1513
Maximum Target Value (dBm)	23	23	23

WCDMA Band IV <b>HSDPA</b>					MPR (dB)
Channel		1312	1413	1513	
1	Maximum Target Value (dBm)	22	22	22	1
2	Maximum Target Value (dBm)	22	22	22	1
3	Maximum Target Value (dBm)	21	21	21	1
4	Maximum Target Value (dBm)	22	22	22	1
WCDMA Band IV <b>HSUPA</b>					MPR (dB)
Channel		1312	1413	1513	
1	Maximum Target Value (dBm)	21	21	21	1
2	Maximum Target Value (dBm)	21	21	21	1
3	Maximum Target Value (dBm)	21	21	21	1
4	Maximum Target Value (dBm)	22	22	22	1
5	Maximum Target Value (dBm)	22	22	22	1

**Table 11.5: WCDMA**

WCDMA Band V			
Channel	4132	4183	4233
Maximum Target Value (dBm)	23.5	23.5	23.5

WCDMA Band V HSDPA					MPR (dB)
Channel		4132	4183	4233	
1	Maximum Target Value (dBm)	23	23	23	1
2	Maximum Target Value (dBm)	23	23	23	1
3	Maximum Target Value (dBm)	23	23	23	1
4	Maximum Target Value (dBm)	23	23	23	1
WCDMA Band V HSUPA					MPR (dB)
Channel		4132	4183	4233	
1	Maximum Target Value (dBm)	23	23	23	1
2	Maximum Target Value (dBm)	23	23	23	1
3	Maximum Target Value (dBm)	23	23	23	1
4	Maximum Target Value (dBm)	23	23	23	1
5	Maximum Target Value (dBm)	23	23	23	1

**Table 11.6: LTE**

LTE Band2			
RB Size	1	50%	100%
Maximum Target Value (dBm)	22.5	22	21.5
LTE Band4			
RB Size	1	50%	100%
Maximum Target Value (dBm)	22.5	22.5	21.5
LTE Band7			
RB Size	1	50%	100%
Maximum Target Value (dBm)	22.5	21.5	21.5
LTE Band17			
RB Size	1	50%	100%
Maximum Target Value (dBm)	23	22	22

**Table 11.7: WiFi**

WiFi 802.11b 2.4G			
Channel	Channel 1	Channel 6	Channel 11
Maximum Target Value (dBm)	15	15	15
WiFi 802.11g 2.4G			
Channel	Channel 1	Channel 6	Channel 11
Maximum Target Value (dBm)	14	15	15
WiFi 802.11n 20M 2.4G			
Channel	Channel 1	Channel 6	Channel 11
Maximum Target Value (dBm)	14	15	15

**Table 11.8: Bluetooth**

Bluetooth			
Channel	Channel 0	Channel 39	Channel 78
Maximum Target Value (dBm)	6	6	4

**Table 11.9: BLE**

Bluetooth			
Channel	Channel 0	Channel 19	Channel 39
Maximum Target Value (dBm)	6	6	4

### 11.1. GSM Measurement result

During the process of testing, the EUT was controlled via Agilent Digital Radio Communication tester (E5515C) to ensure the maximum power transmission and proper modulation. This result contains conducted output power for the EUT. In all cases, the measured peak output power should be greater and within 5% than EMI measurement.

**Table 11.10: The conducted power measurement results for GPRS/EGPRS**

GSM 850 GMSK	Measured Power (dBm)			calculation	Averaged Power (dBm)		
	128	190	251		128	190	251
1 Txslot	31.76	31.88	31.92	-9.03dB	22.73	22.85	22.89
2 Txslots	31.03	31.16	31.22	-6.02dB	25.01	25.14	25.2
3 Txslots	29.46	29.53	29.57	-4.26dB	25.2	25.27	25.31
4 Txslots	28.22	28.4	28.42	-3.01dB	25.21	25.39	<b>25.41</b>
GSM 1900 GMSK	Measured Power (dBm)			calculation	Averaged Power (dBm)		
	512	661	810		512	661	810
1 Txslot	28.74	28.89	28.94	-9.03dB	19.71	19.86	19.91
2 Txslots	27.96	28.12	28.16	-6.02dB	21.94	22.1	22.14
3 Txslots	26.21	26.42	26.51	-4.26dB	21.95	22.16	22.25
4 Txslots	25.09	25.35	25.45	-3.01dB	22.08	22.34	<b>22.44</b>

**Table 11.11: The conducted power measurement results for E-GPRS**

GSM 850 8-PSK	Measured Power (dBm)			calculation	Averaged Power (dBm)		
	128	190	251		128	190	251
1 Txslot	26.74	26.62	26.59	-9.03dB	17.71	17.59	17.56
2 Txslots	25.62	25.55	25.5	-6.02dB	19.6	19.53	19.48
3 Txslots	25.64	25.56	25.48	-4.26dB	21.38	21.3	21.22
4 Txslots	25.65	25.56	25.51	-3.01dB	<b>22.64</b>	22.55	22.5
GSM 1900 8-PSK	Measured Power (dBm)			calculation	Averaged Power (dBm)		
	512	661	810		512	661	810
1 Txslot	26.03	25.93	25.9	-9.03dB	17	16.9	16.87
2 Txslots	24.73	24.65	24.64	-6.02dB	18.71	18.63	18.62
3 Txslots	22.6	22.42	22.45	-4.26dB	18.34	18.16	18.19
4 Txslots	21.42	21.28	21.25	-3.01dB	<b>18.41</b>	18.27	18.24

## NOTES:

1) Division Factors

To average the power, the division factor is as follows:

1TX-slot = 1 transmit time slot out of 8 time slots=&gt; conducted power divided by (8/1) =&gt; -9.03dB

2TX-slots = 2 transmit time slots out of 8 time slots=&gt; conducted power divided by (8/2) =&gt; -6.02dB

3TX-slots = 3 transmit time slots out of 8 time slots=&gt; conducted power divided by (8/3) =&gt; -4.26dB

4TX-slots = 4 transmit time slots out of 8 time slots=&gt; conducted power divided by (8/4) =&gt; -3.01dB

**According to the conducted power as above, the body measurements are performed with 4Txslots for 850MHz ; 4Txslots for1900MHz;**



## 11.2. WCDMA Measurement result

Table 11.12: The conducted Power for WCDMA

Item	band	WCDMA BAND II result(dBm)		
	ARFCN	9262 (1852.4MHz)	9400 (1880.0MHz)	9538 (1907.6MHz)
WCDMA	\	22.35	22.41	22.45
HSDPA	1	21.12	21.07	21.03
	2	20.92	21.03	21.2
	3	20.58	20.58	20.64
	4	20.7	20.68	20.71
HSUPA	1	20.48	20.68	20.8
	2	20.03	20.02	20.14
	3	20.02	20.16	20.07
	4	20.83	20.86	20.98
	5	20.63	20.76	20.87
Item	band	WCDMA BAND V result(dBm)		
	ARFCN	Channel 4132 (826.4MHz)	Channel 4183 (836.6MHz)	Channel 4233 (846.6MHz)
WCDMA	\	23.27	23.29	23.28
HSDPA	1	22.06	22.06	22.03
	2	22.16	22.17	22.15
	3	22.11	22.12	22.1
	4	22.14	22.13	22.11
HSUPA	1	22.04	22.05	22.03
	2	22.26	22.26	22.26
	3	22.14	22.16	22.12
	4	22.17	22.19	22.17
	5	22.08	22.09	22.07
Item	band	WCDMA BAND IV result(dBm)		
	ARFCN	Channel 1312 (1712.4MHz)	Channel 1413 (1732.6MHz)	Channel 1513 (1752.6MHz)
WCDMA	\	22.56	22.71	22.65
HSDPA	1	21.31	21.47	21.33
	2	21.11	21.39	21.39
	3	20.84	20.98	20.94
	4	20.94	21.01	20.94
HSUPA	1	20.74	20.98	20.97
	2	20.21	20.39	20.28
	3	20.21	20.44	20.32
	4	21.14	21.21	21.2
	5	20.85	21.04	21.03

### 11.3. LTE Measurement result

**Table 11.13: The conducted Power for LTE BAND 2/4/7/17**

Band2						
Bandwidth	Mode	RB Size	RB Offset	Actual output power(dBm)		
				Channel 18607 1850.7MHz	Channel 18900 1880MHz	Channel 19193 1909.3MHz
1.4MHz	QPSK	1	0	21.69	21.75	21.73
		1	2	21.81	21.86	21.86
		1	5	21.7	21.73	21.77
		3	0	21.78	21.81	21.86
		3	1	21.83	21.89	21.9
		3	2	21.82	21.87	21.88
		6	0	20.79	20.84	20.88
	16QAM	1	0	20.99	21.06	21.03
		1	2	21.12	21.19	21.14
		1	5	20.99	21.08	21.04
		3	0	20.8	20.84	20.85
		3	1	20.9	20.91	20.94
		3	2	20.85	20.91	20.92
		6	0	19.89	19.92	19.95
Bandwidth	Mode	RB Size	RB Offset	Actual output power(dBm)		
				Channel 18615 1851.5MHz	Channel 18900 1880MHz	Channel 19185 1908.5MHz
3MHz	QPSK	1	0	21.65	21.73	21.71
		1	8	21.68	21.76	21.75
		1	14	21.63	21.73	21.74
		8	0	20.71	20.77	20.82
		8	4	20.77	20.82	20.85
		8	7	20.74	20.78	20.82
		15	0	20.72	20.76	20.81
	16QAM	1	0	21.04	21.09	21.09
		1	8	21.04	21.09	21.07
		1	15	21.03	21.1	21.06
		8	0	19.83	19.87	19.9
		8	4	19.88	19.91	19.95
		8	7	19.87	19.88	19.9
		15	0	19.78	19.83	19.86
Bandwidth	Mode	RB Size	RB Offset	Actual output power(dBm)		

				Channel 18625 1852.5MHz	Channel 18900 1880MHz	Channel 19175 1907.5MHz
5MHz	QPSK	1	0	21.59	21.63	21.66
		1	13	21.68	21.75	21.79
		1	24	21.55	21.63	21.67
		12	0	20.66	20.77	20.84
		12	6	20.79	20.84	20.86
		12	13	20.71	20.78	20.83
		25	0	20.75	20.82	20.87
	16QAM	1	0	20.88	20.88	20.89
		1	13	20.99	21.02	21.01
		1	24	20.85	20.87	20.88
		12	0	19.6	19.73	19.82
		12	6	19.72	19.79	19.85
		12	13	19.68	19.72	19.8
		25	0	19.66	19.71	19.79
Bandwidth	Mode	RB Size	RB Offset	Actual output power(dBm)		
				Channel 18650 1855MHz	Channel 18900 1880MHz	Channel 19150 1905MHz
10MHz	QPSK	1	0	21.74	21.77	21.78
		1	25	21.84	21.85	21.91
		1	49	21.67	21.75	21.76
		25	0	20.71	20.9	21.02
		25	13	20.8	20.87	20.93
		25	25	20.79	20.9	20.91
		50	0	20.75	20.93	21.02
	16QAM	1	0	21.12	21.13	21.1
		1	25	21.18	21.25	21.26
		1	49	20.97	21.12	21.09
		25	0	19.82	19.96	20.06
		25	13	19.86	19.94	19.97
		25	25	19.85	19.98	19.94
		50	0	19.83	19.99	20.02
Bandwidth	Mode	RB Size	RB Offset	Actual output power(dBm)		
				Channel 18675 1857.5MHz	Channel 18900 1880MHz	Channel 19125 1902.5MHz
15MHz	QPSK	1	0	21.72	21.73	21.77
		1	38	21.74	21.83	21.82
		1	74	21.53	21.68	21.7

		36	0	20.74	20.87	20.97	
		36	18	20.8	20.86	20.9	
		36	39	20.72	20.89	20.87	
		75	0	20.76	20.91	20.93	
	16QAM	1	0	21	21	21.03	
		1	38	20.98	21.1	21.08	
		1	74	20.75	20.93	20.95	
		36	0	19.7	19.84	19.96	
		36	18	19.76	19.85	19.89	
		36	39	19.68	19.81	19.84	
		75	0	19.69	19.82	19.91	
		Bandwidth	Mode	RB Size	RB Offset	Actual output power(dBm)	
	Channel 18700 1860MHz					Channel 18900 1880MHz	Channel 19100 1900MHz
20MHz	QPSK	1	0	21.71	21.71	21.74	
		1	50	21.96	22.01	21.98	
		1	99	21.51	21.6	21.62	
		50	0	20.82	21.06	21.1	
		50	25	21.1	21.15	21.12	
		50	50	20.81	20.98	20.86	
		100	0	20.82	21.02	21.01	
	16QAM	1	0	20.79	20.85	20.89	
		1	50	21.03	21.17	21.13	
		1	99	20.63	20.74	20.83	
		50	0	19.58	19.86	19.95	
		50	25	19.69	19.83	19.85	
		50	50	19.58	19.82	19.68	
		100	0	19.59	19.85	19.82	

Band4						
Bandwidth	Mode	RB Size	RB Offset	Actual output power(dBm)		
				Channel 19957 1710.7MHz	Channel 20175 1732.5MHz	Channel 20393 1754.3MHz
1.4MHz	QPSK	1	0	21.9	21.93	21.87
		1	2	22.04	22.04	21.98
		1	5	21.92	21.93	21.88
		3	0	21.99	22.02	21.96
		3	1	22.04	22.06	22.02
		3	2	22.05	22.06	21.98
	16QAM	6	0	21.02	21.05	20.97
		1	0	21.15	21.17	21.09
		1	2	21.31	21.25	21.21
		1	5	21.15	21.2	21.13
		3	0	20.99	21.03	20.94
		3	1	21.07	21.07	21.01
		3	2	21.02	21.04	20.99
		6	0	20.07	20.08	20.01
Bandwidth	Mode	RB Size	RB Offset	Actual output power(dBm)		
				Channel 19965 1711.5MHz	Channel 20175 1732.5MHz	Channel 20385 1753.5MHz
3MHz	QPSK	1	0	21.93	21.93	21.88
		1	8	21.94	21.92	21.88
		1	14	21.91	21.94	21.88
		8	0	20.96	20.99	20.93
		8	4	21.01	21.01	20.98
		8	7	20.97	20.96	20.9
	16QAM	15	0	20.95	20.96	20.92
		1	0	21.22	21.23	21.16
		1	8	21.23	21.2	21.15
		1	15	21.23	21.23	21.15
		8	0	20.01	20.05	19.98
		8	4	20.06	20.06	20.01
		8	7	20.06	20.02	19.98
		15	0	20.01	20	19.94
Bandwidth	Mode	RB Size	RB Offset	Actual output power(dBm)		
				Channel 19975 1712.5MHz	Channel 20175 1732.5MHz	Channel 20375 1752.5MHz

5MHz	QPSK	1	0	21.85	21.88	21.84
		1	13	21.95	21.95	21.91
		1	24	21.83	21.85	21.79
		12	0	20.9	20.96	20.91
		12	6	21	21	20.98
		12	13	20.94	20.92	20.86
		25	0	20.96	20.98	20.93
	16QAM	1	0	21.04	21.06	20.97
		1	13	21.15	21.15	21.1
		1	24	20.99	21.04	20.93
		12	0	19.82	19.92	19.86
		12	6	19.93	19.96	19.91
		12	13	19.9	19.86	19.82
		25	0	19.87	19.88	19.84
Bandwidth	Mode	RB Size	RB Offset	Actual output power(dBm)		
				Channel 20000 1715MHz	Channel 20175 1732.5MHz	Channel 20350 1750MHz
10MHz	QPSK	1	0	21.94	22.01	22.01
		1	25	22.03	22.08	22.05
		1	49	21.94	21.91	21.89
		25	0	20.96	21.07	21.01
		25	13	21.05	21.07	21.03
		25	25	21.02	21	20.95
		50	0	21.03	21.05	21
	16QAM	1	0	21.29	21.27	21.25
		1	25	21.32	21.35	21.31
		1	49	21.23	21.19	21.14
		25	0	19.98	20.08	20.01
		25	13	20.03	20.05	20.03
		25	25	20.04	19.99	19.93
		50	0	20.02	20.04	19.98
Bandwidth	Mode	RB Size	RB Offset	Actual output power(dBm)		
				Channel 20025 1717.5MHz	Channel 20175 1732.5MHz	Channel 20325 1747.5MHz
15MHz	QPSK	1	0	21.97	21.99	21.98
		1	38	22.01	22.02	21.98
		1	74	21.88	21.89	21.81
		36	0	21	21.1	21.03
		36	18	21.06	21.05	21.03
		36	39	21.01	20.99	20.96

		75	0	21.02	21.06	21
	16QAM	1	0	21.18	21.19	21.2
		1	38	21.19	21.2	21.21
		1	74	21.08	21.04	21.01
		36	0	19.93	20.03	19.97
		36	18	20	20.03	19.98
		36	39	19.99	19.95	19.93
		75	0	19.95	19.98	19.93
Bandwidth	Mode	RB Size	RB Offset	Actual output power(dBm)		
				Channel 20050 1720MHz	Channel 20175 1732.5MHz	Channel 20300 1745MHz
20MHz	QPSK	1	0	21.89	21.89	21.87
		1	50	22.17	22.18	22.13
		1	99	21.73	21.72	21.7
		50	0	21.09	21.22	21.13
		50	25	21.15	21.16	21.13
		50	50	21.06	21.07	21.06
		100	0	21.08	21.16	21.07
	16QAM	1	0	20.98	21	21.03
		1	50	21.26	21.27	21.28
		1	99	20.9	20.85	20.8
		50	0	19.91	20.08	19.99
		50	25	19.97	19.99	19.97
		50	50	19.91	19.93	19.93
		100	0	19.9	19.98	19.94

Band7						
Bandwidth	Mode	RB Size	RB Offset	Actual output power(dBm)		
				Channel 20775 2502.5MHz	Channel 21100 2535MHz	Channel 21425 2567.5MHz
5MHz	QPSK	1	0	21.82	21.84	21.85
		1	13	21.93	21.96	22.01
		1	24	21.86	21.87	21.91
		12	0	20.96	20.96	20.99
		12	6	21.02	21.01	21.05
		12	13	21.01	20.96	21.04
		25	0	21	20.99	21.04
	16QAM	1	0	21.05	21.13	21.1
		1	13	21.19	21.25	21.26
		1	24	21.08	21.17	21.14
		12	0	19.91	19.96	19.97
		12	6	19.99	20.01	20.06
		12	13	19.97	19.97	20.03
		25	0	19.94	19.96	20
Bandwidth	Mode	RB Size	RB Offset	Actual output power(dBm)		
				Channel 20800 2505MHz	Channel 21100 2535MHz	Channel 21400 2565MHz
10MHz	QPSK	1	0	21.93	21.93	21.96
		1	25	22.07	22.07	22.1
		1	49	21.97	21.97	22.02
		25	0	21.03	21.06	21.06
		25	13	21.05	21.05	21.08
		25	25	21.08	21.08	21.12
		50	0	21.08	21.08	21.11
	16QAM	1	0	21.21	21.28	21.31
		1	25	21.4	21.38	21.38
		1	49	21.33	21.33	21.3
		25	0	20.05	20.1	20.07
		25	13	20.12	20.1	20.12
		25	25	20.13	20.11	20.2
		50	0	20.09	20.11	20.11
Bandwidth	Mode	RB Size	RB Offset	Actual output power(dBm)		
				Channel 20825 2507.5MHz	Channel 21100 2535MHz	Channel 21375 2562.5MHz



15MHz	QPSK	1	0	21.88	21.9	21.92
		1	38	22.04	22.02	22.03
		1	74	21.95	21.95	22
		36	0	21.01	21	21.04
		36	18	21.05	21.05	21.08
		36	39	21.05	21.04	21.14
		75	0	21.06	21.04	21.09
	16QAM	1	0	21.12	21.18	21.19
		1	38	21.3	21.3	21.29
		1	74	21.22	21.27	21.29
		36	0	20.02	20.03	20.02
		36	18	20.07	20.06	20.11
		36	39	20.07	20.06	20.14
		75	0	20.06	20.03	20.09
Bandwidth	Mode	RB Size	RB Offset	Actual output power(dBm)		
				Channel 20850 2510MHz	Channel 21100 2535MHz	Channel 21350 2560MHz
20MHz	QPSK	1	0	21.75	21.78	21.33
		1	50	22.13	21.91	21.69
		1	99	21.88	21.36	21.38
		50	0	21.05	20.65	20.51
		50	25	21.15	21.17	20.87
		50	50	21.15	20.58	20.67
		100	0	21.08	20.58	20.62
	16QAM	1	0	20.93	21	21.01
		1	50	21.35	21.34	21.36
		1	99	21.07	21.11	21.12
		50	0	19.96	19.94	19.96
		50	25	20.05	20.04	20.06
		50	50	20.08	20	20.13
		100	0	20.03	19.97	20.04

Band 17						
Bandwidth	Mode	RB Size	RB Offset	Actual output power(dBm)		
				Channel 23755 706.5 MHz	Channel 23790 710 MHz	Channel 23825 713.5MHz
5MHz	QPSK	1	0	22.64	22.65	22.58
		1	13	22.78	22.74	22.73
		1	24	22.69	22.66	22.66
		12	0	21.73	21.72	21.81
		12	6	21.87	21.83	21.81
		12	13	21.94	21.72	21.74
		25	0	21.92	21.75	21.86
	16QAM	1	0	21.89	21.86	21.85
		1	13	22	21.94	21.97
		1	24	21.92	21.86	21.88
		12	0	20.7	20.65	20.78
		12	6	20.81	20.77	20.79
		12	13	20.89	20.68	20.68
		25	0	20.83	20.69	20.77
Bandwidth	Mode	RB Size	RB Offset	Actual output power(dBm)		
				Channel23780 709MHz	Channel23790 710 MHz	Channel23800 711 MHz
10MHz	QPSK	1	0	22.73	22.75	22.74
		1	25	22.85	22.86	22.81
		1	49	22.8	22.77	22.81
		25	0	21.71	21.69	21.73
		25	13	21.88	21.89	21.84
		25	25	21.79	21.73	21.77
		50	0	21.77	21.74	21.75
	16QAM	1	0	21.95	22.01	21.99
		1	25	22.08	22.09	22.07
		1	49	22.03	22.03	22.03
		25	0	20.7	20.66	20.71
		25	13	20.87	20.83	20.8
		25	25	20.75	20.7	20.72
		50	0	20.75	20.7	20.69

## 11.4. WiFi and BT Measurement result

**Table 11.14: The conducted power for Bluetooth**

<b>GFSK</b>			
Channel	Ch0 (2402 MHz)	Ch39 (2441MHz)	CH78 (2480MHz)
Conducted Output Power (dBm)	5.04	5.75	3.76
<b><math>\pi/4</math> DQPSK</b>			
Channel	Ch0 (2402 MHz)	Ch39 (2441MHz)	CH78 (2480MHz)
Conducted Output Power (dBm)	3.93	4.73	2.78
<b>8DPSK</b>			
Channel	Ch0 (2402 MHz)	Ch39 (2441MHz)	CH78 (2480MHz)
Conducted Output Power (dBm)	4.11	4.89	2.88

**Table 11.15: The conducted power for BLE**

<b>GFSK</b>			
Channel	Ch0 (2402 MHz)	Ch19 (2440MHz)	CH39 (2480MHz)
Conducted Output Power (dBm)	4.913	5.607	3.47

**NOTE:** According to KDB447498 D01 BT standalone SAR are not required, because maximum average output power is less than 10mW.

When the standalone SAR test exclusion is applied to an antenna that transmits simultaneously with other antennas, the standalone SAR must be estimated according to the following to determine simultaneous transmission SAR test exclusion:

(max. power of channel, including tune-up tolerance, mW)/(min. test separation distance, mm) • [ $\sqrt{f(\text{GHz})/x}$ ] W/kg for test separation distances  $\leq 50$  mm;  
 where  $x = 7.5$  for 1-g SAR, and  $x = 18.75$  for 10-g SAR.

SAR body value of BT is 0.418 W/Kg for 1g.  
 SAR body value of BT is 0.167 W/Kg for 10g

**The default power measurement procedures are:**

a) Power must be measured at each transmit antenna port according to the DSSS and OFDM transmission configurations in each standalone and aggregated frequency band.

b) Power measurement is required for the transmission mode configuration with the highest maximum output power specified for production units.

1) When the same highest maximum output power specification applies to multiple transmission modes, the largest channel bandwidth configuration with the lowest order modulation and lowest data rate is measured.

2) When the same highest maximum output power is specified for multiple largest channel bandwidth configurations with the same lowest order modulation or lowest order modulation and lowest data rate, power measurement is required for all equivalent 802.11 configurations with the same maximum output power.

c) For each transmission mode configuration, power must be measured for the highest and lowest channels; and at the mid-band channel(s) when there are at least 3 channels. For configurations with multiple mid-band channels, due to an even number of channels, both channels should be measured.

During WLAN SAR testing EUT is configured with the WLAN continuous TX tool, and the transmission duty factor was monitored on the spectrum analyzer with zero-span setting, the duty cycle is 100%.

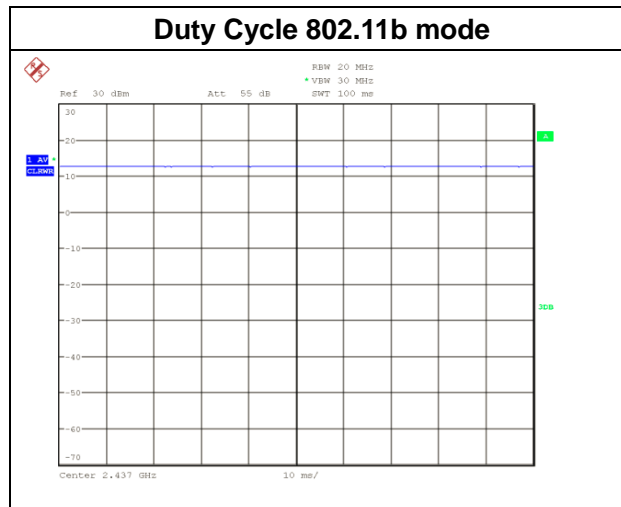

**Table 11.16: The average conducted power for WiFi**

Mode	Channel	Frequency	Average power(dBm)
802.11 b	1	2412 MHZ	14.55
	6	2437 MHZ	14.58
	11	2462 MHZ	14.65
802.11 g	1	2412 MHZ	13.75
	6	2437 MHZ	14.94
	11	2462 MHZ	14.15
802.11 n 20M	1	2412 MHZ	13.81
	6	2437 MHZ	14.03
	11	2462 MHZ	14.25

#### 2.4 GHz 802.11g/n OFDM SAR Test Exclusion Requirements

When SAR measurement is required for 2.4 GHz 802.11g/n OFDM configurations, the measurement and test reduction procedures for OFDM are applied. SAR is not required for the following 2.4 GHz OFDM conditions.

- a) When KDB Publication 447498 D01 SAR test exclusion applies to the OFDM configuration.
- b) When the highest *reported* SAR for DSSS is adjusted by the ratio of OFDM to DSSS specified maximum output power and the adjusted SAR is  $\leq 1.2$  W/kg.

## **12. Simultaneous TX SAR Considerations**

### **12.1. Introduction**

The following procedures adopted from “FCC SAR Considerations for Cell Phones with Multiple Transmitters” are applicable to handsets with built-in unlicensed transmitters such as 802.11 a/b/g and Bluetooth devices which may simultaneously transmit with the licensed transmitter.

For this device, the BT and WiFi can transmit simultaneous with other transmitters.

**12.2. Transmit Antenna Separation Distances**



**Picture 12.1 Antenna Locations**

### 12.3. Standalone SAR Test Exclusion Considerations

Standalone 1-g head or body SAR evaluation by measurement or numerical simulation is not required when the corresponding SAR Exclusion Threshold condition, listed below, is satisfied.

The 1-g SAR test exclusion threshold for 100 MHz to 6 GHz at test separation distances  $\leq$  50 mm are determined by:

$$\left[ \frac{\text{(max. power of channel, including tune-up tolerance, mW)}}{\text{(min. test separation distance, mm)}} \cdot \sqrt{f(\text{GHz})} \right] \leq 3.0$$
 for 1-g SAR, where

$$\left[ \sqrt{f(\text{GHz})} \right] \leq 3.0$$
 for 1-g SAR, where

- f(GHz) is the RF channel transmit frequency in GHz
- Power and distance are rounded to the nearest mW and mm before calculation
- The result is rounded to one decimal place for comparison

According to the KDB447498 appendix A, the SAR test exclusion threshold for 2450MHz at 5mm test separation distances is 10mW.

$$\frac{\text{(max. power of channel, including tune-up tolerance, mW)}}{\text{(min. test separation distance, mm)}} * \sqrt{\text{Frequency (GHz)}} \leq 3.0$$

Based on the above equation, Bluetooth SAR was not required:

Evaluation=1.254 < 3.0

### 12.4. SAR Measurement Positions

According to the KDB941225 D06 Hot Spot SAR v01, the edges with less than 2.5 cm distance to the antennas need to be tested for SAR.

SAR Measurement Positions						
Antenna Mode	Phantom	Ground	Left	Right	Top	Bottom
WWAN	Yes	Yes	Yes	Yes	Yes	No
WLAN	Yes	Yes	Yes	Yes	Yes	No



### 13. SAR Test Result

**Table 13.1: SAR Values (GSM 850 MHz Band-Body)**

Frequency		Mode /Band	Service /Headset	Test Position	Spacing (mm)	Figure No.	Measured average power (dBm)	Maximum allowed Power (dBm)	Scaling factor	Measured SAR(1g) (W/kg)	Reported SAR(1g) (W/kg)	Power Drift (dB)
MHz	Ch.											
Hotspot & Body worn												
836.6	190	GPRS 4TS	Class12	Toward Phantom	5	1	28.4	28.5	1.023	0.548	0.561	-0.10
836.6	190	GPRS 4TS	Class12	Toward Ground	5	/	28.4	28.5	1.023	0.451	0.462	-0.04
Hotspot												
836.6	190	GPRS 4TS	Class12	Toward Left	5	/	28.4	28.5	1.023	0.541	0.554	-0.16
836.6	190	GPRS 4TS	Class12	Toward Right	5	/	28.4	28.5	1.023	0.24	0.246	0.08
836.6	190	GPRS 4TS	Class12	Toward Top	5	/	28.4	28.5	1.023	0.029	0.030	0.01

**Table 13.2: SAR Values for Limb (GSM 850 MHz Band-Body)**

Frequency		Mode /Band	Service /Headset	Test Position	Spacing (mm)	Figure No.	Measured average power (dBm)	Maximum allowed Power (dBm)	Scaling factor	Measured SAR(10g) (W/kg)	Reported SAR(10g) (W/kg)	Power Drift (dB)
MHz	Ch.											
836.6	190	GPRS 4TS	Class12	Toward Phantom	0	2	28.4	28.5	1.023	0.724	0.741	-0.03
836.6	190	GPRS 4TS	Class12	Toward Ground	0	/	28.4	28.5	1.023	0.383	0.392	-0.06
836.6	190	GPRS 4TS	Class12	Toward Left	0	/	28.4	28.5	1.023	0.611	0.625	-0.16
836.6	190	GPRS 4TS	Class12	Toward Right	0	/	28.4	28.5	1.023	0.159	0.163	0.04
836.6	190	GPRS 4TS	Class12	Toward Top	0	/	28.4	28.5	1.023	0.023	0.024	0.05

**Table 13.3: SAR Values (GSM 1900 MHz Band-Body)**

Frequency		Mode /Band	Service /Headset	Test Position	Spacing (mm)	Figure No.	Measured average power (dBm)	Maximum allowed Power (dBm)	Scaling factor	Measured SAR(1g) (W/kg)	Reported SAR(1g) (W/kg)	Power Drift (dB)
MHz	Ch.											
<b>Hotspot &amp; Body worn</b>												
1880	661	GPRS 4TS	Class12	Toward Phantom	5	/	25.35	26	1.161	0.41	0.476	-0.03
1880	661	GPRS 4TS	Class12	Toward Ground	5	/	25.35	26	1.161	0.205	0.238	0.19
<b>Hotspot</b>												
1880	661	GPRS 4TS	Class12	Toward Left	5	/	25.35	26	1.161	0.776	0.901	0.08
1850.2	512	GPRS 4TS	Class12	Toward Left	5	3	25.09	26	1.233	0.797	0.983	-0.04
1909.8	810	GPRS 4TS	Class12	Toward Left	5	/	25.45	26	1.135	0.697	0.791	0.06
1880	661	GPRS 4TS	Class12	Toward Right	5	/	25.35	26	1.161	0.19	0.221	0.12
1880	661	GPRS 4TS	Class12	Toward Top	5	/	25.35	26	1.161	0.016	0.019	0.01
<b>Repeated</b>												
1850.2	512	GPRS 4TS	Class12	Toward Left	5	/	25.35	26	1.161	0.782	0.908	-0.03

**Table 13.4: SAR Values for Limb (GSM 1900 MHz Band-Body)**

Frequency		Mode /Band	Service /Headset	Test Position	Spacing (mm)	Figure No.	Measured average power (dBm)	Maximum allowed Power (dBm)	Scaling factor	Measured SAR(10g) (W/kg)	Reported SAR(10g) (W/kg)	Power Drift (dB)
MHz	Ch.											
1880	661	GPRS 4TS	Class12	Toward Phantom	0	/	25.35	26	1.161	0.353	0.410	-0.03
1880	661	GPRS 4TS	Class12	Toward Ground	0	/	25.35	26	1.161	0.287	0.333	0.19
1880	661	GPRS 4TS	Class12	Toward Left	0	4	25.35	26	1.161	0.897	1.042	0.08
1880	661	GPRS 4TS	Class12	Toward Right	0	/	25.35	26	1.161	0.178	0.207	0.12
1880	661	GPRS 4TS	Class12	Toward Top	0	/	25.35	26	1.161	0.012	0.014	0.01

**Table 13.5: SAR Values (WCDMA Band II-Body)**

Frequency		Mode /Band	Service /Headset	Test Position	Spacing (mm)	Figure No.	Measured average power (dBm)	Maximum allowed Power (dBm)	Scaling factor	Measured SAR(1g) (W/kg)	Reported SAR(1g) (W/kg)	Power Drift (dB)
MHz	Ch.											
<b>Hotspot &amp; Body worn</b>												
1880	9400	Band II	12.2kbps RMC	Toward Phantom	5	/	22.41	23	1.146	0.342	0.392	-0.12
1880	9400	Band II	12.2kbps RMC	Toward Ground	5	/	22.41	23	1.146	0.295	0.338	0.01
<b>Hotspot</b>												
1880	9400	Band II	12.2kbps RMC	Toward Left	5	/	22.41	23	1.146	0.765	0.876	0.03
1852.4	9262	Band II	12.2kbps RMC	Toward Left	5	/	22.35	23	1.161	0.765	0.889	0.18
1907.6	9538	Band II	12.2kbps RMC	Toward Left	5	/	22.45	23	1.135	0.69	0.783	-0.01
1880	9400	Band II	12.2kbps RMC	Toward Right	5	/	22.41	23	1.146	0.147	0.168	0.11
1880	9400	Band II	12.2kbps RMC	Toward Top	5	/	22.41	23	1.146	0.013	0.015	0.04
<b>Repeated</b>												
1852.4	9262	Band II	12.2kbps RMC	Toward Left	5	5	22.35	23	1.161	0.794	0.922	0.09

**Table 13.6: SAR Values for Limb (WCDMA Band II-Body)**

Frequency		Mode /Band	Service /Headset	Test Position	Spacing (mm)	Figure No.	Measured average power (dBm)	Maximum allowed Power (dBm)	Scaling factor	Measured SAR(10g) (W/kg)	Reported SAR(10g) (W/kg)	Power Drift (dB)
MHz	Ch.											
1880	9400	Band II	12.2kbps RMC	Toward Phantom	0	/	22.41	23	1.146	0.255	0.292	-0.1
1880	9400	Band II	12.2kbps RMC	Toward Ground	0	/	22.41	23	1.146	0.213	0.244	0.02
1880	9400	Band II	12.2kbps RMC	Toward Left	0	6	22.41	23	1.146	0.822	0.942	0.06
1880	9400	Band II	12.2kbps RMC	Toward Right	0	/	22.41	23	1.146	0.098	0.112	-0.07
1880	9400	Band II	12.2kbps RMC	Toward Top	0	/	22.41	23	1.146	0.009	0.010	0.09

**Table 13.7: SAR Values (WCDMA BandIV-Body)**

Frequency		Mode /Band	Service /Headset	Test Position	Spacing (mm)	Figure No.	Measured average power (dBm)	Maximum allowed Power (dBm)	Scaling factor	Measured SAR(1g) (W/kg)	Reported SAR(1g) (W/kg)	Power Drift (dB)
MHz	Ch.											
Hotspot & Body worn												
1732.6	1413	Band IV	12.2kbps RMC	Toward Phantom	5	/	22.71	23	1.069	0.436	0.466	-0.01
1732.6	1413	Band IV	12.2kbps RMC	Toward Ground	5	/	22.71	23	1.069	0.304	0.325	0.1
Hotspot												
1732.6	1413	Band IV	12.2kbps RMC	Toward Left	5	/	22.71	23	1.069	0.851	0.910	0.08
1712.4	1312	Band IV	12.2kbps RMC	Toward Left	5	7	22.56	23	1.107	0.842	0.932	0.02
1752.6	1512	Band IV	12.2kbps RMC	Toward Left	5	/	22.65	23	1.084	0.704	0.763	0.07
1732.6	1413	Band IV	12.2kbps RMC	Toward Right	5	/	22.71	23	1.069	0.055	0.059	0.03
1732.6	1413	Band IV	12.2kbps RMC	Toward Top	5	/	22.71	23	1.069	0.118	0.126	0.08
Repeated												
1732.6	1413	Band IV	12.2kbps RMC	Toward Left	5	/	22.71	23	1.069	0.842	0.900	0.03

**Table 13.8: SAR Values for Limb (WCDMA BandIV-Body)**

Frequency		Mode /Band	Service /Headset	Test Position	Spacing (mm)	Figure No.	Measured average power (dBm)	Maximum allowed Power (dBm)	Scaling factor	Measured SAR(10g) (W/kg)	Reported SAR(10g) (W/kg)	Power Drift (dB)
MHz	Ch.											
1732.6	1413	Band IV	12.2kbps RMC	Toward Phantom	0	/	22.71	23	1.069	0.333	0.356	-0.01
1732.6	1413	Band IV	12.2kbps RMC	Toward Ground	0	/	22.71	23	1.069	0.248	0.265	0.18
1732.6	1413	Band IV	12.2kbps RMC	Toward Left	0	8	22.71	23	1.069	0.818	0.874	0.04
1732.6	1413	Band IV	12.2kbps RMC	Toward Right	0	/	22.71	23	1.069	0.06	0.064	0.06
1732.6	1413	Band IV	12.2kbps RMC	Toward Top	0	/	22.71	23	1.069	0.008	0.009	0.1

**Table 13.9: SAR Values (WCDMA Band V-Body)**

Frequency		Mode /Band	Service /Headset	Test Position	Spacing (mm)	Figure No.	Measured average power (dBm)	Maximum allowed Power (dBm)	Scaling factor	Measured SAR(1g) (W/kg)	Reported SAR(1g) (W/kg)	Power Drift (dB)
MHz	Ch.											
<b>Hotspot &amp; Body worn</b>												
836.6	4183	Band V	12.2kbps RMC	Toward Phantom	5	9	23.29	23.5	1.050	0.395	0.415	0.01
836.6	4183	Band V	12.2kbps RMC	Toward Ground	5	/	23.29	23.5	1.050	0.281	0.295	0.11
<b>Hotspot</b>												
836.6	4183	Band V	12.2kbps RMC	Toward Left	5	/	23.29	23.5	1.050	0.218	0.229	0.03
836.6	4183	Band V	12.2kbps RMC	Toward Right	5	/	23.29	23.5	1.050	0.119	0.125	-0.05
836.6	4183	Band V	12.2kbps RMC	Toward Top	5	/	23.29	23.5	1.050	0.017	0.018	0.01

**Table 13.10: SAR Values for Limb (WCDMA Band V-Body)**

Frequency		Mode /Band	Service /Headset	Test Position	Spacing (mm)	Figure No.	Measured average power (dBm)	Maximum allowed Power (dBm)	Scaling factor	Measured SAR(10g) (W/kg)	Reported SAR(10g) (W/kg)	Power Drift (dB)
MHz	Ch.											
836.6	4183	Band V	12.2kbps RMC	Toward Phantom	0	10	23.29	23.5	1.050	0.463	0.486	-0.08
836.6	4183	Band V	12.2kbps RMC	Toward Ground	0	/	23.29	23.5	1.050	0.316	0.332	0.08
836.6	4183	Band V	12.2kbps RMC	Toward Left	0	/	23.29	23.5	1.050	0.418	0.439	0.09
836.6	4183	Band V	12.2kbps RMC	Toward Right	0	/	23.29	23.5	1.050	0.099	0.104	0.05
836.6	4183	Band V	12.2kbps RMC	Toward Top	0	/	23.29	23.5	1.050	0.015	0.016	0.03

**Table 13.11: SAR Values (LTE Band 2-Body)**

Frequency		Configuration	Test Position	Spacing (mm)	Figure No.	Measured average power (dBm)	Maximum allowed Power (dBm)	Scaling factor	Measured SAR(1g) (W/kg)	Reported SAR(1g) (W/kg)	Power Drift (dB)
MHz	Ch.										
<b>Hotspot &amp; Body worn</b>											
1880	18900	QPSK_20MHz_1RB_50 offset Middle	Toward Phantom	5	/	22.01	22.5	1.119	0.254	0.284	0.07
1880	18900	QPSK_20MHz_1RB_50 offset Middle	Toward Ground	5	/	22.01	22.5	1.119	0.329	0.368	0.09
1880	18900	QPSK_20MHz_50RB_25 offset Middle	Toward Phantom	5	/	21.15	22	1.216	0.21	0.255	0.01
1880	18900	QPSK_20MHz_50RB_25 offset Middle	Toward Ground	5	/	21.15	22	1.216	0.257	0.313	0.02
<b>Hotspot</b>											
1880	18900	QPSK_20MHz_1RB_50 offset Middle	Toward Left	5	11	22.01	22.5	1.119	0.678	0.759	0.06
1880	18900	QPSK_20MHz_1RB_50 offset Middle	Toward Right	5	/	22.01	22.5	1.119	0.11	0.123	0.02
1880	18900	QPSK_20MHz_1RB_50 offset Middle	Toward Top	5	/	22.01	22.5	1.119	0.011	0.012	0.01
1880	18900	QPSK_20MHz_50RB_25 offset Middle	Toward Left	5	/	21.15	22	1.216	0.611	0.743	0.05
1880	18900	QPSK_20MHz_50RB_25 offset Middle	Toward Right	5	/	21.15	22	1.216	0.086	0.105	-0.14
1880	18900	QPSK_20MHz_50RB_25 offset Middle	Toward Top	5	/	21.15	22	1.216	0.012	0.015	0.02

**Table 13.12: SAR Values for Limb (LTE Band 2-Body)**

Frequency		Configuration	Test Position	Spacing (mm)	Figure No.	Measured average power (dBm)	Maximum allowed Power (dBm)	Scaling factor	Measured SAR(10g) (W/kg)	Reported SAR(10g) (W/kg)	Power Drift (dB)
MHz	Ch.										
1880	18900	QPSK_20MHz_1RB_50 offset Middle	Toward Phantom	0	/	22.01	22.5	1.119	0.27	0.302	0.05
1880	18900	QPSK_20MHz_1RB_50 offset Middle	Toward Ground	0	/	22.01	22.5	1.119	0.27	0.302	0.02
1880	18900	QPSK_20MHz_1RB_50 offset Middle	Toward Left	0	12	22.01	22.5	1.119	0.848	0.949	-0.18
1880	18900	QPSK_20MHz_1RB_50 offset Middle	Toward Right	0	/	22.01	22.5	1.119	0.068	0.076	-0.09
1880	18900	QPSK_20MHz_1RB_50 offset Middle	Toward Top	0	/	22.01	22.5	1.119	0.007	0.008	0.03
1880	18900	QPSK_20MHz_50RB_25 offset Middle	Toward Phantom	0	/	21.15	22	1.216	0.217	0.264	-0.01
1880	18900	QPSK_20MHz_50RB_25 offset Middle	Toward Ground	0	/	21.15	22	1.216	0.211	0.257	-0.08
1880	18900	QPSK_20MHz_50RB_25 offset Middle	Toward Left	0	/	21.15	22	1.216	0.678	0.825	0.05
1880	18900	QPSK_20MHz_50RB_25 offset Middle	Toward Right	0	/	21.15	22	1.216	0.056	0.068	-0.05
1880	18900	QPSK_20MHz_50RB_25 offset Middle	Toward Top	0	/	21.15	22	1.216	0.006	0.007	-0.01

**Table 13.13: SAR Values (LTE Band 4-Body)**

Frequency		Configuration	Test Position	Spacing (mm)	Figure No.	Measured average power (dBm)	Maximum allowed Power (dBm)	Scaling factor	Measured SAR(1g) (W/kg)	Reported SAR(1g) (W/kg)	Power Drift (dB)
MHz	Ch.										
<b>Hotspot &amp; Body worn</b>											
1732.5	20175	QPSK_20MHz_1RB_50 offset Middle	Toward Phantom	5	/	22.18	22.5	1.076	0.378	0.407	0.06
1732.5	20175	QPSK_20MHz_1RB_50 offset Middle	Toward Ground	5	/	22.18	22.5	1.076	0.316	0.340	0.08
1732.5	20175	QPSK_20MHz_50RB_0 offset Middle	Toward Phantom	5	/	21.22	22.5	1.343	0.312	0.419	0.05
1732.5	20175	QPSK_20MHz_50RB_0 offset Middle	Toward Ground	5	/	21.22	22.5	1.343	0.265	0.356	0.11
<b>Hotspot</b>											
1732.5	20175	QPSK_20MHz_1RB_50 offset Middle	Toward Left	5	/	22.18	22.5	1.076	0.709	0.763	0.02
1732.5	20175	QPSK_20MHz_1RB_50 offset Middle	Toward Right	5	/	22.18	22.5	1.076	0.046	0.050	0.08
1732.5	20175	QPSK_20MHz_1RB_50 offset Middle	Toward Top	5	/	22.18	22.5	1.076	0.012	0.013	-0.01
1732.5	20175	QPSK_20MHz_50RB_0 offset Middle	Toward Left	5	13	21.22	22.5	1.343	0.575	0.772	0.18
1732.5	20175	QPSK_20MHz_50RB_0 offset Middle	Toward Right	5	/	21.22	22.5	1.343	0.037	0.050	0.07
1732.5	20175	QPSK_20MHz_50RB_0 offset Middle	Toward Top	5	/	21.22	22.5	1.343	0.01	0.013	0.01



**Table 13.14: SAR Values for Limb (LTE Band 4-Body)**

Frequency		Configuration	Test Position	Spacing (mm)	Figure No.	Measured average power (dBm)	Maximum allowed Power (dBm)	Scaling factor	Measured SAR(10g) (W/kg)	Reported SAR(10g) (W/kg)	Power Drift (dB)
MHz	Ch.										
1732.5	20175	QPSK_20MHz_1RB_50 offset Middle	Toward Phantom	0	/	22.18	22.5	1.076	0.285	0.307	-0.08
1732.5	20175	QPSK_20MHz_1RB_50 offset Middle	Toward Ground	0	/	22.18	22.5	1.076	0.282	0.304	0.06
1732.5	20175	QPSK_20MHz_1RB_50 offset Middle	Toward Left	0	/	22.18	22.5	1.076	0.813	0.875	0.07
1732.5	20175	QPSK_20MHz_1RB_50 offset Middle	Toward Right	0	/	22.18	22.5	1.076	0.035	0.038	0.02
1732.5	20175	QPSK_20MHz_1RB_50 offset Middle	Toward Top	0	/	22.18	22.5	1.076	0.006	0.006	0.09
1732.5	20175	QPSK_20MHz_50RB_0 offset Middle	Toward Phantom	0	/	21.22	22.5	1.343	0.26	0.349	-0.07
1732.5	20175	QPSK_20MHz_50RB_0 offset Middle	Toward Ground	0	/	21.22	22.5	1.343	0.248	0.333	0.1
1732.5	20175	QPSK_20MHz_50RB_0 offset Middle	Toward Left	0	14	21.22	22.5	1.343	0.663	0.890	0.09
1732.5	20175	QPSK_20MHz_50RB_0 offset Middle	Toward Right	0	/	21.22	22.5	1.343	0.029	0.039	-0.04
1732.5	20175	QPSK_20MHz_50RB_0 offset Middle	Toward Top	0	/	21.22	22.5	1.343	0.005	0.007	-0.03

**Table 13.15: SAR Values (LTE Band 7-Body)**

Frequency		Configuration	Test Position	Spacing (mm)	Figure No.	Measured average power (dBm)	Maximum allowed Power (dBm)	Scaling factor	Measured SAR(1g) (W/kg)	Reported SAR(1g) (W/kg)	Power Drift (dB)
MHz	Ch.										
<b>Hotspot &amp; Body worn</b>											
2535	21100	QPSK_20MHz_1RB_50 offset Middle	Toward Phantom	5	/	21.91	22.5	1.146	0.044	0.050	0.07
2535	21100	QPSK_20MHz_1RB_50 offset Middle	Toward Ground	5	/	21.91	22.5	1.146	0.015	0.017	0.01
2535	21100	QPSK_20MHz_50RB_25 offset Middle	Toward Phantom	5	/	21.17	21.5	1.079	0.033	0.036	0.06
2535	21100	QPSK_20MHz_50RB_25 offset Middle	Toward Ground	5	/	21.17	21.5	1.079	0.01	0.011	0.06
<b>Hotspot</b>											
2535	21100	QPSK_20MHz_1RB_50 offset Middle	Toward Left	5	15	21.91	22.5	1.146	0.324	0.371	-0.07
2535	21100	QPSK_20MHz_1RB_50 offset Middle	Toward Right	5	/	21.91	22.5	1.146	0.009	0.010	0.06
2535	21100	QPSK_20MHz_1RB_50 offset Middle	Toward Top	5	/	21.91	22.5	1.146	0.008	0.009	-0.01
2535	21100	QPSK_20MHz_50RB_25 offset Middle	Toward Left	5	/	21.17	21.5	1.079	0.256	0.276	-0.03
2535	21100	QPSK_20MHz_50RB_25 offset Middle	Toward Right	5	/	21.17	21.5	1.079	0.007	0.008	0.02
2535	21100	QPSK_20MHz_50RB_25 offset Middle	Toward Top	5	/	21.17	21.5	1.079	0.007	0.008	0.01

**Table 13.16: SAR Values for Limb(LTE Band 7-Body)**

Frequency		Configuration	Test Position	Spacing (mm)	Figure No.	Measured average power (dBm)	Maximum allowed Power (dBm)	Scaling factor	Measured SAR(10g) (W/kg)	Reported SAR(10g) (W/kg)	Power Drift (dB)
MHz	Ch.										
2535	21100	QPSK_20MHz_1RB_50 offset Middle	Toward Phantom	0	/	21.91	22.5	1.146	0.033	0.038	0.01
2535	21100	QPSK_20MHz_1RB_50 offset Middle	Toward Ground	0	/	21.91	22.5	1.146	0.014	0.016	0.01
2535	21100	QPSK_20MHz_1RB_50 offset Middle	Toward Left	0	16	21.91	22.5	1.146	0.738	0.845	0.08
2535	21100	QPSK_20MHz_1RB_50 offset Middle	Toward Right	0	/	21.91	22.5	1.146	0.01	0.011	0.05
2535	21100	QPSK_20MHz_1RB_50 offset Middle	Toward Top	0	/	21.91	22.5	1.146	0.004	0.005	0.02
2535	21100	QPSK_20MHz_50RB_25 offset Middle	Toward Phantom	0	/	21.17	21.5	1.079	0.025	0.027	0.06
2535	21100	QPSK_20MHz_50RB_25 offset Middle	Toward Ground	0	/	21.17	21.5	1.079	0.01	0.011	0.03
2535	21100	QPSK_20MHz_50RB_25 offset Middle	Toward Left	0	/	21.17	21.5	1.079	0.587	0.633	0.03
2535	21100	QPSK_20MHz_50RB_25 offset Middle	Toward Right	0	/	21.17	21.5	1.079	0.007	0.008	0.07
2535	21100	QPSK_20MHz_50RB_25 offset Middle	Toward Top	0	/	21.17	21.5	1.079	0.003	0.003	0.09

**Table 13.17: SAR Values (LTE Band 17-Body)**

Frequency		Configuration	Test Position	Spacing (mm)	Figure No.	Measured average power (dBm)	Maximum allowed Power (dBm)	Scaling factor	Measured SAR(1g) (W/kg)	Reported SAR(1g) (W/kg)	Power Drift (dB)
MHz	Ch.										
<b>Hotspot &amp; Body worn</b>											
710	23790	QPSK_10MHz_1RB_25 offset Middle	Toward Phantom	5	/	22.86	23	1.033	0.258	0.266	-0.03
710	23790	QPSK_10MHz_1RB_25 offset Middle	Toward Ground	5	/	22.86	23	1.033	0.037	0.038	0.02
710	23790	QPSK_10MHz_25RB_13 offset Middle	Toward Phantom	5	/	21.89	22	1.026	0.204	0.209	-0.04
710	23790	QPSK_10MHz_25RB_13 offset Middle	Toward Ground	5	/	21.89	22	1.026	0.029	0.030	0.01
<b>Hotspot</b>											
710	23790	QPSK_10MHz_1RB_25 offset Middle	Toward Left	5	17	22.86	23	1.033	0.343	0.354	0.05
710	23790	QPSK_10MHz_1RB_25 offset Middle	Toward Right	5	/	22.86	23	1.033	0.027	0.028	0.08
710	23790	QPSK_10MHz_1RB_25 offset Middle	Toward Top	5	/	22.86	23	1.033	0.004	0.004	0.04
710	23790	QPSK_10MHz_25RB_13 offset Middle	Toward Left	5	/	21.89	22	1.026	0.272	0.279	0.06
710	23790	QPSK_10MHz_25RB_13 offset Middle	Toward Right	5	/	21.89	22	1.026	0.022	0.023	-0.03
710	23790	QPSK_10MHz_25RB_13 offset Middle	Toward Top	5	/	21.89	22	1.026	0.004	0.004	0.01

**Table 13.18: SAR Values for Limb(LTE Band 17-Body)**

Frequency		Configuration	Test Position	Spacing (mm)	Figure No.	Measured average power (dBm)	Maximum allowed Power (dBm)	Scaling factor	Measured SAR(10g) (W/kg)	Reported SAR(10g) (W/kg)	Power Drift (dB)
MHz	Ch.										
710	23790	QPSK_10MHz_1RB_25 offset Middle	Toward Phantom	0	/	22.86	23	1.033	0.241	0.249	-0.01
710	23790	QPSK_10MHz_1RB_25 offset Middle	Toward Ground	0	/	22.86	23	1.033	0.036	0.037	0.02
710	23790	QPSK_10MHz_1RB_25 offset Middle	Toward Left	0	18	22.86	23	1.033	0.364	0.376	0.03
710	23790	QPSK_10MHz_1RB_25 offset Middle	Toward Right	0	/	22.86	23	1.033	0.014	0.014	0.07
710	23790	QPSK_10MHz_1RB_25 offset Middle	Toward Top	0	/	22.86	23	1.033	0.003	0.003	0.09
710	23790	QPSK_10MHz_25RB_13 offset Middle	Toward Phantom	0	/	21.89	22	1.026	0.192	0.197	-0.02
710	23790	QPSK_10MHz_25RB_13 offset Middle	Toward Ground	0	/	21.89	22	1.026	0.028	0.029	0.01
710	23790	QPSK_10MHz_25RB_13 offset Middle	Toward Left	0	/	21.89	22	1.026	0.291	0.298	0.01
710	23790	QPSK_10MHz_25RB_13 offset Middle	Toward Right	0	/	21.89	22	1.026	0.01	0.010	0.01
710	23790	QPSK_10MHz_25RB_13 offset Middle	Toward Top	0	/	21.89	22	1.026	0.002	0.002	0.05

**Table 13.19: SAR Values (WiFi 802.11b - Body)**

Frequency		Mode /Band	Service /Headset	Test Position	Spacing (mm)	Figure No.	Measured average power (dBm)	Maximum allowed Power (dBm)	Scaling factor	Measured SAR(1g) (W/kg)	Reported SAR(1g) (W/kg)	Power Drift (dB)
MHz	Ch.											
<b>Hotspot &amp; Body worn</b>												
2462	11	WiFi 2450	802.11b	Toward Phantom	5	/	14.65	15	1.084	0.146	0.158	0.09
2462	11	WiFi 2450	802.11b	Toward Ground	5	/	14.65	15	1.084	0.047	0.051	0.06
<b>Hotspot</b>												
2462	11	WiFi 2450	802.11b	Toward Left	5	/	14.65	15	1.084	0.093	0.101	0.01
2462	11	WiFi 2450	802.11b	Toward Right	5	19	14.65	15	1.084	0.309	0.335	0.06
2462	11	WiFi 2450	802.11b	Toward Top	5	/	14.65	15	1.084	0.006	0.007	0.01

**Table 13.20: SAR Values for Limb(WiFi 802.11b - Body)**

Frequency		Mode /Band	Service /Headset	Test Position	Spacing (mm)	Figure No.	Measured average power (dBm)	Maximum allowed Power (dBm)	Scaling factor	Measured SAR(10g) (W/kg)	Reported SAR(10g) (W/kg)	Power Drift (dB)
MHz	Ch.											
2462	11	WiFi 2450	802.11b	Toward Phantom	0	/	14.65	15	1.084	0.002	0.002	0.06
2462	11	WiFi 2450	802.11b	Toward Ground	0	/	14.65	15	1.084	0.031	0.034	0.05
2462	11	WiFi 2450	802.11b	Toward Left	0	/	14.65	15	1.084	0.091	0.099	0.04
2462	11	WiFi 2450	802.11b	Toward Right	0	20	14.65	15	1.084	0.3	0.325	-0.03
2462	11	WiFi 2450	802.11b	Toward Top	0	/	14.65	15	1.084	0.004	0.004	0.08

## 14. Evaluation of Simultaneous

**Table14.1 Simultaneous transmission SAR**

<b>Standalone SAR for 2G(W/Kg)</b>				
Test Position		GSM 850	GSM 1900	Highest SAR
Hotspot &Body- worn 5 mm(1g)	Phantom Side	<b>0.561</b>	<b>0.476</b>	<b>0.561</b>
	Ground Side	<b>0.462</b>	<b>0.238</b>	<b>0.462</b>
Hotspot 5 mm(1g)	Left Side	<b>0.554</b>	0.983	<b>0.983</b>
	Right Side	<b>0.246</b>	<b>0.221</b>	<b>0.246</b>
	Top Side	<b>0.03</b>	<b>0.019</b>	<b>0.03</b>
	Bottom Side	-	-	-
Limb (10g)	Phantom Side	<b>0.741</b>	<b>0.410</b>	<b>0.741</b>
	Ground Side	<b>0.392</b>	<b>0.333</b>	<b>0.392</b>
	Left Side	<b>0.625</b>	<b>1.042</b>	<b>1.042</b>
	Right Side	<b>0.163</b>	<b>0.207</b>	<b>0.207</b>
	Top Side	<b>0.024</b>	<b>0.014</b>	<b>0.024</b>
	Bottom Side	-	-	-

<b>Standalone SAR for 3G(W/Kg)</b>					
Test Position		WCDMA Band II	WCDMA Band IV	WCDMA Band V	Highest SAR
Hotspot &Body- worn 5 mm(1g)	Phantom Side	<b>0.392</b>	<b>0.466</b>	<b>0.415</b>	<b>0.466</b>
	Ground Side	<b>0.338</b>	<b>0.325</b>	<b>0.295</b>	<b>0.338</b>
Hotspot 5 mm(1g)	Left Side	<b>0.922</b>	<b>0.932</b>	<b>0.229</b>	<b>0.932</b>
	Right Side	<b>0.168</b>	<b>0.059</b>	<b>0.125</b>	<b>0.168</b>
	Top Side	<b>0.015</b>	<b>0.126</b>	<b>0.018</b>	<b>0.126</b>
	Bottom Side	-	-	-	-
Limb(10g)	Phantom Side	<b>0.292</b>	<b>0.356</b>	<b>0.486</b>	<b>0.486</b>
	Ground Side	<b>0.244</b>	<b>0.265</b>	<b>0.332</b>	<b>0.332</b>
	Left Side	<b>0.942</b>	<b>0.874</b>	<b>0.439</b>	<b>0.942</b>
	Right Side	<b>0.112</b>	<b>0.064</b>	<b>0.104</b>	<b>0.112</b>
	Top Side	<b>0.01</b>	<b>0.009</b>	<b>0.016</b>	<b>0.016</b>
	Bottom Side	-	-	-	-

Standalone SAR for 3G(W/Kg)						
Test Position		LTE Band 2	LTE Band 4	LTE Band 7	LTE Band 17	Highest SAR
Hotspot &Body- worn 5 mm(1g)	Phantom Side	0.284	0.419	0.05	0.266	0.419
	Ground Side	0.368	0.356	0.017	0.038	0.368
Hotspot 5 mm(1g)	Left Side	0.759	0.772	0.371	0.354	0.772
	Right Side	0.123	0.05	0.01	0.028	0.123
	Top Side	0.015	0.013	0.009	0.004	0.015
	Bottom Side	-	-	-	-	-
Limb(10g)	Phantom Side	0.302	0.349	0.038	0.249	0.349
	Ground Side	0.302	0.333	0.016	0.037	0.333
	Left Side	0.949	0.89	0.845	0.376	0.949
	Right Side	0.076	0.039	0.011	0.014	0.076
	Top Side	0.008	0.007	0.005	0.003	0.008
	Bottom Side	-	-	-	-	-

Simultaneous multi-band transmission									
Test Position		2G	3G	4G	2.4GHz		5GHz	SUM	
					BT	WiFi	WiFi	2.4GHz	5GHz
Hotspot &Body- worn 5 mm(1g)	Phantom Side	0.561	0.466	0.419	0.418	0.158	0.362	0.979	0.923
	Ground Side	0.462	0.338	0.368	0.418	0.051	0.056	0.88	0.518
Hotspot 5 mm(1g)	Left Side	0.983	0.932	0.772	0.418	0.101	-	1.401	0.983
	Right Side	0.246	0.168	0.123	0.418	0.335	0.61	0.664	0.856
	Top Side	0.03	0.126	0.015	0.418	0.007	-	0.544	0.126
	Bottom Side	-	-	-	-	-	-	-	-
Limb (10g)	Phantom Side	0.741	0.486	0.349	0.167	0.002	0.203	0.908	0.944
	Ground Side	0.392	0.332	0.333	0.167	0.034	0.052	0.559	0.444
	Left Side	1.042	0.942	0.949	0.167	0.099	-	1.209	1.042
	Right Side	0.207	0.112	0.076	0.167	0.325	0.497	0.532	0.704
	Top Side	0.024	0.016	0.008	0.167	0.004	-	0.191	0.024
	Bottom Side	-	-	-	-	-	-	-	-

According to the conducted power measurement result, we can draw the conclusion that: stand-alone SAR for WiFi should be performed. Then, simultaneous transmission SAR for WiFi/BT is considered with measurement results of GSM/WCDMA/LTE and WiFi/BT. According to the above table, the sum of reported SAR values for GSM/WCDMA/LTE and WiFi < 1.6W/kg. So the simultaneous transmission SAR is not required for WiFi/BT transmitter.



## 15. SAR Measurement Variability

SAR measurement variability must be assessed for each frequency band, which is determined by the SAR probe calibration point and tissue-equivalent medium used for the device measurements. When both head and body tissue-equivalent media are required for SAR measurements in a frequency band, the variability measurement procedures should be applied to the tissue medium with the highest measured SAR, using the highest measured SAR configuration for that tissue-equivalent medium.

The following procedures are applied to determine if repeated measurements are required.

- 1) Repeated measurement is not required when the original highest measured SAR is  $< 0.80$  W/kg; steps 2) through 4) do not apply.
- 2) When the original highest measured SAR is  $\geq 0.80$  W/kg, repeat that measurement once.
- 3) Perform a second repeated measurement only if the ratio of largest to smallest SAR for the original and first repeated measurements is  $> 1.20$  or when the original or repeated measurement is  $\geq 1.45$  W/kg ( $\sim 10\%$  from the 1-g SAR limit).
- 4) Perform a third repeated measurement only if the original, first or second repeated measurement is  $\geq 1.5$  W/kg and the ratio of largest to smallest SAR for the original, first and second repeated measurements is  $> 1.20$ .

**Table 15.1: SAR Measurement Variability for Body Value (1g)**

Frequency		Configuration	Test Position	Original SAR (W/kg)	First Repeated SAR (W/kg)	The Ratio
MHz	Ch.					
1850.2	512	GPRS 4TS	Toward Left	0.797	0.782	1.019
1852.4	9262	12.2kbps RMC	Toward Left	0.765	0.794	1.038
1732.6	1413	12.2kbps RMC	Toward Left	0.851	0.842	1.011

**Note:** According to the KDB 865664 D01 repeated measurement is not required when the original highest measured SAR is  $< 0.8$  W/kg.

## 16. Measurement Uncertainty

Measurement uncertainty for 750 MHz to 3 GHz averaged over 1 gram						
Uncertainty Component	Uncertainty	Prob.	Div.	$C_{i(1g)}$	Std. Unc. (1-g)	$V_i$ or $V_{eff}$
<b>Measurement System</b>						
Probe Calibration ( $k=1$ )	5.4	Normal	2	1	5.40	$\infty$
Probe Isotropy	4.70	Rectangular	$\sqrt{3}$	0.7	1.90	$\infty$
Modulation Response	2.40	Rectangular	$\sqrt{3}$	1	1.39	$\infty$
Hemispherical Isotropy	2.60	Rectangular	$\sqrt{3}$	0.7	1.05	$\infty$
Boundary Effect	1.00	Rectangular	$\sqrt{3}$	1	0.58	$\infty$
Linearity	4.70	Rectangular	$\sqrt{3}$	1	2.71	$\infty$
System Detection Limit	1.00	Rectangular	$\sqrt{3}$	1	0.58	$\infty$
Readout Electronics	0.30	Normal	1	1	0.30	$\infty$
Response Time	0.80	Rectangular	$\sqrt{3}$	1	0.46	$\infty$
Integration Time	2.60	Rectangular	$\sqrt{3}$	1	1.50	$\infty$
RF Ambient Noise	0.00	Rectangular	$\sqrt{3}$	1	0.00	$\infty$
RF Ambient Reflections	0.00	Rectangular	$\sqrt{3}$	1	0.00	$\infty$
Probe Positioner	0.40	Rectangular	$\sqrt{3}$	1	0.23	$\infty$
Probe Positioning	2.90	Rectangular	$\sqrt{3}$	1	1.67	$\infty$
Post-processing	1.00	Rectangular	$\sqrt{3}$	1	0.58	$\infty$
<b>Test sample Related</b>						
Test sample Positioning	1.2	Normal	1	1	1.2	5
Device Holder Uncertainty	3.2	Normal	1	1	3.2	71
Power drift	5	Rectangular	$\sqrt{3}$	1	2.89	$\infty$
Power Scaling	0	Rectangular	$\sqrt{3}$	1	0.00	$\infty$
<b>Phantom and Tissue Parameters</b>						
Phantom Uncertainty	4	Rectangular	$\sqrt{3}$	1	2.31	$\infty$
SAR correction	1.9	Rectangular	$\sqrt{3}$	1	1.10	$\infty$
Liquid Conductivity (meas)	4.19	Rectangular	1	0.78	3.27	$\infty$
Liquid Permittivity (meas)	4.4	Rectangular	1	0.26	1.14	$\infty$
Temp. unc. - Conductivity	0.18	Rectangular	$\sqrt{3}$	0.78	0.08	$\infty$
Temp. unc. - Permittivity	0.54	Rectangular	$\sqrt{3}$	0.23	0.07	$\infty$
<b>Combined Std. Uncertainty</b>		RSS			9.39	
<b>Expanded STD Uncertainty</b>		$k=2$			18.77%	

System check uncertainty for 750 MHz to 3 GHz averaged over 1 gram						
Uncertainty Component	Uncertainty	Prob.	Div.	$c_{i(1g)}$	Std. Unc. (1-g)	$V_i$ or $V_{eff}$
<b>Measurement System</b>						
Probe Calibration ( $k=1$ )	5.40	Normal	1	1	5.40	$\infty$
Probe Isotropy	4.70	Rectangular	$\sqrt{3}$	0.7	1.90	$\infty$
Modulation Response	2.40	Rectangular	$\sqrt{3}$	1	1.39	$\infty$
Hemispherical Isotropy	2.60	Rectangular	$\sqrt{3}$	0.7	1.05	$\infty$
Boundary Effect	1.00	Rectangular	$\sqrt{3}$	1	0.58	$\infty$
Linearity	4.70	Rectangular	$\sqrt{3}$	1	2.71	$\infty$
System Detection Limit	1.00	Rectangular	$\sqrt{3}$	1	0.58	$\infty$
Readout Electronics	0.30	Normal	1	1	0.30	$\infty$
Response Time	0.80	Rectangular	$\sqrt{3}$	1	0.46	$\infty$
Integration Time	2.60	Rectangular	$\sqrt{3}$	1	1.50	$\infty$
RF Ambient Noise	0.00	Rectangular	$\sqrt{3}$	1	0.00	$\infty$
RF Ambient Reflections	0.00	Rectangular	$\sqrt{3}$	1	0.00	$\infty$
Probe Positioner	0.40	Rectangular	$\sqrt{3}$	1	0.23	$\infty$
Probe Positioning	2.90	Rectangular	$\sqrt{3}$	1	1.67	$\infty$
Post-processing	1.00	Rectangular	$\sqrt{3}$	1	0.58	$\infty$
<b>Field source</b>						
Deviation of the experimental source from numerical source	5.5	Normal	1	1	5.5	$\infty$
Source to liquid distance	2	Rectangular	$\sqrt{3}$	1	1.15	$\infty$
Power drift	5	Rectangular	$\sqrt{3}$	1	2.89	$\infty$
<b>Phantom and Tissue Parameters</b>						
Phantom Uncertainty	4	Rectangular	$\sqrt{3}$	1	2.31	$\infty$
SAR correction	1.9	Rectangular	$\sqrt{3}$	1	1.10	$\infty$
Liquid Conductivity (meas)	4.19	Normal	1	0.78	3.27	$\infty$
Liquid Permittivity (meas)	4.4	Normal	1	0.26	1.14	$\infty$
Temp. unc. - Conductivity	0.18	Rectangular	$\sqrt{3}$	0.78	0.08	$\infty$
Temp. unc. - Permittivity	0.54	Rectangular	$\sqrt{3}$	0.23	0.07	$\infty$
<b>Combined Std. Uncertainty</b>		RSS			10.39	
<b>Expanded STD Uncertainty</b>		$k=2$			20.79%	

## 17. Main Test Instrument

**Table 17.1: List of Main Instruments**

No.	Name	Type	Serial Number	Calibration Date	Valid Period
01	Network analyzer	N5242A	MY51221755	Dec 17, 2018	1 year
02	Power meter	NRVD	102257	May 11, 2018	1 year
03	Power sensor	NRV-Z5	100241		
			100644		
04	Signal Generator	E4438C	MY49072044	May 11, 2018	1 Year
05	Amplifier	NTWPA-0086010F	12023024	No Calibration Requested	
06	Coupler	778D	MY4825551	May 11, 2018	1 year
07	BTS	E5515C	MY50266468	Dec 17, 2018	1 year
08	BTS	MT8820C	6201240338	May 11, 2018	1 year
09	E-field Probe	ES3DV3	3252	Sep 4,2018	1 year
10	DAE	SPEAG DAE4	1244	Dec 3,2018	1 year
11	Dipole Validation Kit	SPEAG D750V3	1144	Oct 26,2018	3 year
		SPEAG D835V2	4d112	Oct 25, 2018	3 year
		SPEAG D1750V2	1044	Oct 31, 2018	3 year
		SPEAG D1900V2	5d151	Dec 6,2017	3 year
		SPEAG D2450V2	858	Oct 26,2018	3 year
		SPEAG D2600V2	1031	Nov 1,2018	3 year

## ANNEX A. Highest SAR GRAPH RESULTS

### Fig.1 GPRS850 4TS Phantom Mode Middle

Date/Time: 2018/12/25

Electronics: DAE4 Sn1244

Medium parameters used:  $f = 837$  MHz;  $\sigma = 1.001$  S/m;  $\epsilon_r = 56.695$ ;  $\rho = 1000$  kg/m<sup>3</sup>

Ambient Temperature: 22.5 °C      Liquid Temperature: 22.5 °C

Communication System: GSM 850MHz GPRS 4TS (0);      Frequency: 836.6 MHz; Duty Cycle: 1:2

Probe: ES3DV3 - SN3252ConvF(6.34, 6.34, 6.34); Calibrated: 9/4/2018

#### GPRS850 4TS Phantom Mode Middle/Area Scan (61x111x1):

Measurement grid: dx=10 mm, dy=10 mm

Maximum value of SAR (Measurement) = 0.602 W/kg

#### GPRS850 4TS Phantom Mode Middle/Zoom Scan (7x7x7)/Cube 0:

Measurement grid: dx=5mm, dy=5mm, dz=5mm

Reference Value = 20.09 V/m; Power Drift = -0.10 dB

Peak SAR (extrapolated) = 0.760 W/kg

SAR(1 g) = 0.548 W/kg; SAR(10 g) = 0.369 W/kg

Maximum value of SAR (measured) = 0.584 W/kg

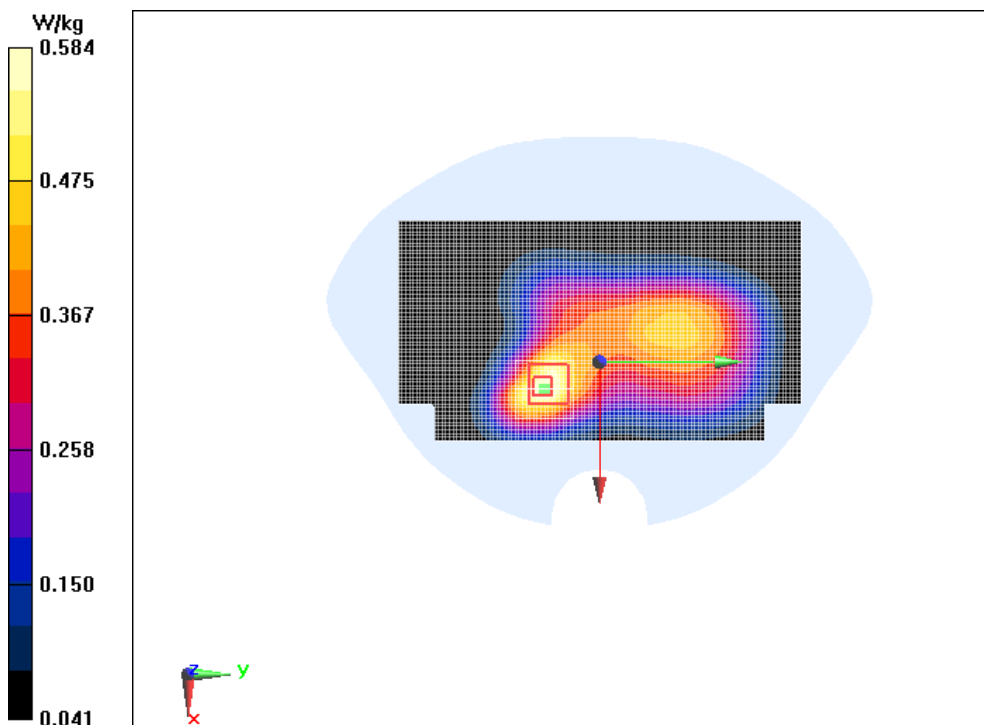

**Fig.2 GPRS850 4TS Phantom Mode Middle**

Date/Time: 2018/12/25

Electronics: DAE4 Sn1244

Medium parameters used:  $f = 837 \text{ MHz}$ ;  $\sigma = 1.001 \text{ S/m}$ ;  $\epsilon_r = 56.695$ ;  $\rho = 1000 \text{ kg/m}^3$

Ambient Temperature:  $22.5 \text{ }^\circ\text{C}$       Liquid Temperature:  $22.5 \text{ }^\circ\text{C}$

Communication System: GSM 850MHz GPRS 4TS (0);    Frequency:  $836.6 \text{ MHz}$ ; Duty Cycle: 1:2

Probe: ES3DV3 - SN3252ConvF(6.34, 6.34, 6.34); Calibrated: 9/4/2018

**GPRS850 4TS Phantom Mode Middle/Area Scan (61x111x1):**

Measurement grid:  $dx=10 \text{ mm}$ ,  $dy=10 \text{ mm}$

Maximum value of SAR (Measurement) =  $1.25 \text{ W/kg}$

**GPRS850 4TS Phantom Mode Middle/Zoom Scan (7x7x7)/Cube 0:**

Measurement grid:  $dx=5\text{mm}$ ,  $dy=5\text{mm}$ ,  $dz=5\text{mm}$

Reference Value =  $20.84 \text{ V/m}$ ; Power Drift =  $-0.03 \text{ dB}$

Peak SAR (extrapolated) =  $1.58 \text{ W/kg}$

SAR(1 g) =  $1.1 \text{ W/kg}$ ; SAR(10 g) =  $0.724 \text{ W/kg}$

Maximum value of SAR (measured) =  $1.19 \text{ W/kg}$

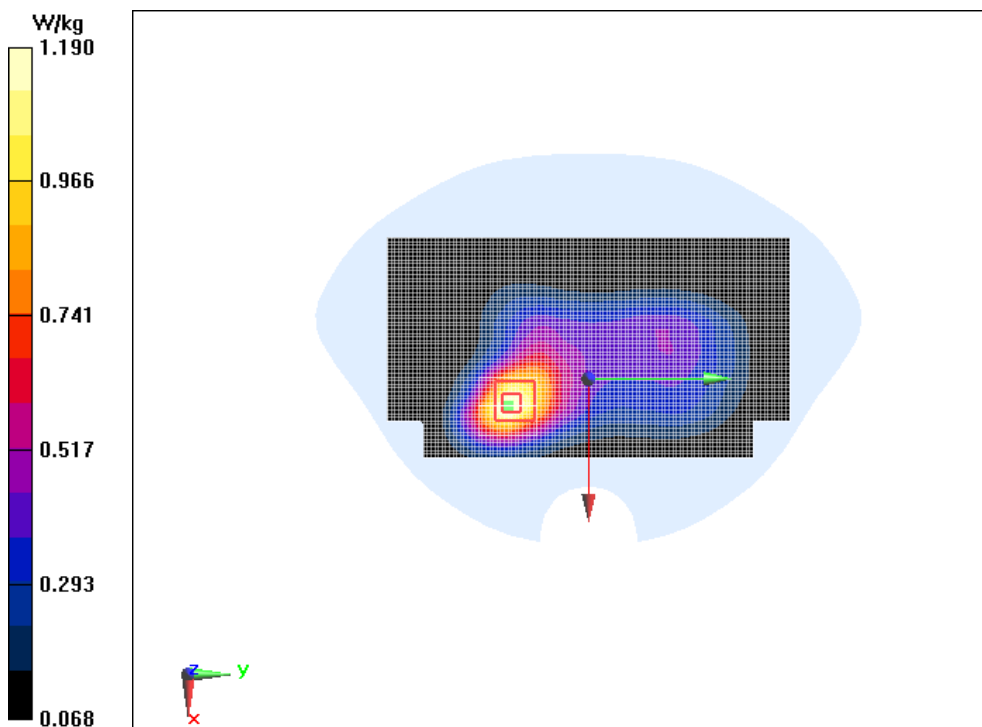

### Fig.3 GPRS1900 4TS Left Mode Low

Date/Time: 2018/12/27

Electronics: DAE4 Sn1244

Medium parameters used (interpolated):  $f = 1850.2$  MHz;  $\sigma = 1.505$  S/m;  $\epsilon_r = 52.242$ ;  $\rho = 1000$  kg/m<sup>3</sup>

Ambient Temperature: 22.5 °C      Liquid Temperature: 22.5 °C

Communication System: GSM 1900MHz GPRS 4TS (0);    Frequency: 1850.2 MHz; Duty Cycle: 1:2

Probe: ES3DV3 - SN3252ConvF(4.77, 4.77, 4.77); Calibrated: 9/4/2018

#### GPRS 4TS Left Mode Low/Area Scan (31x101x1):

Measurement grid: dx=10 mm, dy=10 mm

Maximum value of SAR (Measurement) = 0.881 W/kg

#### GPRS 4TS Left Mode Low/Zoom Scan (7x7x7)/Cube 0:

Measurement grid: dx=5mm, dy=5mm, dz=5mm

Reference Value = 15.98 V/m; Power Drift = -0.04 dB

Peak SAR (extrapolated) = 1.26 W/kg

SAR(1 g) = 0.797 W/kg; SAR(10 g) = 0.475 W/kg

Maximum value of SAR (measured) = 0.872 W/kg

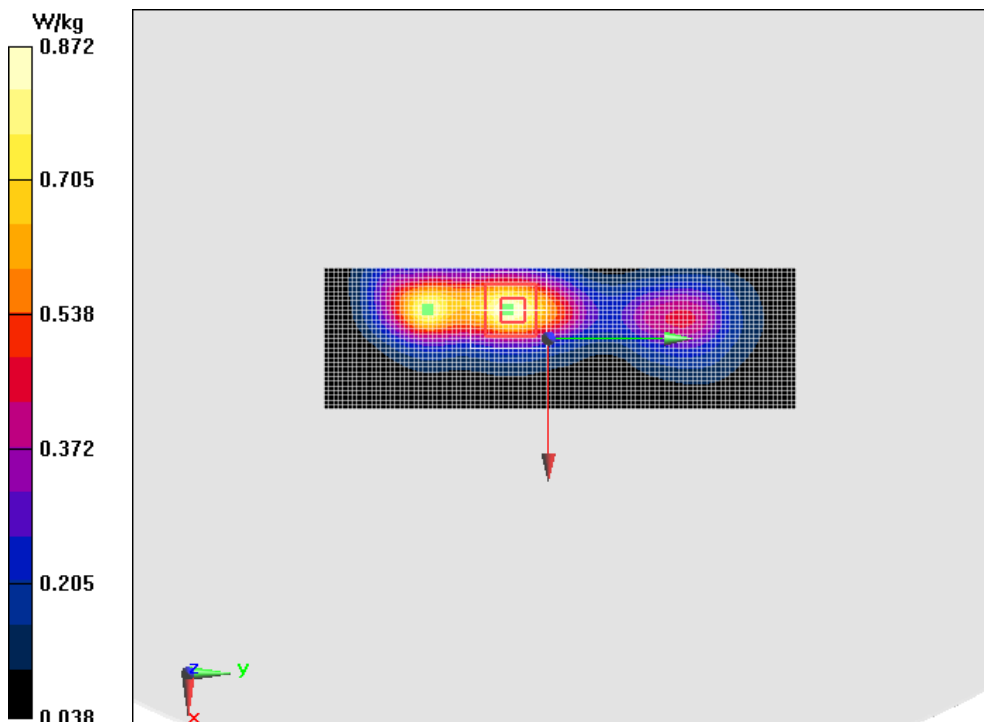

**Fig.4 GPRS1900 4TS Left Mode Middle**

Date/Time: 2018/12/27

Electronics: DAE4 Sn1244

Medium parameters used:  $f = 1880$  MHz;  $\sigma = 1.536$  S/m;  $\epsilon_r = 52.147$ ;  $\rho = 1000$  kg/m<sup>3</sup>

Ambient Temperature: 22.5 °C      Liquid Temperature: 22.5 °C

Communication System: GSM 1900MHz GPRS 4TS (0);    Frequency: 1880 MHz; Duty Cycle: 1:2

Probe: ES3DV3 - SN3252ConvF(4.77, 4.77, 4.77); Calibrated: 9/4/2018

**GPRS 4TS Left Mode Middle/Area Scan (31x101x1):**

Measurement grid: dx=10 mm, dy=10 mm

Maximum value of SAR (Measurement) = 1.81 W/kg

**GPRS 4TS Left Mode Middle/Zoom Scan (7x7x7)/Cube 0:**

Measurement grid: dx=5mm, dy=5mm, dz=5mm

Reference Value = 23.07 V/m; Power Drift = 0.08 dB

Peak SAR (extrapolated) = 3.79 W/kg

SAR(1 g) = 1.79 W/kg; SAR(10 g) = 0.897 W/kg

Maximum value of SAR (measured) = 1.98 W/kg

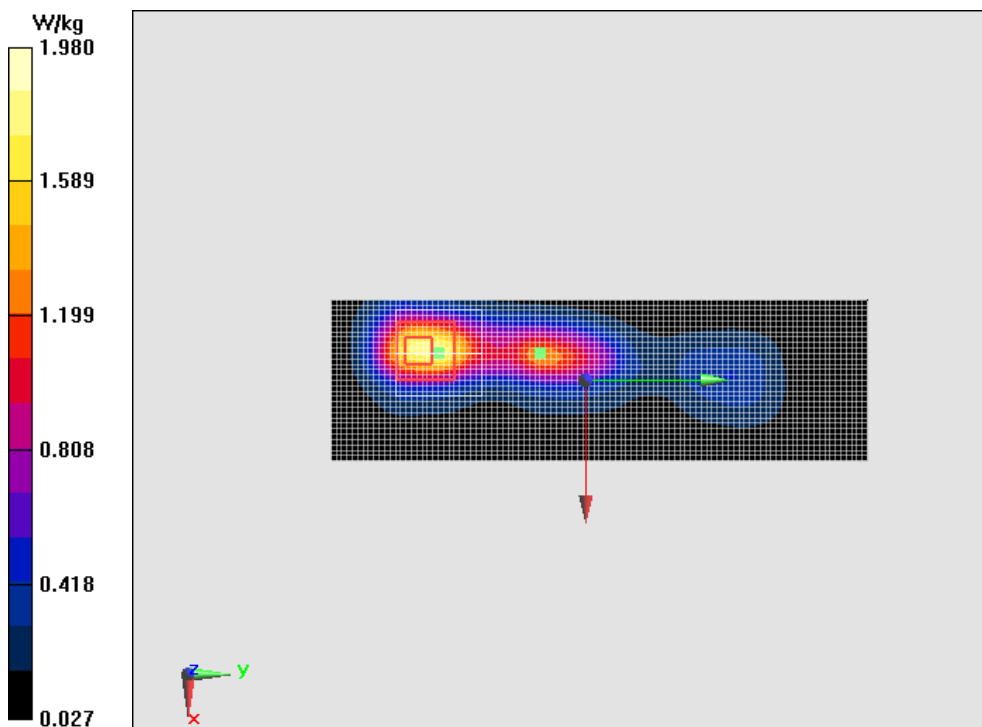



### Fig.5 WCDMA Band 2 Left Mode Low Repeated

Date/Time: 2018/12/27

Electronics: DAE4 Sn1244

Medium parameters used (interpolated):  $f = 1852.4$  MHz;  $\sigma = 1.507$  S/m;  $\epsilon_r = 52.235$ ;  $\rho = 1000$  kg/m<sup>3</sup>

Ambient Temperature: 22.5 °C      Liquid Temperature: 22.5 °C

Communication System: WCDMA Professional Band II ; Frequency: 1852.4 MHz; Duty Cycle: 1:1

Probe: ES3DV3 - SN3252ConvF(4.77, 4.77, 4.77); Calibrated: 9/4/2018

#### WCDMA Band 2 Left Mode Low Repeated/Area Scan (41x111x1):

Measurement grid: dx=10 mm, dy=10 mm

Maximum value of SAR (Measurement) = 0.832 W/kg

#### WCDMA Band 2 Left Mode Low Repeated/Zoom Scan (7x7x7)/Cube 0:

Measurement grid: dx=5mm, dy=5mm, dz=5mm

Reference Value = 19.66 V/m; Power Drift = 0.09 dB

Peak SAR (extrapolated) = 1.29 W/kg

SAR(1 g) = 0.794 W/kg; SAR(10 g) = 0.468 W/kg

Maximum value of SAR (measured) = 0.865 W/kg

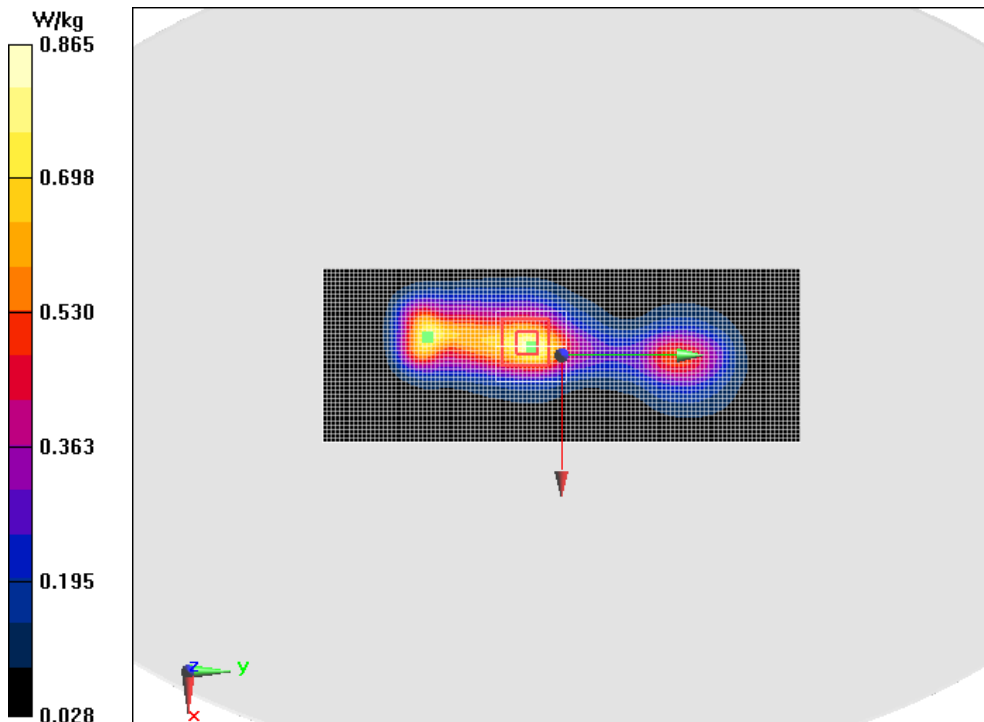

**Fig.6 WCDMA Band 2 Left Mode Middle**

Date/Time: 2018/12/27

Electronics: DAE4 Sn1244

Medium parameters used:  $f = 1880$  MHz;  $\sigma = 1.536$  S/m;  $\epsilon_r = 52.147$ ;  $\rho = 1000$  kg/m<sup>3</sup>

Ambient Temperature: 22.5 °C      Liquid Temperature: 22.5 °C

Communication System: WCDMA Professional Band II; Frequency: 1880 MHz; Duty Cycle: 1:1

Probe: ES3DV3 - SN3252ConvF(4.77, 4.77, 4.77); Calibrated: 9/4/2018

**WCDMA Band 2 Left Mode Middle/Area Scan (41x111x1):**

Measurement grid: dx=10 mm, dy=10 mm

Maximum value of SAR (Measurement) = 1.81 W/kg

**WCDMA Band 2 Left Mode Middle/Zoom Scan (7x7x7)/Cube 0:**

Measurement grid: dx=5mm, dy=5mm, dz=5mm

Reference Value = 22.22 V/m; Power Drift = 0.06 dB

Peak SAR (extrapolated) = 3.92 W/kg

SAR(1 g) = 1.77 W/kg; SAR(10 g) = 0.822 W/kg

Maximum value of SAR (measured) = 2.00 W/kg

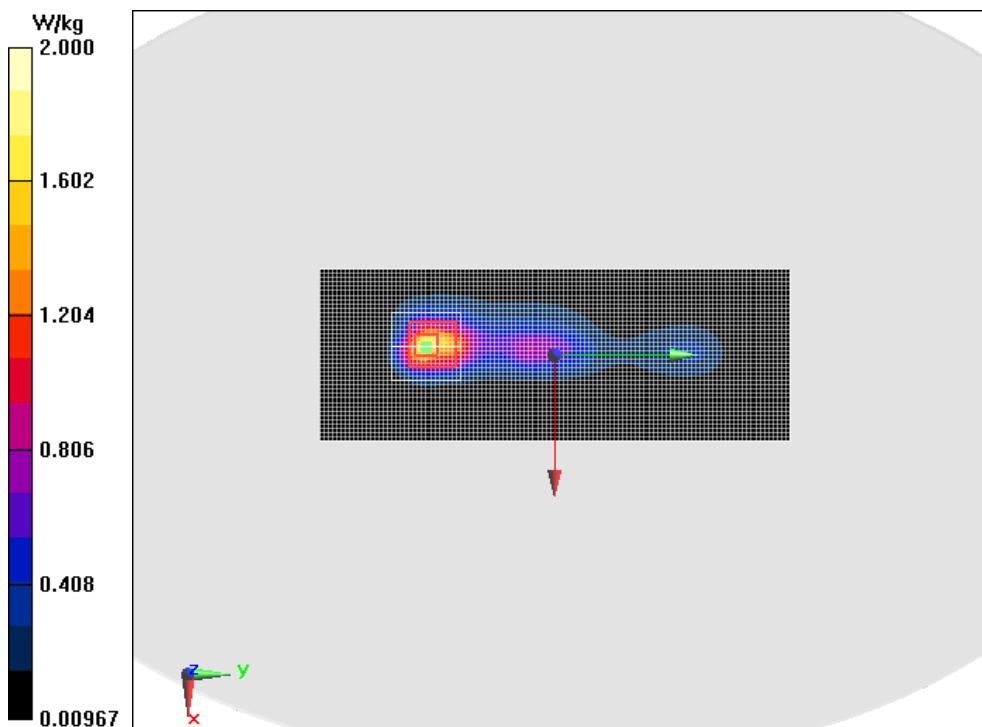

**Fig.7 WCDMA Band 4 left Mode Middle REpeated**

Date/Time: 2018/12/26

Electronics: DAE4 Sn1244

Medium parameters used:  $f = 1733$  MHz;  $\sigma = 1.408$  S/m;  $\epsilon_r = 55.442$ ;  $\rho = 1000$  kg/m<sup>3</sup>

Ambient Temperature: 22.5 °C      Liquid Temperature: 22.5 °C

Communication System: WCDMA Professional 1800MHz;    Frequency: 1732.6 MHz; Duty Cycle: 1:1

Probe: ES3DV3 - SN3252ConvF(4.99, 4.99, 4.99); Calibrated: 9/4/2018

**WCDMA Band 4 left Mode Middle REpeated/Area Scan (41x111x1):**

Measurement grid: dx=10 mm, dy=10 mm

Maximum value of SAR (Measurement) = 0.871 W/kg

**WCDMA Band 4 left Mode Middle REpeated/Zoom Scan (7x7x7)/Cube 0:**

Measurement grid: dx=5mm, dy=5mm, dz=5mm

Reference Value = 18.51 V/m; Power Drift = 0.02 dB

Peak SAR (extrapolated) = 1.30 W/kg

SAR(1 g) = 0.842 W/kg; SAR(10 g) = 0.527 W/kg

Maximum value of SAR (measured) = 0.911 W/kg

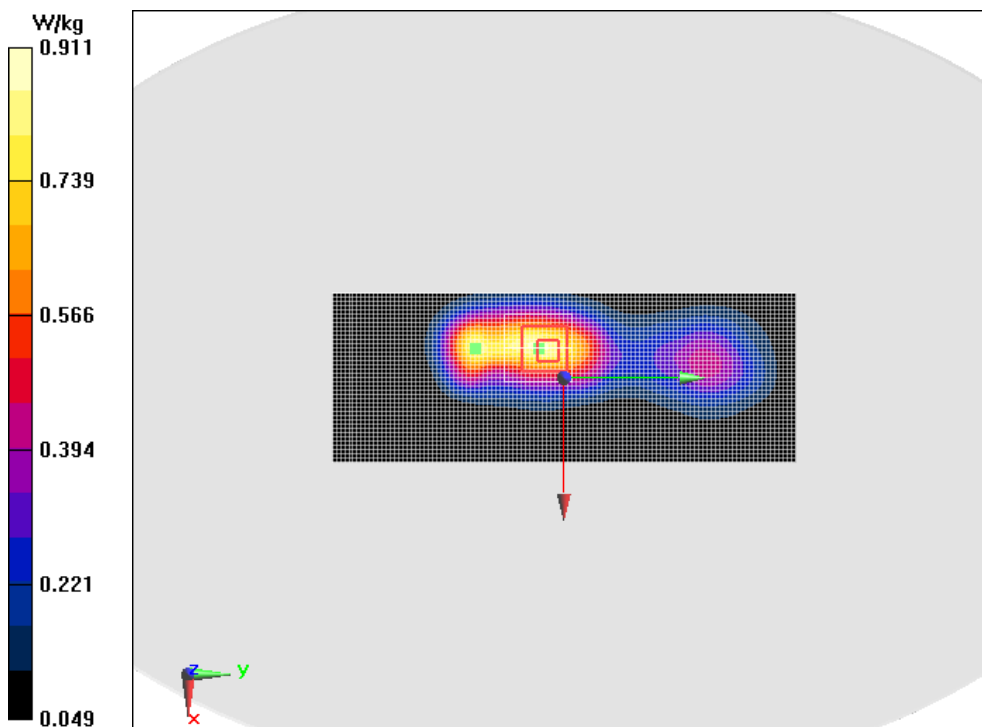

**Fig.8 WCDMA Band 4 left Mode Middle**

Date/Time: 2018/12/26

Electronics: DAE4 Sn1244

Medium parameters used:  $f = 1733 \text{ MHz}$ ;  $\sigma = 1.408 \text{ S/m}$ ;  $\epsilon_r = 55.442$ ;  $\rho = 1000 \text{ kg/m}^3$

Ambient Temperature:  $22.5 \text{ }^\circ\text{C}$       Liquid Temperature:  $22.5 \text{ }^\circ\text{C}$

Communication System: WCDMA Professional 1800MHz;    Frequency:  $1732.6 \text{ MHz}$ ; Duty Cycle: 1:1

Probe: ES3DV3 - SN3252ConvF(4.99, 4.99, 4.99); Calibrated: 9/4/2018

**WCDMA Band 4 left Mode Middle/Area Scan (41x111x1):**

Measurement grid:  $dx=10 \text{ mm}$ ,  $dy=10 \text{ mm}$

Maximum value of SAR (Measurement) =  $2.23 \text{ W/kg}$

**WCDMA Band 4 left Mode Middle/Zoom Scan (7x7x7)/Cube 0:**

Measurement grid:  $dx=5\text{mm}$ ,  $dy=5\text{mm}$ ,  $dz=5\text{mm}$

Reference Value =  $24.79 \text{ V/m}$ ; Power Drift =  $0.04 \text{ dB}$

Peak SAR (extrapolated) =  $3.44 \text{ W/kg}$

SAR(1 g) =  $1.65 \text{ W/kg}$ ; SAR(10 g) =  $0.818 \text{ W/kg}$

Maximum value of SAR (measured) =  $1.82 \text{ W/kg}$

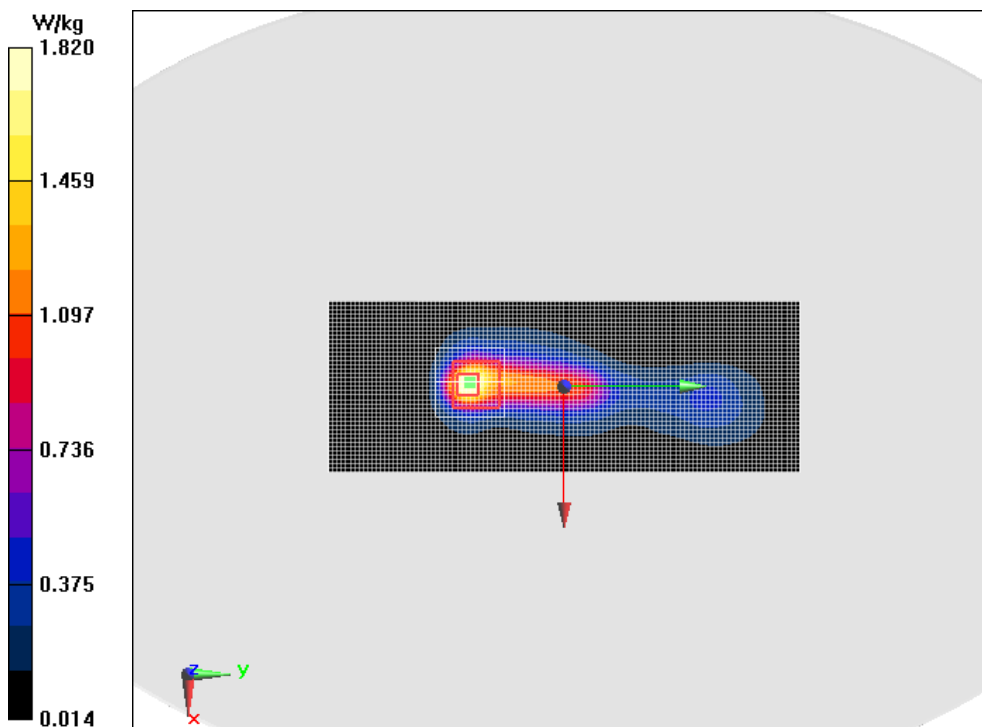

**Fig.9 WCDMA Band 5 Phantom Mode Middle**

Date/Time: 2018/12/25

Electronics: DAE4 Sn1244

Medium parameters used:  $f = 837 \text{ MHz}$ ;  $\sigma = 1.001 \text{ S/m}$ ;  $\epsilon_r = 56.695$ ;  $\rho = 1000 \text{ kg/m}^3$

Ambient Temperature:  $22.5 \text{ }^\circ\text{C}$       Liquid Temperature:  $22.5 \text{ }^\circ\text{C}$

Communication System: WCDMA Professional Band V ; Frequency:  $836.6 \text{ MHz}$ ; Duty Cycle: 1:1

Probe: ES3DV3 - SN3252ConvF(6.34, 6.34, 6.34); Calibrated: 9/4/2018

**WCDMA Band 5 Phantom Mode Middle/Area Scan (61x111x1):**

Measurement grid:  $dx=10 \text{ mm}$ ,  $dy=10 \text{ mm}$

Maximum value of SAR (Measurement) =  $0.432 \text{ W/kg}$

**WCDMA Band 5 Phantom Mode Middle/Zoom Scan (7x7x7)/Cube 0:**

Measurement grid:  $dx=5\text{mm}$ ,  $dy=5\text{mm}$ ,  $dz=5\text{mm}$

Reference Value =  $15.26 \text{ V/m}$ ; Power Drift =  $0.01 \text{ dB}$

Peak SAR (extrapolated) =  $0.548 \text{ W/kg}$

SAR(1 g) =  $0.395 \text{ W/kg}$ ; SAR(10 g) =  $0.265 \text{ W/kg}$

Maximum value of SAR (measured) =  $0.423 \text{ W/kg}$

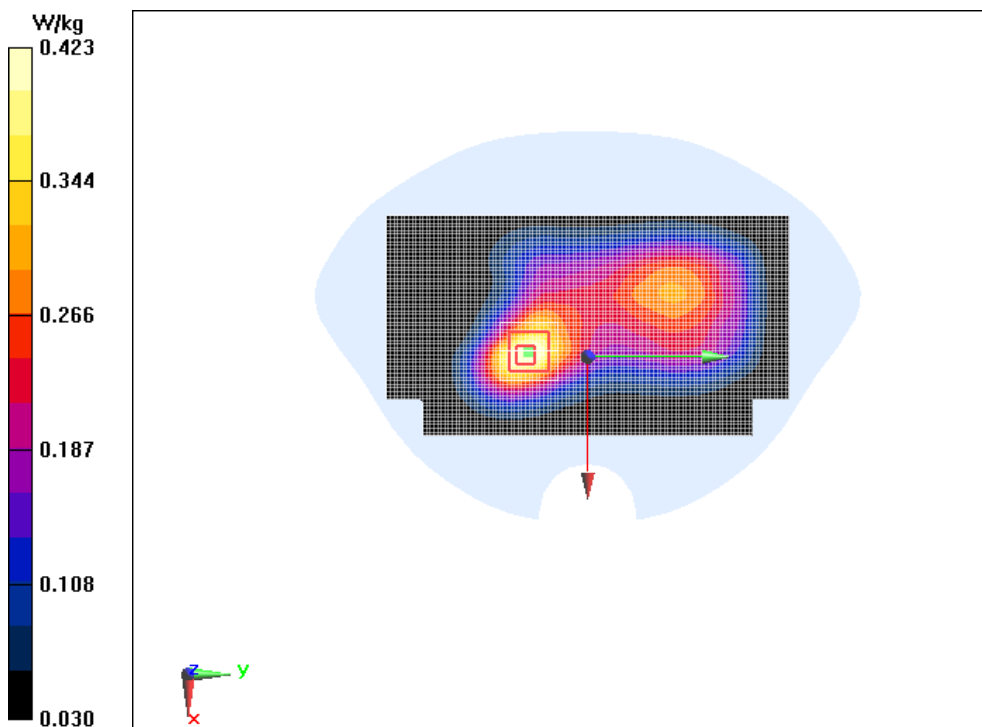

**Fig.10 WCDMA Band 5 Phantom Mode Middle**

Date/Time: 2018/12/25

Electronics: DAE4 Sn1244

Medium parameters used:  $f = 837 \text{ MHz}$ ;  $\sigma = 1.001 \text{ S/m}$ ;  $\epsilon_r = 56.695$ ;  $\rho = 1000 \text{ kg/m}^3$

Ambient Temperature:  $22.5 \text{ }^\circ\text{C}$       Liquid Temperature:  $22.5 \text{ }^\circ\text{C}$

Communication System: WCDMA Professional Band V ; Frequency:  $836.6 \text{ MHz}$ ; Duty Cycle: 1:1

Probe: ES3DV3 - SN3252ConvF(6.34, 6.34, 6.34); Calibrated: 9/4/2018

**WCDMA Band 5 Phantom Mode Middle/Area Scan (61x111x1):**

Measurement grid:  $dx=10 \text{ mm}$ ,  $dy=10 \text{ mm}$

Maximum value of SAR (Measurement) =  $0.771 \text{ W/kg}$

**WCDMA Band 5 Phantom Mode Middle/Zoom Scan (7x7x7)/Cube 0:**

Measurement grid:  $dx=5\text{mm}$ ,  $dy=5\text{mm}$ ,  $dz=5\text{mm}$

Reference Value =  $17.97 \text{ V/m}$ ; Power Drift =  $-0.08 \text{ dB}$

Peak SAR (extrapolated) =  $1.02 \text{ W/kg}$

SAR(1 g) =  $0.710 \text{ W/kg}$ ; SAR(10 g) =  $0.463 \text{ W/kg}$

Maximum value of SAR (measured) =  $0.770 \text{ W/kg}$

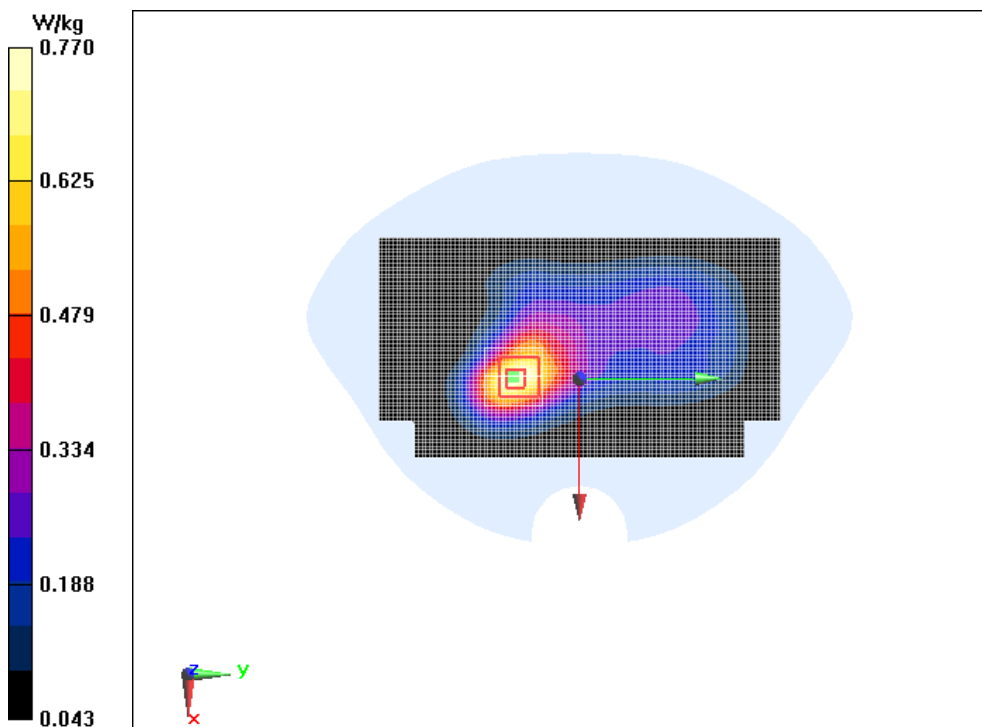

**Fig.11 LTE Band 2 20Mhz 1RB 50 left Mode Middle**

Date/Time: 2018/12/27

Electronics: DAE4 Sn1244

Medium parameters used:  $f = 1880 \text{ MHz}$ ;  $\sigma = 1.536 \text{ S/m}$ ;  $\epsilon_r = 52.147$ ;  $\rho = 1000 \text{ kg/m}^3$

Ambient Temperature:  $22.5 \text{ }^\circ\text{C}$       Liquid Temperature:  $22.5 \text{ }^\circ\text{C}$

Communication System: LTE Band 2 Professional 1900MHz;    Frequency: 1880 MHz; Duty Cycle: 1:1

Probe: ES3DV3 - SN3252ConvF(4.77, 4.77, 4.77); Calibrated: 9/4/2018

**LTE2 20Mhz 1RB 50 left Mode Middle/Area Scan (41x111x1):**

Measurement grid:  $dx=10 \text{ mm}$ ,  $dy=10 \text{ mm}$

Maximum value of SAR (Measurement) =  $0.778 \text{ W/kg}$

**LTE2 20Mhz 1RB 50 left Mode Middle/Zoom Scan (7x7x7)/Cube 0:**

Measurement grid:  $dx=5\text{mm}$ ,  $dy=5\text{mm}$ ,  $dz=5\text{mm}$

Reference Value =  $19.19 \text{ V/m}$ ; Power Drift =  $0.06 \text{ dB}$

Peak SAR (extrapolated) =  $1.30 \text{ W/kg}$

SAR(1 g) =  $0.678 \text{ W/kg}$ ; SAR(10 g) =  $0.357 \text{ W/kg}$

Maximum value of SAR (measured) =  $0.762 \text{ W/kg}$

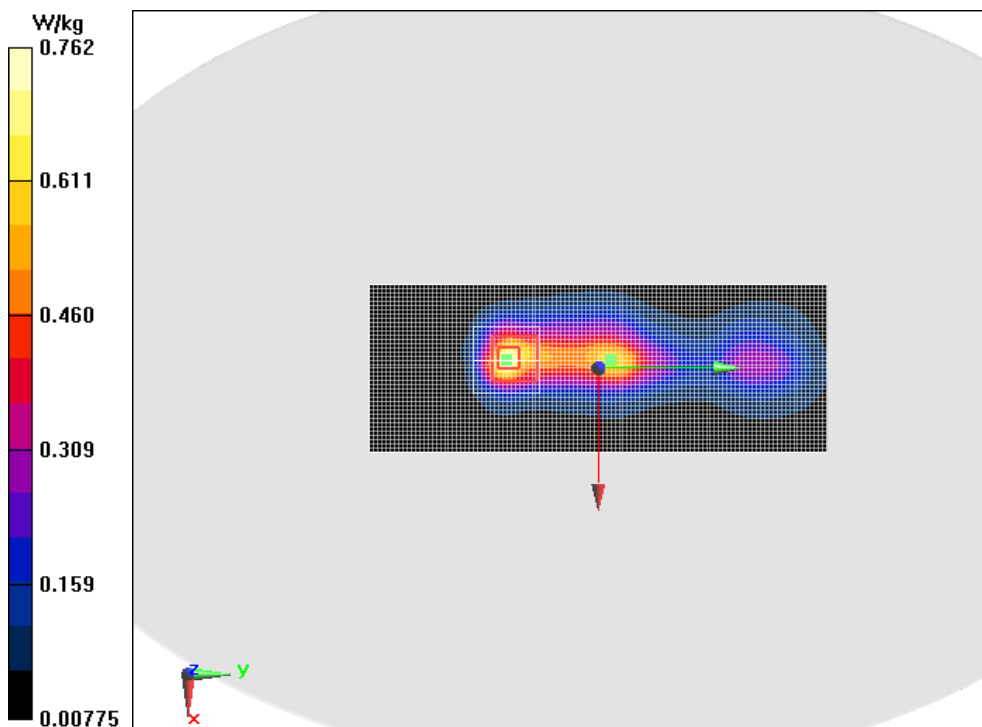

**Fig.12 LTE Band 2 20Mhz 1RB 50 left Mode Middle**

Date/Time: 2018/12/27

Electronics: DAE4 Sn1244

Medium parameters used:  $f = 1880 \text{ MHz}$ ;  $\sigma = 1.536 \text{ S/m}$ ;  $\epsilon_r = 52.147$ ;  $\rho = 1000 \text{ kg/m}^3$

Ambient Temperature:  $22.5 \text{ }^\circ\text{C}$       Liquid Temperature:  $22.5 \text{ }^\circ\text{C}$

Communication System: LTE Band 2 Professional 1900MHz;    Frequency: 1880 MHz; Duty Cycle: 1:1

Probe: ES3DV3 - SN3252ConvF(4.77, 4.77, 4.77); Calibrated: 9/4/2018

**LTE2 20Mhz 1RB 50 left Mode Middle/Area Scan (41x111x1):**

Measurement grid:  $dx=10 \text{ mm}$ ,  $dy=10 \text{ mm}$

Maximum value of SAR (Measurement) = 1.88 W/kg

**LTE2 20Mhz 1RB 50 left Mode Middle/Zoom Scan (7x7x7)/Cube 0:**

Measurement grid:  $dx=5\text{mm}$ ,  $dy=5\text{mm}$ ,  $dz=5\text{mm}$

Reference Value = 25.42 V/m; Power Drift = -0.18 dB

Peak SAR (extrapolated) = 3.96 W/kg

SAR(1 g) = 1.82 W/kg; SAR(10 g) = 0.848 W/kg

Maximum value of SAR (measured) = 2.05 W/kg

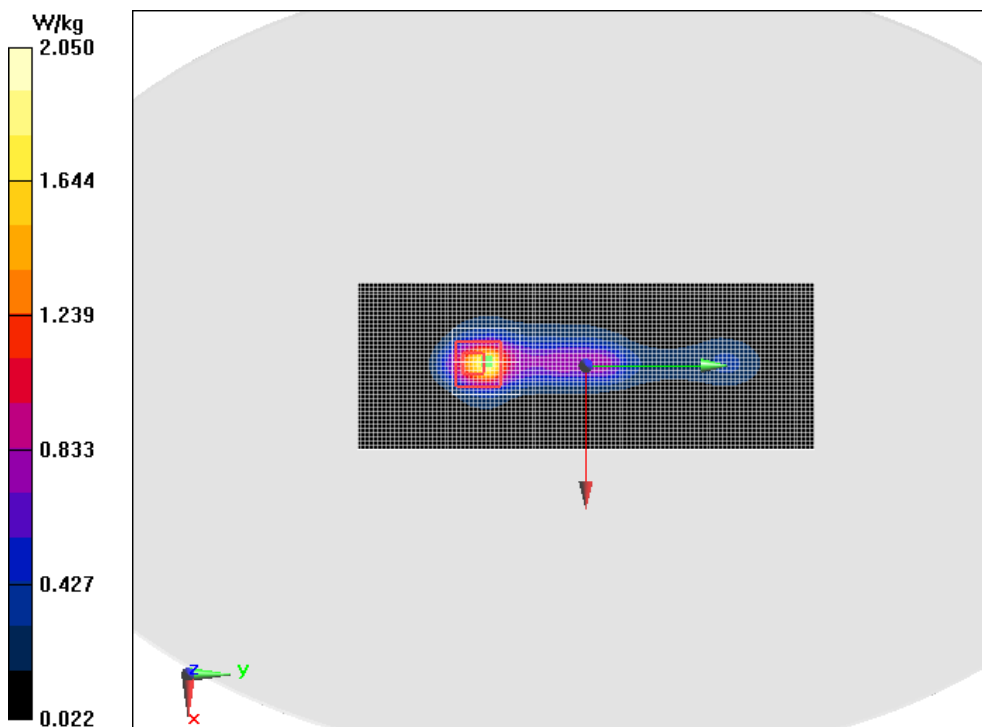



**Fig.13 LTE Band 4 20Mhz 50RB 0 left Mode Middle**

Date/Time: 2018/12/26

Electronics: DAE4 Sn1244

Medium parameters used (interpolated):  $f = 1732.5$  MHz;  $\sigma = 1.408$  S/m;  $\epsilon_r = 55.445$ ;  $\rho = 1000$  kg/m<sup>3</sup>

Ambient Temperature:22.5 °C      Liquid Temperature:22.5 °C

Communication System: LTE Band 4 Professional 1800MHz;    Frequency: 1732.5 MHz;

Duty Cycle: 1:1

Probe: ES3DV3 - SN3252ConvF(4.99, 4.99, 4.99); Calibrated: 9/4/2018

**LTE 4 20Mhz 50RB 0 left Mode Middle/Area Scan (41x111x1):**

Measurement grid: dx=10 mm, dy=10 mm

Maximum value of SAR (Measurement) = 0.668 W/kg

**LTE 4 20Mhz 50RB 0 left Mode Middle/Zoom Scan (7x7x7)/Cube 0:**

Measurement grid: dx=5mm, dy=5mm, dz=5mm

Reference Value = 20.15 V/m; Power Drift = 0.18 dB

Peak SAR (extrapolated) = 1.01 W/kg

SAR(1 g) = 0.575 W/kg; SAR(10 g) = 0.340 W/kg

Maximum of SAR (measured) = 0.630 W/kg

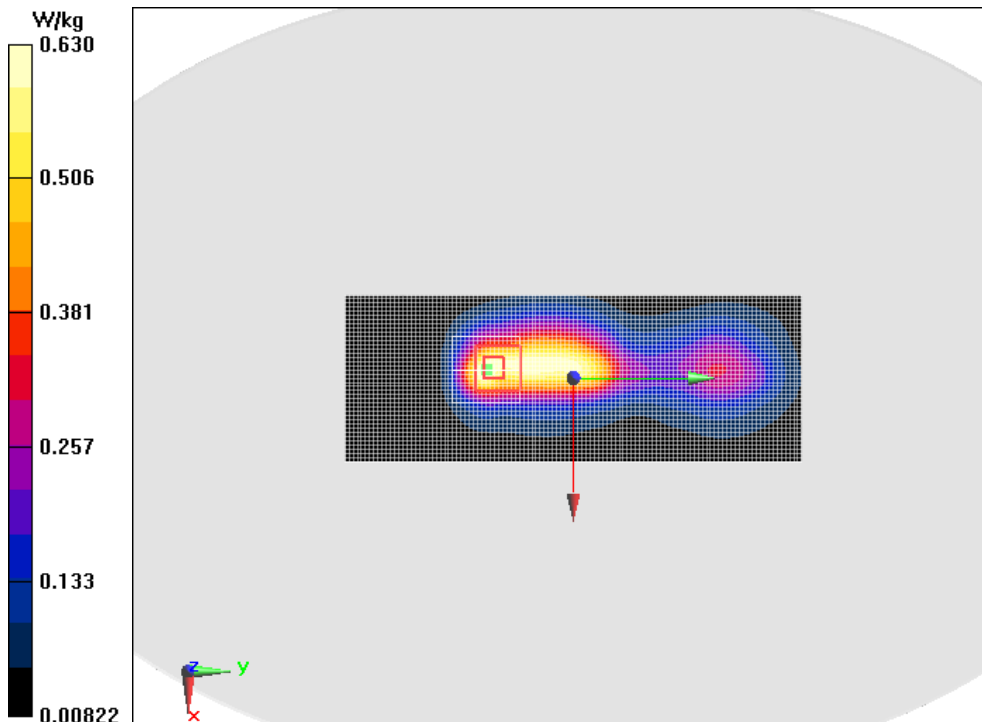

**Fig.14 LTE Band 4 20Mhz 50RB 0 offset left Mode Middle**

Date/Time: 2018/12/26

Electronics: DAE4 Sn1244

Medium parameters used (interpolated):  $f = 1732.5$  MHz;  $\sigma = 1.408$  S/m;  $\epsilon_r = 55.445$ ;  $\rho = 1000$  kg/m<sup>3</sup>

Ambient Temperature:22.5 °C      Liquid Temperature:22.5 °C

Communication System: LTE Band 4 Professional 1800MHz;    Frequency: 1732.5 MHz;

Duty Cycle: 1:1

Probe: ES3DV3 - SN3252ConvF(4.99, 4.99, 4.99); Calibrated: 9/4/2018

**LTE 4 20Mhz 50RB 0 offset left Mode Middle/Area Scan (41x111x1):**

Measurement grid: dx=10 mm, dy=10 mm

Maximum value of SAR (Measurement) = 1.71 W/kg

**LTE 4 20Mhz 50RB 0 offset left Mode Middle/Zoom Scan (7x7x7)/Cube 0:**

Measurement grid: dx=5mm, dy=5mm, dz=5mm

Reference Value = 24.79 V/m; Power Drift = 0.09 dB

Peak SAR (extrapolated) = 2.76 W/kg

SAR(1 g) = 1.33 W/kg; SAR(10 g) = 0.663 W/kg

Maximum value of SAR (measured) = 1.47 W/kg

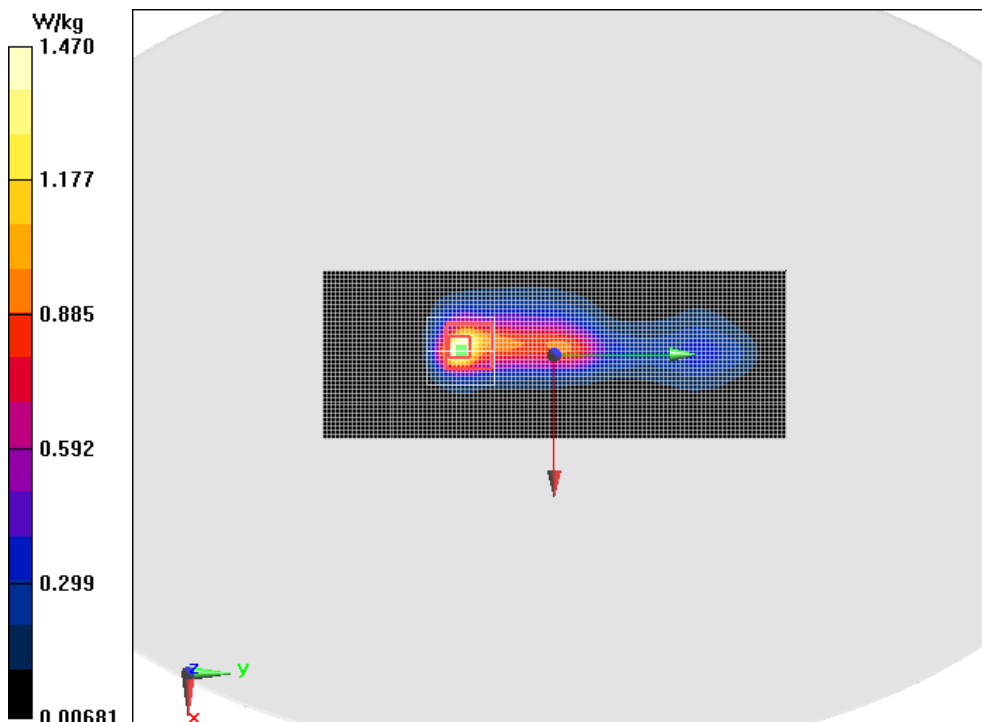

**Fig.15 LTE Band 7 20MHz 1RB 50 offset left Mode Middle 5mm**

Date/Time: 2018/12/24

Electronics: DAE4 Sn1244

Medium parameters used:  $f = 2535$  MHz;  $\sigma = 2.034$  S/m;  $\epsilon_r = 53.856$ ;  $\rho = 1000$  kg/m<sup>3</sup>

Ambient Temperature: 22.5 °C      Liquid Temperature: 22.5 °C

Communication System: LTE Band 7 Professional 2450MHz;    Frequency: 2535 MHz; Duty Cycle: 1:1

Probe: ES3DV3 - SN3252ConvF(4.41, 4.41, 4.41); Calibrated: 9/4/2018

**LTE7 20MHz 1RB 50 offset left Mode Middle 5mm/Area Scan (41x111x1):**

Measurement grid: dx=10 mm, dy=10 mm

Maximum value of SAR (Measurement) = 0.263 W/kg

**LTE7 20MHz 1RB 50 offset left Mode Middle 5mm/Zoom Scan (7x7x7)/Cube 0:**

Measurement grid: dx=5mm, dy=5mm, dz=5mm

Reference Value = 2.545 V/m; Power Drift = -0.07 dB

Peak SAR (extrapolated) = 0.734 W/kg

SAR(1 g) = 0.324 W/kg; SAR(10 g) = 0.133 W/kg

Maximum value of SAR (measured) = 0.393 W/kg

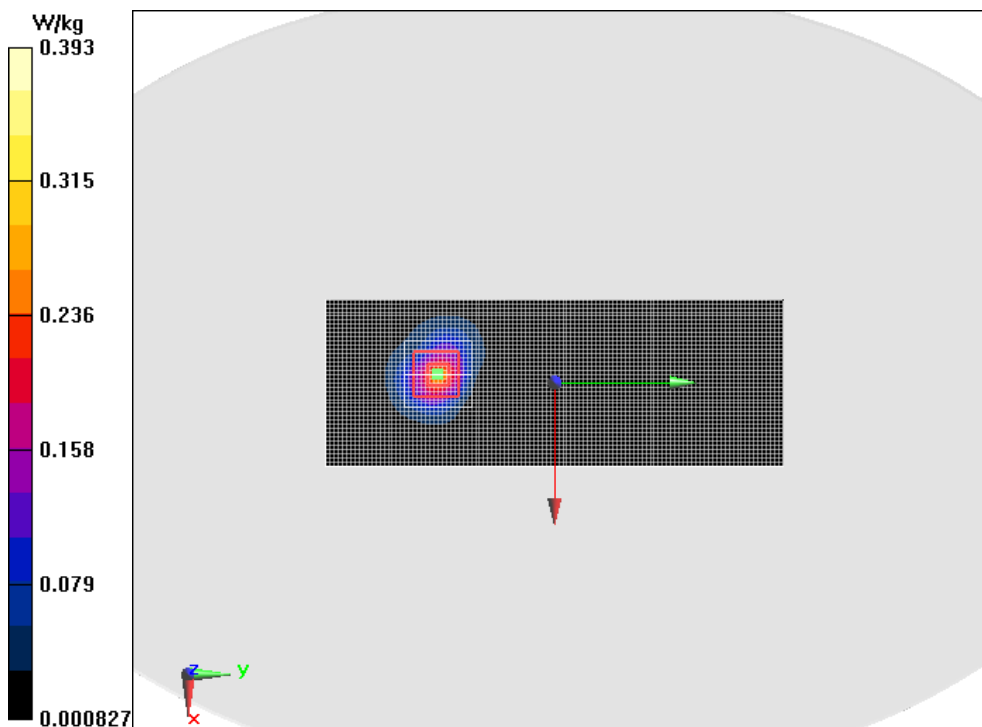

**Fig.16 LTE Band 7 20MHz 1RB 50 offset left Mode Middle 0mm**

Date/Time: 2018/12/24

Electronics: DAE4 Sn1244

Medium parameters used:  $f = 2535 \text{ MHz}$ ;  $\sigma = 2.034 \text{ S/m}$ ;  $\epsilon_r = 53.856$ ;  $\rho = 1000 \text{ kg/m}^3$

Ambient Temperature:  $22.5 \text{ }^\circ\text{C}$       Liquid Temperature:  $22.5 \text{ }^\circ\text{C}$

Communication System: LTE Band 7 Professional 2450MHz;    Frequency: 2535 MHz; Duty Cycle: 1:1

Probe: ES3DV3 - SN3252ConvF(4.41, 4.41, 4.41); Calibrated: 9/4/2018

**LTE7 20MHz 1RB 50 offset left Mode Middle 0mm/Area Scan (41x111x1):**

Measurement grid:  $dx=10 \text{ mm}$ ,  $dy=10 \text{ mm}$

Maximum value of SAR (Measurement) =  $2.55 \text{ W/kg}$

**LTE7 20MHz 1RB 50 offset left Mode Middle 0mm/Zoom Scan (7x7x7)/Cube 0:**

Measurement grid:  $dx=5\text{mm}$ ,  $dy=5\text{mm}$ ,  $dz=5\text{mm}$

Reference Value =  $6.369 \text{ V/m}$ ; Power Drift =  $0.08 \text{ dB}$

Peak SAR (extrapolated) =  $5.29 \text{ W/kg}$

SAR(1 g) =  $2.09 \text{ W/kg}$ ; SAR(10 g) =  $0.738 \text{ W/kg}$

Maximum value of SAR (measured) =  $2.51 \text{ W/kg}$

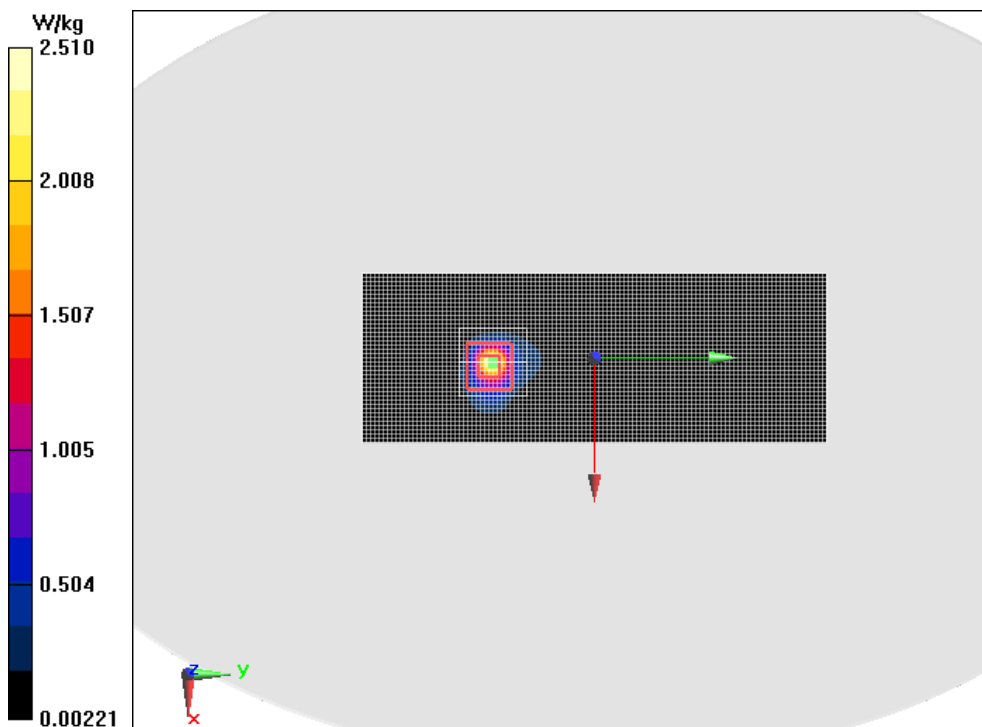

**Fig.17 LTE Band 17 10MHz 1RB 25 offset Left Mode Middle**

Date/Time: 2018/12/24

Electronics: DAE4 Sn1244

Medium parameters used:  $f = 710 \text{ MHz}$ ;  $\sigma = 0.877 \text{ S/m}$ ;  $\epsilon_r = 58.163$ ;  $\rho = 1000 \text{ kg/m}^3$

Ambient Temperature: 22.5 °C      Liquid Temperature: 22.5 °C

Communication System: LTE Band 17 Professional 850MHz;    Frequency: 710 MHz; Duty Cycle: 1:1

Probe: ES3DV3 - SN3252ConvF(6.53, 6.53, 6.53); Calibrated: 9/4/2018

**LTE17 10MHz 1RB 25 offset Left Mode Middle/Area Scan (41x111x1):**

Measurement grid:  $dx=10 \text{ mm}$ ,  $dy=10 \text{ mm}$

Maximum value of SAR (Measurement) = 0.341 W/kg

**LTE17 10MHz 1RB 25 offset Left Mode Middle/Zoom Scan (7x7x7)/Cube 0:**

Measurement grid:  $dx=5\text{mm}$ ,  $dy=5\text{mm}$ ,  $dz=5\text{mm}$

Reference Value = 9.628 V/m; Power Drift = 0.05 dB

Peak SAR (extrapolated) = 0.679 W/kg

SAR(1 g) = 0.343 W/kg; SAR(10 g) = 0.184 W/kg

Maximum value of SAR (measured) = 0.380 W/kg

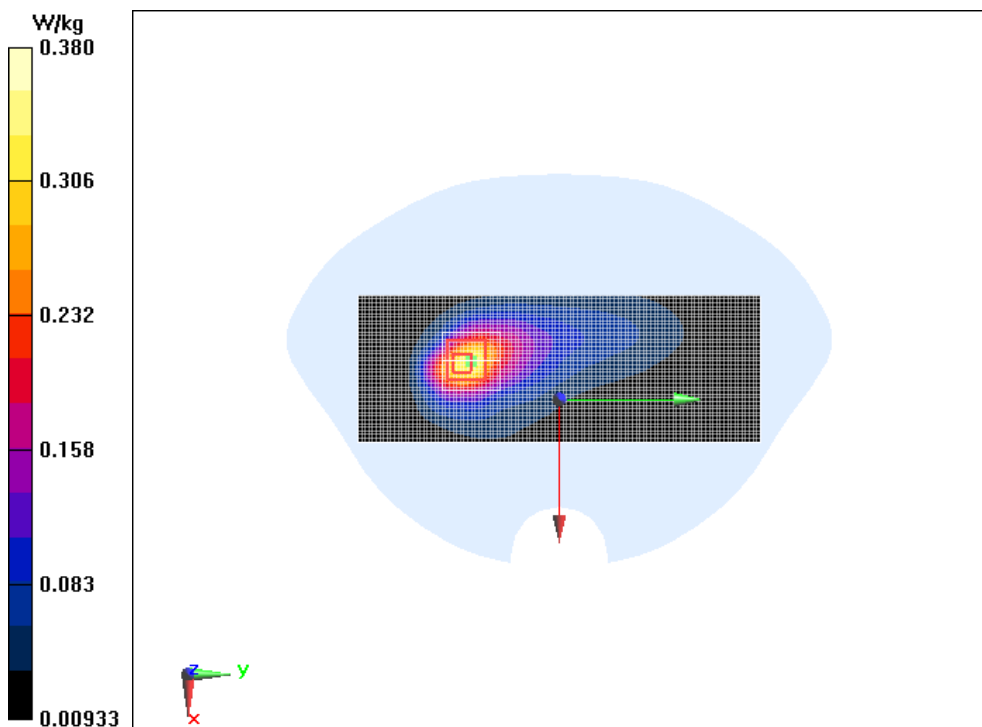

**Fig.18 LTE Band 17 10MHz 1RB 25 offset Left Mode Middle**

Date/Time: 2018/12/24

Electronics: DAE4 Sn1244

Medium parameters used:  $f = 710 \text{ MHz}$ ;  $\sigma = 0.877 \text{ S/m}$ ;  $\epsilon_r = 58.163$ ;  $\rho = 1000 \text{ kg/m}^3$

Ambient Temperature: 22.5 °C      Liquid Temperature: 22.5 °C

Communication System: LTE Band 17 Professional 850MHz;    Frequency: 710 MHz; Duty Cycle: 1:1

Probe: ES3DV3 - SN3252ConvF(6.53, 6.53, 6.53); Calibrated: 9/4/2018

**LTE17 10MHz 1RB 25 offset Left Mode Middle/Area Scan (41x111x1):**

Measurement grid:  $dx=10 \text{ mm}$ ,  $dy=10 \text{ mm}$

Maximum value of SAR (Measurement) = 0.776 W/kg

**LTE17 10MHz 1RB 25 offset Left Mode Middle/Zoom Scan (7x7x7)/Cube 0:**

Measurement grid:  $dx=5\text{mm}$ ,  $dy=5\text{mm}$ ,  $dz=5\text{mm}$

Reference Value = 8.064 V/m; Power Drift = 0.03 dB

Peak SAR (extrapolated) = 2.34 W/kg

SAR(1 g) = 0.775 W/kg; SAR(10 g) = 0.364 W/kg

Maximum value of SAR (measured) = 0.732 W/kg

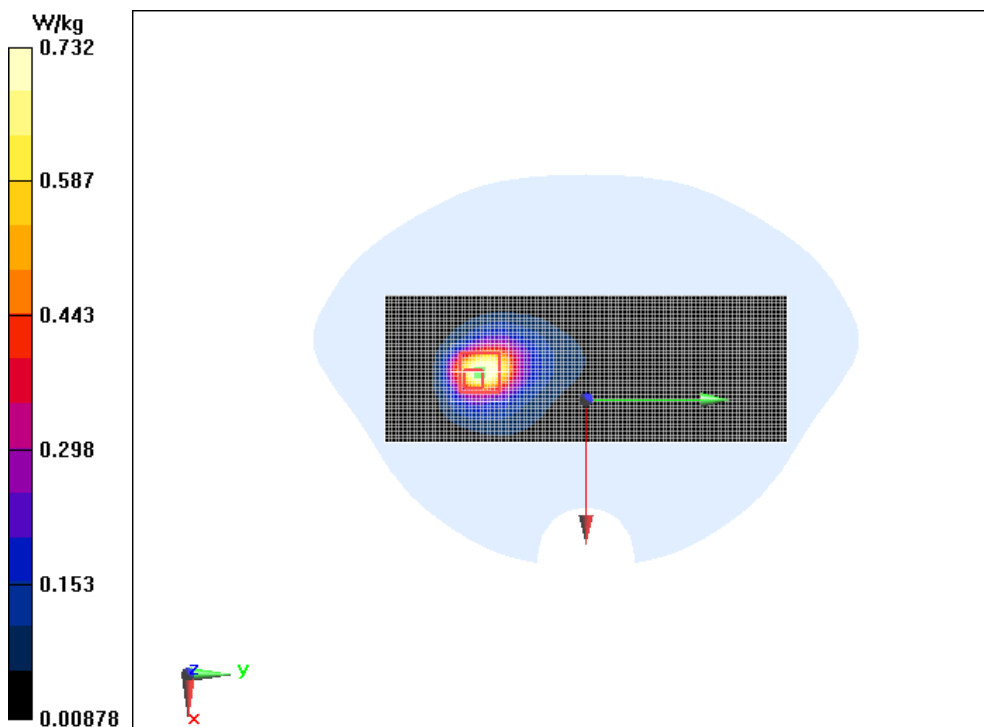

**Fig.19 WiFi 802.11b Right Mode High**

Date/Time: 2018/12/28

Electronics: DAE4 Sn1244

Medium parameters used:  $f = 2462 \text{ MHz}$ ;  $\sigma = 1.991 \text{ S/m}$ ;  $\epsilon_r = 52.882$ ;  $\rho = 1000 \text{ kg/m}^3$

Ambient Temperature:  $22.5 \text{ }^\circ\text{C}$       Liquid Temperature:  $22.5 \text{ }^\circ\text{C}$

Communication System: Wifi 2450 2450MHz;    Frequency:  $2462 \text{ MHz}$ ; Duty Cycle: 1:1

Probe: ES3DV3 - SN3252ConvF(4.41, 4.41, 4.41); Calibrated: 9/4/2018

**WiFi 802.11b Right Mode High/Area Scan (41x111x1):**

Measurement grid:  $dx=10 \text{ mm}$ ,  $dy=10 \text{ mm}$

Maximum value of SAR (Measurement) =  $0.405 \text{ W/kg}$

**WiFi 802.11b Right Mode High/Zoom Scan (7x7x7)/Cube 0:**

Measurement grid:  $dx=5\text{mm}$ ,  $dy=5\text{mm}$ ,  $dz=5\text{mm}$

Reference Value =  $6.593 \text{ V/m}$ ; Power Drift =  $0.06 \text{ dB}$

Peak SAR (extrapolated) =  $0.708 \text{ W/kg}$

SAR(1 g) =  $0.309 \text{ W/kg}$ ; SAR(10 g) =  $0.129 \text{ W/kg}$

Maximum value of SAR (measured) =  $0.339 \text{ W/kg}$

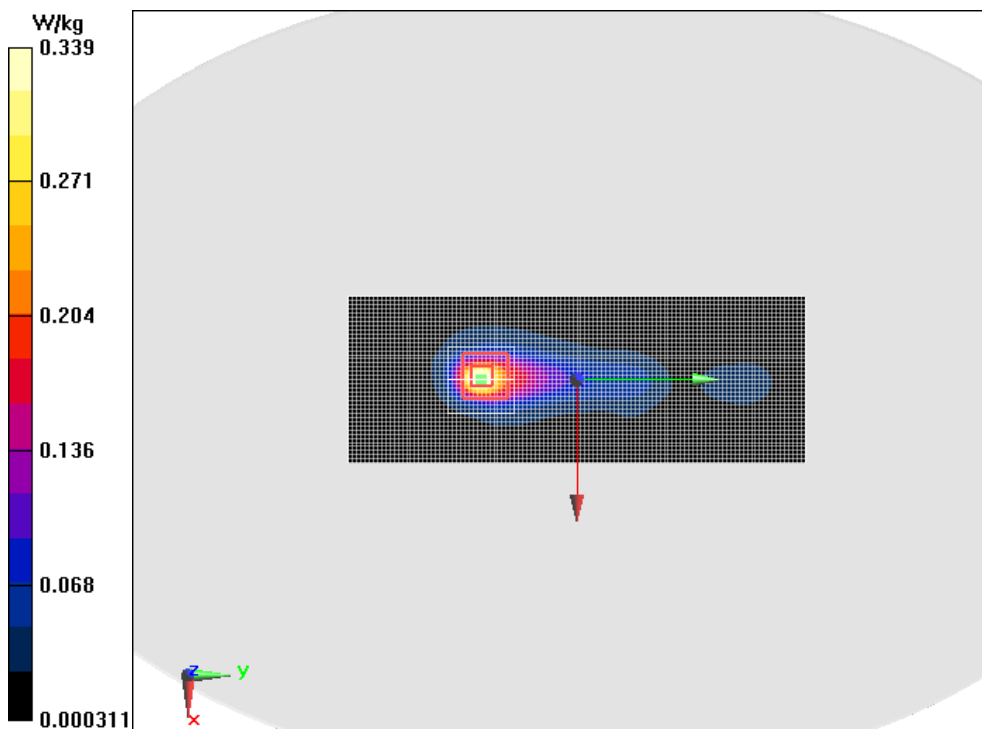

**Fig.20 WiFi 802.11b Right Mode High**

Date/Time: 2018/12/28

Electronics: DAE4 Sn1244

Medium parameters used:  $f = 2462 \text{ MHz}$ ;  $\sigma = 1.991 \text{ S/m}$ ;  $\epsilon_r = 52.882$ ;  $\rho = 1000 \text{ kg/m}^3$

Ambient Temperature:  $22.5 \text{ }^\circ\text{C}$       Liquid Temperature:  $22.5 \text{ }^\circ\text{C}$

Communication System: Wifi 2450 2450MHz;    Frequency:  $2462 \text{ MHz}$ ; Duty Cycle: 1:1

Probe: ES3DV3 - SN3252ConvF(4.41, 4.41, 4.41); Calibrated: 9/4/2018

**WiFi 802.11b Right Mode High/Area Scan (41x111x1):**

Measurement grid:  $dx=10 \text{ mm}$ ,  $dy=10 \text{ mm}$

Maximum value of SAR (Measurement) =  $0.714 \text{ W/kg}$

**WiFi 802.11b Right Mode High/Zoom Scan (7x7x7)/Cube 0:**

Measurement grid:  $dx=5\text{mm}$ ,  $dy=5\text{mm}$ ,  $dz=5\text{mm}$

Reference Value =  $6.374 \text{ V/m}$ ; Power Drift =  $-0.03 \text{ dB}$

Peak SAR (extrapolated) =  $2.43 \text{ W/kg}$

SAR(1 g) =  $0.853 \text{ W/kg}$ ; SAR(10 g) =  $0.300 \text{ W/kg}$

Maximum value of SAR (measured) =  $0.882 \text{ W/kg}$

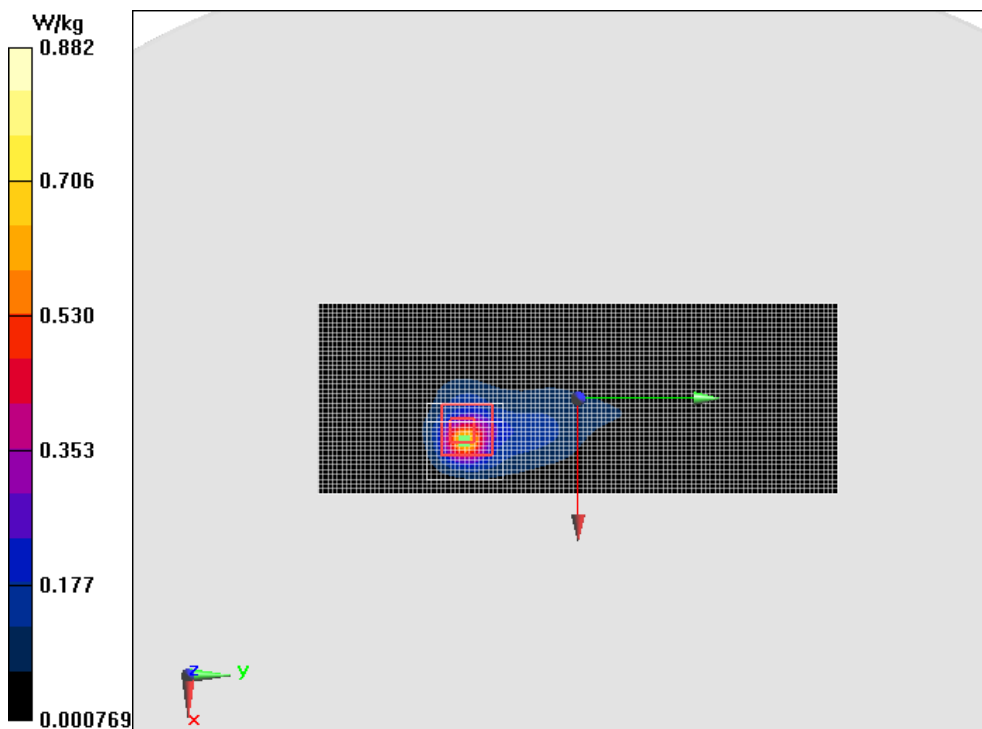



**ANNEX B. SYSTEM VALIDATION RESULTS**

**Body 750MHz**

Date/Time: 2018/12/24

Electronics: DAE4 Sn1244

Medium parameters used:  $f = 750 \text{ MHz}$ ;  $\sigma = 0.915 \text{ S/m}$ ;  $\epsilon_r = 57.696$ ;  $\rho = 1000 \text{ kg/m}^3$

Ambient Temperature:  $22.5 \text{ }^\circ\text{C}$       Liquid Temperature:  $22.5 \text{ }^\circ\text{C}$

Communication System: CW 850MHz;    Frequency: 750 MHz; Duty Cycle: 1:1

Probe: ES3DV3 - SN3252ConvF(6.53, 6.53, 6.53); Calibrated: 9/4/2018

**System Validation /Area Scan (71x131x1):**

Measurement grid:  $dx=10 \text{ mm}$ ,  $dy=10 \text{ mm}$

Maximum value of SAR (Measurement) =  $2.21 \text{ W/kg}$

**System Validation /Zoom Scan (7x7x7) (7x7x7)/Cube 0:**

Measurement grid:  $dx=5\text{mm}$ ,  $dy=5\text{mm}$ ,  $dz=5\text{mm}$

Reference Value =  $45.74 \text{ V/m}$ ; Power Drift =  $0.06 \text{ dB}$

Peak SAR (extrapolated) =  $3.06 \text{ W/kg}$

SAR(1 g) =  $2.11 \text{ W/kg}$ ; SAR(10 g) =  $1.42 \text{ W/kg}$

Maximum value of SAR (measured) =  $2.27 \text{ W/kg}$

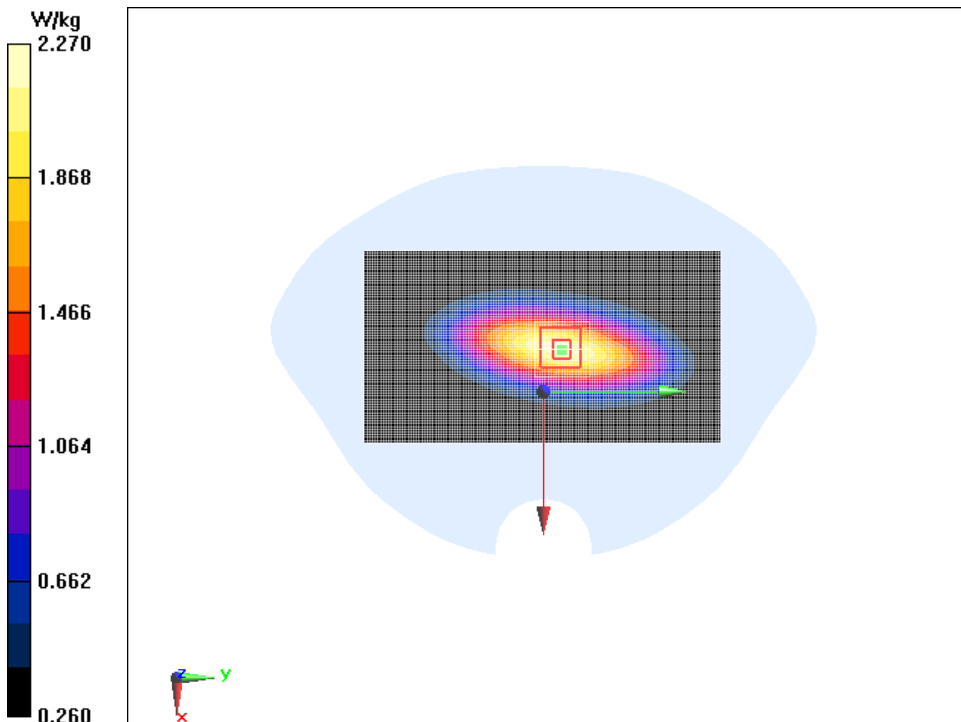

## Body 835MHz

Date/Time: 2018/12/25

Electronics: DAE4 Sn1244

Medium parameters used:  $f = 835 \text{ MHz}$ ;  $\sigma = 0.998 \text{ S/m}$ ;  $\epsilon_r = 56.715$ ;  $\rho = 1000 \text{ kg/m}^3$

Ambient Temperature:  $22.5 \text{ }^\circ\text{C}$       Liquid Temperature:  $22.5 \text{ }^\circ\text{C}$

Communication System: CW 850MHz;    Frequency: 835 MHz; Duty Cycle: 1:1

Probe: ES3DV3 - SN3252ConvF(6.34, 6.34, 6.34); Calibrated: 9/4/2018

### System Validation/Area Scan (61x131x1):

Measurement grid:  $dx=10 \text{ mm}$ ,  $dy=10 \text{ mm}$

Maximum value of SAR (Measurement) =  $2.65 \text{ W/kg}$

### System Validation/Zoom Scan (7x7x7)/Cube 0:

Measurement grid:  $dx=5\text{mm}$ ,  $dy=5\text{mm}$ ,  $dz=5\text{mm}$

Reference Value =  $50.50 \text{ V/m}$ ; Power Drift =  $0.04 \text{ dB}$

Peak SAR (extrapolated) =  $3.55 \text{ W/kg}$

SAR(1 g) =  $2.48 \text{ W/kg}$ ; SAR(10 g) =  $1.66 \text{ W/kg}$

Maximum value of SAR (measured) =  $2.67 \text{ W/kg}$

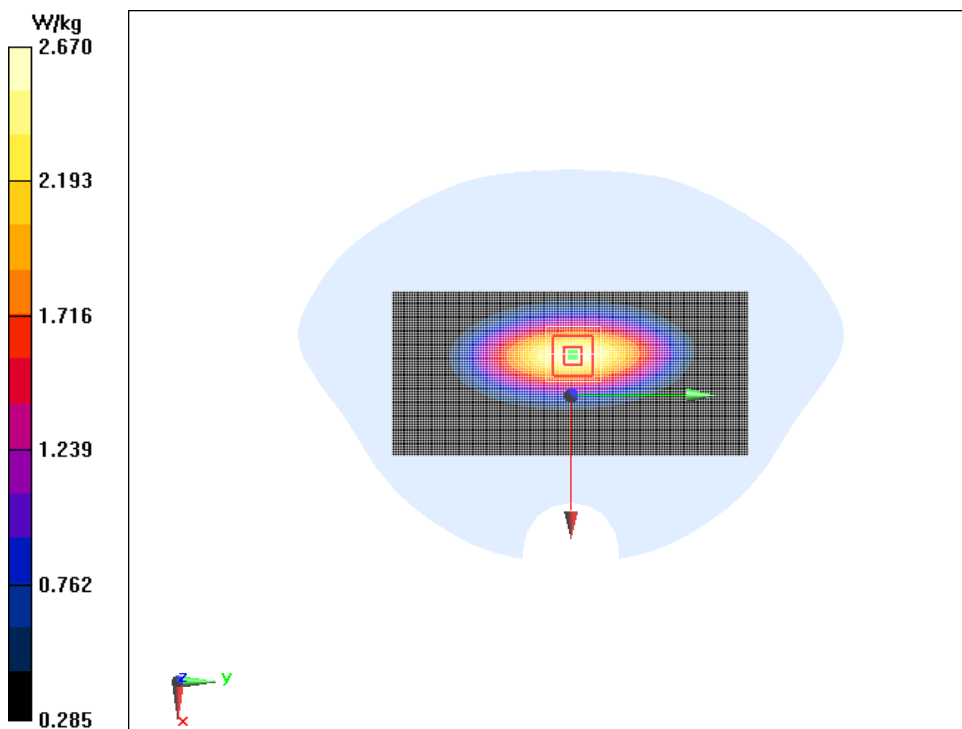

## Body 1750MHz

Date/Time: 2018/12/26

Electronics: DAE4 Sn1244

Medium parameters used:  $f = 1750 \text{ MHz}$ ;  $\sigma = 1.426 \text{ S/m}$ ;  $\epsilon_r = 55.385$ ;  $\rho = 1000 \text{ kg/m}^3$

Ambient Temperature:  $22.5 \text{ }^\circ\text{C}$       Liquid Temperature:  $22.5 \text{ }^\circ\text{C}$

Communication System: CW 1800MHz;    Frequency: 1750 MHz; Duty Cycle: 1:1

Probe: ES3DV3 - SN3252ConvF(4.99, 4.99, 4.99); Calibrated: 9/4/2018

### System check Validation/Area Scan (61x61x1):

Measurement grid:  $dx=10 \text{ mm}$ ,  $dy=10 \text{ mm}$

Maximum value of SAR (Measurement) =  $11.1 \text{ W/kg}$

### System check Validation/Zoom Scan (7x7x7) (7x7x7)/Cube 0:

Measurement grid:  $dx=5\text{mm}$ ,  $dy=5\text{mm}$ ,  $dz=5\text{mm}$

Reference Value =  $88.54 \text{ V/m}$ ; Power Drift =  $-0.02 \text{ dB}$

Peak SAR (extrapolated) =  $17.4 \text{ W/kg}$

SAR(1 g) =  $9.63 \text{ W/kg}$ ; SAR(10 g) =  $5.14 \text{ W/kg}$

Maximum value of SAR (measured) =  $10.7 \text{ W/kg}$

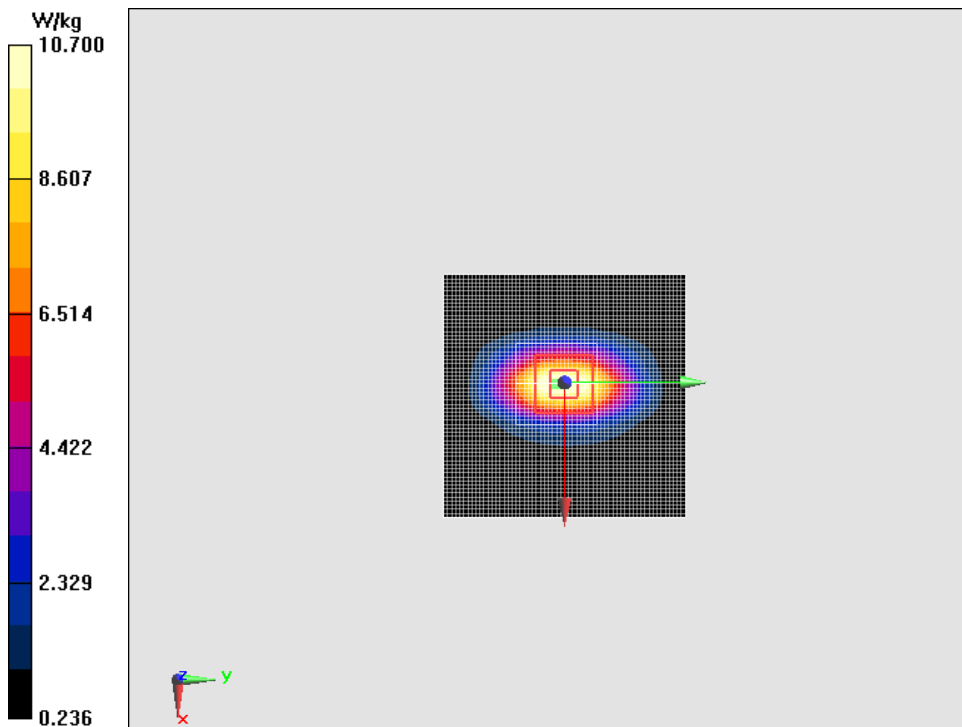

## Body 1900MHz

Date/Time: 2018/12/27

Electronics: DAE4 Sn1244

Medium parameters used:  $f = 1900 \text{ MHz}$ ;  $\sigma = 1.556 \text{ S/m}$ ;  $\epsilon_r = 52.078$ ;  $\rho = 1000 \text{ kg/m}^3$

Ambient Temperature:  $22.5 \text{ }^\circ\text{C}$       Liquid Temperature:  $22.5 \text{ }^\circ\text{C}$

Communication System: CW 1900MHz;    Frequency: 1900 MHz; Duty Cycle: 1:1

Probe: ES3DV3 - SN3252ConvF(4.77, 4.77, 4.77); Calibrated: 9/4/2018

### System check Validation /Area Scan (61x61x1):

Measurement grid:  $dx=10 \text{ mm}$ ,  $dy=10 \text{ mm}$

Maximum value of SAR (Measurement) =  $12.3 \text{ W/kg}$

### System check Validation /Zoom Scan (7x7x7) (7x7x7)/Cube 0:

Measurement grid:  $dx=5\text{mm}$ ,  $dy=5\text{mm}$ ,  $dz=5\text{mm}$

Reference Value =  $83.59 \text{ V/m}$ ; Power Drift =  $-0.04 \text{ dB}$

Peak SAR (extrapolated) =  $17.9 \text{ W/kg}$

SAR(1 g) =  $10 \text{ W/kg}$ ; SAR(10 g) =  $5.34 \text{ W/kg}$

Maximum value of SAR (measured) =  $11.4 \text{ W/kg}$

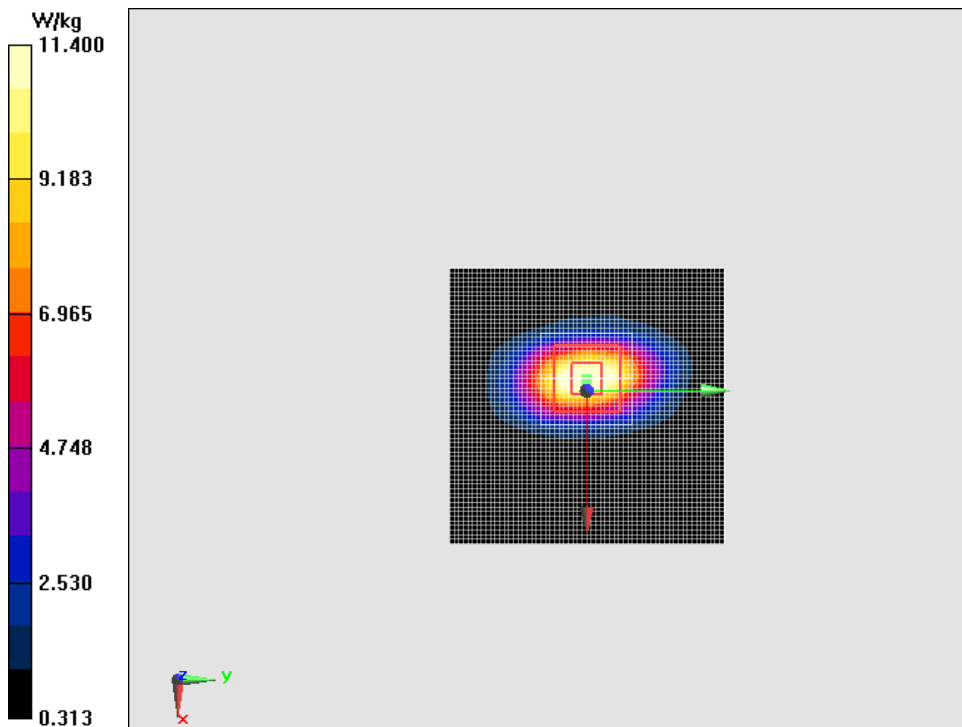

## Body 2450MHz

Date/Time: 2018/12/28

Electronics: DAE4 Sn1244

Medium parameters used:  $f = 2450 \text{ MHz}$ ;  $\sigma = 1.976 \text{ S/m}$ ;  $\epsilon_r = 52.926$ ;  $\rho = 1000 \text{ kg/m}^3$

Ambient Temperature:  $22.5 \text{ }^\circ\text{C}$       Liquid Temperature:  $22.5 \text{ }^\circ\text{C}$

Communication System: CW 2450MHz;    Frequency: 2450 MHz; Duty Cycle: 1:1

Probe: ES3DV3 - SN3252ConvF(4.41, 4.41, 4.41); Calibrated: 9/4/2018

### System Validation/Area Scan (91x71x1):

Measurement grid:  $dx=10 \text{ mm}$ ,  $dy=10 \text{ mm}$

Maximum value of SAR (Measurement) =  $15.3 \text{ W/kg}$

### System Validation/Zoom Scan (7x7x7) (7x7x7)/Cube 0:

Measurement grid:  $dx=5\text{mm}$ ,  $dy=5\text{mm}$ ,  $dz=5\text{mm}$

Reference Value =  $87.88 \text{ V/m}$ ; Power Drift =  $-0.08 \text{ dB}$

Peak SAR (extrapolated) =  $27.8 \text{ W/kg}$

SAR(1 g) =  $13.2 \text{ W/kg}$ ; SAR(10 g) =  $6.11 \text{ W/kg}$

Maximum value of SAR (measured) =  $15.2 \text{ W/kg}$

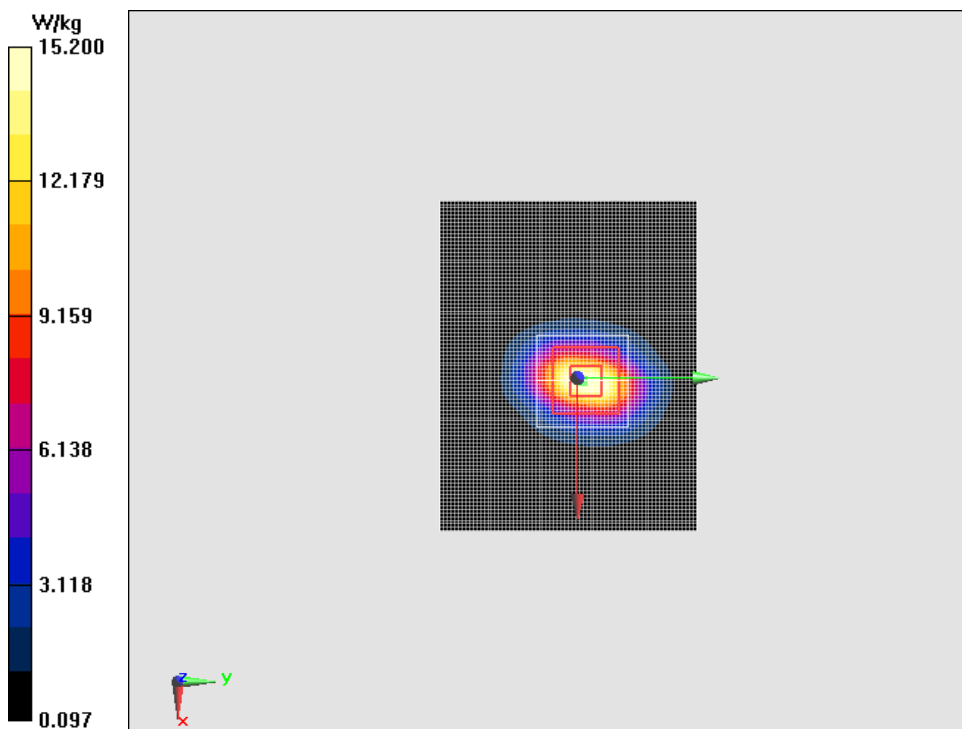

## Body 2600MHz

Date/Time: 2018/12/24

Electronics: DAE4 Sn1244

Medium parameters used:  $f = 2600 \text{ MHz}$ ;  $\sigma = 2.113 \text{ S/m}$ ;  $\epsilon_r = 53.66$ ;  $\rho = 1000 \text{ kg/m}^3$

Ambient Temperature:  $22.5 \text{ }^\circ\text{C}$       Liquid Temperature:  $22.5 \text{ }^\circ\text{C}$

Communication System: CW 2450MHz;    Frequency: 2600 MHz; Duty Cycle: 1:1

Probe: ES3DV3 - SN3252ConvF(4.19, 4.19, 4.19); Calibrated: 9/4/2018

### Body 2600MHz/Area Scan (101x101x1):

Measurement grid:  $dx=10 \text{ mm}$ ,  $dy=10 \text{ mm}$

Maximum value of SAR (Measurement) =  $16.8 \text{ W/kg}$

### Body 2600MHz/Zoom Scan (7x7x7)/Cube 0:

Measurement grid:  $dx=5\text{mm}$ ,  $dy=5\text{mm}$ ,  $dz=5\text{mm}$

Reference Value =  $78.23 \text{ V/m}$ ; Power Drift =  $-0.10 \text{ dB}$

Peak SAR (extrapolated) =  $31.5 \text{ W/kg}$

SAR(1 g) =  $14.2 \text{ W/kg}$ ; SAR(10 g) =  $6.2 \text{ W/kg}$

Maximum value of SAR (measured) =  $16.3 \text{ W/kg}$

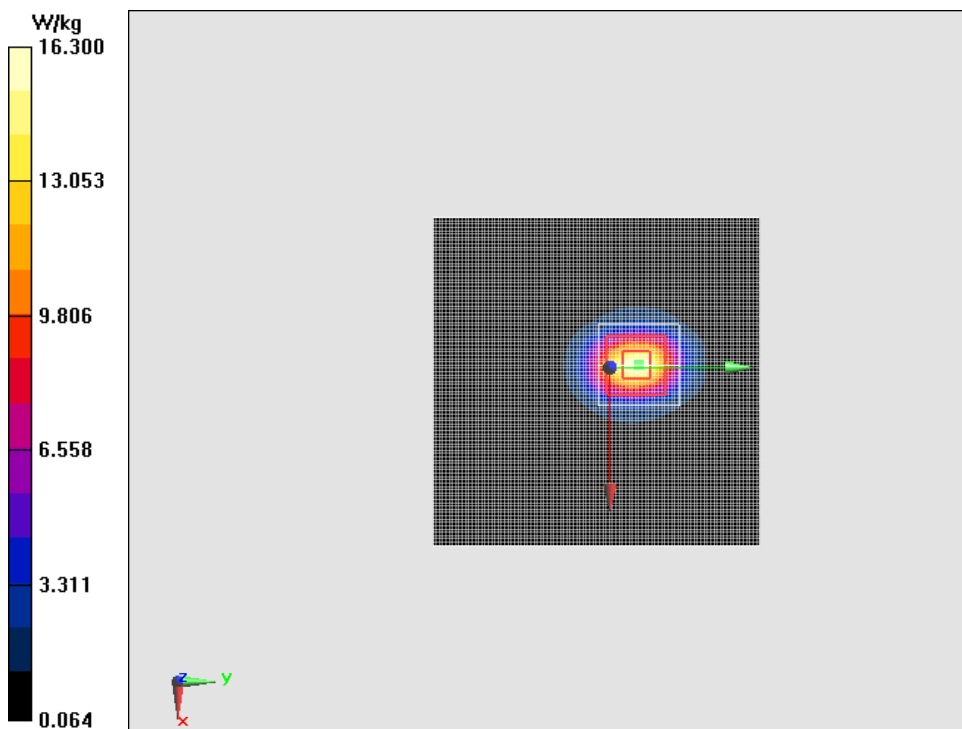

## ANNEX C. SAR Measurement Setup

### C.1. Measurement Set-up

The DASY5 system for performing compliance tests is illustrated above graphically. This system consists of the following items:

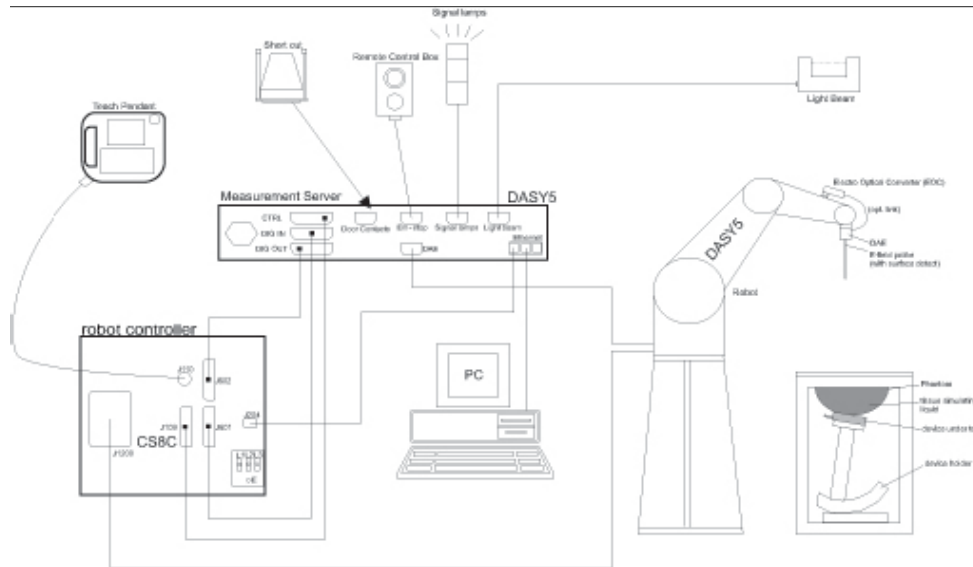

Picture C.1 SAR Lab Test Measurement Set-up

- A standard high precision 6-axis robot (Stäubli TX=RX family) with controller, teach pendant and software. An arm extension for accommodating the data acquisition electronics (DAE).
- An isotropic field probe optimized and calibrated for the targeted measurement.
- A data acquisition electronics (DAE) which performs the signal amplification, signal multiplexing, AD-conversion, offset measurements, mechanical surface detection, collision detection, etc. The unit is battery powered with standard or rechargeable batteries. The signal is optically transmitted to the EOC.
- The Electro-optical converter (EOC) performs the conversion from optical to electrical signals for the digital communication to the DAE. To use optical surface detection, a special version of the EOC is required. The EOC signal is transmitted to the measurement server.
- The function of the measurement server is to perform the time critical tasks such as signal filtering, control of the robot operation and fast movement interrupts.
- The Light Beam used is for probe alignment. This improves the (absolute) accuracy of the probe positioning.
- A computer running WinXP and the DASY5 software.
- Remote control and teach pendant as well as additional circuitry for robot safety such as
- warning lamps, etc.

- The phantom, the device holder and other accessories according to the targeted measurement.



## C.2. DASY5 E-field Probe System

The SAR measurements were conducted with the dosimetric probe designed in the classical triangular configuration and optimized for dosimetric evaluation. The probe is constructed using the thick film technique; with printed resistive lines on ceramic substrates. The probe is equipped with an optical multifiber line ending at the front of the probe tip. It is connected to the EOC box on the robot arm and provides an automatic detection of the phantom surface. Half of the fibers are connected to a pulsed infrared transmitter, the other half to a synchronized receiver. As the probe approaches the surface, the reflection from the surface produces a coupling from the transmitting to the receiving fibers. This reflection increases first during the approach, reaches maximum and then decreases. If the probe is flatly touching the surface, the coupling is zero. The distance of the coupling maximum to the surface is independent of the surface reflectivity and largely independent of the surface to probe angle. The DASY5 software reads the reflection during a software approach and looks for the maximum using 2<sup>nd</sup> order curve fitting. The approach is stopped at reaching the maximum.

### Probe Specifications:

<b>Model:</b>	<b>ES3DV3,EX3DV4</b>
<b>Frequency</b>	<b>10MHz — 6GHz(EX3DV4)</b>
<b>Range:</b>	<b>10MHz — 4GHz(ES3DV3)</b>
<b>Calibration:</b>	<b>In head and body simulating tissue at Frequencies from 835 up to 5800MHz</b>
<b>Linearity:</b>	<b>± 0.2 dB(30 MHz to 4 GHz) for ES3DV3 ± 0.2 dB(30 MHz to 6 GHz) for EX3DV4</b>
<b>Dynamic Range:</b>	<b>10 mW/kg — 100W/kg</b>
<b>Probe Length:</b>	<b>330 mm</b>
<b>Probe Tip</b>	
<b>Length:</b>	<b>20 mm</b>
<b>Body Diameter:</b>	<b>12 mm</b>
<b>Tip Diameter:</b>	<b>2.5 mm (3.9 mm for ES3DV3)</b>
<b>Tip-Center:</b>	<b>1 mm (2.0mm for ES3DV3)</b>
<b>Application:</b>	<b>SAR Dosimetry Testing Compliance tests of mobile phones Dosimetry in strong gradient fields</b>



Picture7-2 Near-field Probe



Picture 7-3 E-field Probe

## C.3. E-field Probe Calibration

Each E-Probe/Probe Amplifier combination has unique calibration parameters. A TEM cell calibration procedure is conducted to determine the proper amplifier settings to enter in the probe parameters. The amplifier settings are determined for a given frequency by subjecting the probe to

a known E-field density ( $1 \text{ mW/cm}^2$ ) using an RF Signal generator, TEM cell, and RF Power Meter.

The free space E-field from amplified probe outputs is determined in a test chamber. This calibration can be performed in a TEM cell if the frequency is below 1 GHz and in a waveguide or other methodologies above 1 GHz for free space. For the free space calibration, the probe is placed in the volumetric center of the cavity and at the proper orientation with the field. The probe is then rotated 360 degrees until the three channels show the maximum reading. The power density readings equate to  $1 \text{ mW/cm}^2$ :

E-field temperature correlation calibration is performed in a flat phantom filled with the appropriate simulated brain tissue. The E-field in the medium correlates with the temperature rise in the dielectric medium. For temperature correlation calibration a RF transparent thermistor-based temperature probe is used in conjunction with the E-field probe.

$$SAR = C \frac{\Delta T}{\Delta t}$$

Where:

$\Delta t$  = Exposure time (30 seconds),

C = Heat capacity of tissue (brain or muscle),

$\Delta T$  = Temperature increase due to RF exposure.

$$SAR = \frac{|E|^2 \cdot \sigma}{\rho}$$

Where:

$\sigma$  = Simulated tissue conductivity,

$\rho$  = Tissue density ( $\text{kg/m}^3$ ).

## **C.4. Other Test Equipment**

### **C.4.1. Data Acquisition Electronics(DAE)**

The data acquisition electronics consist of a highly sensitive electrometer-grade preamplifier with auto-zeroing, a channel and gain-switching multiplexer, a fast 16 bit AD-converter and a command decoder with a control logic unit. Transmission to the measurement server is accomplished through an optical downlink for data and status information, as well as an optical uplink for commands and the clock.

The mechanical probe mounting device includes two different sensor systems for frontal and sideways probe contacts. They are used for mechanical surface detection and probe collision detection.

The input impedance of the DAE is 200 MOhm; the inputs are symmetrical and floating. Common mode rejection is above 80 dB.



**PictureC.4: DAE**

### C.4.2. Robot

The SPEAG DASY system uses the high precision robots (DASY5: RX90L) type from Stäubli SA (France). For the 6-axis controller system, the robot controller version from Stäubli is used. The Stäubli robot series have many features that are important for our application:

- High precision (repeatability 0.02mm)
- High reliability (industrial design)
- Low maintenance costs (virtually maintenance free due to direct drive gears; no belt drives)
- Jerk-free straight movements (brushless synchron motors; no stepper motors)
- Low ELF interference (motor control fields shielded via the closed metallic construction shields)



**Picture C.5 DASY 5**

### C.4.3. Measurement Server

The Measurement server is based on a PC/104 CPU board with CPU (DASY5: 400 MHz, Intel Celeron), chipdisk (DASY5: 128MB), RAM (DASY5: 128MB). The necessary circuits for communication with the DAE electronic box, as well as the 16 bit AD converter system for optical detection and digital I/O interface are contained on the DASY I/O board, which is directly connected to the PC/104 bus of the CPU board.