



TESTING LABORATORY
CERTIFICATE#4323.01



FCC SAR EVALUATION REPORT

For

Shanghai Sunmi Technology Co.,Ltd.

Room 605, Block 7, KIC Plaza, No.388 Song Hu Road, Yang Pu District, Shanghai 200433 China

FCC ID: 2AH25TF700

Report Type: Original Report		Product Type: WIRELESS DATA TERMINAL	
Test Engineer:	Bard Liu	<i>Bard Liu</i>	
Report Number:	RKSA200706002-20A		
Report Date:	2020-09-07		
Reviewed By:	Oscar Ye EMC Manager	<i>Oscar Ye</i>	
Test Laboratory:	Bay Area Compliance Laboratories Corp. (Kunshan) No.248 Chenghu Road,Kunshan,Jiangsu province,China Tel: +86-0512-86175000 Fax: +86-0512-88934268 www.baclcorp.com.cn		

Note: This test report is prepared for the customer shown above and for the equipment described herein. It may not be duplicated or used in part without prior written consent from Bay Area Compliance Laboratories Corp. This report is valid only with a valid digital signature. The digital signature may be available only under the Adobe software above version 7.0.

Attestation of Test Results			
EUT Information	EUT Description:	WIRELESS DATA TERMINAL	
	Tested Model:	TF700	
	FCC ID:	2AH25TF700	
	Serial Number:	RKSA200706002	
	Test Date:	2020-09-01~2020-09-02	
MODE		Max. SAR Level(s) Reported(W/kg)	Limit (W/kg)
Bluetooth	1g Body SAR	0.467	1.6
WLAN 2.4G	1g Body SAR	1.054	1.6
WLAN 5G	1g Body SAR	1.151	1.6
Applicable Standards	FCC 47 CFR part 2.1093 Radiofrequency radiation exposure evaluation: portable devices		
	RF Exposure Procedures: TCB Workshop April 2019		
	IEEE1528:2013 IEEE Recommended Practice for Determining the Peak Spatial-Average Specific Absorption Rate (SAR) in the Human Head from Wireless Communications Devices: Measurement Techniques		
	IEC 62209-2:2010 Human exposure to radio frequency fields from hand-held and body-mounted wireless communication devices-Human models, instrumentation, and procedures-Part 2: Procedure to determine the specific absorption rate (SAR) for wireless communication devices used in close proximity to the human body (frequency range of 30 MHz to 6 GHz)		
	KDB procedures KDB 447498 D01 General RF Exposure Guidance v06 KDB 865664 D01 SAR Measurement 100 MHz to 6 GHz v01r04 KDB 865664 D02 RF Exposure Reporting v01r02 KDB 248227 D01 802 .11 Wi-Fi SAR v02r02		
<p>Note: This wireless device has been shown to be capable of compliance for localized specific absorption rate (SAR) for General Population/Uncontrolled Exposure limits specified in FCC 47 CFR part 2.1093 and has been tested in accordance with the measurement procedures specified in IEEE 1528-2013 and RF exposure KDB procedures.</p> <p>The results and statements contained in this report pertain only to the device(s) evaluated.</p>			

TABLE OF CONTENTS

DOCUMENT REVISION HISTORY	4
EUT DESCRIPTION	5
TECHNICAL SPECIFICATION	5
REFERENCE, STANDARDS, AND GUIDELINES.....	6
SAR LIMITS	6
FACILITIES.....	7
DESCRIPTION OF TEST SYSTEM	8
EQUIPMENT LIST AND CALIBRATION	16
EQUIPMENTS LIST & CALIBRATION INFORMATION	16
SAR MEASUREMENT SYSTEM VERIFICATION	17
LIQUID VERIFICATION	17
SYSTEM ACCURACY VERIFICATION	18
SAR SYSTEM VALIDATION DATA.....	19
EUT TEST STRATEGY AND METHODOLOGY	22
TEST POSITIONS FOR DEVICE OPERATING NEXT TO A PERSON’S EAR.....	22
CHEEK/TOUCH POSITION	23
EAR/TILT POSITION	23
TEST POSITIONS FOR BODY-WORN AND OTHER CONFIGURATIONS.....	24
TEST DISTANCE FOR SAR EVALUATION	24
SAR EVALUATION PROCEDURE.....	25
CONDUCTED OUTPUT POWER MEASUREMENT	26
PROVISION APPLICABLE	26
TEST PROCEDURE	26
MAXIMUM TARGET OUTPUT POWER	26
TEST RESULTS:	28
STANDALONE SAR TEST EXCLUSION CONSIDERATIONS	31
ANTENNA DISTANCE TO EDGE	31
STANDALONE SAR TEST EXCLUSION CONSIDERATIONS.....	32
SAR TEST EXCLUSION FOR THE EUT EDGE CONSIDERATIONS RESULT	32
SAR MEASUREMENT RESULTS.....	33
SAR TEST DATA.....	33
SAR MEASUREMENT VARIABILITY	35
SAR SIMULTANEOUS TRANSMISSION DESCRIPTION	36
APPENDIX A SAR PLOTS	37
APPENDIX A MEASUREMENT UNCERTAINTY	38
APPENDIX B EUT TEST AND EXTERNAL POSITION PHOTOS.....	40
APPENDIX C PROBE AND DAE CALIBRATION CERTIFICATES.....	41
APPENDIX D DIPOLE CALIBRATION CERTIFICATES	42

DOCUMENT REVISION HISTORY

Revision Number	Report Number	Description of Revision	Date of Revision
1.0	RKSA200706002-20A	Original Report	2020-09-07

EUT DESCRIPTION

This report has been prepared on behalf of *Shanghai Sunmi Technology Co.,Ltd.* and their product **WIRELESS DATA TERMINAL**, Model: **TF700**, FCC ID: **2AH25TF700** or the EUT (Equipment under Test) as referred to in the rest of this report.

**All measurement and test data in this report was gathered from production sample serial number: RKSA200706002 (Assigned by BACL).The EUT supplied by the applicant was received on 2020-08-06.*

Technical Specification

Device Type:	Portable
Exposure Category:	Population / Uncontrolled
Antenna Type(s):	FPC Antenna
Body-Worn Accessories:	None
Operation Mode :	BT; WLAN; RLAN
Frequency Band:	BT: 2400-2483.5 MHz WLAN 2.4G: 2412-2462 MHz RLAN 5G: 5150-5250 MHz; 5725-5850 MHz
Conducted RF Power:	BT: 10.71 dBm WLAN 2.4G: 14.20 dBm RLAN 5G: 15.55 dBm
Power Supply:	DC 5.0/9.0/12.0/3.6~6.0/6.0~9.0/9.0~12.0V from adapter
Normal Operation:	Body supported

REFERENCE, STANDARDS, AND GUIDELINES

FCC:

The Report and Order requires routine SAR evaluation prior to equipment authorization of portable transmitter devices, including portable telephones. For consumer products, the applicable limit is 1.6 mW/g as recommended by the ANSI/IEEE standard C95.1-1992 [6] for an uncontrolled environment (Paragraph 65). According to the Supplement C of OET Bulletin 65 "Evaluating Compliance with FCC Guide-lines for Human Exposure to Radio frequency Electromagnetic Fields", released on Jun 29, 2001 by the FCC, the device should be evaluated at maximum output power (radiated from the antenna) under "worst-case" conditions for normal or intended use, incorporating normal antenna operating positions, device peak performance frequencies and positions for maximum RF energy coupling.

This report describes the methodology and results of experiments performed on wireless data terminal. The objective was to determine if there is RF radiation and if radiation is found, what is the extent of radiation with respect to safety limits. SAR (Specific Absorption Rate) is the measure of RF exposure determined by the amount of RF energy absorbed by human body (or its parts) – to determine how the RF energy couples to the body or head which is a primary health concern for body worn devices. The limit below which the exposure to RF is considered safe by regulatory bodies in North America is 1.6 mW/g average over 1 gram of tissue mass.

SAR Limits

FCC Limit

EXPOSURE LIMITS	SAR (W/kg)	
	(General Population / Uncontrolled Exposure Environment)	(Occupational / Controlled Exposure Environment)
Spatial Average (averaged over the whole body)	0.08	0.4
Spatial Peak (averaged over any 1 g of tissue)	1.60	8.0
Spatial Peak (hands/wrists/feet/ankles averaged over 10 g)	4.0	20.0

Population/Uncontrolled Environments are defined as locations where there is the exposure of individual who have no knowledge or control of their exposure.

Occupational/Controlled Environments are defined as locations where there is exposure that may be incurred by people who are aware of the potential for exposure (i.e. as a result of employment or occupation).

General Population/Uncontrolled environments Spatial Peak limit 4.0 W/kg (FCC) for 10g Extremity SAR applied to the EUT.

FACILITIES

The test site used by Bay Area Compliance Laboratories Corp. (Kunshan) to collect test data is located on the No.248 Chenghu Road, Kunshan, Jiangsu province, China.

Bay Area Compliance Laboratories Corp. (Kunshan) Lab is accredited to ISO/IEC 17025 by A2LA (Lab code: 4323.01) and the FCC designation No. CN1185 under the FCC KDB 974614 D01 and CAB identifier CN0004 under the ISED requirement. The facility also complies with the radiated and AC line conducted test site criteria set forth in ANSI C63.4-2014.

DESCRIPTION OF TEST SYSTEM

These measurements were performed with the automated near-field scanning system DASY6 from Schmid & Partner Engineering AG (SPEAG) which is the Fifth generation of the system shown in the figure hereinafter:



DASY6 System Description

The DASY6 system for performing compliance tests consists of the following items:

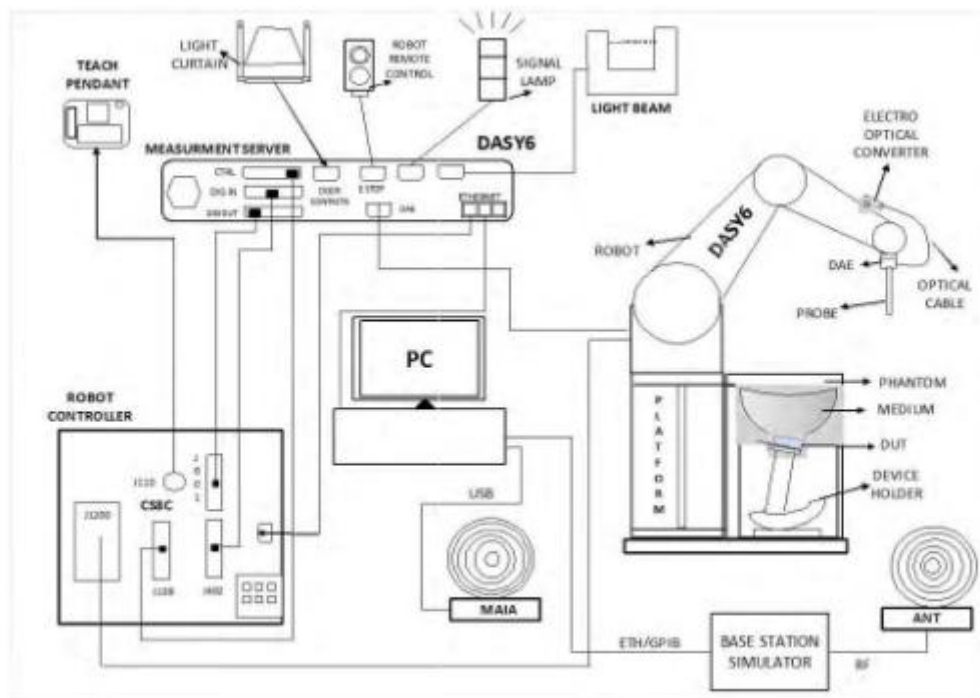

- A standard high precision 6-axis robot (Staubli TX=RX family) with controller, teach pendant and software. An arm extension for accommodating the data acquisition electronics (DAE).
- An isotropic field probe optimized and calibrated for the targeted measurement.
- A data acquisition electronics (DAE) which performs the signal application, signal multiplexing, AD-conversion, offset measurements, mechanical surface detection, collision detection, etc. The unit is battery powered with standard or rechargeable batteries. The signal is optically transmitted to the EOC.
- The Electro-optical converter (EOC) performs the conversion from optical to electrical signals for the digital communication to the DAE. To use optical surface detection, a special version of the EOC is required. The EOC signal is transmitted to the measurement server.
- The function of the measurement server is to perform the time critical tasks such as signal filtering, control of the robot operation and fast movement interrupts.
- The Light Beam used is for probe alignment. This improves the (absolute) accuracy of the probe positioning.
- A computer running Win7 professional operating system and the DASY52 software.
- Remote control and teach pendant as well as additional circuitry for robot safety such as warning lamps, etc.
- The phantom, the device holder and other accessories according to the targeted measurement.

DASY6 Measurement Server

The DASY6 measurement server is based on a PC/104 CPU board with a 400 MHz Intel ULV Celeron, 128 MB chip-disk and 128 MB RAM. The necessary circuits for communication with the DAE4 (or DAE3) electronics box, as well as the 16-bit AD converter system for optical detection and digital I/O interface are contained on the DASY6 I/O board, which is directly connected to the PC/104 bus of the CPU board.



The measurement server performs all real-time data evaluations of field measurements and surface detection, controls robot movements, and handles safety operations. The PC operating system cannot interfere with these time-critical processes. All connections are supervised by a watchdog, and disconnection of any of the cables to the measurement server will automatically disarm the robot and disable all program- controlled robot movements. Furthermore, the measurement server is equipped with an expansion port, which is reserved for future applications. Please note that this expansion port does not have a standardized pinout, and therefore only devices provided by SPEAG can be connected. Connection of devices from any other supplier could seriously damage the measurement server.

Data Acquisition Electronics

The data acquisition electronics (DAE4) consist of a highly sensitive electrometer-grade preamplifier with auto-zeroing, a channel and gain-switching multiplexer, a fast 16 bit AD-converter and a command decoder with a control logic unit. Transmission to the measurement server is accomplished through an optical downlink for data and status information, as well as an optical uplink for commands and the clock.

The mechanical probe mounting device includes two different sensor systems for frontal and sideways probe contacts. They are used for mechanical surface detection and probe collision detection.

The input impedance of both the DAE4 as well as of the DAE3 box is 200M Ω ; the inputs are symmetrical and floating. Common mode rejection is above 80 dB.

EX3DV4 E-Field Probes

Frequency	10 MHz to > 6 GHz Linearity: ± 0.2 dB (30 MHz to 6 GHz)
Directivity	± 0.3 dB in TSL (rotation around probe axis) ± 0.5 dB in TSL (rotation normal to probe axis)
Dynamic Range	10 µW/g to > 100 mW/g Linearity: ± 0.2 dB (noise: typically < 1 µW/g)
Dimensions	Overall length: 337 mm (Tip: 20 mm) Tip diameter: 2.5 mm (Body: 12 mm) Typical distance from probe tip to dipole centers: 1 mm
Application	High precision dosimetric measurements in any exposure scenario (e.g., very strong gradient fields); the only probe that enables compliance testing for frequencies up to 6 GHz with precision of better 30%.
Compatibility	DASY3, DASY4, DASY52 SAR and higher, EASY4/MRI

SAM Twin Phantom

The SAM Twin Phantom (shown in front of DASY6) is a fiberglass shell phantom with shell thickness 2 mm, except in the ear region where the thickness is increased to 6 mm. The phantom has three measurement areas: 1) Left Head, 2) Right Head, and 3) Flat Section. For larger devices, the use of the ELI-Phantom (shown behind DASY6) is required. For devices such as glasses with a wireless link, the Face Down Phantom is the most suitable (between the SAM Twin and ELI phantoms).

When the phantom is mounted inside allocated slot of the DASY6 platform, phantom reference points can be taught directly in the DASY5 V5.2 software. When the DASY6 platform is used to mount the Phantom, some of the phantom teaching points cannot be reached by the robot in DASY5 V5.2. A special tool called P1a-P2aX-Former is provided to transform two of the three points, P1 and P2, to reachable locations. To use these new teaching points, a revised phantom configuration file is required.

In addition to our standard broadband liquids, the phantom can be used with the following tissue simulating liquids:

Sugar-water-based liquids can be left permanently in the phantom. Always cover the liquid when the system is not in use to prevent changes in liquid parameters due to water evaporation.

DGBE-based liquids should be used with care. As DGBE is a softener for most plastics, the liquid should be taken out of the phantom, and the phantom should be dried when the system is not in use (desirable at least once a week).

Do not use other organic solvents without previously testing the solvent resistivity of the phantom.

Approximately 25 liters of liquid is required to fill the SAM Twin phantom.



ELI Phantom

The ELI phantom is intended for compliance testing of handheld and body-mounted wireless devices in the frequency range of 30MHz to 6 GHz. ELI is fully compatible with the latest draft of the standard IEC 62209-2 and the use of all known tissue simulating liquids. ELI has been optimized for performance and can be integrated into a SPEAG standard phantom table. A cover is provided to prevent evaporation of water and changes in liquid parameters. Reference markings on the phantom allow installation of the complete setup, including all predefined phantom positions and measurement grids, by teaching three points.

The phantom can be used with the following tissue simulating liquids:

- Sugar-water-based liquids can be left permanently in the phantom. Always cover the liquid when the system is not in use to prevent changes in liquid parameters due to water evaporation.
- DGBE-based liquids should be used with care. As DGBE is a softener for most plastics, the liquid should be taken out of the phantom, and the phantom should be dried when the system is not in use (desirable at least once a week).
- Do not use other organic solvents without previously testing the solvent resistivity of the phantom.

Approximately 25 liters of liquid is required to fill the ELI phantom.



Robots

The DASY6 system uses the high-precision industrial robots TX60L, TX90XL, and RX160L from Staubli SA (France). The TX robot family - the successor of the well-known RX robot family - continues to offer the features important for DASY6 applications:

- High precision (repeatability 0.02mm)
- High reliability (industrial design)
- Low maintenance costs (virtually maintenance free due to direct drive gears; no belt drives)
- Jerk-free straight movements (brushless synchrony motors; no stepper motors)
- Low ELF interference (motor control fields shielded via the closed metallic construction shields)

The robots are controlled by the Staubli CS8c robot controllers. All information regarding the use and maintenance of the robot arm and the robot controller is provided

Area Scans

Area scans are defined prior to the measurement process being executed with a user defined variable spacing between each measurement point (integral) allowing low uncertainty measurements to be conducted. Scans defined for FCC applications utilize a 15mm 2 step integral, with 1.5mm interpolation used to locate the peak SAR area used for zoom scan assessments.

Where the system identifies multiple SAR peaks (which are within 25% of peak value) the system will provide the user with the option of assessing each peak location individually for zoom scan averaging.

Zoom Scan (Cube Scan Averaging)

The averaging zoom scan volume utilized in the DASY5 software is in the shape of a cube and the side dimension of a 1 g or 10 g mass is dependent on the density of the liquid representing the simulated tissue. A density of 1000 kg/m^3 is used to represent the head and body tissue density and not the phantom liquid density, in order to be consistent with the definition of the liquid dielectric properties, i.e. the side length of the 1g cube is 10mm, with the side length of the 10g cube is 21.5mm.

When the cube intersects with the surface of the phantom, it is oriented so that 3 vertices touch the surface of the shell or the center of a face is tangent to the surface. The face of the cube closest to the surface is modified in order to conform to the tangent surface.

The zoom scan integer steps can be user defined so as to reduce uncertainty, but normal practice for typical test applications (including FCC) utilize a physical step of $7 \times 7 \times 7$ (5mmx5mmx5mm) providing a volume of 30 mm in the X & Y & Z axis.

Tissue Dielectric Parameters for Head and Body Phantoms

The head tissue dielectric parameters recommended by the IEC 62209-1:2016

Recommended Tissue Dielectric Parameters for Head liquid

Table A.3 – Dielectric properties of the head tissue-equivalent liquid

Frequency MHz	Relative permittivity ϵ_r	Conductivity (σ) S/m
300	45,3	0,87
450	43,5	0,87
<i>750</i>	<i>41,9</i>	<i>0,89</i>
835	41,5	0,90
900	41,5	0,97
1 450	40,5	1,20
<i>1 500</i>	<i>40,4</i>	<i>1,23</i>
<i>1 640</i>	<i>40,2</i>	<i>1,31</i>
<i>1 750</i>	<i>40,1</i>	<i>1,37</i>
1 800	40,0	1,40
1 900	40,0	1,40
2 000	40,0	1,40
<i>2 100</i>	<i>39,8</i>	<i>1,49</i>
<i>2 300</i>	<i>39,5</i>	<i>1,67</i>
2 450	39,2	1,80
<i>2 600</i>	<i>39,0</i>	<i>1,96</i>
3 000	38,5	2,40
<i>3 500</i>	<i>37,9</i>	<i>2,91</i>
<i>4 000</i>	<i>37,4</i>	<i>3,43</i>
<i>4 500</i>	<i>36,8</i>	<i>3,94</i>
<i>5 000</i>	<i>36,2</i>	<i>4,45</i>
<i>5 200</i>	<i>36,0</i>	<i>4,66</i>
<i>5 400</i>	<i>35,8</i>	<i>4,86</i>
<i>5 600</i>	<i>35,5</i>	<i>5,07</i>
<i>5 800</i>	<i>35,3</i>	<i>5,27</i>
6 000	35,1	5,48

NOTE For convenience, permittivity and conductivity values at those frequencies which are not part of the original data provided by Drossos et al. [33] or the extension to 5 800 MHz are provided (i.e. the values shown *in italics*). These values were linearly interpolated between the values in this table that are immediately above and below these values, except the values at 6 000 MHz that were linearly extrapolated from the values at 3 000 MHz and 5 800 MHz.

Note:

- 1, Effective February 19, 2019, FCC has permitted the use of single head-tissue simulating liquid specified in IEC 62209-1 for all SAR tests.
- 2, Mix and Match of traditional FCC SAR TSLs and IEC 62209-1 TSL in a single application is not permitted TSL can be changed in a Permissive Change.
- 3, If SAR increases and original SAR > 1.2 W/kg, additional SAR measurements will be required IEC 62209-1 TSL is an alternative, not mandatory at this time.
- 4, If FCC parameters are used, $\pm 5\%$ tolerance. If IEC parameters, $\pm 10\%$.
- 5, In this case, IEC parameters applied.

Calibration Frequency Points for EX3DV4 E-Field Probes SN: 7557 Calibrated: 2019/10/04

Calibration Frequency Point(MHz)	Frequency Range(MHz)		Conversion Factor		
	From	To	X	Y	Z
750 Head	650	810	10.41	10.41	10.41
835 Head	810	935	10.10	10.10	10.10
1750 Head	1650	1810	8.67	8.67	8.67
1900 Head	1810	2000	8.36	8.36	8.36
2300 Head	2200	2399	7.79	7.79	7.79
2450 Head	2399	2500	7.41	7.41	7.41
2600 Head	2500	2700	7.21	7.21	7.21
5250 Head	5140	5360	5.38	5.38	5.38
5600 Head	5490	5700	4.75	4.75	4.75
5800 Head	5700	5910	4.70	4.70	4.70

EQUIPMENT LIST AND CALIBRATION

Equipments List & Calibration Information

Equipment	Model	S/N	Calibration Date	Calibration Due Date
DASY5 Test Software	DASY52 52.10.2	N/A	NCR	NCR
DASY6 Measurement Server	DASY6 6.0.31	N/A	NCR	NCR
Data Acquisition Electronics	DAE4	527	2020/07/09	2021/07/08
E-Field Probe	EX3DV4	7557	2019/10/04	2020/10/03
Mounting Device	MD4HHTV5	SD 000 H01 KA	NCR	NCR
Twin-SAM Phantom	QD 000 P41 AX	1963	NCR	NCR
Dipole, 2450MHz	D2450V2	970	2018/06/26	2021/06/25
Dipole, 5GHz	D5GHzV2	1296	2019/10/03	2022/10/02
Simulated Tissue Liquid Head	HBBL600-6000V6	180611-3	Each Time	
Network Analyzer	8753B	3625A00809	2019/12/14	2020/12/13
Dielectric Assessment Kit	DAK-3.5	SM DAK 300AB	NCR	NCR
Signal Generator	N5182B	MY53051592	2019/12/14	2020/12/13
Power Meter	E4419B	GB43312421	2020/08/05	2021/08/04
Power Amplifier	5S1G4	71377	NCR	NCR
Directional Coupler	4242-10	3307	NCR	NCR
Attenuator	3dB	5402	NCR	NCR
Attenuator	10dB	AU 3842	NCR	NCR
Signal Analyzer	FSV40	101116	2020-07-23	2021-07-22

SAR MEASUREMENT SYSTEM VERIFICATION

Liquid Verification

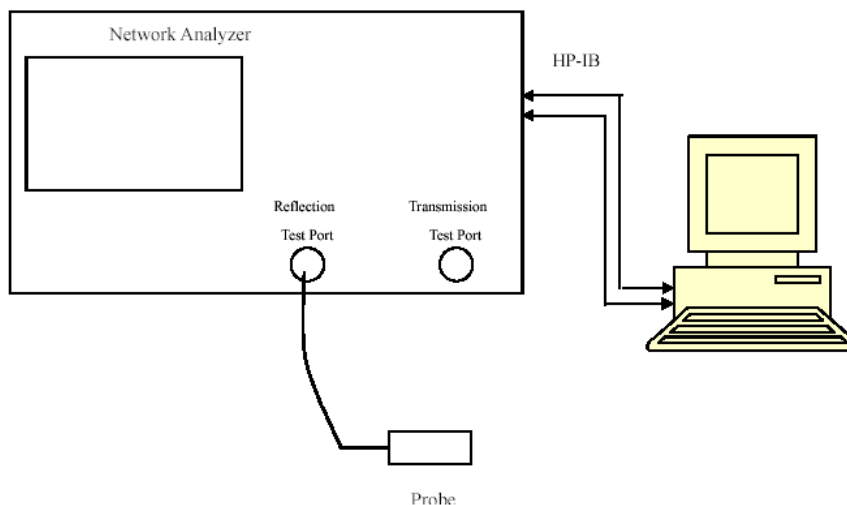

Liquid Verification Setup Block Diagram

Liquid Verification Results

Frequency (MHz)	Liquid Type	Liquid Parameter		Target Value		Delta (%)		Tolerance (%)
		ϵ_r	σ (S/m)	ϵ_r	σ (S/m)	$\Delta \epsilon_r$	$\Delta \sigma$	
2450	Head	37.602	1.837	39.20	1.80	-4.08	2.06	± 5
2412	Head	37.765	1.794	39.26	1.76	-3.81	1.93	± 5
2437	Head	37.66	1.823	39.22	1.79	-3.98	1.84	± 5
2462	Head	37.548	1.851	39.18	1.81	-4.17	2.27	± 5
2402	Head	37.806	1.783	39.27	1.76	-3.73	1.31	± 5
5250	Head	37.469	4.732	35.95	4.71	4.23	0.47	± 5
5210	Head	37.516	4.693	35.99	4.67	4.24	0.49	± 5

*Liquid Verification was performed on 2020/09/01

Frequency (MHz)	Liquid Type	Liquid Parameter		Target Value		Delta (%)		Tolerance (%)
		ϵ_r	σ (S/m)	ϵ_r	σ (S/m)	$\Delta \epsilon_r$	$\Delta \sigma$	
5800	Head	36.713	5.301	35.30	5.27	4.00	0.59	± 5
5775	Head	36.75	5.275	35.33	5.24	4.02	0.67	± 5

*Liquid Verification was performed on 2020/09/02

System Accuracy Verification

Prior to the assessment, the system validation kit was used to test whether the system was operating within its specifications of $\pm 10\%$. The validation results are tabulated below. And also the corresponding SAR plot is attached as well in the SAR plots files.

The spacing distances in the **System Verification Setup Block Diagram** is given by the following:

- a) $s = 15 \text{ mm} \pm 0,2 \text{ mm}$ for $300 \text{ MHz} \leq f \leq 1 \text{ 000 MHz}$;
- b) $s = 10 \text{ mm} \pm 0,2 \text{ mm}$ for $1 \text{ 000 MHz} < f \leq 3 \text{ 000 MHz}$;
- c) $s = 10 \text{ mm} \pm 0,2 \text{ mm}$ for $3 \text{ 000 MHz} < f \leq 6 \text{ 000 MHz}$.

System Verification Setup Block Diagram

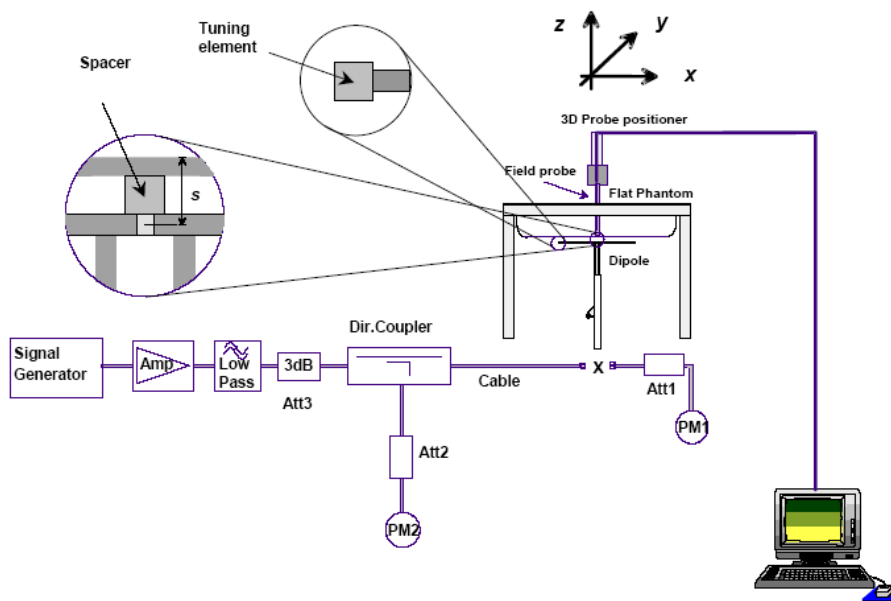

System Accuracy Check Results

Date	Frequency Band (MHz)	Liquid Type	Input Power (mW)	Measured SAR (W/kg)	Normalized to 1W (W/kg)	Target Value (W/Kg)	Delta (%)	Tolerance (%)
2020/09/01	2450	Head	250	1g 14.30	57.2	53.30	7.32	± 10
2020/09/01	5250	Head	100	1g 8.11	81.1	79.20	2.40	± 10
2020/09/02	5800	Head	100	1g 7.86	78.6	79.90	-1.63	± 10

*The SAR values above are normalized to 1 Watt forward power.

SAR SYSTEM VALIDATION DATA

System Performance 2450MHz Head

DUT: Dipole 2450 MHz; Type: D2450V2; Serial: 970

Communication System: UID 0; Frequency: 2450 MHz;Duty Cycle: 1:1
 Medium parameters used: f = 2450 MHz; $\sigma = 1.837$ S/m; $\epsilon_r = 37.602$; $\rho = 1000$ kg/m³

DASY5 Configuration:

- Probe: EX3DV4 - SN7557; ConvF(7.41, 7.41, 7.41); Calibrated: 10/4/2019
- Sensor-Surface: 1.4mm (Mechanical Surface Detection)
- Electronics: DAE4 Sn527; Calibrated: 7/9/2020
- Phantom: ELI V8.0; Type: QD OVA 004 Ax; Serial: 2095
- Measurement SW: DASY52, Version 52.10 (1); SEMCAD X Version 14.6.11 (7437)

Area Scan (91x91x1): Interpolated grid: dx=1.200 mm, dy=1.200 mm

Maximum value of SAR (interpolated) = 18.0 W/kg

Zoom Scan (7x7x7)/Cube 0: Measurement grid: dx=5mm, dy=5mm, dz=5mm

Reference Value = 98.20 V/m; Power Drift = -0.01 dB

Peak SAR (extrapolated) = 30.6 W/kg

SAR(1 g) = 14.3 W/kg; SAR(10 g) = 6.62 W/kg

Maximum value of SAR (measured) = 16.9 W/kg

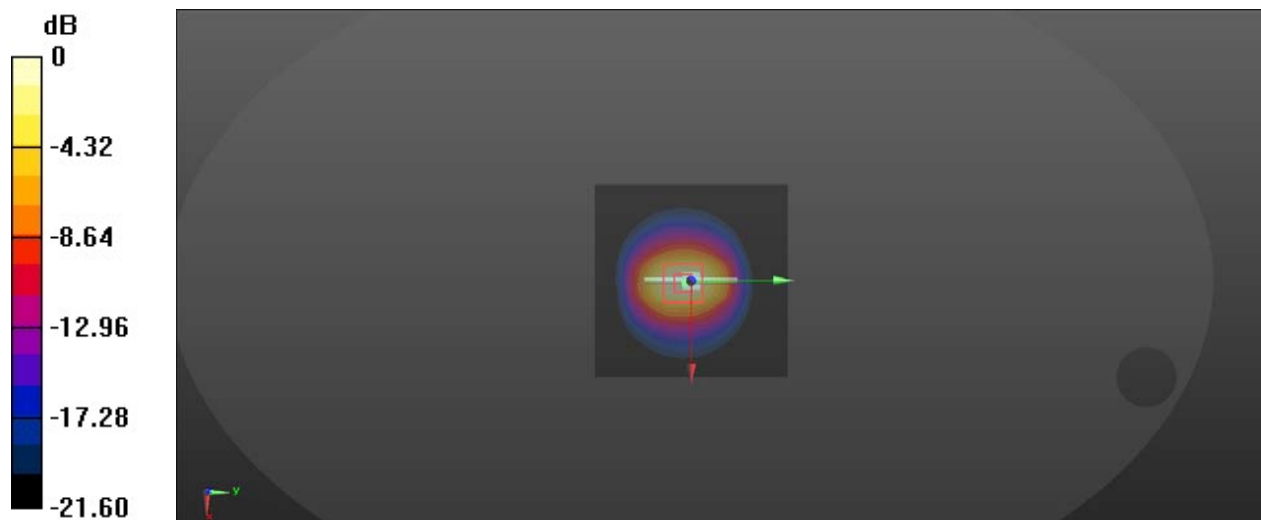

0 dB = 16.9 W/kg = 12.28 dBW/kg

System Performance 5250MHz Head

DUT: Dipole 5GHz; Type: D 5GHzV2; Serial: 1296

Communication System: UID 0; Frequency: 5250 MHz; Duty Cycle: 1:1

Medium parameters used: $f = 5250$ MHz; $\sigma = 4.732$ S/m; $\epsilon_r = 37.469$; $\rho = 1000$ kg/m³

DASY5 Configuration:

- Probe: EX3DV4 - SN7557; ConvF(5.38, 5.38, 5.38); Calibrated: 10/4/2019
- Sensor-Surface: 1.4mm (Mechanical Surface Detection)
- Electronics: DAE4 Sn527; Calibrated: 7/9/2020
- Phantom: ELI V8.0; Type: QD OVA 004 Ax; Serial: 2095
- Measurement SW: DASY52, Version 52.10 (1); SEMCAD X Version 14.6.11 (7437)

Area Scan (81x81x1): Interpolated grid: dx=1.000 mm, dy=1.000 mm

Maximum value of SAR (interpolated) = 9.30 W/kg

Zoom Scan (8x8x7)/Cube 0: Measurement grid: dx=4mm, dy=4mm, dz=1.4mm

Reference Value = 42.73 V/m; Power Drift = 0.03 dB

Peak SAR (extrapolated) = 29.8 W/kg

SAR(1 g) = 8.11 W/kg; SAR(10 g) = 2.35 W/kg

Maximum value of SAR (measured) = 9.00 W/kg

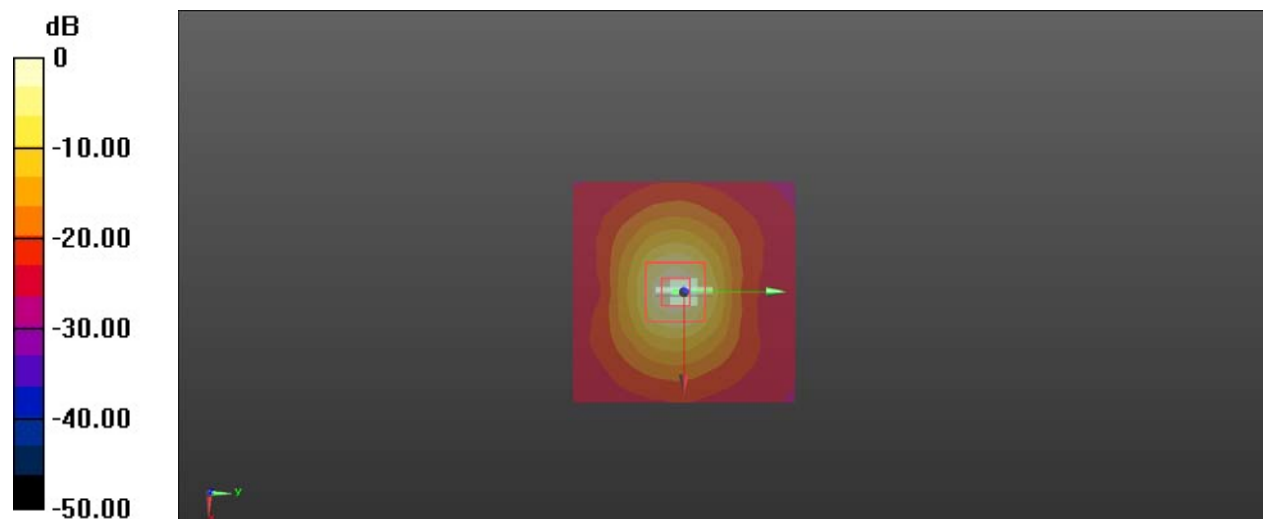

0 dB = 9.00 W/kg = 9.54 dBW/kg

System Performance 5800MHz Head

DUT: Dipole 5GHz; Type: D 5GHzV2; Serial: 1296

Communication System: UID 0; Frequency: 5800 MHz;Duty Cycle: 1:1

Medium parameters used: f = 5800 MHz; σ =5.301 S/m; ϵ_r = 36.713; ρ = 1000 kg/m³

DASY5 Configuration:

- Probe: EX3DV4 - SN7557; ConvF(4.7, 4.7, 4.7); Calibrated: 10/4/2019
- Sensor-Surface: 1.4mm (Mechanical Surface Detection)
- Electronics: DAE4 Sn527; Calibrated: 7/9/2020
- Phantom: ELI V8.0; Type: QD OVA 004 Ax; Serial: 2095
- Measurement SW: DASY52, Version 52.10 (1); SEMCAD X Version 14.6.11 (7437)

Area Scan (81x81x1): Interpolated grid: dx=1.000 mm, dy=1.000 mm

Maximum value of SAR (interpolated) = 8.81 W/kg

Zoom Scan (8x8x7)/Cube 0: Measurement grid: dx=4mm, dy=4mm, dz=1.4mm

Reference Value = 39.09 V/m; Power Drift = -0.03 dB

Peak SAR (extrapolated) = 32.3 W/kg

SAR(1 g) = 7.86 W/kg; SAR(10 g) = 2.25 W/kg

Maximum value of SAR (measured) = 8.82 W/kg

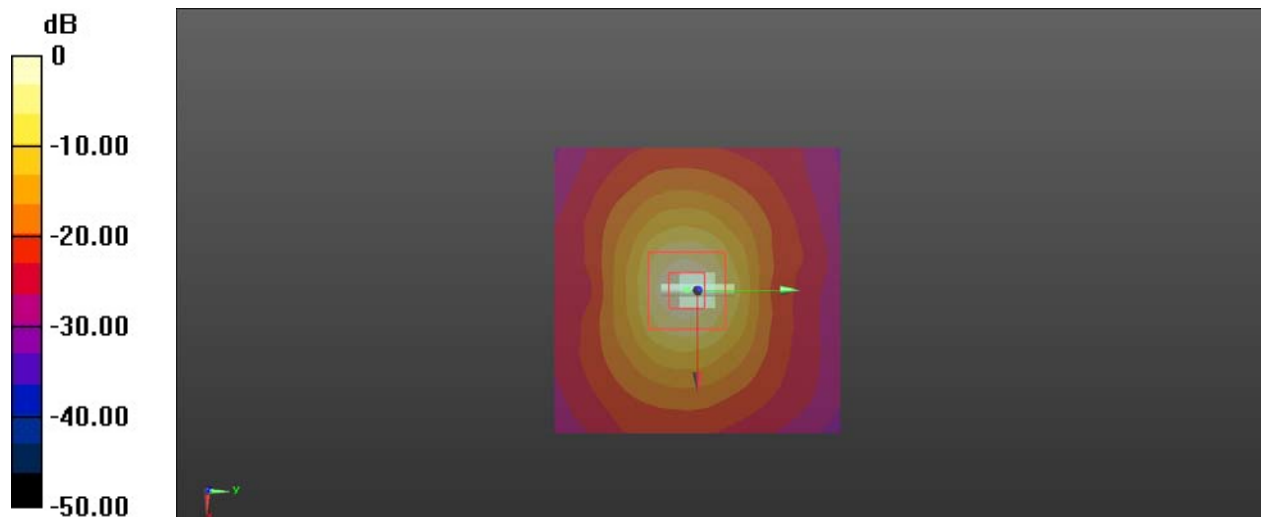

0 dB = 8.82 W/kg = 9.45 dBW/kg

EUT TEST STRATEGY AND METHODOLOGY

Test Positions for Device Operating Next to a Person’s Ear

This category includes most wireless handsets with fixed, retractable or internal antennas located toward the top half of the device, with or without a foldout, sliding or similar keypad cover. The handset should have its earpiece located within the upper ¼ of the device, either along the centerline or off-centered, as perceived by its users. This type of handset should be positioned in a normal operating position with the “test device reference point” located along the “vertical centerline” on the front of the device aligned to the “ear reference point”. The “test device reference point” should be located at the same level as the center of the earpiece region. The “vertical centerline” should bisect the front surface of the handset at its top and bottom edges. A “ear reference point” is located on the outer surface of the head phantom on each ear spacer. It is located 1.5 cm above the center of the ear canal entrance in the “phantom reference plane” defined by the three lines joining the center of each “ear reference point” (left and right) and the tip of the mouth.

A handset should be initially positioned with the earpiece region pressed against the ear spacer of a head phantom. For the SCC-34/SC-2 head phantom, the device should be positioned parallel to the “N-F” line defined along the base of the ear spacer that contains the “ear reference point”. For interim head phantoms, the device should be positioned parallel to the cheek for maximum RF energy coupling. The “test device reference point” is aligned to the “ear reference point” on the head phantom and the “vertical centerline” is aligned to the “phantom reference plane”. This is called the “initial ear position”. While maintaining these three alignments, the body of the handset is gradually adjusted to each of the following positions for evaluating SAR:

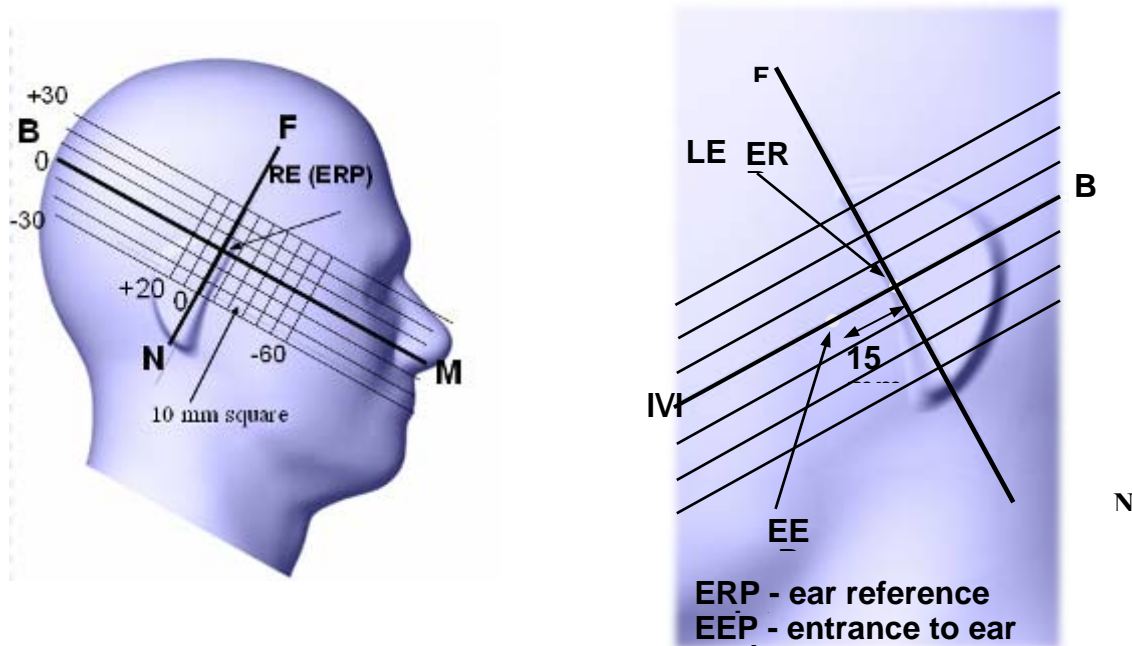

Cheek/Touch Position

The device is brought toward the mouth of the head phantom by pivoting against the “ear reference point” or along the “N-F” line for the SCC-34/SC-2 head phantom.

This test position is established:

When any point on the display, keypad or mouthpiece portions of the handset is in contact with the phantom.

(or) When any portion of a foldout, sliding or similar keypad cover opened to its intended self-adjusting normal use position is in contact with the cheek or mouth of the phantom.

For existing head phantoms – when the handset loses contact with the phantom at the pivoting point, rotation should continue until the device touches the cheek of the phantom or breaks its last contact from the ear spacer.

Cheek /Touch Position



Ear/Tilt Position

With the handset aligned in the “Cheek/Touch Position”:

1) If the earpiece of the handset is not in full contact with the phantom’s ear spacer (in the “Cheek/Touch position”) and the peak SAR location for the “Cheek/Touch” position is located at the ear spacer region or corresponds to the earpiece region of the handset, the device should be returned to the “initial ear position” by rotating it away from the mouth until the earpiece is in full contact with the ear spacer.

2) (otherwise) The handset should be moved (translated) away from the cheek perpendicular to the line passes through both “ear reference points” (note: one of these ear reference points may not physically exist on a split head model) for approximate 2-3 cm. While it is in this position, the device handset is tilted away from the mouth with respect to the “test device reference point” until the inside angle between the vertical centerline on the front surface of the phone and the horizontal line passing through the ear reference point is by 15 80°. After the tilt, it is then moved (translated) back toward the head perpendicular to the line passes through both “ear reference points” until the device touches the phantom or the ear spacer. If the antenna touches the head first, the positioning process should be repeated with a tilt angle less than 15° so that the device and its antenna would touch the phantom simultaneously. This test position may require a device holder or positioner to achieve the translation and tilting with acceptable positioning repeatability.

If a device is also designed to transmit with its keypad cover closed for operating in the head position, such positions should also be considered in the SAR evaluation. The device should be tested on the left and right side of the head phantom in the “Cheek/Touch” and “Ear/Tilt” positions. When applicable, each configuration should be tested with the antenna in its fully extended and fully retracted positions. These test configurations should be tested at the high, middle and low frequency channels of each operating mode; for example, AMPS, CDMA, and TDMA. If the SAR measured at the middle channel for each test configuration (left, right, Cheek/Touch, Tilt/Ear, extended and retracted) is at least 2.0 dB lower than the SAR limit, testing at the high and low channels is optional for such test configuration(s). If the transmission band of the test device is less than 10 MHz, testing at the high and low frequency channels is optional.

Ear /Tilt 15° Position

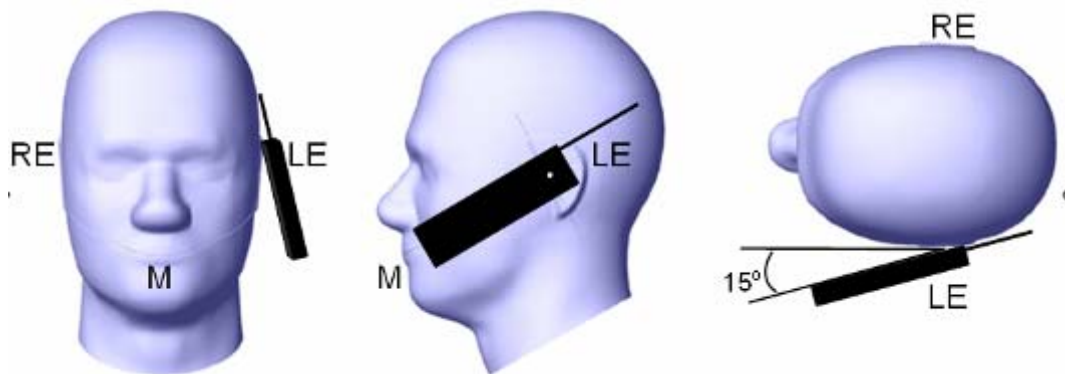

Test positions for body-worn and other configurations

Body-worn operating configurations should be tested with the belt-clips and holsters attached to the device and positioned against a flat phantom in normal use configurations. Devices with a headset output should be tested with a headset connected to the device. When multiple accessories that do not contain metallic components are supplied with the device, the device may be tested with only the accessory that dictates the closest spacing to the body. When multiple accessories that contain metallic components are supplied with the device, the device must be tested with each accessory that contains a unique metallic component. If multiple accessories share an identical metallic component (e.g., the same metallic belt-clip used with different holsters with no other metallic components), only the accessory that dictates the closest spacing to the body must be tested.

Body-worn accessories may not always be supplied or available as options for some devices that are intended to be authorized for body-worn use. A separation distance of 1.5 cm between the back of the device and a flat phantom is recommended for testing body-worn SAR compliance under such circumstances. Other separation distances may be used, but they should not exceed 2.5 cm. In these cases, the device may use body-worn accessories that provide a separation distance greater than that tested for the device provided however that the accessory contains no metallic components.



Figure 5 – Test positions for body-worn devices

Test Distance for SAR Evaluation

In this case the EUT(Equipment Under Test) is set against from the phantom, the test distance is 0mm.

SAR Evaluation Procedure

The evaluation was performed with the following procedure:

Step 1: Measurement of the SAR value at a fixed location above the ear point or central position was used as a reference value for assessing the power drop. The SAR at this point is measured at the start of the test and then again at the end of the testing.

Step 2: The SAR distribution at the exposed side of the head was measured at a distance of 4 mm from the inner surface of the shell. The area covered the entire dimension of the head or radiating structures of the EUT, the horizontal grid spacing was 15 mm x 15 mm, and the SAR distribution was determined by integrated grid of 1.5mm x 1.5mm. Based on these data, the area of the maximum absorption was determined by spline interpolation. The first Area Scan covers the entire dimension of the EUT to ensure that the hotspot was correctly identified.

Step 3: Around this point, a volume of 30 mm x 30 mm x 30 mm was assessed by measuring 7x 7 x 7 points. On the basis of this data set, the spatial peak SAR value was evaluated under the following procedure:

- 1) The data at the surface were extrapolated, since the center of the dipoles is 1.2 mm away from the tip of the probe and the distance between the surface and the lowest measuring point is 1.3 mm. The extrapolation was based on a least square algorithm. A polynomial of the fourth order was calculated through the points in z-axes. This polynomial was then used to evaluate the points between the surface and the probe tip.

- 2) The maximum interpolated value was searched with a straightforward algorithm. Around this maximum the SAR values averaged over the spatial volumes (1 g or 10 g) were computed by the 3D-Spline interpolation algorithm. The 3D-Spline is composed of three one dimensional splines with the "Not a knot"-condition (in x, y and z-directions). The volume was integrated with the trapezoidal-algorithm. One thousand points (10 x 10 x 10) were interpolated to calculate the averages.

All neighboring volumes were evaluated until no neighboring volume with a higher average value was found.

Step 4: Re-measurement of the SAR value at the same location as in Step 1. If the value changed by more than 5%, the evaluation was repeated.

CONDUCTED OUTPUT POWER MEASUREMENT

Provision Applicable

The measured peak output power should be greater and within 5% than EMI measurement.

Test Procedure

The RF output of the transmitter was connected to the input of the Power Meter through Connector.

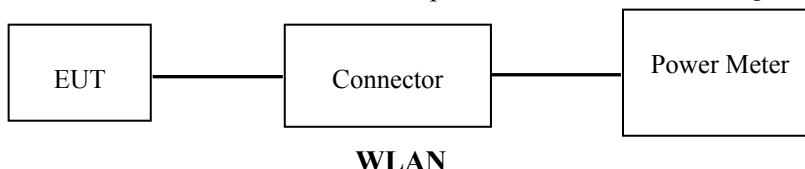

Maximum Target Output Power

WLAN 2.4G

Max Target Power(dBm)			
Mode/Band	Channel		
	Low	Middle	High
WLAN 2.4G(802.11b)	14	14.5	14.5
WLAN 2.4G(802.11g)	11.5	11.5	11.5
WLAN 2.4G(802.11n HT20)	10.5	10.5	10.5
WLAN 2.4G(802.11n HT40)	10.5	10.5	10.5

Bluetooth:

Max Target Power(dBm)			
Mode/Band	Channel		
	Low	Middle	High
BDR(GFSK)	11	11	11
EDR($\pi/4$ -DQPSK)	10.5	10.5	10.5
EDR(8DPSK)	10.5	10.5	10.5

BLE:

Max Target Power(dBm)			
Mode/Band	Channel		
	Low	Middle	High
BLE(1Mbps)	0.5	0.5	0.5
BLE(2Mbps)	0.5	0.5	0.5

WLAN 5.2G

Max Target Power(dBm)			
Mode/Band	Channel		
	Low	Middle	High
WLAN 5G(802.11a)	15.5	15.5	15.5
WLAN 5G(802.11n HT20)	15.5	15.5	15.5
WLAN 5G(802.11n HT40)	15.5	15.5	15.5
WLAN 5G(802.11ac VHT20)	15.5	15.5	15.5
WLAN 5G(802.11ac VHT40)	15.5	15.5	15.5
WLAN 5G(802.11ac VHT80)	15.5	15.5	15.5

WLAN 5.8G

Max Target Power(dBm)			
Mode/Band	Channel		
	Low	Middle	High
WLAN 5G(802.11a)	14	14	14
WLAN 5G(802.11n HT20)	14	14	14
WLAN 5G(802.11n HT40)	14	14	14
WLAN 5G(802.11ac VHT20)	14	14	14
WLAN 5G(802.11ac VHT40)	14	14	14
WLAN 5G(802.11ac VHT80)	14	14	14

Test Results:

WLAN 2.4G:

Mode	Channel frequency (MHz)	Data Rate	Average Output Power(dBm)
802.11b	2412	1Mbps	13.80
	2437		14.20
	2462		14.12
802.11g	2412	6Mbps	10.38
	2437		10.43
	2462		10.45
802.11n HT20	2412	MCS0	9.26
	2437		9.21
	2462		9.42
802.11n HT40	2422	MCS0	9.32
	2437		9.81
	2452		9.43

Bluetooth:

Mode	Frequency (MHz)	Max Conducted Peak Output Power (dBm)
BDR (GFSK)	2402	10.71
	2441	10.35
	2480	10.60
EDR ($\pi/4$-DQPSK)	2402	10.10
	2441	9.64
	2480	10.16
EDR (8DPSK)	2402	10.33
	2441	9.96
	2480	10.27

BLE:

Channel	Frequency (MHz)	Max Conducted Peak Output Power (dBm)
BLE(1Mbps) Mode		
Low	2402	0.08
Middle	2440	-0.47
High	2480	0.34
BLE(2Mbps) Mode		
Low	2402	0.21
Middle	2440	-0.43
High	2480	0.41

WLAN 5.2G:

Mode	Channel frequency (MHz)	Data Rate	Average Output Power(dBm)
802.11a	5180	6Mbps	14.23
	5200		14.74
	5240		15.17
802.11n HT20	5180	MCS0	14.08
	5200		14.53
	5240		15.01
802.11n HT40	5190	MCS0	14.63
	5230		15.11
802.11ac VHT20	5180	MCS0	14.11
	5200		14.55
	5240		14.95
802.11 ac VHT40	5190	MCS0	14.65
	5230		15.08
802.11 ac VHT80	5210	MCS0	14.05

WLAN 5.8G:

Mode	Channel frequency (MHz)	Data Rate	Average Output Power(dBm)
802.11a	5745	6Mbps	13.80
	5785		13.50
	5825		12.65
802.11n HT20	5745	MCS0	13.71
	5785		13.36
	5825		12.55
802.11n HT40	5755	MCS0	13.93
	5795		13.49
802.11ac VHT20	5745	MCS0	13.68
	5785		13.32
	5825		12.46
802.11 ac VHT40	5755	MCS0	13.80
	5795		13.45
802.11 ac VHT80	5775	MCS0	13.01

Standalone SAR test exclusion considerations

Antennas Location:

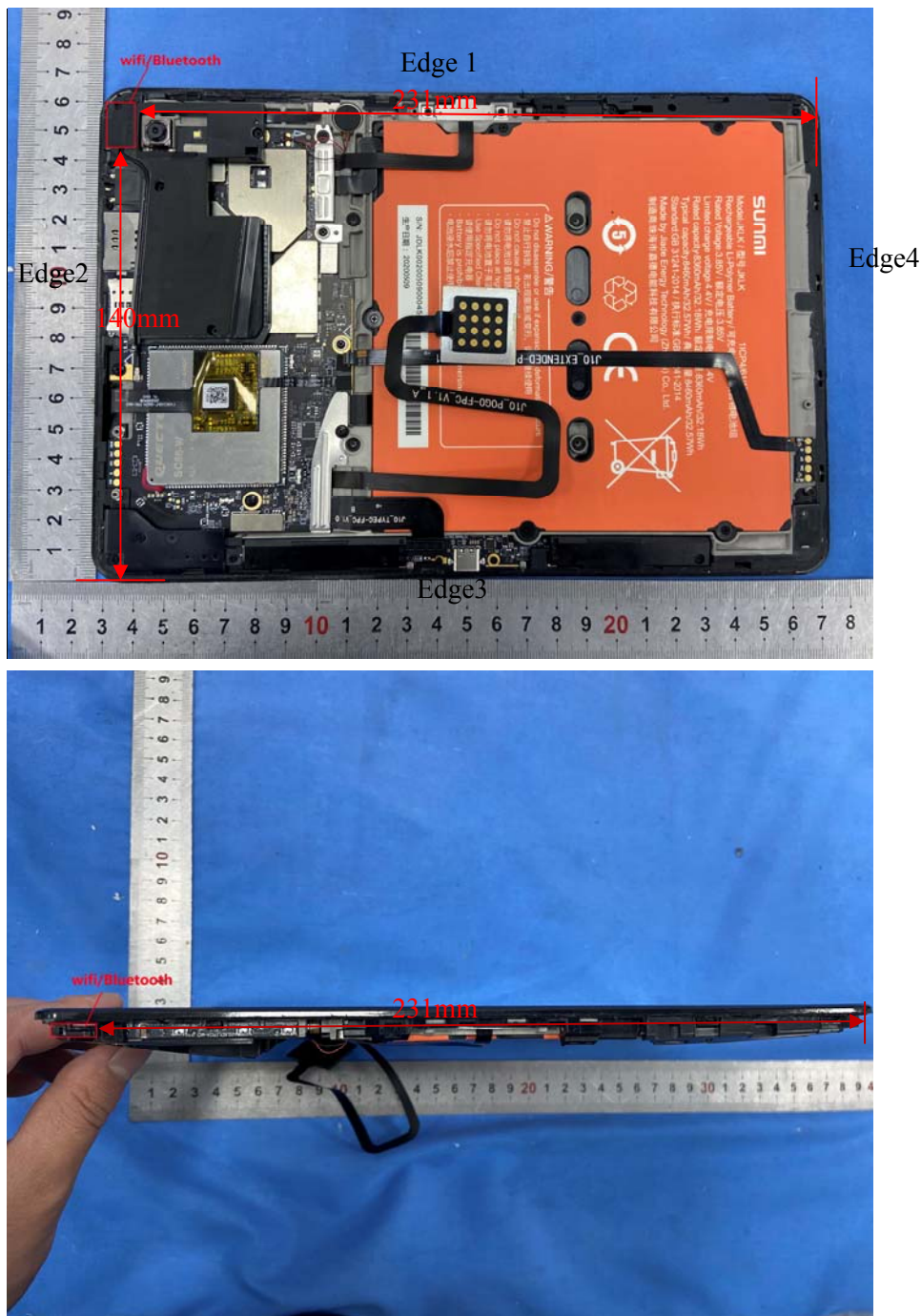

Antenna Distance To Edge

Antenna	Antenna Distance To Edge(mm)					
	Edge4	Edge 2	Front	Back	Edge 1	Edge3
Wi-Fi/Bluetooth	231	<5	<5	<5	<5	140

Standalone SAR test exclusion considerations

Mode	Frequency (MHz)	Pavg (dBm)	Pavg (mW)	Test Exclusion Distance(mm)
WLAN 2.4G Antenna	2462	14.5	28.18	43
Bluetooth Antenna	2480	11	12.59	42
WLAN 5G Antenna	5775	14	25.12	46

SAR test exclusion for the EUT edge considerations Result

Mode	Edge4	Edge 2	Front	Back	Edge 1	Edge3
WLAN Antenna	Exclusion	Required	Required	Required	Required	Exclusion

Note:

Required: The distance is less than **Test Exclusion Distance**, the SAR test is required.

Exclusion: The distance is larger than **Test Exclusion Distance**, the SAR test is not required.

NOTE:

The 1-g and 10-g SAR test exclusion thresholds for 100 MHz to 6 GHz at test separation distances ≤ 50 mm are determined by:

$$[(\text{max. power of channel, including tune-up tolerance, mW}) / (\text{min. test separation distance, mm})] \cdot [\sqrt{f(\text{GHz})}] \leq 3.0 \text{ for 1-g SAR and } \leq 7.5 \text{ for 10-g extremity SAR, where}$$

1. $f(\text{GHz})$ is the RF channel transmit frequency in GHz.

2. Power and distance are rounded to the nearest mW and mm before calculation.

3. The result is rounded to one decimal place for comparison.

4. When the minimum test separation distance is < 5 mm, a distance of 5 mm is applied to determine SAR test Exclusion.

SAR MEASUREMENT RESULTS

This page summarizes the results of the performed dosimetric evaluation.

SAR Test Data

Environmental Conditions

Temperature:	22-24°C	22.3-23.8°C
Relative Humidity:	40-60 %	42-59 %
ATM Pressure:	101.9 kPa	101.8 kPa
Test Date:	2020/09/01	2020/09/02

Testing was performed by Bard liu.

WLAN 2.4G:

EUT Position	Frequency (MHz)	Test Mode	Max. Meas. Power (dBm)	Max. Rated Power (dBm)	1g SAR (W/kg)			
					Scaled Factor	Meas. SAR	Scaled SAR	Plot
Body Front(0mm)	2412	802.11b	13.80	14	1.047	0.969	1.015	/
	2437	802.11b	14.20	14.5	1.072	0.984	1.054	#1
	2462	802.11b	14.12	14.5	1.091	0.918	1.002	/
Body Back(0mm)	2437	802.11b	14.20	14.5	1.072	0.476	0.498	/
Body Edge1(0mm)	2437	802.11b	14.20	14.5	1.072	0.109	0.114	/
Body Edge2(0mm)	2412	802.11b	13.80	14	1.047	0.909	0.952	/
	2437	802.11b	14.20	14.5	1.072	0.966	1.035	/
	2462	802.11b	14.12	14.5	1.091	0.951	1.038	/

Bluetooth:

EUT Position	Frequency (MHz)	Test Mode	Max. Meas. Power (dBm)	Max. Rated Power (dBm)	1g SAR (W/kg)			
					Scaled Factor	Meas. SAR	Scaled SAR	Plot
Body Front(0mm)	2402	BDR (GFSK)	10.71	11	1.069	0.344	0.368	#2
Body Back(0mm)	2402	BDR (GFSK)	10.71	11	1.069	0.320	0.342	/
Body Edge1(0mm)	2402	BDR (GFSK)	10.71	11	1.069	0.092	0.098	/
Body Edge2(0mm)	2402	BDR (GFSK)	10.71	11	1.069	0.437	0.467	#3

WLAN 5.2G:

EUT Position	Frequency (MHz)	Test Mode	Max. Meas. Power (dBm)	Max. Rated Power (dBm)	1g SAR (W/kg)			
					Scaled Factor	Meas. SAR	Scaled SAR	Plot
Body Front(0mm)	5210	802.11ac -VHT80	14.05	15.5	1.396	0.624	0.871	#4
Body Back(0mm)	5210	802.11ac -VHT80	14.05	15.5	1.396	0.494	0.690	/
Body Edge1(0mm)	5210	802.11ac -VHT80	14.05	15.5	1.396	0.255	0.314	/
Body Edge2(0mm)	5210	802.11ac -VHT80	14.05	15.5	1.396	0.824	1.151	#5

WLAN5.8G

EUT Position	Frequency (MHz)	Test Mode	Max. Meas. Power (dBm)	Max. Rated Power (dBm)	1g SAR (W/kg)			
					Scaled Factor	Meas. SAR	Scaled SAR	Plot
Body Front(0mm)	5775	802.11ac -VHT80	13.01	14	1.256	0.172	0.216	/
Body Back(0mm)	5775	802.11ac -VHT80	13.01	14	1.256	0.225	0.283	#6
Body Edge1(0mm)	5775	802.11ac -VHT80	13.01	14	1.256	0.042	0.053	/
Body Edge2(0mm)	5775	802.11ac -VHT80	13.01	14	1.256	0.275	0.345	#7

Note:

1. When the SAR Value is less than half of the limit, testing for other channels are optional.
2. The EUT transmit and receive through the same antenna while testing SAR.
3. When SAR or MPE is not measured at the maximum power level allowed for production units, the results must be scaled to the maximum tune-up tolerance limit according to the power applied to the individual channels tested to determine compliance.
4. KDB 248227 D01-SAR measurement is not required for 2.4 GHz OFDM(801.11g/n) when the highest reported SAR for DSSS(802.11b) is ≤ 1.2 W/kg.

SAR Measurement Variability

In accordance with published RF Exposure KDB procedure 865664 D01 SAR measurement 100 MHz to 6 GHz v01. These additional measurements are repeated after the completion of all measurements requiring the same head or body tissue-equivalent medium in a frequency band. The test device should be returned to ambient conditions (normal room temperature) with the battery fully charged before it is re-mounted on the device holder for the repeated measurement(s) to minimize any unexpected variations in the repeated results

- 1) Repeated measurement is not required when the original highest measured SAR is < 0.80 W/kg; steps 2) through 4) do not apply.
- 2) When the original highest measured SAR is ≥ 0.80 W/kg, repeat that measurement once.
- 3) Perform a second repeated measurement only if the ratio of largest to smallest SAR for the original and first repeated measurements is > 1.20 or when the original or repeated measurement is ≥ 1.45 W/kg (~ 10% from the 1-g SAR limit).
- 4) Perform a third repeated measurement only if the original, first or second repeated measurement is ≥ 1.5 W/kg and the ratio of largest to smallest SAR for the original, first and second repeated measurements is > 1.20.

Note: The same procedures should be adapted for measurements according to extremity and occupational exposure limits by applying a factor of 2.5 for extremity exposure and a factor of 5 for occupational exposure to the corresponding SAR thresholds.

The Highest Measured SAR Configuration in Each Frequency Band

Frequency Band	Freq.(MHz)	EUT Position	Meas. SAR (W/kg)		Largest to Smallest SAR Ratio
			Original	Repeat	
WLAN 2.4G	2437	Body Front(0mm)	0.984	0.954	1.031
WLAN5G	5210	Body Edge2(0mm)	0.824	0.810	1.017

Note:

1. Repeated measurement is not required since the original highest measured SAR is < 0.80 W/kg.
2. The measured SAR results do not have to be scaled to the maximum tune-up tolerance to determine if repeated measurements are required.
3. SAR measurement variability must be assessed for each frequency band, which is determined by the SAR probe calibration point and tissue-equivalent medium used for the device measurements.

SAR SIMULTANEOUS TRANSMISSION DESCRIPTION

Simultaneous Transmission:

Description of Simultaneous Transmit Capabilities	
Transmitter Combination	Simultaneous?
BT/WLAN 2.4G/ RLAN 5G Antenna	×

Note:

1. The EUT has only one BT/WLAN 2.4G/ RLAN 5G antenna, and does not support transmit simultaneously.

APPENDIX A SAR PLOTS

Please Refer to the Attachment.

APPENDIX A MEASUREMENT UNCERTAINTY

The uncertainty budget has been determined for the measurement system and is given in the following Table.

Measurement uncertainty evaluation for IEEE1528-2013 SAR test

Source of uncertainty	Tolerance/uncertainty ± %	Probability distribution	Divisor	ci (1 g)	ci (10 g)	Standard uncertainty ± %, (1 g)	Standard uncertainty ± %, (10 g)
Measurement system							
Probe calibration	6.0	N	1	1	1	6.0	6.0
Axial Isotropy	4.7	R	√3	1	1	1.9	1.9
Hemispherical Isotropy	9.6	R	√3	0	0	3.9	3.9
Boundary effect	1.0	R	√3	1	1	0.6	0.6
Linearity	4.7	R	√3	1	1	2.7	2.7
Detection limits	1.0	R	√3	1	1	0.6	0.6
Readout electronics	0.3	N	1	1	1	0.3	0.3
Response time	0.8	R	√3	1	1	0.5	0.5
Integration time	2.6	R	√3	1	1	1.5	1.5
RF ambient conditions – noise	3.0	R	√3	1	1	1.7	1.7
RF ambient conditions–reflections	3.0	R	√3	1	1	1.7	1.7
Probe positioner mech. Restrictions	0.02	R	√3	1	1	0.0	0.0
Probe positioning with respect to phantom shell	0.4	R	√3	1	1	0.2	0.2
Post-processing	2.0	R	√3	1	1	1.2	1.2
Test sample related							
Test sample positioning	2.9	N	1	1	1	2.9	2.9
Device holder uncertainty	3.6	N	1	1	1	3.6	3.6
Drift of output power	5.0	R	√3	1	1	2.9	2.9
Phantom and set-up							
Phantom uncertainty (shape and thickness tolerances)	6.1	R	√3	1	1	2.3	2.3
Liquid conductivity target)	5.0	R	√3	0.78	0.71	2.0	1.8
Liquid conductivity meas.)	2.5	N	1	0.78	0.71	2.0	1.8
Liquid permittivity target)	5.0	R	√3	0.23	0.26	0.6	0.7
Liquid permittivity meas.)	2.5	N	1	0.23	0.26	0.6	0.7
Combined standard uncertainty		RSS				11.3	11.2
Expanded uncertainty 95 % confidence interval)						22.6	22.4

Measurement uncertainty evaluation for IEC62209-2 SAR test

Source of uncertainty	Tolerance/uncertainty ± %	Probability distribution	Divisor	ci (1 g)	ci (10 g)	Standard uncertainty ± %, (1 g)	Standard uncertainty ± %, (10 g)
Measurement system							
Probe calibration	6.55	N	1	1	1	6.55	6.55
Axial Isotropy	4.7	R	√3	1	1	1.9	1.9
Hemispherical Isotropy	9.6	R	√3	0	0	3.9	3.9
Linearity	4.7	R	√3	1	1	2.7	2.7
Modulation Response	2.4	R	√3	1	1	1.4	1.4
Detection limits	1.0	R	√3	1	1	0.6	0.6
Boundary effect	2.0	R	√3	1	1	1.2	1.2
Readout electronics	0.3	N	1	1	1	0.3	0.3
Response time	0.8	R	√3	1	1	0.5	0.5
Integration time	2.6	R	√3	1	1	1.5	1.5
RF ambient conditions – noise	3.0	R	√3	1	1	1.7	1.7
RF ambient conditions–reflections	3.0	R	√3	1	1	1.7	1.7
Probe positioner mech. Restrictions	0.04	R	√3	1	1	0.0	0.0
Probe positioning with respect to phantom shell	0.8	R	√3	1	1	0.5	0.5
Post-processing	4.0	R	√3	1	1	2.3	2.3
Test sample related							
Device holder Uncertainty	3.6	N	1	1	1	3.6	3.6
Test sample positioning	2.9	N	1	1	1	2.9	2.9
Power scaling	0	R	√3	1	1	0	0
Drift of output power	5.0	R	√3	1	1	2.9	2.9
Phantom and set-up							
Phantom uncertainty (shape and thickness tolerances)	7.6	R	√3	1	1	4.4	4.4
Algorithm for correcting SAR for deviations in permittivity and conductivity	1.9	N	1	1	0.84	1.9	1.9
Liquid conductivity (meas.)	2.5	N	1	0.78	0.71	2.0	1.8
Liquid permittivity (meas.)	2.5	N	1	0.23	0.26	0.6	0.7
Temp. unc. - Conductivity	3.4	R	√3	0.78	0.71	1.5	1.4
Temp. unc. - Permittivity	0.4	R	√3	0.23	0.26	0.1	0.1
Combined standard uncertainty		RSS				12.1	12.0
Expanded uncertainty 95 % confidence interval)						24.1	24.0

APPENDIX B EUT TEST AND EXTERNAL POSITION PHOTOS

Please Refer to the Attachment.

APPENDIX C PROBE AND DAE CALIBRATION CERTIFICATES

Please Refer to the Attachment.

APPENDIX D DIPOLE CALIBRATION CERTIFICATES

******* END OF REPORT *******