



# TEST REPORT

Report Number: C21T00061-SRD01-V01

Applicant	Shanghai Sunmi Technology Co.,Ltd.
Product Name	Handheld Wireless Terminal
Model Name	T8911
Brand Name	SUNMI
FCC ID	2AH25T8911
IC	22621-T8911

Industrial Internet Innovation Center (Shanghai) Co., Ltd. tested the above equipment in accordance with the requirements in FCC Part15, ANSI C63.10-2013, KDB 558074, RSS-Gen Issue 5, RSS-247 Issue 2.

Prepared by 

Reviewed by 

Approved by 

Issue Date 2021-11-26

**Industrial Internet Innovation Center (Shanghai) Co., Ltd.**



## NOTE

1. This report is invalid without the signature of the writer, reviewer and authorizer.
2. This report is invalid if altered.
3. For the benefit of clients, if you have any objection to the report, please inform the testing laboratory within 15 days from the date of receiving this report.
4. Samples in the test report are provided by the client. The test results are only applicable to the samples received by the laboratory. The source information of samples (such as sample sender, manufacturer, etc.) in the test report is provided by the client, and the laboratory is not responsible for its authenticity and the measurement accuracy.
5. The test report does not represent the identification of a product by a certification body or an authorized body.
6. This report is only valid as a whole, and no part of the report can be reproduced without the written approval of Industrial Internet Innovation Center (Shanghai) Co., Ltd.
7. Without the written permission of testing institutions and accreditation bodies, this report cannot be used in part or in whole for publicity or product introduction.
8. "N/A" is used in this report to indicate that it is not applicable or available.
9. Industrial Internet Innovation Center (Shanghai) Co., Ltd. assumes the legal responsibility for the report.
10. The measurement uncertainty is not taken into account when deciding conformity, and the results of measurement (or the average of measurement results) are directly used as the criterion for the stating conformity.

### **Test Laboratory:**

Industrial Internet Innovation Center (Shanghai) Co., Ltd.  
Add: Building 4, No. 766 Jingang Rd, Pudong, Shanghai, China  
Tel: +86 21 68866880



### Revision Version

Report Number	Revision	Date	Memo
C21T00061-SRD01-V00	00	2021-11-03	Initial creation of test report
C21T00061-SRD01-V01	01	2021-11-26	1.The normal voltage of the prototype in the report has been corrected. 2.The limit value has been revised. 3.99%BW data has been corrected.



## CONTENTS

1. TEST LABORATORY .....	7
1.1. TESTING LOCATION .....	7
1.2. TESTING ENVIRONMENT .....	7
1.3. PROJECT INFORMATION .....	7
2. CLIENT INFORMATION .....	8
2.1. APPLICANT INFORMATION .....	8
2.2. MANUFACTURER INFORMATION .....	8
3. EQUIPMENT UNDER TEST (EUT) AND ANCILLARY EQUIPMENT (AE) .....	9
3.1. ABOUT EUT .....	9
3.2. INTERNAL IDENTIFICATION OF EUT USED DURING THE TEST .....	9
3.3. INTERNAL IDENTIFICATION OF AE USED DURING THE TEST .....	9
4. REFERENCE DOCUMENTS .....	10
4.1. REFERENCE DOCUMENTS FOR TESTING .....	10
4.2. REFERENCE INFORMATION FROM CLIENT .....	10
5. TEST SUMMARY .....	11
5.1. SUMMARY OF TEST RESULTS .....	11
5.2. STATEMENTS .....	12
6. MEASUREMENT RESULTS .....	13
6.1. PEAK OUTPUT POWER-CONDUCTED .....	14
6.1.1. Measurement Limit .....	14
6.1.2. Test Condition .....	14
6.1.3. Test procedure .....	14
6.1.4. Test Setup .....	14
6.2. FREQUENCY BAND EDGES-CONDUCTED .....	18
6.2.1. Measurement Limit .....	18
6.2.2. Test procedure .....	18

6.2.3. Test Setup.....	18
6.3. CONDUCTED EMISSION .....	22
6.3.1. Measurement Limit.....	22
6.3.2. Test procedures .....	22
6.3.3. Test Setup.....	22
6.4. RADIATED EMISSION .....	26
6.4.1. Measurement Limit.....	26
6.4.2. Test Method.....	26
6.4.3. Test Setup.....	27
6.5. TIME OF OCCUPANCY (DWELL TIME) .....	37
6.5.1. Measurement Limit.....	37
6.5.2. Test procedures .....	37
6.5.3. Test Setup.....	37
6.6. 20DB BANDWIDTH.....	41
6.6.1. Measurement Limit.....	41
6.6.2. Test procedures .....	41
6.6.3. Test Setup.....	41
6.7. 99% OCCUPIED BANDWIDTH .....	44
6.7.1. Measurement Limit.....	44
6.7.2. Test procedures .....	44
6.7.3. Test Setup.....	44
6.8. CARRIER FREQUENCY SEPARATION.....	47
6.8.1. Measurement Limit.....	47
6.8.2. Test procedures .....	47
6.8.3. Test Setup.....	47
6.9. NUMBER OF HOPPING CHANNELS .....	49
6.9.1. Measurement Limit.....	49
6.9.2. Test procedure .....	49
6.9.3. Test Setup.....	49
7. TEST EQUIPMENT LIST.....	51
7.1. CONDUCTED TEST SYSTEM.....	51
7.2. RADIATED EMISSION TEST SYSTEM.....	51
ANNEX A: MEASUREMENT UNCERTAINTY.....	52



## 1. Test Laboratory

### 1.1. Testing Location

Primary Lab:

Company Name	Industrial Internet Innovation Center (Shanghai) Co., Ltd.
Address	Building 4, No. 766 Jingang Rd, Pudong, Shanghai, China
FCC Registration No.	958356
FCC Designation No.	CN1177
IC designation No.	CN0067

Subcontracting Lab #1:

Company Name	N/A
Address	N/A

### 1.2. Testing Environment

Normal Temperature	15°C~35°C
Relative Humidity	30%RH~60%RH
Supply Voltage	120V/60Hz

### 1.3. Project Information

Project Leader	Wang Wenen
Testing Start Date	2021-07-01
Testing End Date	2021-08-18



## 2. Client Information

### 2.1. Applicant Information

Company Name	Shanghai Sunmi Technology Co.,Ltd.
Address	Room 505, KIC Plaza, No.388 Song Hu Road, Yang Pu District, Shanghai, China
Telephone	+86 18721763396

### 2.2. Manufacturer Information

Company Name	Shanghai Sunmi Technology Co.,Ltd.
Address	Room 505, KIC Plaza, No.388 Song Hu Road, Yang Pu District, Shanghai, China
Telephone	+86 18721763396



### 3. Equipment under Test (EUT) and Ancillary Equipment (AE)

#### 3.1. About EUT

Product Name	Handheld Wireless Terminal
Model name	T8911
Supported Radio Technology and Bands	GSM850/GSM900/GSM1800/GSM1900 WCDMA Band I /Band II/Band IV/Band V /Band VIII CDMA Band BC0/BC1/BC10 LTE 1/2/3/4/5/7/12/13/14/17/18/19/25/26/28/38/41/66/71 LTE CA Up Link 2CA: 7C,41C BT5.0 WLAN 802.11b,g,n WLAN 802.11a,n,ac NFC GPS GLONASS Galileo BDS
Hardware Version	V1.02
Software Version	V01_T46
FCC ID	2AH25T8911
IC	22621-T8911

#### 3.2. Internal Identification of EUT used during the test

EUT ID*	SN or IMEI	HW Version	SW Version	Date of Receipt
N01	864679050005368 864679050014659	V1.02	V01_T46	2021-06-04
N05	864679050005574 864679050014865	V1.02	V01_T46	2021-06-18

\*EUT ID: is internally used to identify the test sample in the lab.

#### 3.3. Internal Identification of AE used during the test

AE ID*	Description	Model	SN/Remark
AE1	RF Cable	N/A	N/A

\*AE ID: is internally used to identify the test sample in the lab.

\*The AE is provided by the client.

## 4. Reference Documents

### 4.1. Reference Documents for testing

The following documents listed in this section are referred for testing.

Reference	Title	Version
FCC Part15	FCC CFR 47, Part 15, Subpart C: 15.205 Restricted bands of operation; 15.209 Radiated emission limits, general requirements; 15.247 Operation within the bands 902-928MHz, 2400-2483.5MHz, and 5725-5850MHz.	2018-10-01
ANSI C63.10	American National Standard of Procedures for Compliance Testing of Unlicensed Wireless Devices	2013
KDB 558074	Guidance for Performing Compliance Measurements on Frequency Hopping Spread Spectrum systems (DSS) Operating Under §15.247	v05r02
RSS-247 Issue 2	Digital Transmission Systems (DTSs), Frequency Hopping Systems (FHSs) and Licence-Exempt Local Area Network (LE-LAN) Devices	2017
RSS-Gen Issue 5	General Requirements for Compliance of Radio Apparatus	2019

### 4.2. Reference Information from client

Information of the test sample provided by the client.

Antenna gain of EUT 2.71 dBi

Note: The product T8911 use an integral antenna which compliance with the requirement of 15.203.

## 5. Test Summary

### 5.1. Summary of Test Results

Measurement Items	Sub-clause of Part15C	Sub-clause of IC	Verdict
Maximum Peak Output Power	15.247(b)	RSS-247 5.4	Pass
20dB Occupied Bandwidth	15.247(a)	RSS-247 5.1	Pass
99% Occupied Bandwidth	N/A	RSS-Gen 6.7	Pass
Band Edges Compliance	15.247 (d)	RSS-247 5.5	Pass
Time Of Occupancy (Dwell Time)	15.247(a)	RSS-247 5.1	Pass
Carrier Frequency Separation	15.247(a)	RSS-247 5.1	Pass
Number Of Hopping Channels	15.247(a)	RSS-247 5.1	Pass
Transmitter Spurious Emission-Conducted	15.247(d)	RSS-247 5.5	Pass
Transmitter Spurious Emission-Radiated	15.247,15.209,15.205	RSS-Gen 8.9,8.10	Pass

#### Test Conditions

Tnom	Normal Temperature
Tmin	Low Temperature
Tmax	High Temperature
Vnom	Normal Voltage
Vmin	Low Voltage
Vmax	High Voltage
Hnom	Norm Humidity
Anom	Norm Air Pressure

For this report, all the test case listed above are tested under Normal Temperature and Normal Voltage, and also under norm humidity, the specific conditions as following:

Temperature	Tnom	25°C
Voltage	Vnom	3.8V
Humidity	Hnom	48%
Air Pressure	Anom	1010hPa

#### Note:

- a. All the test data for each data were verified, but only the worst case was reported.
- b. The GFSK,  $\pi/4$  DQPSK and 8DPSK were set in DH1 for GFSK, 2-DH1 for  $\pi/4$  DQPSK, 3-DH1 for 8DPSK.
- c. The DC and low frequency voltages' measurement uncertainty is  $\pm 2\%$ .



## 5.2. Statements

The T8911 manufactured by Shanghai Sunmi Technology Co.,Ltd., Incorporated are new products for testing.

Industrial Internet Innovation Center (Shanghai) Co., Ltd. only performed test cases which identified with Pass/Fail/Inc result in section 5.1.

Industrial Internet Innovation Center (Shanghai) Co., Ltd. has verified that the compliance of the tested device specified in section 3 of this test report is successfully evaluated according to the procedure and test methods as defined in type certification requirement listed in section 4 of this test report.

## 6. Measurement Results

**Shielding Room1** (6.0 meters×3.0 meters×2.7 meters) did not exceed following limits along the conducted RF performance testing:

Temperature	Min. = 15 °C, Max. = 35 °C
Relative humidity	Min. = 20 %, Max. = 75 %
Shielding effectiveness	> 100 dB
Ground system resistance	< 0.5 Ω
Temperature	Min. = 15 °C, Max. = 35 °C

**Control room** did not exceed following limits along the EMC testing:

Temperature	Min. = 15 °C, Max. = 35 °C
Relative humidity	Min. =30 %, Max. = 60 %
Shielding effectiveness	> 100 dB
Electrical insulation	> 10 kΩ
Ground system resistance	< 0.5 Ω

**Fully-anechoic chamber1** (6.9 meters×10.9 meters×5.4 meters) did not exceed following limits along the EMC testing:

Temperature	Min. = 15 °C, Max. = 35 °C
Relative humidity	Min. = 25 %, Max. = 75 %
Shielding effectiveness	> 100 dB
Electrical insulation	> 10 kΩ
Ground system resistance	< 0.5 Ω
VSWR	Between 0 and 6 dB, from 1GHz to 18GHz
Site Attenuation Deviation	Between -4 and 4 dB,30MHz to 1GHz
Uniformity of field strength	Between 0 and 6 dB, from 80MHz to 3000 MHz

## 6.1. Peak Output Power-Conducted

### 6.1.1. Measurement Limit

Standard	Limit (dBm)
FCC 47 Part 15.247(b)(1)	<20.96
RSS-247 5.4(b)	<20.96

### 6.1.2. Test Condition

Hopping Mode	RBW	VBW	Span	Sweptime
Hopping OFF	3MHz	10MHz	9MHz	Auto

### 6.1.3. Test procedure

The measurement is according to ANSI C63.10 clause 7.8.5.

1. The output power of EUT was connected to the spectrum analyzer and CBT32 by cable and divide. The path loss was compensated to the results for each measurement.
2. Enable EUT transmitter maximum power continuously.
3. Measure the conducted output power and record the results it.

### 6.1.4. Test Setup

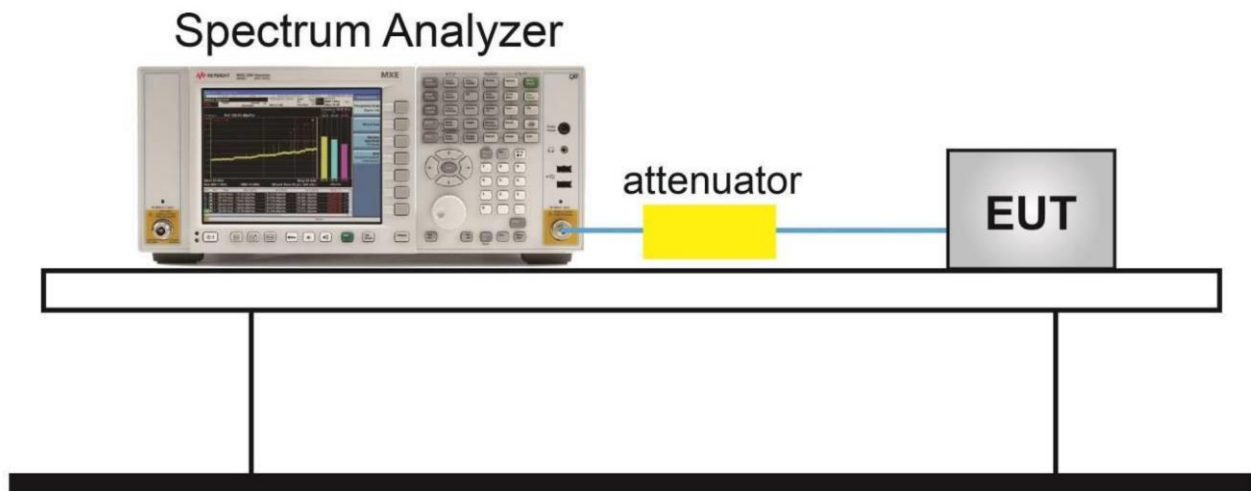

### Measurement Results

Note: Bold font is the maximum Value

<p>Peak Conducted Output Power GFSK, CH0 (dBm)</p>	<p><b>10.15</b></p>	<p>Peak Conducted Output Power GFSK, CH39 (dBm)</p>	<p><b>8.73</b></p>
<p>Ref: 30 dBm, Att: 30 dB, RBW: 3 MHz, VBW: 10 MHz, SWT: 2.5 ms, Marker 1 [T1]: 10.15 dBm, 2.401835769 GHz</p> <p>Center: 2.402 GHz, Span: 9 MHz</p> <p>Date: 22 JUN 2021 15:32:29</p>		<p>Ref: 30 dBm, Att: 30 dB, RBW: 3 MHz, VBW: 10 MHz, SWT: 2.5 ms, Marker 1 [T1]: 8.73 dBm, 2.440870192 GHz</p> <p>Center: 2.441 GHz, Span: 9 MHz</p> <p>Date: 22 JUN 2021 15:33:38</p>	
<p>Peak Conducted Output Power GFSK, CH78 (dBm)</p>	<p><b>10.05</b></p>	<p>Peak Conducted Output Power <math>\pi/4</math> DQPSK, CH0 (dBm)</p>	<p><b>10.12</b></p>
<p>Ref: 30 dBm, Att: 30 dB, RBW: 3 MHz, VBW: 10 MHz, SWT: 2.5 ms, Marker 1 [T1]: 10.05 dBm, 2.479826923 GHz</p> <p>Center: 2.48 GHz, Span: 9 MHz</p> <p>Date: 22 JUN 2021 15:34:58</p>		<p>Ref: 30 dBm, Att: 30 dB, RBW: 3 MHz, VBW: 10 MHz, SWT: 2.5 ms, Marker 1 [T1]: 10.12 dBm, 2.401956731 GHz</p> <p>Center: 2.402 GHz, Span: 9 MHz</p> <p>Date: 22 JUN 2021 15:39:39</p>	

<b>Peak Conducted Output Power</b> $\pi/4$ DQPSK, CH39 (dBm)	<b>8.72</b>	<b>Peak Conducted Output Power</b> $\pi/4$ DQPSK, CH78 (dBm)	<b>10.04</b>
<p>Ref 30 dBm    Att 30 dB    RBW 3 MHz    VBW 10 MHz    Span 9 MHz        Marker 1 [T1]    8.72 dBm        2.44085769 GHz</p> <p>Date: 22 JUN 2021 15:40:30</p>	<p>Ref 30 dBm    Att 30 dB    RBW 3 MHz    VBW 10 MHz    Span 9 MHz        Marker 1 [T1]    10.04 dBm        2.479899038 GHz</p> <p>Date: 22 JUN 2021 15:41:30</p>		
<b>Peak Conducted Output Power</b> 8DPSK, CH0 (dBm)	<b>10.15</b>	<b>Peak Conducted Output Power</b> 8DPSK, CH39 (dBm)	<b>8.72</b>
<p>Ref 30 dBm    Att 30 dB    RBW 3 MHz    VBW 10 MHz    Span 9 MHz        Marker 1 [T1]    10.15 dBm        2.401884615 GHz</p> <p>Date: 22 JUN 2021 15:43:17</p>	<p>Ref 30 dBm    Att 30 dB    RBW 3 MHz    VBW 10 MHz    Span 9 MHz        Marker 1 [T1]    8.72 dBm        2.440942308 GHz</p> <p>Date: 22 JUN 2021 15:44:57</p>		



<b>Peak Conducted Output Power 8DPSK, CH78 (dBm)</b>	<b>10.06</b>	/	/
<p> <small>             Ref: 30 dBm    +Att: 30 dB    -RBW: 3 MHz    Marker 1: 171.1    10.06 dBm              +VBW: 10 MHz    -SWT: 2.5 ms    2.479870192 GHz              Center: 2.48 GHz    900 kHz/    Span: 9 MHz              Date: 22 JUN 2021 15:45:44           </small> </p>		/	

## 6.2. Frequency Band Edges-Conducted

### 6.2.1. Measurement Limit

Standard	Limited(dBc)
FCC 47 CFR Part 15.247(d)	>20
RSS-247 5.5	>20

### 6.2.2. Test procedure

The measurement is according to ANSI C63.10 clause 7.8.6.

1. Connect the EUT to spectrum analyzer.
2. Set RBW=100KHz, VBW=300KHz, span more than 1.5 times channel bandwidth (2MHz).
3. Detector =peak, sweep time=auto couple, trace mode=max hold.
4. Allow sweep to continue until the trace stabilizes.

### 6.2.3. Test Setup

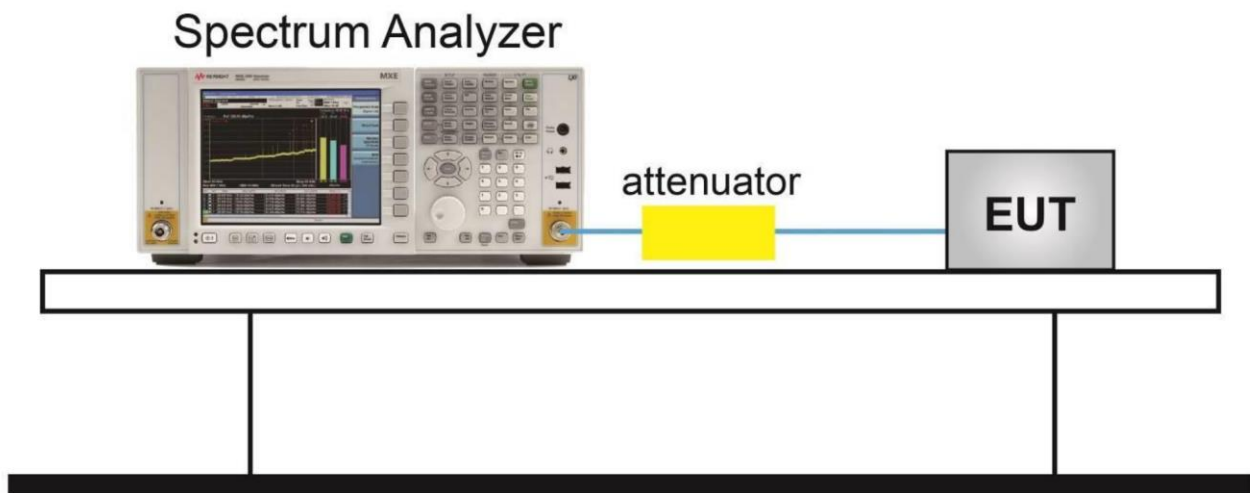

Measurement results

Frequency Band Edge: GFSK, Ch0, Hopping OFF

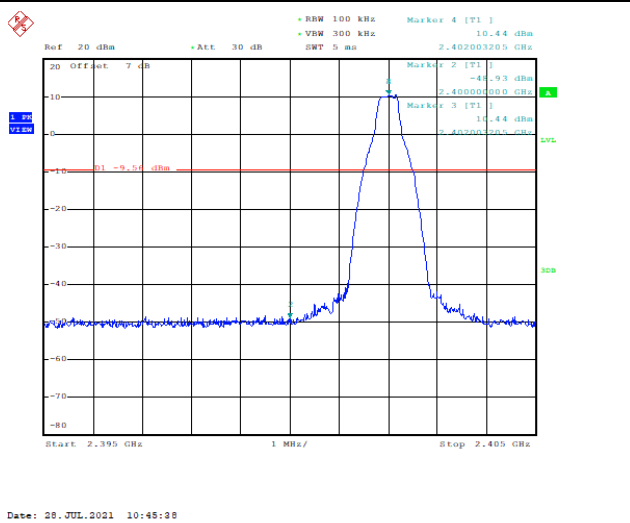

Frequency Band Edge: GFSK, Ch0, Hopping ON

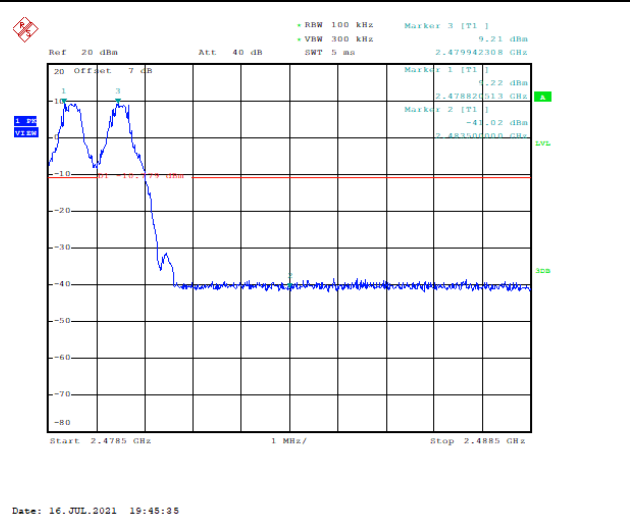

Frequency Band Edge: GFSK, Ch78, Hopping OFF

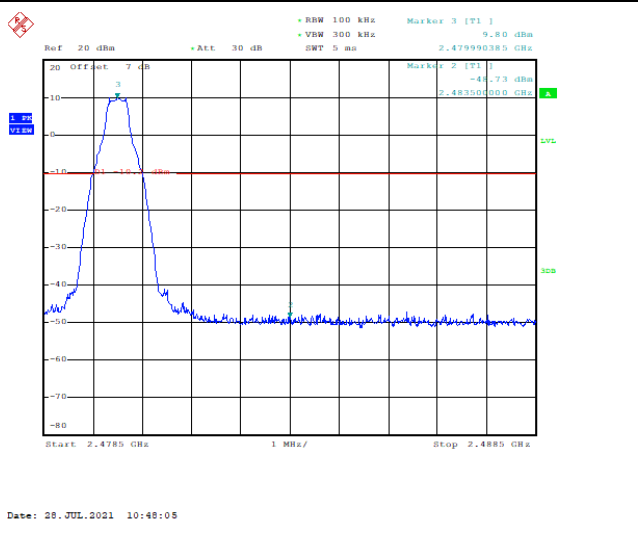

Frequency Band Edge: GFSK, Ch78, Hopping ON

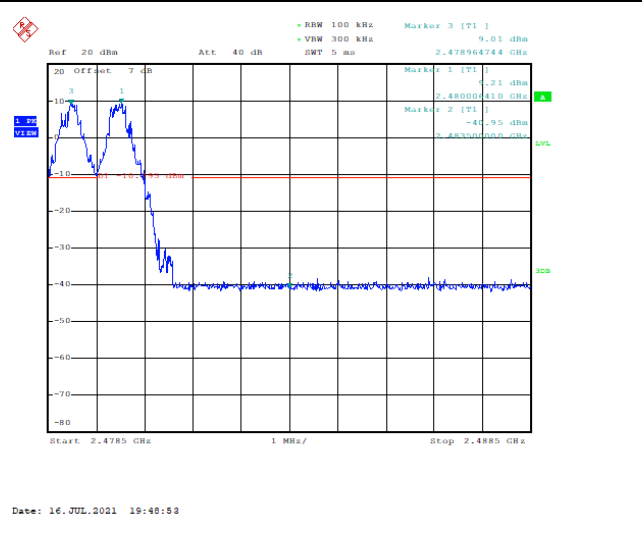

Frequency Band Edge:  $\pi/4$  DQPSK,

Frequency Band Edge:  $\pi/4$  DQPSK,

Ch0, Hopping OFF

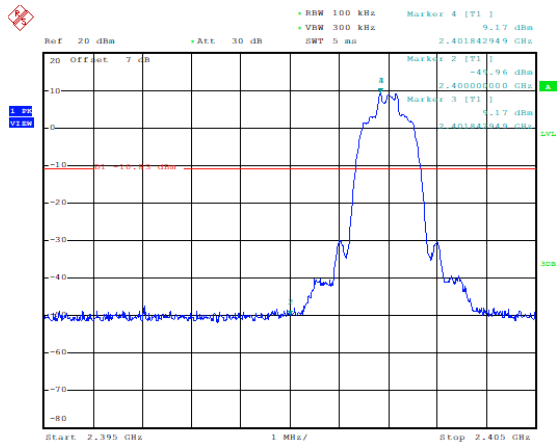

Date: 28.JUL.2021 10:49:28

Ch0, Hopping ON

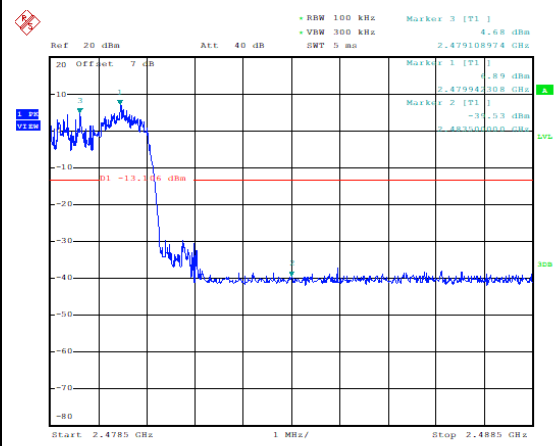

Date: 16.JUL.2021 19:50:52

Frequency Band Edge:  $\pi/4$  DQPSK, Ch78, Hopping OFF

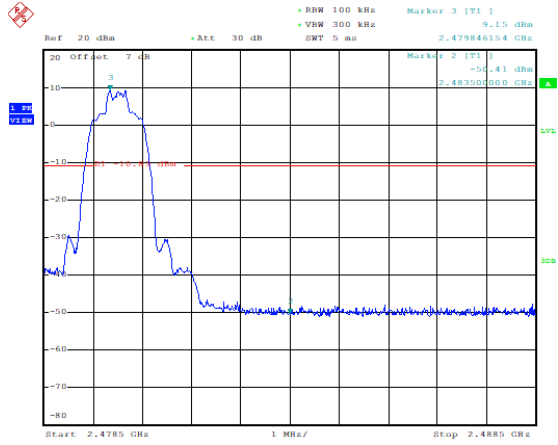

Date: 28.JUL.2021 10:51:29

Frequency Band Edge:  $\pi/4$  DQPSK, Ch78, Hopping ON

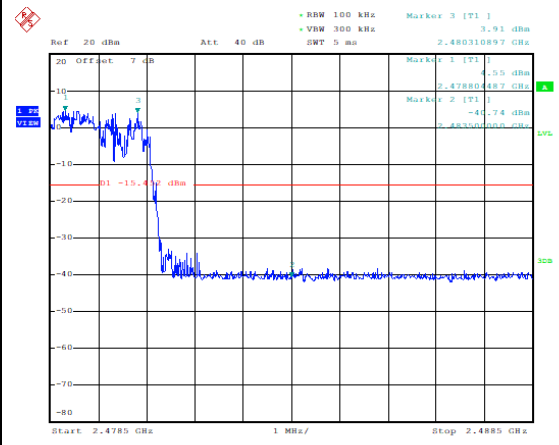

Date: 16.JUL.2021 19:59:24

Frequency Band Edge: 8DPSK, Ch0, Hopping OFF

Frequency Band Edge: 8DPSK, Ch0, Hopping ON

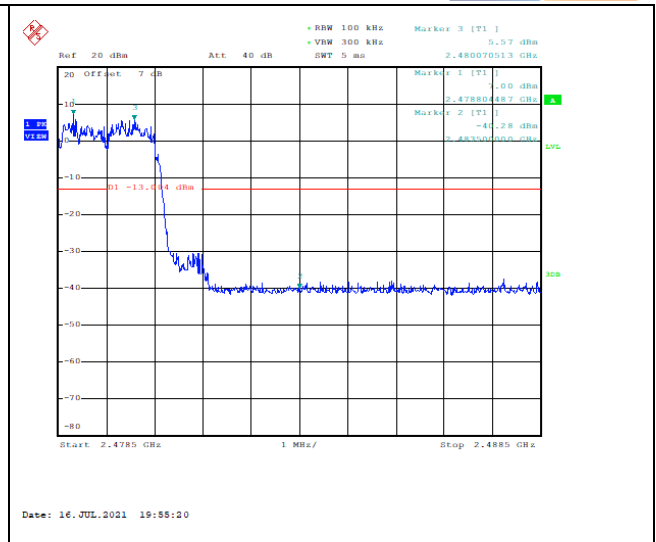
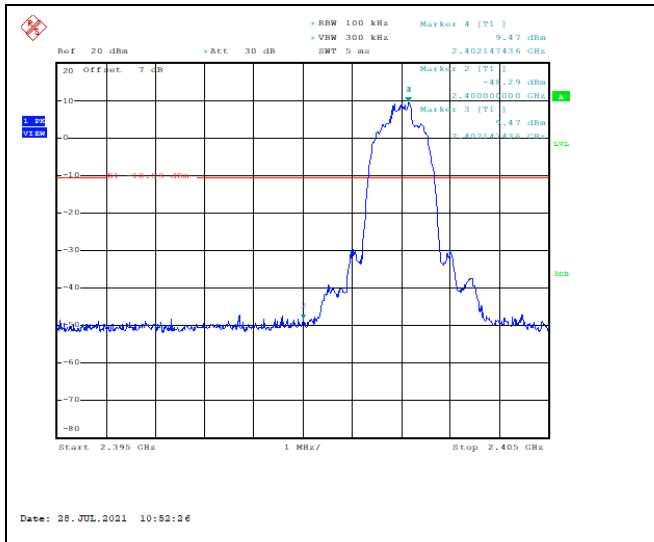

Frequency Band Edge:8DPSK,  
Ch78, Hopping OFF

Frequency Band Edge: 8DPSK,  
Ch78, Hopping ON

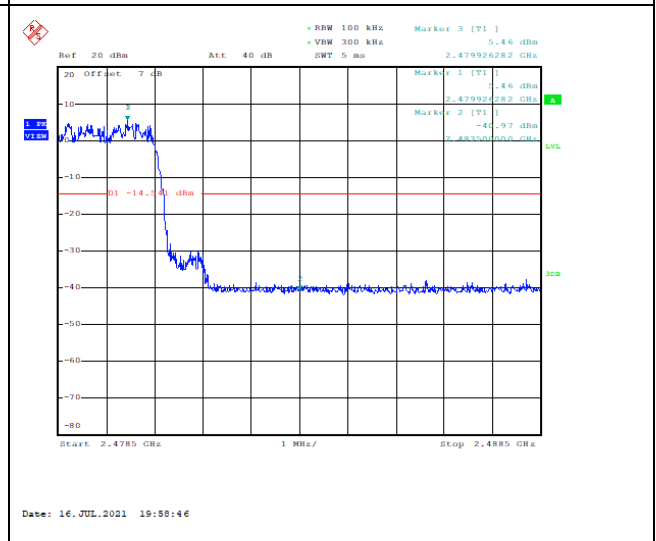
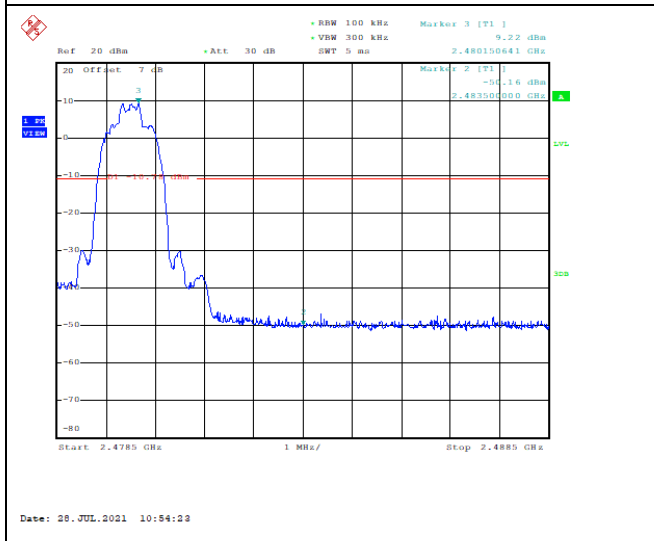

### 6.3. Conducted Emission

#### 6.3.1. Measurement Limit

Standard	Limit
FCC 47 CFR Part15.247 (d)	20dB below peak output power in 100KHz bandwidth
RSS-247 5.5	20dB below peak output power in 100KHz bandwidth

#### 6.3.2. Test procedures

The measurement is according to ANSI C63.10 clause 7.8.8.

1. Connect the EUT to spectrum analyzer.
2. Set RBW=100KHz, VBW=300KHz.
3. Detector =peak, sweep time=auto couple, trace mode=max hold.

#### 6.3.3. Test Setup

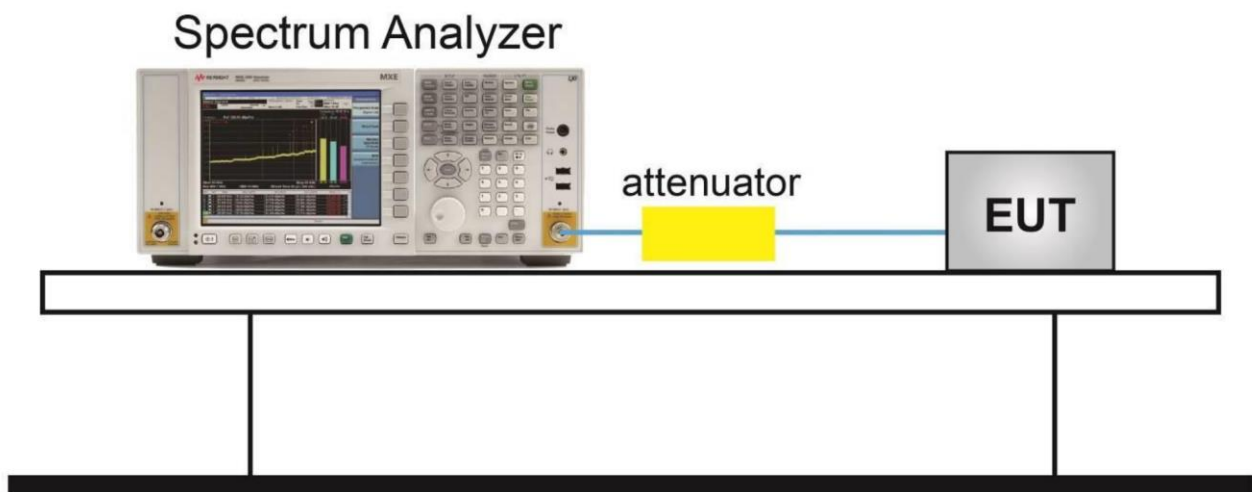

### Measurement Results

Conducted spurious emission:  
GFSK, Ch0, 30MHz~26GHz

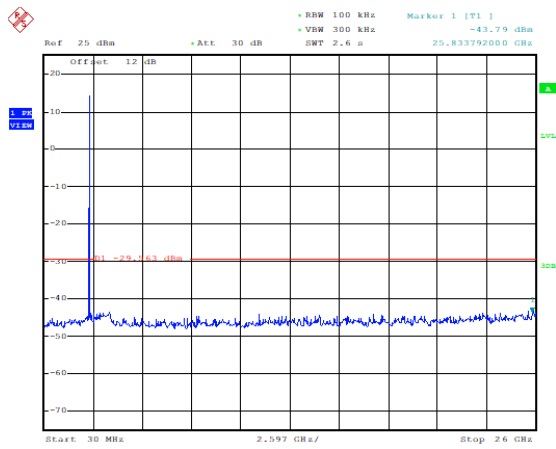

Date: 28.JUL.2021 10:45:54

Conducted spurious emission:  
GFSK, Ch39, 30MHz~26GHz

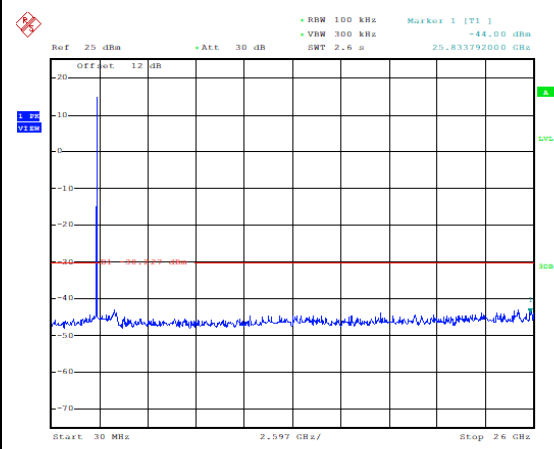

Date: 28.JUL.2021 10:47:27

Conducted spurious emission:  
GFSK, Ch78, 30MHz~26GHz

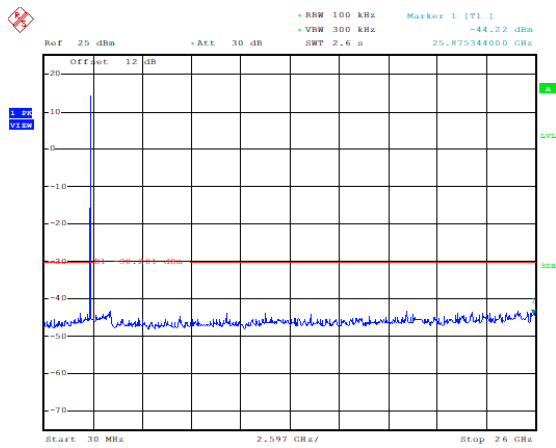

Date: 28.JUL.2021 10:48:21

Conducted spurious emission:  
 $\pi/4$  DQPSK, Ch0, 30MHz~26GHz

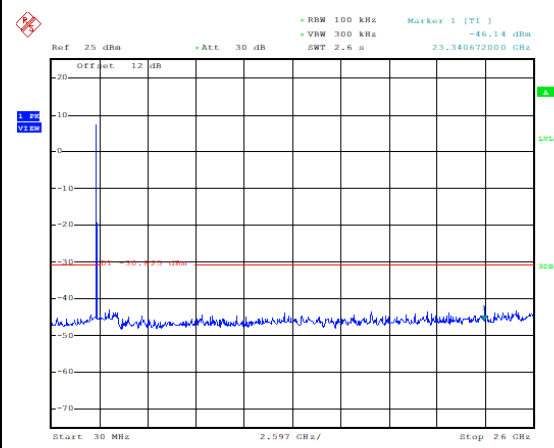

Date: 28.JUL.2021 10:49:44

Conducted spurious emission:  
 $\pi/4$  DQPSK, Ch39, 30MHz~26GHz

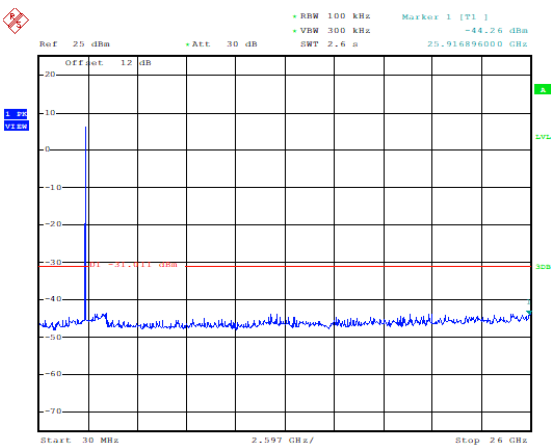

Date: 28.JUL.2021 10:50:49

Conducted spurious emission:  
 $\pi/4$  DQPSK, Ch78, 30MHz~26GHz

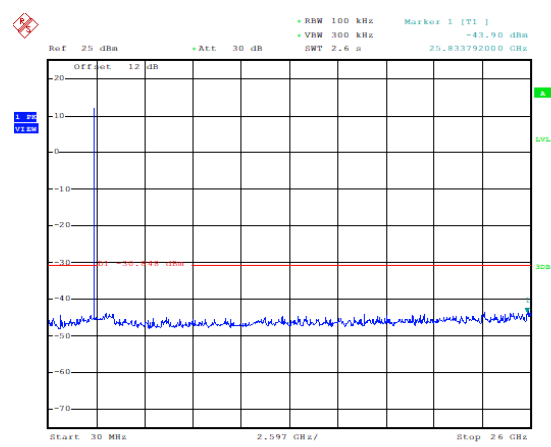

Date: 28.JUL.2021 10:51:45

Conducted spurious emission:  
 8DQPSK, Ch0, 30MHz~26GHz

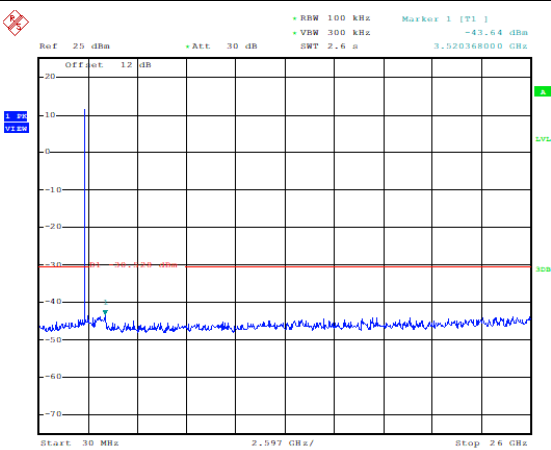

Date: 28.JUL.2021 10:52:42

Conducted spurious emission:  
 8DQPSK, Ch39, 30MHz~26GHz

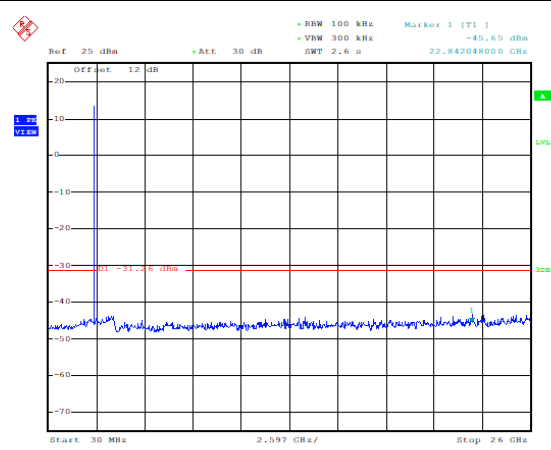

Date: 28.JUL.2021 10:59:41



Conducted spurious emission:  
8DQPSK, Ch78, 30MHz~26GHz

/

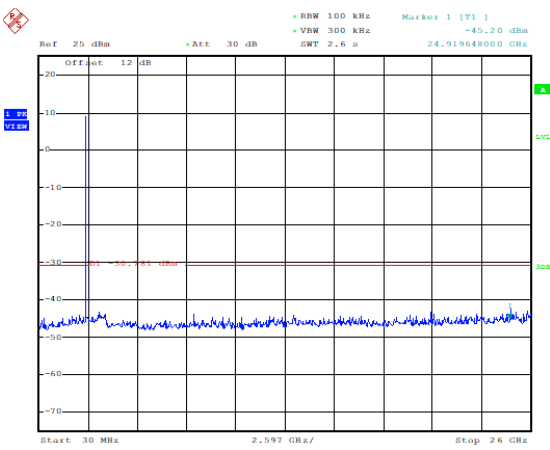

/

Date: 28.JUL.2021 10:54:29

## 6.4. Radiated Emission

### 6.4.1. Measurement Limit

Standard	Limit
FCC 47 CFR Part 15.247, 15.205, 15.209	20dB below peak output power
RSS-Gen 8.9,8.10	20dB below peak output power

In addition, radiated emissions which fall in the restricted bands, as defined in 15.205(a), must also comply with the radiated emission limits specified in 15.209(a) (see 15.205(c)).

#### Limit in restricted band

Frequency of emission	Field strength (uV/m)	Field strength (dBuV/m)
30~88	100	40
88~216	150	43.5
216~960	200	46
Above 960	500	54

### 6.4.2. Test Method

Portable, small, lightweight, or modular devices that may be handheld, worn on the body, or placed on a table during operation shall be positioned on a non-conducting platform, the top of which is 80 cm above the reference ground plane. The preferred area occupied by the EUT arrangement is 1 m by 1.5 m, For emissions testing at or below 1 GHz, the table height shall be 80 cm above the reference ground plane. For emission measurements above 1 GHz, the table height shall be 1.5 m. but it may be larger or smaller to accommodate various sized EUTs. For testing purposes, ceiling- and wall-mounted devices also shall be positioned on a tabletop (see also ANSI C63.10-2013 section 6.3.4 and 6.3.5). In making any tests involving handheld, body-worn, or ceiling-mounted equipment, it is essential to recognize that the measured levels may be dependent on the orientation (attitude) of the three orthogonal axes of the EUT. Thus, exploratory tests as specified in 8.3.1 shall be carried out for various axes orientations to determine the attitude having maximum or near-maximum emission level.

The EUT was placed on a non-conductive table. The measurement antenna was placed at a distance of 3 meters from the EUT. During the tests, the antenna height and the EUT azimuth were varied in order to identify the maximum level of emissions from the EUT. This maximization process was repeated with the EUT positioned in each of its three orthogonal orientations.

Frequency of emission	RBW/VBW	Sweep Time (s)
30~1000	100KHz/300KHz	5
1000~4000	1MHz/3MHz	15
4000~18000	1MHz/3MHz	40
18000~26500	1MHz/3MHz	20

### 6.4.3. Test Setup

#### Below 1GHz Test Setup

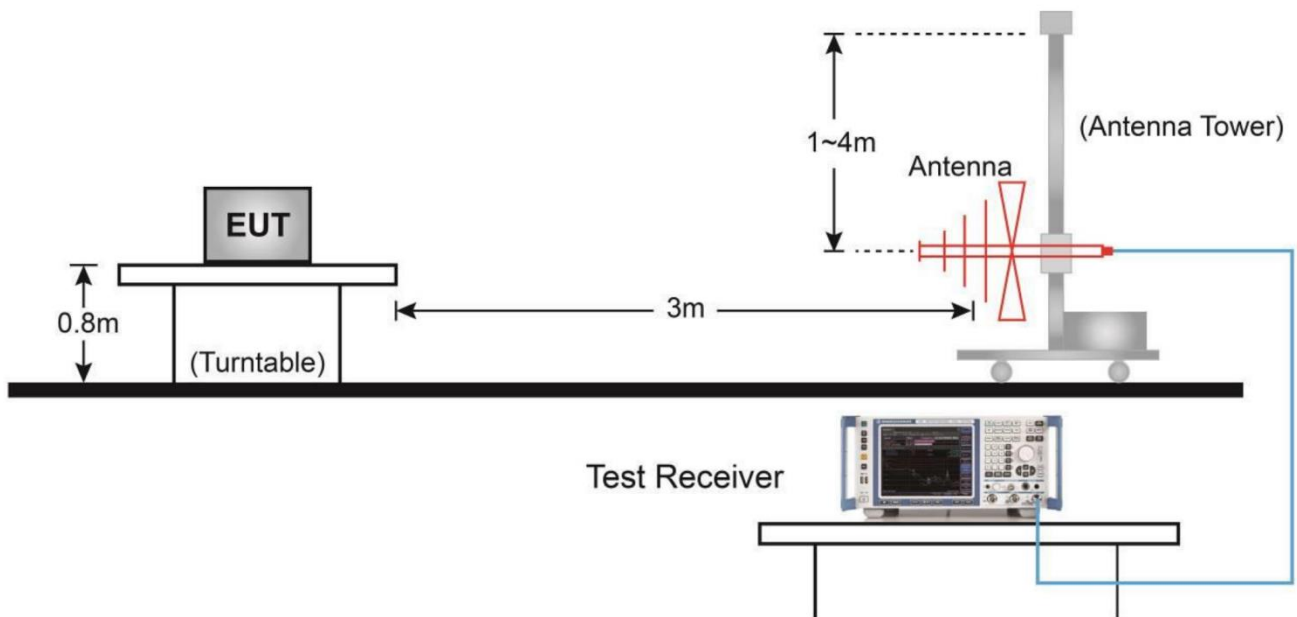

#### Above 1GHz Test Setup

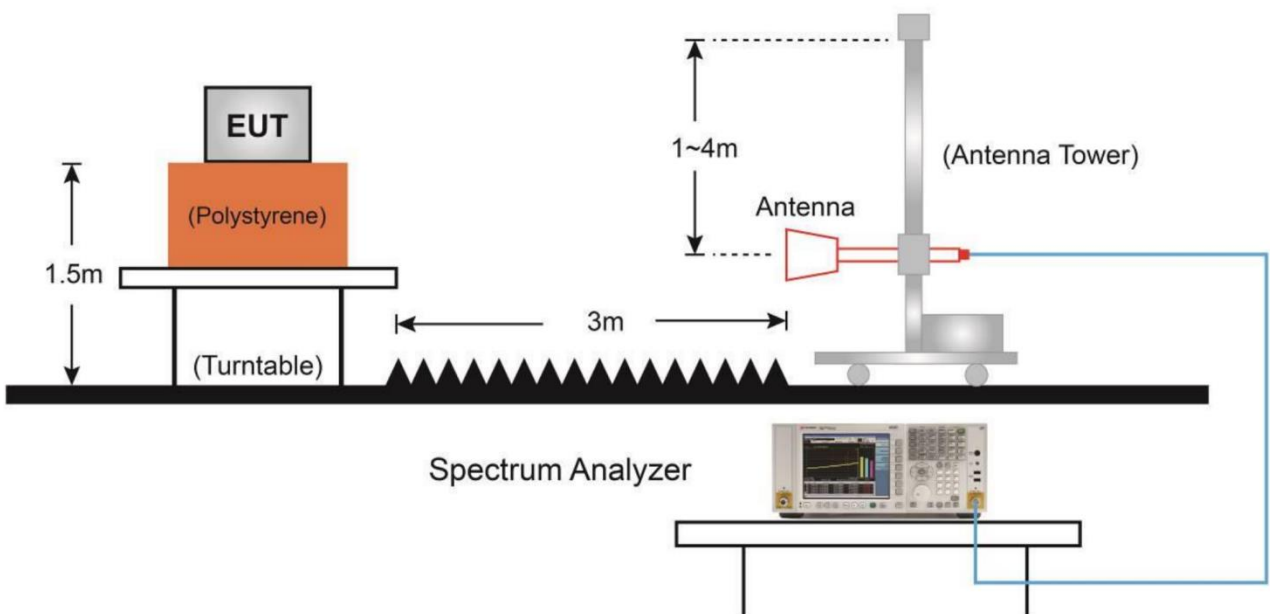

### Measurement Results

A “reference path loss” is established and  $A_{R_{pi}}$  is the attenuation of “reference path loss”, and including the gain of receive antenna, the gain of the preamplifier, the cable loss.

The measurement results are obtained as described below:

$$A_{R_{pi}} = \text{Cable loss} + \text{Antenna Gain} - \text{Preamplifier gain}$$

$$\text{Result} = P_{\text{Mea}} + A_{R_{pi}}$$

### Mainly Supply

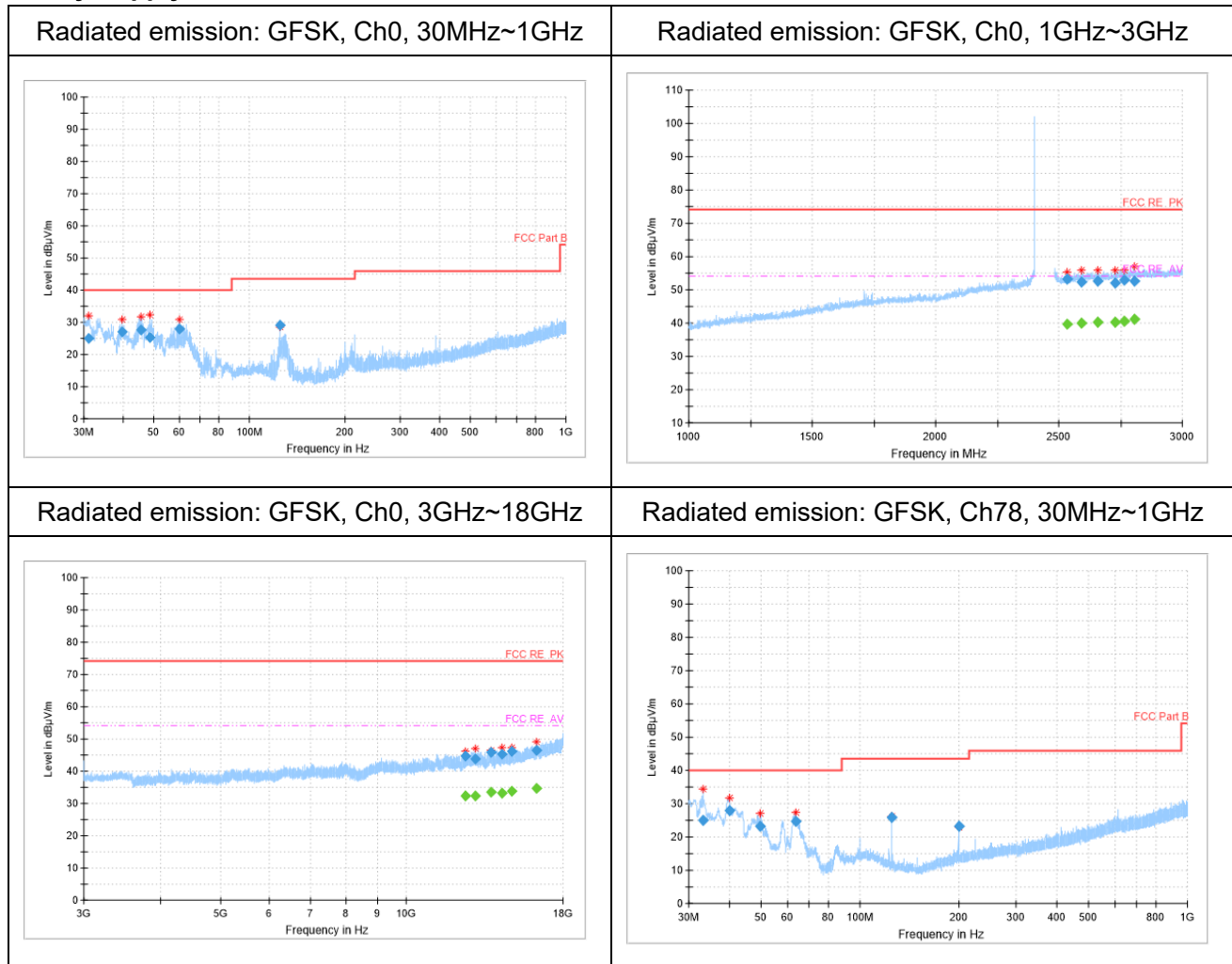

Radiated emission: GFSK, Ch78, 1GHz~3GHz

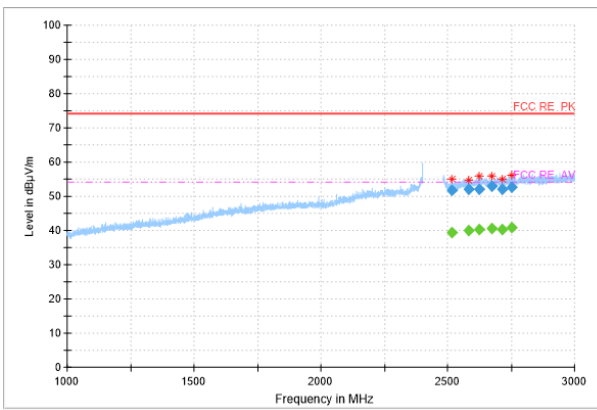

Radiated emission: GFSK, Ch78, 3GHz~18GHz

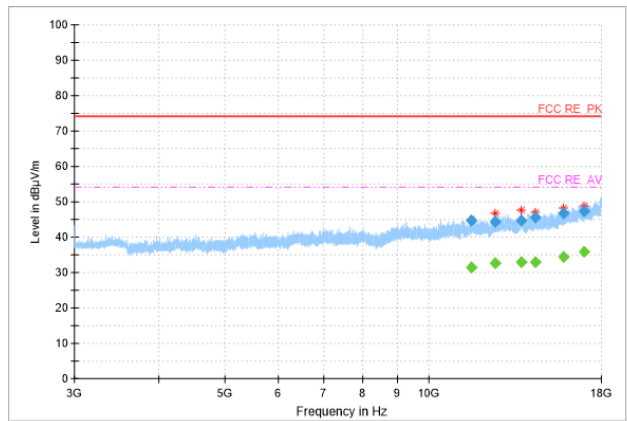

Bandedge (Low): GFSK, low channel

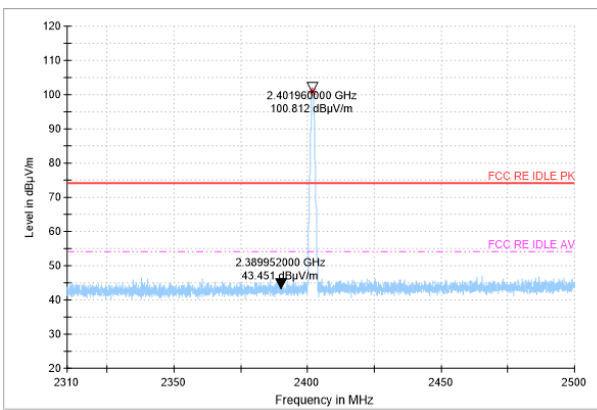

Bandedge (High): GFSK, high channel

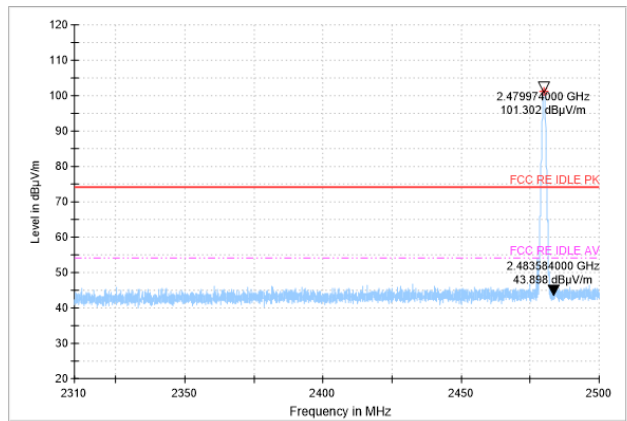

Radiated emission:  $\pi/4$  DQPSK, Ch0, 30MHz~1GHz

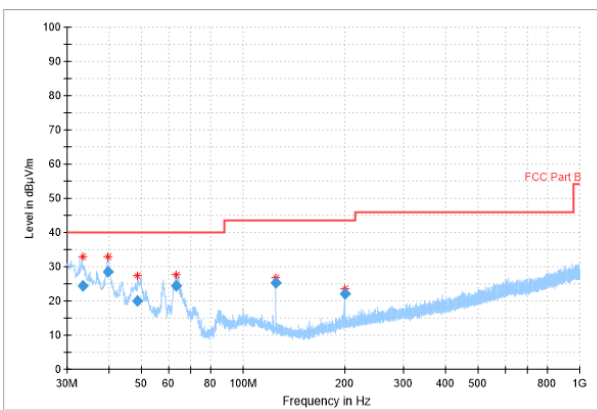

Radiated emission:  $\pi/4$  DQPSK, Ch0, 1GHz~3GHz

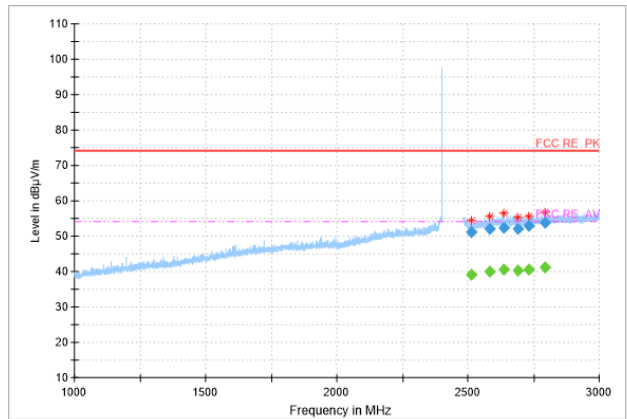

Radiated emission:  $\pi/4$  DQPSK, Ch0,  
3GHz~18GHz

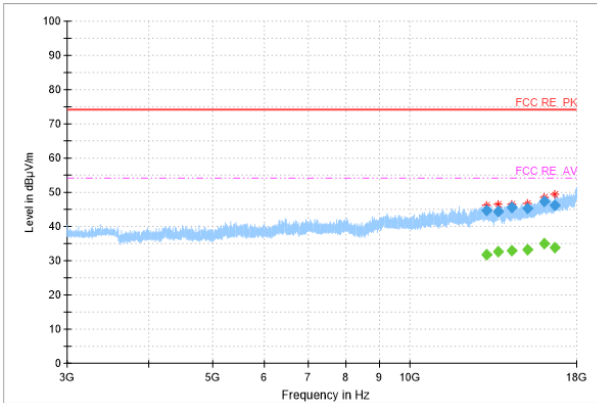

Radiated emission:  $\pi/4$  DQPSK, Ch78,  
30MHz~1GHz

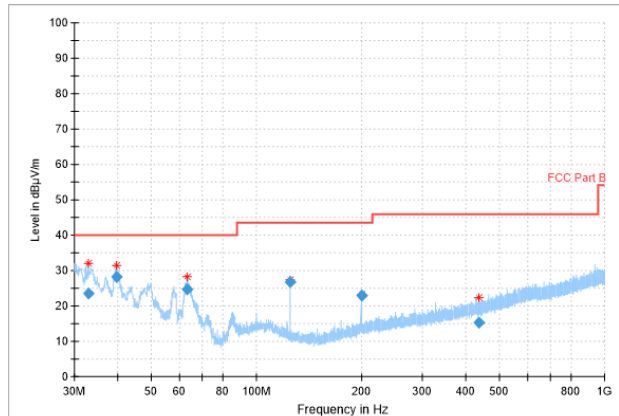

Radiated emission:  $\pi/4$  DQPSK, Ch78,  
1GHz~3GHz

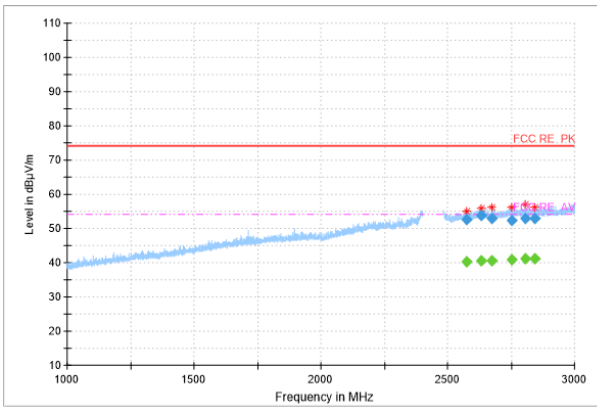

Radiated emission:  $\pi/4$  DQPSK, Ch78,  
3GHz~18GHz

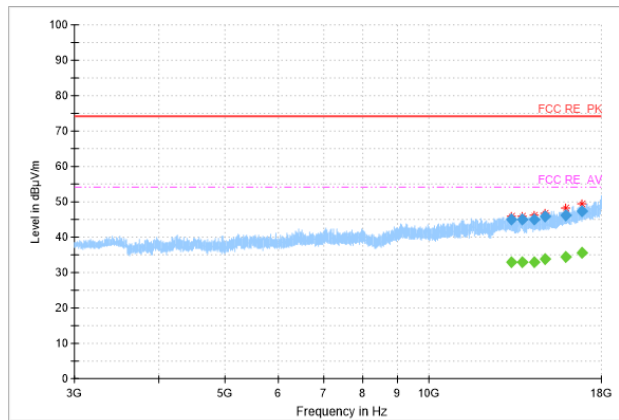

Bandedge (Low):  $\pi/4$  DQPSK, low channel

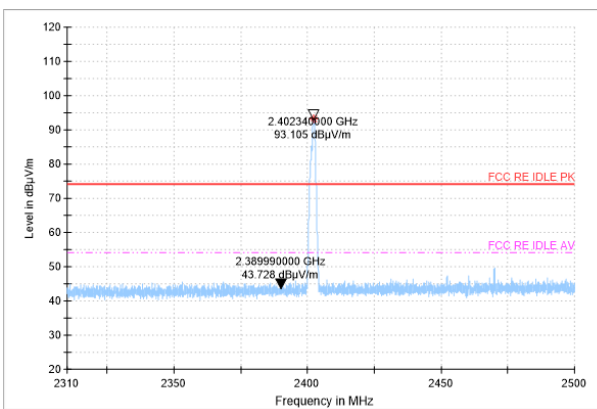

Bandedge (High):  $\pi/4$  DQPSK, high channel

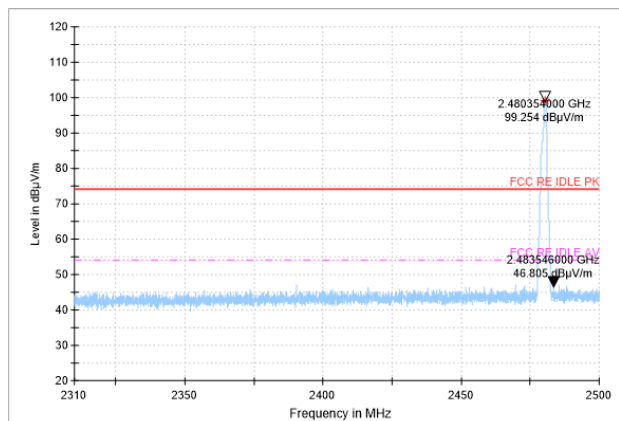

Radiated emission: 8DPSK, Ch0, 30MHz~1GHz

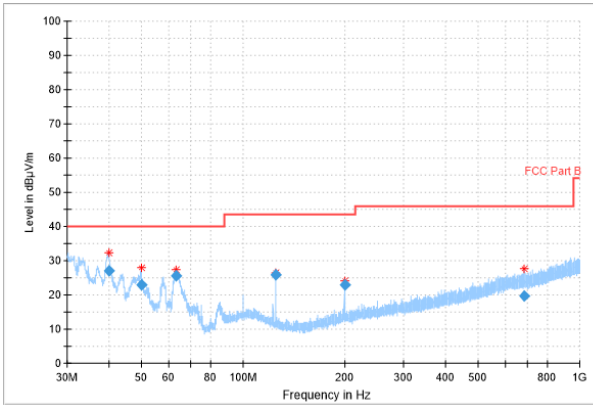

Radiated emission: 8DPSK, Ch0, 1GHz~3GHz

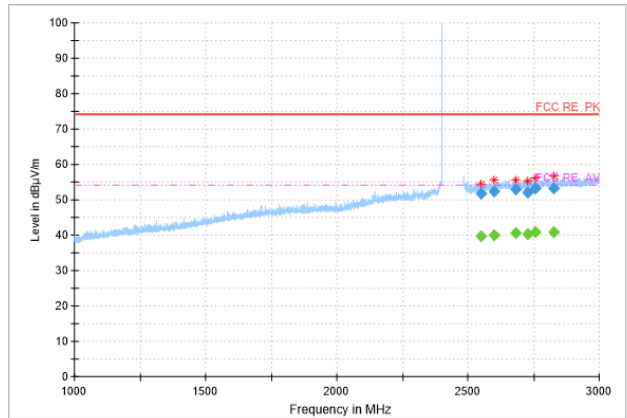

Radiated emission: 8DPSK, Ch0, 3GHz~18GHz

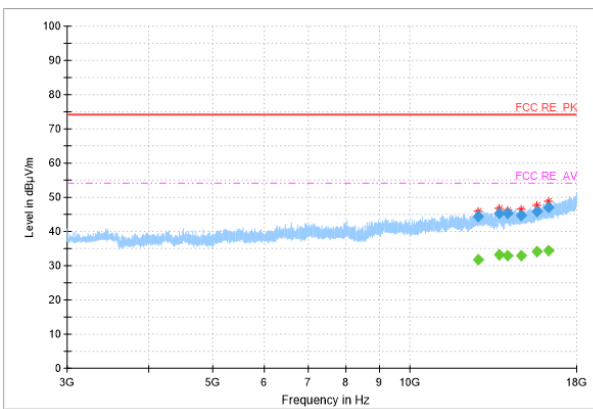

Radiated emission: 8DPSK, Ch78, 30MHz~1GHz

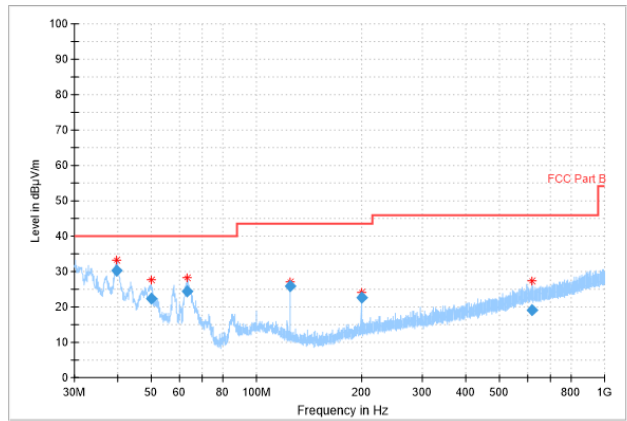

Radiated emission: 8DPSK, Ch78, 1GHz~3GHz

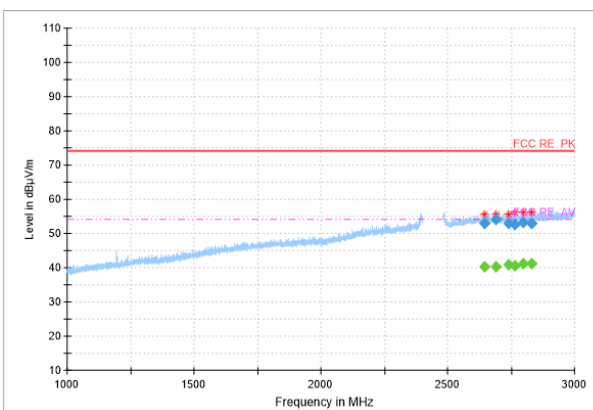

Radiated emission: 8DPSK, Ch78, 3GHz~18GHz

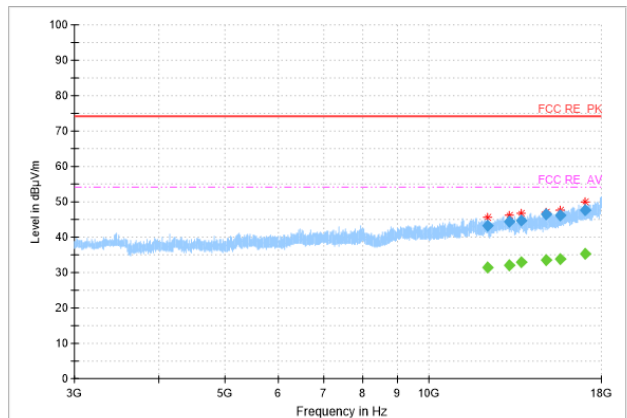

Bandedge (Low): 8DPSK, low channel

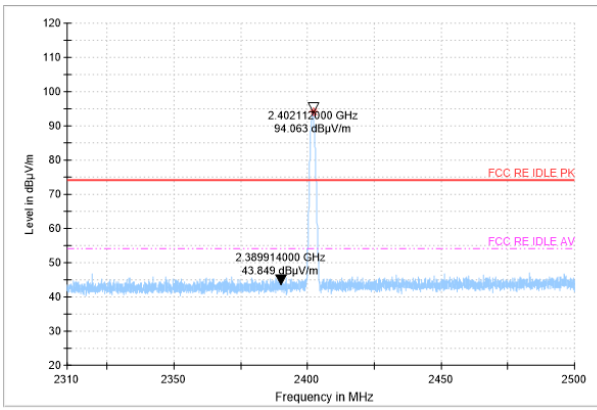

Bandedge (High): 8DPSK, high channel

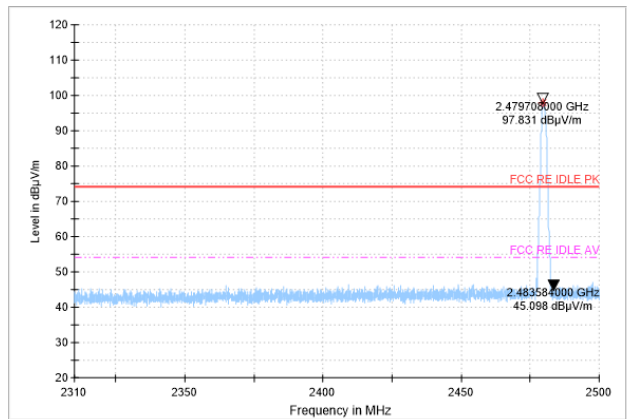

ALL Channel 18GHz~26GHz

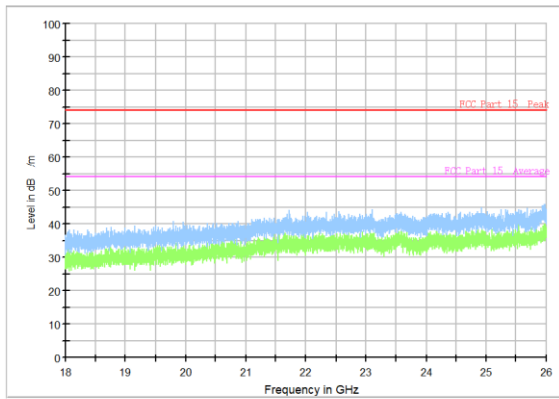

/

/





### Mainly Supply

#### GFSK Ch0 30MHz-1GHz

Frequency (MHz)	Result(dBuV/m)	ARpl(dB)	PMea(dBuV/m)	Polarity
31.1	24.92	-14.3	39.22	V
39.6	27.01	-12.9	39.91	V
45.6	27.54	-12.3	39.84	V
48.6	25.42	-12	37.42	V
60.0	27.83	-12.3	40.13	V
125.0	29.26	-15.6	44.86	H

#### GFSK Ch0 1GHz-3GHz

Frequency (MHz)	Result(dBuV/m)	ARpl(dB)	PMea(dBuV/m)	Polarity
2533.2	53.12	14.8	38.32	V
2590.4	52.21	15.4	36.81	H
2658.5	52.78	15.9	36.88	V
2727.1	52.16	16.1	36.06	H
2763.2	52.86	16.3	36.56	V
2807.3	52.7	16.6	36.1	H

#### GFSK Ch0 3GHz-18GHz

Frequency (MHz)	Result(dBuV/m)	ARpl(dB)	PMea(dBuV/m)	Polarity
12505.8	44.7	2.4	42.3	H
12975.0	43.91	3.4	40.51	H
13751.0	45.89	4.1	41.79	H
14311.5	45.18	5.4	39.78	H
14852.2	46.18	5.7	40.48	V
16304.9	46.41	7.9	38.51	V

#### GFSK CH78 30MHz-1GHz

Frequency (MHz)	Result(dBuV/m)	ARpl(dB)	PMea(dBuV/m)	Polarity
33.3	24.98	-14.2	39.18	V
40.0	27.85	-12.8	40.65	V
49.5	23.3	-11.9	35.2	V
63.5	24.67	-13.5	38.17	V
125.0	25.87	-15.6	41.47	H
200.0	23.13	-13.9	37.03	V

#### GFSK Ch78 1GHz-3GHz

Frequency (MHz)	Result(dBuV/m)	ARpl(dB)	PMea(dBuV/m)	Polarity
2518.3	51.89	14.7	37.19	V
2582.0	52.02	15.4	36.62	H



2623.9	51.94	15.7	36.24	V
2674.4	53.01	15.9	37.11	H
2715.3	52.07	16	36.07	H
2751.3	52.79	16.2	36.59	H

**GFSK Ch78 3GHz-18GHz**

Frequency (MHz)	Result(dBuV/m)	ARpl(dB)	PMea(dBuV/m)	Polarity
11550.8	44.58	2.3	42.28	V
12546.2	44.42	2.6	41.82	H
13680.0	44.63	4	40.63	H
14390.7	45.54	5.2	40.34	H
15842.9	46.9	7.4	39.5	H
16940.5	47.35	8.9	38.45	H

**$\pi/4$  DQPSK Ch0 30MHz-1GHz**

Frequency (MHz)	Result(dBuV/m)	ARpl(dB)	PMea(dBuV/m)	Polarity
33.3	24.31	-14.2	38.51	V
39.8	28.46	-12.9	41.36	V
48.6	20.06	-12	32.06	V
63.3	24.42	-13.5	37.92	V
125.0	25.21	-15.6	40.81	H
200.0	22.19	-13.9	36.09	V

**$\pi/4$  DQPSK Ch0 1GHz-3GHz**

Frequency (MHz)	Result(dBuV/m)	ARpl(dB)	PMea(dBuV/m)	Polarity
2512.7	51.14	14.7	36.44	H
2581.4	51.95	15.4	36.55	V
2635.9	52.39	15.8	36.59	H
2691.7	52.16	15.9	36.26	V
2731.4	52.98	16.1	36.88	V
2794.0	53.82	16.5	37.32	H

**$\pi/4$  DQPSK Ch0 3GHz-18GHz (Peak)**

Frequency (MHz)	Result(dBuV/m)	ARpl(dB)	PMea(dBuV/m)	Polarity
13087.5	44.69	3.7	40.99	V
13657.7	44.47	4	40.47	H
14330.4	45.46	5.3	40.16	V
15157.4	45.28	5.8	39.48	H
16078.9	47.42	7.6	39.82	H
16648.5	46.11	8.5	37.61	H

**$\pi/4$  DQPSK Ch78 30MHz-1GHz**

Frequency (MHz)	Result(dBuV/m)	ARpl(dB)	PMea(dBuV/m)	Polarity
33.0	23.5	-14.2	37.7	V
39.8	28.1	-12.9	41	V
63.2	24.81	-13.4	38.21	V
125.0	26.78	-15.6	42.38	H
200.0	22.97	-13.9	36.87	V
436.0	15.27	-7.7	22.97	V

**$\pi/4$  DQPSK Ch78 1GHz-3GHz**

Frequency (MHz)	Result(dBuV/m)	ARpl(dB)	PMea(dBuV/m)	Polarity
2573.3	52.59	15.3	37.29	V
2632.3	53.81	15.7	38.11	H
2675.4	53.07	15.9	37.17	H
2752.5	52.49	16.2	36.29	H
2804.1	53	16.6	36.4	H
2844.8	52.9	16.6	36.3	V

**$\pi/4$  DQPSK Ch78 3GHz-18GHz**

Frequency (MHz)	Result(dBuV/m)	ARpl(dB)	PMea(dBuV/m)	Polarity
13277.3	44.88	3.5	41.38	H
13738.2	44.95	4.1	40.85	H
14334.3	45.12	5.3	39.82	H
14869.4	45.76	5.8	39.96	H
15958.2	46.19	7.7	38.49	H
16829.5	47.48	8.9	38.58	H

**8DPSK Ch0 30MHz-1GHz**

Frequency (MHz)	Result(dBuV/m)	ARpl(dB)	PMea(dBuV/m)	Polarity
40.0	27.05	-12.8	39.85	V
50.0	23.08	-11.9	34.98	V
63.2	25.48	-13.4	38.88	V
125.0	25.93	-15.6	41.53	H
200.0	22.91	-13.9	36.81	V
685.8	19.57	-2.8	22.37	H

**8DPSK Ch0 1GHz-3GHz**

Frequency (MHz)	Result(dBuV/m)	ARpl(dB)	PMea(dBuV/m)	Polarity
2549.6	51.66	15.1	36.56	H
2598.7	52.45	15.5	36.95	V
2680.8	53.08	15.9	37.18	H
2728.2	52.2	16.1	36.1	H

2755.9	53.3	16.3	37	H
2825.8	53.22	16.6	36.62	V

### 8DPSK Ch0 3GHz-18GHz

Frequency (MHz)	Result(dBuV/m)	ARpl(dB)	PMea(dBuV/m)	Polarity
12719.2	44.41	2.9	41.51	H
13709.0	45.19	4.1	41.09	V
14126.9	45.39	4.8	40.59	V
14808.8	44.69	5.7	38.99	H
15673.6	45.85	6.8	39.05	H
16321.4	46.95	8	38.95	H

### 8DPSK Ch78 30MHz-1GHz

Frequency (MHz)	Result(dBuV/m)	ARpl(dB)	PMea(dBuV/m)	Polarity
39.8	30.28	-12.9	43.18	V
49.9	22.23	-11.9	34.13	V
63.4	24.4	-13.5	37.9	V
125.0	25.95	-15.6	41.55	H
200.0	22.58	-13.9	36.48	V
617.4	18.99	-3	21.99	H

### 8DPSK Ch78 1GHz-3GHz (Peak)

Frequency (MHz)	Result(dBuV/m)	ARpl(dB)	PMea(dBuV/m)	Polarity
2646.6	52.95	15.9	37.05	V
2689.5	54.14	15.9	38.24	V
2738.4	52.82	16.1	36.72	V
2765.4	52.61	16.3	36.31	V
2796.2	53.15	16.6	36.55	H
2831.9	53.05	16.6	36.45	H

### 8DPSK Ch78 1GHz-3GHz (Average)

Frequency (MHz)	Result(dBuV/m)	ARpl(dB)	PMea(dBuV/m)	Polarity
2689.5	40.44	15.9	24.54	V

### 8DPSK Ch78 3GHz-18GHz (Peak)

Frequency (MHz)	Result(dBuV/m)	ARpl(dB)	PMea(dBuV/m)	Polarity
12224.7	43.19	2	41.19	V
13151.5	44.38	3.7	40.68	H
13709.8	44.81	4.1	40.71	H
14899.3	46.53	5.8	40.73	H
15658.7	46.07	6.7	39.37	V
17032.7	47.61	8.8	38.81	H

## 6.5. Time Of Occupancy (Dwell Time)

### 6.5.1. Measurement Limit

Standard	Limit (ms)
FCC 47 Part 15.247 (a) (1) (iii)	< 400
RSS-247 5.5	< 400

### 6.5.2. Test procedures

The measurement is according to ANSI C63.10 clause 7.8.4

1. Connect the EUT through cable and divide with CBT32 and spectrum analyzer.
2. Enable the EUT transmit maximum power.
3. Set the spectrum analyzer as step 4 to step 8.
4. Span: Zero span, centered on a hopping channel.
5. RBW shall be  $\leq$  channel spacing and where possible RBW should be set  $\gg 1 / T$ , where T is the expected dwell time per channel.
6. Sweep: As necessary to capture the entire dwell time per hopping channel; where possible use a video trigger and trigger delay so that the transmitted signal starts a little to the right of the start of the plot. The trigger level might need slight adjustment to prevent triggering when the system hops on an adjacent channel; a second plot might be needed with a longer sweep time to show two successive hops on a channel.
7. Detector function: Peak.
8. Trace: Max hold.
9. Use the marker-delta function, and record it.

### 6.5.3. Test Setup

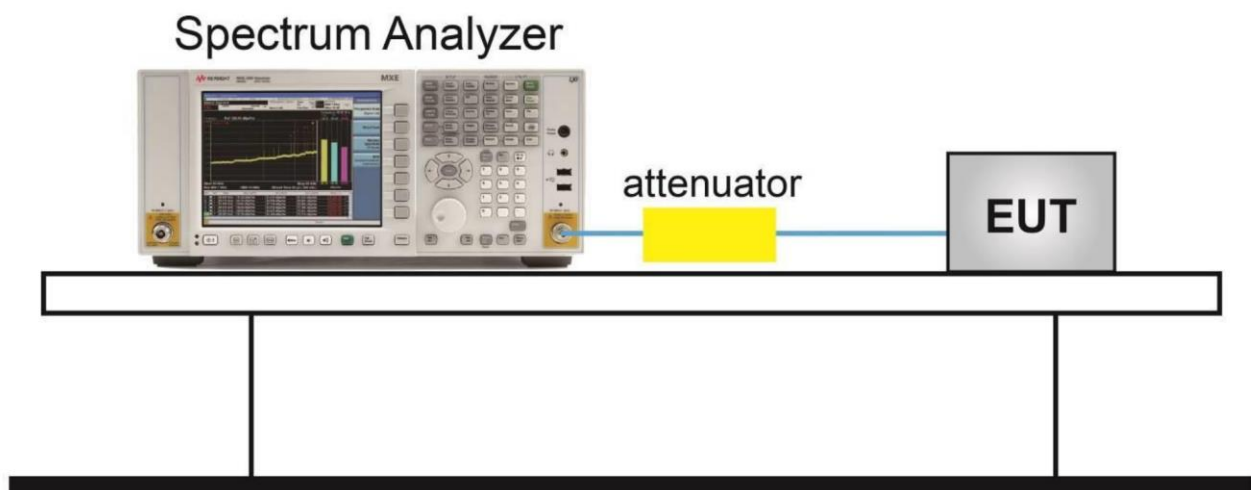



**Note:** For AFH mode, Test Period = 0.4 (second/ channel) x 20 Channel = 8 sec,  
For FHSS mode, Test Period = 0.4 (second/ channel) x 79 Channel = 31.6 sec,  
So the Time of Occupancy (Dwell Time) of AFH mode= Time of Occupancy (Dwell Time) of FHSS mode  
/ 79 Channel x 20 Channel

Modulation type	Frequency (MHz)	Time slot length (ms)	Hop rate(s)	Dwell Time (ms)	Limit (ms)	Conclusion
GFSK DH5	2402-2480	2.88	92	264.96	400	P
$\pi/4$ DQPSK 2DH5	2402-2480	2.88	97	279.36	400	P
8DPSK 3DH5	2402-2480	2.90	85	246.16	400	P

Note: Dwell time = time slot length \* hop rate

Measurement Result

<p style="text-align: center;">For GFSK, Ch39,Packet DH5 Time of occupancy (Dwell Time)</p> <p style="font-size: small;">Ref: 20 dBm, Att: 30 dB, BW: 1 MHz, VSW: 1 MHz, SWT: 10 ms, Delta 1 [T1]: -0.32 dB, Marker 1 [T1]: 10.48 dBm, 2.880000 ms</p> <p style="font-size: x-small;">Date: 21. JUL. 2021 11:57:20</p>	<p style="text-align: center;">For GFSK, Ch39,Packet DH5 Number of Transmissions Measurement</p> <p style="font-size: small;">Ref: 20 dBm, Att: 30 dB, BW: 1 MHz, VSW: 1 MHz, SWT: 31.6 μs, Marker 1 [T1]: 10.50 dBm, 27.042308 μs</p> <p style="font-size: x-small;">Date: 21. JUL. 2021 11:58:26</p>
<p style="text-align: center;">For <math>\pi/4</math> DQPSK, Ch39,Packet 2DH5 Time of occupancy (Dwell Time)</p> <p style="font-size: small;">Ref: 20 dBm, Att: 30 dB, BW: 1 MHz, VSW: 1 MHz, SWT: 10 ms, Delta 1 [T1]: -1.73 dB, Marker 1 [T1]: 10.70 dBm, 3.070000 ms</p> <p style="font-size: x-small;">Date: 21. JUL. 2021 12:05:21</p>	<p style="text-align: center;">For <math>\pi/4</math> DQPSK, Ch39,Packet 2DH5 Number of Transmissions Measurement</p> <p style="font-size: small;">Ref: 20 dBm, Att: 30 dB, BW: 1 MHz, VSW: 1 MHz, SWT: 31.6 μs, Marker 1 [T1]: 10.93 dBm, 16.205128 μs</p> <p style="font-size: x-small;">Date: 21. JUL. 2021 12:07:24</p>

For 8DPSK, Ch39, Packet 3DH5  
Time of occupancy (Dwell Time)

For 8DPSK, Ch39, Packet 3DH5  
Number of Transmissions Measurement

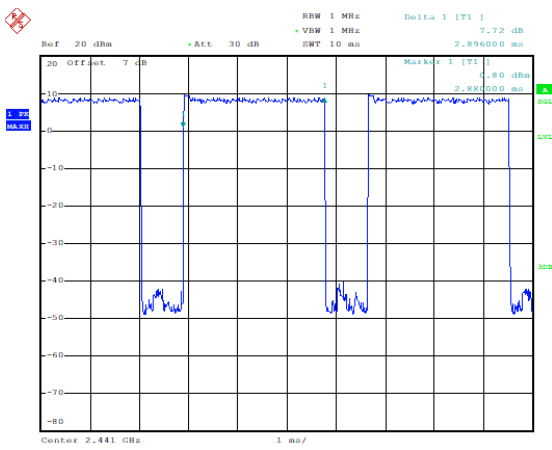

Date: 21.JUL.2021 12:11:06

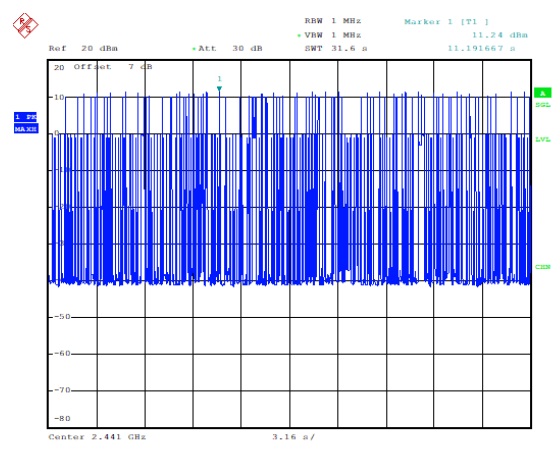

Date: 21.JUL.2021 12:11:59



## 6.6. 20dB Bandwidth

### 6.6.1. Measurement Limit

Standard	Limit
FCC 47 Part 15.247 (a) (1)	N/A
RSS-247 5.1(b)	N/A

### 6.6.2. Test procedures

The measurement is according to ANSI C63.10 clause 7.8.7

1. Connect the EUT through cable and divide with CBT32 and spectrum analyzer.
2. Enable the EUT transmit maximum power.
3. Set the spectrum analyzer as step 4 to step 7.
4. Span: two or five times of OBW
5. RBW= 1% to 5% of the OBW; VBW is approximately three times of RBW; Max Hold.
6. Select the max peak, and N DB DOWN=20dB.
7. Record the results.

### 6.6.3. Test Setup

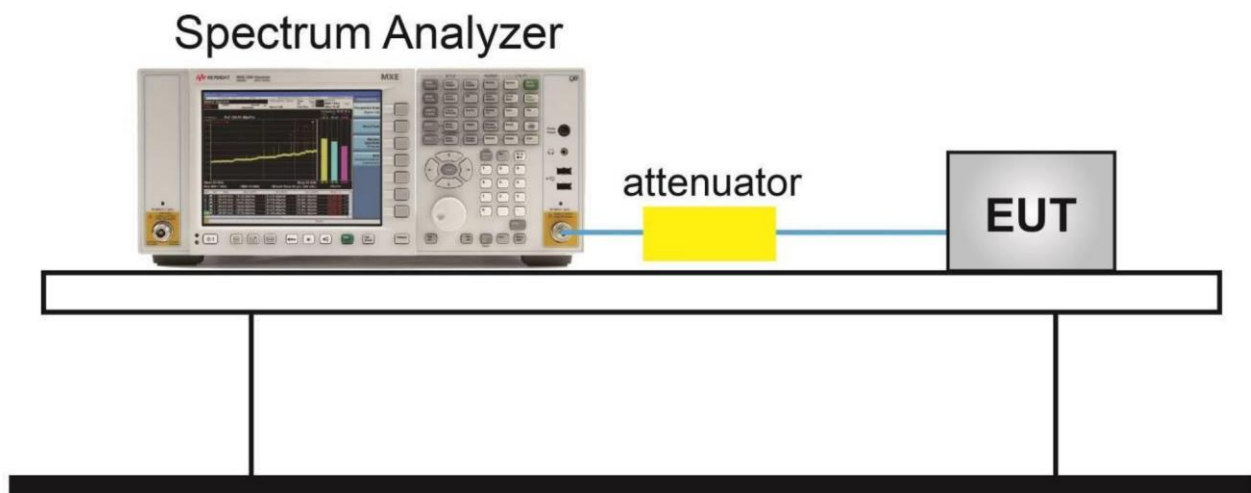

## Measurement Result

Modulation type	Frequency (MHz)	20dB Bandwidth (MHz)
GFSK DH5	2402	0.802
	2441	0.802
	2480	0.807
$\pi/4$ DQPSK 2DH5	2402	1.216
	2441	1.221
	2480	1.235
8DPSK 3DH5	2402	1.211
	2441	1.211
	2480	1.211

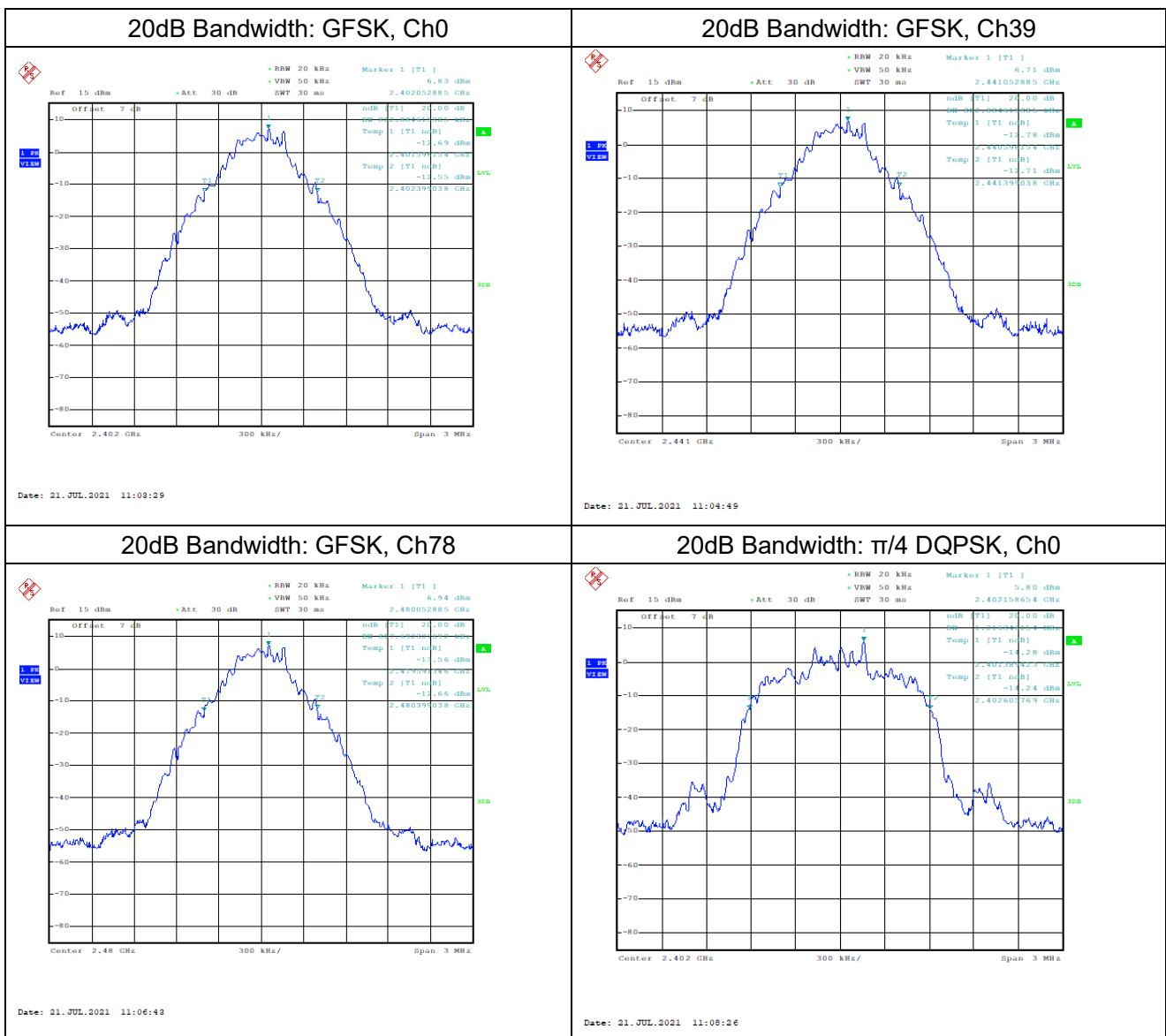

20dB Bandwidth: $\pi/4$ DQPSK, Ch39	20dB Bandwidth: $\pi/4$ DQPSK, Ch78
-------------------------------------	-------------------------------------

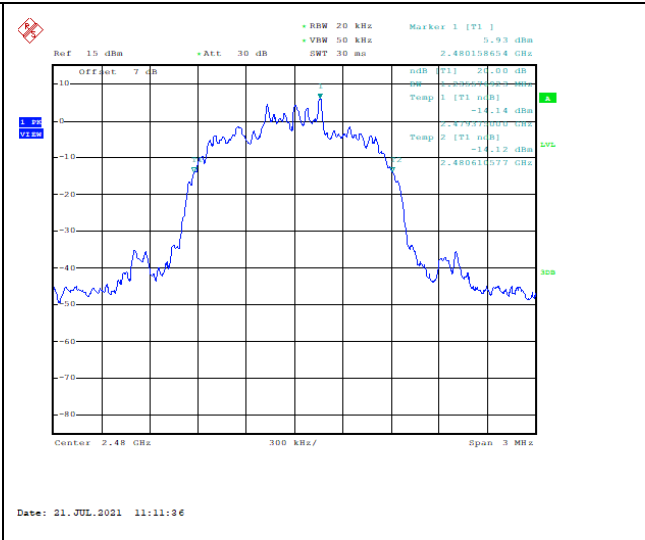
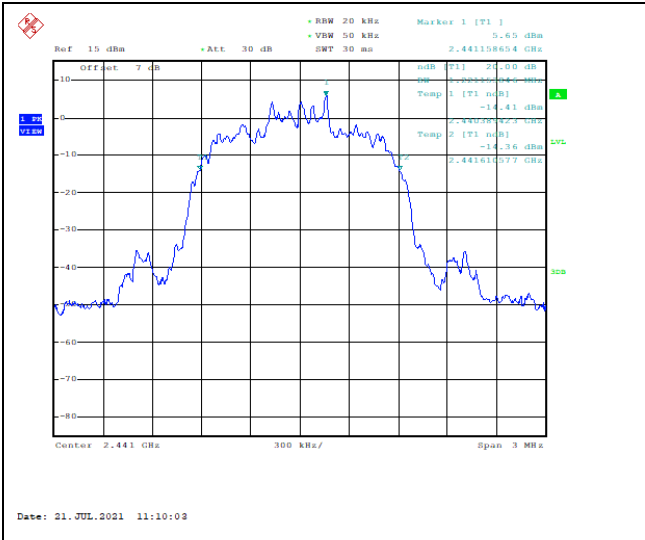

20dB Bandwidth: 8DPSK, Ch0

20dB Bandwidth: 8DPSK, Ch39

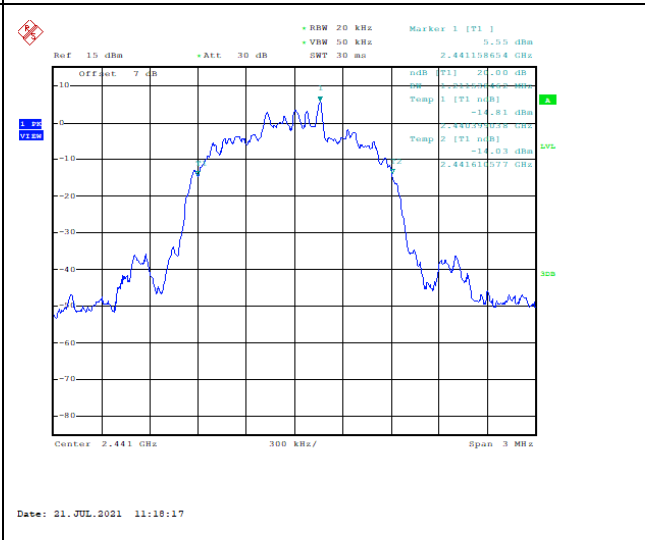
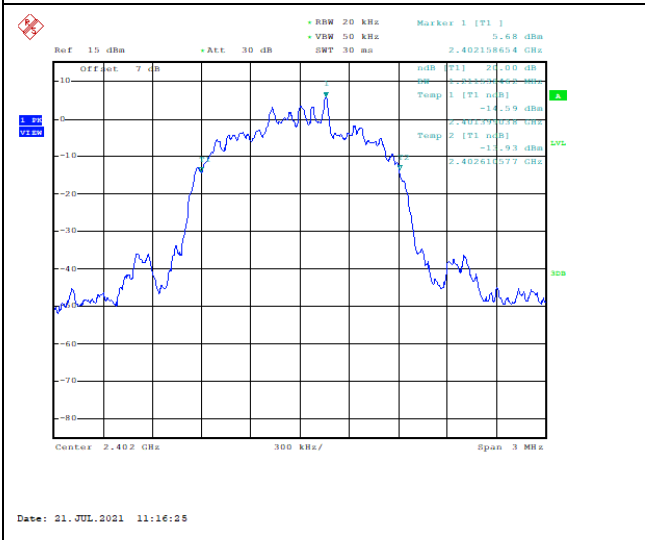

20dB Bandwidth: 8DPSK, Ch78

/

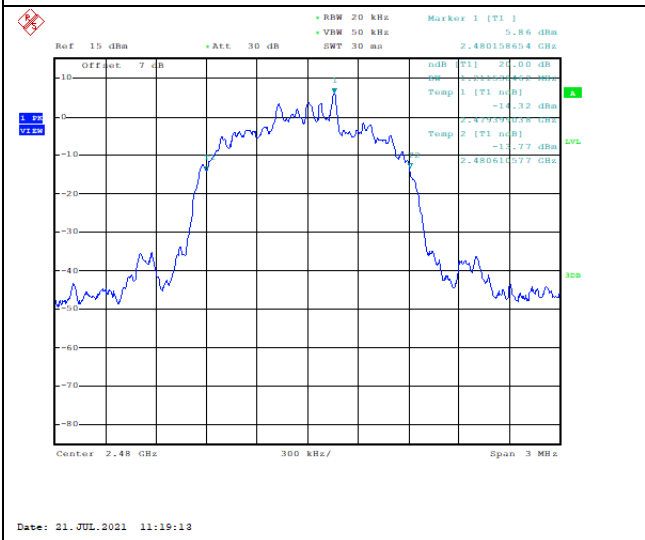

/

## 6.7. 99% Occupied Bandwidth

### 6.7.1. Measurement Limit

Standard	Limit
RSS-Gen 6.7	N/A

### 6.7.2. Test procedures

The measurement is according to ANSI C63.10 clause 6.9.3.

1. The output power of EUT was connected to the spectrum analyzer. The path loss was compensated to the results for each measurement.
2. Enable EUT transmitter maximum power continuously.
3. Set RBW shall be in the range of 1% to 5% of the OBW.
4. Set the VBW  $\geq [3 \times \text{RBW}]$ .
5. Detector = peak.
6. Trace mode = max hold.
7. Sweep = auto couple.
8. Allow the trace to stabilize.
9. The occupied bandwidth is the frequency bandwidth such that, below its lower and above its upper frequency limits, the mean powers are each equal to 0.5% of the total mean power of the given emission.

### 6.7.3. Test Setup

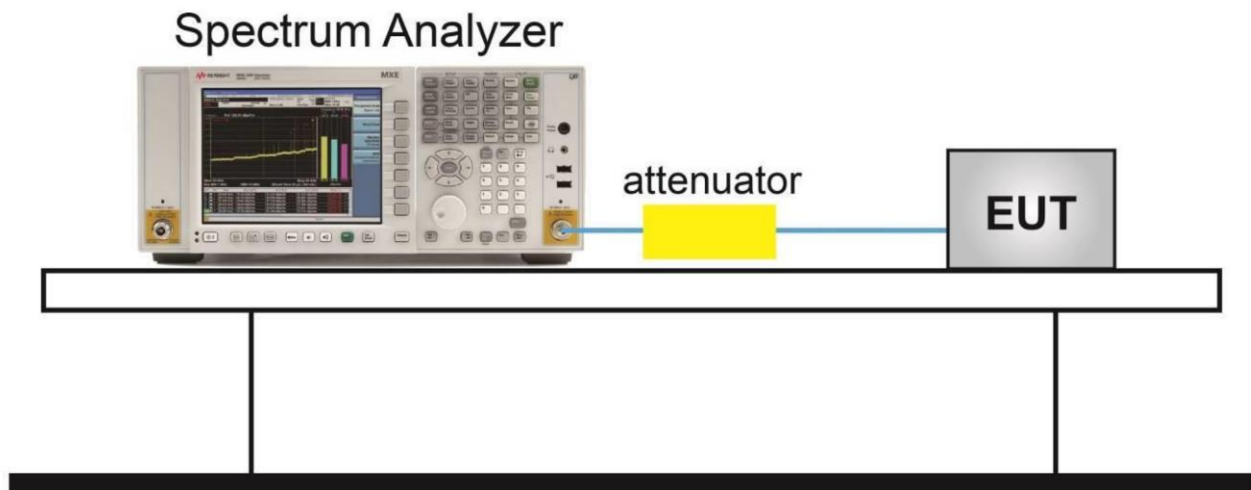

### Measurement Result

Modulation type	Frequency (MHz)	99% Bandwidth (KHz)
GFSK DH5	2402	778.846
	2441	778.846
	2480	774.038
$\pi/4$ DQPSK 2DH5	2402	1067.308
	2441	1062.5
	2480	1067.308
8DPSK 3DH5	2402	1067.308
	2441	1067.308
	2480	1067.308

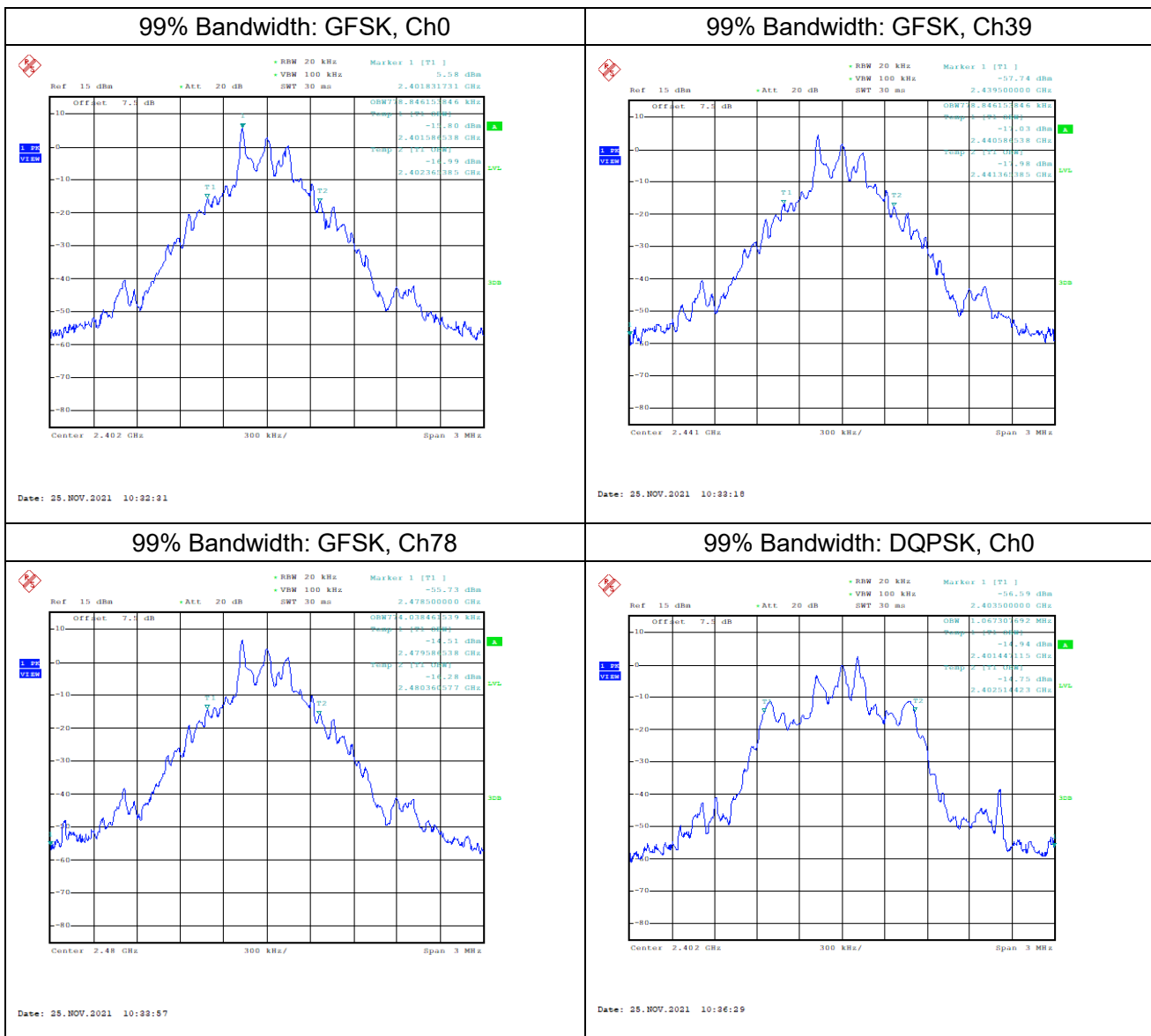

99% Bandwidth: DQPSK, Ch39

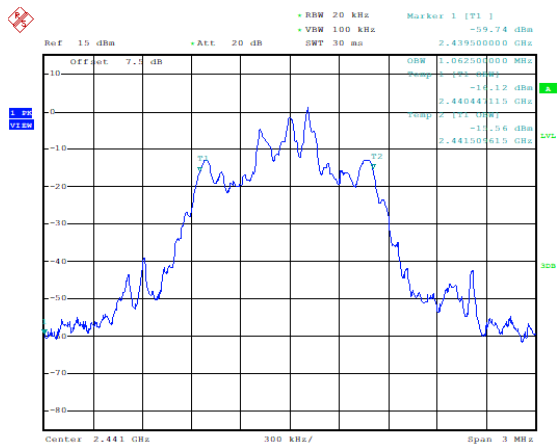

Date: 25.NOV.2021 10:37:14

99% Bandwidth: DQPSK, Ch78

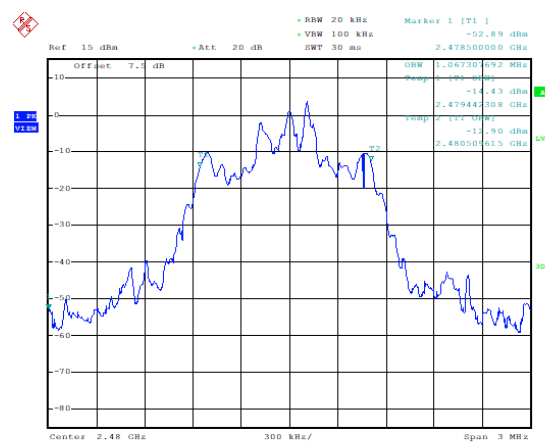

Date: 25.NOV.2021 10:38:26

99% Bandwidth: 8DPSK, Ch0

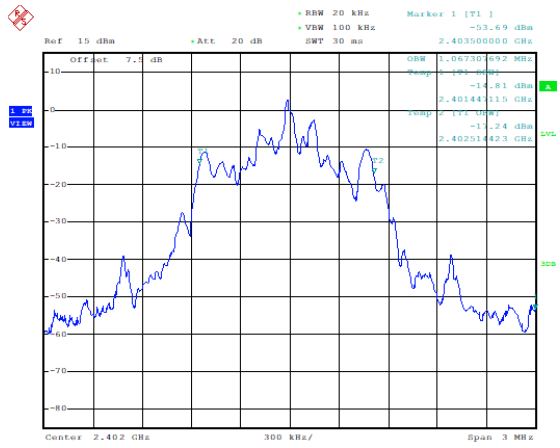

Date: 25.NOV.2021 10:40:21

99% Bandwidth: 8DPSK, Ch39

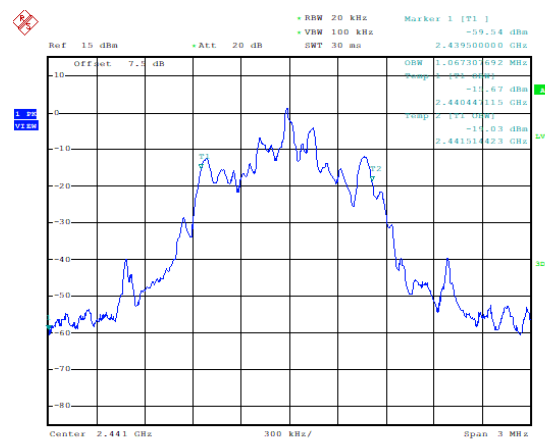

Date: 25.NOV.2021 10:42:35

99% Bandwidth: 8DPSK, Ch78

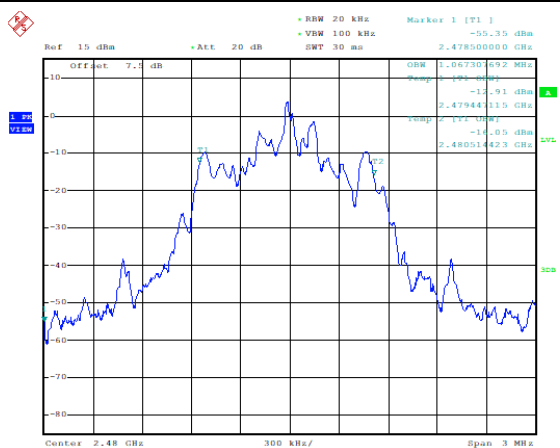

Date: 25.NOV.2021 10:43:40

/

/

## 6.8. Carrier Frequency Separation

### 6.8.1. Measurement Limit

Standard	Limit (KHz)
FCC 47 Part 15.247 (a) (1)	Over 25KHz or $(2/3)*20\text{dB}$ bandwidth
RSS-247 5.1	Over 25KHz or $(2/3)*20\text{dB}$ bandwidth

### 6.8.2. Test procedures

The measurement is according to ANSI C63.10 clause 7.8.2.

1. Connect the EUT through cable and divide with CBT32 and spectrum analyzer.
2. Enable the EUT transmit in hopping mode.
3. Span: Wide enough to capture the peaks of two adjacent channels.
4. RBW: Start with the RBW set to approximately 30% of the channel spacing; adjust as necessary to best identify the center of each individual channel.
5. Video (or average) bandwidth (VBW)  $\geq$  RBW.
6. Sweep: Auto.
7. Detector function: Peak.
8. Trace: Max hold.
9. Allow the trace to stabilize.

### 6.8.3. Test Setup

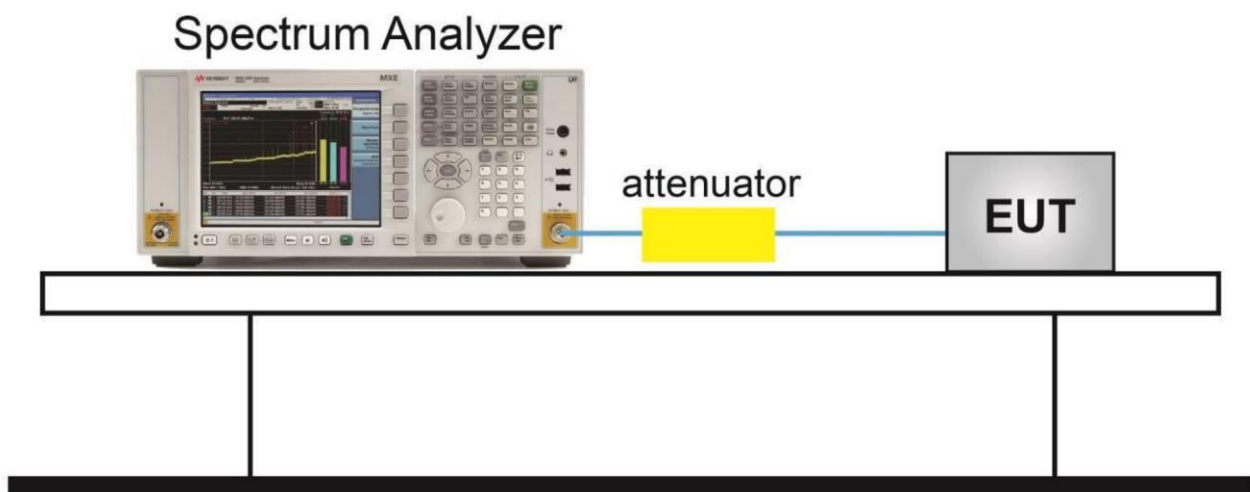

### Measurement Result

Modulation type	Frequency (MHz)	Carrier separation measurement (KHz)
GFSK DH5	2441	1155.2
$\pi/4$ DQPSK 2DH5	2441	1004.8
8DPSK 3DH5	2441	995.2

Carrier separation measurement: GFSK, Ch39	Carrier separation measurement: $\pi/4$ DQPSK, Ch39
<p>Date: 16.JUL.2021 18:46:50</p>	<p>Date: 16.JUL.2021 18:54:54</p>
Carrier separation measurement: 8DPSK, Ch39	/
<p>Date: 16.JUL.2021 18:50:47</p>	/



## 6.9. Number Of Hopping Channels

### 6.9.1. Measurement Limit

Standard	Limit
FCC 47 CFR Part 15.247 (a)(1)(iii)	At least 15 non-overlapping channels
RSS-247 5.1	At least 15 non-overlapping channels

### 6.9.2. Test procedure

The measurement is according to ANSI C63.10 clause 7.8.3.

1. Connect the EUT through cable and divide with CBT32 and spectrum analyzer.
2. Enable the EUT transmit in hopping mode.
3. Span: The frequency band of operation. Depending on the number of channels the device supports, it may be necessary to divide the frequency range of operation across multiple spans, to allow the individual channels to be clearly seen.
4. RBW: To identify clearly the individual channels, set the RBW to less than 30% of the channel spacing or the 20 dB bandwidth, whichever is smaller.
5. VBW  $\geq$  RBW.
6. Sweep: Auto.
7. Detector function: Peak.
8. Trace: Max hold.
9. Allow the trace to stabilize.
10. Record the test results.

### 6.9.3. Test Setup

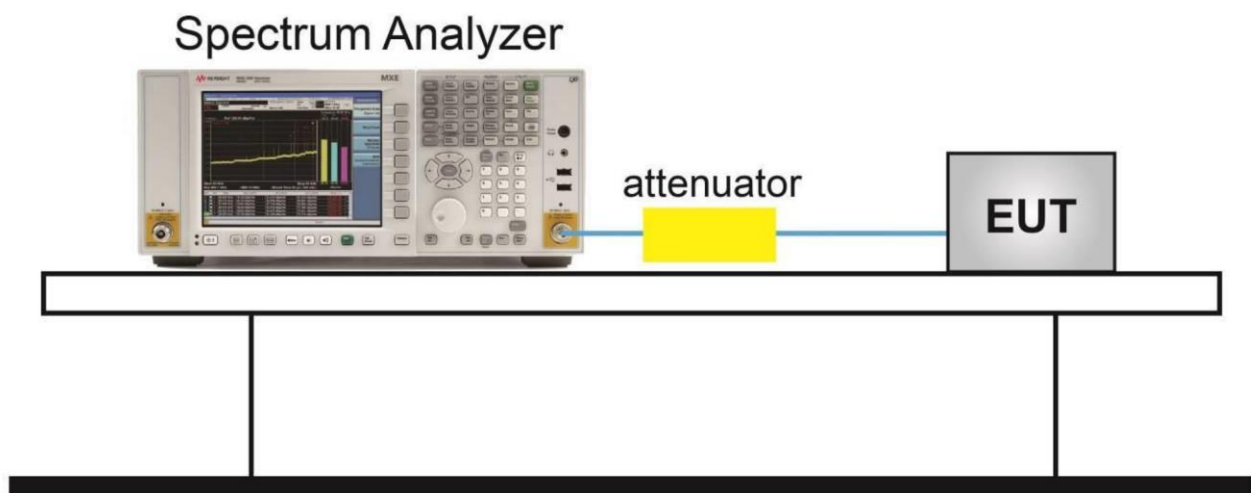

Measurement Result:

Number of hopping frequency GFSK Ch0~78:79

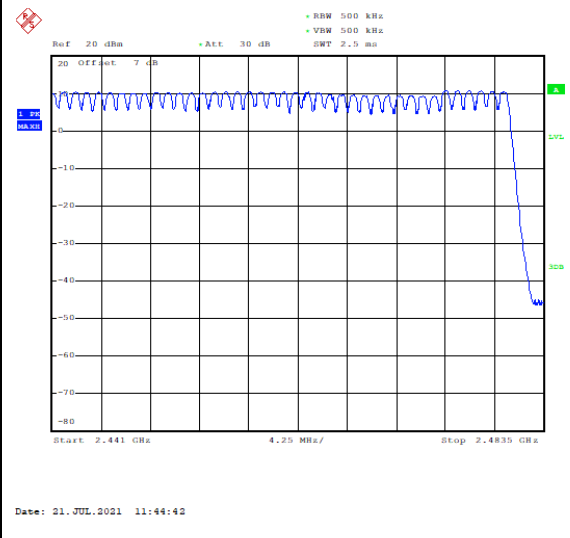
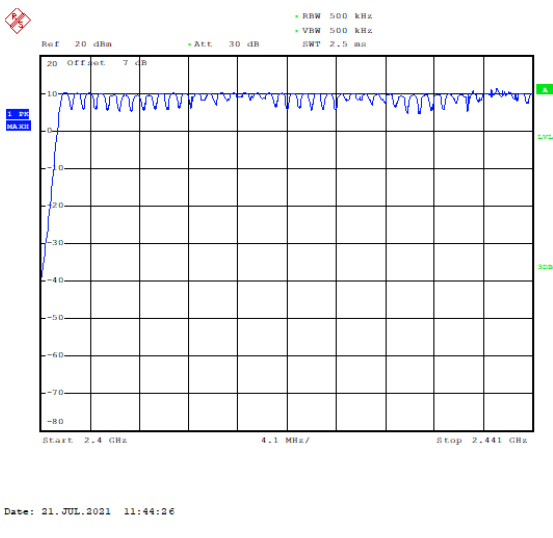

Number of hopping frequency  $\pi/4$  DQPSK Ch0~78:79

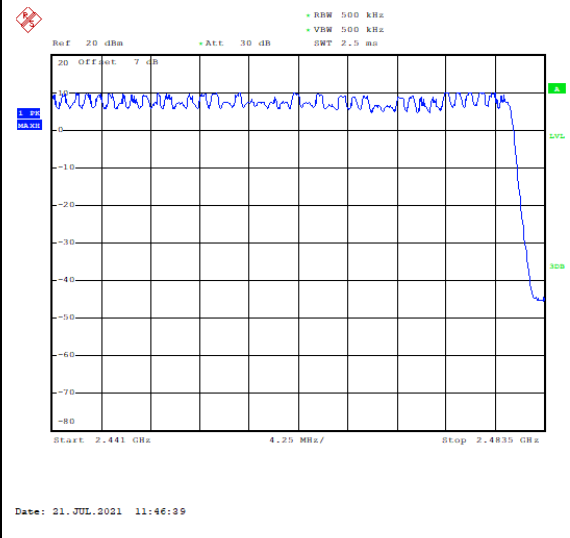
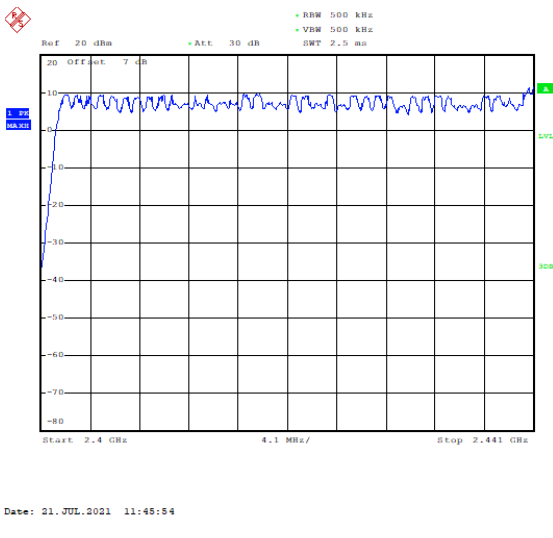

Number of hopping frequency 8PSK Ch0~78:79

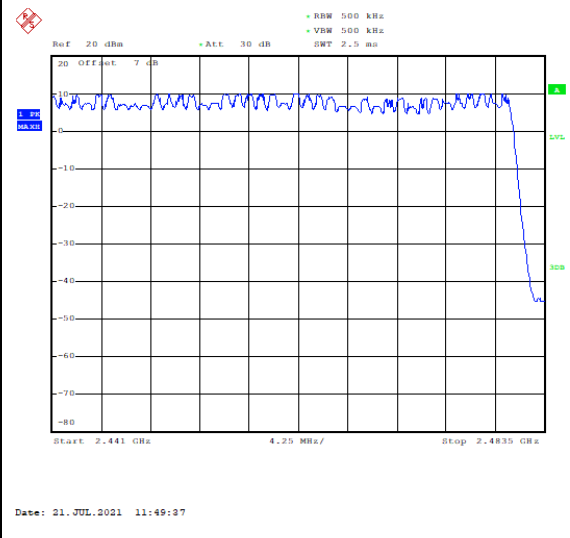
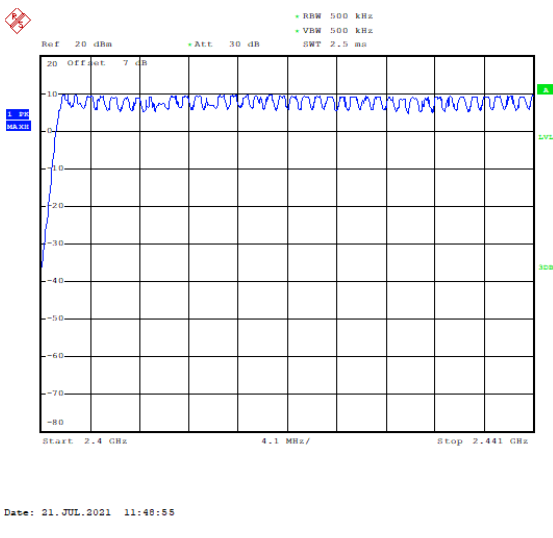

## 7. Test Equipment List

### 7.1. Conducted Test System

Item	Equipment Name	Type	Serial Number	Manufacturer	Cal. Date	Cal. interval
1	Vector Signal Analyzer	FSQ26	101091	R&S	2020-05-11	1 year
					2021-05-10	
2	DC Power Supply	ZUP60-14	LOC-220Z006-0007	TDL-Lambda	2020-05-11	1 year
					2021-05-10	
3	Eagle Test Software	Eagle V3.1 FCC BT/WIFI	N/A	ECIT	N/A	N/A

### 7.2. Radiated Emission Test System

Item	Equipment Name	Type	Serial Number	Manufacturer	Cal. Date	Cal. interval
1	Universal Radio Communication Tester	CMU200	123123	R&S	2020-05-11	1 year
					2021-05-10	
2	EMI Test Receiver	ESU40	100307	R&S	2021-03-03	1 year
3	TRILOG Broadband Antenna	VULB9163	VULB9163-515	Schwarzbeck	2021-02-03	2 years
4	Double-ridged Waveguide Antenna	ETS-3117	00135890	ETS	2020-02-28	3 years
5	Universal Radio Communication Tester	CMW500	104178	R&S	2020-05-11	1 year
					2021-05-10	
6	EMI Test Software	EMC32 V 9.15.00	N/A	R&S	N/A	N/A

Anechoic chamber

Fully anechoic chamber by ETS.

## Annex A: Measurement Uncertainty

Measurement uncertainty for all the testing in this report are within the limit specified in 3IN documents. The detailed measurement uncertainty is defined in 3IN documents.

Measurement Items	Range	Confidence Level	Calculated Uncertainty
Peak Output Power-Conducted	2402MHz-2480MHz	95%	0.544dB
Frequency Band Edges-Conducted	2402MHz-2480MHz	95%	0.544dB
Conducted Emission	30MHz-2GHz	95%	0.90dB
Conducted Emission	2GHz-3.6GHz	95%	0.88dB
Conducted Emission	3.6GHz-8GHz	95%	0.96dB
Conducted Emission	8GHz-20GHz	95%	0.94dB
Conducted Emission	20GHz-22GHz	95%	0.88dB
Conducted Emission	22GHz-26GHz	95%	0.86dB
Transmitter Spurious Emission-Radiated	9KHz-30MHz	95%	5.66dB
Transmitter Spurious Emission-Radiated	30MHz-1000MHz	95%	4.98dB
Transmitter Spurious Emission-Radiated	1000MHz -18000MHz	95%	5.06dB
Transmitter Spurious Emission-Radiated	18000MHz -40000MHz	95%	5.20dB
Dwell Time	2402MHz-2480MHz	95%	0.218ms
20dB Bandwidth	2402MHz-2480MHz	95%	62.04Hz
AC Power line Conducted Emission	0.15MHz-30MHz	95%	3.66 dB

## Annex B: Accreditation Certificate



### Accredited Laboratory

A2LA has accredited

## INDUSTRIAL INTERNET INNOVATION CENTER (SHANGHAI) CO., LTD.

Shanghai, People's Republic of China

for technical competence in the field of

### Electrical Testing

This laboratory is accredited in accordance with the recognized International Standard ISO/IEC 17025:2017 *General requirements for the competence of testing and calibration laboratories*. This accreditation demonstrates technical competence for a defined scope and the operation of a laboratory quality management system (refer to joint ISO-ILAC-IAF Communiqué dated April 2017).



Presented this 12<sup>th</sup> day of April 2021.

Vice President, Accreditation Services  
For the Accreditation Council  
Certificate Number 3682.01  
Valid to February 28, 2023

*For the tests to which this accreditation applies, please refer to the laboratory's Electrical Scope of Accreditation.*

\*\*\*\*\*END OF REPORT\*\*\*\*\*