



# TEST REPORT

Report Number: C21T00061-SRD05-V01

Applicant	Shanghai Sunmi Technology Co.,Ltd.
Product Name	Handheld Wireless Terminal
Model Name	T8911
Brand Name	SUNMI
FCC ID	2AH25T8911
IC	22621-T8911

Industrial Internet Innovation Center (Shanghai) Co., Ltd. tested the above equipment in accordance with the requirements in FCC Part15, ANSI 63.10, KDB 789033, KDB 905462, RSS-Gen Issue 5, RSS-247 Issue 2.

Prepared by 

Reviewed by 

Approved by 

Issue Date 2021-11-26

**Industrial Internet Innovation Center (Shanghai) Co., Ltd.**



## NOTE

1. This report is invalid without the signature of the writer, reviewer and authorizer.
2. This report is invalid if altered.
3. For the benefit of clients, if you have any objection to the report, please inform the testing laboratory within 15 days from the date of receiving this report.
4. Samples in the test report are provided by the client. The test results are only applicable to the samples received by the laboratory. The source information of samples (such as sample sender, manufacturer, etc.) in the test report is provided by the client, and the laboratory is not responsible for its authenticity and the measurement accuracy.
5. The test report does not represent the identification of a product by a certification body or an authorized body.
6. This report is only valid as a whole, and no part of the report can be reproduced without the written approval of Industrial Internet Innovation Center (Shanghai) Co., Ltd.
7. Without the written permission of testing institutions and accreditation bodies, this report cannot be used in part or in whole for publicity or product introduction.
8. "N/A" is used in this report to indicate that it is not applicable or available.
9. Industrial Internet Innovation Center (Shanghai) Co., Ltd. assumes the legal responsibility for the report.
10. The measurement uncertainty is not taken into account when deciding conformity, and the results of measurement (or the average of measurement results) are directly used as the criterion for the stating conformity.

### **Test Laboratory:**

Industrial Internet Innovation Center (Shanghai) Co., Ltd.

Add: Building 4, No. 766 Jingang Rd, Pudong, Shanghai, China

Tel: +86 21 68866880



### Revision Version

Report Number	Revision	Date	Memo
C21T00061-SRD05-V00	00	2021-11-03	Initial creation of test report
C21T00061-SRD05-V01	01	2021-11-26	1. The normal voltage of the prototype in the report has been corrected. 2. A declaration has been added in section 6.7.



## CONTENTS

<b>1. TEST LABORATORY .....</b>	<b>6</b>
<b>1.1. TESTING LOCATION .....</b>	<b>6</b>
<b>1.2. TESTING ENVIRONMENT .....</b>	<b>6</b>
<b>1.3. PROJECT INFORMATION .....</b>	<b>6</b>
<b>2. CLIENT INFORMATION .....</b>	<b>7</b>
<b>2.1. APPLICANT INFORMATION .....</b>	<b>7</b>
<b>2.2. MANUFACTURER INFORMATION .....</b>	<b>7</b>
<b>3. EQUIPMENT UNDER TEST (EUT) AND ANCILLARY EQUIPMENT (AE) .....</b>	<b>8</b>
<b>3.1. ABOUT EUT .....</b>	<b>8</b>
<b>3.2. INTERNAL IDENTIFICATION OF EUT USED DURING THE TEST .....</b>	<b>8</b>
<b>3.3. INTERNAL IDENTIFICATION OF AE USED DURING THE TEST .....</b>	<b>8</b>
<b>4. REFERENCE DOCUMENTS .....</b>	<b>9</b>
<b>4.1. REFERENCE DOCUMENTS FOR TESTING .....</b>	<b>9</b>
<b>4.2. REFERENCE INFORMATION FROM CLIENT .....</b>	<b>9</b>
<b>5. TEST SUMMARY .....</b>	<b>10</b>
<b>5.1. SUMMARY OF TEST RESULTS .....</b>	<b>10</b>
<b>5.2. STATEMENTS .....</b>	<b>11</b>
<b>6. MEASUREMENT RESULTS .....</b>	<b>12</b>
<b>6.1. MAXIMUM AVERAGE OUTPUT POWER .....</b>	<b>13</b>
<b>6.1.1. Measurement Limit and Method .....</b>	<b>13</b>
<b>6.1.2. Method of Measurement: See ANSI C63.10-clause 12.3.2.2 Method SA-1 .....</b>	<b>13</b>
<b>6.1.3 Test Setup .....</b>	<b>13</b>
<b>6.2. PEAK POWER SPECTRAL DENSITY .....</b>	<b>19</b>
<b>6.2.1. Measurement Limit .....</b>	<b>19</b>
<b>6.2.2. The measurement is made according to ANSI C63.10 and KDB789033 D02 .....</b>	<b>19</b>
<b>6.2.3 Test Setup .....</b>	<b>19</b>



<b>6.3. 6DB OCCUPIED BANDWIDTH .....</b>	<b>25</b>
<b>6.3.1. Measurement Limit.....</b>	<b>25</b>
<b>6.3.2. The measurement is made according to KDB 789033 .....</b>	<b>25</b>
<b>6.3.3 Test Setup .....</b>	<b>25</b>
<b>6.4. 99% OCCUPIED BANDWIDTH .....</b>	<b>30</b>
<b>6.4.1. Measurement Limit.....</b>	<b>30</b>
<b>6.4.2. The measurement is made according to KDB 789033 .....</b>	<b>30</b>
<b>6.4.3 Test Setup .....</b>	<b>30</b>
<b>6.5. FREQUENCY STABILITY .....</b>	<b>35</b>
<b>6.6. TRANSMITTER SPURIOUS EMISSION .....</b>	<b>35</b>
<b>6.6.1. Transmitter Spurious Emission – Conducted.....</b>	<b>35</b>
<b>6.6.2. Transmitter Spurious Emission - Radiated .....</b>	<b>43</b>
<b>6.7. BAND EDGES COMPLIANCE.....</b>	<b>59</b>
<b>6.7.1 Measurement Limit.....</b>	<b>59</b>
<b>6.7.2. Set the spectrum analyzer in the following.....</b>	<b>61</b>
<b>7. TEST EQUIPMENT LIST.....</b>	<b>66</b>
<b>7.1. CONDUCTED TEST SYSTEM.....</b>	<b>66</b>
<b>7.2. RADIATED EMISSION TEST SYSTEM.....</b>	<b>66</b>
<b>ANNEX A: MEASUREMENT UNCERTAINTY.....</b>	<b>67</b>
<b>ANNEX B: ACCREDITATION CERTIFICATE.....</b>	<b>68</b>

## 1. Test Laboratory

### 1.1. Testing Location

Primary Lab:

Company Name	Industrial Internet Innovation Center (Shanghai) Co., Ltd.
Address	Building 4, No. 766 Jingang Rd, Pudong, Shanghai, China
FCC Registration No.	958356
FCC Designation No.	CN1177
IC designation No.	CN0067

Subcontracting Lab #1:

Company Name	N/A
Address	N/A

### 1.2. Testing Environment

Normal Temperature	15°C~35°C
Relative Humidity	30%RH~60%RH
Supply Voltage	230V/60Hz

### 1.3. Project Information

Project Leader	Wang Wenen
Testing Start Date	2021-06-15
Testing End Date	2021-08-25



## 2. Client Information

### 2.1. Applicant Information

Company Name	Shanghai Sunmi Technology Co.,Ltd.
Address	Room 505, KIC Plaza, No.388 Song Hu Road, Yang Pu District, Shanghai, China
Telephone	+86 18721763396

### 2.2. Manufacturer Information

Company Name	Shanghai Sunmi Technology Co.,Ltd.
Address	Room 505, KIC Plaza, No.388 Song Hu Road, Yang Pu District, Shanghai, China
Telephone	+86 18721763396

### 3. Equipment under Test (EUT) and Ancillary Equipment (AE)

#### 3.1. About EUT

Product Name	Handheld Wireless Terminal
Model name	T8911
Supported Radio Technology and Bands	GSM850/GSM900/GSM1800/GSM1900 WCDMA Band I /Band II/Band IV/Band V /Band VIII CDMA Band BC0/BC1/BC10 LTE 1/2/3/4/5/7/12/13/14/17/18/19/25/26/28/38/41/66/71 LTE CA Up Link 2CA: 7C,41C BT5.0 WLAN 802.11b,g,n WLAN 802.11a,n,ac NFC GPS GLONASS Galileo BDS
Hardware Version	V1.02
Software Version	V01_T46
WLAN Frequency	U-NII-3:5725 MHz~5850 MHz
FCC ID	2AH25T8911
IC	22621-T8911

#### 3.2. Internal Identification of EUT used during the test

EUT ID*	SN or IMEI	HW Version	SW Version	Date of Receipt
N01	864679050005368 864679050014659	V1.02	V01_T46	2021-06-04
N05	864679050005574 864679050014865	V1.02	V01_T46	2021-06-18

\*EUT ID: is internally used to identify the test sample in the lab.

#### 3.3. Internal Identification of AE used during the test

AE ID*	Description	Model	SN/Remark
AE1	RF Cable	N/A	N/A

\*AE ID: is internally used to identify the test sample in the lab.

\*The AE is provided by the client.



## 4. Reference Documents

### 4.1. Reference Documents for testing

The following documents listed in this section are referred for testing.

Reference	Title	Version
FCC Part15	Title 47 of the Code of Federal Regulations; Chapter I Part 15 - Radio frequency devices	2018-10-01
ANSI 63.10	Methods of Measurement of Radio-Noise Emissions from Low-Voltage Electrical and Electronic Equipment in the Range of 9 kHz to 40 GHz	2013
KDB 789033	Information Infrastructure (U-NII) Devices - Part 15, Subpart E	2017
KDB 905462	COMPLIANCE MEASUREMENT PROCEDURES FOR UNLICENSED-NATIONAL INFORMATION INFRASTRUCTURE DEVICES OPERATING IN THE 5250-5350 MHz AND 5470-5725 MHz BANDS INCORPORATING DYNAMIC FREQUENCY SELECTION	2016
RSS-247 Issue 2	Digital Transmission Systems (DTSSs), Frequency Hopping Systems (FHSs) and Licence-Exempt Local Area Network (LE-LAN) Devices	2017
RSS-Gen Issue 5	General Requirements for Compliance of Radio Apparatus	2019

### 4.2. Reference Information from client

Antenna gain Information of the test sample provided by client.

Maximum of Antenna Gain: 0.69 dBi

Note: The product T8911 use an integral antenna which compliance with the requirement of 15.203.

## 5. Test Summary

### 5.1. Summary of Test Results

Measurement Items	Sub-clause of Part15	Sub-clause of IC	Verdict
Maximum Output Power	15.407(a)	RSS-247 6.2	Pass
Power Spectral Density	15.407(a)	RSS-247 6.2	Pass
6dB Occupied Bandwidth	15.407(e)	RSS-247 6.2	Pass
99% Occupied Bandwidth	N/A	RSS-GEN 6.7	Pass
Band edge compliance	15.407(b)	RSS-247 6.2	Pass
Transmitter Spurious Emission - Conducted	15.407	RSS-247 6.2	Pass
Transmitter Spurious Emission - Radiated	15.407,15.205,15.209	RSS-247 6.2 RSS-Gen 8.9,8.10	Pass

#### Test Conditions

Tnom	Normal Temperature
Tmin	Low Temperature
Tmax	High Temperature
Vnom	Normal Voltage
Vmin	Low Voltage
Vmax	High Voltage
Hnom	Norm Humidity
Anom	Norm Air Pressure

For this report, all the test case listed above are tested under Normal Temperature and Normal Voltage, and also under norm humidity, the specific conditions as following:

Temperature	Tnom	25°C
Voltage	Vnom	24 V
Humidity	Hnom	48%
Air Pressure	Anom	1010hPa

#### Note:

- a. All the test data for each data were verified, but only the worst case was reported.
- b. The DC and low frequency voltages' measurement uncertainty is  $\pm 2\%$ .



## 5.2. Statements

The T8911 manufactured by Shanghai Sunmi Technology Co.,Ltd., Incorporated are new products for testing.

Industrial Internet Innovation Center (Shanghai) Co., Ltd. only performed test cases which identified with Pass/Fail/Inc result in section 5.1.

Industrial Internet Innovation Center (Shanghai) Co., Ltd. has verified that the compliance of the tested device specified in section 3 of this test report is successfully evaluated according to the procedure and test methods as defined in type certification requirement listed in section 4 of this test report.

## 6. Measurement Results

**Shielding Room1** (6.0 meters×3.0 meters×2.7 meters) did not exceed following limits along the conducted RF performance testing:

Temperature	Min. = 15 °C, Max. = 35 °C
Relative humidity	Min. = 20 %, Max. = 75 %
Shielding effectiveness	> 100 dB
Ground system resistance	< 0.5 Ω
Temperature	Min. = 15 °C, Max. = 35 °C

**Control room** did not exceed following limits along the EMC testing:

Temperature	Min. = 15 °C, Max. = 35 °C
Relative humidity	Min. = 30 %, Max. = 60 %
Shielding effectiveness	> 100 dB
Electrical insulation	> 10 kΩ
Ground system resistance	< 0.5 Ω

**Fully-anechoic chamber1** (6.9 meters×10.9 meters×5.4 meters) did not exceed following limits along the EMC testing:

Temperature	Min. = 15 °C, Max. = 35 °C
Relative humidity	Min. = 25 %, Max. = 75 %
Shielding effectiveness	> 100 dB
Electrical insulation	> 10 kΩ
Ground system resistance	< 0.5 Ω
VSWR	Between 0 and 6 dB, from 1GHz to 18GHz
Site Attenuation Deviation	Between -4 and 4 dB, 30MHz to 1GHz
Uniformity of field strength	Between 0 and 6 dB, from 80MHz to 3000 MHz

## 6.1. Maximum Average Output Power

### 6.1.1. Measurement Limit and Method

Standard	Limit (dBm)
FCC CRF Part 15.407(a)	< 30
RSS-247 6.2.4.1	< 30

### 6.1.2. Method of Measurement: See ANSI C63.10-clause 12.3.2.2 Method SA-1

Set the spectrum analyzer in the following:

Detector: RMS.

RBW=1MHz.

VBW=3MHz.

Sweep time = AUTO.

Span: 30MHz (for 20MHz); 50MHz (for 40MHz).

### 6.1.3 Test Setup

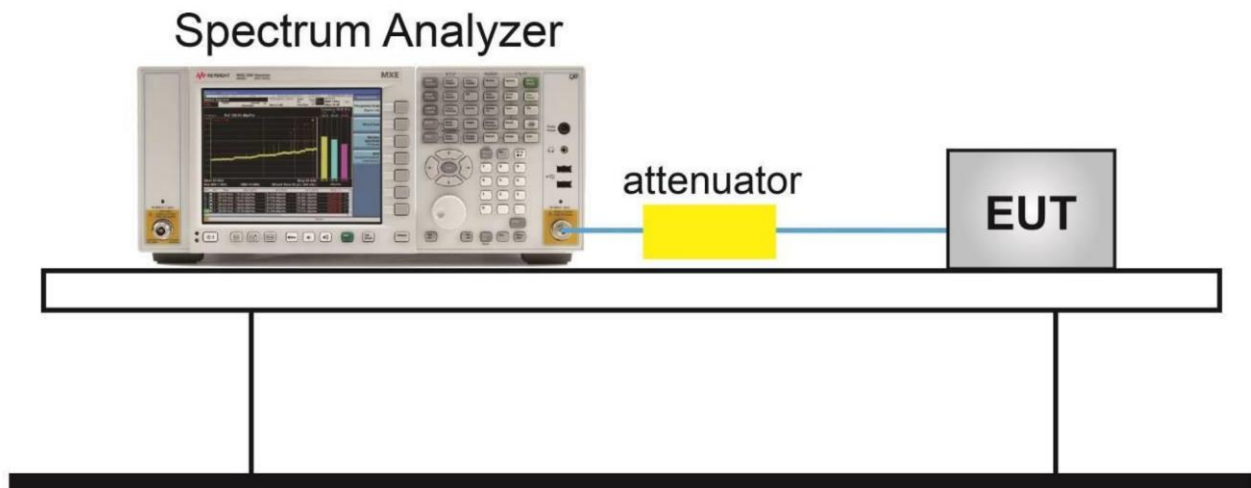



**Measurement Results:**

**U-NII-3**

Mode	Channel	Conducted (dBm)	E. I.R.P(dBm)	Duty cycle factor (dB)
802.11a	5745	10.6	11.43	0.14
	5785	11.47	12.3	0.14
	5825	10.97	11.8	0.14
802.11n(20MHz)	5745	10.2	11.04	0.15
	5785	11.05	11.89	0.15
	5825	10.97	11.81	0.15
802.11n(40MHz)	5755	10.91	12.13	0.53
	5795	11.4	12.62	0.53
802.11ac	5745	10.26	11.08	0.13
	5785	11.16	11.98	0.13
	5825	10.59	11.41	0.13
802.11ac(40)	5755	10.88	12.1	0.53
	5795	11.39	12.61	0.53
802.11ac(80)	5755	9.29	11.64	1.66

**Conclusion: PASS**

**TEST PLOTS:**

### Output Power-Conducted (802.11a, Ch149)

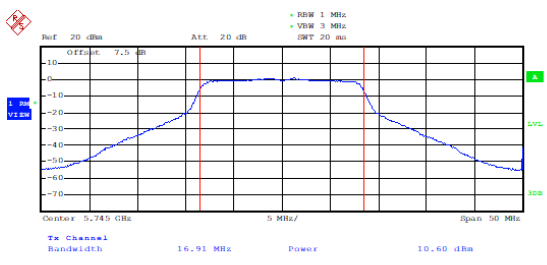

Date: 16.AUG.2021 11:34:55

### Output Power-Conducted (802.11a, Ch157)

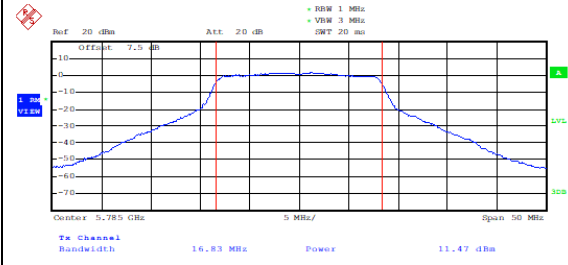

Date: 16.AUG.2021 11:35:52

### Output Power-Conducted (802.11a, Ch165)

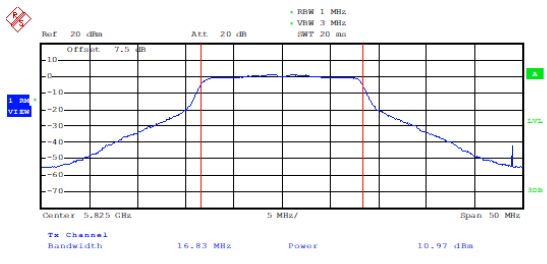

Date: 16.AUG.2021 11:37:33

### Output Power-Conducted (802.11n-HT20, Ch149)

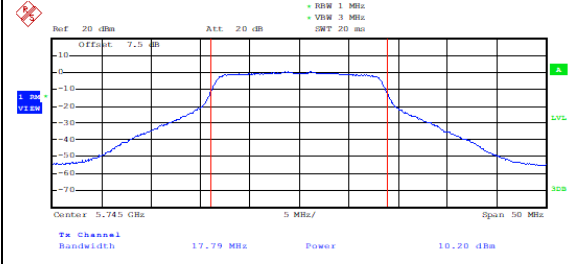

Date: 16.AUG.2021 11:38:37

### Output Power-Conducted (802.11n-HT20, Ch157)

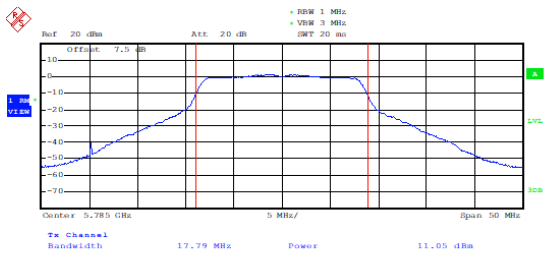

Date: 16.AUG.2021 11:39:30

### Output Power-Conducted (802.11n-HT20, Ch165)

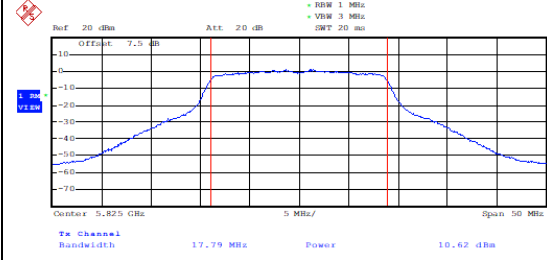

Date: 16.AUG.2021 11:40:28

### Output Power-Conducted (802.11n-HT40, Ch151)

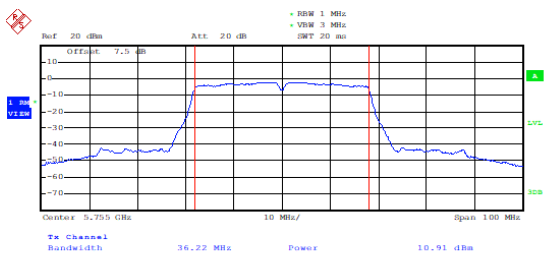

Date: 16.AUG.2021 11:42:04

### Output Power-Conducted (802.11n-HT40, Ch159)

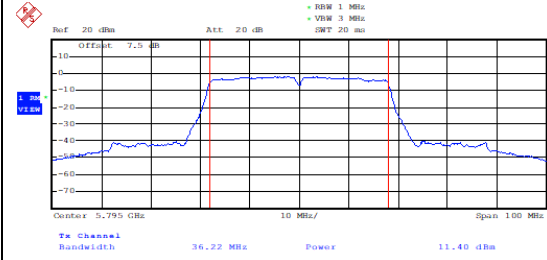

Date: 16.AUG.2021 11:43:29



### Output Power-Conducted (802.11ac-VHT20, Ch149)

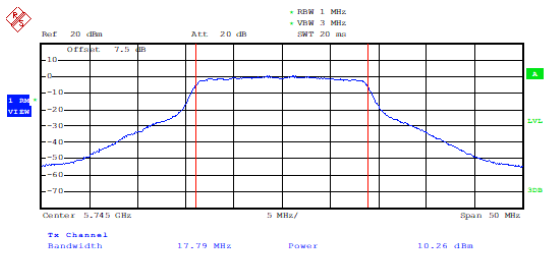

Date: 16.AUG.2021 11:44:35

### Output Power-Conducted (802.11ac-VHT20, Ch157)

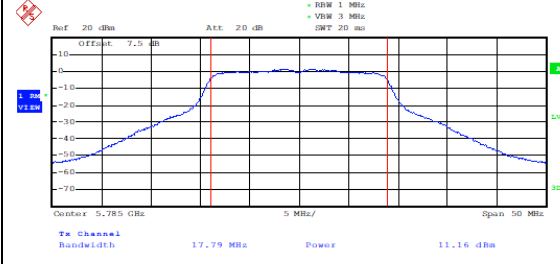

Date: 16.AUG.2021 11:46:19

### Output Power-Conducted (802.11ac-VHT20, Ch165)

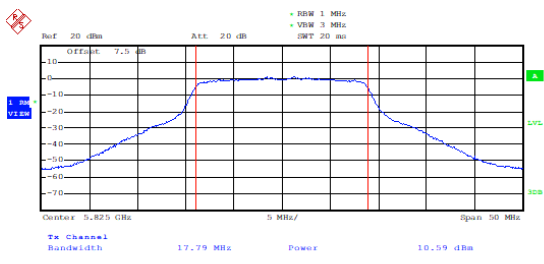

Date: 16.AUG.2021 11:47:39

### Output Power-Conducted (802.11ac-VHT40, Ch151)

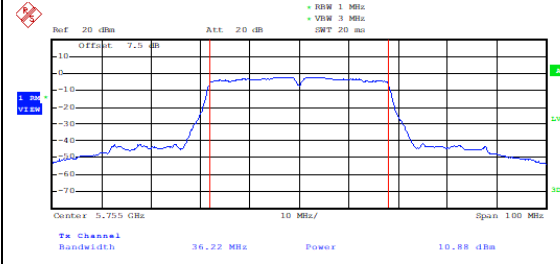

Date: 16.AUG.2021 11:49:50

Output Power-Conducted  
(802.11ac-VHT40, Ch159)

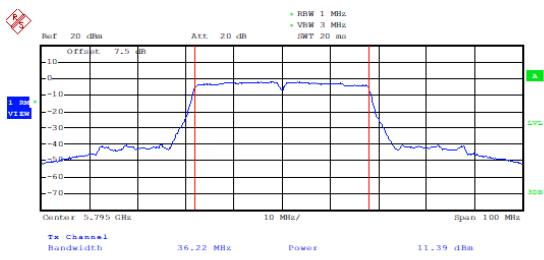

Date: 16.AUG.2021 11:53:15

Output Power-Conducted  
(802.11ac-VHT80, Ch155)

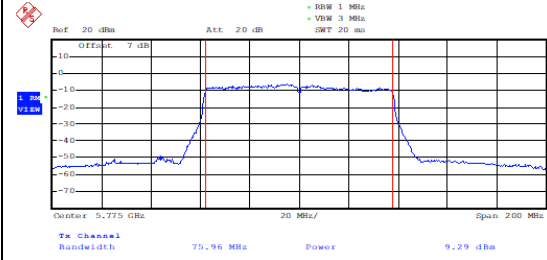

Date: 21.JUN.2021 15:18:02

## 6.2. Peak Power Spectral Density

### 6.2.1. Measurement Limit

Standard	Limit
FCC 47 CFR Part 15.407(a)	< 30 dBm/500 kHz
RSS-247 6.2.4.1	< 30 dBm/500 kHz

6.2.2. The measurement is made according to ANSI C63.10 and KDB789033 D02

### 6.2.3 Test Setup

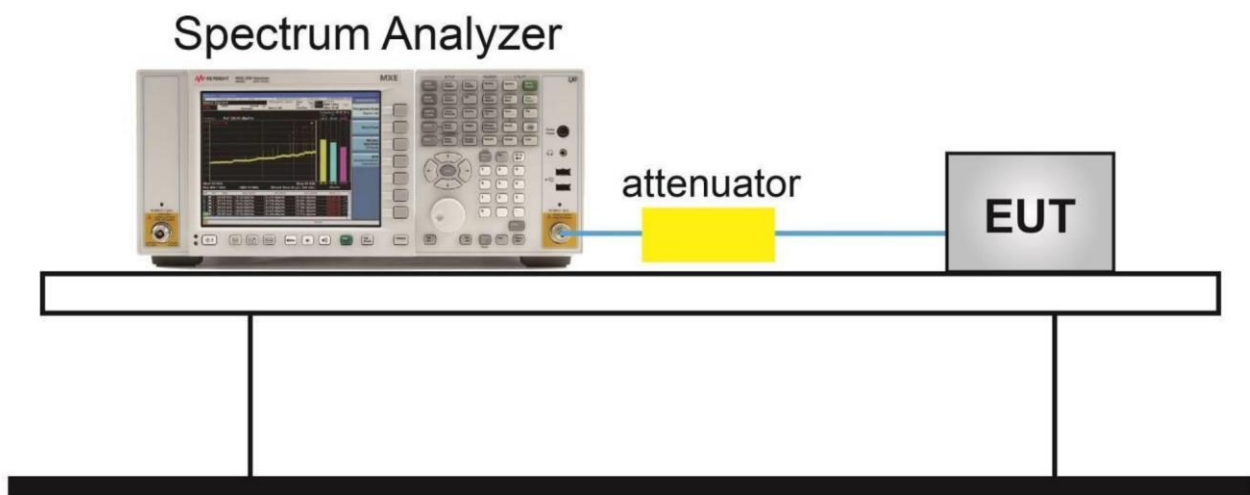

### Measurement Results

Mode	Channel	Power Spectral Density (dBm/500kHz)	Conclusion
802.11a	149	-0.781	P
	157	-1.487	P
	165	-0.354	P
802.11n HT20	149	-1.256	P
	157	-1.746	P
	165	-1.136	P
802.11n HT40	151	-3.817	P
	159	-4.228	P
802.11ac HT20	149	-1.271	P
	157	-1.745	P
	165	-1.633	P
802.11ac HT40	151	-3.852	P
	159	-4.116	P
802.11ac HT80	155	-6.489	P

Test graphs as below

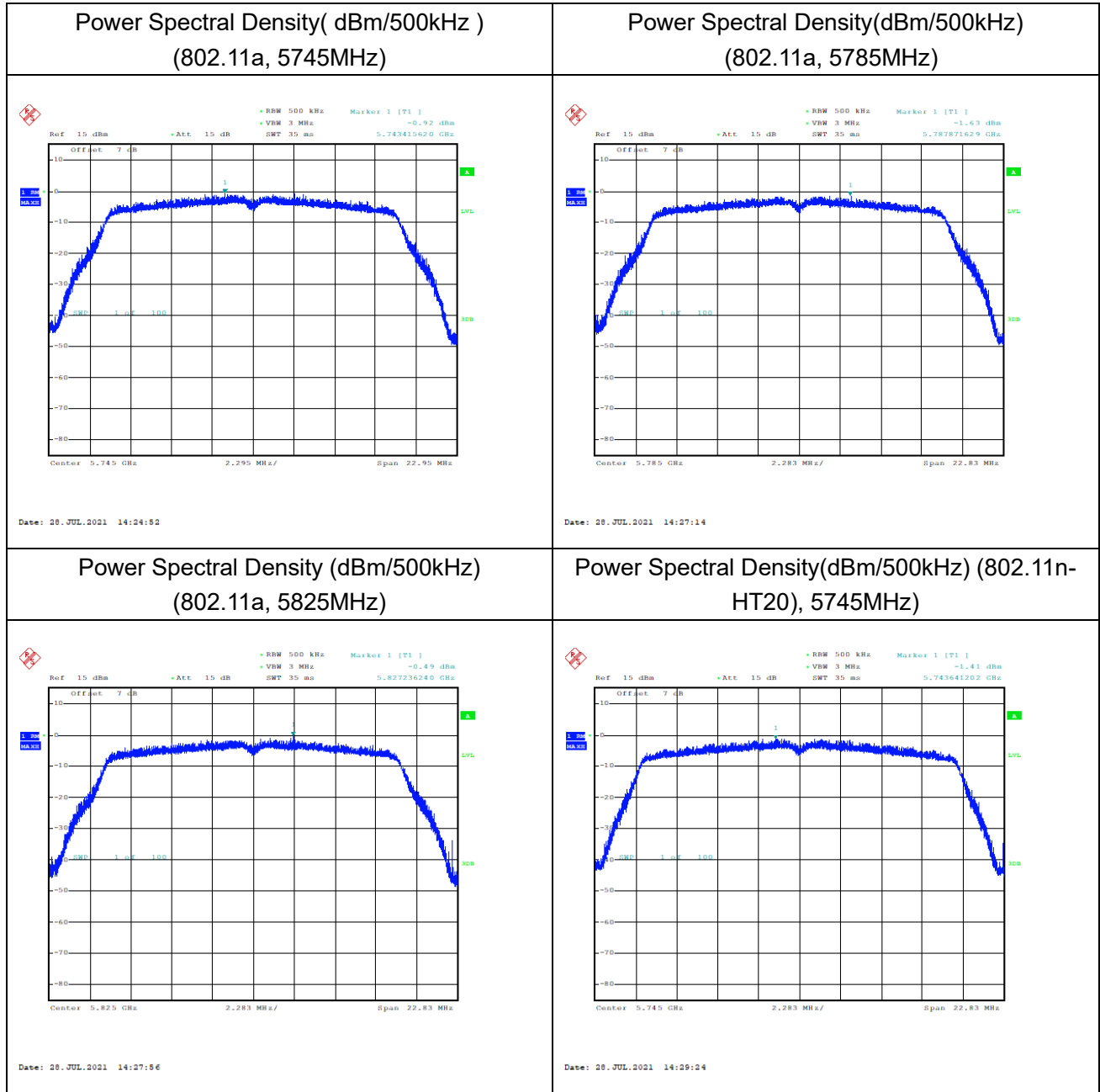

Power Spectral Density (dBm/500kHz) (802.11n-HT20, 5785MHz)

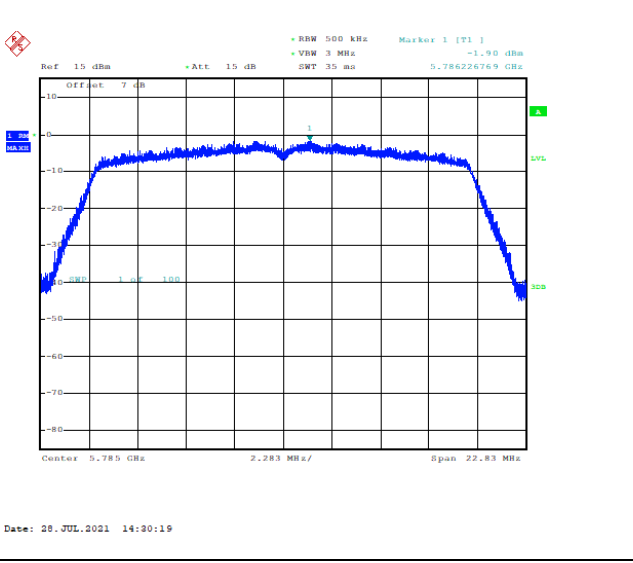

Power Spectral Density(dBm/500kHz) (802.11n-HT20), 5825MHz)

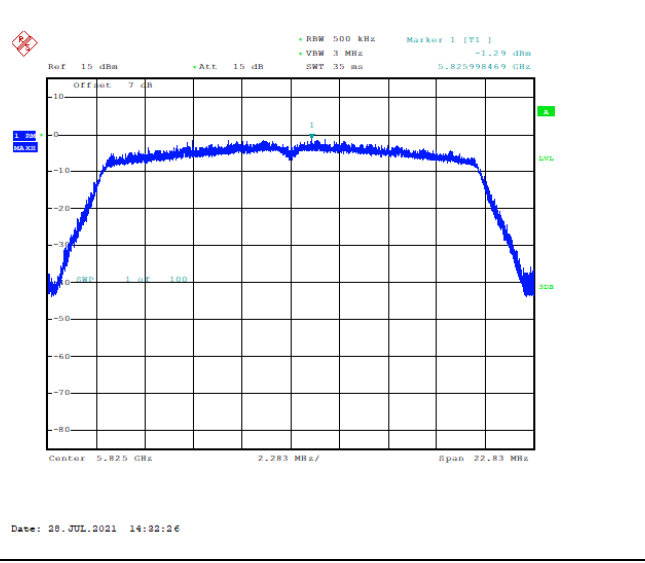

Power Spectral Density (dBm/500kHz) (802.11n-HT40, 5755MHz)

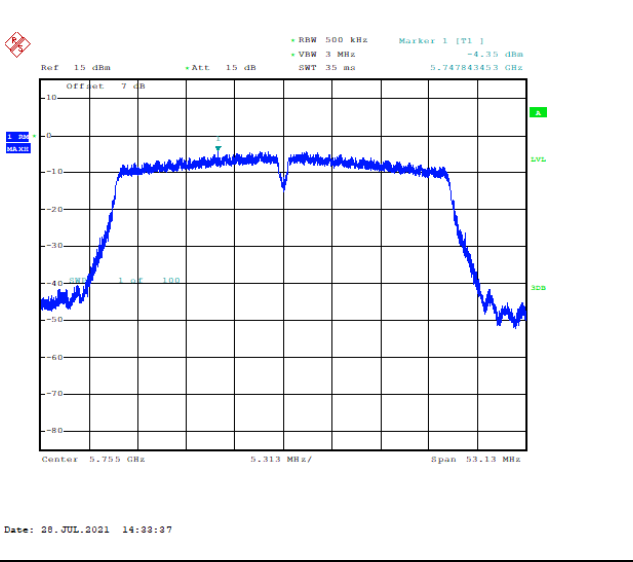

Power Spectral Density(dBm/500kHz) (802.11n-HT40), 5795MHz)

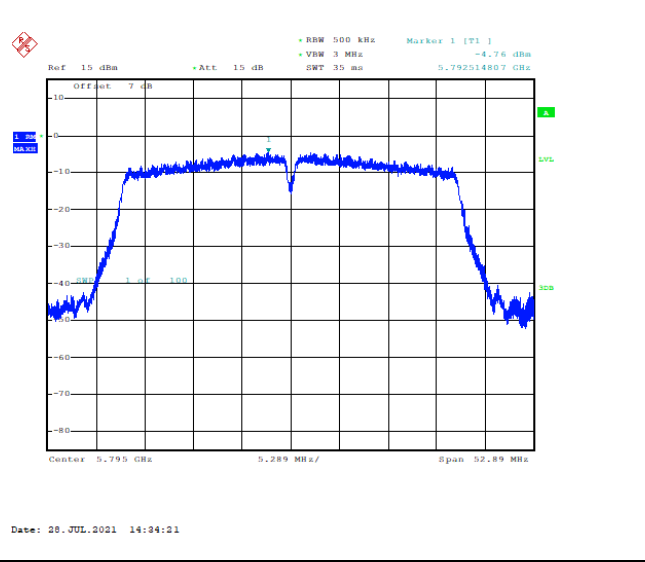

Power Spectral Density(dBm/500kHz) (802.11ac-VHT20, 5745MHz)

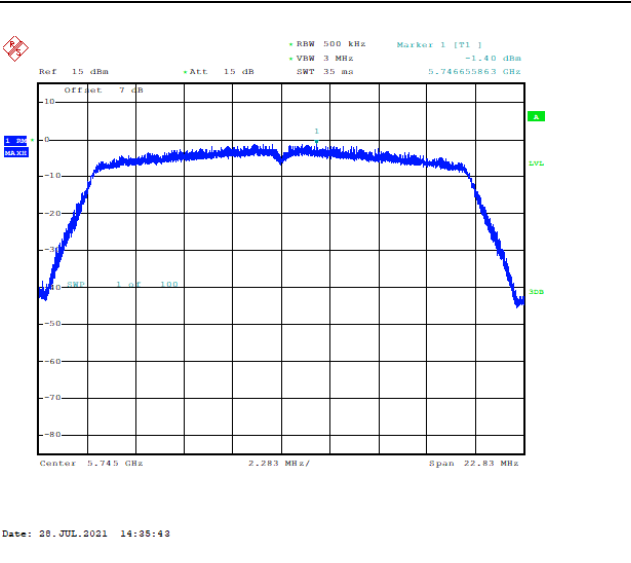

Power Spectral Density(dBm/500kHz) (802.11ac-VHT20, 5785MHz)

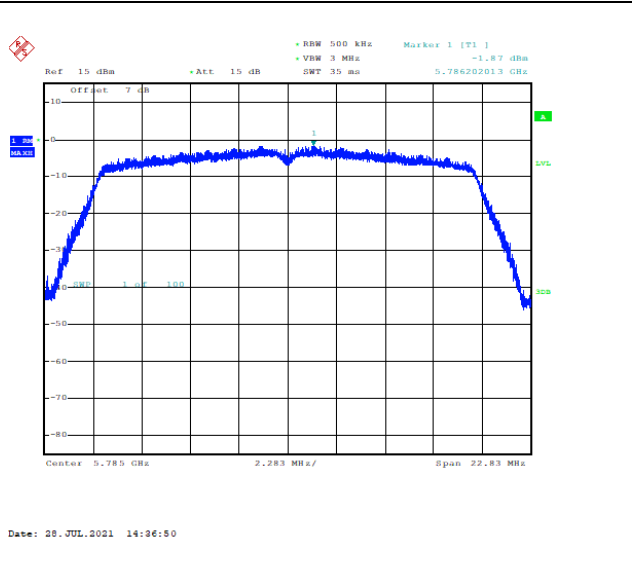

Power Spectral Density (dBm/500kHz) (802.11ac-VHT20, 5825MHz)

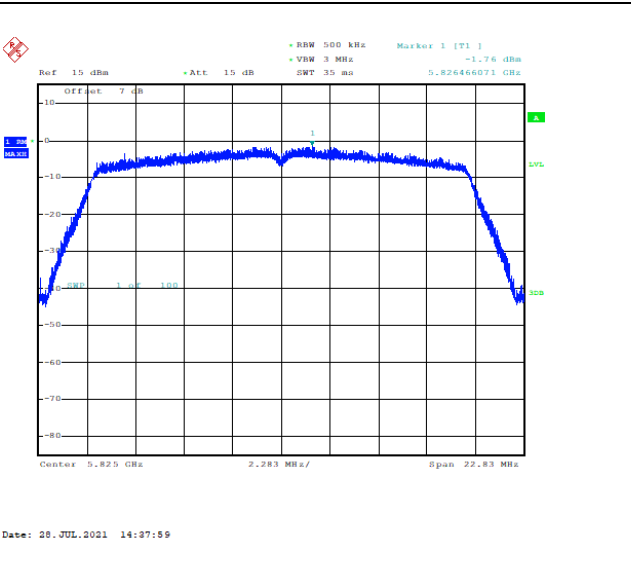

Power Spectral Density (dBm/500kHz) (802.11ac-VHT40, 5755MHz)

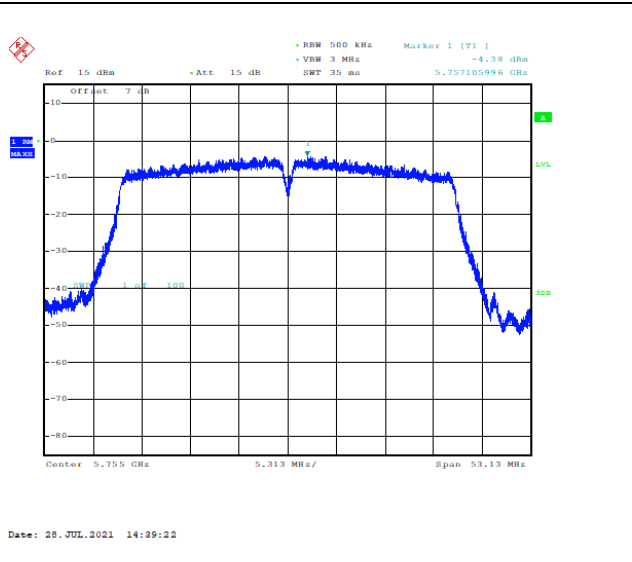

Power Spectral Density (dBm/500kHz) (802.11ac-VHT40, 5795MHz)

Power Spectral Density (dBm/500kHz) (802.11ac-VHT80, 5775MHz)

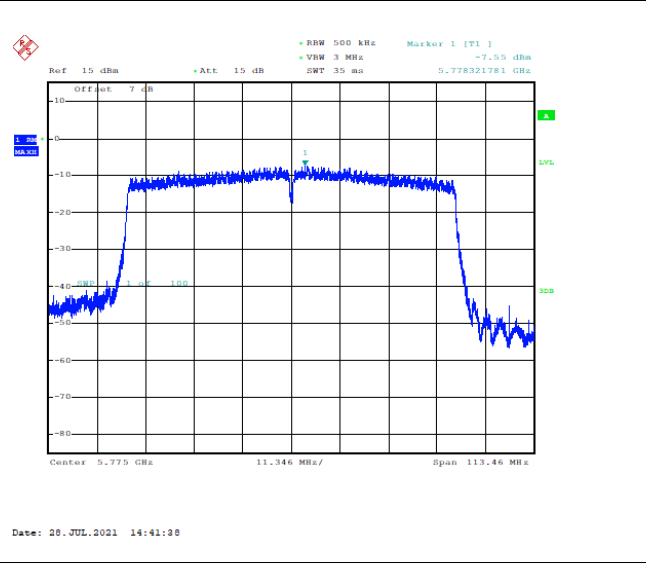
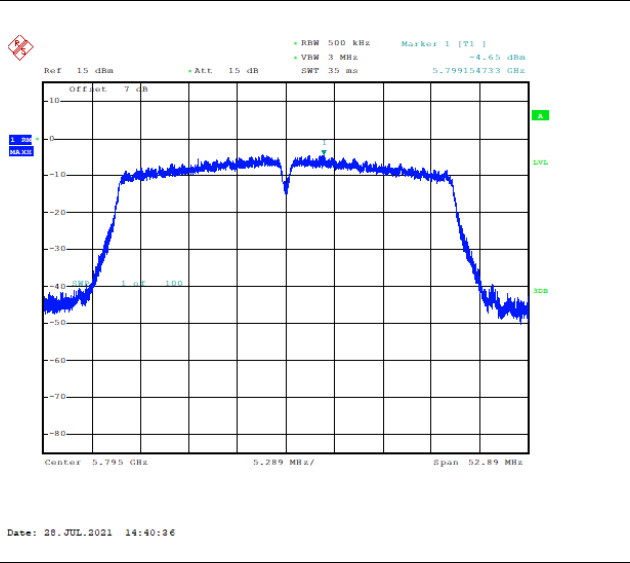



### 6.3. 6dB Occupied Bandwidth

#### 6.3.1. Measurement Limit

##### Measurement Limit

Standard	Limit (kHz)
FCC 47 CFR Part 15.407 (e)	≥500
RSS-247 6.2.4.1	≥500

#### 6.3.2. The measurement is made according to KDB 789033

##### Measurement Result

Mode	Channel	Occupied 6dB Bandwidth (MHz)	Conclusion
802.11a	149	15.30	P
	157	15.22	P
	165	15.22	P
802.11n HT20	149	15.22	P
	157	15.22	P
	165	15.22	P
802.11n HT40	151	35.42	P
	159	35.26	P
802.11ac HT20	149	15.22	P
	157	15.22	P
	165	15.22	P
802.11ac HT40	151	35.42	P
	159	35.26	P
802.11ac HT80	155	75.64	P

#### 6.3.3 Test Setup

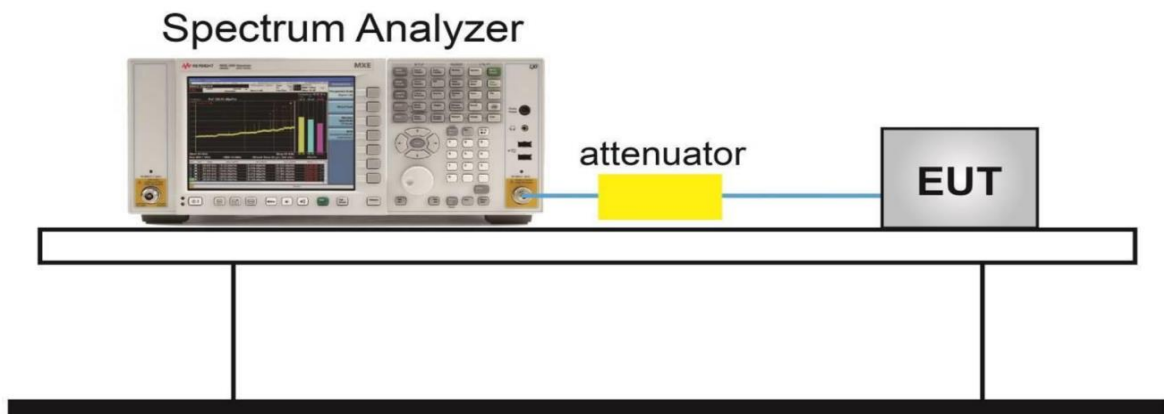

Test graphs as below

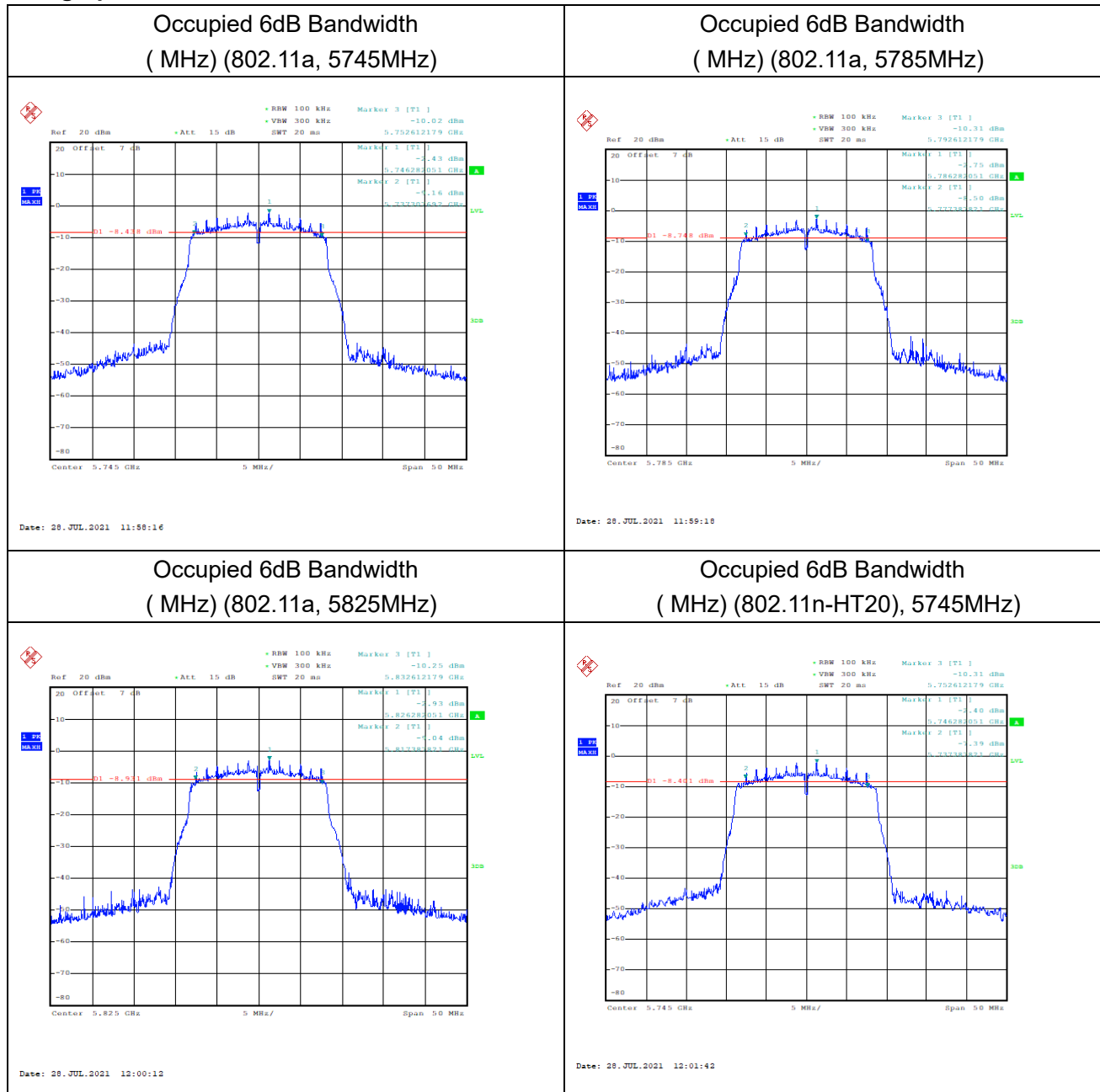

Occupied 6dB Bandwidth  
( MHz) (802.11n-HT20, 5785MHz)

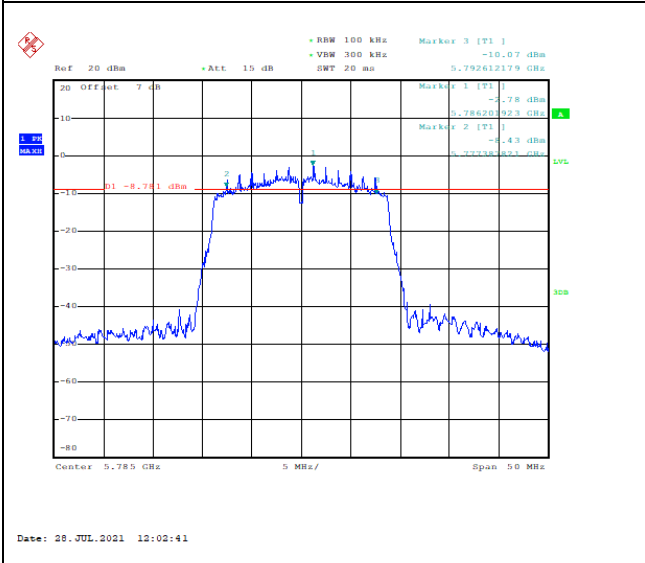

Occupied 6dB Bandwidth  
( MHz) (802.11n-HT20), 5825MHz)

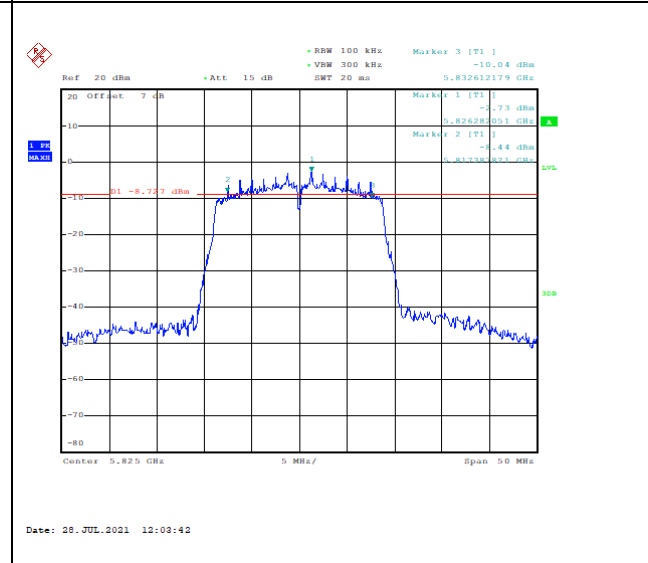

Occupied 6dB Bandwidth  
( MHz) (802.11n-HT40, 5755MHz)

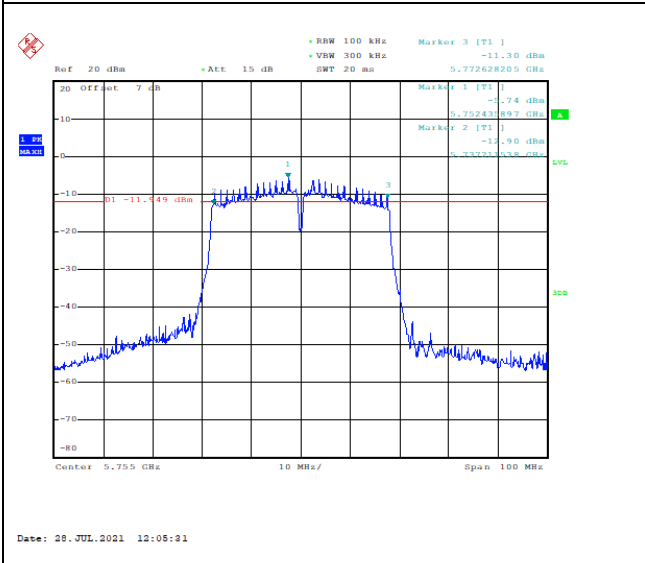

Occupied 6dB Bandwidth  
( MHz) (802.11n-HT40), 5795MHz)

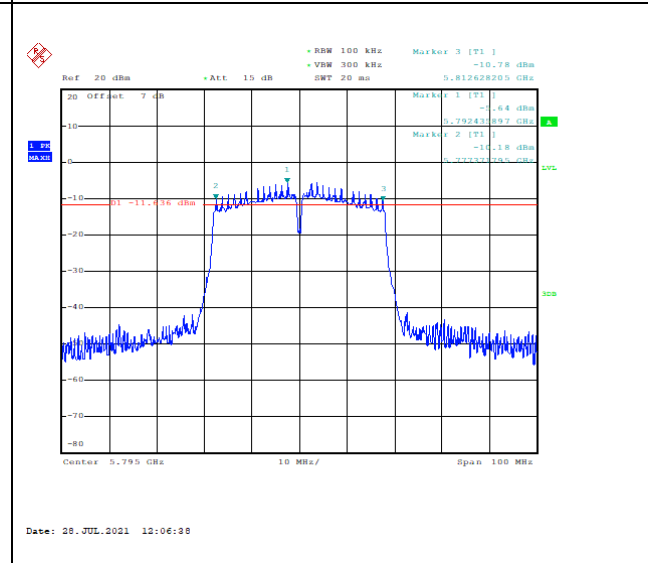

Occupied 6dB Bandwidth  
( MHz) (802.11ac-VHT20, 5745MHz)

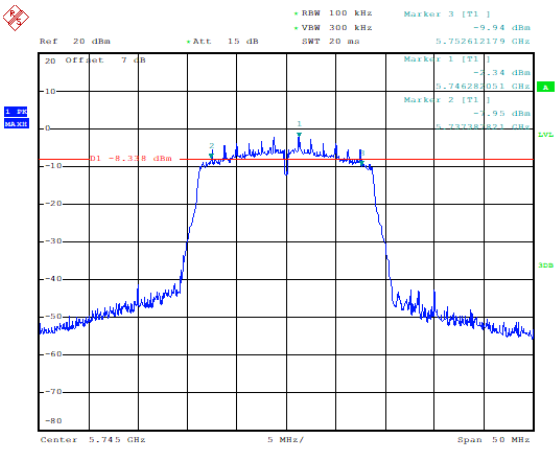

Date: 28 JUL 2021 12:07:54

Occupied 6dB Bandwidth  
( MHz) (802.11ac-VHT20, 5785MHz)

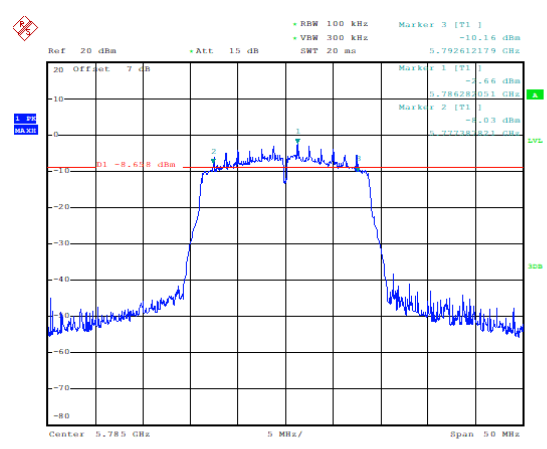

Date: 28 JUL 2021 12:08:48

Occupied 6dB Bandwidth  
( MHz) (802.11ac-VHT20, 5825MHz)

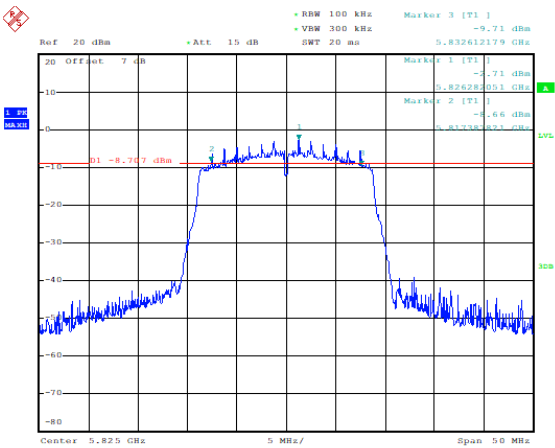

Date: 28 JUL 2021 12:09:39

Occupied 6dB Bandwidth  
( MHz) (802.11ac-VHT40, 5775MHz)

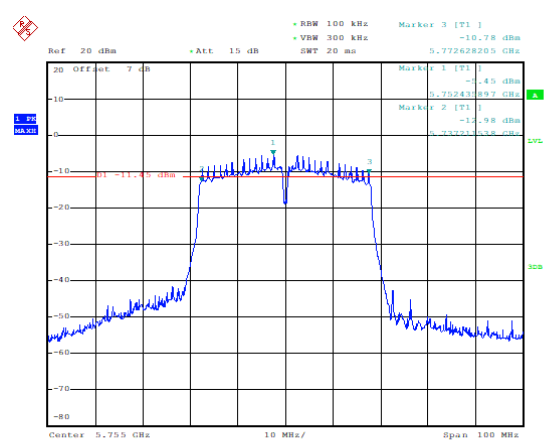

Date: 28 JUL 2021 12:10:56

Occupied 6dB Bandwidth  
( MHz) (802.11ac-VHT40), 5795MHz)

Occupied 6dB Bandwidth  
( MHz) (802.11ac-VHT80), 5775MHz)

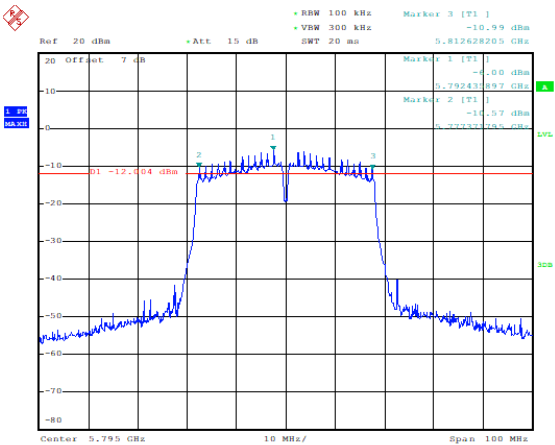

Date: 28\_JUL\_2021 12:12:28

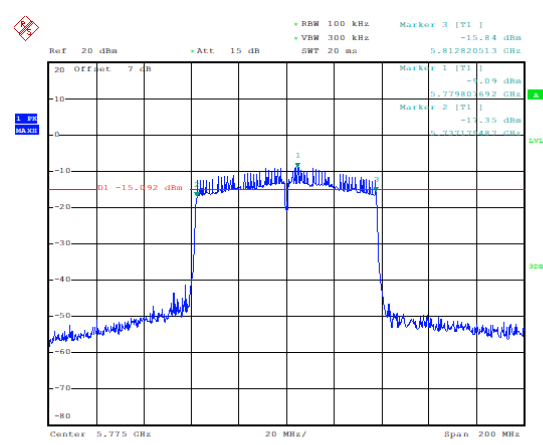

Date: 28\_JUL\_2021 12:18:51

## 6.4. 99% Occupied Bandwidth

### 6.4.1. Measurement Limit

#### Measurement Limit

Standard	Limit (kHz)
RSS-GEN 6.7	N/A

### 6.4.2. The measurement is made according to KDB 789033

### 6.4.3 Test Setup

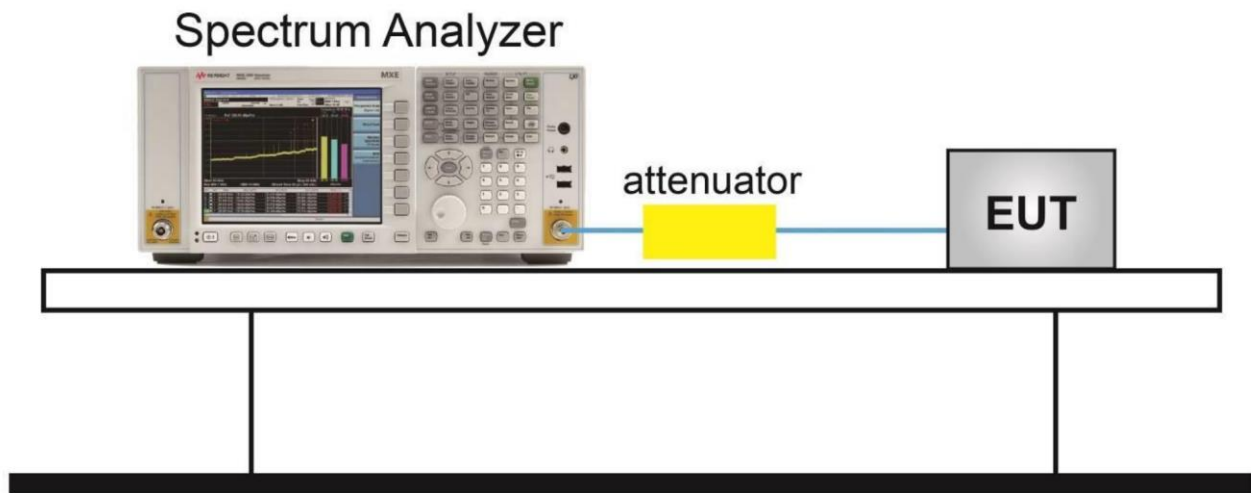

### Measurement Result

Mode	Channel	99% Occupied Bandwidth (MHz)	Conclusion
802.11a	149	16.907	P
	157	16.827	P
	165	16.827	P
802.11n HT20	149	17.788	P
	157	17.788	P
	165	17.788	P
802.11n HT40	151	36.218	P
	159	36.218	P
802.11ac HT20	149	17.788	P
	157	17.788	P
	165	17.788	P
802.11ac HT40	151	36.218	P
	159	36.218	P
802.11ac HT80	155	75.641	P

Test graphs as below

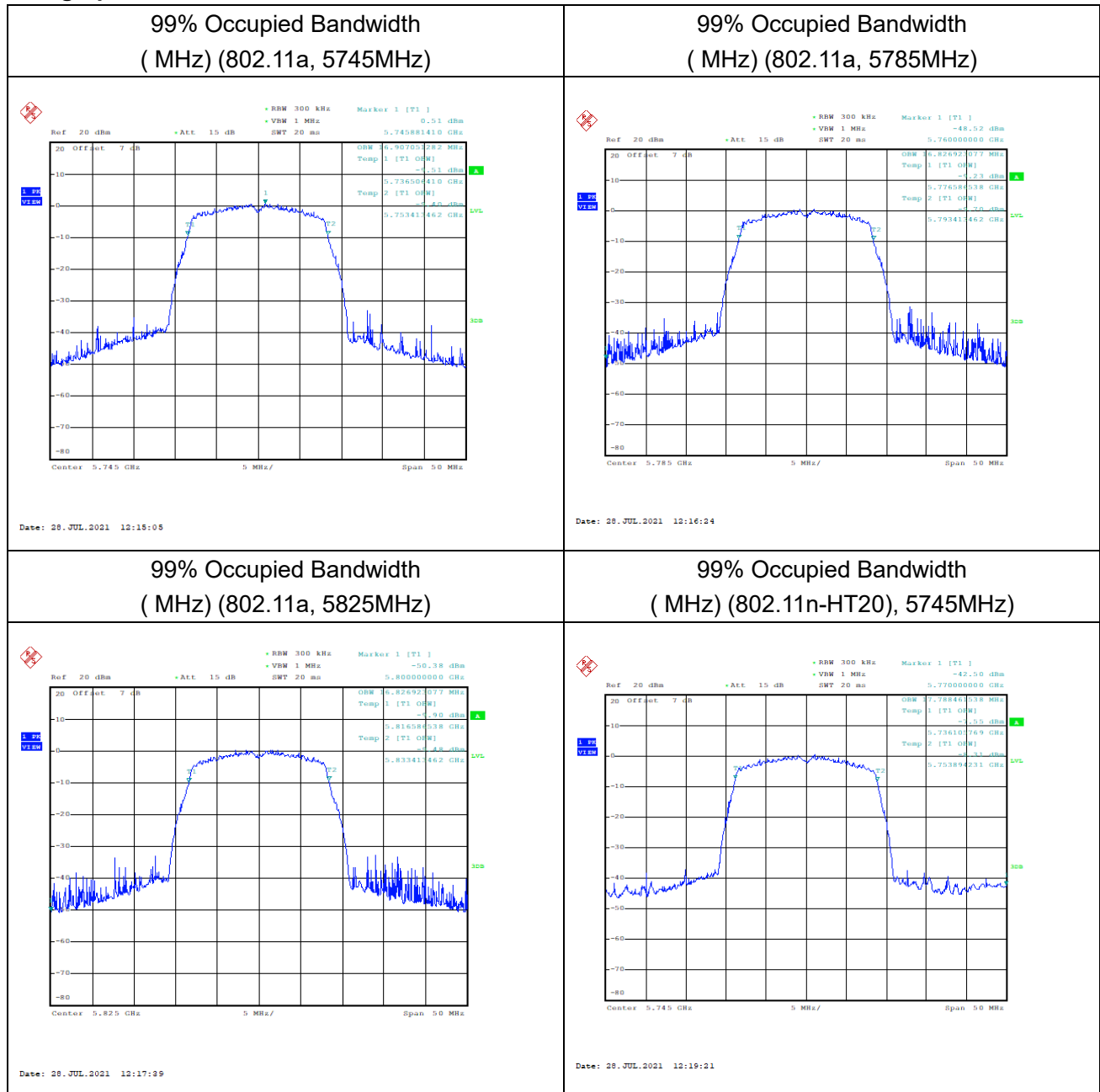

99% Occupied Bandwidth  
( MHz) (802.11n-HT20, 5785MHz)

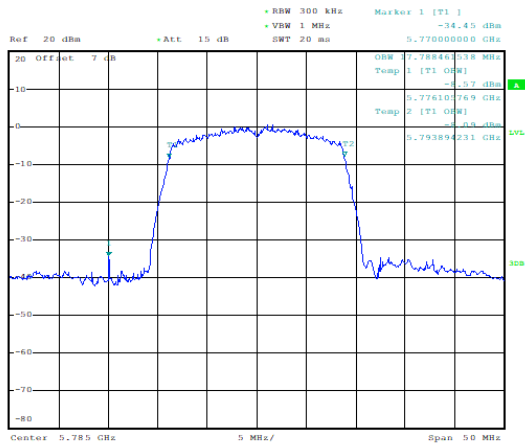

Date: 28 JUL 2021 12:20:28

99% Occupied Bandwidth  
( MHz) (802.11n-HT20, 5825MHz)

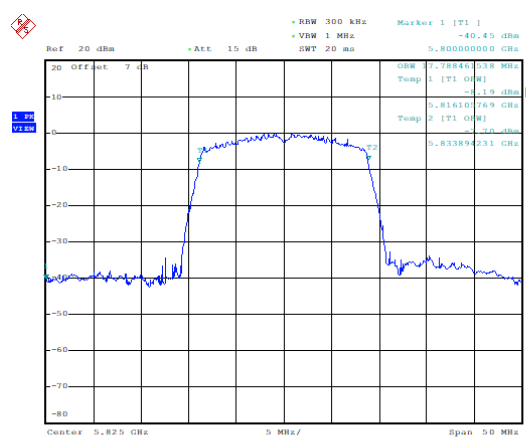

Date: 28 JUL 2021 12:22:06

99% Occupied Bandwidth  
( MHz) (802.11n-HT40, 5755MHz)

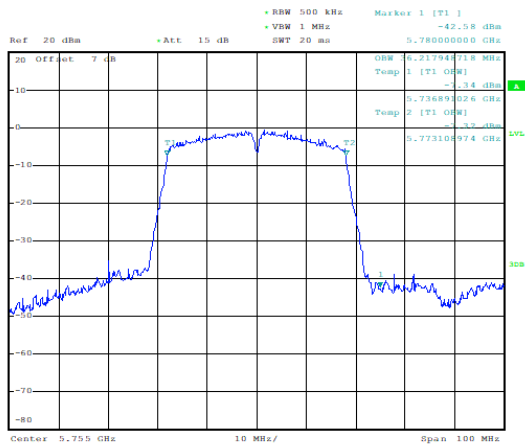

Date: 28 JUL 2021 12:23:27

99% Occupied Bandwidth  
( MHz) (802.11n-HT40, 5795MHz)

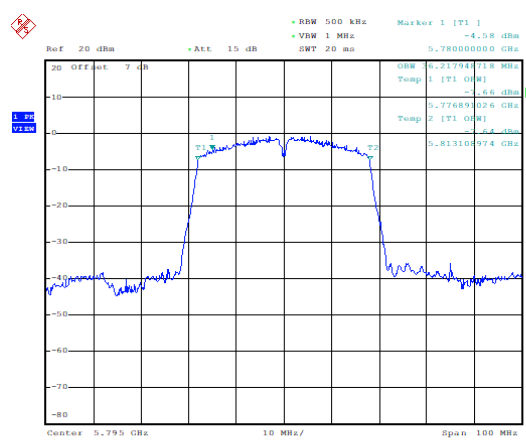

Date: 28 JUL 2021 12:24:49



99% Occupied Bandwidth  
( MHz) (802.11ac-VHT20, 5745MHz)

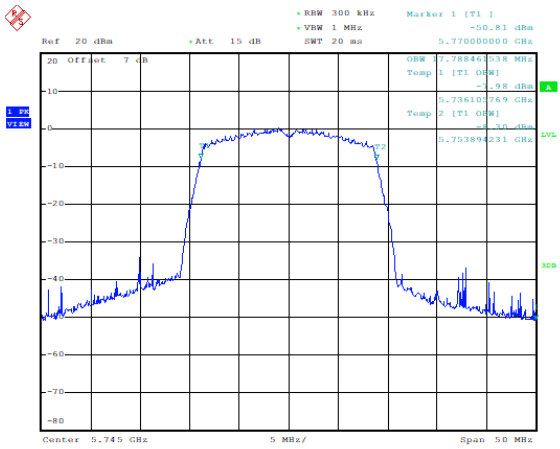

Date: 28 JUL 2021 12:26:10

99% Occupied Bandwidth  
( MHz) (802.11ac-VHT20, 5785MHz)

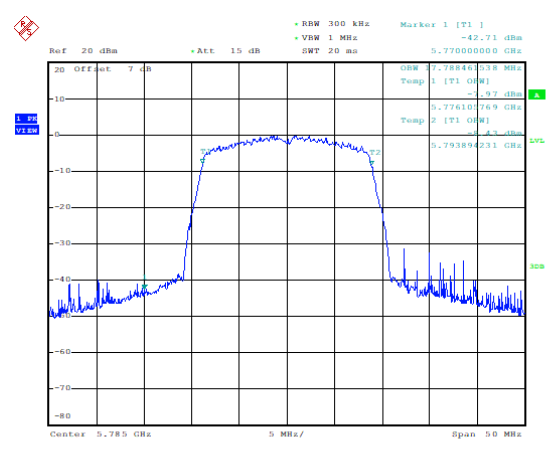

Date: 28 JUL 2021 12:28:00

99% Occupied Bandwidth  
( MHz) (802.11ac-VHT20, 5825MHz)

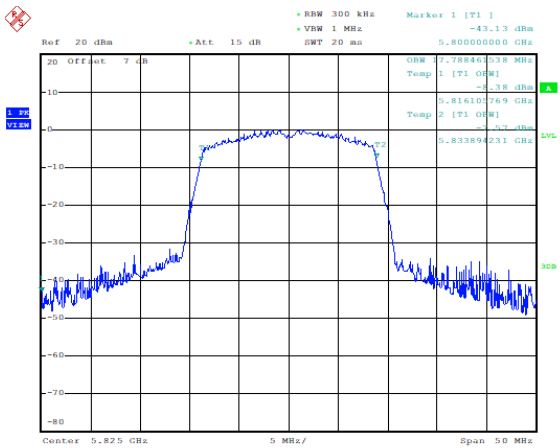

Date: 28 JUL 2021 13:59:47

99% Occupied Bandwidth  
( MHz) (802.11ac-VHT40), 5775MHz)

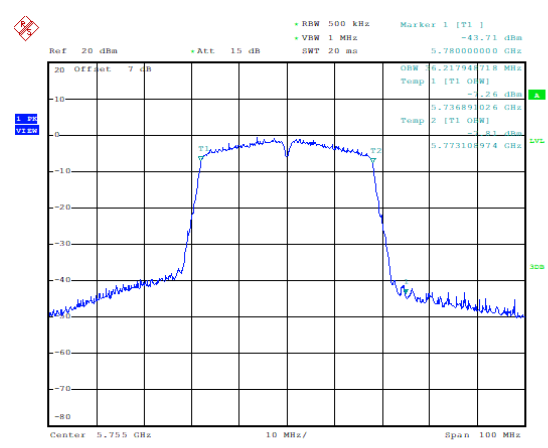

Date: 28 JUL 2021 14:01:54

99% Occupied Bandwidth  
( MHz) (802.11ac-VHT40), 5795MHz)

99% Occupied Bandwidth  
( MHz) (802.11ac-VHT80), 5775MHz)

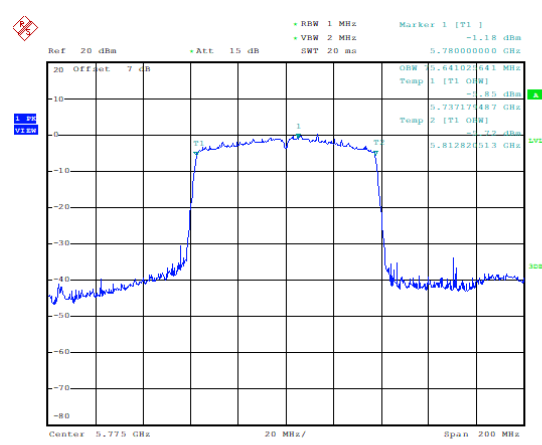
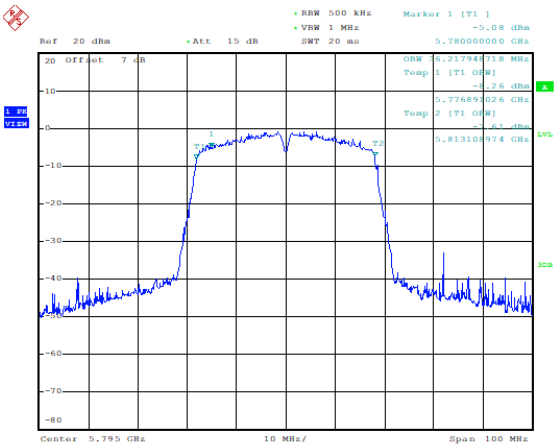

Date: 28\_JUL.2021 14:02:27

Date: 28\_JUL.2021 14:06:00

## 6.5. Frequency Stability

Manufacturers ensured the EUT meet the requirement of frequency stability, such that an emission is maintained within the band of operation under all conditions of normal operation as specified in the user's manual.

## 6.6. Transmitter Spurious Emission

### Measurement Limit

Standard	Limit
FCC 47 Part 15.407, 15.205, 15.209	< -27
RSS-247 6.2.4.2 RSS-Gen 8.9, 8.10	< -27

### The measurement is made according to ANSI C63.10.

Frequency of emission (MHz)	Field strength(uV/m)	Field strength(dBuV/m)
0.009-0.490	2400/F(kHz)	/
0.490-1.705	24000/F(kHz)	/
1.705-30	30	/
30-88	100	40
88-216	150	43.5
216-960	200	46
Above 960	500	54

### 6.6.1. Transmitter Spurious Emission – Conducted

Modulation type and data rate tested (Only worst case result is given below):

Mode	Data rate	Channel
802.11a	6Mbps	149
802.11n-HT20	6Mbps	149
802.11n-HT40	MCS0	151
802.11ac-HT20	6Mbps	149
802.11ac-HT40	MCS0	151
802.11ac-HT80	MCS0	155

### Measurement Results

MODE	Channel	Frequency Range	Conclusion
802.11a	149(5745MHz)	30 MHz ~ 1 GHz	P
		1 GHz ~ 5.7 GHz	P
		5.7 GHz ~ 40 GHz	P
802.11n-HT20	149	30 MHz ~ 1 GHz	P
		1 GHz ~ 5.7 GHz	P
		5.7 GHz ~ 40 GHz	P
802.11n-HT40	151(5755MHz)	30 MHz ~ 1 GHz	P
		1 GHz ~ 5.7 GHz	P
		5.7 GHz ~ 40 GHz	P
802.11ac-HT20	149	30 MHz ~ 1 GHz	P
		1 GHz ~ 5.7 GHz	P
		5.7 GHz ~ 40 GHz	P
802.11ac-HT40	151(5755MHz)	30 MHz ~ 1 GHz	P
		1 GHz ~ 5.7 GHz	P
		5.7 GHz ~ 40 GHz	P
802.11ac-HT80	155(5775MHz)	30 MHz ~ 1 GHz	P
		1 GHz ~ 5.7 GHz	P
		5.7 GHz ~ 40 GHz	P

### Test Setup

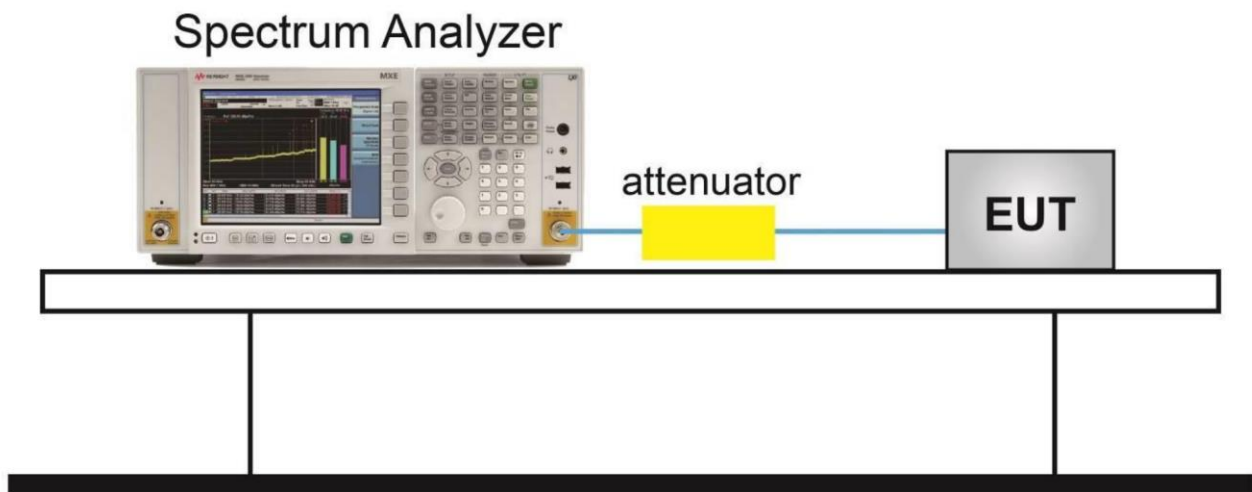

Test graphs as below

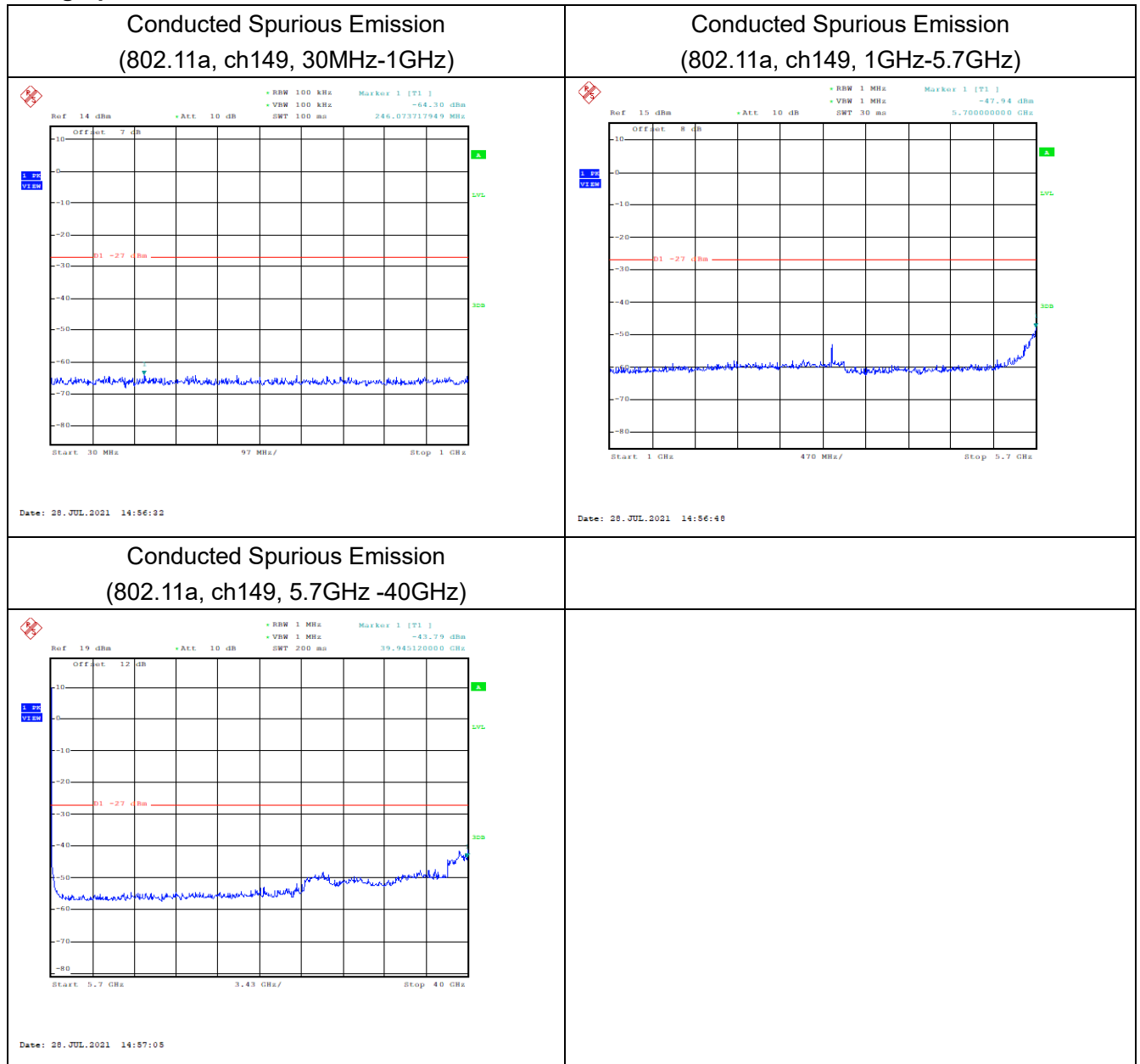

Conducted Spurious Emission  
(802.11n-HT20, ch149, 30MHz-1GHz)

Conducted Spurious Emission  
(802.11n-HT20, ch149, 1GHz-5.7GHz)

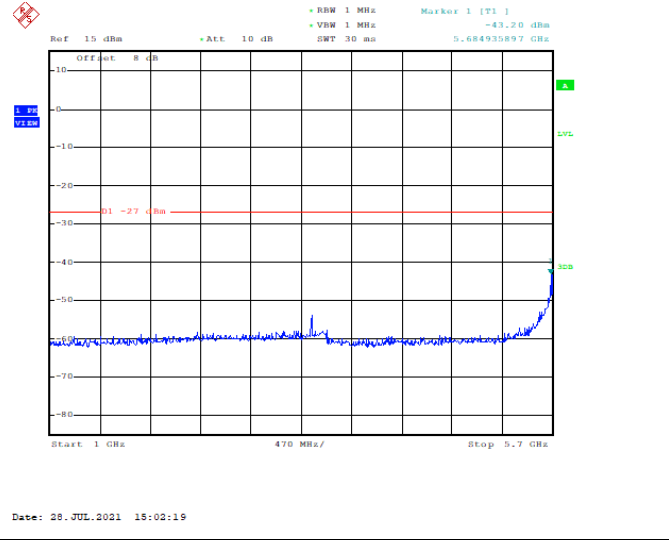
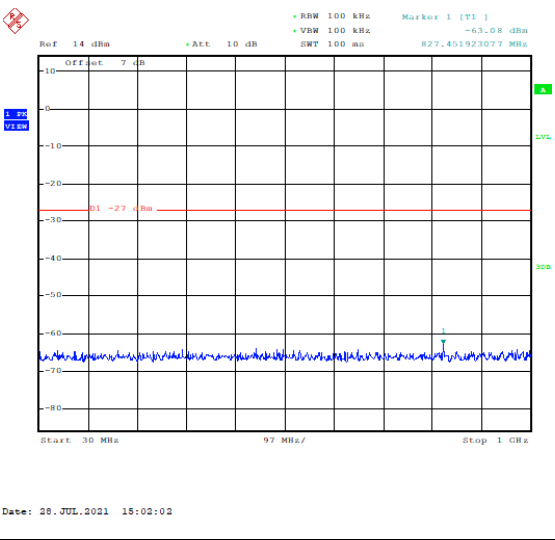

Conducted Spurious Emission  
(802.11n-HT20, ch149, 5.7GHz -40GHz)

/

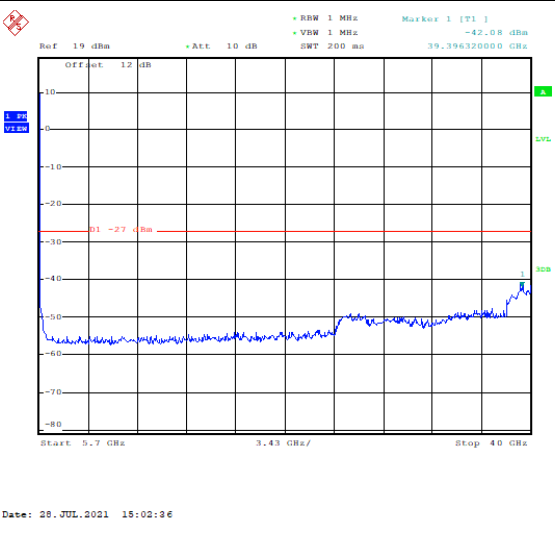

/

**Conducted Spurious Emission  
(802.11n-HT40, ch151, 30MHz-1GHz)**

**Conducted Spurious Emission  
(802.11n-HT40, ch151, 1GHz-5.7GHz)**

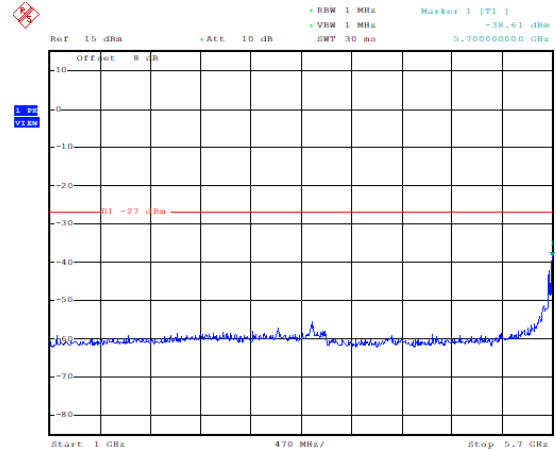
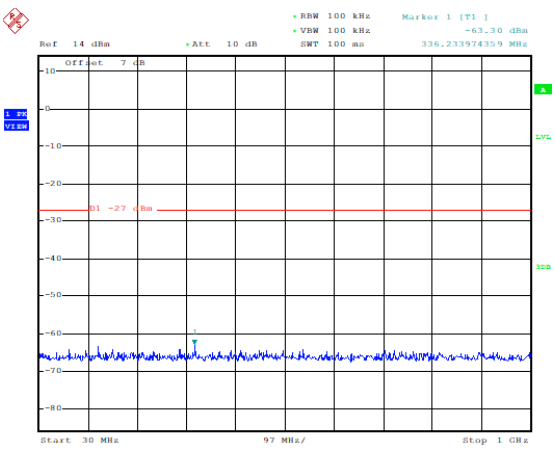

Date: 28.JUL.2021 15:07:49

Date: 28.JUL.2021 15:08:00

**Conducted Spurious Emission  
(802.11n-HT40, ch151, 5.7GHz -40GHz)**

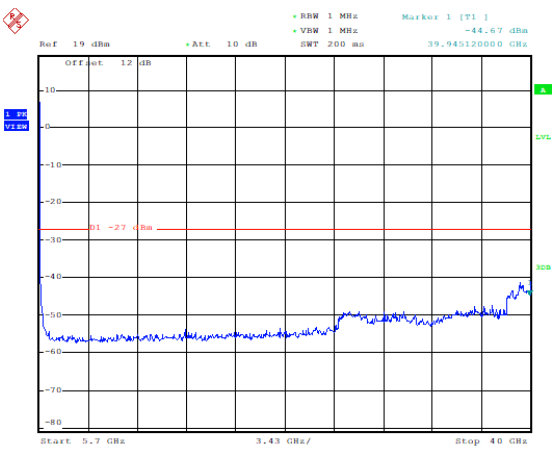

Date: 28.JUL.2021 15:08:16

Conducted Spurious Emission  
(802.11ac-VHT20, ch149, 30MHz-1GHz)

Conducted Spurious Emission  
(802.11ac-VHT20, ch149, 1GHz-5.7GHz)

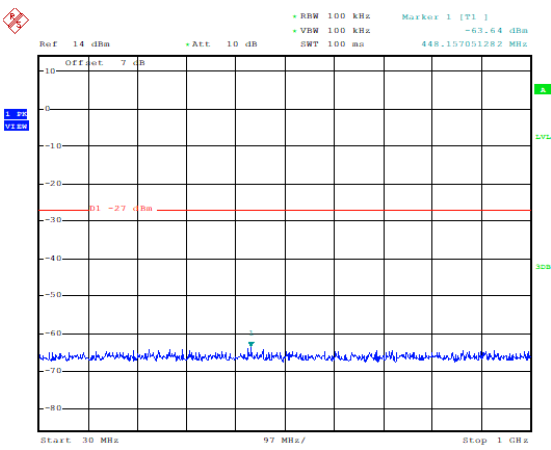

Date: 28.JUL.2021 15:11:06

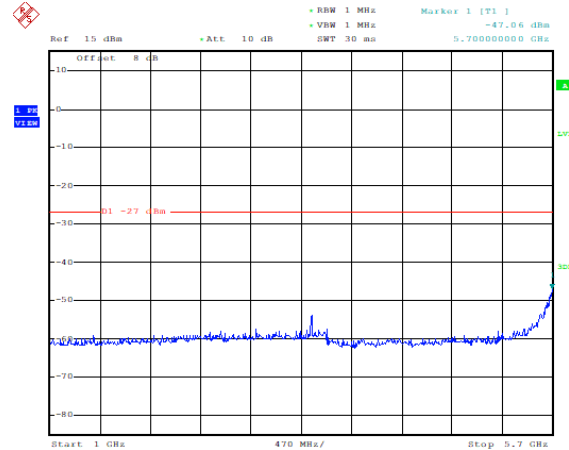

Date: 28.JUL.2021 15:11:23

Conducted Spurious Emission  
(802.11ac-VHT20, ch149, 5.7GHz -40GHz)

/

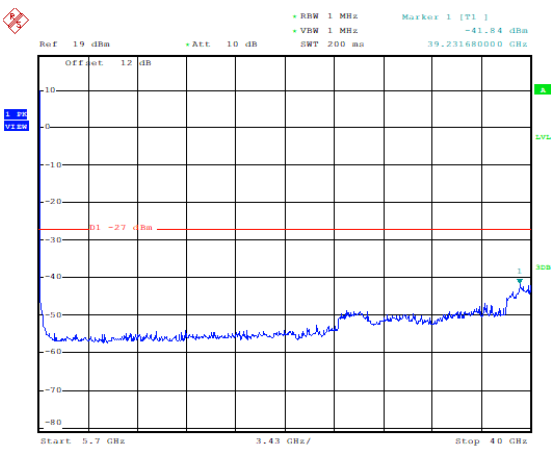

Date: 28.JUL.2021 15:11:40

/



### Conducted Spurious Emission (802.11ac-VHT40, ch151, 30MHz-1GHz)

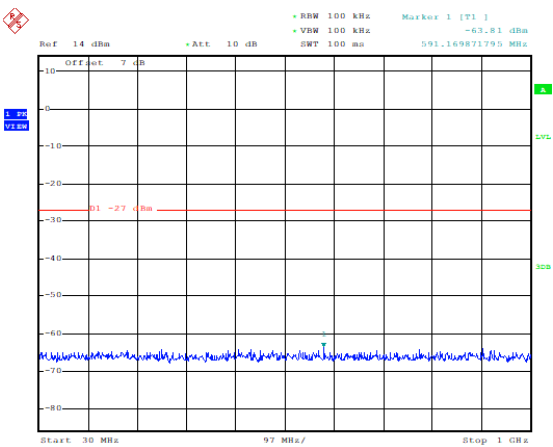

Date: 28.JUL.2021 15:28:46

### Conducted Spurious Emission (802.11ac-VHT40, ch151, 1GHz-5.7GHz)

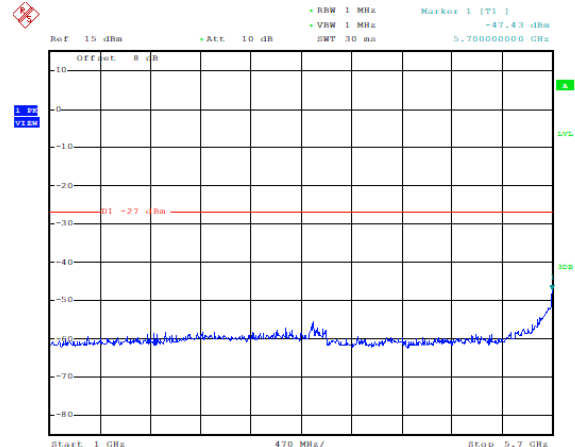

Date: 28.JUL.2021 15:29:02

### Conducted Spurious Emission (802.11ac-VHT40, ch151, 5.7GHz -40GHz)

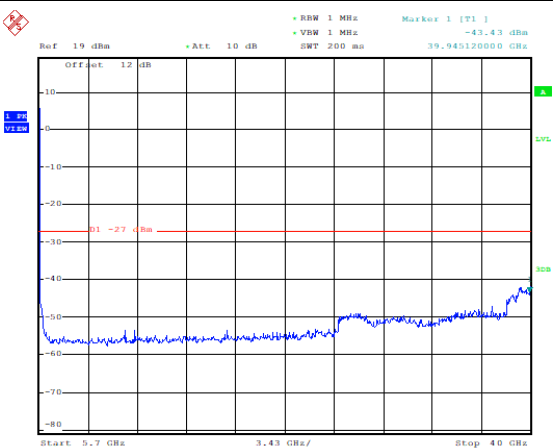

Date: 28.JUL.2021 15:29:19

**Conducted Spurious Emission  
(802.11ac-VHT80, ch155, 30MHz-1GHz)**

**Conducted Spurious Emission  
(802.11ac-VHT80, ch155, 1GHz-5.7GHz)**

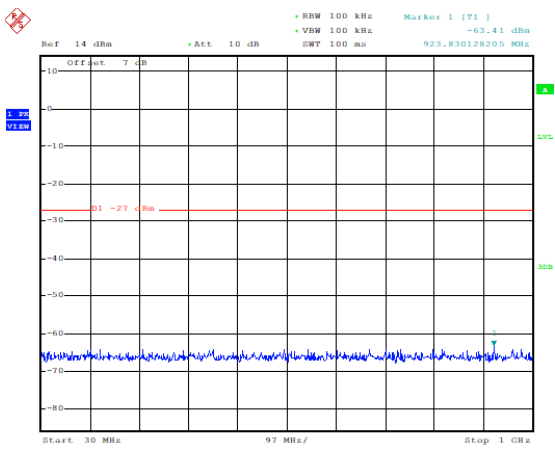

Date: 28.JUL.2021 15:32:22

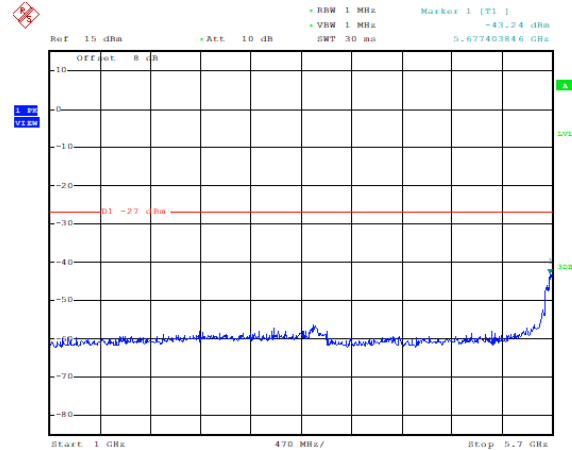

Date: 28.JUL.2021 15:32:38

**Conducted Spurious Emission  
(802.11ac-VHT80, ch155, 5.7GHz -40GHz)**

/

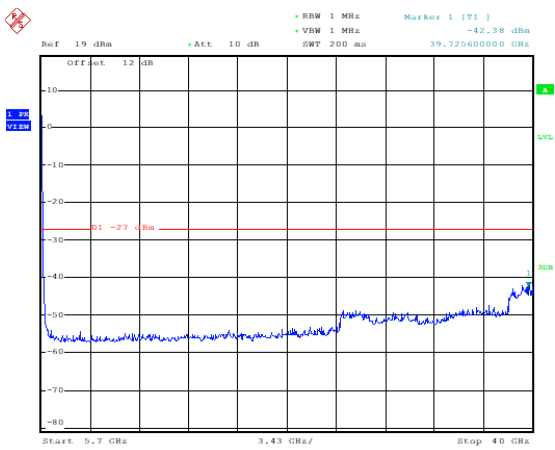

Date: 28.JUL.2021 15:32:54

/



### 6.6.2. Transmitter Spurious Emission - Radiated

Modulation type and data rate tested (Only worst case result is given below):

<b>Mainly Supply</b>		
<b>Mode</b>	<b>Data rate</b>	<b>Channel</b>
802.11a	6Mbps	157(5785MHz)
802.11n-HT20	MCS0	157(5785MHz)
802.11n-HT40	MCS0	159(5795MHz)
802.11ac-HT20	MCS0	157(5785MHz)
802.11ac-HT40	MCS0	151(5755MHz)
802.11ac-HT80	MCS0	155(5775MHz)

**Measurement Results**

<b>Mainly Supply</b>			
<b>Mode</b>	<b>Channel</b>	<b>Frequency Range</b>	<b>Conclusion</b>
802.11a	157(5785MHz)	30 MHz ~1 GHz	P
		1 GHz ~ 8 GHz	P
		8 GHz ~ 18 GHz	P
		18 GHz ~ 26.5 GHz	P
		26.5 GHz~ 40 GHz	P
802.11n-HT20	157(5785MHz)	30 MHz ~1 GHz	P
		1 GHz ~ 8 GHz	P
		8 GHz ~ 18 GHz	P
		18 GHz ~ 26.5 GHz	P
		26.5 GHz~ 40 GHz	P
802.11n-HT40	159(5795MHz)	30 MHz ~1 GHz	P
		1 GHz ~ 8 GHz	P
		8 GHz ~ 18 GHz	P
		18 GHz ~ 26.5 GHz	P
		26.5 GHz~ 40 GHz	P
802.11ac-HT20	157(5785MHz)	30 MHz ~1 GHz	P
		1 GHz ~ 8 GHz	P
		8 GHz ~ 18 GHz	P
		18 GHz ~ 26.5 GHz	P
		26.5 GHz~ 40 GHz	P
802.11ac-HT40	151(5755MHz)	30 MHz ~1 GHz	P
		1 GHz ~ 8 GHz	P
		8 GHz ~ 18 GHz	P
		18 GHz ~ 26.5 GHz	P
		26.5 GHz~ 40 GHz	P
802.11ac-HT80	155(5775MHz)	30 MHz ~1 GHz	P
		1 GHz ~ 8 GHz	P
		8 GHz ~ 18 GHz	P
		18 GHz ~ 26.5 GHz	P
		26.5 GHz~ 40 GHz	P

### Test Setup

#### Below 1GHz Test Setup

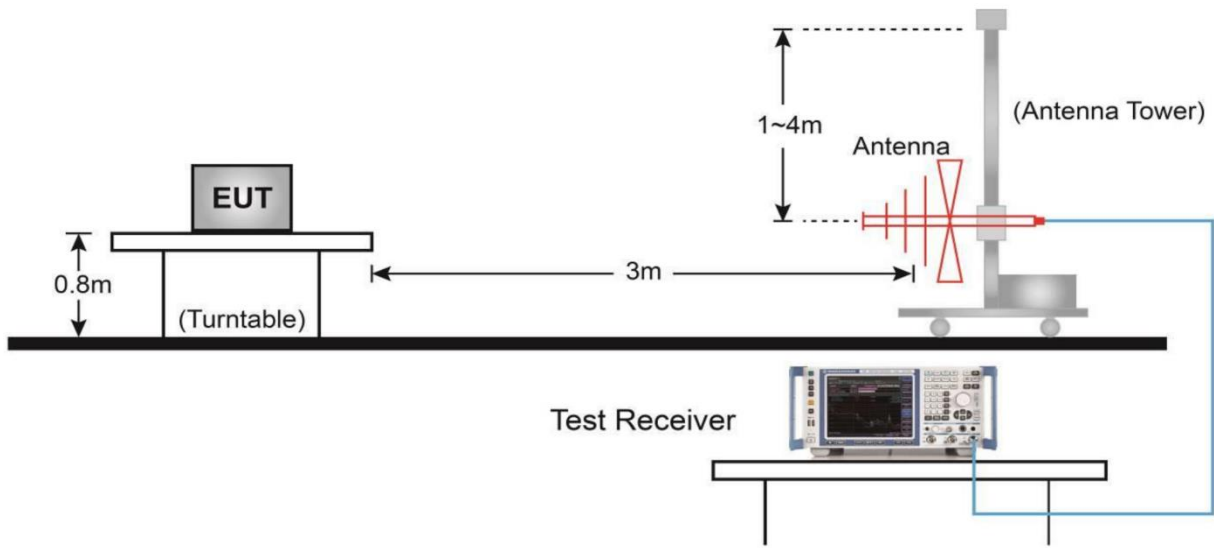

#### Above 1GHz Test Setup

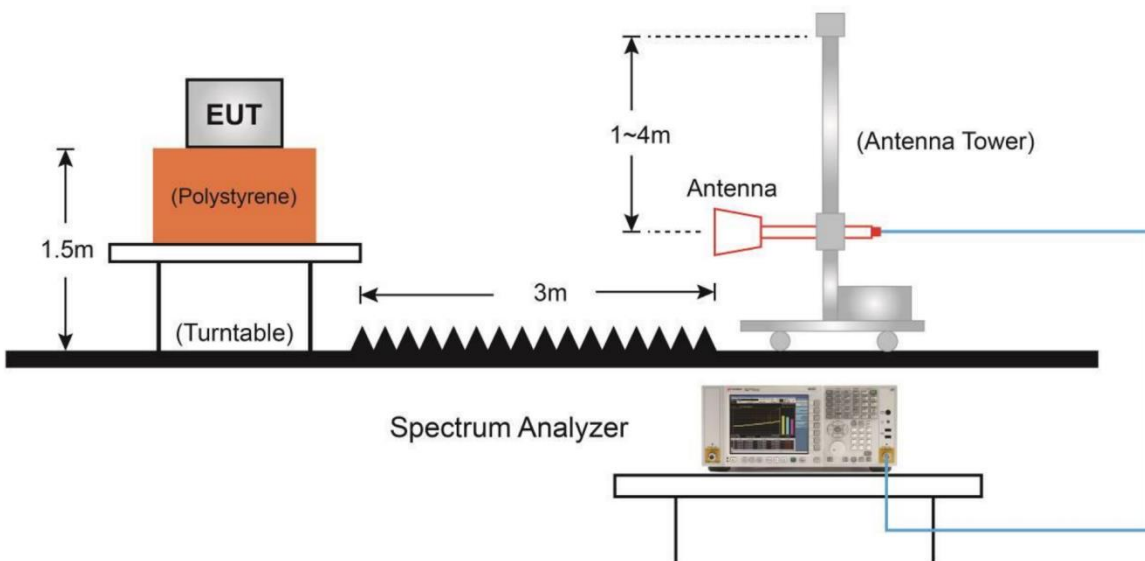

Test graphs as below

Mainly Supply

<p style="text-align: center;"><b>Radiated Spurious Emission (802.11a, ch157, 30MHz-1GHz)</b></p>	<p style="text-align: center;"><b>Radiated Spurious Emission (802.11a, ch157, 1GHz-8GHz)</b></p>
<p style="text-align: center;"><b>Radiated Spurious Emission (802.11a, ch157, 8GHz-18GHz)</b></p>	<p style="text-align: center;"><b>Radiated Spurious Emission (802.11n, ch157, 18GHz-26.5GHz)</b></p>
<p style="text-align: center;"><b>Radiated Spurious Emission (802.11a, ch157, 26.5 GHz-40 GHz)</b></p>	<p style="text-align: center;">/</p>
	<p style="text-align: center;">/</p>

Radiated Spurious Emission  
(802.11n-HT20, ch157, 30MHz-1GHz)

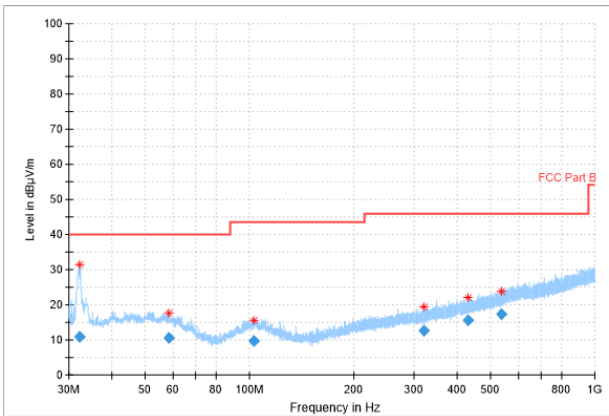

Radiated Spurious Emission  
(802.11n-HT20, ch157, 1GHz-8GHz)

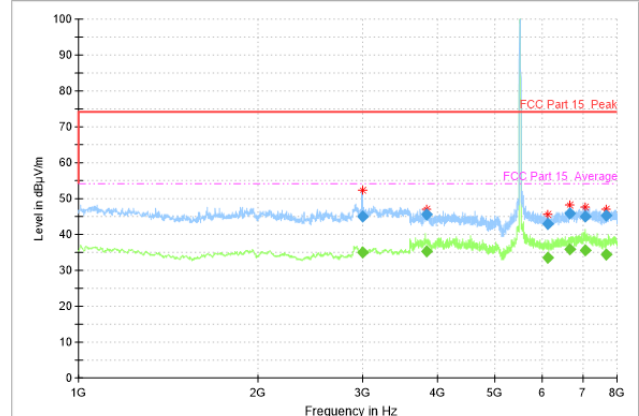

Radiated Spurious Emission  
(802.11n-HT20, ch157, 8GHz-18GHz)

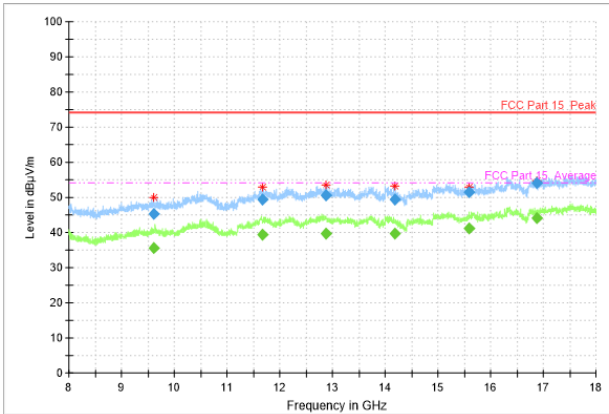

Radiated Spurious Emission  
(802.11n-HT20, ch157, 18GHz-26.5GHz)

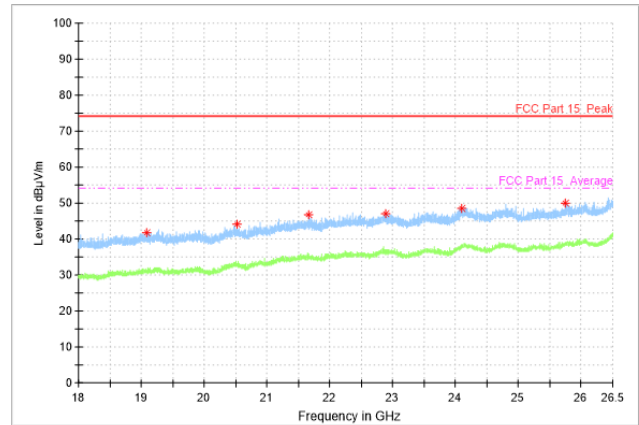

Radiated Spurious Emission  
(802.11n-HT20, ch157, 26.5GHz-40GHz)

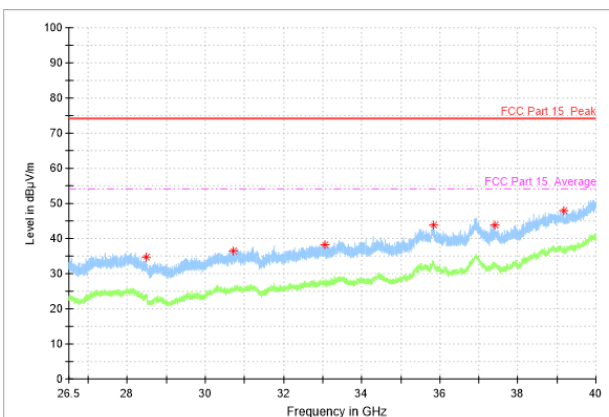

/

/

Radiated Spurious Emission  
(802.11n-HT40, ch159, 30MHz-1GHz)

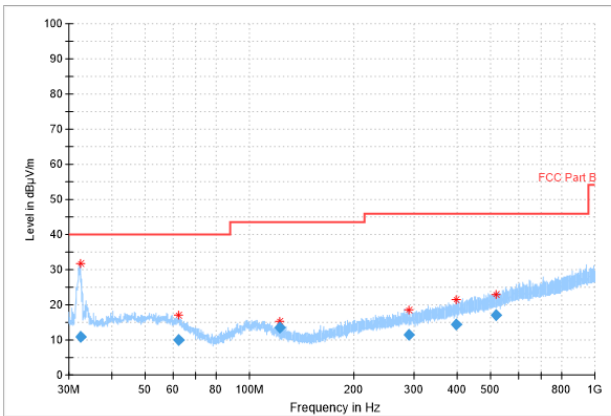

Radiated Spurious Emission  
(802.11n-HT40, ch159, 1GHz-8GHz)

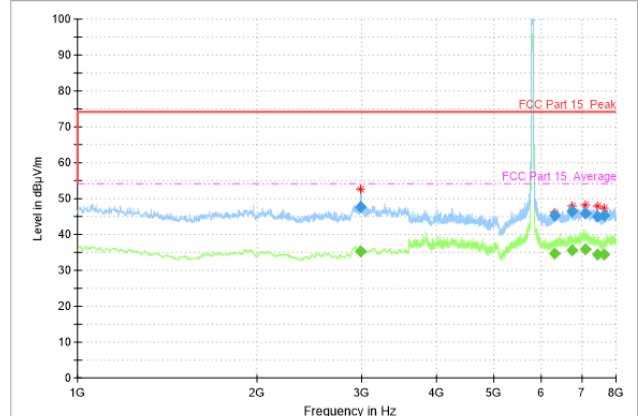

Radiated Spurious Emission  
(802.11n-HT40, ch159, 8GHz-18GHz)

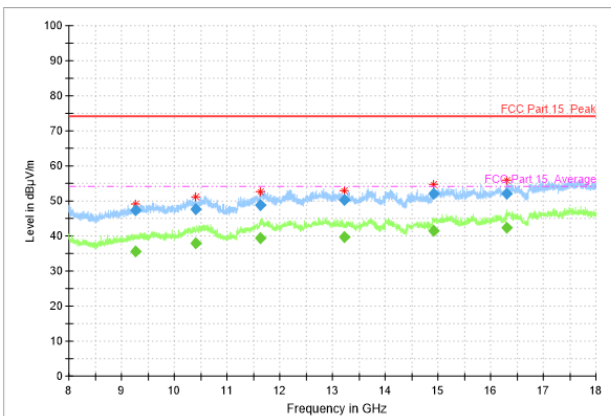

Radiated Spurious Emission  
(802.11n-HT40, ch159, 18GHz-26.5GHz)

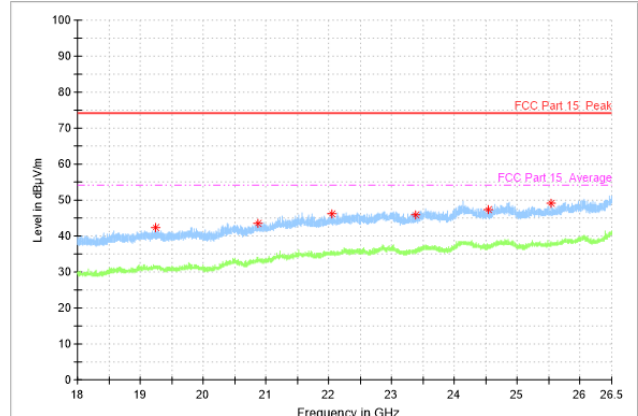

Radiated Spurious Emission  
(802.11n-HT20, ch157, 26.5GHz-40GHz)

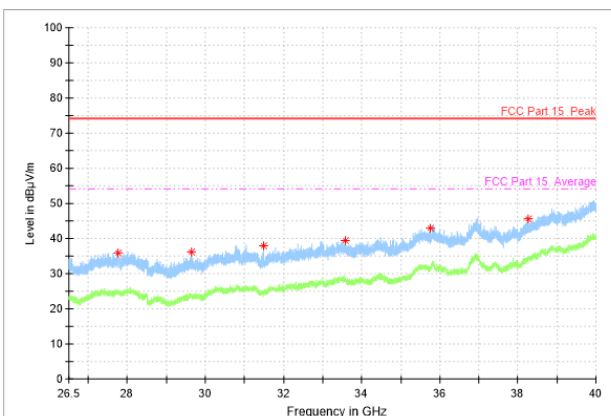

/

/



Radiated Spurious Emission  
(802.11ac-VHT20, ch157, 30MHz-1GHz)

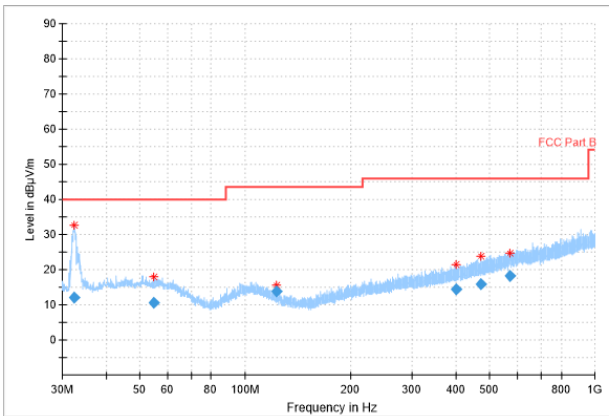

Radiated Spurious Emission  
(802.11ac-VHT20, ch157, 1GHz-8GHz)

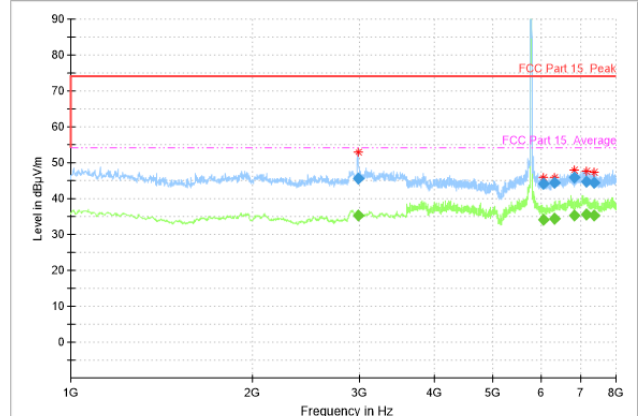

Radiated Spurious Emission  
(802.11ac-VHT20, ch157, 8GHz-18GHz)

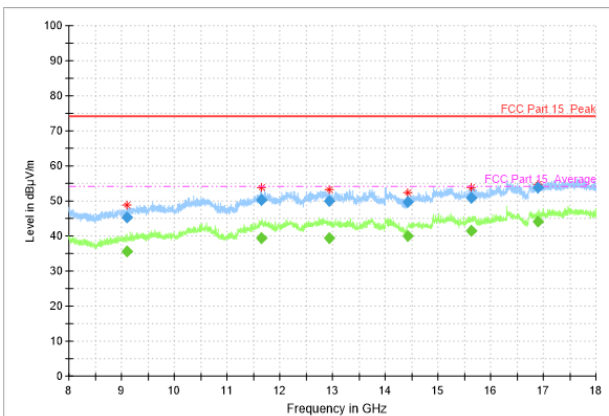

Radiated Spurious Emission  
(802.11ac-VHT20, ch157, 18GHz-26.5GHz)

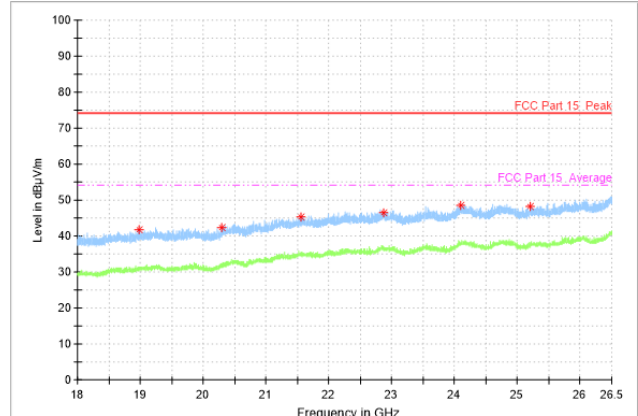

Radiated Spurious Emission  
(802.11ac-VHT20, ch157, 26.5GHz-40GHz)

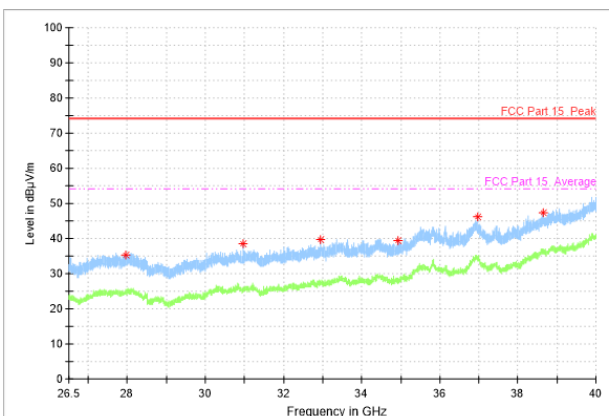

/

/

Radiated Spurious Emission  
(802.11ac-VHT40, ch151, 30MHz-1GHz)

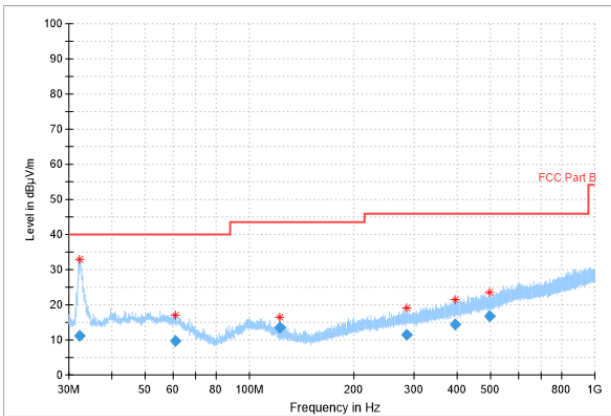

Radiated Spurious Emission  
(802.11ac-VHT40, ch151, 1GHz-8GHz)

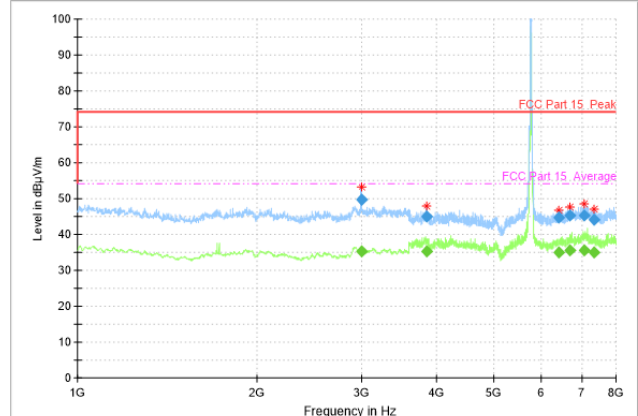

Radiated Spurious Emission  
(802.11ac-VHT40, ch151, 8GHz-18GHz)

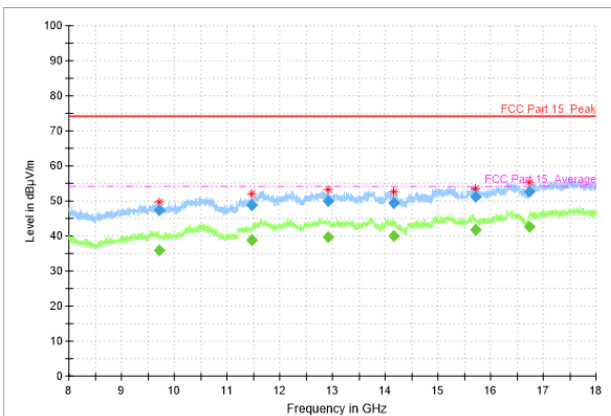

Radiated Spurious Emission  
(802.11ac-VHT40, ch151, 18GHz-26.5GHz)

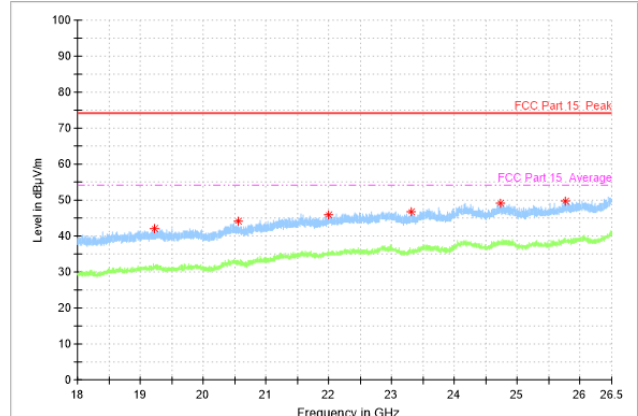

Radiated Spurious Emission  
(802.11ac-VHT40, ch151, 26.5GHz-40GHz)

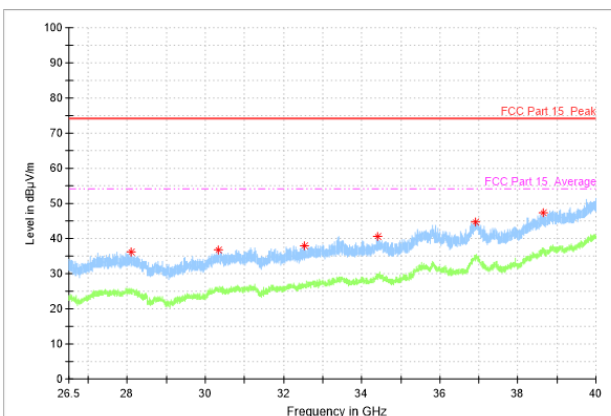

/

/

Radiated Spurious Emission  
(802.11ac-VHT80, ch155, 30MHz-1GHz)

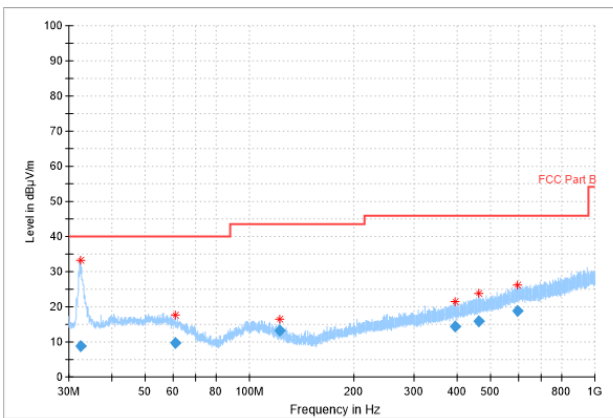

Radiated Spurious Emission  
(802.11ac-VHT80, ch155, 1GHz-8GHz)

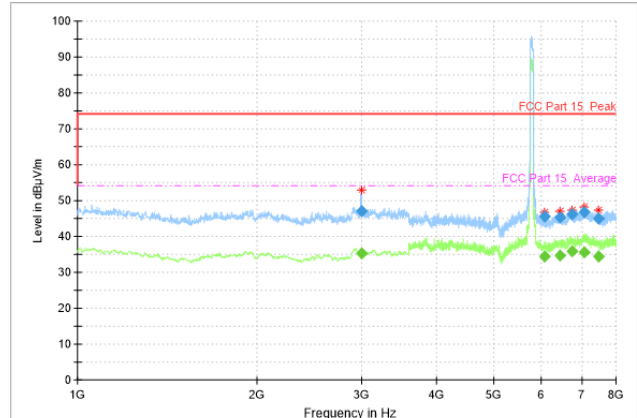

Radiated Spurious Emission  
(802.11ac-VHT80, ch155, 8GHz-18GHz)

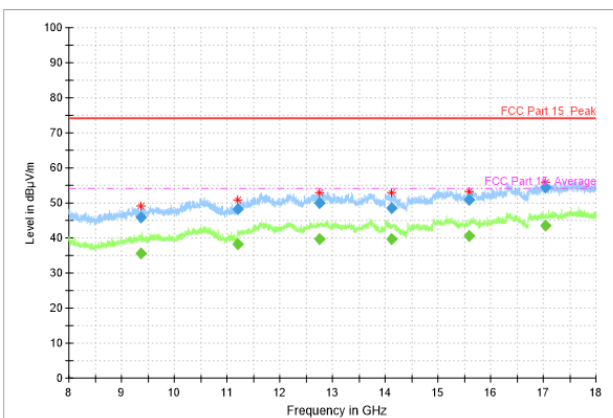

Radiated Spurious Emission  
(802.11ac-VHT80, ch155, 18GHz-26.5GHz)

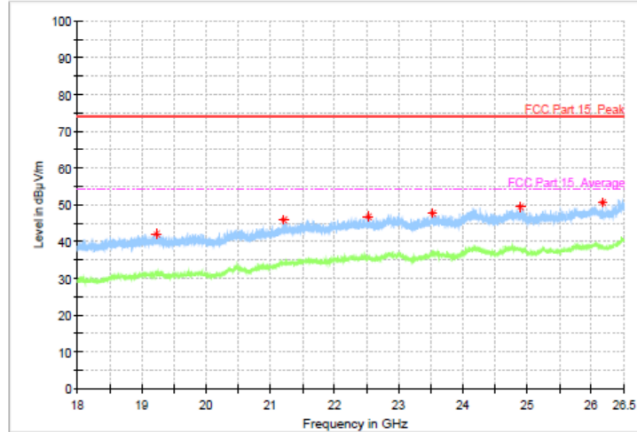

Radiated Spurious Emission  
(802.11ac-VHT80, ch155, 26.5GHz-40GHz)

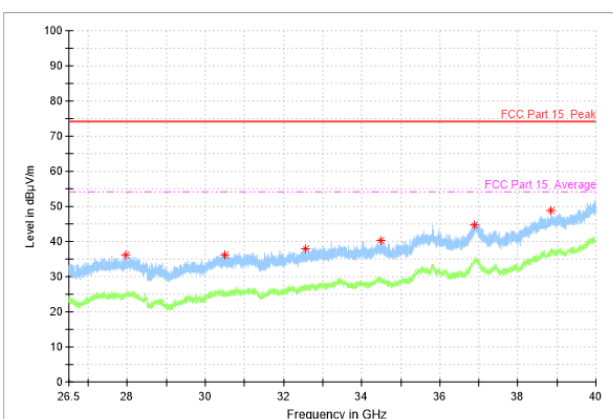

/

/



Mainly Supply

802.11a mode

Channel 157 (30MHz ~ 1GHz )

Frequency(MHz)	Result(dBuV/m)	ARpl(dB)	PMea(dBuV/m)	Polarity
32.2	11.37	-14.3	25.67	H
57.1	11.27	-12.2	23.47	H
109.0	9.6	-13.2	22.8	V
342.4	13.01	-9.5	22.51	V
475.0	16.11	-6.7	22.81	V
614.0	18.91	-3	21.91	H

Channel 157 (1GHz-8GHz )

Frequency(MHz)	Result(dBuV/m)	ARpl(dB)	PMea(dBuV/m)	Polarity
2993.8	44.95	1.8	43.15	H
4192.8	44.03	1	43.03	H
6317.6	46.92	3	43.92	H
6691.6	46.11	4	42.11	H
7058.0	46.58	4.4	42.18	H
7678.6	43.81	3.6	40.21	H

Channel 157 (8GHz-18GHz)

Frequency(MHz)	Result(dBuV/m)	ARpl(dB)	PMea(dBuV/m)	Polarity
9628.6	46.31	5.8	40.51	V
11782.6	50.34	10	40.34	H
13737.0	50.43	11.7	38.73	V
15242.6	52.55	14.2	38.35	H
16346.0	52.95	16.3	36.65	V
17550.8	54.68	17.7	36.98	H

Channel 157 (8GHz-18GHz) (Average)

Frequency(MHz)	Result(dBuV/m)	ARpl(dB)	PMea(dBuV/m)	Polarity
17550.8	43.3	17.7	25.6	H

Channel 157 (18GHz-25.6GHz)

Frequency(MHz)	Result(dBuV/m)	ARpl(dB)	PMea(dBuV/m)	Polarity
18946.9	41.64	-4.6	46.24	V
20297.6	42.8	-4.4	47.2	H
21542.8	45.72	-2.1	47.82	H
22966.6	47.34	-1.2	48.54	H
24198.2	48.72	0	48.72	H
25775.0	50.62	0.9	49.72	V

Channel 157 (25.6GHz-40GHz)

Frequency(MHz)	Result(dBuV/m)	ARpl(dB)	PMea(dBuV/m)	Polarity
28226.6	35.44	0.3	35.14	V
30789.0	37.09	-0.1	37.19	V



32988.1	39.33	4.1	35.23	V
35244.0	41.19	4.8	36.39	H
36992.2	45.3	8.2	37.1	H
38682.4	47.73	10.9	36.83	V

**802.11n-HT20 mode**

**Channel 157(30MHz ~ 1GHz )**

Frequency(MHz)	Result(dBuV/m)	ARpl(dB)	PMea(dBuV/m)	Polarity
32.2	10.87	-14.3	25.17	H
58.3	10.61	-12.2	22.81	V
102.8	9.79	-13.3	23.09	V
320.1	12.52	-9.9	22.42	H
429.0	15.49	-7.7	23.19	V
536.1	17.47	-5.3	22.77	H

**Channel 157 (1GHz-8GHz )**

Frequency(MHz)	Result(dBuV/m)	ARpl(dB)	PMea(dBuV/m)	Polarity
3000.0	44.99	1.6	43.39	H
3835.6	45.66	2.1	43.56	H
6119.0	43	2.6	40.4	H
6676.2	45.99	3.8	42.19	H
7068.4	45.13	4.3	40.83	H
7657.4	45.22	3.5	41.72	H

**Channel 157 (8GHz-18GHz)**

Frequency(MHz)	Result(dBuV/m)	ARpl(dB)	PMea(dBuV/m)	Polarity
9603.8	45.36	5.8	39.56	V
11666.0	49.41	9.9	39.51	V
12874.0	50.67	11.2	39.47	H
14191.0	49.53	12.4	37.13	V
15601.4	51.52	14.4	37.12	H
16874.0	54.08	17.5	36.58	H

**Channel 157 (8GHz-18GHz) (Average)**

Frequency(MHz)	Result(dBuV/m)	ARpl(dB)	PMea(dBuV/m)	Polarity
16874.0	44	17.5	26.5	H

**Channel 157 (18GHz-25.6GHz)**

Frequency(MHz)	Result(dBuV/m)	ARpl(dB)	PMea(dBuV/m)	Polarity
19087.2	41.84	-4.4	46.24	V
20531.3	44.13	-3.1	47.23	V
21655.0	46.8	-2.4	49.2	V
22892.6	47.07	-0.7	47.77	H
24092.8	48.47	-0.1	48.57	V
25750.3	49.89	1	48.89	V

**Channel 157 (25.6GHz-40GHz)**

Frequency(MHz)	Result(dBuV/m)	ARpl(dB)	PMea(dBuV/m)	Polarity
28479.1	34.84	-0.9	35.74	V
30720.1	36.45	-0.1	36.55	H
33044.8	38.29	4.2	34.09	V
35839.3	43.76	6.4	37.36	H
37402.6	43.8	7.7	36.1	V
39184.6	47.94	12.1	35.84	V

**802.11n-HT40 mode**
**Channel 159(30MHz ~ 1GHz )**

Frequency(MHz)	Result(dBuV/m)	ARpl(dB)	PMea(dBuV/m)	Polarity
32.5	11.02	-14.2	25.22	H
62.5	9.9	-13.2	23.1	V
122.7	13.41	-15.3	28.71	H
289.5	11.59	-11	22.59	V
395.7	14.36	-8.3	22.66	V
518.3	16.98	-5.7	22.68	V

**Channel 159 (1GHz-8GHz )**

Frequency(MHz)	Result(dBuV/m)	ARpl(dB)	PMea(dBuV/m)	Polarity
2987.2	47.65	1.9	45.75	H
6311.0	45.19	3	42.19	H
6744.0	46.37	3.7	42.67	H
7091.0	45.87	4.3	41.57	H
7426.6	45.12	3.6	41.52	H
7642.0	45.21	3.5	41.71	H

**Channel 159 (8GHz-18GHz)**

Frequency(MHz)	Result(dBuV/m)	ARpl(dB)	PMea(dBuV/m)	Polarity
9257.0	47.27	5.1	42.17	H
10416.6	47.6	7.7	39.9	V
11623.0	48.96	9.8	39.16	H
13233.8	50.26	10.9	39.36	H
14927.4	52	13.8	38.2	H
16313.4	52.08	16.1	35.98	V

**Channel 159 (18GHz-26.5GHz)**

Frequency(MHz)	Result(dBuV/m)	ARpl(dB)	PMea(dBuV/m)	Polarity
19248.6	42.28	-4.7	46.98	V
20866.2	43.6	-2.7	46.3	H
22043.4	46.21	-2	48.21	V
23384.8	46.01	-0.9	46.91	V
24537.4	47.45	-0.3	47.75	V
25537.0	49.11	-0.9	50.01	V

**Channel 159 (25.6GHz-40GHz)**

Frequency(MHz)	Result(dBuV/m)	ARpl(dB)	PMea(dBuV/m)	Polarity
27775.8	35.9	-0.8	36.7	H
29628.0	36.05	0.1	35.95	H
31492.3	37.96	1.1	36.86	V
33574.0	39.51	4.5	35.01	H
35761.0	42.94	6.5	36.44	H
38251.8	45.64	9	36.64	H

**802.11ac-VHT20 mode**
**Channel 157 (30MHz ~ 1GHz )**

Frequency(MHz)	Result(dBuV/m)	ARpl(dB)	PMea(dBuV/m)	Polarity
32.5	12.03	-14.2	26.23	H
54.9	10.45	-12.1	22.55	H
122.7	13.7	-15.3	29	H
400.5	14.48	-8.1	22.58	H
471.9	15.96	-6.6	22.56	H
570.5	18.24	-3.9	22.14	V

**Channel 157 (1GHz-8GHz )**

Frequency(MHz)	Result(dBuV/m)	ARpl(dB)	PMea(dBuV/m)	Polarity
2987.4	45.46	1.9	43.56	H
6069.2	44.07	2.5	41.57	H
6320.6	44.54	2.9	41.64	H
6809.2	45.8	3.4	42.4	H
7132.2	44.83	4.1	40.73	H
7342.6	44.47	3.9	40.57	H

**Channel 157 (8GHz-18GHz)**

Frequency(MHz)	Result(dBuV/m)	ARpl(dB)	PMea(dBuV/m)	Polarity
9104.6	45.26	4.8	40.46	V
11649.2	50.24	9.9	40.34	H
12942.2	49.99	11.1	38.89	V
14425.0	49.63	12.4	37.23	H
15624.8	50.93	14.4	36.53	H
16906.6	53.81	17.4	36.41	H

**Channel 157 (18GHz-26.5GHz)**

Frequency(MHz)	Result(dBuV/m)	ARpl(dB)	PMea(dBuV/m)	Polarity
18977.5	41.63	-4.5	46.13	V
20299.2	42.25	-4.3	46.55	V
21552.2	45.39	-2.2	47.59	V
22863.7	46.45	-0.6	47.05	H
24097.0	48.51	-0.1	48.61	V
25199.5	48.28	0.3	47.98	V



**Channel 157 (26.5GHz-40GHz)**

Frequency(MHz)	Result(dBuV/m)	ARpl(dB)	PMea(dBuV/m)	Polarity
27972.8	35.43	-0.2	35.63	V
30955.0	38.42	1.3	37.12	H
32957.0	39.71	4.1	35.61	V
34922.6	39.43	3.2	36.23	H
36980.0	46.1	8.3	37.8	H
38636.5	47.23	10.6	36.63	H

**802.11ac-VHT40 mode**
**Channel 151 (30MHz ~ 1GHz )**

Frequency(MHz)	Result(dBuV/m)	ARpl(dB)	PMea(dBuV/m)	Polarity
32.3	11.19	-14.2	25.39	H
61.1	9.83	-12.7	22.53	V
122.7	13.61	-15.3	28.91	H
284.7	11.53	-11	22.53	V
394.8	14.37	-8.3	22.67	V
495.8	16.65	-6.5	23.15	V

**Channel 151 (1GHz-8GHz )**

Frequency(MHz)	Result(dBuV/m)	ARpl(dB)	PMea(dBuV/m)	Polarity
2993.2	49.6	1.8	47.8	H
3842.0	45	2	43	H
6425.6	44.62	2.9	41.72	H
6692.8	45.33	4	41.33	H
7061.2	45.2	4.4	40.8	H
7334.0	44.26	3.9	40.36	H

**Channel 151 (8GHz-18GHz)**

Frequency(MHz)	Result(dBuV/m)	ARpl(dB)	PMea(dBuV/m)	Polarity
9720.4	47.21	5.5	41.71	V
11460.8	48.74	9.1	39.64	H
12921.0	49.98	11.2	38.78	V
14164.6	49.35	12.4	36.95	V
15705.4	51.17	14.6	36.57	H
16739.0	52.67	16.6	36.07	V

**Channel 151 (8GHz-18GHz)**

Frequency(MHz)	Result(dBuV/m)	ARpl(dB)	PMea(dBuV/m)	Polarity
9235.8	30.7	5.6	25.1	V
11591.6	41.13	10.2	30.93	H
12871	34.62	12	22.62	H
14511.6	34.73	13.1	21.63	H
15641.6	36.18	15.6	20.58	H
17246.6	38.49	18.4	20.09	H



**Channel 151 (18GHz-26.5GHz)**

Frequency(MHz)	Result(dBuV/m)	ARpl(dB)	PMea(dBuV/m)	Polarity
19225.7	42.15	-4.7	46.85	V
20553.4	44.05	-3.3	47.35	H
21992.4	45.89	-2.1	47.99	V
23315.9	46.62	-0.6	47.22	V
24737.1	49.11	0.6	48.51	H
25758.8	49.61	1	48.61	V

**Channel 151 (26.5GHz-40GHz)**

Frequency(MHz)	Result(dBuV/m)	ARpl(dB)	PMea(dBuV/m)	Polarity
28087.6	36.11	0.8	35.31	V
30342.1	36.67	1.1	35.57	H
32545.3	38.08	3.5	34.58	V
34396.2	40.62	4.6	36.02	V
36919.3	44.77	8.4	36.37	H
38660.8	47.36	10.8	36.56	H

**802.11ac-VHT80 mode**
**Channel 155 (30MHz ~ 1GHz )**

Frequency(MHz)	Result(dBuV/m)	ARpl(dB)	PMea(dBuV/m)	Polarity
32.35	8.91	-14.2	23.11	H
60.8	9.76	-12.6	22.36	H
122.7	13.18	-15.3	28.48	H
393.3	14.31	-8.3	22.61	H
462.3	15.84	-6.8	22.64	V
598.5	18.80	-3.5	22.3	V

**Channel 155 (1GHz-8GHz )**

Frequency(MHz)	Result(dBuV/m)	ARpl(dB)	PMea(dBuV/m)	Polarity
2993.4	46.96	1.8	45.16	H
6079.6	45.51	2.5	43.01	H
6445.4	45.25	2.9	42.35	H
6749.6	46.24	3.7	42.54	H
7072.2	46.82	4.3	42.52	H
7476.8	45.02	3.4	41.52	H

**Channel 155 (8GHz-18GHz)**

Frequency(MHz)	Result(dBuV/m)	ARpl(dB)	PMea(dBuV/m)	Polarity
9363.2	45.74	5.9	39.84	H
11208.6	48.22	8.0	40.22	V
12764.8	49.96	10.9	39.06	V
14132.4	48.52	12.4	36.12	H
15591	50.97	14.4	36.57	V
17036	54.37	17.3	37.07	V

**Channel 155 (8GHz-18GHz) (Average)**

Frequency(MHz)	Result(dBuV/m)	ARpl(dB)	PMea(dBuV/m)	Polarity
17036	43.65	17.3	46.35	V

**Channel 155 (18GHz-26.5GHz)**

Frequency(MHz)	Result(dBuV/m)	ARpl(dB)	PMea(dBuV/m)	Polarity
19559.75	41.41	-4.7	46.11	H
21013.25	43.99	-3	46.99	V
22463.35	47.28	-1.9	49.18	H
24094.5	48.48	-1.4	49.88	H
25148.5	48.73	-0.2	48.93	V
26330.85	50.20	-0.3	50.50	V

**Channel 155 (26.5GHz-40GHz)**

Frequency(MHz)	Result(dBuV/m)	ARpl(dB)	PMea(dBuV/m)	Polarity
27947.2	36.25	-0.4	36.65	H
30482.5	36.25	1.2	37.45	V
32560.15	38.04	3.5	41.54	V
34502.8	40.26	4.4	44.66	H
36888.25	44.79	8.4	53.16	H
38830.9	48.91	11.4	60.31	V

## 6.7. Band Edges Compliance

### Band Edges - Radiated

#### 6.7.1 Measurement Limit

- (1) For transmitters operating in the 5.15-5.25 GHz band: All emissions outside of the 5.15-5.35 GHz band shall not exceed an e.i.r.p. of -27 dBm/MHz.
- (2) For transmitters operating in the 5.25-5.35 GHz band: All emissions outside of the 5.15-5.35 GHz band shall not exceed an e.i.r.p. of -27 dBm/MHz.
- (3) For transmitters operating in the 5.47-5.725 GHz band: All emissions outside of the 5.47-5.725 GHz band shall not exceed an e.i.r.p. of -27 dBm/MHz.
- (4) All emissions shall be limited to a level of -27 dBm/MHz at 75 MHz or more above or below the band edge increasing linearly to 10 dBm/MHz at 25 MHz above or below the band edge, and from 25 MHz above or below the band edge increasing linearly to a level of 15.6 dBm/MHz at 5 MHz above or below the band edge, and from 5 MHz above or below the band edge increasing linearly to a level of 27 dBm/MHz at the band edge.
- (5) In addition, radiated emissions which fall in the restricted bands, as defined in § 15.205(a), must also comply with the radiated emission limits specified in § 15.209(a) (see § 15.205(c)).

Frequency (MHz)	Field strength (microvolts/meter)	Measurement distance (meters)
0.009-0.490	2400/F(kHz)	300
0.490-1.705	24000/F(kHz)	30
1.705-30.0	30	30
30-88	100**	3
88-216	150**	3
216-960	200**	3
Above 960	500	3

MHz	MHz	MHz	GHz
0.090-0.110	16.42-16.423	399.9-410	4.5-5.15
0.495-0.505	16.69475-16.69525	608-614	5.35-5.46
2.1735-2.1905	16.80425-16.80475	960-1240	7.25-7.75
4.125-4.128	25.5-25.67	1300-1427	8.025-8.5
4.17725-4.17775	37.5-38.25	1435-1626.5	9.0-9.2
4.20725-4.20775	73-74.6	1645.5-1646.5	9.3-9.5
6.215-6.218	74.8-75.2	1660-1710	10.6-12.7
6.26775-6.26825	108-121.94	1718.8-1722.2	13.25-13.4
6.31175-6.31225	123-138	2200-2300	14.47-14.5
8.291-8.294	149.9-150.05	2310-2390	15.35-16.2
8.362-8.366	156.52475-156.52525	2483.5-2500	17.7-21.4
8.37625-8.38675	156.7-156.9	2690-2900	22.01-23.12
8.41425-8.41475	162.0125-167.17	3260-3267	23.6-24.0
12.29-12.293	167.72-173.2	3332-3339	31.2-31.8
12.51975-12.52025	240-285	3345.8-3358	36.43-36.5
12.57675-12.57725	322-335.4	3600-4400	(2)
13.36-13.41			

- (6) IC Restricted frequency bands:

MHz	MHz	GHz
0.090 - 0.110	149.9 - 150.05	9.0 - 9.2
0.495 - 0.505	156.52475 - 156.52525	9.3 - 9.5
2.1735 - 2.1905	156.7 - 156.9	10.6 - 12.7
3.020 - 3.026	162.0125 - 167.17	13.25 - 13.4
4.125 - 4.128	167.72 - 173.2	14.47 - 14.5
4.17725 - 4.17775	240 - 285	15.35 - 16.2
4.20725 - 4.20775	322 - 335.4	17.7 - 21.4
5.677 - 5.683	399.9 - 410	22.01 - 23.12
6.215 - 6.218	608 - 614	23.6 - 24.0
6.26775 - 6.26825	960 - 1427	31.2 - 31.8
6.31175 - 6.31225	1435 - 1626.5	36.43 - 36.5
8.291 - 8.294	1645.5 - 1646.5	Above 38.6
8.362 - 8.366	1660 - 1710	
8.37625 - 8.38675	1718.8 - 1722.2	
8.41425 - 8.41475	2200 - 2300	
12.29 - 12.293	2310 - 2390	
12.51975 - 12.52025	2483.5 - 2500	
12.57675 - 12.57725	2655 - 2900	
13.36 - 13.41	3260 - 3267	
16.42 - 16.423	3332 - 3339	
16.69475 - 16.69525	3345.8 - 3358	
16.80425 - 16.80475	3500 - 4400	
25.5 - 25.67	4500 - 5150	
37.5 - 38.25	5350 - 5460	
73 - 74.6	7250 - 7750	
74.8 - 75.2	8025 - 8500	
108 - 138		

### 6.7.2. Set the spectrum analyzer in the following

1. Sweep mode: SweepAnalyzer6db.
2. PEAK: RBW=1MHz / VBW=3MHz / Sweep=2.5ms, Sweep point;5001
3. AVERAGE: RBW=1MHz / VBW=10Hz / Sweep=2.5ms, Sweep point;5001

#### Measurement Result

Mode	Channel	Conclusion
802.11a	149	P
	165	P
802.11n HT20	149	P
	165	P
802.11n HT40	151	P
	159	P
802.11ac VHT20	149	P
	165	P
802.11ac VHT40	151	P
	159	P
802.11ac VHT80	155	P

Test graphs as below:

#### Mainly Supply

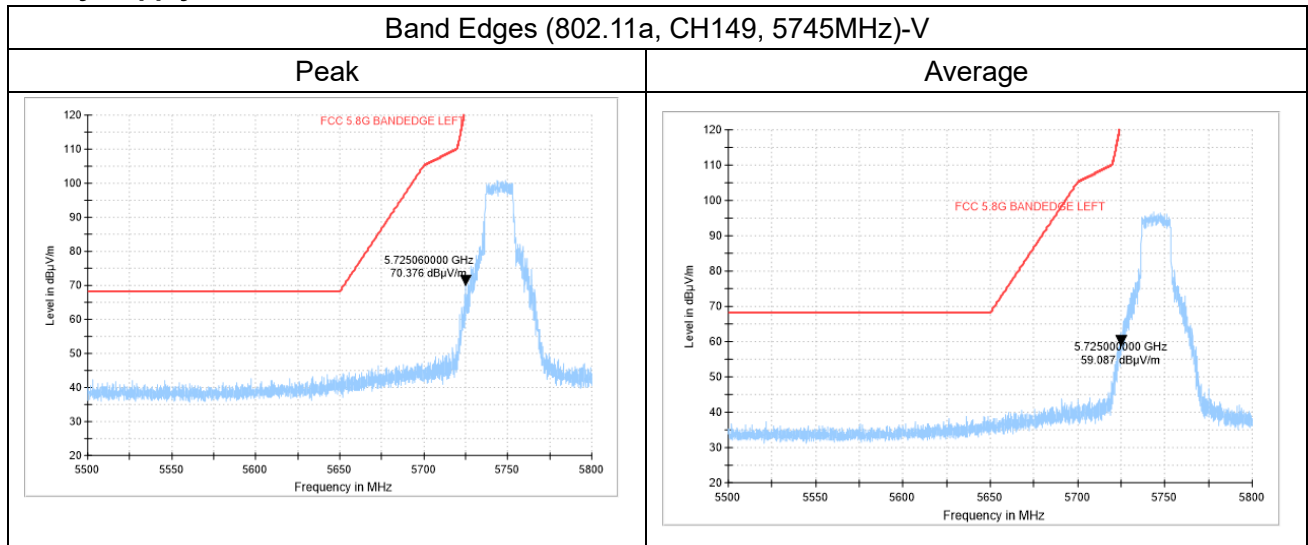

### Band Edges (802.11a, CH165, 5825MHz)-V

Peak

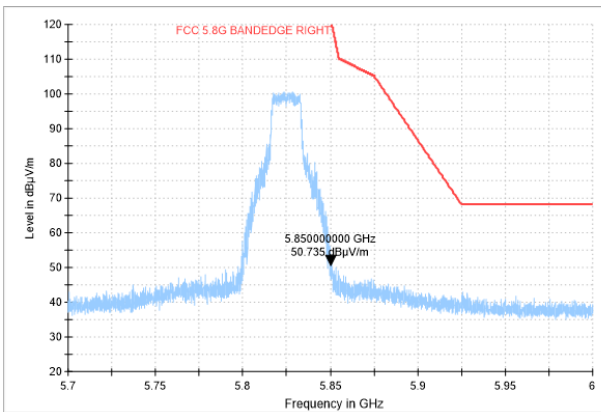

Average

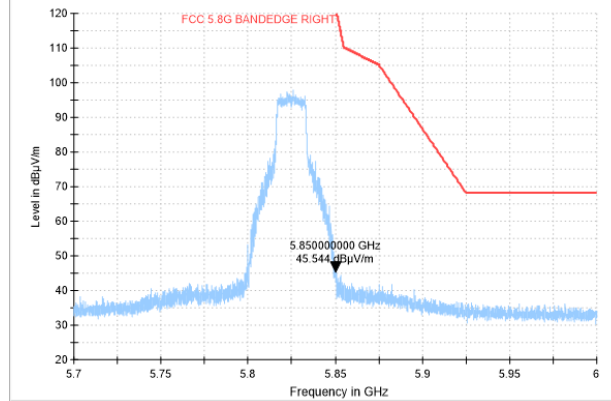

### Band Edges (802.11n-HT20, CH149, 5745MHz)-H

Peak

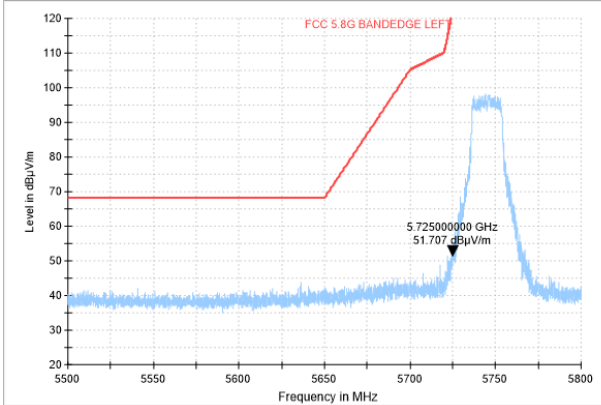

Average

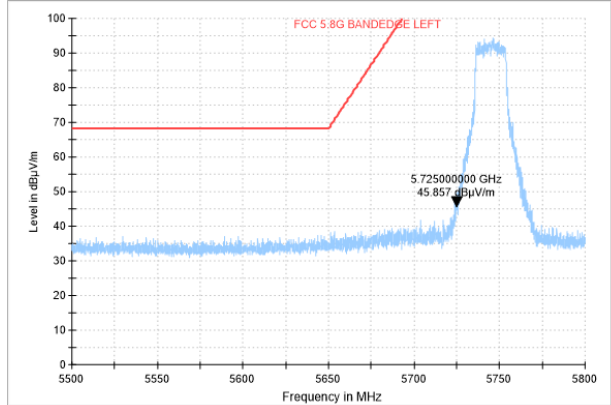

### Band Edges (802.11n-HT20, CH165, 5825MHz)-H

Peak

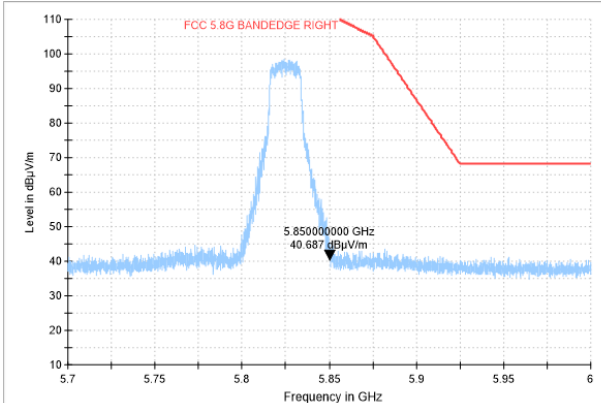

Average

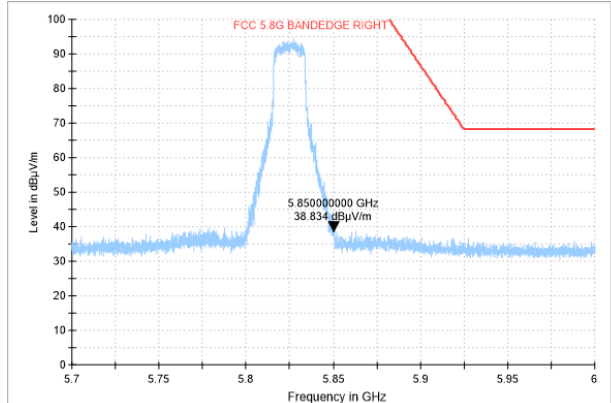

### Band Edges (802.11n-HT40, CH151, 5755MHz)-H

Peak

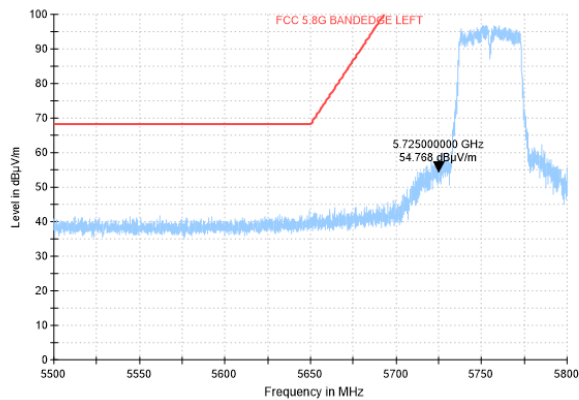

Average

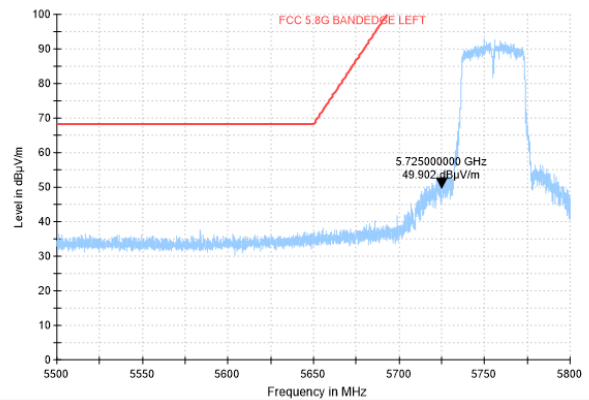

### Band Edges (802.11-HT40, CH159, 5795MHz)-V

Peak

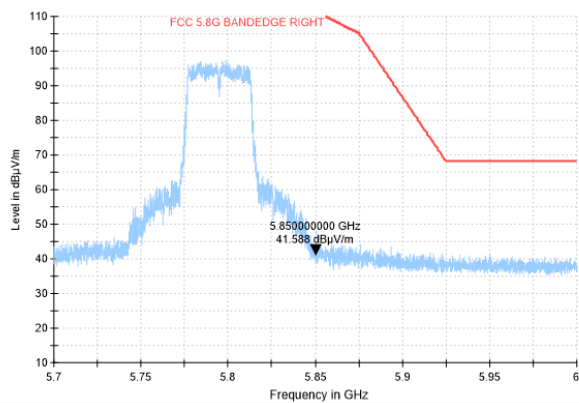

Average

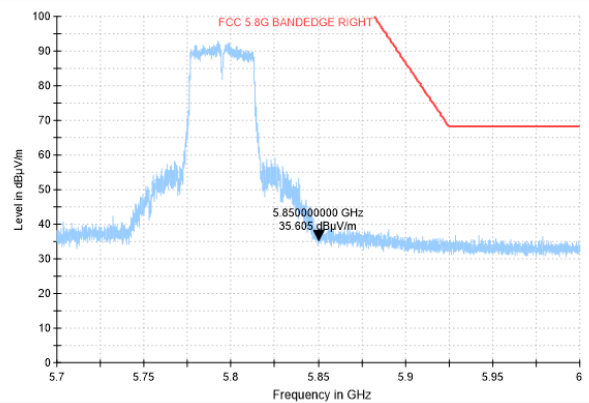

### Band Edges (802.11ac-HT20, CH149, 5745MHz)-H

Peak

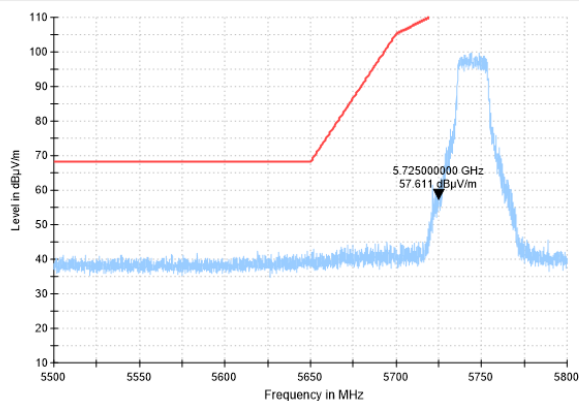

Average

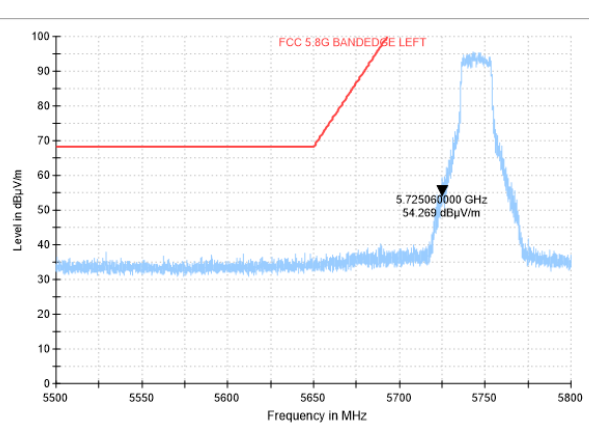

### Band Edges (802.11ac-HT20, CH165, 5825MHz)-H

Peak

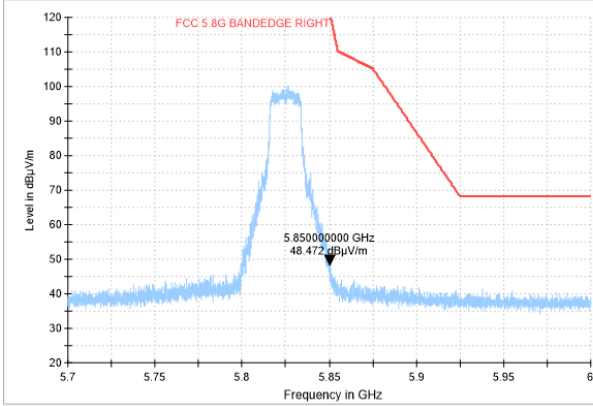

Average

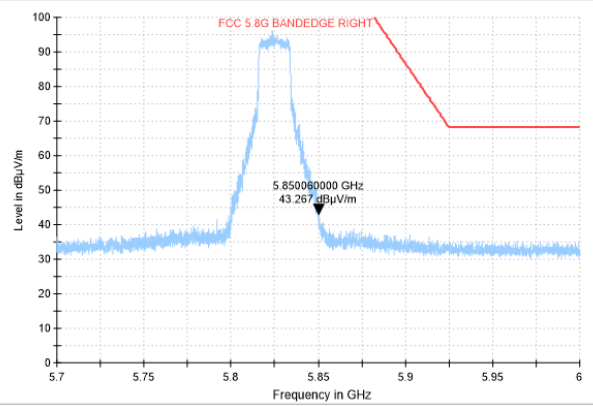

### Band Edges (802.11ac-HT40, CH151, 5755MHz)-V

Peak

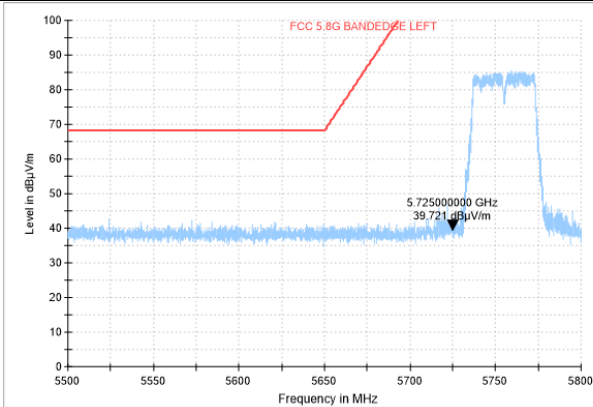

Average

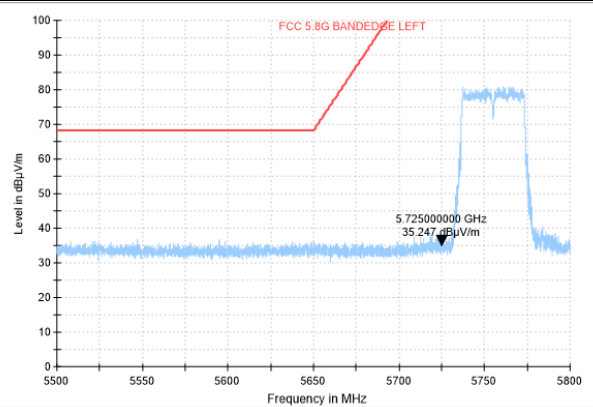

### Band Edges (802.11ac-HT40, CH159, 5795MHz)-V

Peak

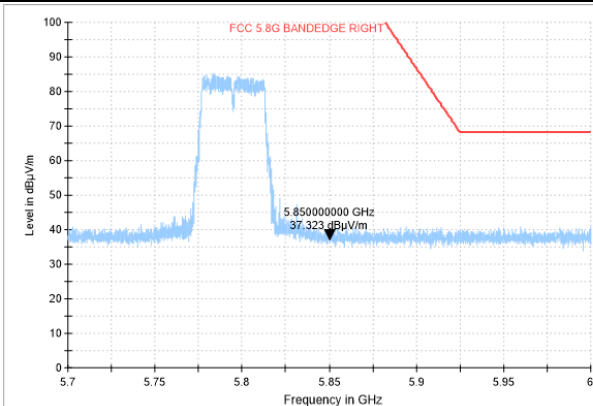

Average

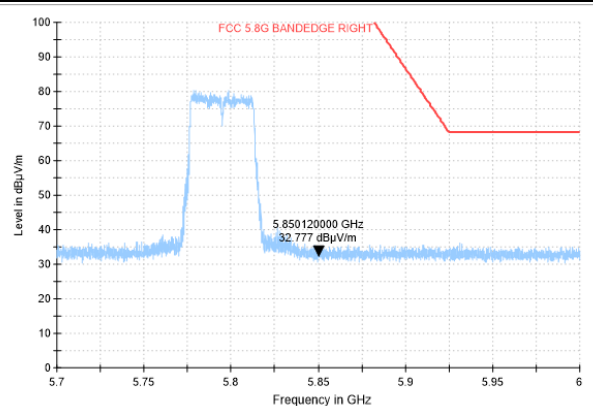



Band Edges (802.11ac-HT80, CH155, 5775MHz)-H

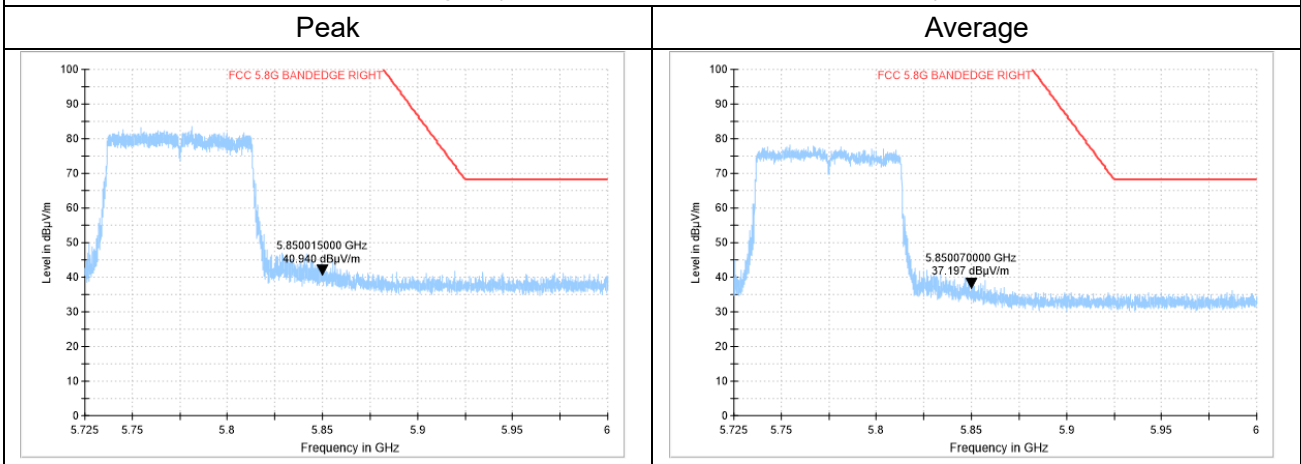

Note: Horizontal and vertical polarity is all have been tested, the result of them is synthesized in the above data diagram.

## 7. Test Equipment List

### 7.1. Conducted Test System

Item	Equipment Name	Type	Serial Number	Manufacturer	Cal. Date	Cal. interval
1	Vector Signal Analyzer	FSQ26	101091	R&S	2020-05-11	1 year
					2021-05-10	
2	DC Power Supply	ZUP60-14	LOC-220Z006-0007	TDL-Lambda	2020-05-11	1 year
					2021-05-10	
3	Eagle Test Software	Eagle V3.1 FCC BT/WIFI	N/A	ECIT	N/A	N/A

### 7.2. Radiated Emission Test System

Item	Equipment Name	Type	Serial Number	Manufacturer	Cal. Date	Cal. interval
1	Universal Radio Communication Tester	CMU200	123123	R&S	2020-05-11	1 year
					2021-05-10	
2	EMI Test Receiver	ESU40	100307	R&S	2021-03-03	1 year
3	TRILOG Broadband Antenna	VULB9163	VULB9163-515	Schwarzbeck	2021-02-03	2 years
4	Double-ridged Waveguide Antenna	ETS-3117	00135890	ETS	2020-02-28	3 years
5	Universal Radio Communication Tester	CMW500	104178	R&S	2020-05-11	1 year
					2021-05-10	
6	EMI Test Software	EMC32 V 9.15.00	N/A	R&S	N/A	N/A

Anechoic chamber

Fully anechoic chamber by ETS.

## Annex A: Measurement Uncertainty

Measurement uncertainty for all the testing in this report are within the limit specified in 3IN documents . The detailed measurement uncertainty is defined in 3IN documents.

Measurement Items	Range	Confidence Level	Calculated Uncertainty
Peak Output Power-Conducted	5100MHz-5875MHz	95%	1.024dB
Peak Power Spectral Density	5100MHz-5875MHz	95%	1.024dB/MHz
Conducted Emission	30MHz-2GHz	95%	0.90dB
Conducted Emission	2GHz-3.6GHz	95%	0.88dB
Conducted Emission	3.6GHz-8GHz	95%	0.96dB
Conducted Emission	8GHz-20GHz	95%	0.94dB
Conducted Emission	20GHz-22GHz	95%	0.88dB
Conducted Emission	22GHz-26GHz	95%	0.86dB
Transmitter Spurious Emission-Radiated	9KHz-30MHz	95%	5.66dB
Transmitter Spurious Emission-Radiated	30MHz-1000MHz	95%	4.98dB
Transmitter Spurious Emission-Radiated	1000MHz -18000MHz	95%	5.06dB
Transmitter Spurious Emission-Radiated	18000MHz -40000MHz	95%	5.20dB
AC Power line Conducted Emission	0.15MHz-30MHz	95%	3.66 dB

## Annex B: Accreditation Certificate



### Accredited Laboratory

A2LA has accredited

## INDUSTRIAL INTERNET INNOVATION CENTER (SHANGHAI) CO., LTD.

Shanghai, People's Republic of China

for technical competence in the field of

### Electrical Testing

This laboratory is accredited in accordance with the recognized International Standard ISO/IEC 17025:2017 *General requirements for the competence of testing and calibration laboratories*. This accreditation demonstrates technical competence for a defined scope and the operation of a laboratory quality management system (refer to joint ISO-ILAC-IAF Communiqué dated April 2017).



Presented this 12<sup>th</sup> day of April 2021.

Vice President, Accreditation Services  
For the Accreditation Council  
Certificate Number 3682.01  
Valid to February 28, 2023

*For the tests to which this accreditation applies, please refer to the laboratory's Electrical Scope of Accreditation.*

\*\*\*\*\*END OF REPORT\*\*\*\*\*