



Antenna Passive Test Report

Project Name	XQT530	Engineer	wuqingjie	Checker	
HW Version	V00	Prototype(S/N)	VE03E28100041	Software Version	00.00.20220728 test-ke
Temperature/Humidity	25°C/50%	Test Equipment	OTA	Test Date	2022.09.08
Conclusion:		Remarks			

Standard	Fre(Mhz)	Effi(%) (Min~Max)	Problem Description and Next Step Plan
Main Antenna	690~800	27%-39%	
	800~960	30%-42%	
	1700~2170	37%-51%	
	2300~2400	41%-50%	
	2500~2700	35%-55%	
Div Antenna	690~800	1%-23%	
	800~960	24%-45%	
	1700~2170	30%-42%	
	2300~2400	18%-23%	
	2500~2700	18%-22%	
WiFi	2.4G	40%-46%	
	5G	31%-45%	
GPS	L5	35%	

Matching Circuit, Switch Logic Schematic(CAD and Tag Number Diagram)

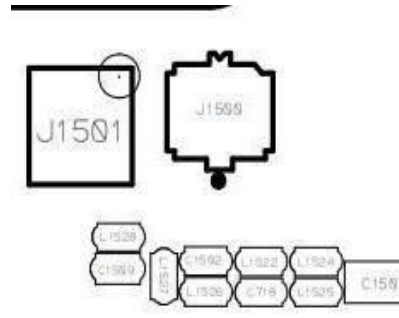
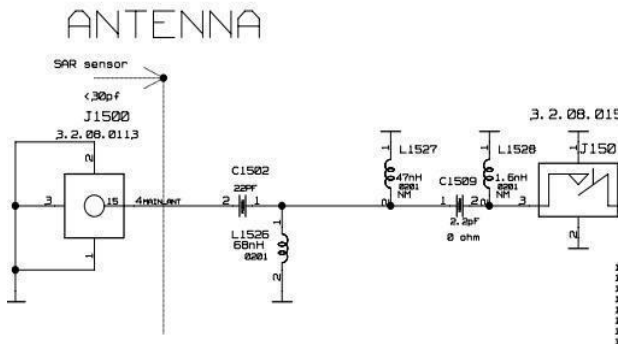

Element	Matching
L1527	NM
C1509	0ohm
L1528	NM

S Parameter (Return Loss, Smith)

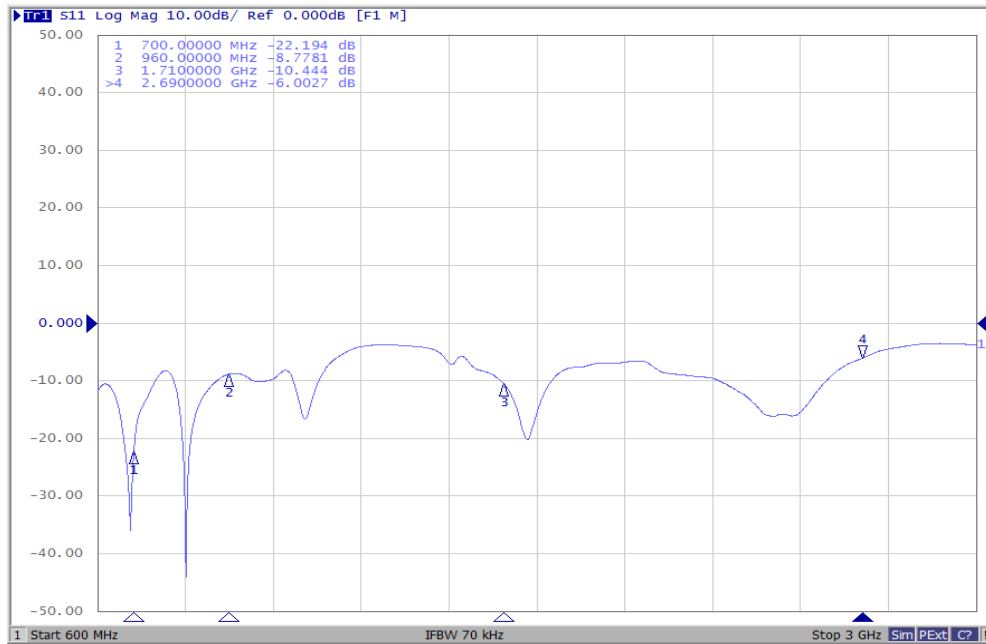

Passive Performance (Efficiency, Gain)

frequency (MHz)	Gain (dB)	Efficiency (dB)	Efficiency (%)
690	-0.31	-3.99	39.86%
700	-0.48	-4.20	37.97%
710	-0.52	-4.21	37.86%
720	-1.06	-4.72	33.66%
730	-0.84	-4.55	35.00%
740	-1.04	-4.58	34.79%
750	-1.38	-4.99	31.63%
760	-1.56	-5.43	28.64%
770	-1.75	-5.61	27.44%
780	-1.48	-4.70	33.86%
790	-1.51	-4.83	32.86%
800	-1.26	-4.70	33.88%
810	-1.05	-4.35	36.69%
820	-1.27	-5.19	30.22%
830	-1.11	-4.83	32.88%
840	-0.73	-4.41	36.17%
850	-0.55	-4.30	37.08%
860	-0.48	-4.28	37.27%
870	-0.39	-4.20	37.95%
880	-0.19	-4.00	39.73%
890	0.15	-3.85	41.15%
900	0.25	-3.85	41.18%
910	0.03	-4.13	38.60%
920	-0.12	-4.42	36.13%
930	-0.25	-4.47	35.68%
940	-0.24	-4.32	36.95%
950	-0.04	-4.11	38.73%
960	0.05	-4.09	38.95%
970	0.04	-4.09	38.97%
980	-0.18	-4.25	37.53%
1700	-0.35	-3.81	41.60%
1710	-0.12	-3.57	44.00%
1720	0.18	-3.27	47.14%
1730	0.46	-3.12	48.77%
1740	0.79	-2.92	51.09%

1750	0.85	-2.95	50.72%
1760	1.00	-2.98	50.39%
1770	1.10	-3.12	48.80%
1780	1.24	-3.26	47.20%
1790	1.40	-3.38	45.95%
1800	1.58	-3.36	46.16%
1810	1.67	-3.33	46.50%
1820	1.77	-3.19	48.00%
1830	1.47	-3.30	46.79%
1840	1.05	-3.56	44.08%
1850	0.92	-3.60	43.63%
1860	0.90	-3.58	43.86%
1870	1.27	-3.63	43.36%
1880	1.83	-3.44	45.28%
1890	2.00	-3.47	44.94%
1900	2.02	-3.59	43.74%
1910	1.86	-3.68	42.88%
1920	1.77	-3.72	42.46%
1930	1.57	-3.87	41.04%
1940	1.26	-4.07	39.16%
1950	1.11	-4.18	38.15%
1960	0.99	-4.22	37.80%
1970	1.19	-4.03	39.54%
1980	1.22	-4.03	39.58%
1990	0.89	-4.16	38.39%
2000	0.86	-4.06	39.29%
2010	0.90	-4.03	39.52%
2020	0.93	-3.94	40.39%
2030	0.90	-3.89	40.81%
2040	0.95	-3.98	39.98%
2050	1.01	-4.06	39.30%
2060	1.03	-4.01	39.75%
2070	0.87	-4.02	39.62%
2080	0.84	-4.07	39.22%
2090	1.07	-4.16	38.37%
2100	1.33	-4.11	38.78%
2110	1.71	-3.65	43.17%
2120	1.48	-3.58	43.85%
2130	0.82	-3.89	40.86%

2140	0.58	-3.93	40.50%
2150	0.94	-3.67	42.94%
2160	1.02	-3.54	44.31%
2170	1.02	-3.38	45.95%
2180	0.86	-3.45	45.19%
2190	0.73	-3.73	42.33%
2200	0.94	-3.63	43.31%
2210	1.11	-3.55	44.13%
2220	0.98	-3.70	42.66%
2230	1.06	-3.66	43.09%
2240	0.83	-3.89	40.82%
2250	0.94	-3.78	41.88%
2260	1.25	-3.50	44.71%
2270	1.09	-3.69	42.73%
2280	0.88	-3.99	39.88%
2290	0.95	-3.93	40.45%
2300	1.07	-3.77	41.96%
2310	1.18	-3.62	43.43%
2320	1.28	-3.46	45.12%
2330	1.36	-3.35	46.19%
2340	1.41	-3.25	47.34%
2350	1.67	-2.96	50.64%
2360	1.63	-2.99	50.27%
2370	1.31	-3.29	46.92%
2380	1.43	-3.11	48.89%
2390	1.28	-3.12	48.74%
2400	1.28	-3.04	49.71%
2410	1.31	-3.04	49.63%
2420	1.19	-3.15	48.43%
2430	1.38	-3.11	48.87%
2440	1.59	-3.02	49.90%
2450	1.61	-3.20	47.90%
2460	2.08	-2.99	50.20%
2470	2.31	-2.95	50.69%
2480	2.64	-2.81	52.39%
2490	2.99	-2.57	55.32%
2500	2.96	-2.59	55.10%
2510	2.96	-2.58	55.14%
2520	2.90	-2.60	54.95%

2530	2.80	-2.66	54.17%
2540	2.47	-2.87	51.59%
2550	2.35	-2.83	52.13%
2560	2.19	-2.86	51.71%
2570	2.04	-2.86	51.71%
2580	1.62	-3.13	48.67%
2590	1.16	-3.35	46.25%
2600	1.21	-3.09	49.08%
2610	1.16	-2.97	50.43%
2620	0.74	-3.23	47.50%
2630	0.47	-3.48	44.88%
2640	0.32	-3.64	43.28%
2650	0.40	-3.69	42.71%
2660	0.67	-3.66	43.10%
2670	0.68	-3.91	40.62%
2680	0.65	-4.13	38.62%
2690	0.73	-4.28	37.33%
2700	0.76	-4.44	35.93%

Matching Circuit, Switch Logic Schematic(CAD and Tag Number Diagram)

LTE DRX

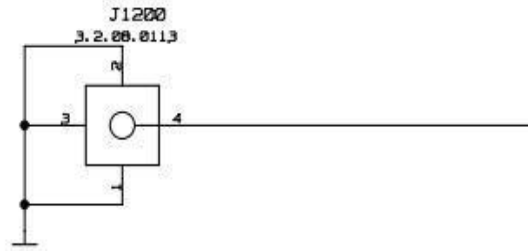

Element	Matching
NM	NM

S Parameter (Return Loss, Smith)

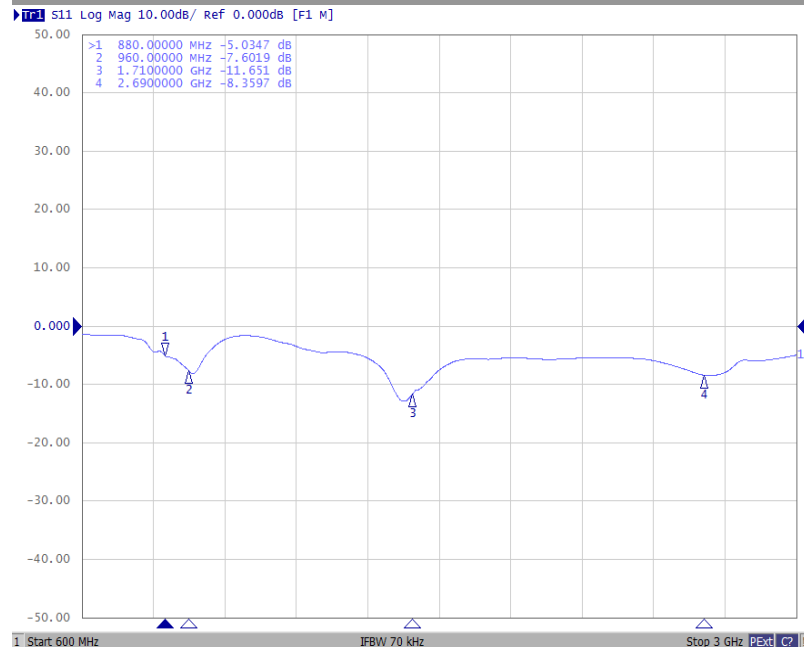

Passive Performance (Efficiency, Gain)

frequency (MHz)	Gain (dB)	Efficiency (dB)	Efficiency (%)
690	-14.56	-18.25	1.50%
700	-13.38	-16.93	2.03%
710	-12.17	-15.69	2.70%
720	-10.85	-14.46	3.58%
730	-9.36	-13.01	5.00%
740	-7.87	-11.66	6.82%
750	-6.80	-10.96	8.01%
760	-6.20	-10.15	9.65%
770	-5.42	-9.18	12.08%
780	-4.69	-8.13	15.37%
790	-2.58	-6.50	22.37%
800	-2.29	-6.30	23.43%
810	-2.13	-6.07	24.69%
820	-1.88	-5.96	25.35%
830	-1.38	-5.69	26.95%
840	-1.54	-5.61	27.46%
850	-1.12	-5.33	29.29%
860	-0.81	-4.87	32.51%
870	-0.76	-4.70	33.88%
880	-0.64	-4.11	38.74%
890	-0.53	-4.01	39.69%
900	-0.42	-3.68	42.78%
910	-0.35	-3.61	43.47%
920	-0.21	-3.52	44.43%
930	-0.12	-3.44	45.21%
940	0.10	-3.56	43.98%
950	0.25	-3.75	42.15%
960	-0.24	-4.02	39.60%
970	-0.45	-4.61	34.56%
980	-0.69	-4.78	33.21%
1700	0.42	-4.37	36.55%
1710	1.08	-4.06	39.30%
1720	1.63	-3.82	41.45%
1730	1.93	-3.77	42.00%
1740	2.28	-3.70	42.63%
1750	2.24	-3.94	40.39%

1760	2.27	-4.06	39.23%
1770	2.32	-4.16	38.35%
1780	2.19	-4.30	37.15%
1790	2.01	-4.50	35.45%
1800	2.00	-4.54	35.13%
1810	1.85	-4.53	35.21%
1820	1.72	-4.57	34.90%
1830	1.62	-4.72	33.73%
1840	1.41	-4.88	32.50%
1850	1.31	-4.90	32.32%
1860	1.32	-4.82	32.95%
1870	1.24	-4.89	32.47%
1880	1.23	-4.86	32.67%
1890	1.15	-4.84	32.85%
1900	0.82	-4.93	32.13%
1910	0.47	-4.95	32.01%
1920	0.12	-4.97	31.87%
1930	-0.32	-5.12	30.73%
1940	-0.69	-5.18	30.37%
1950	-0.80	-5.07	31.13%
1960	-0.79	-5.00	31.62%
1970	-0.64	-4.88	32.50%
1980	-0.58	-4.84	32.78%
1990	-0.62	-4.84	32.83%
2000	-0.23	-4.67	34.11%
2010	0.08	-4.53	35.26%
2020	0.03	-4.67	34.16%
2030	0.01	-4.69	33.95%
2040	0.04	-4.56	35.02%
2050	0.25	-4.52	35.34%
2060	0.55	-4.43	36.07%
2070	0.49	-4.50	35.47%
2080	0.24	-4.54	35.16%
2090	0.34	-4.80	33.05%
2100	0.36	-4.55	35.04%
2110	0.37	-4.57	34.84%
2120	0.31	-4.52	35.29%
2130	0.00	-4.41	36.18%
2140	0.13	-4.31	37.00%

2150	0.50	-4.54	35.12%
2160	0.65	-4.74	33.56%
2170	0.76	-4.87	32.53%
2180	0.90	-4.75	33.47%
2190	0.94	-4.79	33.14%
2200	1.04	-4.74	33.57%
2210	1.02	-4.75	33.48%
2220	0.78	-4.90	32.31%
2230	0.61	-5.03	31.35%
2240	-0.03	-4.42	36.13%
2250	-0.46	-4.81	33.01%
2260	-0.83	-5.17	30.43%
2270	-1.94	-5.25	29.80%
2280	-3.30	-5.59	27.60%
2290	-4.42	-6.18	24.09%
2300	-4.44	-6.25	23.69%
2310	-4.55	-6.42	22.77%
2320	-4.88	-6.55	22.13%
2330	-5.18	-6.60	21.83%
2340	-5.38	-6.74	21.17%
2350	-5.85	-6.83	20.73%
2360	-5.91	-6.87	20.55%
2370	-6.42	-7.03	19.80%
2380	-5.96	-7.33	18.46%
2390	-5.54	-7.23	18.89%
2400	-4.95	-7.07	19.61%
2410	-4.37	-6.86	20.58%
2420	-4.48	-6.68	21.44%
2430	-4.32	-6.97	20.09%
2440	-3.77	-6.92	20.28%
2450	-3.86	-6.98	20.02%
2460	-3.60	-6.84	20.67%
2470	-3.30	-6.80	20.85%
2480	-3.26	-6.82	20.77%
2490	-2.80	-6.58	21.96%
2500	-2.70	-6.48	22.47%
2510	-2.77	-6.52	22.26%
2520	-2.83	-6.60	21.86%
2530	-2.78	-6.61	21.78%

2540	-2.81	-6.69	21.41%
2550	-2.53	-6.55	22.12%
2560	-2.42	-6.52	22.26%
2570	-2.61	-6.65	21.62%
2580	-2.67	-6.67	21.51%
2590	-2.80	-6.75	21.13%
2600	-2.67	-6.70	21.37%
2610	-2.53	-6.66	21.55%
2620	-3.54	-7.15	19.25%
2630	-4.03	-7.31	18.54%
2640	-3.87	-7.12	19.39%
2650	-4.31	-7.20	19.05%
2660	-4.49	-7.14	19.29%
2670	-4.91	-7.23	18.92%
2680	-5.57	-7.42	18.09%
2690	-5.73	-7.41	18.13%
2700	-5.66	-7.30	18.58%

Matching Circuit, Switch Logic Schematic(CAD and Tag Number Diagram)

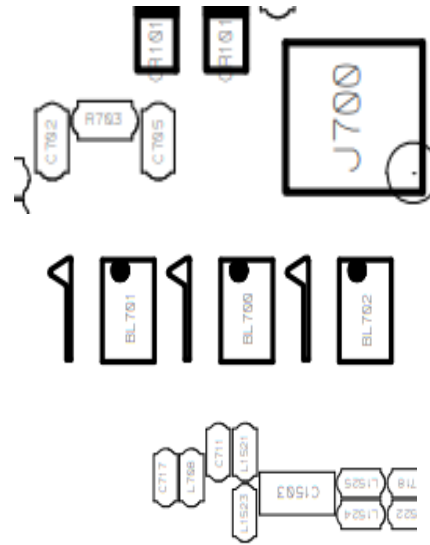
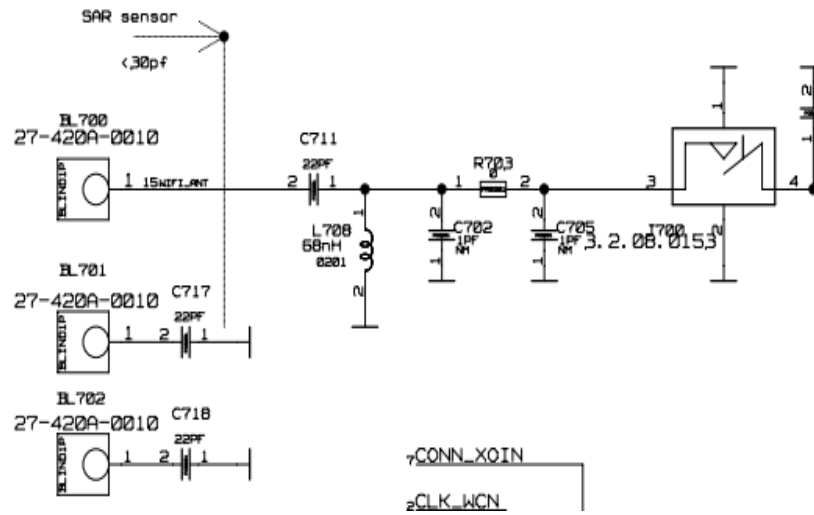

Element	Matching
C702	NM
R703	00HM
C705	NM
C717	22PF
C718	22PF

S Parameter (Return Loss, Smith)

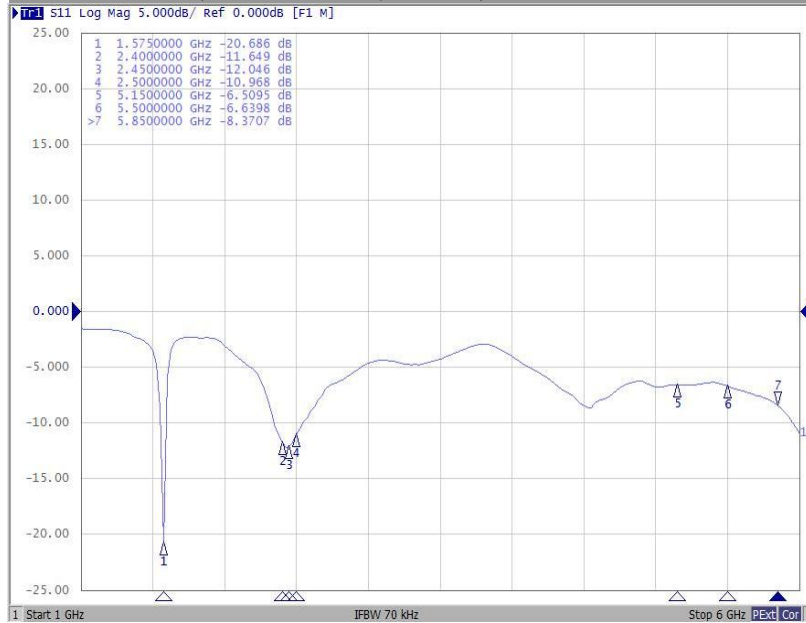

Passive Performance (Efficiency, Gain)

frequency (MHz)	Gain(dB)	Efficiency(dB)	Efficiency(%)
1550	-1.9	-5.28	29.65%
1555	-1.99	-5.28	29.67%
1560	-1.83	-5.04	31.31%
1565	-1.72	-4.85	32.73%
1570	-1.64	-4.68	34.02%
1575	-1.57	-4.55	35.09%
1580	-1.48	-4.50	35.50%
1585	-1.46	-4.52	35.30%
1590	-1.5	-4.59	34.75%
1595	-1.59	-4.70	33.92%
1600	-1.95	-5.02	31.49%
1605	-2.32	-5.33	29.33%
1610	-2.85	-5.76	26.54%
1615	-3.51	-6.28	23.57%
1620	-4.07	-6.71	21.33%
2400	1.69	-3.29	46.86%
2410	1.45	-3.54	44.27%
2420	1.82	-3.48	44.86%
2430	2.06	-3.52	44.42%
2440	2.27	-3.55	44.20%
2450	2.07	-3.84	41.31%
2460	2.05	-3.88	40.96%
2470	1.97	-3.86	41.16%
2480	2.06	-3.66	43.01%
2490	2	-3.62	43.48%
2500	1.79	-3.74	42.24%
5000	2.07	-3.79	41.76%
5050	2.64	-3.74	42.28%
5100	3.31	-3.44	45.33%
5150	3.25	-3.50	44.62%
5200	2.34	-3.74	42.28%
5250	1.47	-4.02	39.66%
5300	0.39	-4.59	34.78%
5350	0.56	-4.78	33.26%
5400	0.56	-4.80	33.09%
5450	0.04	-4.94	32.05%

5500	-0.08	-4.93	32.16%
5550	-0.38	-5.07	31.14%
5600	-0.12	-4.86	32.68%
5650	0.14	-4.42	36.14%
5700	1.16	-4.09	39.01%
5750	0.99	-4.24	37.71%
5800	0.73	-4.09	38.99%
5850	1.42	-3.80	41.67%
5900	0.87	-4.28	37.32%
5950	0.65	-4.44	35.98%

Matching Circuit, Switch Logic Schematic(CAD and Tag Number Diagram)

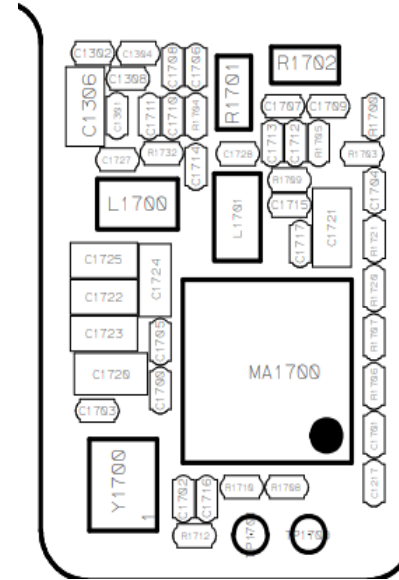
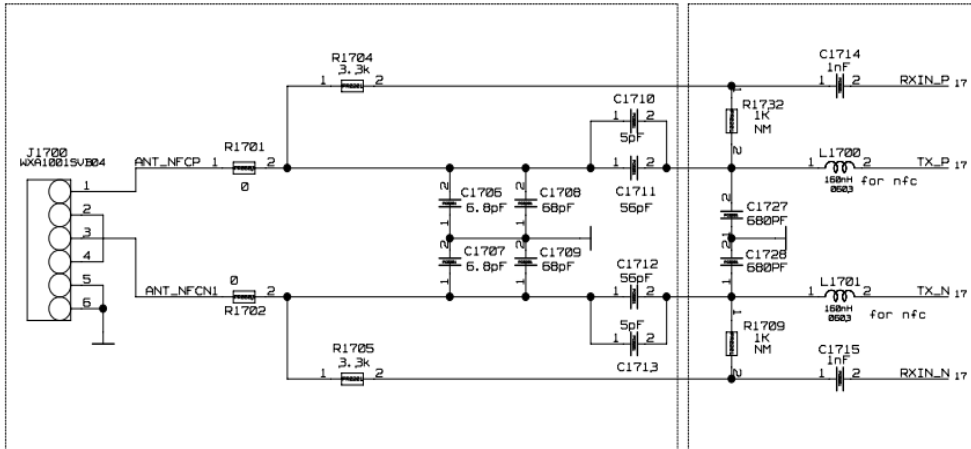

Element	Matching
C1710/C1713	22pF
C1711/C1712	33pF
C1706/C1707	120pF
C1708/C1709	56pF
L1700/L1701	160nH
R1704/R1705	680pF
R1709/R1732	NC
R1709/R1732	560 Ω

S Parameter (Return Loss, Smith)

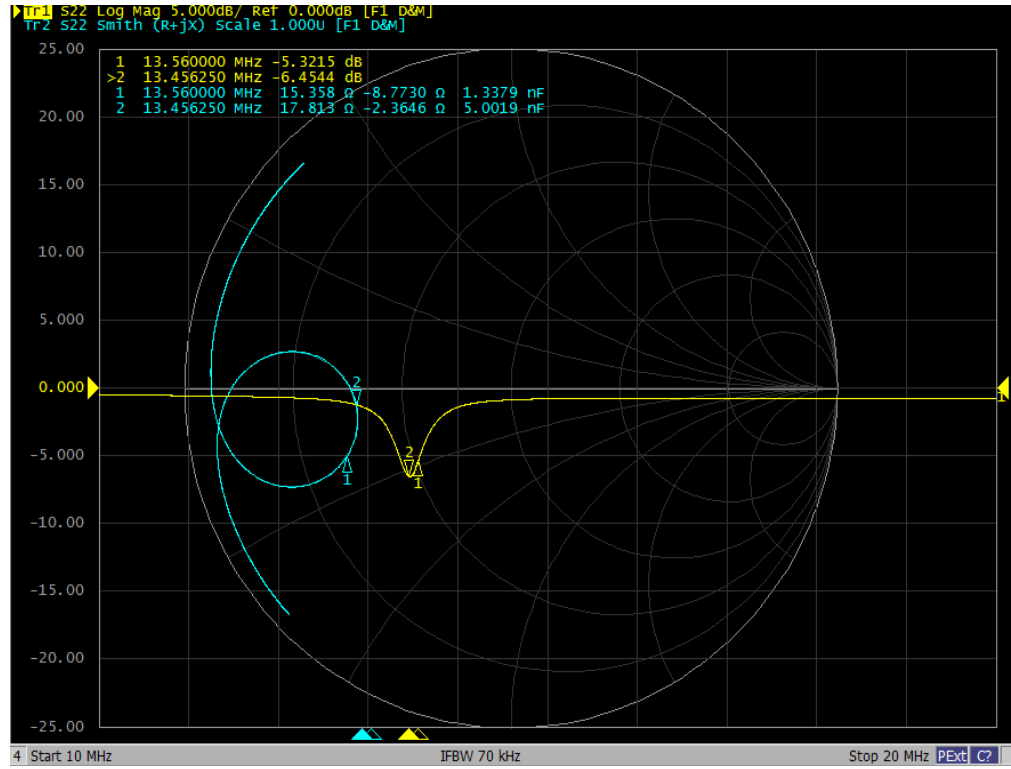

MAIN ANT 3D Pattern

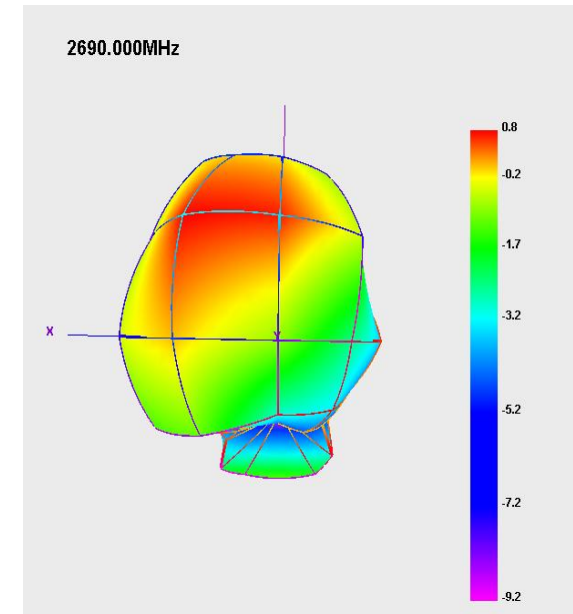
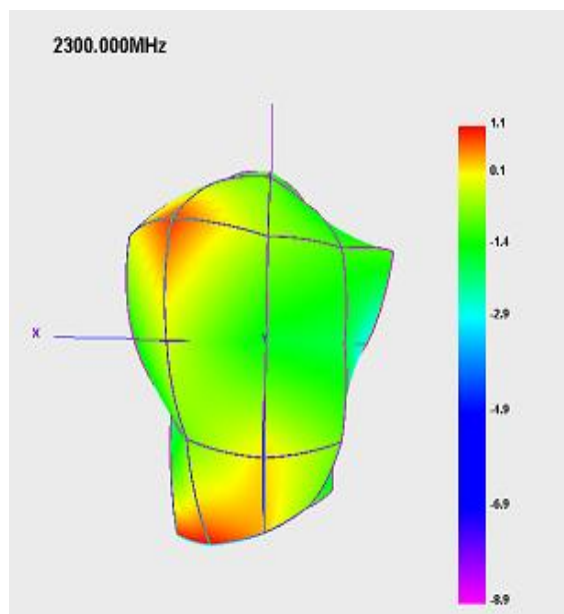
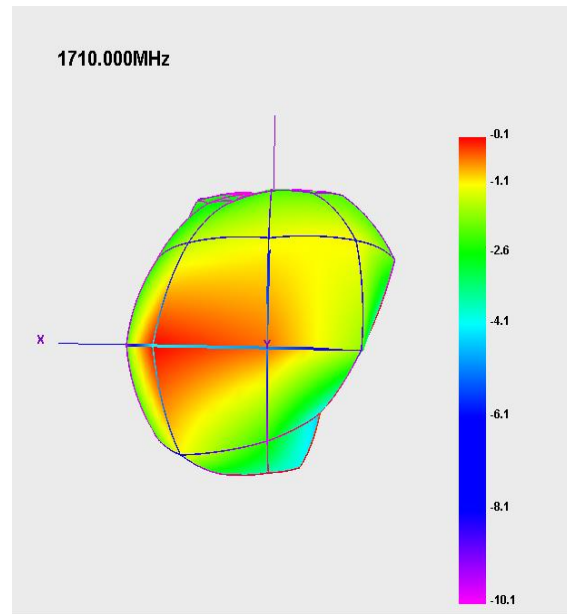
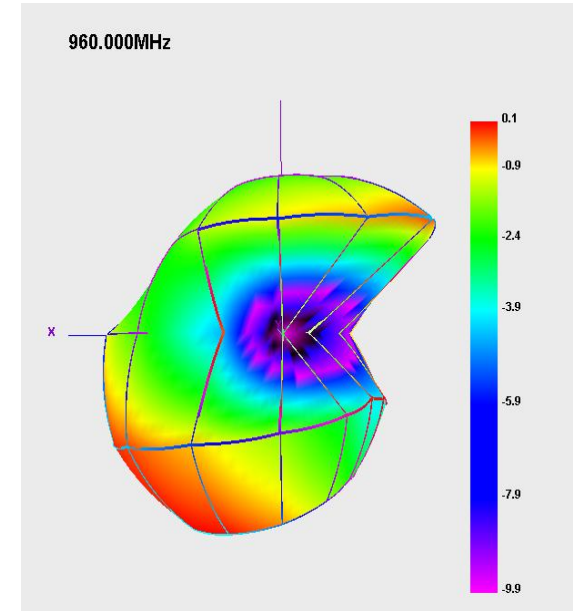
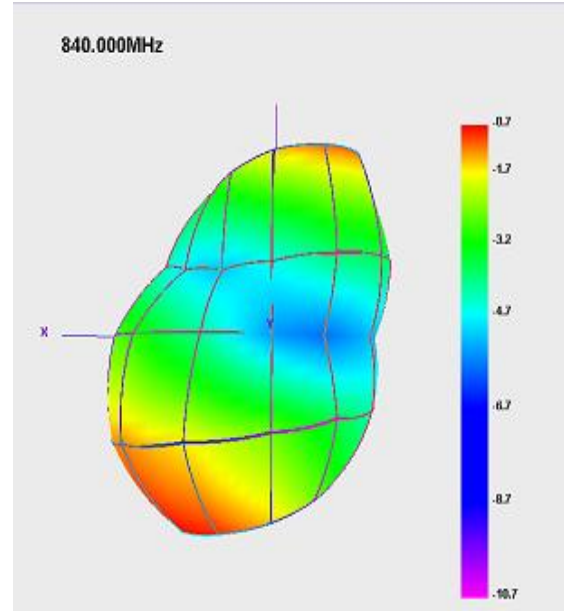
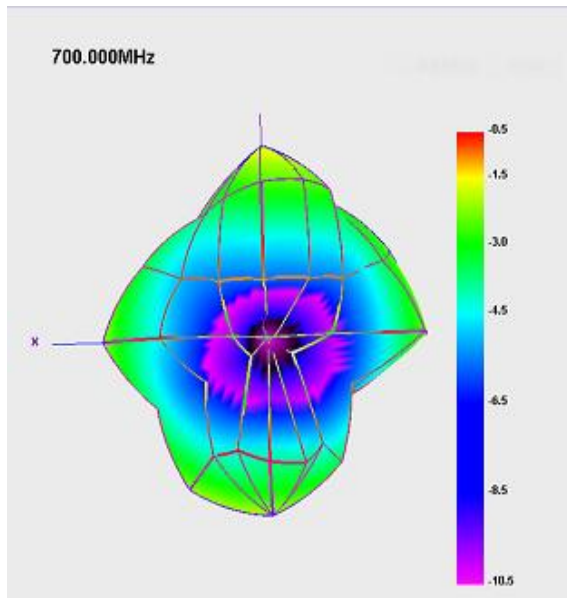

DIVERSITY ANT 3D Pattern

730.000MHz

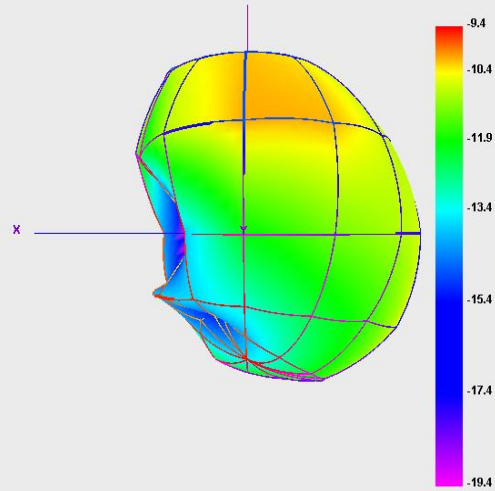

840.000MHz

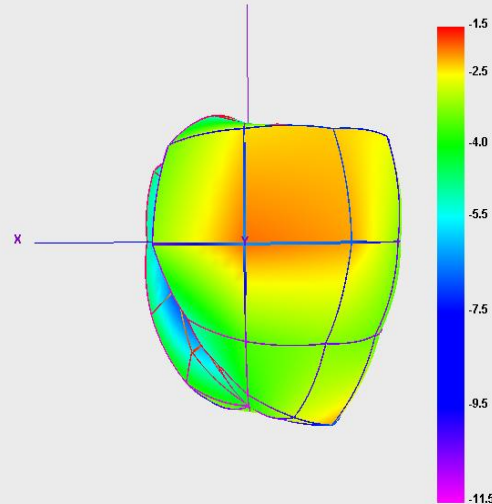

960.000MHz

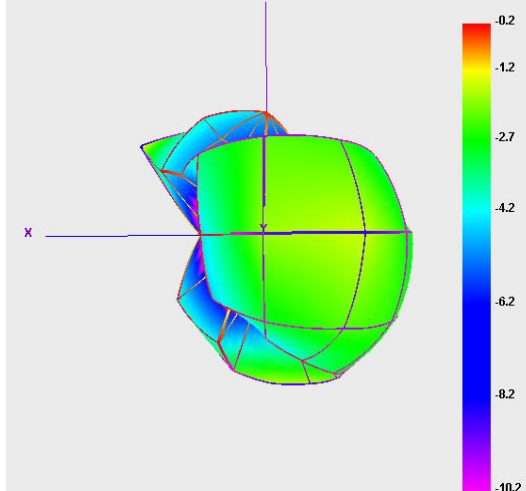

1810.000MHz

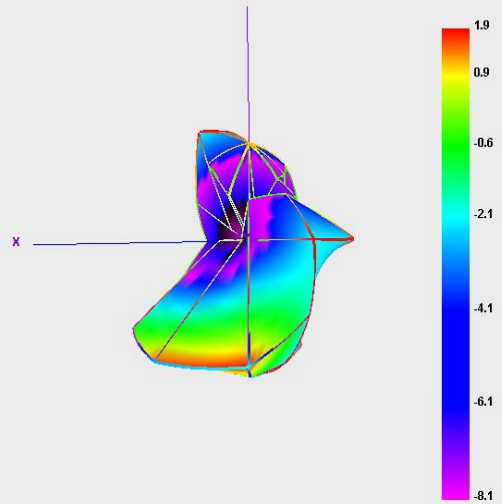

2300.000MHz

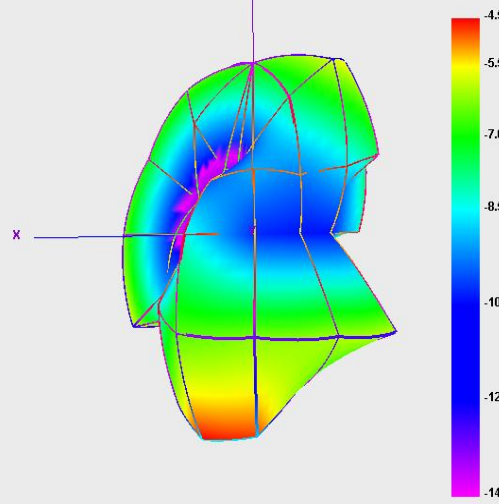

2690.000MHz

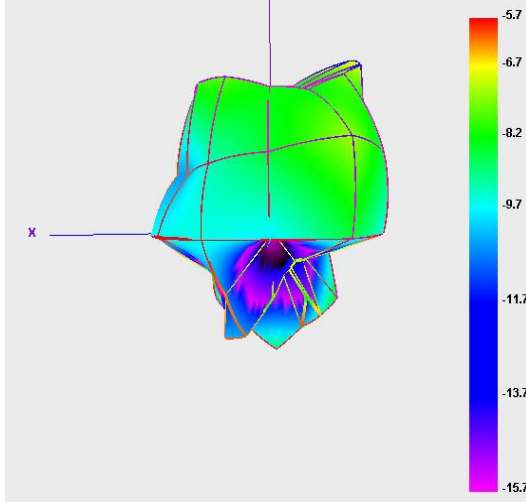

WIFI ANT 3D Pattern

1575.000MHz

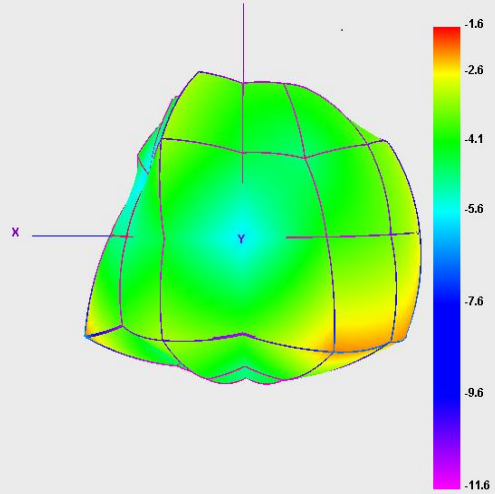

2400.000MHz

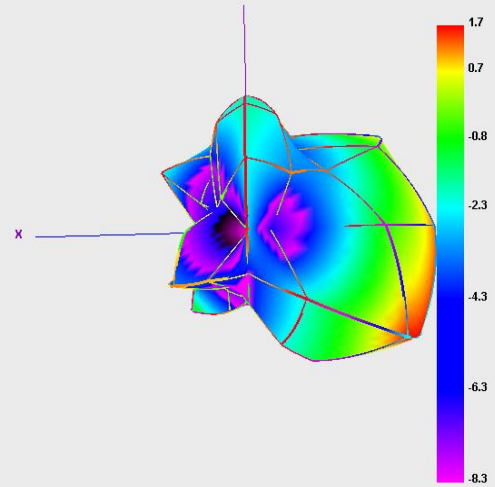

2480.000MHz

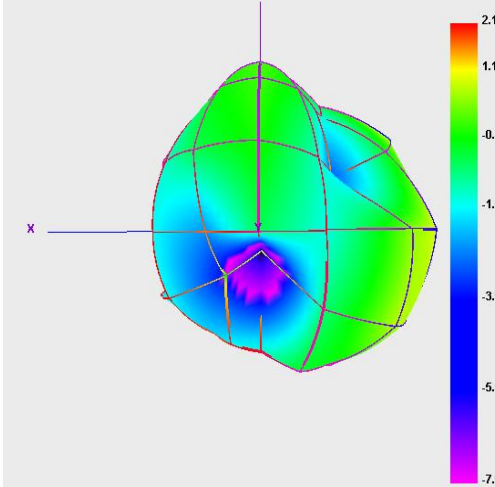

5150.000MHz

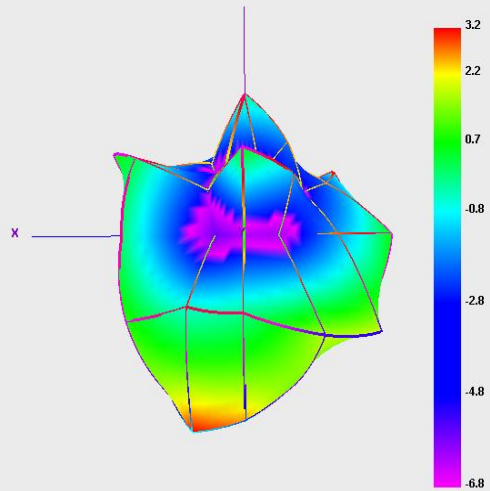

5500.000MHz

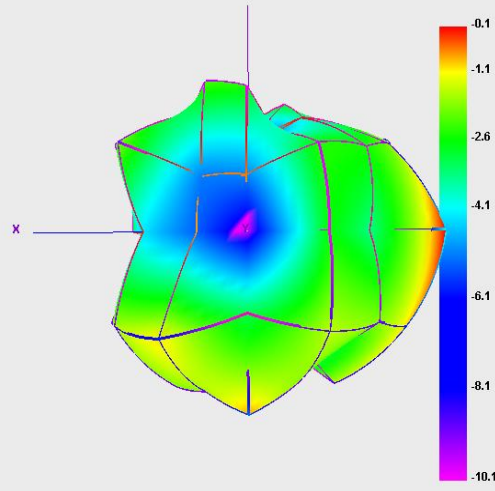

5850.000MHz

