

Industrial Internet Innovation Center (Shanghai) Co.,Ltd.**FCC/IC DFS TEST REPORT**

PRODUCT	Wireless data POS System
BRAND	SUNMI
MODEL	T5820
FCC ID	2AH25T5820C
IC	22621-T5820C
APPLICANT	Shanghai Sunmi Technology Co.,Ltd.
ISSUE DATE	February 1, 2023
STANDARD(S)	FCC Part15E, RSS-247 Issue 2, RSS-Gen Issue 5

Prepared by: *Tao Lingyan*Reviewed by: *Yang Fan*Approved by: *Zhang Min***CAUTION:**

This report shall not be reproduced except in full without the written permission of the test laboratory and shall not be quoted out of context.

CONTENTS

1. SUMMARY OF TEST REPORT	3
1.1 TEST STANDARD.....	3
1.2 REFERENCE DOCUMENT(S).....	3
1.3 SUMMARY OF TEST RESULTS.....	3
2. GENERAL INFORMATION OF THE LABORATORY	4
2.1 TESTING LABORATORY	4
2.2 LABORATORY ENVIRONMENTAL REQUIREMENTS.....	4
2.3 PROJECT INFORMATION	4
3. GENERAL INFORMATION OF THE CUSTOMER.....	5
3.1 APPLICANT	5
3.2 MANUFACTURER	5
4. GENERAL INFORMATION OF THE PRODUCT.....	6
4.1 PRODUCT DESCRIPTION FOR EQUIPMENT UNDER TEST (EUT).....	6
4.2 ADDITIONAL INFORMATION	6
5. TEST CONFIGURATION INFORMATION	7
5.1 LABORATORY ENVIRONMENTAL CONDITIONS.....	7
5.2 MEASUREMENT UNCERTAINTY	8
6. TEST REQUIREMENTS.....	9
6.1 DFS TECHNICAL REQUIREMENTS AND RADAR TEST WAVEFORMS	9
6.2 TEST SET-UP	14
7. TEST RESULTS.....	15
7.1 DFS DETECTION THRESHOLDS.....	15
7.2 IN-SERVICE MONITORING FOR CHANNEL MOVE TIME, CHANNEL CLOSING TRANSMISSION TIME AND NON-OCCUPANCY PERIOD.....	20
ANNEX A: REVISED HISTORY	26
ANNEX B: ACCREDITATION CERTIFICATE.....	27

1. Summary of Test Report

1.1 Test Standard

No.	Test Standard	Title	Version
1	FCC Part15E	Title 47 of the Code of Federal Regulations; Chapter I Part 15 - Radio frequency devices	2020

1.2 Reference Document(s)

No.	Reference	Title	Version
1	ANSI 63.10	Methods of Measurement of Radio-Noise Emissions from Low-Voltage Electrical and Electronic Equipment in the Range of 9 kHz to 40 GHz	2013
2	KDB 789033	Information Infrastructure (U-NII) Devices - Part 15, Subpart E	2017
3	KDB 905462	COMPLIANCE MEASUREMENT PROCEDURES FOR UNLICENSED-NATIONAL INFORMATION INFRASTRUCTURE DEVICES OPERATING IN THE 5250-5350 MHz AND 5470-5725 MHz BANDS INCORPORATING DYNAMIC FREQUENCY SELECTION	2016

1.3 Summary of Test Results

No.	Measurement Items	Sub-clause of Part15	Verdict
1	DFS	15.407	Pass

NOTE:

The T5820, manufactured by Shanghai Sunmi Technology Co.,Ltd. is a new product for testing.

Industrial Internet Innovation Center (Shanghai) Co., Ltd. only performed test cases which identified with Pass/Fail/Inc result in section 1.2.

Industrial Internet Innovation Center (Shanghai) Co., Ltd. has verified that the compliance of the tested device specified in section 4 of this test report is successfully evaluated according to the procedure and test methods as defined in type certification requirement listed in section 1 of this test report.

2. General Information of The Laboratory

2.1 Testing Laboratory

Lab Name	Industrial Internet Innovation Center (Shanghai) Co.,Ltd.
Address	Building 4, No. 766, Jingang Road, Pudong, Shanghai, China
Telephone	021-68866880
FCC Registration No.	958356
FCC Designation No.	CN1177
IC Designation No.	10766A

2.2 Laboratory Environmental Requirements

Temperature	15°C~35°C
Relative Humidity	25%RH~75%RH
Atmospheric Pressure	101kPa

2.3 Project Information

Project Manager	Gao Hongning
Test Date	October 20, 2022 to December 15, 2022

3. General Information of The Customer

3.1 Applicant

Company	Shanghai Sunmi Technology Co.,Ltd.
Address	Room 505, No.388, Song Hu Road, Yang Pu District, Shanghai, China
Telephone	13510126210

3.2 Manufacturer

Company	Shanghai Sunmi Technology Co.,Ltd.
Address	Room 505, No.388, Song Hu Road, Yang Pu District, Shanghai, China

4. General Information of The Product

4.1 Product Description for Equipment under Test (EUT)

Product	Wireless data POS System
Model	T5820
Marketing name	S01aa/ S06aa:October 20,2022 S11aa:December 08, 2022
Date of Receipt	S01aa/S11aa/S06aa
SN/IMEI	S01aa:860450060018328 860450060018336 S11aa:N/A S06aa: 860450060018740 860450060018757
Supported Radio Technology and Bands	GSM850/GSM900/DCS1800/PCS1900 WCDMA Band I/II/IV/V/VIII LTE Band 1/2/3/4/5/7/12/17/28/38/41 WLAN 802.11 b/g/n WLAN 802.11 a/n/ac BT5.1 BR/EDR, BLE NFC GPS/Glonass/BDS
HVIN	T5820C
Hardware Version	V01
Software Version	XQT530_V004_20220923
FCC ID	2AH25T5820C
IC	22621-T5820C

NOTE: EUT ID is the internal identification code of the laboratory.

4.2 Additional Information

Operating Frequency Range(s)	U-NII-2A(5250MHz-5350MHz) U-NII-2C(5500MHz-5700MHz)
Operating Mode	Slave without radar detection

5. Test Configuration Information

5.1 Laboratory Environmental Conditions

5.1.1 Permanent Facilities

Relative Humidity	Min. = 45 %, Max. = 57 %		
Atmospheric Pressure	101kPa		
Temperature	Normal	Minimum	Maximum
	25°C	0°C	45°C
Working Voltage of EUT	Normal	Minimum	Maximum
	7.2V	6.8V	8.4V

5.1.2 Test Equipments Utilized

The test equipment and ancillaries used are as follows.

Conducted test system

No.	Name	Model	S/N	Manufacturer	Cal. Date	Cal. Interval
1	Programmable Power Supply	Keithley 2303	4039070	Starpoint	July 12, 2022	1 Year
2	Vector Signal Generator	SMBV100A	257904	R&S	February 21, 2022	1 Year
3	Temperature box	B-TF-107C	BTF107C-201804107	Boyi	June 30, 2022	1 Year
4	Spectrum Analyzer	FSQ40	200063	R&S	October 19, 2022	1 year
5	USB Wideband Power Senser	U2021XA	MY56410009	Keysight	February 21, 2022	1 Year
6	Simultaneous Sampling DQA	U2531A	TW56183514	Agilent	March 02, 2022	1 Year
7	Vector Signal Generator	SMU200A	104684	R&S	August 23, 2022	1 Year
8	Wireless communication comprehensive tester	CMW270	100919	R&S	August 22, 2022	1 Year
9	Eagle Test Software	Eagle V3.3	N/A	ECIT	N/A	N/A

5.2 Measurement Uncertainty

Measurement Uncertainty of Channel Shutdown:

The assessed measurement uncertainty to ensure 95% confidence level for the normal distribution is with the coverage factor $K=1.96, U=2.69\text{dB}$.

Measurement Uncertainty of Radiation test

Frequency Range	Uncertainty(dB)
$30\text{MHz} \leq f \leq 2\text{GHz}$	± 4.98
$2\text{GHz} \leq f \leq 12.75\text{GHz}$	± 5.06

Measurement Uncertainty of Conducted test

Measurement Items	Range	Confidence Level	Calculated Uncertainty
Peak Output Power-Conducted	2400MHz-2480MHz	95%	0.544dB
Peak Power Spectral Density	2400MHz-2480MHz	95%	0.088dB/MHz
Occupied Bandwidth	2400MHz-2480MHz	95%	69.26kHz
Conducted Emission	30MHz-2GHz	95%	0.90dB
Conducted Emission	2GHz-3.6GHz	95%	0.88dB
Conducted Emission	3.6GHz-8GHz	95%	0.96dB
Conducted Emission	8GHz-20GHz	95%	0.94dB
Conducted Emission	20GHz-22GHz	95%	0.88dB
Conducted Emission	22GHz-26GHz	95%	0.86dB

6. Test Requirements

6.1 DFS Technical Requirements and Radar Test Waveforms

6.1.1 DFS Overview

Applicability of DFS requirements Prior to Use of a Channel

Requirement	DFS Operational mode		
	Master	Slave without radar detection	Slave with radar detection
Channel Availability Check	Required	Not required	Required (see note 2)
Off-Channel CAC (see note 1)	Required	Not required	Required (see note 2)
In-Service Monitoring	Required	Not required	Required
Channel Shutdown	Required	Required	Required
Non-Occupancy Period	Required	Not required	Required
Uniform Spreading	Required	Not required	Not required

NOTE 1: Where implemented by the manufacturer.

NOTE 2: A slave with radar detection is not required to perform a CAC or Off-Channel CAC at initial use of the channel but only after the slave has detected a radar signal on the Operating Channel by In-Service Monitoring and the Non-Occupancy Period resulting from this detection has elapsed.

6.1.2 DFS Detection Thresholds

DFS Requirement Values

Parameter	Value
Channel Availability Check Time	60 s (see note 1)
Minimum Off-Channel CAC Time	6 minutes (see note 2)
Maximum Off-Channel CAC Time	4 hours (see note 2)
Channel Move Time	10 s
Channel Closing Transmission Time	1 s
Non-Occupancy Period	30 minutes

NOTE 1: For channels whose nominal bandwidth falls completely or partly within the band 5 600 MHz to 5 650 MHz, the Channel Availability Check Time shall be 10 minutes.

NOTE 2: For channels whose nominal bandwidth falls completely or partly within the band 5 600 MHz to 5 650 MHz, the Off-Channel CAC Time shall be within the range 1 hour to 24 hours.

EIRP Spectral Density (dBm/MHz)	Value (see note 1 and note 2)
10	-62 dBm

NOTE 1: This is the level at the input of the receiver of an RLAN device with a maximum EIRP density of 10 dBm/MHz and assuming a 0 dBi receive antenna. For devices employing different EIRP spectral density and/or a different receive antenna gain G (dBi) the Radar Detection Threshold Level at the receiver input follows the following relationship: DFS Detection Threshold (dBm) = -62 + 10 * EIRP Spectral Density (dBm/MHz) + G (dBi); however the Radar Detection Threshold Level shall not be less than -64 dBm assuming a 0 dBi receive antenna gain.

NOTE 2: Slave devices with a maximum e.i.r.p. of less than 23 dBm do not have to implement radar detection unless these devices are used in fixed outdoor point to point or fixed outdoor point to multi point applications (see clause 4.2.6.1.3).

6.1.3 Radar Test Waveforms

Parameters of the reference DFS test signal

Pulse width W (μ s)	Pulse repetition frequency PRF (PPS)	Pulses per burst (PPB)
1	700	18

Parameters of radar test signals

Radar test signal # (see note 1 to note 3)	Pulse width W (μ s)		Pulse repetition frequency PRF (PPS)		Number of different PRFs	Pulses per burst for each PRF (PPB) (see note 5)
	Min	Max	Min	Max		
1	0,5	5	200	1 000	1	10 (see note 6)
2	0,5	15	200	1 600	1	15 (see note 6)
3	0,5	15	2 300	4 000	1	25
4	20	30	2 000	4 000	1	20
5	0,5	2	300	400	2/3	10 (see note 6)
6	0,5	2	400	1 200	2/3	15 (see note 6)

NOTE 1: Radar test signals #1 to #4 are constant PRF based signals. See figure D.1. These radar test signals are intended to simulate also radars using a packet based Staggered PRF. See figure D.2.

NOTE 2: Radar test signal #4 is a modulated radar test signal. The modulation to be used is a chirp modulation with a $\pm 2,5$ MHz frequency deviation which is described below.

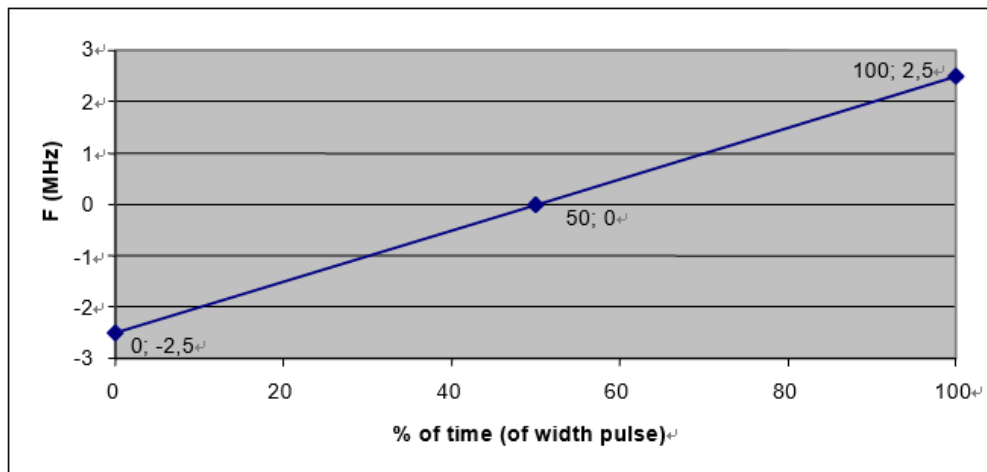

NOTE 3: Radar test signals #5 and #6 are single pulse based Staggered PRF radar test signals using 2 or 3 different PRF values. For radar test signal #5, the difference between the PRF values chosen shall be between 20 PPS and 50 PPS. For radar test signal #6, the difference between the PRF values chosen shall be between 80 PPS and 400 PPS. See figure D.3.

NOTE 4: Apart for the Off-Channel CAC testing, the radar test signals above shall only contain a single burst of pulses. See figure D.1, figure D.3 and figure D.4.

For the Off-Channel CAC testing, repetitive bursts shall be used for the total duration of the test.

See figure D.2 and figure D.5. See also clause 4.2.6.2.3, clause 5.4.8.2.1.4.2 and clause 5.4.8.2.1.4.3.

NOTE 5: The total number of pulses in a burst is equal to the number of pulses for a single PRF multiplied by the number of different PRFs used.

NOTE 6: For the CAC and Off-Channel CAC requirements, the minimum number of pulses (for each PRF)

for any of the radar test signals to be detected in the band 5 600 MHz to 5 650 MHz shall be 18.

Detection probability

Parameter	Detection Probability (P_d)	
	Channels whose nominal bandwidth falls partly or completely within the 5 600 MHz to 5 650 MHz band	Other channels
CAC, Off-Channel CAC	99,99 %	60 %
In-Service Monitoring	60 %	60 %

NOTE: P_d gives the probability of detection per simulated radar burst and represents a minimum level of detection performance under defined conditions. Therefore P_d does not represent the overall detection probability for any particular radar under real life conditions.

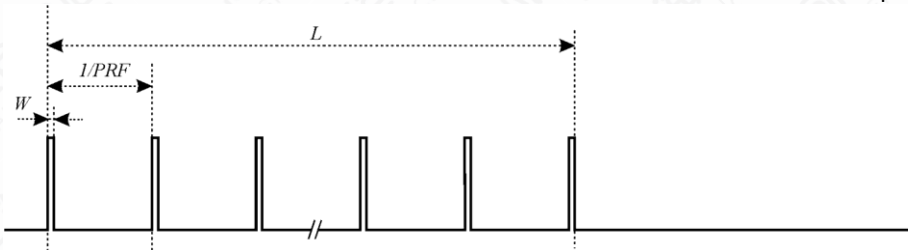

Pic 6-1: General structure of a single burst/constant PRF based radar test signal

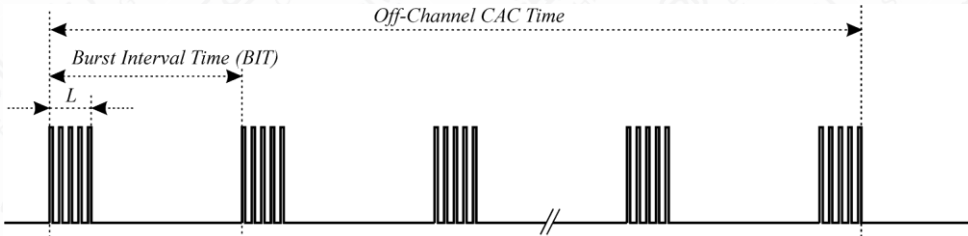

Pic 6-2: General structure of a multiple burst/constant PRF based radar test signal

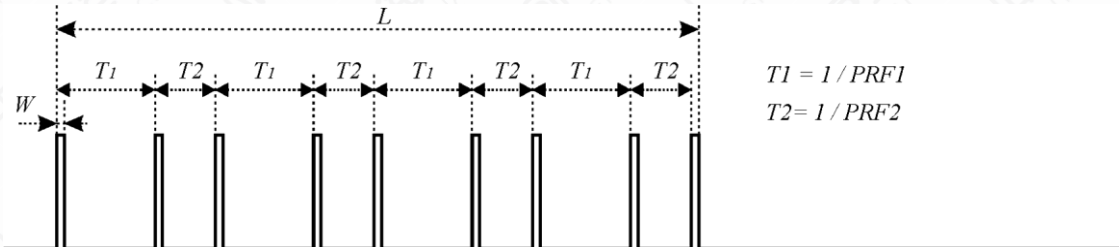

Pic 6-3: General structure of a single burst/single pulse based staggered PRF radar test signal

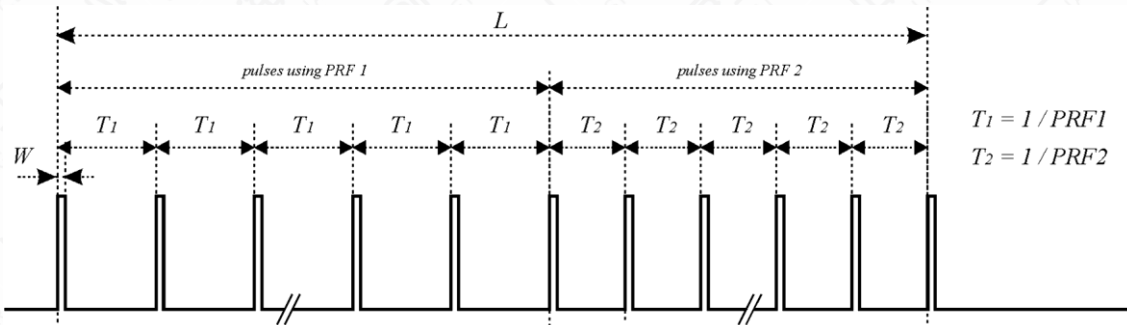

Pic 6-4: General structure of a single burst/packet based staggered PRF radar test signal

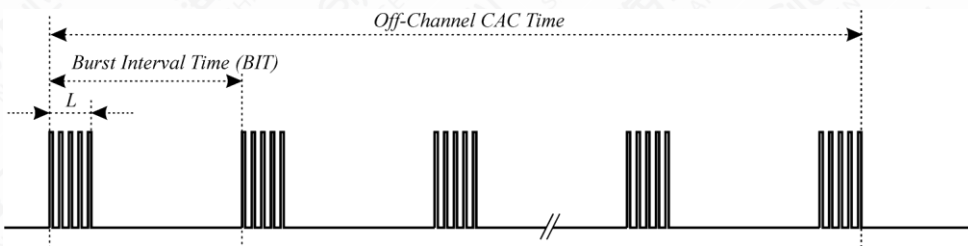

Pic 6-5: General structure of a multiple burst/packet based staggered PRF based radar test signal

6.2 Test Set-up

Set-up B is a set-up whereby the UUT is an RLAN device operating in slave mode, with or without Radar Interference Detection function. This set-up also contains an RLAN device operating in master mode. The radar test signals are injected into the master device. The UUT (slave device) is associated with the master device.

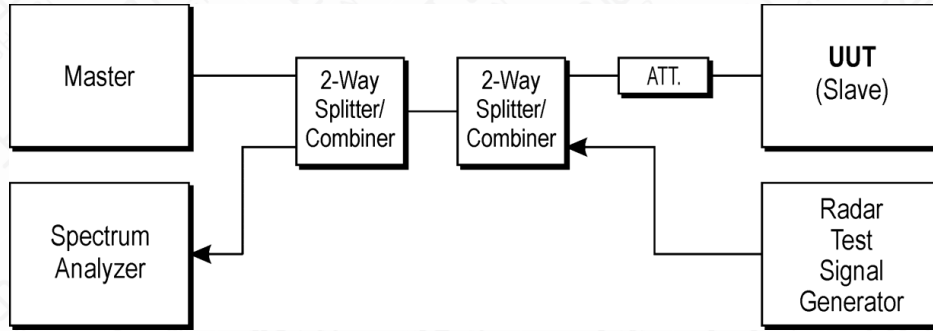

Pic 6-6: Set-up B

7. Test Results

7.1 DFS Detection Thresholds

7.1.1 Test Instructions

Radar Detection Threshold during the Channel Availability Check

- a) The signal generator and UUT are connected using Set-up A described. The power of the UUT is switched off.
- b) The UUT is powered on at T_0 . T_1 denotes the instant when the UUT has completed its power-up sequence (T_{power_up}) and is ready to start the radar detection. The Channel Availability Check on Chr is expected to commence at instant T_1 and is expected to end no sooner than $T_1 + T_{ch_avail_check}$ unless the radar test signal is detected sooner.

Additional verification may be needed to define T_1 in case it is not exactly known or indicated by the UUT.

- c) A single burst radar test signal is generated on Chr using any of the radar test signals defined in table D.4 at a level defined. This single-burst radar test signal may commence at any time within the applicable Channel Availability Check Time.

For the purpose of reducing test time, it is recommended that the single-burst radar test signal starts approximately 10 s after T_1 .

- d) It shall be recorded if the radar test signal was detected.
- e) Step c) to step d) shall be performed 20 times and each time a unique radar test signal shall be generated from options provided in table D.4. When selecting these 20 unique radar test signals, the radar test signals #1 to #6 from table D.4 shall be included as well as variations of pulse width, pulse repetition frequency and number of different PRFs (if applicable) within the ranges given. The radar test signals used shall be recorded in the report. The radar test signal shall be detected at least 12 times out of the 20 trials in order to comply with the detection probability specified for this frequency range in table D.5.

Where the declared channel plan includes channels whose nominal bandwidth falls completely or partly within the 5 600 MHz to 5 650 MHz band, additional testing as described in the steps below shall be performed on a channel within this band.

- f) A single burst radar test signal is generated on Chr using any of the radar test signals defined in table D.4 (except signals #3 and #4) at a level of 10 dB above the level defined. This single burst radar test signal may commence at any time within the applicable Channel Availability Check Time.

For the purpose of reducing test time, it is recommended that the single burst radar test signal starts approximately 10 s after T_1 .

- g) Step f) shall be performed 20 times, each time a different radar test signal shall be generated from options provided in table D.4 (except signals #3 and #4). The radar test signals used shall be recorded in the report. The radar test signal shall be detected during each of these tests and this shall be recorded.

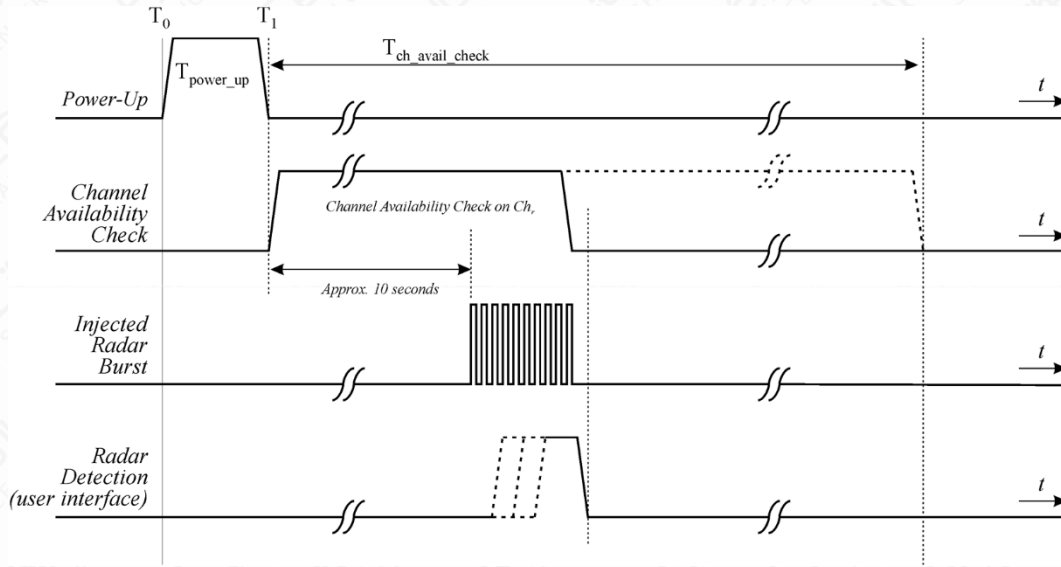

Pic 6-7: Example of timing for radar testing during the Channel Availability Check

Radar Detection Threshold during the In-Service Monitoring

- When the UUT is a master device, a slave device will be used that associates with the UUT. The signal generator and the UUT are connected using Set-up A described. When the UUT is a slave device with a Radar Interference Detection function, the UUT shall associate with a master device. The signal generator and the UUT are connected using Set-up C described.
- The UUT shall transmit a test transmission sequence in accordance with clause 5.3.1.2 on the selected channel Chr. While the testing is performed on Chr, the equipment is allowed to have simultaneous transmissions on other adjacent or non-adjacent Operating Channels.
- At a certain time T_0 , a single burst radar test signal is generated on Chr using radar test signal #1 defined in table D.4 and at a level defined. T_1 denotes the end of the radar burst.
- It shall be recorded if the radar test signal was detected.
- Step b) to step d) shall be performed 20 times, each time a random value shall be chosen for pulse width and pulse repetition frequency from the corresponding ranges provided in table D.4. For radar test signal #5 and radar test signal #6 provided in table D.4 the number of PRF values shall vary between 2 or 3. The radar test signal shall be detected at least 12 times out of the 20 trials in order to comply with the detection probability specified in table D.5.
- Step b) to step e) shall be repeated for each of the radar test signals defined in table D.4 and as described.

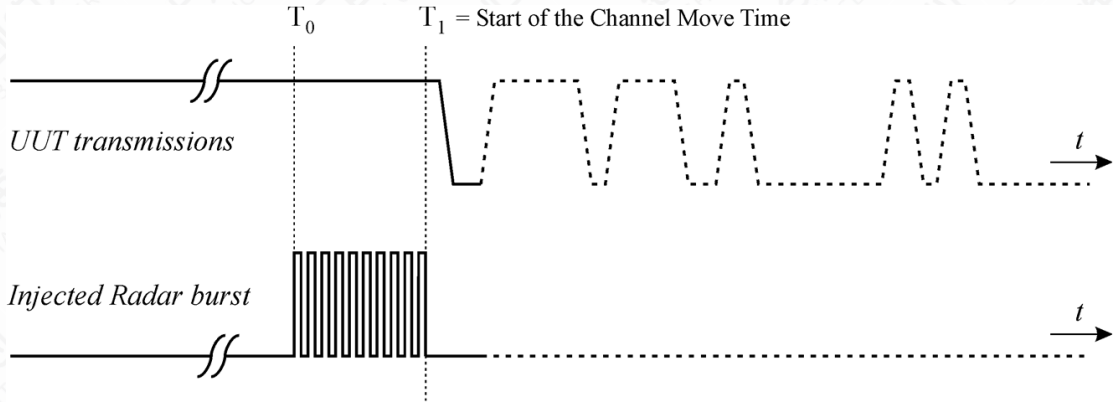

Pic 6-8: Example of timing for radar testing during the In-Service Monitoring

Frequency of Calibration	
Bandwidth	Central Frequency
20MHz	5320MHz
	5500MHz

7.1.2 The Calibration is listed below

Relative Humidity: 50%~60% at normal and high temperature.

Calibration Measurement Results:

Radar Test Waveforms

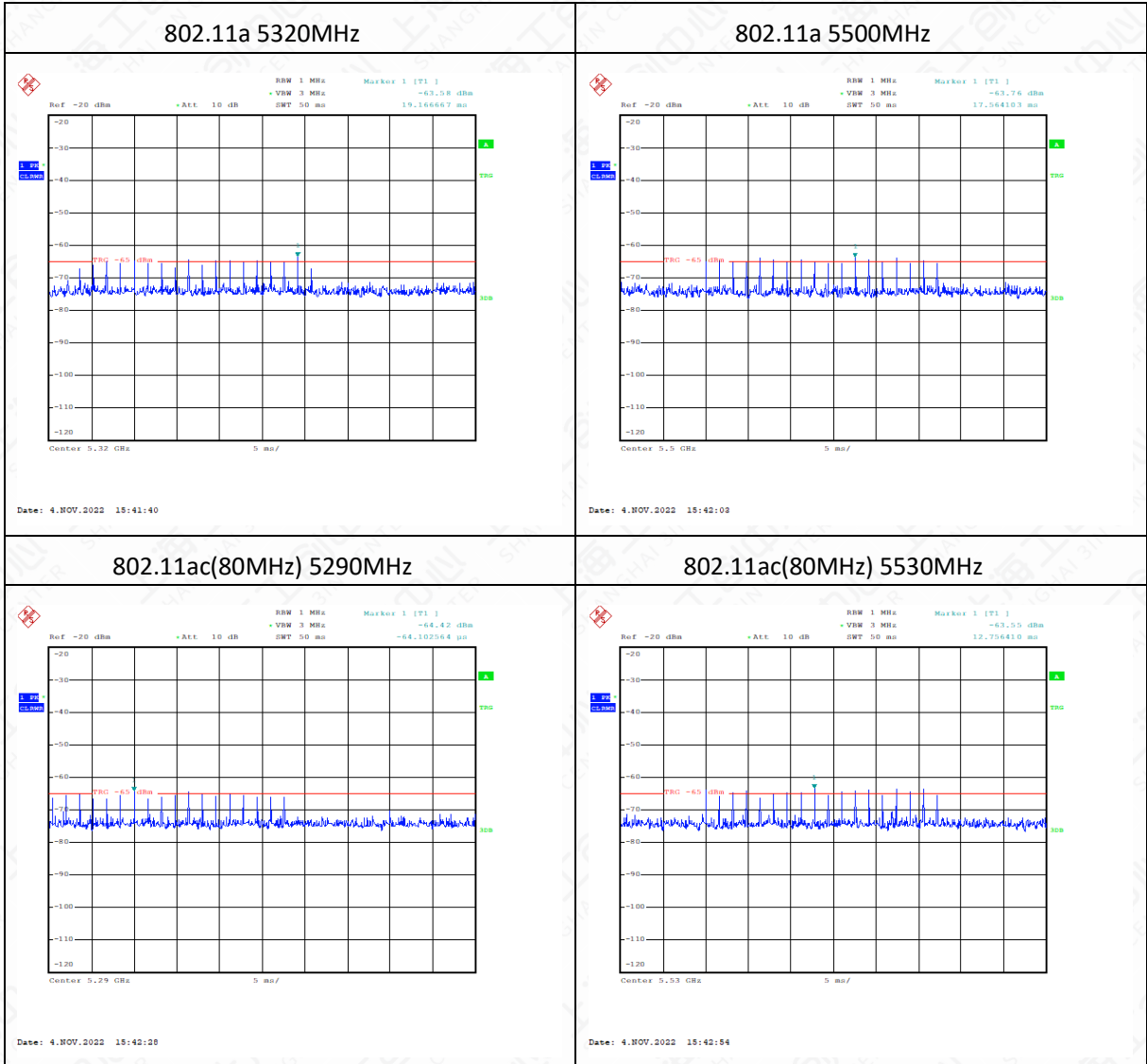

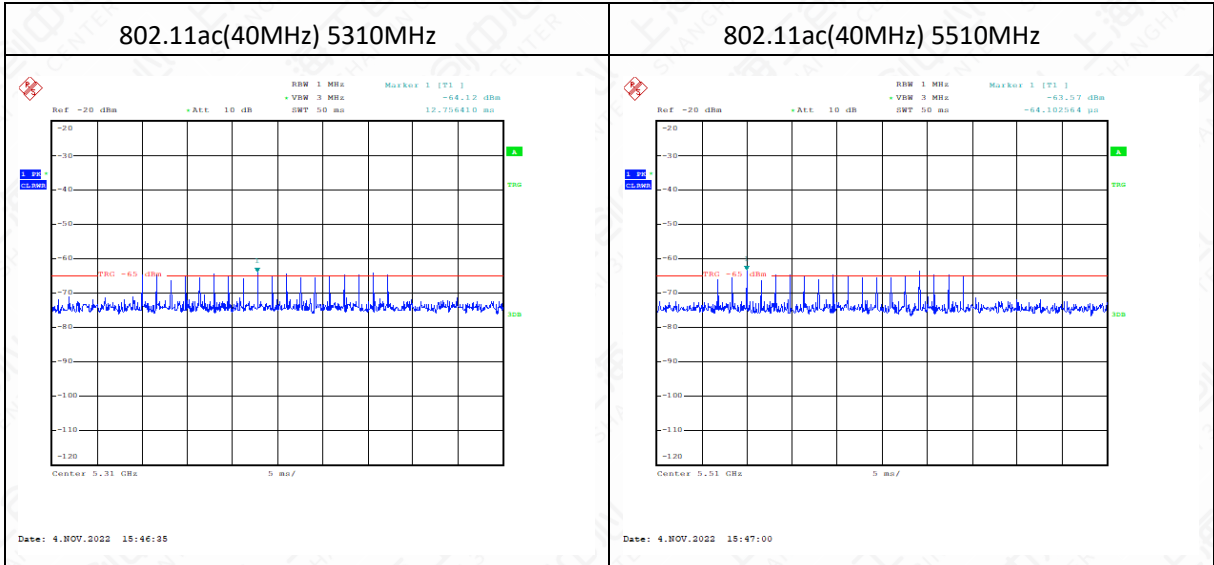

7.2 In-Service Monitoring for Channel Move Time, Channel Closing Transmission Time and Non-Occupancy Period

7.2.1 Test Instructions

Method of Measurement

These tests define how the following DFS parameters are verified during In-Service Monitoring;

Channel Closing Transmission Time

Channel Move Time

Non-Occupancy Period

The steps below define the procedure to determine the above mentioned parameters when a radar Burst with a level equal to the DFS Detection Threshold + 1dB is generated on the Operating Channel of the U-NII device (In- Service Monitoring).

- a) One frequency will be chosen from the Operating Channels of the EUT within the 5250-5350 MHz or 5470-5725 MHz bands. For 802.11 devices, the test frequency must contain control signals. This can be verified by disabling channel loading and monitoring the spectrum analyzer. If no control signals are detected, another frequency must be selected within the emission bandwidth where control signals are detected.
- b) In case the EUT is a U-NII device operating as a Client Device (with or without DFS), a U-NII device operating as a Master Device will be used to allow the EUT (Client device) to Associate with the Master Device. In case the EUT is a Master Device, a U-NII device operating as a Client Device will be used and it is assumed that the Client will Associate with the EUT (Master). In both cases for conducted tests, the Radar Waveform generator will be connected to the Master Device. For radiated tests, the emissions of the Radar Waveform generator will be directed towards the Master Device. If the Master Device has antenna gain, the main beam of the antenna will be directed toward the radar emitter.
- c) Vertical polarization is used for testing.
- d) Stream the channel loading test file from the Master Device to the Client Device on the test Channel for the entire period of the test.
- e) At time T₀ the Radar Waveform generator sends a Burst of pulses for one of the Radar Type 0 in Table 5 at levels defined in Table 3, on the Operating Channel. An additional 1 dB is added to the radar test signal to ensure it is at or above the DFS Detection Threshold, accounting for equipment variation /errors.
- f) Observe the transmissions of the EUT at the end of the radar Burst on the Operating Channel for duration greater than 10 seconds. Measure and record the transmissions from the EUT during the observation time (Channel Move Time). Measure and record the Channel Move Time and Channel Closing Transmission Time if radar detection occurs. Figure 17 illustrates Channel Closing Transmission Time.
- g) When operating as a Master Device, monitor the EUT for more than 30 minutes following instant T₂ to verify that the EUT does not resume any transmissions on this Channel. Perform this test once and record the measurement result.
- h) In case the EUT is a U-NII device operating as a Client Device with In-Service Monitoring, perform

steps 1 to 6.

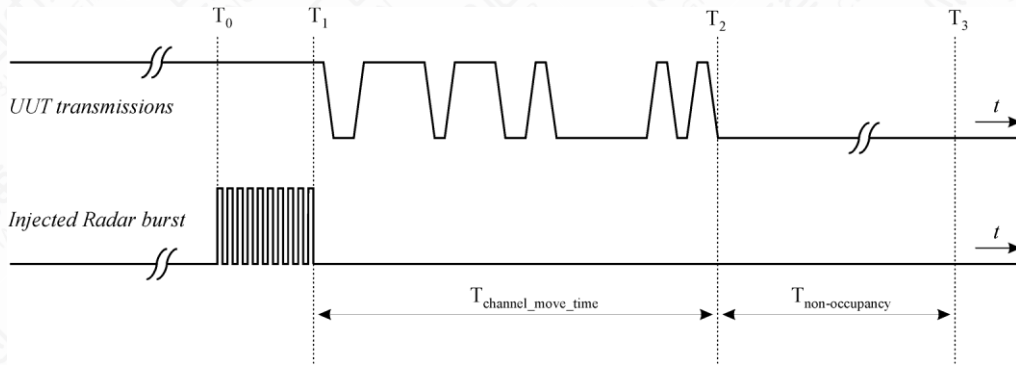

Pic 6-9: Channel Closing Transmission Time, Channel Move Time and Non-Occupancy Period

Limits:

Channel Move Time	≤10s
Channel Closing Transmission Time	≤200ms + 60ms (over remaining 10s period)
Non-Occupancy Period	≥30min

Note 1: Channel Move Time and the Channel Closing Transmission Time should be performed with Radar Type 0. The measurement timing begins at the end of the Radar Type 0 burst.

Note 2: The Channel Closing Transmission Time is comprised of 200 milliseconds starting at the beginning of the Channel Move Time plus any additional intermittent control signals required to facilitate a Channel move (an aggregate of 60 milliseconds) during the remainder of the 10 second period. The aggregate duration of control signals will not count quiet periods in between transmissions.

Note 3: The Channel Closing Transmission Time is calculated by The computer .

Method of calculation:

The Channel Closing Transmission Time=

Time to start the test and stop the transfer - The time between the start of the test and the insertion of the jamming signal.

The whole process is controlled and timed by a computer.

7.2.2 In-Service Monitoring for Channel Move Time and Channel Closing Transmission Time

Slave

802.11a

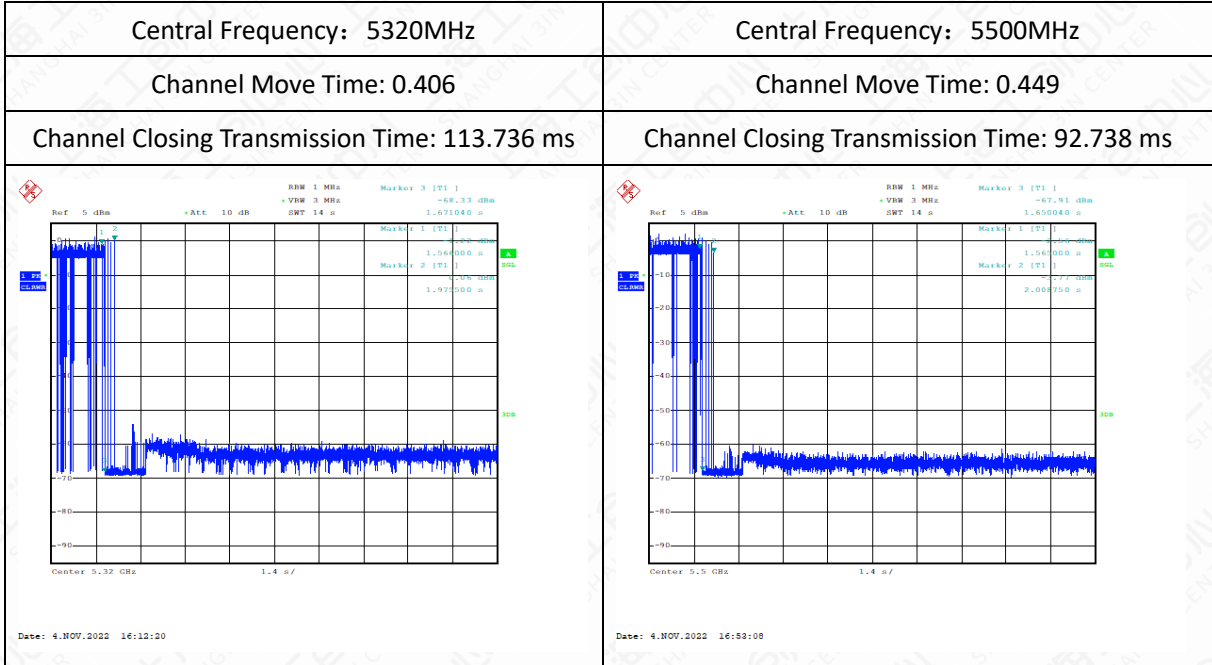

802.11ac(40MHz)

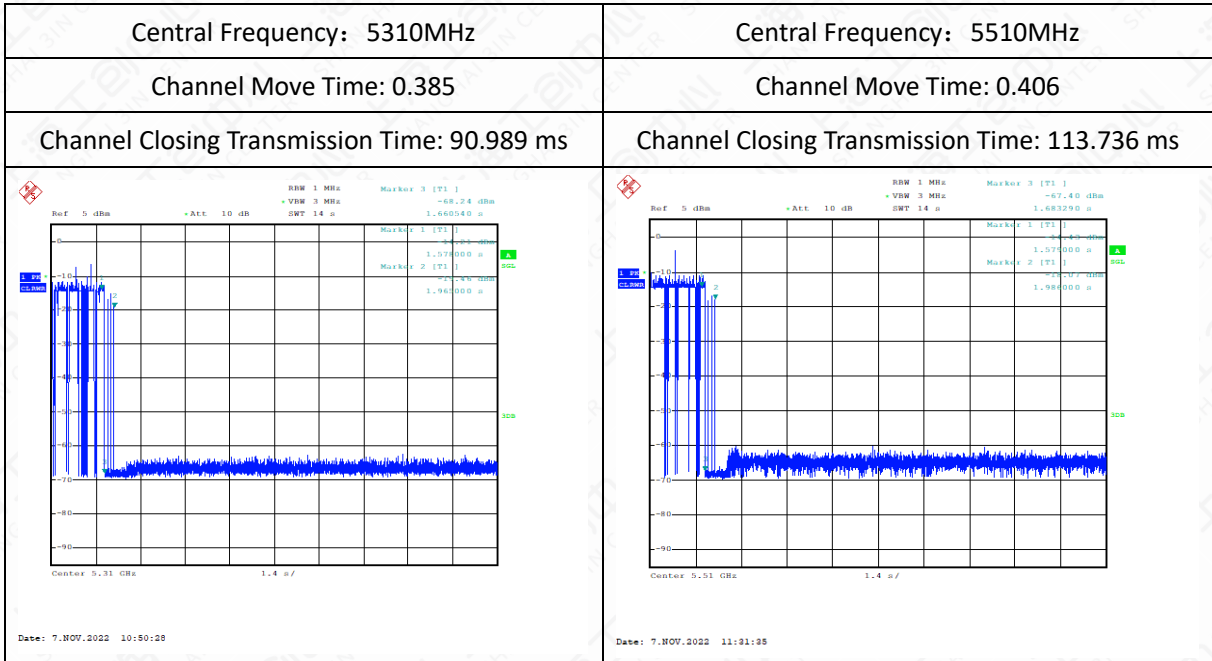

802.11ac(80MHz)

Central Frequency: 5290MHz	Central Frequency: 5530MHz
Channel Move Time: 0.409	Channel Move Time: 0.341
Channel Closing Transmission Time: 110.236 ms	Channel Closing Transmission Time: 48.994 ms

7.2.3 In-Service Monitoring for Non-Occupancy Period

802.11a

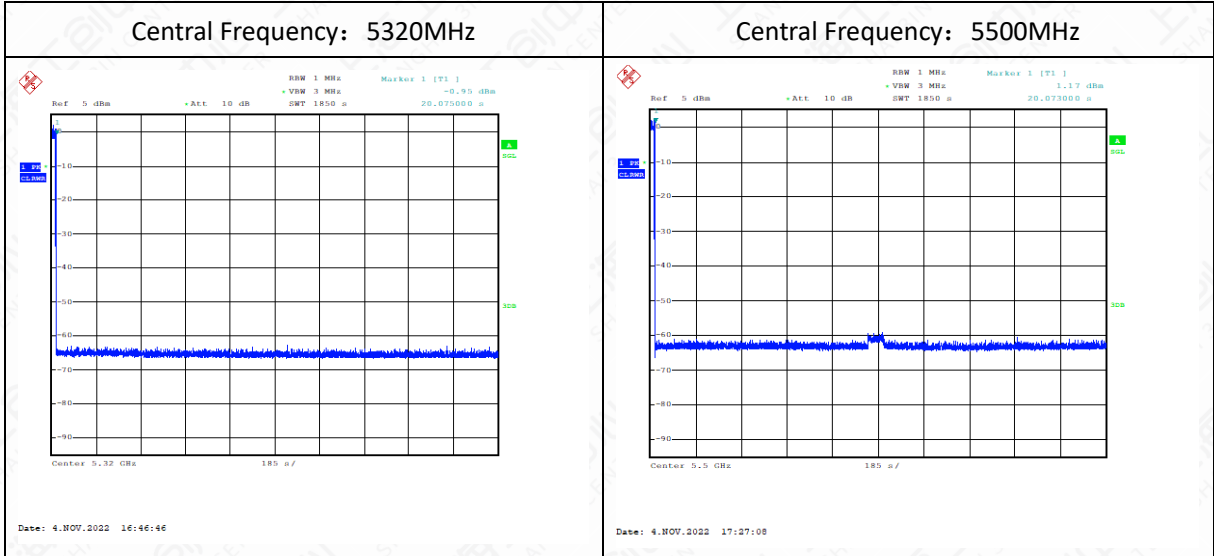

802.11ac(40MHz)

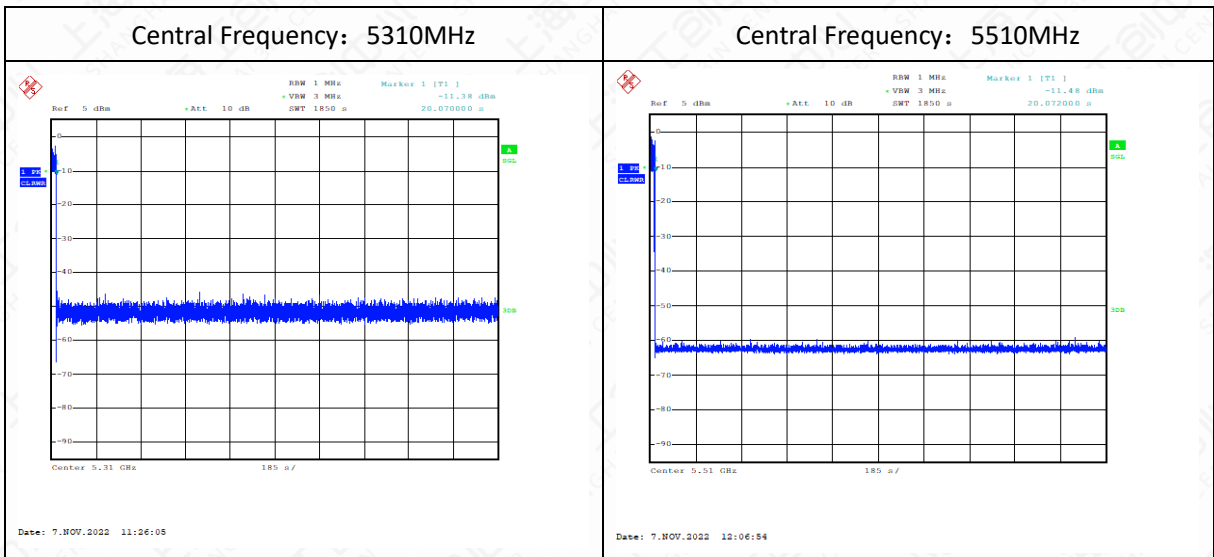

802.11ac(80MHz)

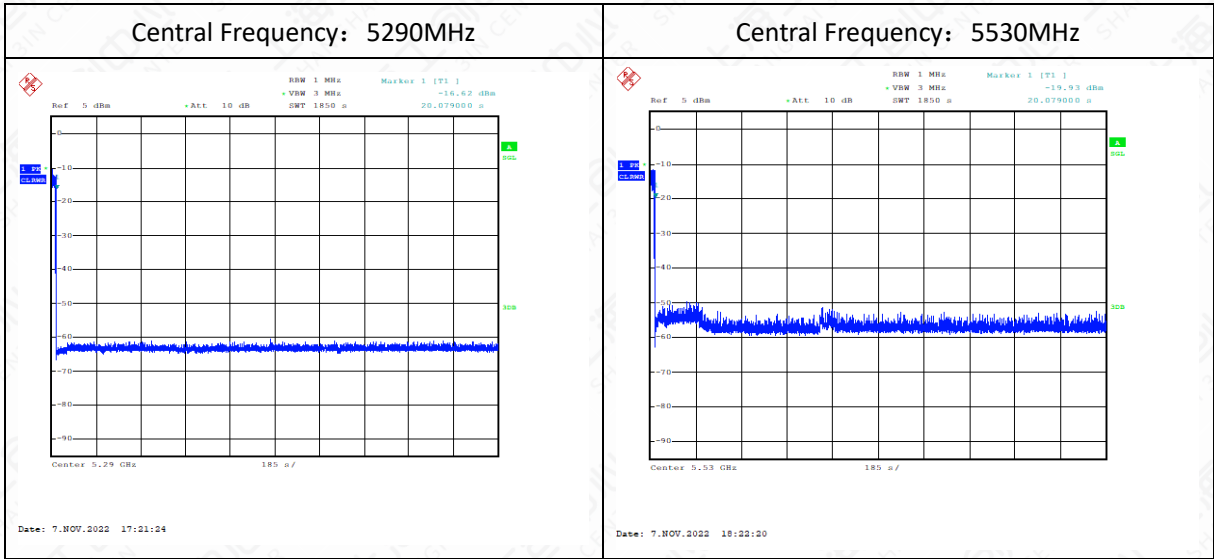

Annex A: Revised History

Version	Revised Content
V00	Initial
V01	Update the cover and section 1.

Annex B: Accreditation Certificate



Accredited Laboratory

A2LA has accredited

**INDUSTRIAL INTERNET INNOVATION CENTER
(SHANGHAI) CO., LTD.**
Shanghai, People's Republic of China

for technical competence in the field of
Electrical Testing

This laboratory is accredited in accordance with the recognized International Standard ISO/IEC 17025:2017 General requirements for the competence of testing and calibration laboratories. This accreditation demonstrates technical competence for a defined scope and the operation of a laboratory quality management system (refer to joint ISO-ILAC-IAF Communiqué dated April 2017).



Presented this 12th day of April 2021.



Vice President, Accreditation Services
For the Accreditation Council
Certificate Number 3682.01
Valid to February 28, 2023

For the tests to which this accreditation applies, please refer to the laboratory's Electrical Scope of Accreditation.

END OF REPORT