

**Industrial Internet Innovation Center (Shanghai) Co.,Ltd.****FCC/IC 2.4G WIFI TEST REPORT**

<b>PRODUCT</b>	Wireless data POS System
<b>BRAND</b>	SUNMI
<b>MODEL</b>	T5820
<b>FCC ID</b>	2AH25T5820C
<b>IC</b>	22621-T5820C
<b>APPLICANT</b>	Shanghai Sunmi Technology Co.,Ltd.
<b>ISSUE DATE</b>	January 31, 2023
<b>STANDARD(S)</b>	FCC Part15, RSS-247 Issue 2, RSS-Gen Issue 5

Prepared by: *Tao Lingyan*Reviewed by: *Yang Fan*Approved by: *Zhang Min***CAUTION:**

*This report shall not be reproduced except in full without the written permission of the test laboratory and shall not be quoted out of context.*

## CONTENTS

<b>1. SUMMARY OF TEST REPORT .....</b>	<b>3</b>
1.1 TEST STANDARD(S) .....	3
1.2 REFERENCE DOCUMENTS.....	3
1.3 SUMMARY OF TEST RESULTS.....	3
1.4 DATA PROVIDED BY APPLICANT.....	4
<b>2. GENERAL INFORMATION OF THE LABORATORY .....</b>	<b>5</b>
2.1 TESTING LABORATORY .....	5
2.2 LABORATORY ENVIRONMENTAL REQUIREMENTS.....	5
2.3 PROJECT INFORMATION .....	5
<b>3. GENERAL INFORMATION OF THE CUSTOMER.....</b>	<b>6</b>
3.1 APPLICANT .....	6
3.2 MANUFACTURER .....	6
<b>4. GENERAL INFORMATION OF THE PRODUCT.....</b>	<b>7</b>
4.1 PRODUCT DESCRIPTION FOR EQUIPMENT UNDER TEST (EUT).....	7
4.2 INTERNAL IDENTIFICATION OF AE USED DURING THE TEST.....	7
4.3 ADDITIONAL INFORMATION .....	7
<b>5. TEST CONFIGURATION INFORMATION .....</b>	<b>9</b>
5.1 LABORATORY ENVIRONMENTAL CONDITIONS.....	9
5.2 TEST EQUIPMENTS UTILIZED.....	9
5.3 MEASUREMENT UNCERTAINTY .....	11
<b>6. TEST RESULTS .....</b>	<b>12</b>
6.1 OUTPUT POWER-CONDUCTED .....	12
6.2 PEAK POWER SPECTRAL DENSITY .....	16
6.3 OCCUPIED 6dB BANDWIDTH.....	20
6.4 99% OCCUPIED BANDWIDTH.....	23
6.5 BAND EDGES COMPLIANCE.....	26
6.6 TRANSMITTER SPURIOUS EMISSION-CONDUCTED.....	28
6.7 TRANSMITTER SPURIOUS EMISSION-RADIATED .....	32
6.8 AC POWERLINE CONDUCTED EMISSION .....	47
<b>ANNEX A: REVISED HISTORY .....</b>	<b>50</b>
<b>ANNEX B: ACCREDITATION CERTIFICATE.....</b>	<b>51</b>

## 1. Summary of Test Report

### 1.1 Test Standard(s)

No.	Test Standard(s)	Title	Version
1	FCC Part15	FCC CFR 47, Part 15, Subpart C: 15.205 Restricted bands of operation; 15.209 Radiated emission limits, general requirements; 15.247 Operation within the bands 902-928MHz, 2400-2483.5MHz, and 5725-5850MHz.	2020
2	RSS-247 Issue 2	Digital Transmission Systems (DTSS), Frequency Hopping Systems (FHSs) and Licence-Exempt Local Area Network (LE-LAN) Devices	2017
3	RSS-Gen Issue 5	General Requirements for Compliance of Radio Apparatus	2021

### 1.2 Reference Documents

No.	Reference	Title	Version
1	ANSI C63.10	American National Standard of Procedures for Compliance Testing of Unlicensed Wireless Devices	2013
2	KDB 558074	Guidance for Performing Compliance Measurements on Frequency Hopping Spread Spectrum systems (DSS) Operating Under §15.247	2019

### 1.3 Summary of Test Results

Measurement Items	Sub-clause of Part15C	Sub-clause of IC	Verdict
Maximum Peak Output Power	15.247(b)	RSS-247 5.4	Pass
Peak Power Spectral Density	15.247(e)	RSS-247 5.2	Pass
6dB Occupied Bandwidth	15.247(a)	RSS-247 5.2	Pass
99% Occupied Bandwidth	15.247(a)	RSS-Gen 6.7	Pass
Band Edges Compliance	15.247(d)	RSS-247 5.5	Pass
Transmitter Spurious Emission-Conducted	15.247(d)	RSS-247 5.5	Pass
Transmitter Spurious Emission-Radiated	15.247/15.205/15.209	RSS-Gen 8.9,8.10	Pass
AC Powerline Conducted Emission	15.207	RSS-Gen 8.8	Pass

**Note:**

The T5820, manufactured by Shanghai Sunmi Technology Co.,Ltd. is a new product for testing.

The product's Band 41 uses only 2535-2655 MHZ.

Industrial Internet Innovation Center (Shanghai) Co., Ltd. only performed test cases which identified with Pass/Fail/Inc result in section 1.

Industrial Internet Innovation Center (Shanghai) Co., Ltd. has verified that the compliance of the tested device specified in section 1.3 of this test report is successfully evaluated according to the procedure and test methods as defined in type certification requirement listed in section 4 of this test report.

**1.4 Data Provided by Applicant**

No.	Item(s)	Data
1	Antenna gain of EUT	2.27 dBi

Note: The data of 1.4 is provided by the customer may affect the validity of the test results in this report, and the impact and consequences of this shall be undertaken by the customer.

## 2. General Information of The Laboratory

### 2.1 Testing Laboratory

Lab Name	Industrial Internet Innovation Center (Shanghai) Co.,Ltd.
Address	Building 4, No. 766, Jingang Road, Pudong, Shanghai, China
Telephone	021-68866880
FCC Registration No.	958356
FCC Designation No.	CN1177
IC Designation No.	10766A

### 2.2 Laboratory Environmental Requirements

Temperature	15°C~35°C
Relative Humidity	25%RH~75%RH
Atmospheric Pressure	101kPa

### 2.3 Project Information

Project Manager	Gao Hongning
Test Date	October 20, 2022 to January 13, 2022

### 3. General Information of The Customer

#### 3.1 Applicant

Company	Shanghai Sunmi Technology Co.,Ltd.
Address	Room 505, No.388, Song Hu Road, Yang Pu District, Shanghai, China
Telephone	13510126210

#### 3.2 Manufacturer

Company	Shanghai Sunmi Technology Co.,Ltd.
Address	Room 505, No.388, Song Hu Road, Yang Pu District, Shanghai, China

## 4. General Information of The Product

### 4.1 Product Description for Equipment under Test (EUT)

Product	Wireless data POS System
Model	T5820
Date of Receipt	S01aa/ S06aa:October 20,2022 S11aa:December 08, 2022
EUT ID*	S01aa/S11aa/S06aa
SN/IMEI	S01aa:860450060018328 860450060018336 S11aa:N/A S06aa: 860450060018740 860450060018757
Supported Radio Technology and Bands	GSM850/GSM900/DCS1800/PCS1900 WCDMA Band I/II/IV/V/VIII LTE Band 1/2/3/4/5/7/12/17/28/38/41 WLAN 802.11 b/g/n WLAN 802.11 a/n/ac BT5.1 BR/EDR, BLE NFC GPS/Glonass/BDS
HVIN	T5820C
Hardware Version	V01
Software Version	XQT530_V004_20220923
FCC ID	2AH25T5820C
IC	22621-T5820C
NOTE: EUT ID is the internal identification code of the laboratory.	

### 4.2 Internal Identification of AE used during the test

AE ID*	Description	Model	SN/Remark
AE1	RF Cable	N/A	N/A
NOTE: AE ID is the internal identification code of the laboratory.			

### 4.3 Additional Information

WLAN Frequency	2412MHz-2472MHz
----------------	-----------------

Occupied Channel Bandwidth	CH1-13
WLAN type of modulation	802.11b: DSSS 802.11g/n: OFDM



## 5. Test Configuration Information

### 5.1 Laboratory Environmental Conditions

#### 5.1.1 Permanent Facilities

Relative Humidity	Min. = 45 %, Max. = 55 %		
Atmospheric Pressure	101kPa		
Temperature	Normal	Minimum	Maximum
	25°C	0°C	45°C
Working Voltage of EUT	Normal	Minimum	Maximum
	7.2V	6.8V	8.4V

### 5.2 Test Equipments Utilized

#### 5.2.1 Conducted Test System

No.	Name	Model	S/N	Manufacturer	Cal. Date	Cal. Interval
1	Programmable Power Supply	Keithley 2303	4039070	Starpoint	July 12, 2022	1 Year
2	Vector Signal Generator	SMBV100A	257904	R&S	February 21, 2022	1 Year
3	Temperature box	B-TF-107C	BTF107C-201804107	Boyi	June 30, 2022	1 Year
4	Spectrum Analyzer	FSQ40	200063	R&S	October 19, 2022	1 year
5	USB Wideband Power Sensor	U2021XA	MY56410009	Keysight	February 21, 2022	1 Year
6	Simultaneous Sampling DQA	U2531A	TW56183514	Agilent	March 02, 2022	1 Year
7	Vector Signal Generator	SMU200A	104684	R&S	August 22, 2022	1 Year
8	Wireless communication comprehensive tester	CMW270	100919	R&S	August 22, 2022	1 Year
9	Eagle Test Software	Eagle V3.3	N/A	ECIT	N/A	N/A
10	Talent Microwave Band Rejection Filter	Filter	191016001	N/A	N/A	N/A

### 5.2.2 Radiated Emission Test System

No.	Name	Model	S/N	Manufacturer	Cal. Date	Cal. Interval
1	Universal Radio Communication Tester	CMU200	123123	R&S	October 17,2022	1Year
2	Universal Radio Communication Tester	CMW500	104178	R&S	October 17,2022	1Year
3	EMI Test Receiver	ESU40	100307	R&S	February 23, 2022	1 Year
4	TRILOG Broadband Antenna	VULB9163	VULB9163-515	Schwarzbeck	March 11, 2022	1 Year
5	Double- ridged Waveguide Antenna	ETS-3117	00135890	ETS	March 9, 2022	2 Years
6	2-Line V-Network	ENV216	101380	R&S	February 21, 2022	1 Year
7	EMI Test Software	EMC32 V9.15.00	N/A	R&S	N/A	N/A

### 5.2.3 Test Environment

**Shielding Room1** (6.0 meters×3.0 meters×2.7 meters) did not exceed following limits along the conducted RF performance testing:

Temperature	Min. = 15 °C, Max. = 35 °C
Relative humidity	Min. = 20 %, Max. = 75 %
Shielding effectiveness	> 100 dB
Ground system resistance	< 0.5 Ω
Temperature	Min. = 15 °C, Max. = 35 °C

**Control room** did not exceed following limits along the EMC testing:

Temperature	Min. = 15 °C, Max. = 35 °C
Relative humidity	Min. =30 %, Max. = 60 %
Shielding effectiveness	> 100 dB
Electrical insulation	> 10 kΩ
Ground system resistance	< 0.5 Ω

**Fully-anechoic chamber1** (9.8 meters×6.7 meters×6.7 meters) did not exceed following limits along the EMC testing:

Temperature	Min. = 15 °C, Max. = 35 °C
Relative humidity	Min. = 25 %, Max. = 75 %
Shielding effectiveness	> 100 dB
Electrical insulation	> 10 kΩ
Ground system resistance	< 0.5 Ω

VSWR	Between 0 and 6 dB, from 1GHz to 18GHz
Site Attenuation Deviation	Between -4 and 4 dB,30MHz to 1GHz
Uniformity of field strength	Between 0 and 6 dB, from 80MHz to 3000 MHz

### 5.3 Measurement Uncertainty

Item(s)	Range	Confidence Level	Calculated Uncertainty
Peak Output Power-Conducted	2412MHz-2462MHz	95%	0.544dB
Peak Power Spectral Density	2412MHz-2462MHz	95%	0.502dB
Occupied 6dB Bandwidth	2412MHz-2462MHz	95%	69.26kHz
Band Edges-Conducted	2412MHz-2462MHz	95%	0.544dB
Conducted Emission	9KHz-30MHz	95%	0.89dB
Conducted Emission	30MHz-2GHz	95%	0.90dB
Conducted Emission	2GHz-3.6GHz	95%	0.88dB
Conducted Emission	3.6GHz-8GHz	95%	0.96dB
Conducted Emission	8GHz-20GHz	95%	0.94dB
Conducted Emission	20GHz-22GHz	95%	0.88dB
Conducted Emission	22GHz-26GHz	95%	0.86dB
Transmitter Spurious Emission-Radiated	9KHz-30MHz	95%	5.66dB
Transmitter Spurious Emission-Radiated	30MHz-1000MHz	95%	4.98dB
Transmitter Spurious Emission-Radiated	1000MHz -18000MHz	95%	5.06dB
Transmitter Spurious Emission-Radiated	18000MHz -40000MHz	95%	5.20dB
AC Power line Conducted Emission	0.15MHz-30MHz	95%	3.66 dB

## 6. Test Results

### 6.1 Output Power-Conducted

#### 6.1.1. Measurement Limit

Standard	Limit (dBm)	Limit EIRP(dBm)
FCC 47 Part 15.247(b)(3)	<30	<36
RSS-247 5.4(d)	<30	<36

#### 6.1.2. Test Procedure

The measurement is according to ANSI C63.10 clause 11.9.

1. Set span to at least 1.5 times the OBW.
2. Set RBW = 1-5% of the OBW, not to exceed 1 MHz.
3. Set VBW  $\geq 3 \times$  RBW.
4. Number of points in sweep  $\geq 2 \times$  span / RBW. (This gives bin-to-bin spacing  $\leq$  RBW/2, so that narrowband signals are not lost between frequency bins.)
5. Sweep time = auto.
6. Detector = RMS (i.e., power averaging), if available. Otherwise, use sample detector mode.
7. If transmit duty cycle < 98 %, use a sweep trigger with the level set to enable triggering only on full power pulses. The transmitter shall operate at maximum power control level for the entire duration of every sweep. If the EUT transmits continuously (i.e., with no off intervals) or at duty cycle  $\geq$  98 %, and if each transmission is entirely at the maximum power control level, then the trigger shall be set to "free run".
8. Trace average at least 100 traces in power averaging (i.e., RMS) mode. i) Compute power by integrating the spectrum across the OBW of the signal using the instrument's band power measurement function, with band limits set equal to the OBW band edges. If the instrument does not have a band power function, sum the spectrum levels (in power units) at intervals equal to the RBW extending across the entire OBW of the spectrum

#### 6.1.3. Test setup

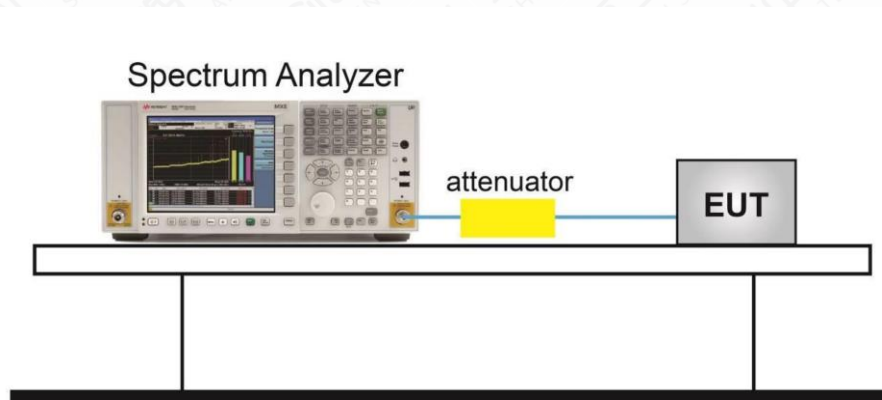

**Maximum Average Output Power-conducted**

## Measurement Results

Mode	Channel	Tx power	Conducted (dBm)	E.I.R.P.(dBm)
802.11b	1	21.5	18.03	20.3
	6	21.5	18.40	20.67
	11	21.5	17.74	20.01
802.11g	1	18	17.27	19.54
	6	21	17.47	19.74
	11	18	16.93	19.2
802.11n(20MHz)	1	18.5	16.71	18.98
	6	20.5	16.96	19.23
	11	18.5	16.42	18.69

Conclusion: PASS

## TEST PLOTS:

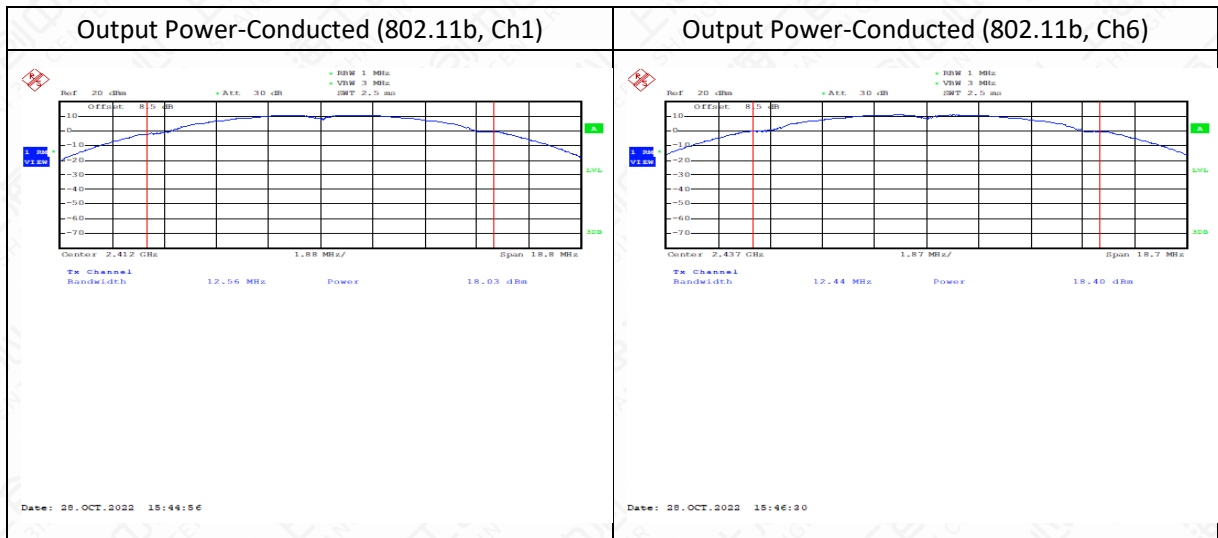



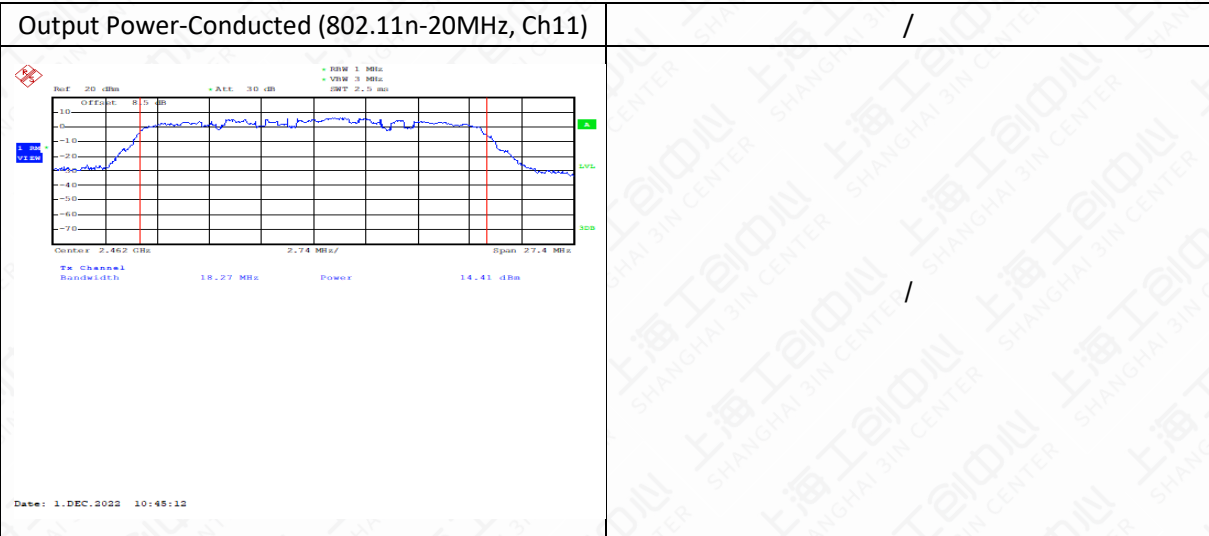

Note: Using the MTK platform software set by default by the customer.

## 6.2 Peak Power Spectral Density

### 6.2.1. Measurement Limit

Standard	Limit
FCC 47 Part 15.247(e)	$\leq 8\text{dBm}/3\text{ KHz}$
RSS-247 5.2(b)	$\leq 8\text{dBm}/3\text{ kHz}$

### 6.2.2. Test procedures

The measurement is according to ANSI C63.10 clause 11.10.

1. The output power of EUT was connected to the spectrum analyzer. The path loss was compensated to the results for each measurement.
2. Enable EUT transmitter maximum power continuously.
3. Set analyzer center frequency to DTS channel center frequency.
4. Set the span to 1.5 times the DTS bandwidth.
5. Set the RBW=3kHz
6. Set the VBW  $\geq [3 \times \text{RBW}]$ .
7. Detector = peak.
8. Sweep time = auto couple.
9. Trace mode = max hold.
10. Allow trace to fully stabilize.
11. Use the peak marker function to determine the maximum amplitude level within the RBW.
12. If measured value exceeds requirement, then reduce RBW (but no less than 3 kHz) and repeat

### 6.2.3. Test setup

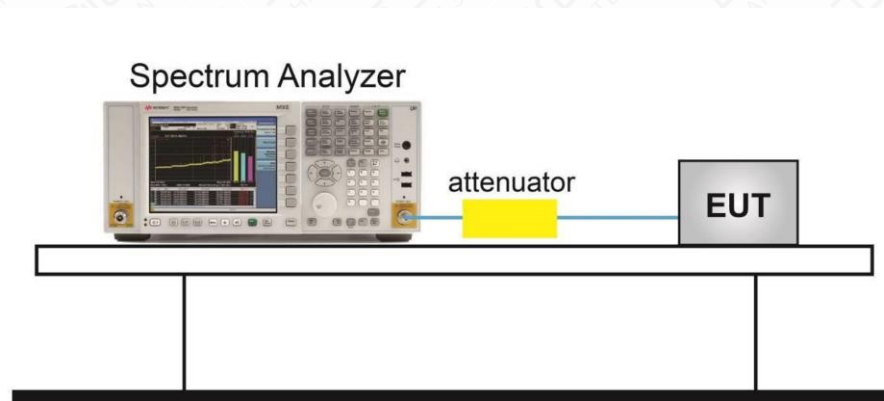



**Measurement Result**

Modulation type	Frequency (MHz)	PSD (dBm/3kHz)
802.11 b	2412	-12.86
	2437	-12.71
	2462	-13.45
802.11 g	2412	-18.08
	2437	-16.12
	2462	-18.23
802.11 n-20MHz	2412	-17.31
	2437	-16.94
	2462	-17.99

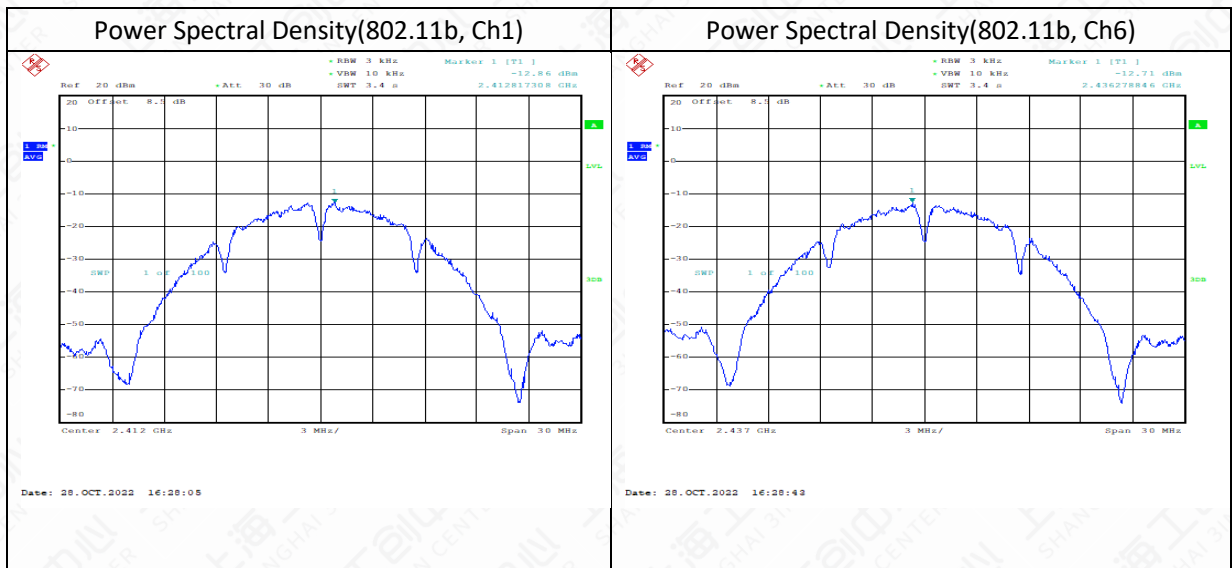

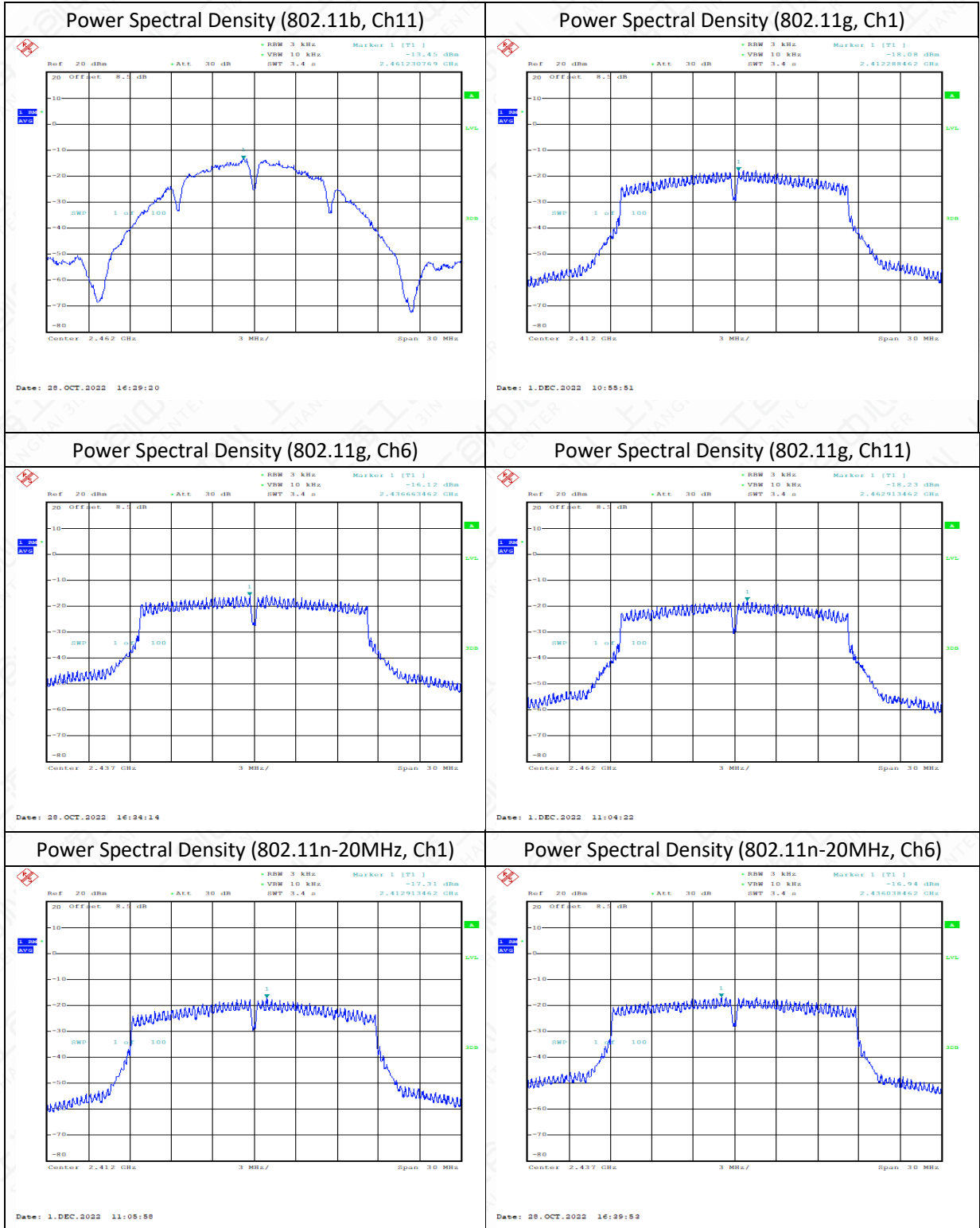

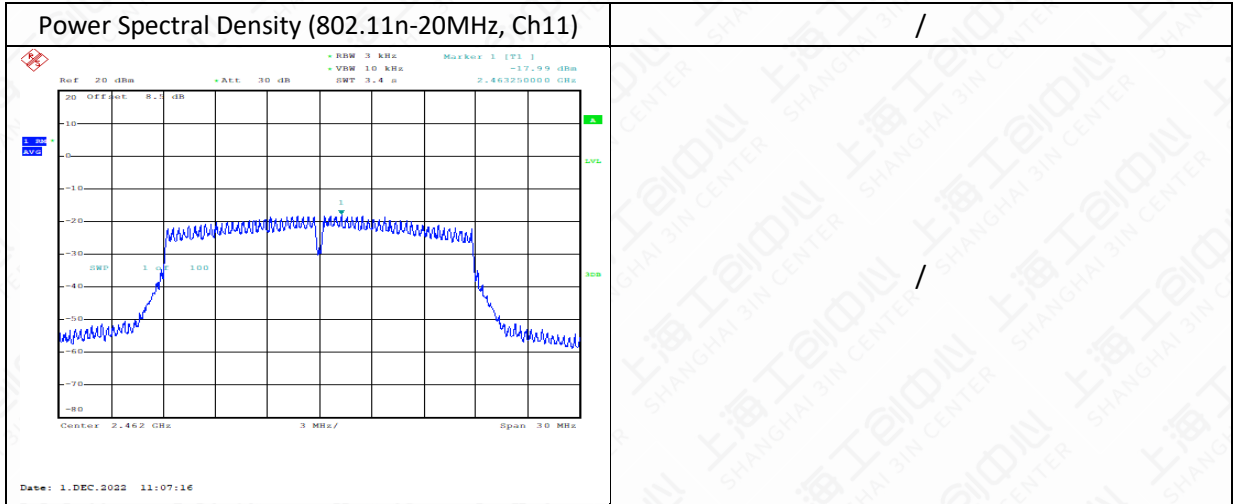

### 6.3 Occupied 6dB Bandwidth

#### 6.3.1. Measurement Limit

Standard	Limit(KHz)
FCC 47 Part 15.247(a) (2)	≥500KHz
RSS-247 5.2(a)	≥500KHz

#### 6.3.2. Test procedures

1. The output power of EUT was connected to the spectrum analyzer. The path loss was compensated to the results for each measurement.
2. Enable EUT transmitter maximum power continuously.
3. Set RBW = 100 kHz.
4. Set the VBW  $\geq [3 \times \text{RBW}]$ .
5. Detector = peak.
6. Trace mode = max hold.
7. Sweep = auto couple.
8. Allow the trace to stabilize.
9. Measure the maximum width of the emission that is constrained by the frequencies associated with the two outermost amplitude points (upper and lower frequencies) that are attenuated by 6 dB relative to the maximum level measured in the fundamental emission.

#### 6.3.3. Test Setup

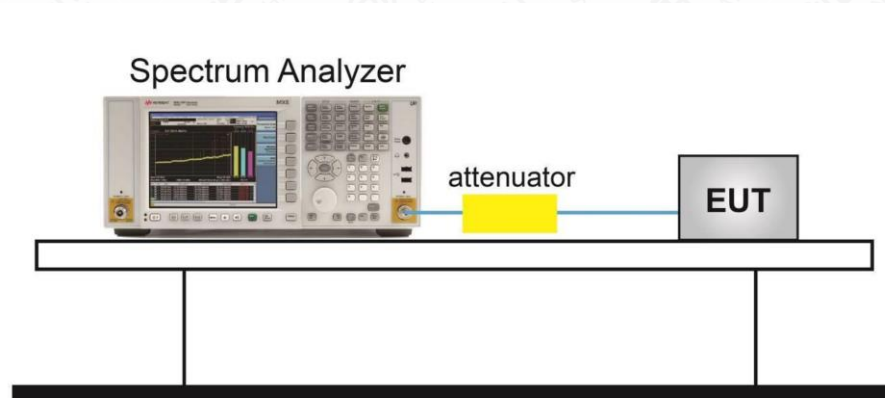

**Measurement Results**

Mode	Test Result (MHz)		
	2412MHz (Ch1)	2437MHz (Ch6)	2462MHz (Ch11)
802.11b	8.08	8.59	9.10
802.11g	15.13	15.26	15.32
802.11n(20MHz)	15.19	15.19	15.26

Conclusion: PASS

Test graphs as below

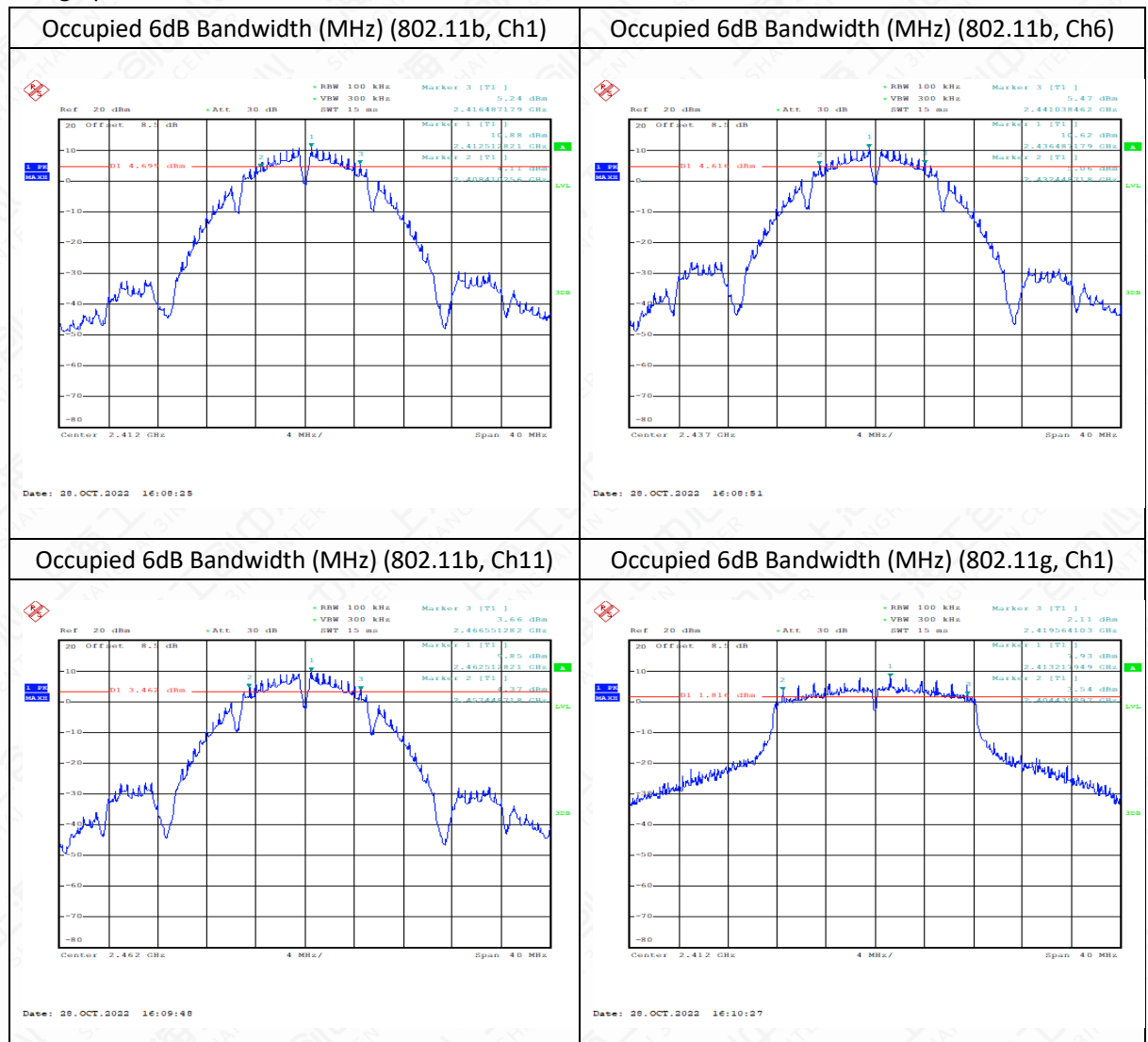

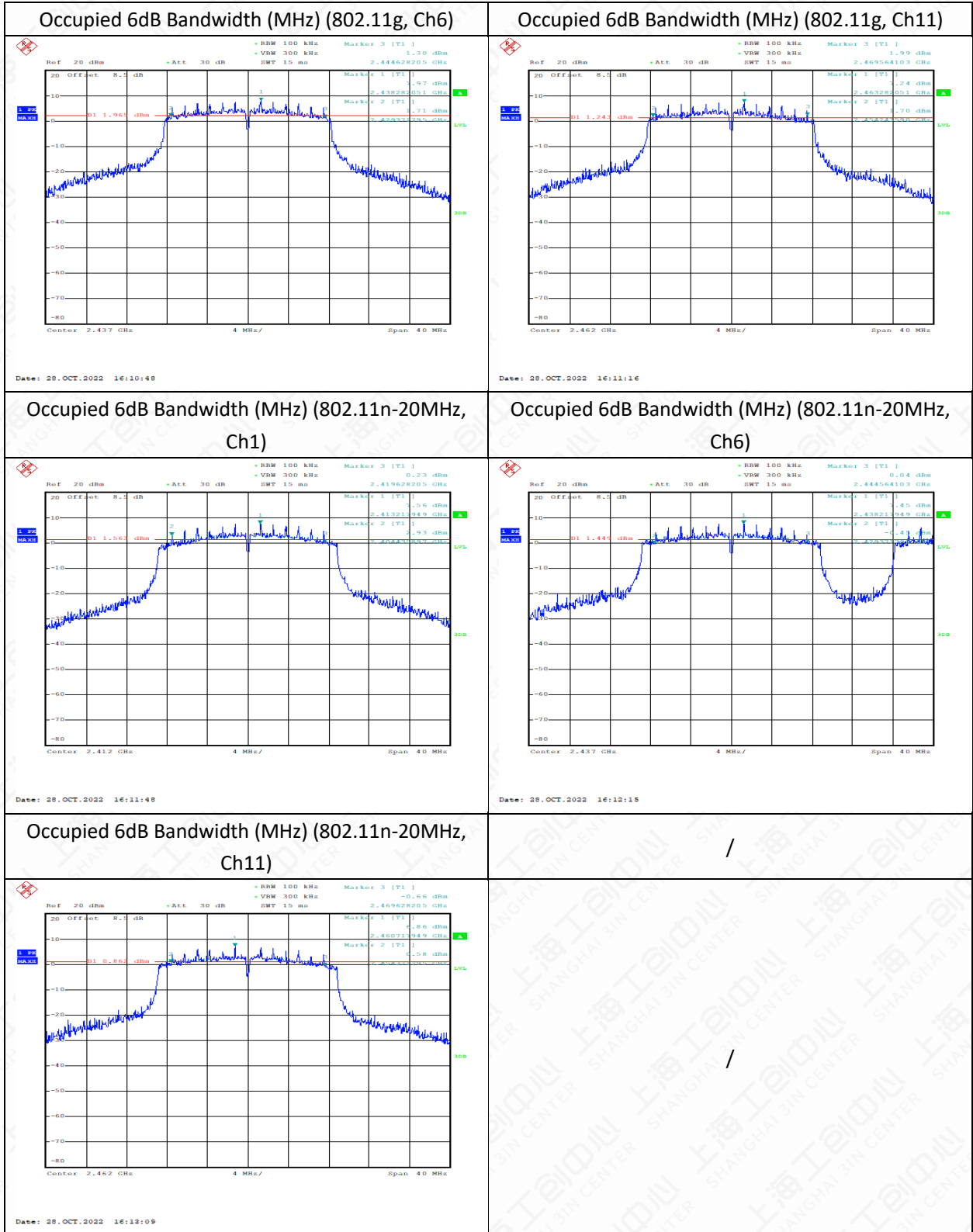

## 6.4 99% Occupied Bandwidth

### 6.4.1. Measurement Limit

Standard	Limit
RSS-Gen 6.7	N/A

### 6.4.2. Test procedures

The measurement is according to ANSI C63.10 clause 6.9.3.

1. The output power of EUT was connected to the spectrum analyzer. The path loss was compensated to the results for each measurement.
2. Enable EUT transmitter maximum power continuously.
3. Set RBW shall be in the range of 1% to 5% of the OBW.
4. Set the VBW  $\geq [3 \times \text{RBW}]$ .
5. Detector = peak.
6. Trace mode = max hold.
7. Sweep = auto couple.
8. Allow the trace to stabilize.
9. The occupied bandwidth is the frequency bandwidth such that, below its lower and above its upper frequency limits, the mean powers are each equal to 0.5% of the total mean power of the given emission.

### 6.4.3. Test setup

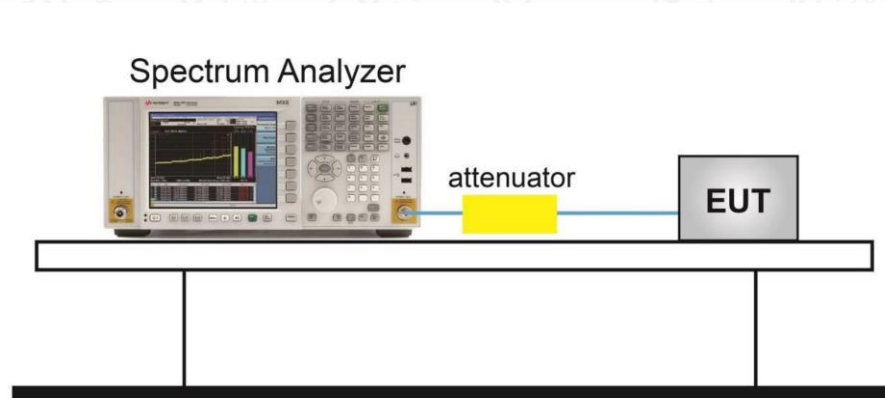

**Measurement Result**

Mode	Test Result (MHz)		
	2412MHz (Ch1)	2437MHz (Ch6)	2462MHz (Ch11)
802.11b	13.526	13.974	13.974
802.11g	16.987	17.500	17.500
802.11n-20MHz	17.885	18.269	18.269

Conclusion: PASS

Test graphs as below

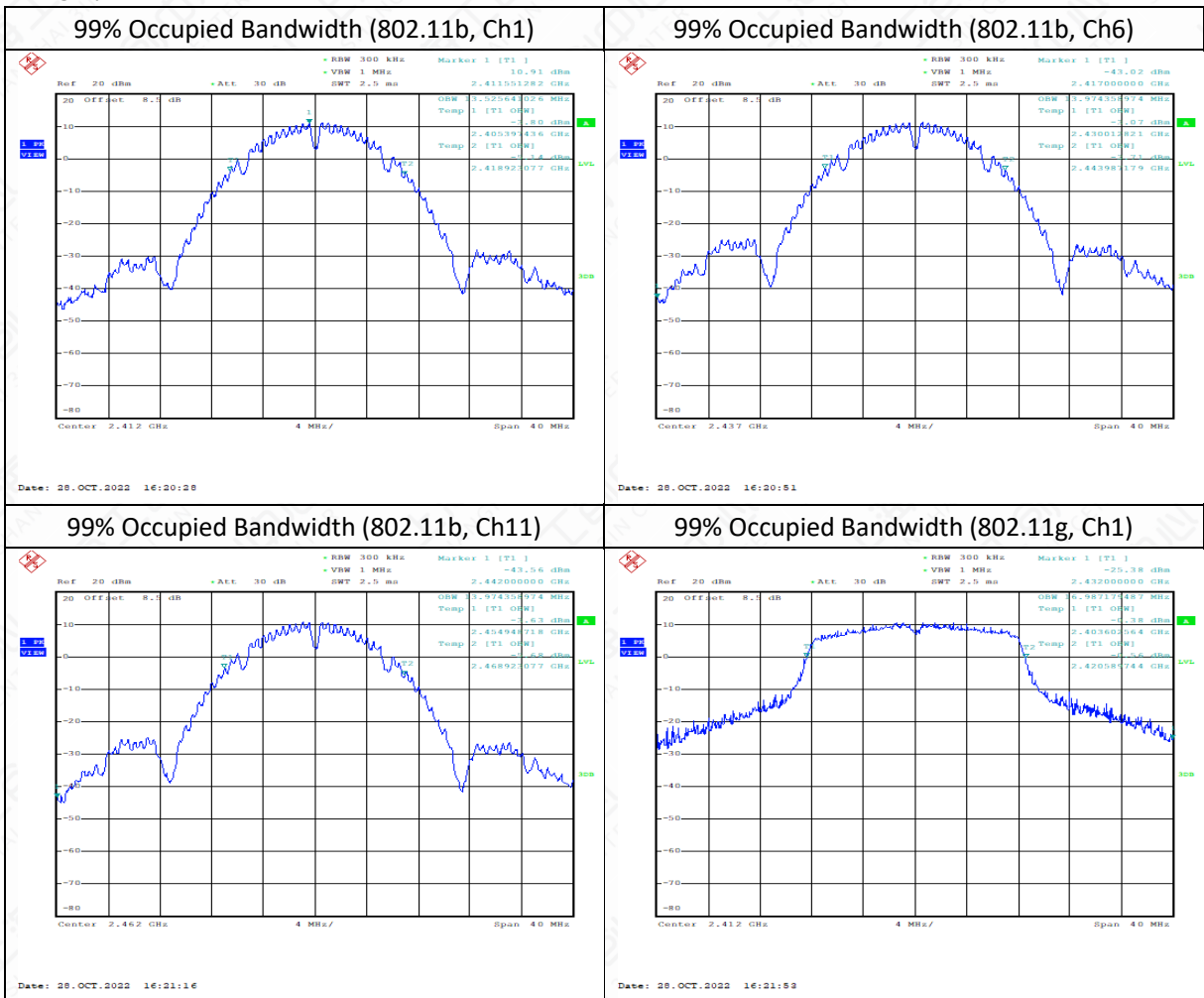



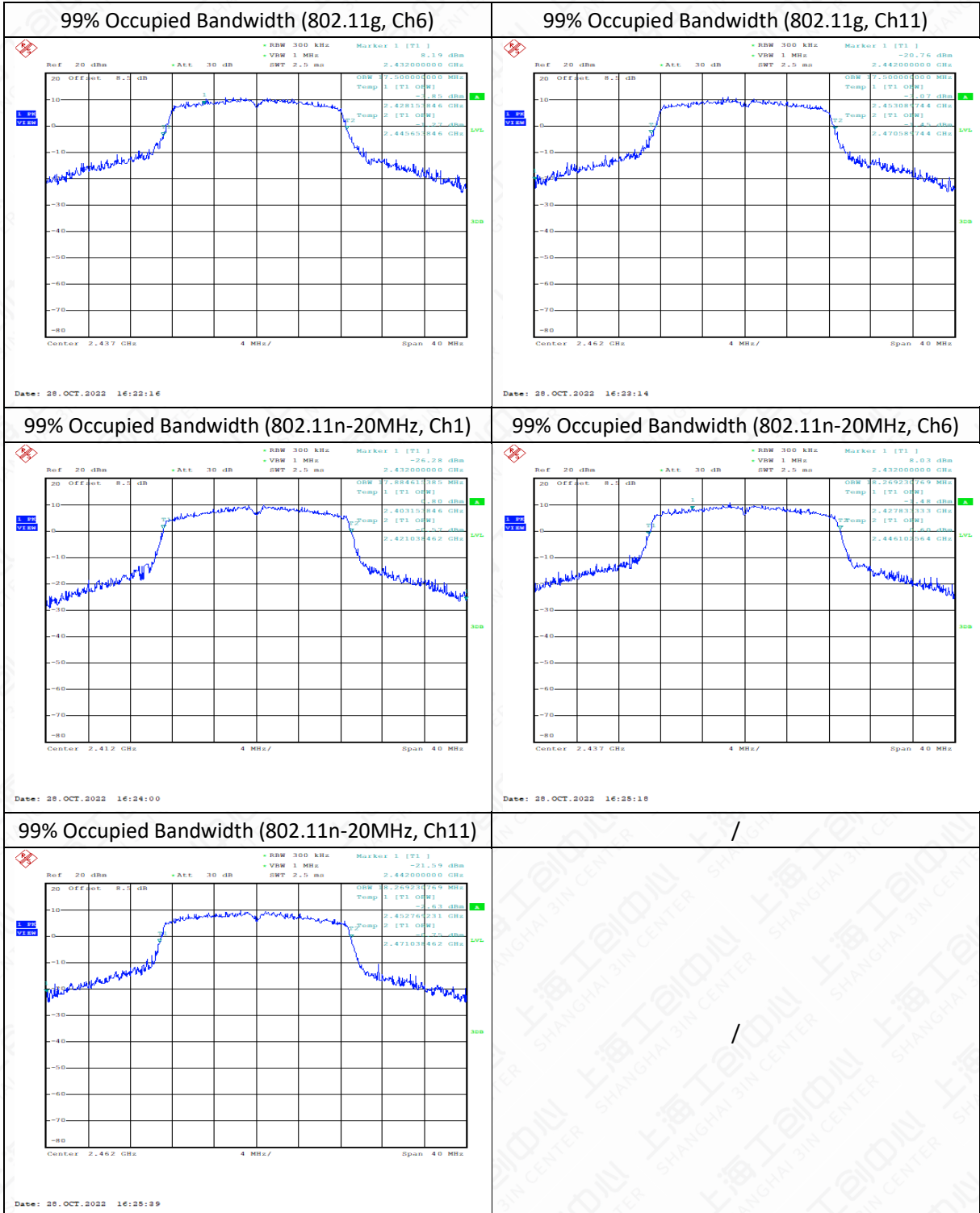

## 6.5 Band Edges Compliance

### 6.5.1. Measurement Limit

Standard	Limit(dBc)
FCC 47 Part 15.247(d)	>30
RSS-247 5.5	>30

### 6.5.2. Test procedures

The measurement is according to ANSI C63.10 clause 11.13.

1. The output power of EUT was connected to the spectrum analyzer. The path loss was compensated to the results for each measurement.
2. Enable EUT transmitter maximum power continuously.
3. Set instrument center frequency to the frequency of the emission to be measured (must be within 2MHz of the authorized band edge).
4. Set span to 2 MHz.
5. RBW = 100 kHz.
6. VBW  $\geq$  [3  $\times$  RBW].
7. Detector = peak.
8. Sweep time = auto.
9. Trace mode = max hold.
10. Allow sweep to continue until the trace stabilizes

### Measurement results

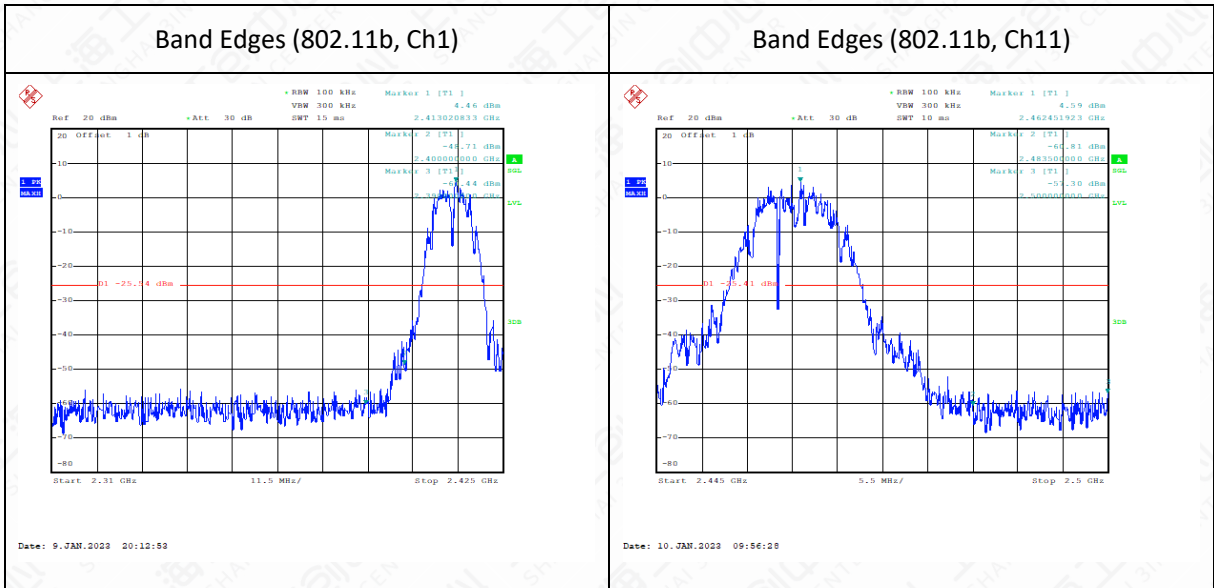

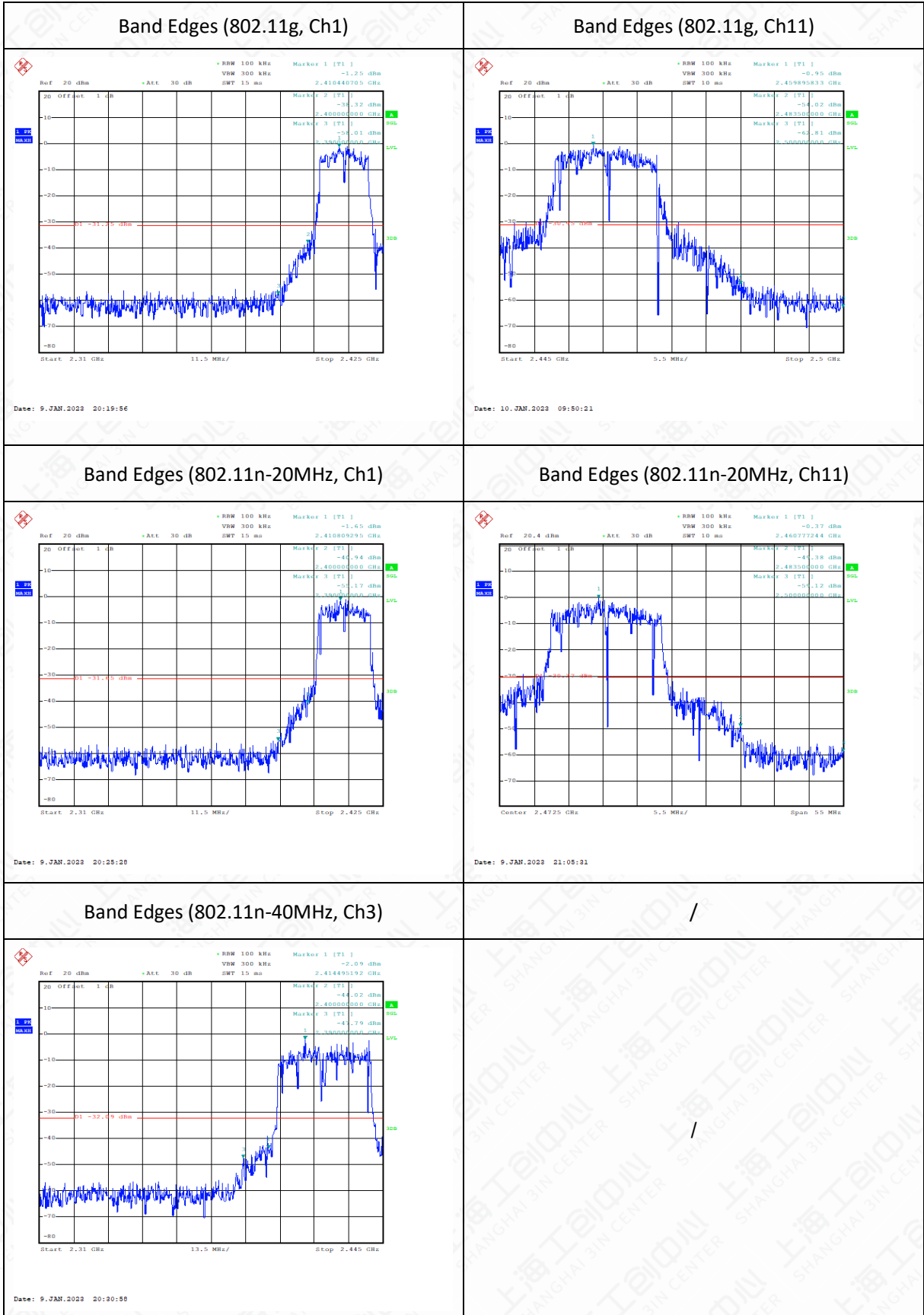

Conclusion: PASS

## 6.6 Transmitter Spurious Emission-conducted

### 6.6.1. Measurement Limit

Standard	Limit
FCC 47 Part 15.247(d)	30dB below highest level power in 100KHz bandwidth
RSS-247 5.5	30dB below highest level power in 100KHz bandwidth

### 6.6.2. Test procedures

This measurement is according to ANSI C63.10 clause 11.11.

1. The output power of EUT was connected to the spectrum analyzer. The path loss was compensated to the results for each measurement.
2. Enable EUT transmitter maximum power continuously.

#### Reference level measurement

3. Set instrument center frequency to DTS channel center frequency.
4. Set the span to  $\geq 1.5$  times the DTS bandwidth.
5. Set the RBW = 100 kHz.
6. Set the VBW  $\geq [3 \times \text{RBW}]$ .
7. Detector = peak.
8. Sweep time = auto couple.
9. Trace mode = max hold.
10. Allow trace to fully stabilize.
11. Use the peak marker function to determine the maximum PSD level.

#### Emission level measurement

1. Set the center frequency and span to encompass frequency range to be measured.
2. Set the RBW = 100 kHz.
3. Set the VBW  $\geq [3 \times \text{RBW}]$ .
4. Detector = peak.
5. Sweep time = auto couple.
6. Trace mode = max hold.
7. Allow trace to fully stabilize.
8. Use the peak marker function to determine the maximum amplitude level.

6.6.3. Test Setup

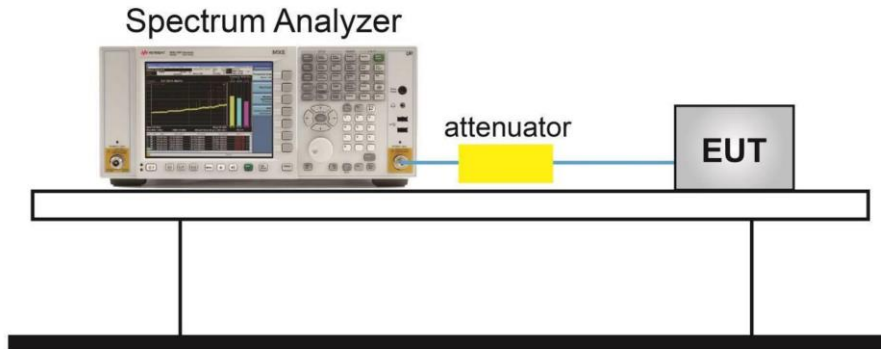

Measurement Result

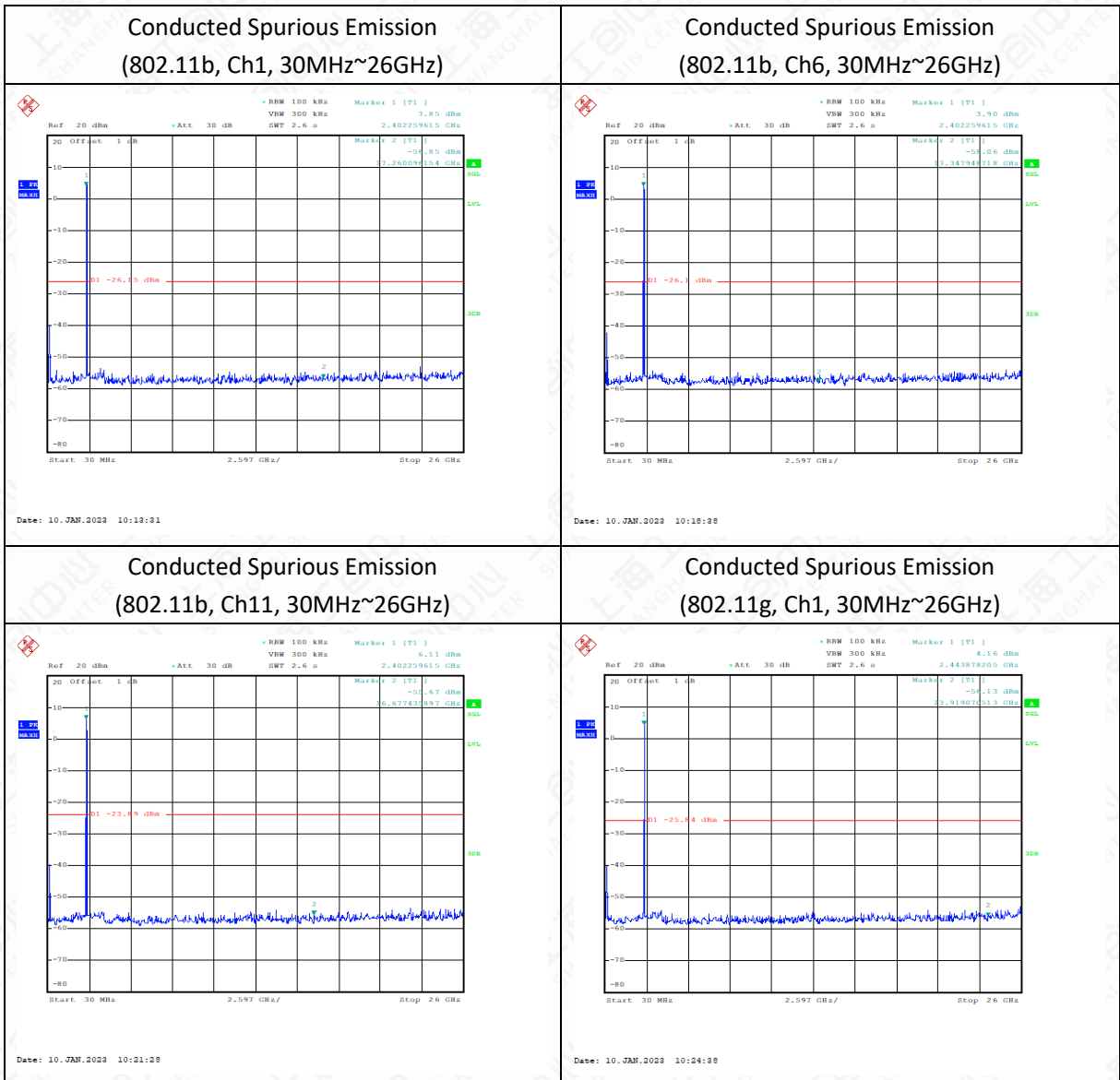

Conducted Spurious Emission  
(802.11g, Ch6, 30MHz~26GHz)

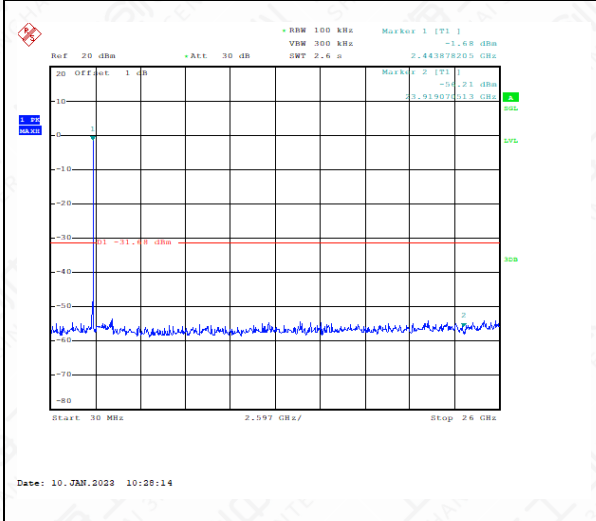

Conducted Spurious Emission  
(802.11g, Ch11, 30MHz~26GHz)

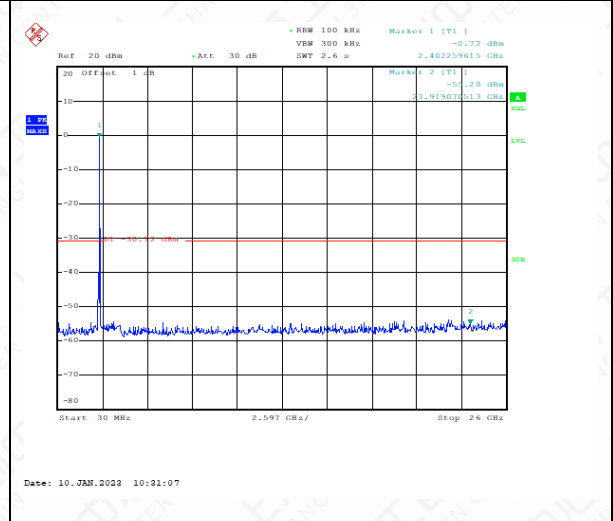

Conducted Spurious Emission  
(802.11n-20MHz, Ch1, 30MHz~26GHz)

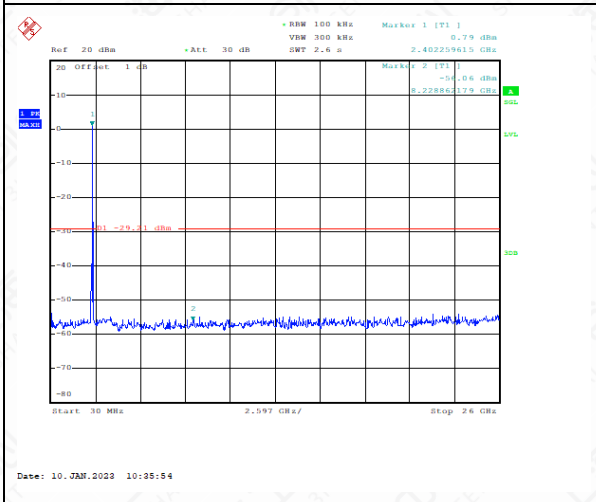

Conducted Spurious Emission  
(802.11n-20MHz, Ch6, 30MHz~26GHz)

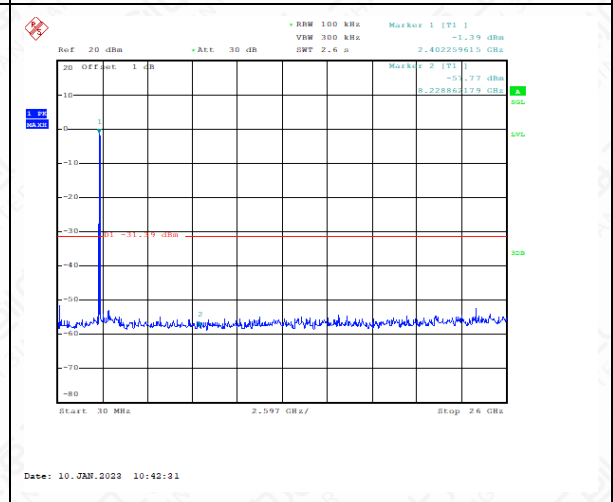

Conducted Spurious Emission  
(802.11n-20MHz, Ch11, 30MHz~26GHz)

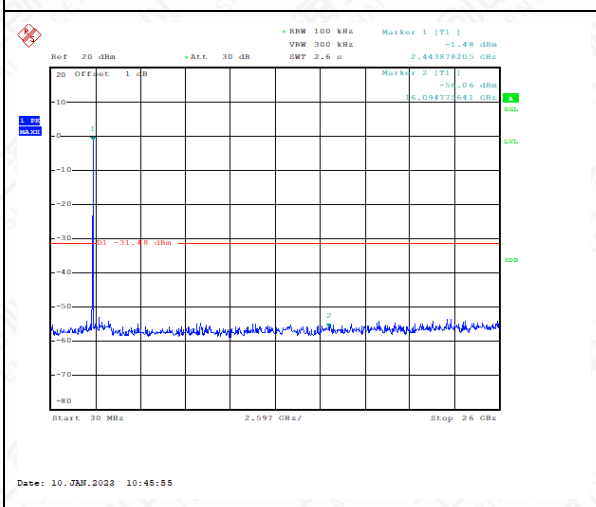

/

/

Note: 1. The out-of-limit signal in the picture is the main frequency signal.

2. The test data below 30MHz is more than 20dB lower than the limit value, so it is not provided in the report.

## 6.7 Transmitter Spurious Emission-Radiated

### 6.7.1. Measurement Limit

Standard	Limit
FCC 47 Part 15.247,15.205,15.209	20dB below peak output power
RSS-Gen 8.9,8.10	20dB below peak output power

In addition, radiated emissions which fall in the restricted bands, as defined in 25.205(a), must also comply with the radiated emission limits specified in 15.209(a)(see 15.205(c)).

The measurement is according to ANSI C63.10 clause 11.11 and 11.12.

### 6.7.2. Limit in restricted band

Frequency of emission (MHz)	Field strength(uV/m)	Field strength(dBuV/m)
0.009~0.49	2400/F (kHz)	129-94
0.49~1.705	24000/F (kHz)	74-63
1.705~30	30	70
30~88	100	40
88~216	150	43.5
216~960	200	46
Above 960	500	54

### 6.7.3. Test procedures

Portable, small, lightweight, or modular devices that may be handheld, worn on the body, or placed on a table during operation shall be positioned on a nonconducting platform, the top of which is 80 cm above the reference ground plane. The preferred area occupied by the EUT arrangement is 1 m by 1.5 m, but it may be larger or smaller to accommodate various sized EUTs. For testing purposes, ceiling- and wall-mounted devices also shall be positioned on a tabletop (see also ANSI C63.4-2013 section 6.3.4 and 6.3.5). In making any tests involving handheld, body-worn, or ceiling-mounted equipment, it is essential to recognize that the measured levels may be dependent on the orientation (attitude) of the three orthogonal axes of the EUT. Thus, exploratory tests as specified in 8.3.1 shall be carried out for various axes orientations to determine the attitude having maximum or near-maximum emission level.

The EUT was placed on a non-conductive table. The measurement antenna was placed at a distance of 3 meters from the EUT. During testing, the antenna height and the EUT azimuth were varied in order to identify the maximum level of emission from the EUT. This maximization process was repeated with the EUT positioned in each of its three orthogonal orientations.

Frequency of emission	RBW/VBW	Sweep Time (s)
0.009~30	9KHz/30KHz	Auto
30~1000	100KHz/300KHz	5
1000~4000	1MHz/3MHz	15
4000~18000	1MHz/3MHz	40



18000~26500	1MHz/3MHz	20
-------------	-----------	----

#### 6.7.4. Test Setup

##### Below 1GHz Test Setup

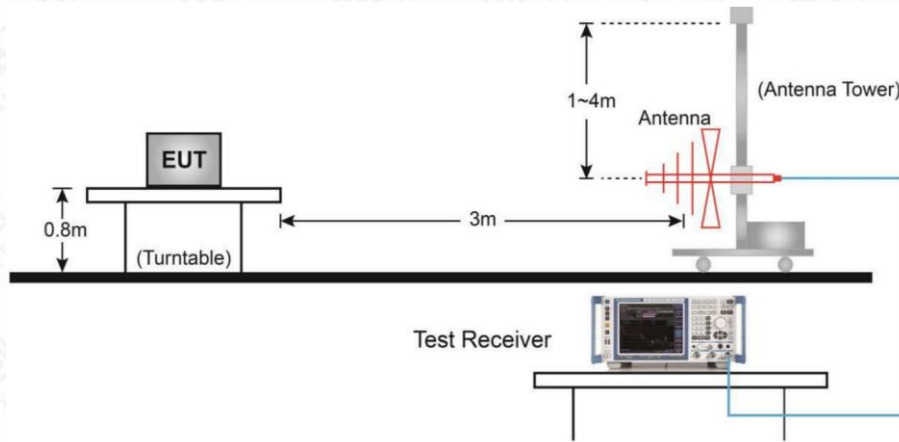

##### Above 1GHz Test Setup

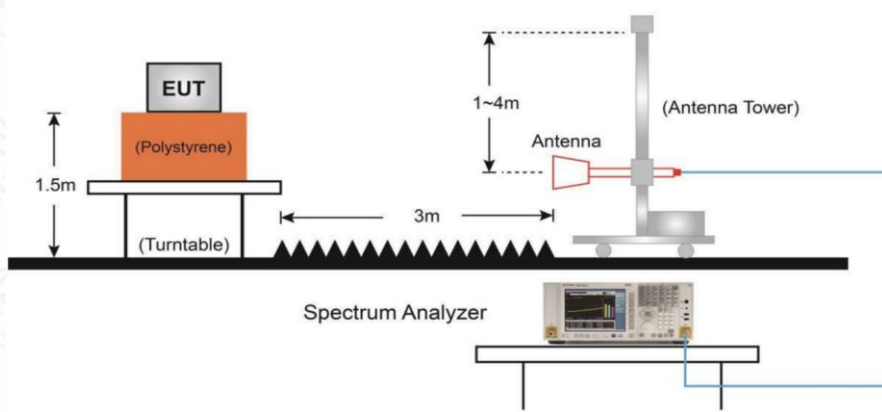

Frequency of emission (MHz)	RBW/VBW	Sweep Times (s)
30~1000	100KHz/300KHz	5
1000~4000	1MHz/3MHz	15
4000~18000	1MHz/3MHz	40
18000~26500	1MHz/3MHz	20

### Measurement Results

A "reference path loss" is established and  $A_{Rpi}$  is the attenuation of "reference path loss", and including the gain of receive antenna, the gain of the preamplifier, the cable loss.

$P_{Mea}$  is the field strength recorded from the instrument.

The measurement results are obtained as described below:

$$A_{Rpi} = \text{Cable loss} + \text{Antenna Factor} - \text{Preamplifier gain}$$

$$\text{Result} = P_{Mea} + \text{Cable loss} + \text{Antenna Factor} - \text{Preamplifier gain} = P_{Mea} + A_{Rpi}$$

The test data below 30MHz is more than 20dB lower than the limit value, so it is not provided in the report.

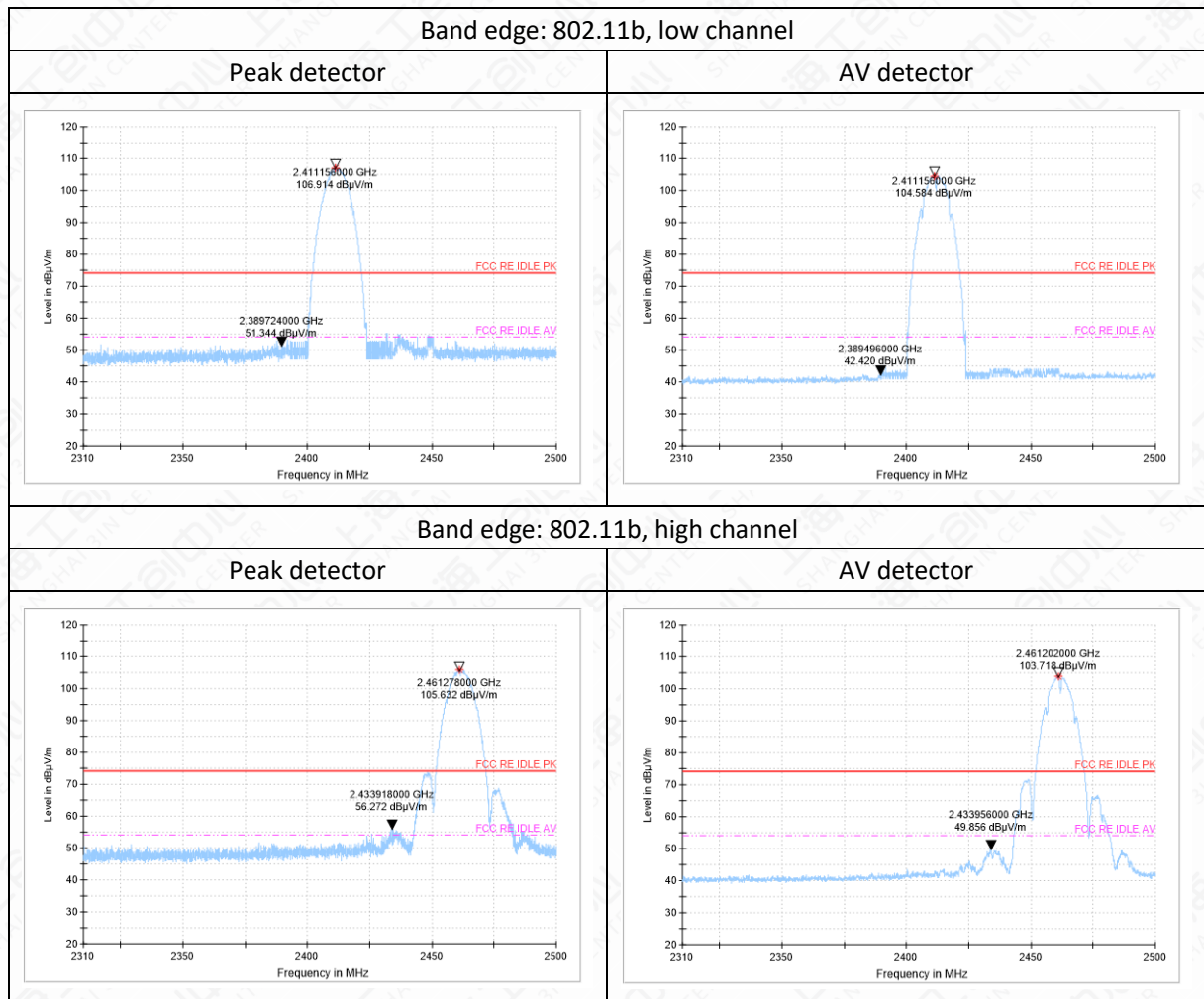

Radiated Spurious Emission  
(802.11b, Ch1, 30MHz~1GHz)

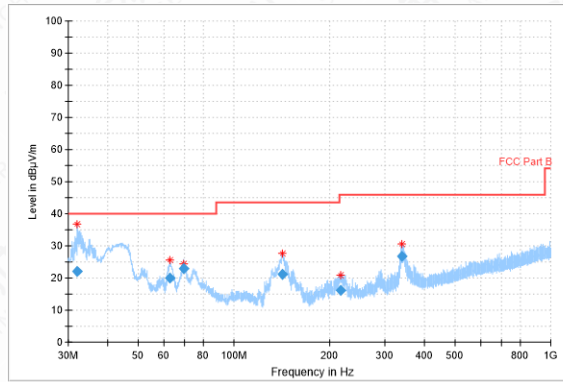

Radiated Spurious Emission  
(802.11b, Ch1, 1GHz~3GHz)

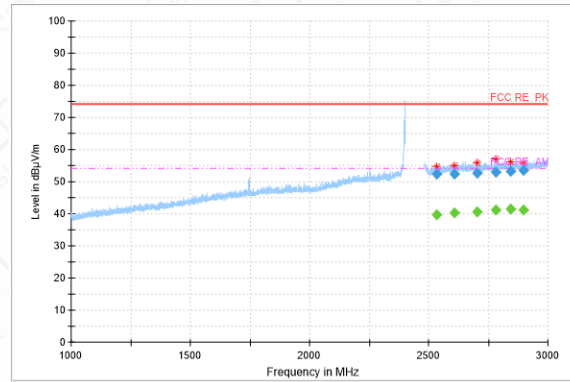

Radiated Spurious Emission  
(802.11b, Ch1, 3GHz~18GHz)

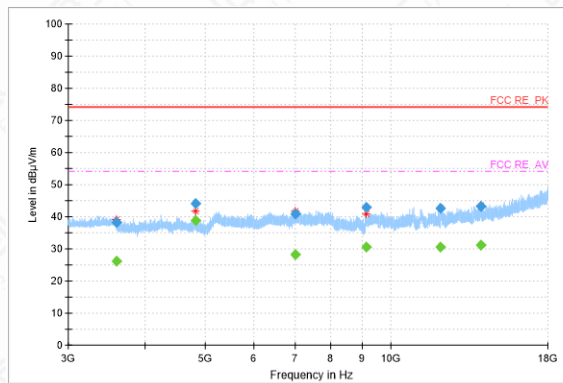

Radiated Spurious Emission  
(802.11b, Ch1, 18GHz~26.5GHz)

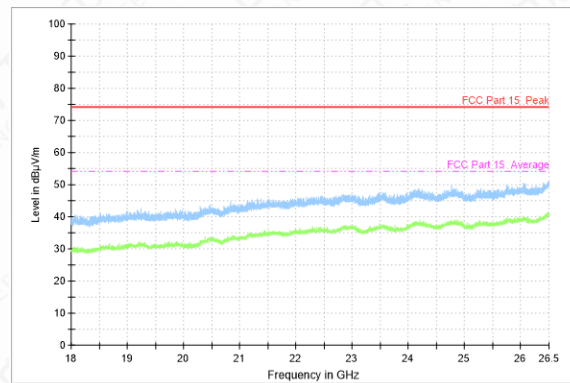

Radiated Spurious Emission  
(802.11b, Ch1, 26.5GHz~40GHz)

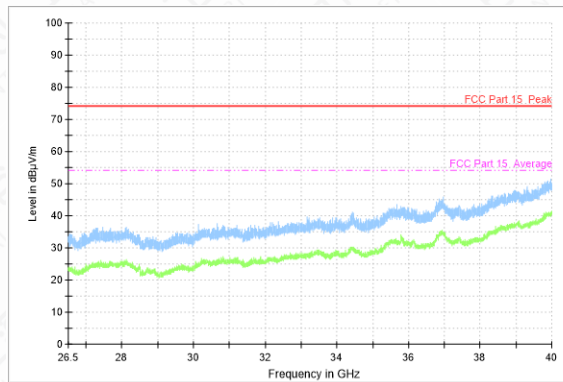

Radiated Spurious Emission  
(802.11b, Ch11, 30MHz~1GHz)

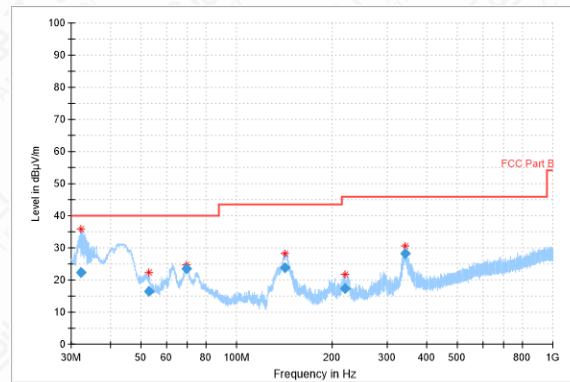

Radiated Spurious Emission  
(802.11b, Ch11, 1GHz~3GHz)

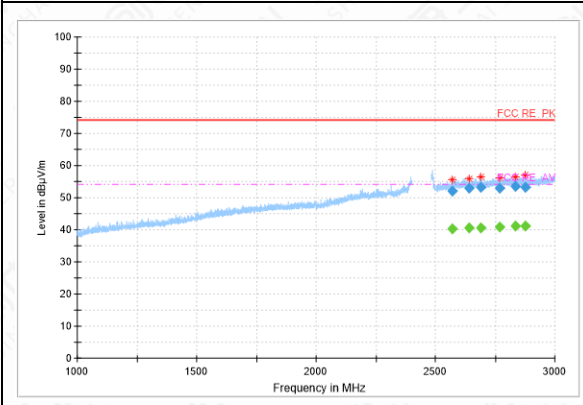

Radiated Spurious Emission  
(802.11b, Ch11, 3GHz~18GHz)

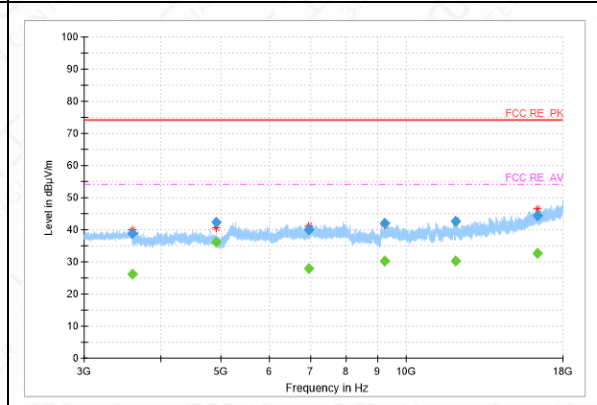

Radiated Spurious Emission  
(802.11b, Ch11, 18GHz~26.5GHz)

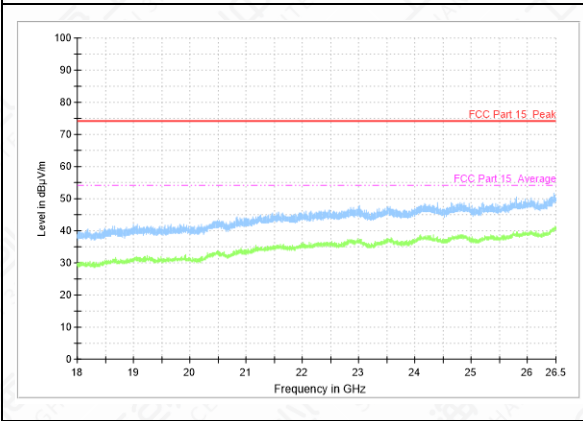

Radiated Spurious Emission  
(802.11b, Ch1, 26.5GHz~40GHz)

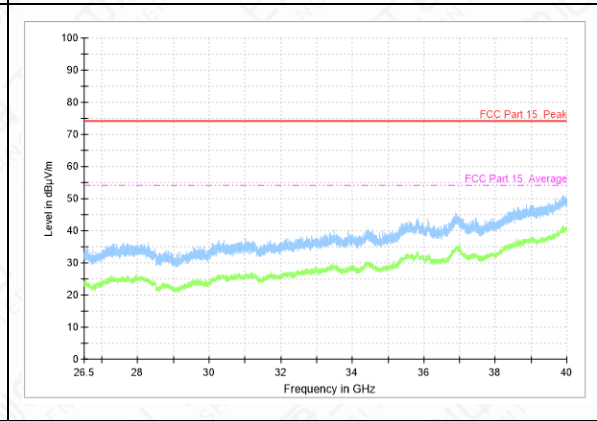

## Band edge: 802.11g, low channel

Peak detector

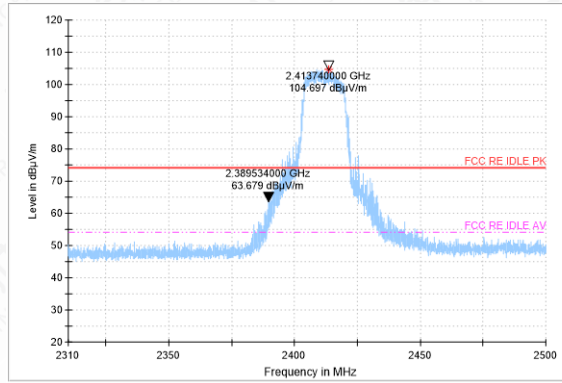

AV detector

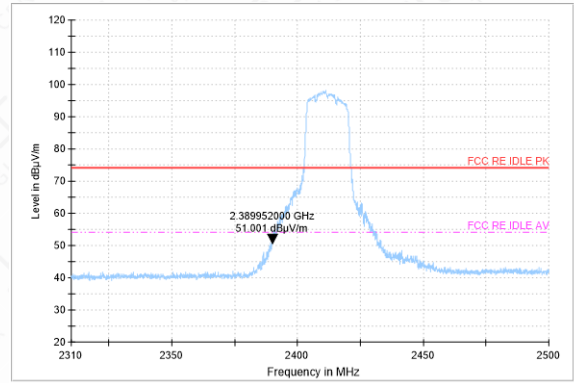

## Band edge: 802.11g, high channel

Peak detector

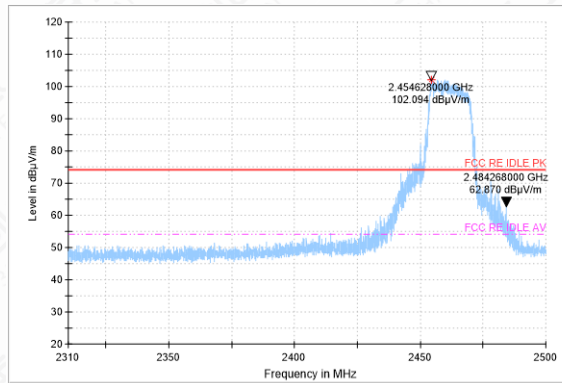

AV detector

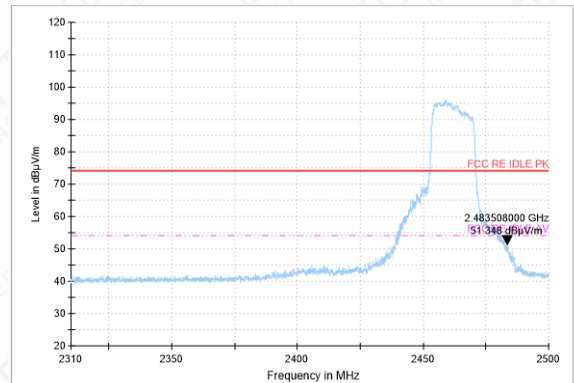

Radiated Spurious Emission  
(802.11g, Ch1, 30MHz~1GHz)

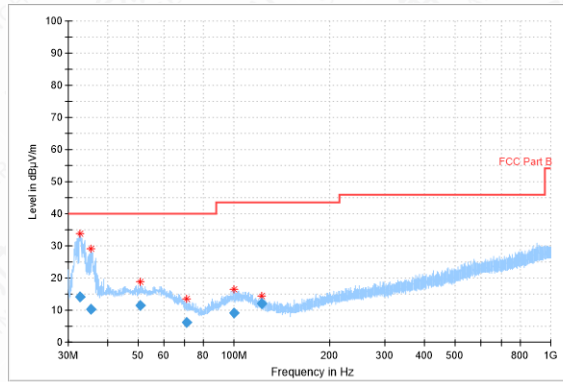

Radiated Spurious Emission  
(802.11g, Ch1, 1GHz~3GHz)

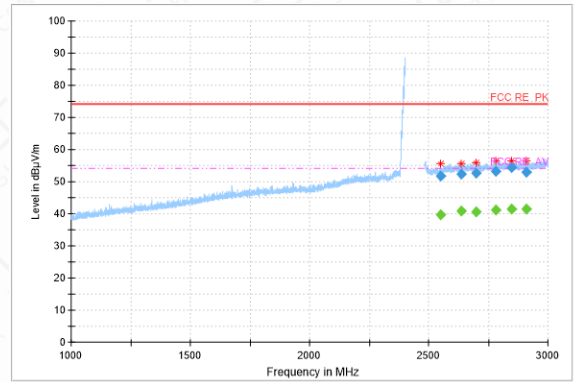

Radiated Spurious Emission  
(802.11g, Ch1, 3GHz~18GHz)

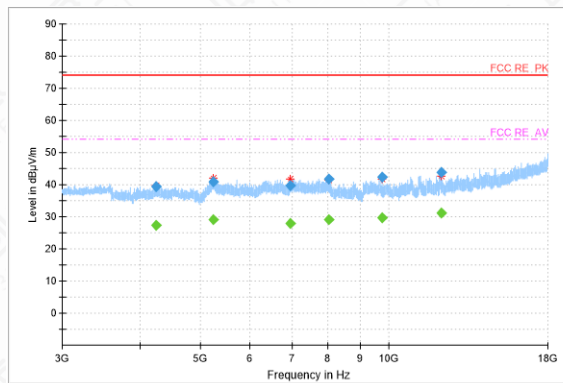

Radiated Spurious Emission  
(802.11g, Ch1, 18GHz~26.5GHz)

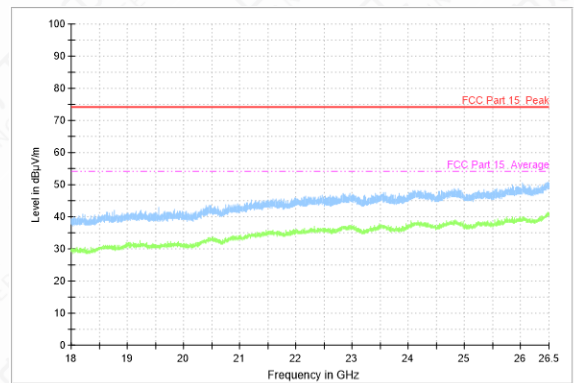

Radiated Spurious Emission  
(802.11g, Ch1, 26.5GHz~40GHz)

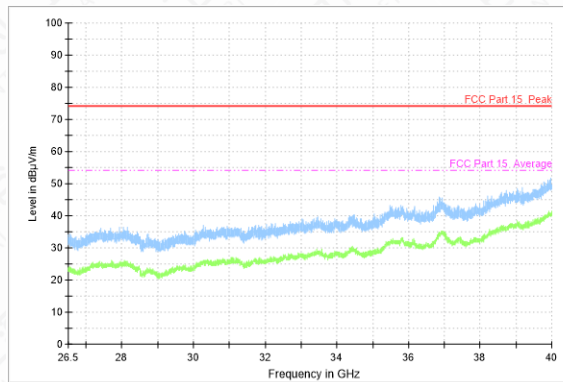

Radiated Spurious Emission  
(802.11g, Ch11, 30MHz~1GHz)

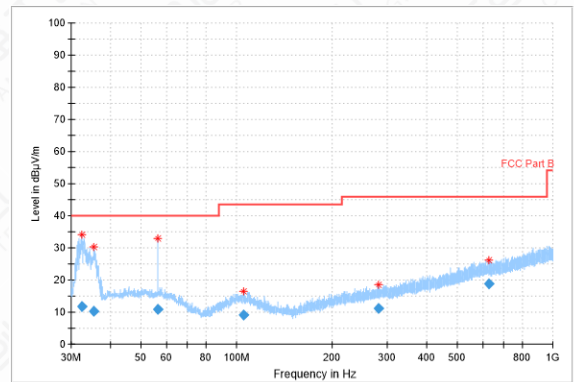

**Radiated Spurious Emission**  
(802.11g, Ch11, 1GHz~3GHz)

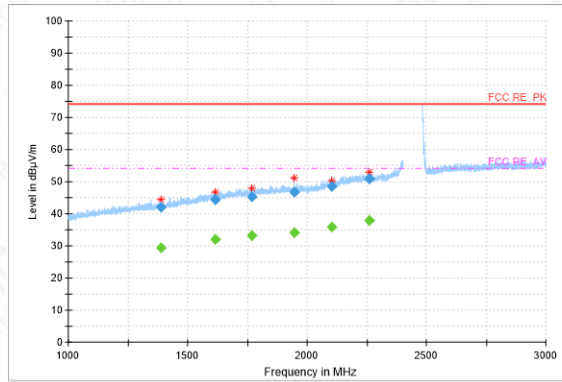

**Radiated Spurious Emission**  
(802.11g, Ch11, 3GHz~18GHz)

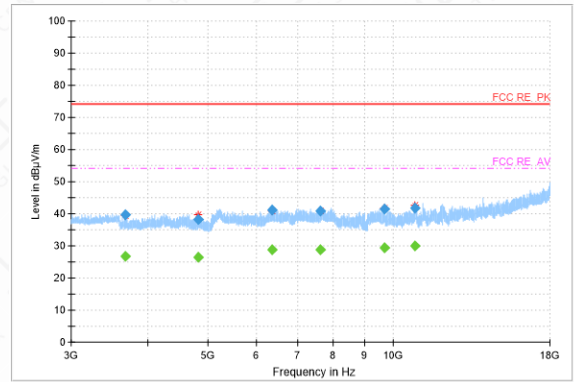

**Radiated Spurious Emission**  
(802.11g, Ch1, 26.5GHz~40GHz)

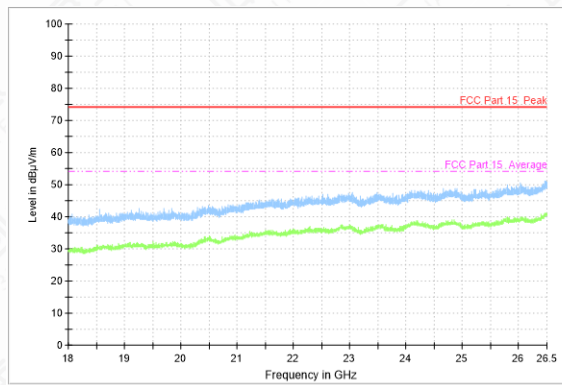

**Radiated Spurious Emission**  
(802.11g, Ch1, 18GHz~26.5GHz)

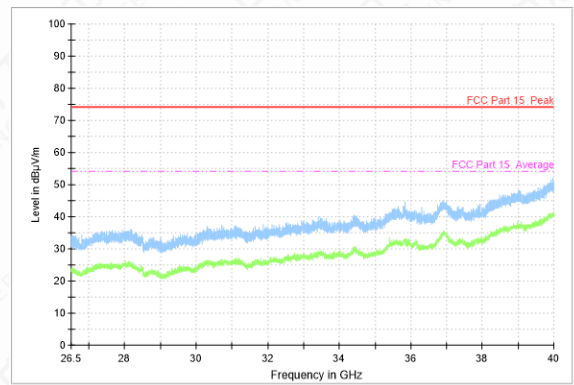

Band edge: 802.11n-20HT, low channel

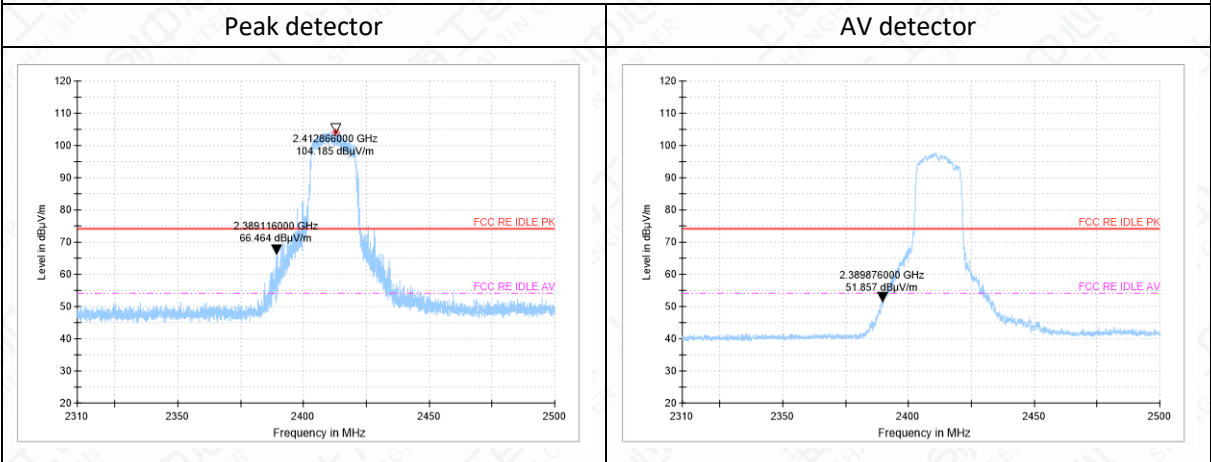

Band edge: 802.11n-20HT, high channel

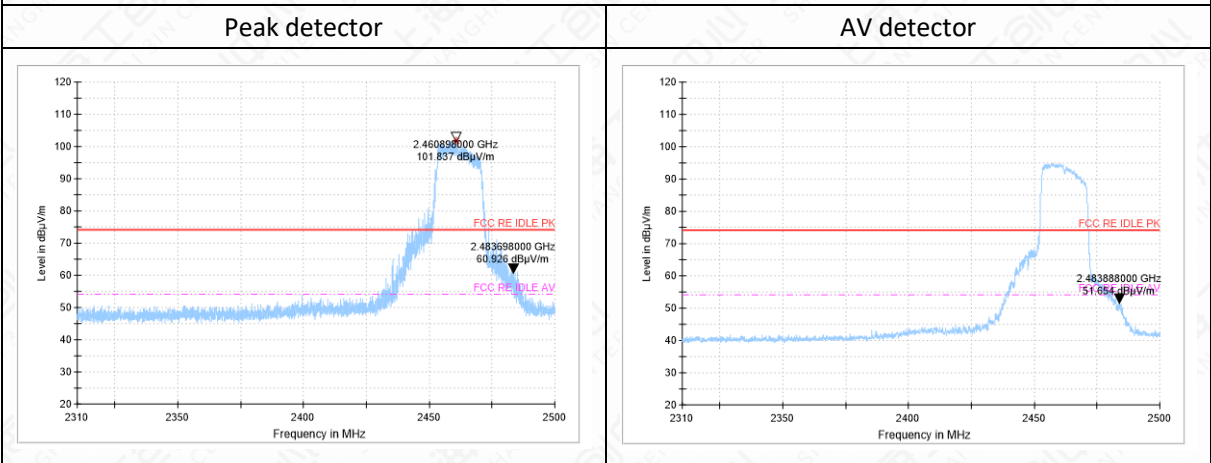



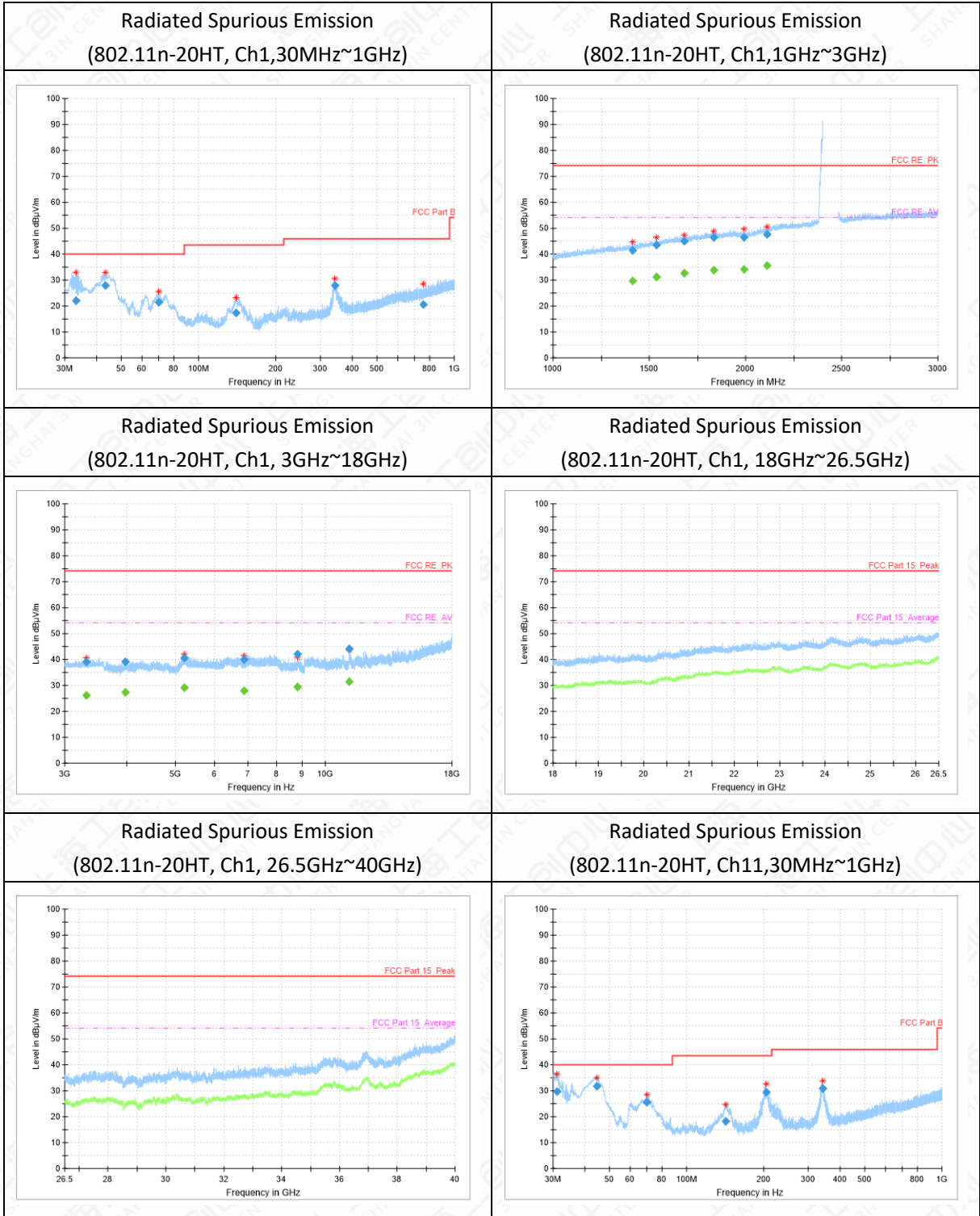

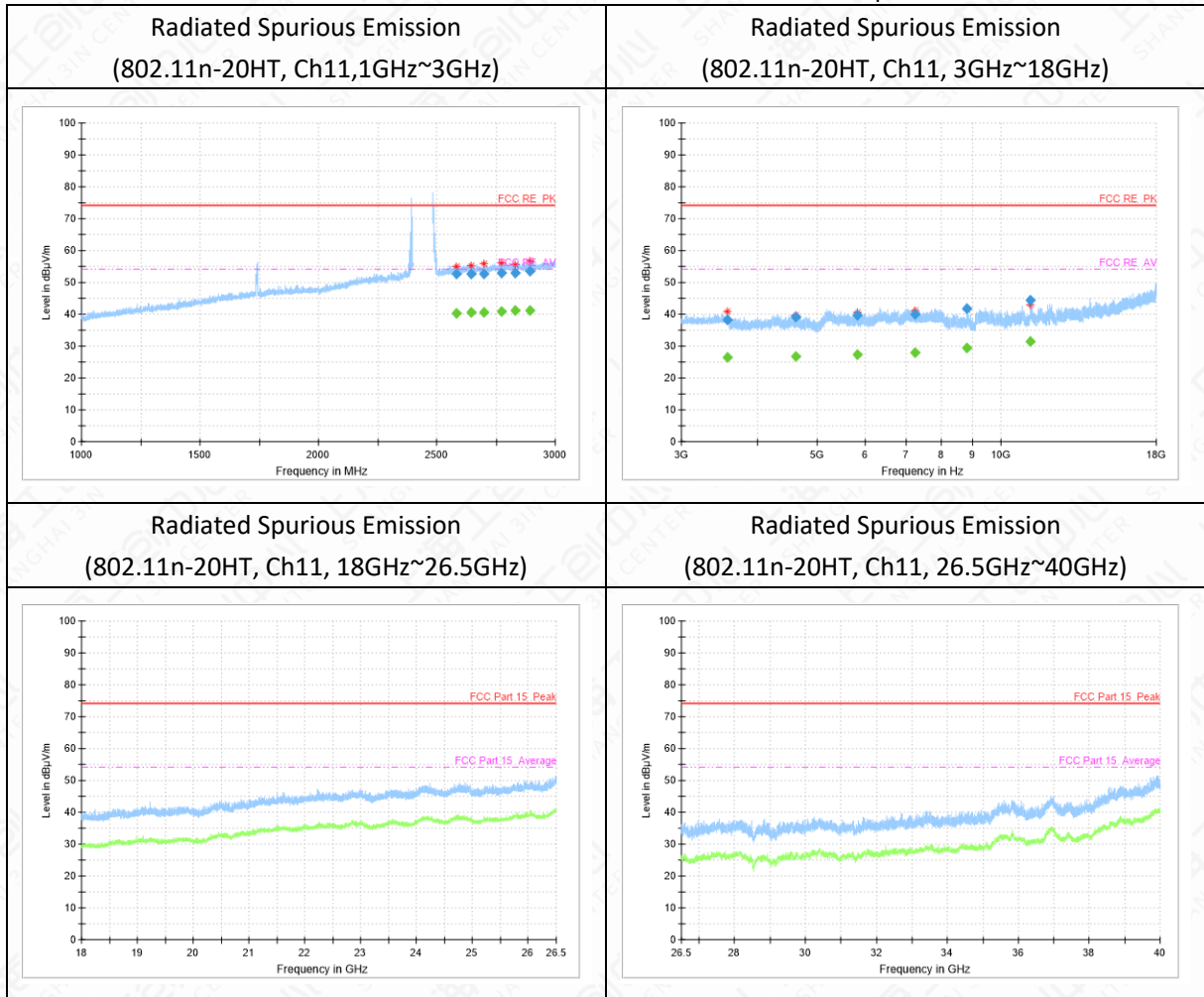

Note: The out-of-limit signal in the picture is the main frequency signal.

### 802.11b

#### Ch1 30MHz~1GHz

Frequency (MHz)	Result (dBµV/m)	ARpl (dB)	PMea (dBµV/m)	Polarity
32.0	21.94	-14.3	36.24	V
62.8	20.04	-13.3	33.34	V
69.5	23.08	-15.5	38.58	V
142.3	21.28	-17.1	38.38	H
217.8	16.07	-12.7	28.77	V
338.2	26.89	-9.5	36.39	H

#### Ch1 1GHz~3GHz

Frequency (MHz)	Result (dBµV/m)	ARpl (dB)	PMea (dBµV/m)	Polarity
2532.4	52.24	14.7	37.54	V
2609.3	52.36	15.6	36.76	V
2701.0	52.58	15.9	36.68	V
2779.5	53.01	16.4	36.61	H
2841.3	53.18	16.6	36.58	V

2895.5	53.5	16.7	36.8	V
--------	------	------	------	---

## Ch1 3GHz~18GHz

Frequency (MHz)	Result (dB $\mu$ V/m)	ARpl (dB)	PMea (dB $\mu$ V/m)	Polarity
3597.9	38.31	-7	45.31	V
4823.9	44.16	-4.8	48.96	H
7006.7	40.78	-2.2	42.98	H
9122.4	42.99	-0.4	43.39	H
12054.8	42.73	2	40.73	H
14001.8	43.27	4.7	38.57	V

## Ch11 30MHz~1GHz

Frequency (MHz)	Result (dB $\mu$ V/m)	ARpl (dB)	PMea (dB $\mu$ V/m)	Polarity
32.3	22.23	-14.2	36.43	V
52.8	16.43	-12	28.43	V
69.5	23.4	-15.5	38.9	V
142.2	23.93	-17.1	41.03	H
219.7	17.34	-12.5	29.84	V
342.2	28.28	-9.5	37.78	H

## Ch11 1GHz~3GHz

Frequency (MHz)	Result (dB $\mu$ V/m)	ARpl (dB)	PMea (dB $\mu$ V/m)	Polarity
2569.5	52.11	15.3	36.81	H
2641.0	52.85	15.8	37.05	V
2690.1	53.38	15.9	37.48	V
2769.6	53.04	16.4	36.64	V
2833.9	53.42	16.6	36.82	H
2875.8	53.23	16.7	36.53	H

## Ch11 3GHz~18GHz

Frequency (MHz)	Result (dB $\mu$ V/m)	ARpl (dB)	PMea (dB $\mu$ V/m)	Polarity
3594.5	38.73	-7	45.73	V
4923.9	42.36	-4.5	46.86	H
6959.1	39.98	-2.4	42.38	H
9244.5	41.99	-0.3	42.29	H
12057.7	42.57	2	40.57	H
16342.8	44.43	8	36.43	V

## 802.11g

## Ch1 30MHz~1GHz

Frequency (MHz)	Result (dB $\mu$ V/m)	ARpl (dB)	PMea (dB $\mu$ V/m)	Polarity
32.6	14.22	-14.2	28.42	V
35.3	10.25	-14	24.25	V
50.5	11.37	-11.9	23.27	V
70.7	6.18	-15.8	21.98	V
99.8	9	-13.4	22.4	H

122.7	11.92	-15.3	27.22	V
-------	-------	-------	-------	---

## Ch1 1GHz~3GHz

Frequency (MHz)	Result (dB $\mu$ V/m)	ARpl (dB)	PMea (dB $\mu$ V/m)	Polarity
2550.8	51.86	15.1	36.76	H
2636.9	52.41	15.8	36.61	H
2696.5	52.56	15.9	36.66	H
2781.5	53.14	16.5	36.64	H
2847.0	54.55	16.6	37.95	H
2908.8	53.04	16.7	36.34	H

## Ch1 1GHz~3GHz(Average)

Frequency (MHz)	Result (dB $\mu$ V/m)	ARpl (dB)	PMea (dB $\mu$ V/m)	Polarity
2847.0	41.33	16.6	24.73	H

## Ch1 3GHz~18GHz

Frequency (MHz)	Result (dB $\mu$ V/m)	ARpl (dB)	PMea (dB $\mu$ V/m)	Polarity
4237.6	39.42	-5.4	44.82	V
5230.7	40.86	-1.3	42.16	V
6965.3	39.78	-2.4	42.18	H
8022.0	41.76	-1.1	42.86	H
9753.2	42.31	-0.5	42.81	H
12129.5	43.68	2	41.68	H

## Ch11 30MHz~1GHz

Frequency (MHz)	Result (dB $\mu$ V/m)	ARpl (dB)	PMea (dB $\mu$ V/m)	Polarity
32.4	11.86	-14.2	26.06	V
35.4	10.43	-13.9	24.33	V
56.5	11.02	-12.2	23.22	H
105.1	9.02	-13.3	22.32	H
281.6	11.23	-10.9	22.13	V
626.5	18.92	-3.1	22.02	V

## Ch11 1GHz~3GHz

Frequency (MHz)	Result (dB $\mu$ V/m)	ARpl (dB)	PMea (dB $\mu$ V/m)	Polarity
1387.3	42.08	4.2	37.88	V
1613.9	44.48	7.1	37.38	V
1767.9	45.4	8.2	37.2	H
1946.2	46.72	9.2	37.52	H
2101.5	48.6	11	37.6	H
2258.3	50.92	12.9	38.02	V

## Ch11 3GHz~18GHz

Frequency (MHz)	Result (dB $\mu$ V/m)	ARpl (dB)	PMea (dB $\mu$ V/m)	Polarity
3671.0	39.65	-6.6	46.25	V
4832.4	38.12	-4.8	42.92	H
6369.0	41.3	-2.5	43.8	V
7611.5	40.78	-1.8	42.58	H

9698.2	41.53	-0.6	42.13	V
10861.7	41.69	1.1	40.59	H

802.11n-HT20

Ch1 30MHz~1GHz

Frequency (MHz)	Result (dB $\mu$ V/m)	ARpl (dB)	PMea (dB $\mu$ V/m)	Polarity
33.2	22.1	-14.2	36.3	V
43.3	27.97	-12.5	40.47	V
69.7	21.48	-15.6	37.08	V
140.2	17.29	-17.1	34.39	H
341.4	27.82	-9.5	37.32	H
757.7	20.63	-2	22.63	V

Ch1 1GHz~3GHz

Frequency (MHz)	Result (dB $\mu$ V/m)	ARpl (dB)	PMea (dB $\mu$ V/m)	Polarity
1413.7	41.61	4.5	37.11	V
1537.2	43.62	6.1	37.52	H
1682.9	44.96	7.7	37.26	V
1835.1	46.33	8.7	37.63	V
1993.0	46.43	9.1	37.33	H
2110.4	47.55	11.2	36.35	H

Ch1 3GHz~18GHz

Frequency (MHz)	Result (dB $\mu$ V/m)	ARpl (dB)	PMea (dB $\mu$ V/m)	Polarity
3313.8	39.18	-7.2	46.38	H
3965.7	39.1	-5.6	44.7	V
5216.3	40.73	-1.1	41.83	V
6887.9	39.93	-2.5	42.43	H
8796.7	42.02	-1.5	43.52	V
11201.5	44.18	1.7	42.48	H

Ch11 30MHz~1GHz

Frequency (MHz)	Result (dB $\mu$ V/m)	ARpl (dB)	PMea (dB $\mu$ V/m)	Polarity
31.1	29.79	-14.3	44.09	V
44.4	31.8	-12.4	44.2	V
69.7	25.53	-15.6	41.13	V
142.4	18.14	-17.1	35.24	H
204.6	29.39	-13.6	42.99	V
340.2	30.87	-9.5	40.37	H

Ch11 1GHz~3GHz

Frequency (MHz)	Result (dB $\mu$ V/m)	ARpl (dB)	PMea (dB $\mu$ V/m)	Polarity
2581.2	52.59	15.4	37.19	H
2644.0	52.63	15.8	36.83	V
2698.2	52.56	15.9	36.66	H
2770.7	52.88	16.4	36.48	H

2830.5	52.91	16.6	36.31	V
2893.1	53.4	16.7	36.7	V

**Ch11 3GHz~18GHz**

Frequency (MHz)	Result (dB $\mu$ V/m)	ARpl (dB)	PMea (dB $\mu$ V/m)	Polarity
3563.5	38.25	-7	45.25	V
4611.3	39.05	-5	44.05	V
5824.7	39.68	-4	43.68	H
7241.3	40.06	-2.2	42.26	H
8796.1	41.71	-1.5	43.21	V
11201.0	44.28	1.7	42.58	V

## 6.8 AC Powerline Conducted Emission

### 6.8.1. Method of Measurement: ANSI C63.10-2013-clause 6.2

1. The one EUT cable configuration and arrangement and mode of operation that produced the emission with the highest amplitude relative to the limit is selected for the final measurement, while applying the appropriate modulating signal to the EUT.
2. If the EUT is relocated from an exploratory test site to a final test site, the highest emissions shall be remaximized at the final test location before final ac power-line conducted emission measurements are performed.
3. The final test on all current-carrying conductors of all of the power cords to the equipment that comprises the EUT (but not the cords associated with other non-EUT equipment in the system) is then performed for the full frequency range for which the EUT is being tested for compliance without further variation of the EUT arrangement, cable positions, or EUT mode of operation.
4. If the EUT is comprised of equipment units that have their own separate ac power connections, e.g., floor-standing equipment with independent power cords for each shelf that are able to connect directly to the ac power network, each current-carrying conductor of one unit is measured while the other units are connected to a second (or more) LISN(s). All units shall be separately measured. If a power strip is provided by the manufacturer, to supply all of the units making up the EUT, only the conductors in the power cord of the power strip shall be measured.

If the EUT uses a detachable antenna, these measurements shall be made with a suitable dummy load connected to the antenna output terminals; otherwise, the tests shall be made with the antenna connected and, if adjustable, fully extended. When measuring the ac conducted emissions from a device that operates between 150 kHz and 30 MHz a non-detachable antenna may be replaced with a dummy load for the measurements within the fundamental emission band of the transmitter, but only for those measurements.<sup>36</sup> Record the six highest EUT emissions relative to the limit of each of the current-carrying conductors of the power cords of the equipment that comprises the EUT over the frequency range specified by the procuring or regulatory agency. Diagram or photograph the test setup that was used. See Clause 8 for full reporting requirements.

6.8.2. Test Setup

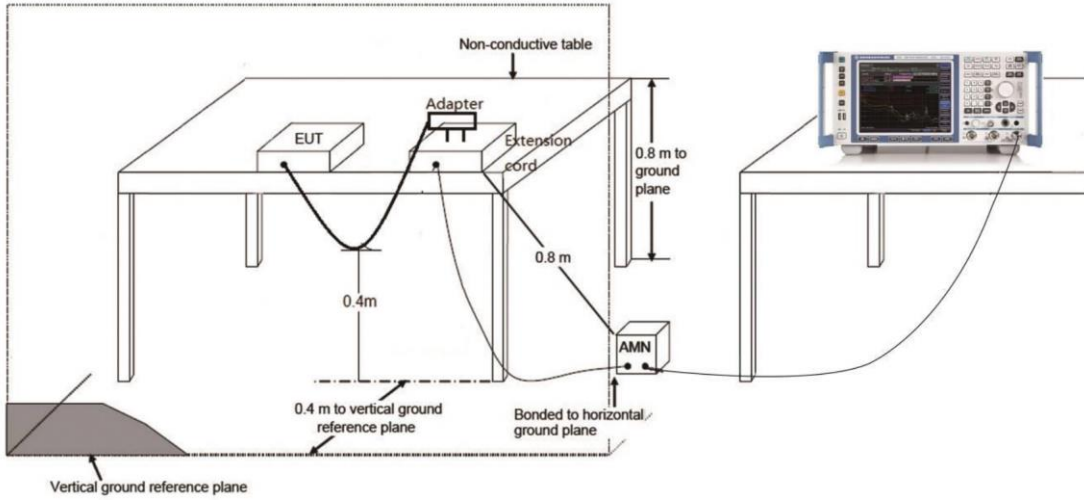

6.8.3. Test Condition

Voltage (V)	Frequency (Hz)
120	60

Measurement Result and limit:  
(Quasi-peak-average Limit)

Frequency range (MHz)	Quasi-peak Limit (dBμV)	Average Limit (dBμV)	Conclusion
0.15 to 0.5	66 to 56	56 to 46	P
0.5 to 5	56	46	
5 to 30	60	50	

NOTE: The limit decreases linearly with the logarithm of the frequency in the range 0.15 MHz to 0.5 MHz.

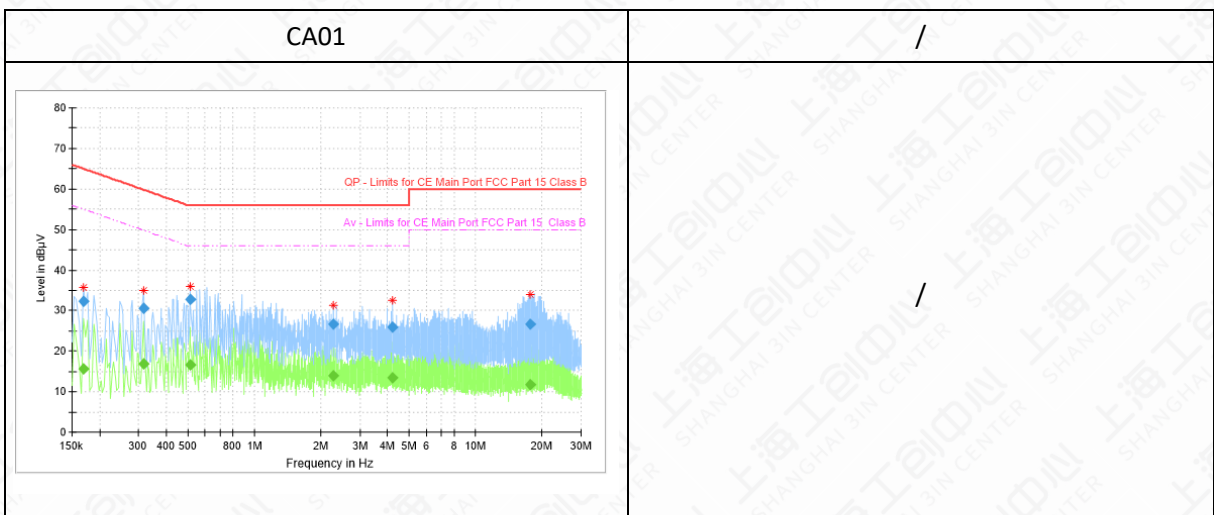



Frequency (MHz)	QuasiPeak (dB $\mu$ V)	Average (dB $\mu$ V)	Limit (dB $\mu$ V)	Margin (dB)	Meas. Time (ms)	Bandwidth (kHz)	Line	Filter	Corr. (dB)
0.168656	---	15.56	55.03	39.47	15000.0	9.000	L1	ON	9.6
0.168656	32.23	---	65.03	32.80	15000.0	9.000	L1	ON	9.6
0.314175	---	16.82	49.86	33.04	15000.0	9.000	L1	ON	9.6
0.314175	30.65	---	59.86	29.21	15000.0	9.000	L1	ON	9.6
0.511931	---	16.70	46.00	29.30	15000.0	9.000	L1	ON	9.6
0.511931	32.85	---	56.00	23.15	15000.0	9.000	L1	ON	9.6
2.284275	---	14.00	46.00	32.00	15000.0	9.000	N	ON	9.7
2.284275	26.65	---	56.00	29.35	15000.0	9.000	N	ON	9.7
4.213331	---	13.56	46.00	32.44	15000.0	9.000	N	ON	9.7
4.213331	26.04	---	56.00	29.96	15000.0	9.000	N	ON	9.7
17.686875	---	11.62	50.00	38.38	15000.0	9.000	N	ON	10.1
17.686875	26.64	---	60.00	33.36	15000.0	9.000	N	ON	10.1

## Annex A: Revised History

Version	Revised Content
V00	Initial
V01	Update the FCC Designation No.in section 2.1; Update the FCC ID and HVIN in section 4.1

**Annex B: Accreditation Certificate****Accredited Laboratory**

A2LA has accredited

**INDUSTRIAL INTERNET INNOVATION CENTER  
(SHANGHAI) CO., LTD.**

Shanghai, People's Republic of China

for technical competence in the field of

**Electrical Testing**

This laboratory is accredited in accordance with the recognized International Standard ISO/IEC 17025:2017 *General requirements for the competence of testing and calibration laboratories*. This accreditation demonstrates technical competence for a defined scope and the operation of a laboratory quality management system (refer to joint ISO-ILAC-IAF Communiqué dated April 2017).

Presented this 12<sup>th</sup> day of April 2021.

Vice President, Accreditation Services  
For the Accreditation Council  
Certificate Number 3682.01  
Valid to February 28, 2023

For the tests to which this accreditation applies, please refer to the laboratory's Electrical Scope of Accreditation.

**END OF REPORT**