

POS System

User Manual Book

Before operating this unit
please read these instructions completely and save them

Three configurations of T2s

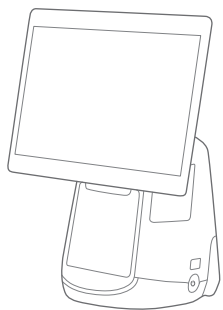

15.6" Main Display
(L1561)

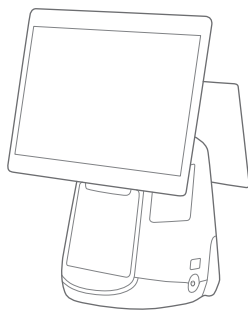

15.6" Main Display + 10.1"
Customer Display
(L1562)

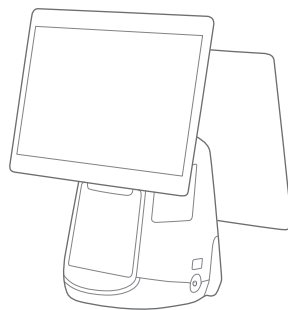

15.6" Dual-Display
L1563

Simplified Setting

It only takes a few steps to turn on this intelligent commercial POS machine:

- 1 Press "Power" button, then the display lights on. Setting your Internet connection mode as steps shown on display.
- 2 WiFi Connection
 - Press the [Setting] button, start WLAN to enter the WLAN search interface, and search for the available WLAN hotspots.
 - Press the WLAN to be connected. If an encrypted network is selected, a password is required for connection.
- 3 LAN Connection

How to download/use App

The POS is applicable to cashing environments of commercial customers from a wide variety of sectors such as catering services, high-end department stores, convenience stores, banking services, information stations, interactive multimedia facilities, advertising exposure systems, etc. Open the App Market while you are connected to the Internet to view, download and install the App.

Access the Help App in the POS machine for more use instructions

Introduction to POS

"Take dual 15.6" as sample"

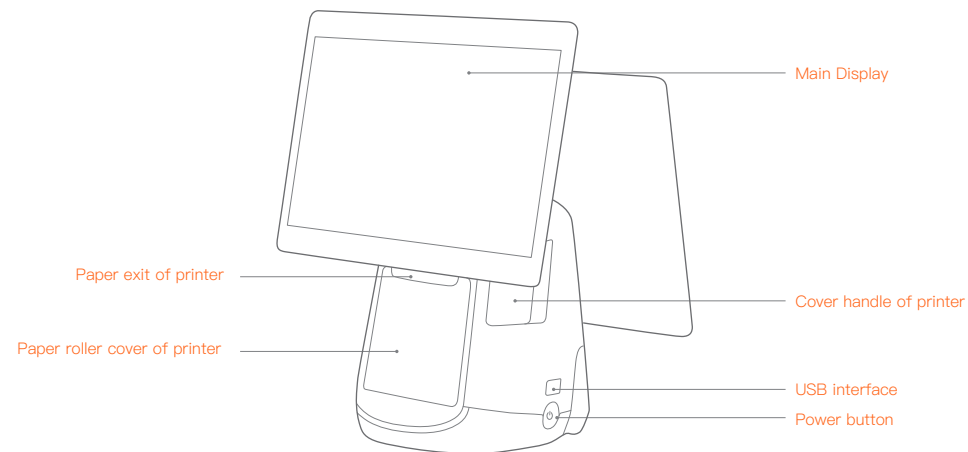

Power button

Press the power button to start the POS when the machine is powered off;
Press the power button for 2-3 seconds to turn off or restart the POS when the machine is working.
Press the power button for 11 seconds to power off the machine when it crashes.

USB interface

For connecting an external keyboard, mouse or U-disk.

Paper exit of printer

For printing a receipt at the power-on state.

Cover handle of printer

For opening the paper roller cover of the printer to change paper.

Main Display

A touchscreen for operators.

Customer Display

A screen that plays advertisement for customers. It is optional, based on the POS.

Cable cover

Behind the cover are ports that connect various cables.

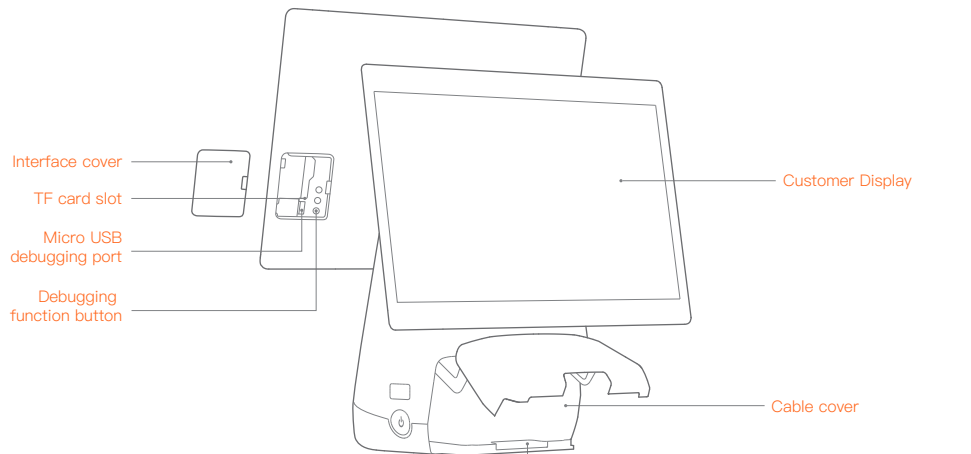

TF card slot

For connecting an external TF memory card.

Micro USB debugging port, debugging function button

For debugging the POS.

Cashdrawer Port

This port can only supports 24V/1A cashbox.If you use a 12V cashbox, there maybe has a potential risk of circuit burns.

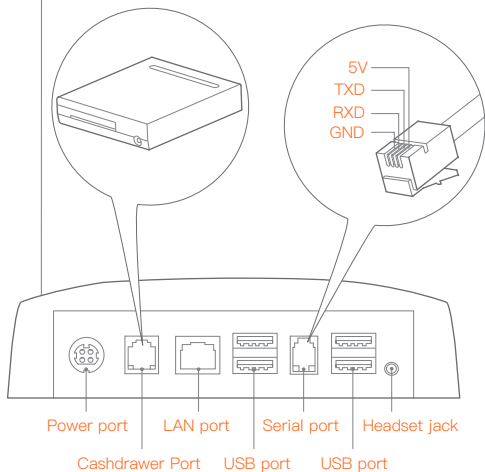

POS Machine Installation

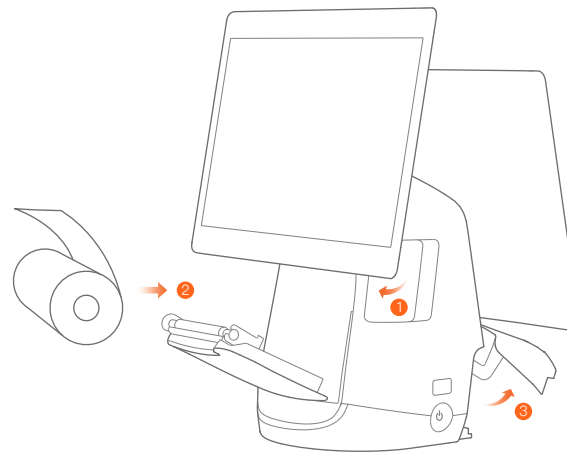

1 Open the paper roller cover

Pull the printer handle out, and the paper roller cover pops out automatically.

2 Install printing paper

Place 80mm thermo-sensitive paper, pull out a section from the paper exit, and then close the paper roller door.

3 Connect the power cable

Connect the power interface of the adapter to the power port at the bottom of the POS. Connect the other end of the adapter to the power socket.

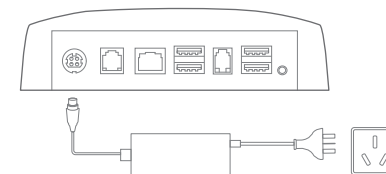

Wrong Operation

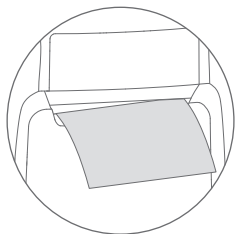

Please do not tilt the printing paper.

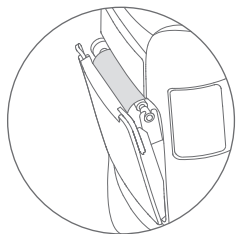

Please do not get printing paper caught in the aperture of the paper case cover by accident.

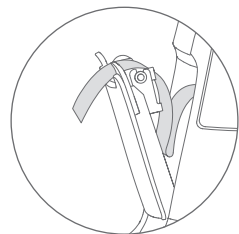

Do not pull the printing paper roll in the paper case tray too long.



Please do not put loose paper into the paper case.

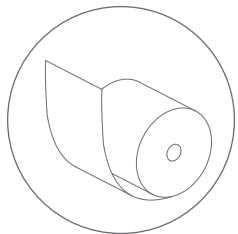

Please pay attention to the correct orientation of the printing paper.

Paper Jammed Troubleshooting

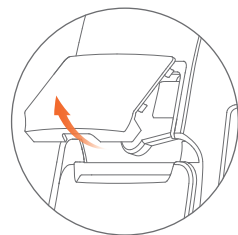

1 Firstly, open outward the cover of the printer cutter

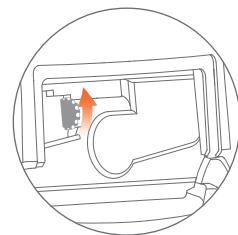

2 Secondly, adjust the cutter knob upwards until it is removed.

Common Troubleshooting

Symptom	Solution
Device Crash	<ul style="list-style-type: none">· Press the power button for 11 seconds to reboot.
Printer Out of Service	<ul style="list-style-type: none">· Make sure the paper roller cover is closed properly;· Please check if it is the paper jam;
If got an empty printout	<ul style="list-style-type: none">· Please check if put the thermal paper in the wrong side;· Please check if you have used the appropriate 80mm width thermal paper;
If got a garbled printout	<ul style="list-style-type: none">· Please check if the print head was not clean, if so, please use a cotton-wool bud with alcohol to clean it;· Please use the thermal paper with high quality to avoid the garbled printout;

Specification

Operating system	Android 9.0
Processor	Qualcomm Snapdragon Qcta-core
Main-screen	15.6-inch FHD1920×1080 resolution
Memory	32GB ROM + 3GB RAM; 64GB ROM + 4GB RAM
Touchscreen	Multi-touch capacitive screen
WiFi	Dual-band WiFi, 802.11a/b/g/n/ac(2.4GHz/5GHz) supported
Bluetooth	Bluetooth 5.0 BLE and iBeacon supported
Printer	80mm printer head, paper roll diameter of 80mm, with an auto-cutter
Speaker	1x 1.2W each
External memory card	MicroSD (TF) supported, maximum 64GB
External ports	5 × USB type-A ports, 1 × RJ11 serial port, 1 × RJ12 24v cashdrawer port, 1 × RJ45 LAN port, 1 × headset jack, 1 × power port, 1 × Micro-USB debugging port
Overall dimensions (H×W×D) cm	40.7 x 38.2 x 23.2cm
Power adapfor	Input: AC 100~240V/1.7A Output: DC 24V/2.5A

Specification of 15.6" customer display

Monitor	15.6-inch FHD1920×1080 resolution
Touchscreen	Multi-touch capacitive screen

Specification of 10.1" customer display

Monitor	10.1-inch 1024×600 resolution
Touchscreen	Multi-touch capacitive screen

Name and Content of Toxic or Harmful Substances in this Product

Part Name	Toxic or Harmful Substances or Elements					
	Lead (Pb)	Mercury (Hg)	Cadmium (Cd)	Hexavalent chromium (Cr(VI))	Polybrominated biphenyls (PBB)	Polybrominated diphenyl ethers (PBDE)
Components of circuit board	×	○	○	○	○	○
Print head component	×	○	○	○	○	○

○ : Means that the content of the toxic or harmful substance in all homogeneous materials of this part is below the limit stipulated in SJ/T11363-2006.

× : Means that the content of the toxic or harmful substance in at least one of the homogeneous materials of this part is beyond the limit stipulated in SJ/T11363-2006; but as for the component marked with "x" on the table, the content is beyond the limit since there is no alternative mature technology in the industry yet.

The products reaching or exceeding the environmental service life shall be recycled per "Regulations on the Control and Management of Electronic Information Products" and shall not be littered.

Package content

T2s Instruction Manual

Precautions

Warning

- Please insert the AC plug into the AC outlet according to the identifying input on the power adapter;
- It is prohibited to use the device in any places with potential explosive gases;
- Nonprofessionals shall not open the power adapter anyhow so as to avoid dangers;
- The device is a Grade A product. In living environment, the product may cause radio interference. Therefore, users may be required to take practical measures against the interference.
- About the battery replacement:
 1. It may cause explosion with wrong type battery
 2. Old battery which is replaced should be handled by repair man, do not put it in fire!
- Adapter shall be installed near the equipment and shall be easily accessible.
- The operating temperature of the device between -10°C to 40°C.
- The device complies with RF specifications when the device used at 20cm from your body.
- This product can be used across EU member states.

Recommendation

- Do not use the device near water or in humid environment.Keep liquid from falling onto the terminal;
- Do not use the device in extremely cold and hot environment, e.g. around fire or lighted cigarettes;
- Do not smash, throw or bend the device;
- Use the device in clean and dustfree environment as much as possible and keep small items from falling into the terminal;
- Do not use it near medical devices unless permitted.

Important Safety Instructions

- Avoid installing or using during thunder and lightning,other wise lightning stroke may occur;
- Cut off the power immediately if there is abnormal smell, overheating or smog;
- Do not touch the sharp paper cutting tool!

Statement

The company is not responsible for the following behaviors:

- Damages caused by using and maintaining the device without following the User Guide;
- Damages or problems caused by selection of objects or Consumables (products which are not the initial ones provided or recognized by the company).
In this case, the company will not undertake any responsibility. No one is entitled to modify or change the product unless permitted by the company.

Disclaimer

Discrepancies between the product and the file concerning details may raise due to product updates. Please be subject to the material object. The company reserves the right to interpret the file and the right to revise this manual without prior notices.

Please make sure the temperature for adapter will be from -10 °C to 40 °C.

Please make sure the temperature for device will be from -10 °C to 40 °C.

FCC Statement

Any Changes or modifications not expressly approved by the party responsible for compliance could void the user's authority to operate the equipment.

This device complies with part 15 of the FCC Rules. Operation is subject to the following two conditions:

- (1) This device may not cause harmful interference, and
- (2) This device must accept any interference received, including interference that may cause undesired operation.

FCC Radiation Exposure Statement:

This equipment complies with FCC radiation exposure limits set forth for an uncontrolled environment .This equipment should be installed and operated with minimum distance 20cm between the radiator& your body.

Note : This equipment has been tested and found to comply with the limits for a Class B digital device, pursuant to part 15 of the FCC Rules. These limits are designed to provide reasonable protection against harmful interference in a residential installation. This equipment generates,uses and can radiate radio frequency energy and, if not installed and used in accordance with the instructions, may cause harmful interference to radio communications. However, there is no guarantee that interference will not occur in a particular installation. If this equipment does cause harmful interference to radio or television reception, which can be determined by turning the equipment off and on, the user is encouraged to try to correct the interference by one or more of the following measures:

- Reorient or relocate the receiving antenna.
- Increase the separation between the equipment and receiver.
- Connect the equipment into an outlet on a circuit different from that to which the receiver is connected.
- Consult the dealer or an experienced radio/TV technician for help.

RF Frequency:

2.4G Wi-Fi: 2412-2462 MHz(b/g/n20), 2422-2452 MHz(n40)

BLE(1Mbps)/BLE(2Mbps): 2402-2480 MHz

BT:2402-2480 MHz

5G Wi-Fi B1: 5150-5250 MHz, B4: 5725-5850 MHz

POS System

User Manual

Three options for sub screen of intelligent POS machine



15.6" main screen only
(L1571)



15.6" main screen+10.1"
customer screen
(L1572)

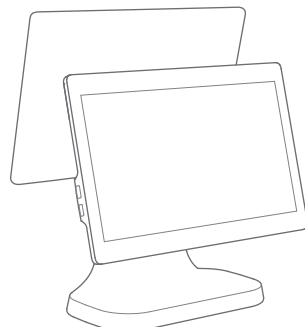

15.6" main screen+15.6"
customer screen
(L1573)

Quick Installation Guide

"Take main screen as sample"



1. Rotate the display to horizontal

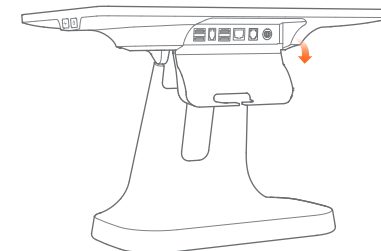

2. Open the port cover

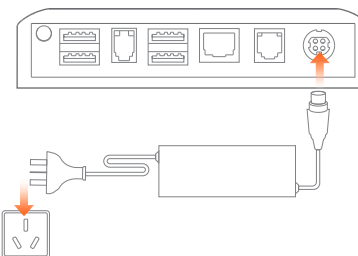

3. Connect the power interface of the
adapter to the power port at the
bottom of the mainframe. And insert
the other side of the adapter to electric
supply sockets

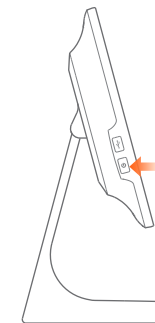

4. Press the power button for
two seconds to turn on

Installation Steps for the VESA Bracket

"Single screen configuration only"

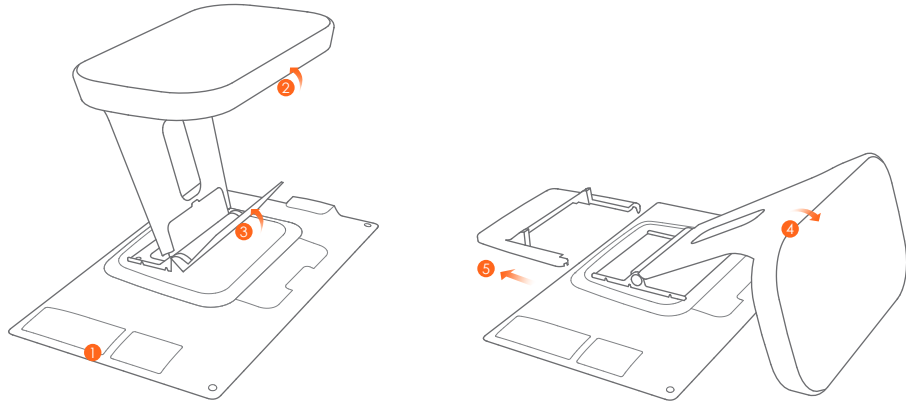

Remove the base

1. Put the display flat on the desktop with its face down.
2. Rotate the metal base to vertical.
3. Remove the lower cover of the bracket.

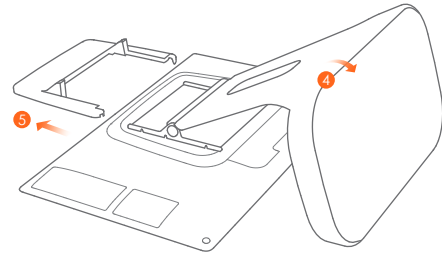

Remove the base

4. Rotate the metal base to horizontal.
5. Remove the upper cover of the bracket.

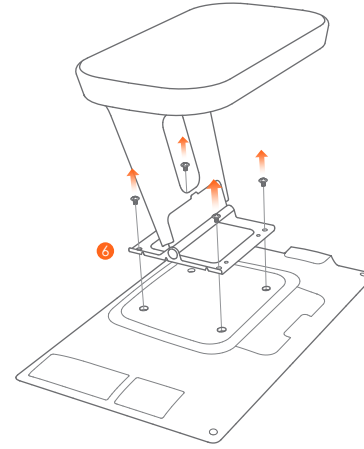

Remove the base

6. Unscrew the four M4 screws with a screwdriver and complete the removal of base.

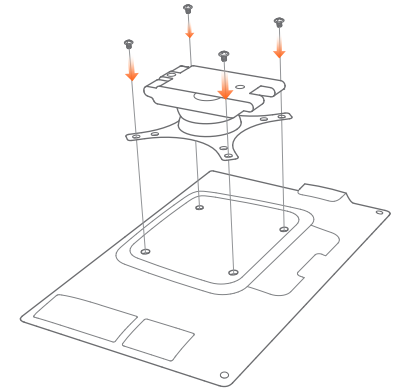

Install VESA accessories

1. Place the VESA bracket aligning the four screw holes according to directions.
2. Use the four M4 screws removed from the base to fix the VESA bracket.
3. Install the bracket on the wall or desk in accordance with VESA bracket instructions to complete the installation.

Note: This machine only supports the installation for VESA MIS-D (100×100mm) suspension bracket. The VESA bracket is an optional accessory which needs to be purchased by the user.

Minimal Settings

Only a few steps to turn on the intelligent business equipment.

- 1 Press the power button and the screen will power on. Enter the first start-up screen and follow the prompts. Two options for Internet access are available.
- 2 Wi-Fi setting.
 - Press [Setting] and start WLAN. Enter the searching interface of WLAN, waiting for WLAN network available;
 - Click on the WLAN to be connected. A password is required for access if an encrypted network is chosen.
- 3 Setting of LAN

How to download/use the application

This POS machine is suitable for cashier environment of business customers of different industries including Chinese and Western foodservice industry, exclusive department store, convenience store, the banking service industry, consulting station, interactive multimedia and advertisement broadcast system, etc. Relevant apps can be scanned, downloaded and installed in the application store with access to the internet.

Please read the built-in Help APP for more help.

Basic Specifications

Operating system	Android 9.0
Processor	Qualcomm snapdragon Qcta-core processor
Display resolution	15.6'' resolution HD 1920 x 1080
Storage	32GB ROM + 3GB RAM or 64GB ROM + 4GB RAM
Touch screen	Multi-touch capacitive display
Wi-Fi	Support 802.11b/g/n/AC 2.4GHz/5GHz
Bluetooth	Support Bluetooth 3.0/4.0/5.0 and iBeacon
Loudspeaker	Single 1.2W voice reaches 90db
External interface	5 x USB Type A interfaces, 1x RJ11 serial interface, 1 x RJ12 24V cash drawer interface, 1x RJ45 LAN interface, 1 x headset jack, 1x power port, 1x Micro-USB debug interface
External storage card	MicroSD (TF), 64G maximum
VESA (limited main screen only)	In accordance with VESA MIS-D 100×100mm Standard
Item dimension	H 35cm × W 38cm × T 17cm
AC adapter	Input:AC 100~240V,50/60Hz,1.5A Output:DC 24V,1.5A

Specification of 15.6" customer display (optional)

Display resolution	15.6'' resolution HD 1920 x 1080
Touch screen	Multi-touch capacitive display

Specification of 10.1" customer display (optional)

Display resolution	10.1'' resolution HD 1024 x 600
Touch screen	Multi-touch capacitive display

Configurations and parameters listed in this page are indicative and actual products on the market shall prevail.

Precautions

Warning

- Please insert the AC plug into the AC outlet according to the identifying input on the power adapter;
- It is prohibited to use the device in any places with potential explosive gases;
- Nonprofessionals shall not open the power adapter anyhow so as to avoid dangers;
- The device is a Grade A product. In living environment, the product may cause radio interference. Therefore, users may be required to take practical measures against the interference.
- About the battery replacement:
 1. It may cause explosion with wrong type battery
 2. Old battery which is replaced should be handled by repair man, do not put it in fire!
- Adapter shall be installed near the equipment and shall be easily accessible.
- The operating temperature of the device between 0°C to 45°C.
- The device complies with RF specifications when the device used at 20cm from your body.
- This product can be used across EU member states.

Recommendation

- Do not use the device near water or in humid environment. Keep liquid from falling onto the terminal;
- Do not use the device in extremely cold and hot environment, e.g. around fire or lighted cigarettes;
- Do not smash, throw or bend the device;
- Use the device in clean and dustfree environment as much as possible and keep small items from falling into the terminal;
- Do not use it near medical devices unless permitted.

Important Safety Instructions

- Avoid installing or using during thunder and lightning, otherwise lightning stroke may occur;
- Cut off the power immediately if there is abnormal smell, overheating or smog!

Statement

The company is not responsible for the following behaviors:

- Damages caused by using and maintaining the device without following the User Guide;
- Damages or problems caused by selection of objects or Consumables (products which are not the initial ones provided or recognized by the company).
In this case, the company will not undertake any responsibility.
- No one is entitled to modify or change the product unless permitted by the company.

Disclaimer

Discrepancies between the product and the file concerning details may raise due to product updates. Please be subject to the material object. The company reserves the right to interpret the file and the right to revise this manual without prior notices.

Please make sure the temperature for adapter will be from -10 °C to 40 °C.

Please make sure the temperature for device will be from -10 °C to 40 °C.

Name and content of toxic and harmful substances contained in this product are shown in the following table

Name of parts	Toxic and harmful substances and elements					
	(Pb)	(Hg)	(Cd)	(Cr(VI))	(PBB)	(PBDE)
Circuit board	×	○	○	○	○	○
Shell	○	○	○	○	○	○

- :It indicates that the content of toxic and harmful substances in all homogeneous materials of this part is below the limit specified in SJ/T11363-2006.
- × :It indicates that the content of toxic and harmful substances is higher than the limit specified in SJ/T11363-2006 in at least one homogeneous material of this part; however, the reason why the toxic substance of that part exceeds the limit is that there is no applicable material to replace it currently.

For products that have reached or passed the service years for environmental protection, they should be recycled according to Measures for Control and Management of Electronic Information Products and should not be thrown away at will.

Package content

- 1 × main machine
- 1 × user manual
- 1 × power adapter

Manufacture

Room 505, KIC Plaza, No.388 Song Hu Road, Yang Pu District, Shanghai, China

EU Regulatory Conformance

Hereby, Shanghai Sunmi Technology Co., Ltd. declares that the radio equipment type is in compliance with Directive 2014/53/EU.

The full text of the EU declaration of conformity is available at the following internet address: www.sunmi.com



Notice: Observe the national local regulations in the location where the device is to be used. This device may be restricted for use in some or all member states of the European Union (EU).

Adapter shall be installed near the equipment and shall be easily accessible.

The operating temperature of the device between -10 C to 40 C.

The device complies with RF specifications when the device used at 20cm from your body

This product can be used across EU member states.

FCC Regulations:

FCC Statement

Any Changes or modifications not expressly approved by the party responsible for compliance could void the user's authority to operate the equipment.

This device complies with part 15 of the FCC Rules. Operation is subject to the following two conditions:

- (1) This device may not cause harmful interference, and
- (2) This device must accept any interference received, including interference that may cause undesired operation.

FCC Radiation Exposure Statement:

This equipment complies with FCC radiation exposure limits set forth for an uncontrolled environment. This equipment should be installed and operated with minimum distance 20cm between the radiator & your body.

Note : This equipment has been tested and found to comply with the limits for a Class B digital device, pursuant to part 15 of the FCC Rules. These limits are designed to provide reasonable protection against harmful interference in a residential installation. This equipment generates, uses and can radiate radio frequency energy and, if not installed and used in accordance with the instructions, may cause harmful interference to radio communications. However, there is no guarantee that interference will not occur in a particular installation. If this equipment does cause harmful interference to radio or television reception, which can be determined by turning the equipment off and on, the user is encouraged to try to correct the interference by one or more of the following measures:

- Reorient or relocate the receiving antenna.
- Increase the separation between the equipment and receiver.
- Connect the equipment into an outlet on a circuit different from that to which the receiver is connected.
- Consult the dealer or an experienced radio/TV technician for help.

Technical features and characteristic

the product includes the following features and characteristics□

Caution: Changes or modifications not expressly approved by the party responsible for compliance could void the user's authority to operate the equipment.