



# TEST REPORT

**No. I18D00189-EMC01**

*For*

**Client : Shanghai Sunmi Technology Co.,Ltd.**

**Production: POS System**

**Model Name : L1321/L1323**

**Brand Name: SUNMI**

**FCC ID: 2AH25T2MININFC**

**Hardware Version: V1.03**

**Software Version: MST2MINI\_EQ000\_2EE0.123BBE2.953076**

**2\_180824\_100\_V01\_T15**

**Issued date: 2018-12-20**

**Note:**

The test results in this test report relate only to the devices specified in this report. This report shall not be reproduced except in full without the written approval of ECIT Shanghai.

**Test Laboratory:**

ECIT Shanghai, East China Institute of Telecommunications

Add: 7F, G Area, No.668, Beijing East Road, Huangpu District, Shanghai, P. R. China

Tel: (+86)-021-63843300, E-Mail: [welcome@ecit.org.cn](mailto:welcome@ecit.org.cn)

### Revision Version

Report Number	Revision	Date	Memo
I18D00189-EMC01	00	2018-12-10	Initial creation of test report
I18D00189-EMC01	01	2018-12-20	Second creation of test report

## CONTENTS

<b>1. TEST LABORATORY .....</b>	<b>5</b>
<b>1.1. TESTING LOCATION .....</b>	<b>5</b>
<b>1.2. TESTING ENVIRONMENT .....</b>	<b>5</b>
<b>1.3. PROJECT DATA.....</b>	<b>5</b>
<b>1.4. SIGNATURE.....</b>	<b>5</b>
<b>2. CLIENT INFORMATION .....</b>	<b>6</b>
<b>2.1. APPLICANT INFORMATION.....</b>	<b>6</b>
<b>2.2. MANUFACTURER INFORMATION.....</b>	<b>6</b>
<b>3. EQUIPMENT UNDER TEST (EUT) AND ANCILLARY EQUIPMENT (AE) .....</b>	<b>7</b>
<b>3.1. ABOUT EUT.....</b>	<b>7</b>
<b>3.2. INTERNAL IDENTIFICATION OF EUT USED DURING THE TEST .....</b>	<b>7</b>
<b>3.3. INTERNAL IDENTIFICATION OF AE USED DURING THE TEST .....</b>	<b>7</b>
<b>4. REFERENCE DOCUMENTS.....</b>	<b>8</b>
<b>4.1. REFERENCE DOCUMENTS FOR TESTING .....</b>	<b>8</b>
<b>5. TEST RESULTS.....</b>	<b>9</b>
<b>5.1. SUMMARY OF TEST RESULTS.....</b>	<b>9</b>
<b>5.2. STATEMENTS.....</b>	<b>9</b>
<b>6. TEST EQUIPMENTS UTILIZED.....</b>	<b>10</b>
<b>6.1 RADIATED EMISSION EQUIPMENTS LIST.....</b>	<b>10</b>
<b>6.2 AC CONDUCTED EMISSION EQUIPMENTS LIST .....</b>	<b>10</b>
<b>7. SYSTEM CONFIGURATION DURING TEST.....</b>	<b>11</b>
<b>7.1 TEST MODE.....</b>	<b>11</b>
<b>7.2 CONNECTION DIAGRAM OF TEST SYSTEM.....</b>	<b>12</b>
<b>8. MEASUREMENT RESULTS.....</b>	<b>13</b>
<b>8.1 RADIATED EMISSION 30MHZ-18GHZ.....</b>	<b>13</b>

**8.2 AC CONDUCTED EMISSION..... 20**

## 1. Test Laboratory

### 1.1. Testing Location

Company Name: ECIT Shanghai, East China Institute of Telecommunications  
Address: 7F, G Area, No. 668, Beijing East Road, Huangpu District, Shanghai,  
P. R. China  
Postal Code: 200001  
Telephone: 86-21-63843300  
Fax: 86-21-63843301  
FCC registration No: 958356

### 1.2. Testing Environment

Normal Temperature: 15-35°C  
Relative Humidity: 30-60%RH

### 1.3. Project data

Project Leader: Zhou Yan  
Testing Start Date: 2018-09-28  
Testing End Date: 2018-11-29

### 1.4. Signature



Qin Yabin

(Prepared this test report)



You Jinjun

(Reviewed this test report)

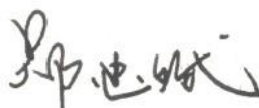

Zheng Zhongbin

(Approved this test report)

## 2. Client Information

### 2.1. Applicant Information

Company Name: Shanghai Sunmi Technology Co.,Ltd.  
Address : Room 505, KIC Plaza, No.388 Song Hu Road, Yang Pu District,  
Shanghai, China  
Telephone: 8618721763396  
Postcode: 200433

### 2.2. Manufacturer Information

Company Name: Shanghai Sunmi Technology Co.,Ltd.  
Address : Room 505, KIC Plaza, No.388 Song Hu Road, Yang Pu District,  
Shanghai, China  
Telephone: 8618721763396  
Postcode: 200433

### 3. Equipment under Test (EUT) and Ancillary Equipment (AE)

#### 3.1. About EUT

ProductName	POS System
Model name	L1321/L1323
GSM Frequency Band	GSM850/GSM1900
UMTS Frequency Band	WCDMA Band II / V
CDMA Frequency Band	BC0
LTE Frequency Band	LTE 38/41
Additional Communication Function	BT4.0, BLE; WIFI 802.11b,g,n; NFC;

#### 3.2. Internal Identification of EUT used during the test

EUT ID*	SN or IMEI	HW Version	SW Version	Date of receipt
N08(L1321)	/	V1.03	MST2MINI_EQ000_2EE0.123BB E2.9530762_180824_100_V01_T 15	2018-09-17
N01(L1323)	/	V1.03	MST2MINI_EQ000_2EE0.123BB E2.9530762_180824_100_V01_T 15	2018-09-17

\*EUT ID: is used to identify the test sample in the lab internally.

#### 3.3. Internal Identification of AE used during the test

AE ID*	Description	Model	SN
CA04	Adapter	TPA—97050100UU	/
UA01	AC Cable	/	/
EA02	IOIOI Cable	/	/
AE1	USB Cable	/	/
AE2	LAN Cable	/	/
AE3	Cash Box	/	/
AE4	Keyboard	/	/
AE5	Mouse	/	/
AE6	Notebook PC	DELL Latitude E6510	/
AE7	SanDisk Ultra32GB	MicroSDHC UHS-I	/
AE8	U disk	DT101 G2	/
AE9	Earphone	/	/
AE10	USB Cable	/	/

\*AE ID: is used to identify the test sample in the lab internally.

## 4. Reference Documents

### 4.1. Reference Documents for testing

The following documents listed in this section are referred for testing.

Reference	Title	Version
FCC Part 15, Subpart B	Radio frequency devices	10-1-17 Edition
ANSI C63.4	Method of Measurement of Radio-Noise Emissions from Low-Voltage Electrical and Electronic Equipment in the Range of 9 kHz to 40 GHz	2014



## 5. Test Results

### 5.1. Summary of Test Results

Items	Test List	Clause in FCC rules	Verdict
1	Radiated Emission	15.109(a)	Pass
2	AC Conducted Emission	15.107(a)	Pass

### 5.2. Statements

The L1321/L1323, supporting GSM/WCDMA/CDMA/LTE/BT/WLAN/NFC.etc, manufactured by Shanghai Sunmi Technology Co.,Ltd. is a new product for testing. ECIT only performed test cases which identified with Pass/Fail/Inc result in section 5.1.

ECIT has verified that the compliance of the tested device specified in section 3 of this test report is successfully evaluated according to the procedure and test methods as defined in type certification requirement listed in section 4 of this test report.

Note: This project have two models of sample, one with 58 printer (N08\_L1321), the other with 80 printer (N01\_L1323). We mainly tested the sample with 58 printer (N08), and the other sample (N01) we tested worst case.

## 6. Test Equipments Utilized

### 6.1 Radiated Emission Equipments list

No.	Name	Type	Series Number	Producer	Cal. Date	Cal. interval
1	Universal Radio Communication	CMU200	123126	R&S	2018-05-11	1 Year
2	Test Receiver	ESU40	100307	R&S	2018-05-11	1 Year
3	Trilog Antenna	VULB9163	VULB9163-515	Schwarzbeck	2017-02-25	3 Year
4	Double Ridged Guide	ETS-3117	00135890	ETS	2017-01-11	3 Year
5	EMI Test Software	EMC32 V9.15	NA	R&S	NA	NA

### 6.2 AC Conducted Emission Equipments list

No.	Name	Type	Series Number	Producer	Cal. Date	Cal. interval
1	Universal Radio	CMU200	123123	R&S	2018-05-11	1 Year
2	Test Receiver	ESCI	101235	R&S	2018-05-11	1 Year
3	2-Line V-Network	ENV216	101380	R&S	2018-05-11	1 Year
4	EMI Test Software	EMC32 V10.35.02	NA	R&S	NA	NA

## 7. System Configuration during Test

### 7.1 Test Mode

#### N08 Sample (L1321)

Test Item	Function Type
AC Conducted Emission	Mode 1: Working mode _Full system <Figure 1> Mode 2: Data link mode<Figure 2>
Radiated Emission	Mode 1: Working mode _Full system <Figure 1> Mode 2: Data link mode<Figure 2>
Remark: 1. All test modes are performed, only the worst cases test data are recorded in this report. 2. Data Link with PC means data application transferred mode between EUT and PC.	

#### N01 Sample (L1323)

Test Item	Function Type
AC Conducted Emission	Mode 1: Working mode _Full system <Figure 1> Mode 2: Data link mode<Figure 2>
Radiated Emission	Mode 2: Data link mode<Figure 2>
Remark: 3. All test modes are performed, only the worst cases test data are recorded in this report. 4. Data Link with PC means data application transferred mode between EUT and PC.	

**Note:** The full system include LAN cable, cash box, keyboard, mouse, earphone, printer, U disk , POS and notebook PC.

### 7.2 Connection Diagram of Test System

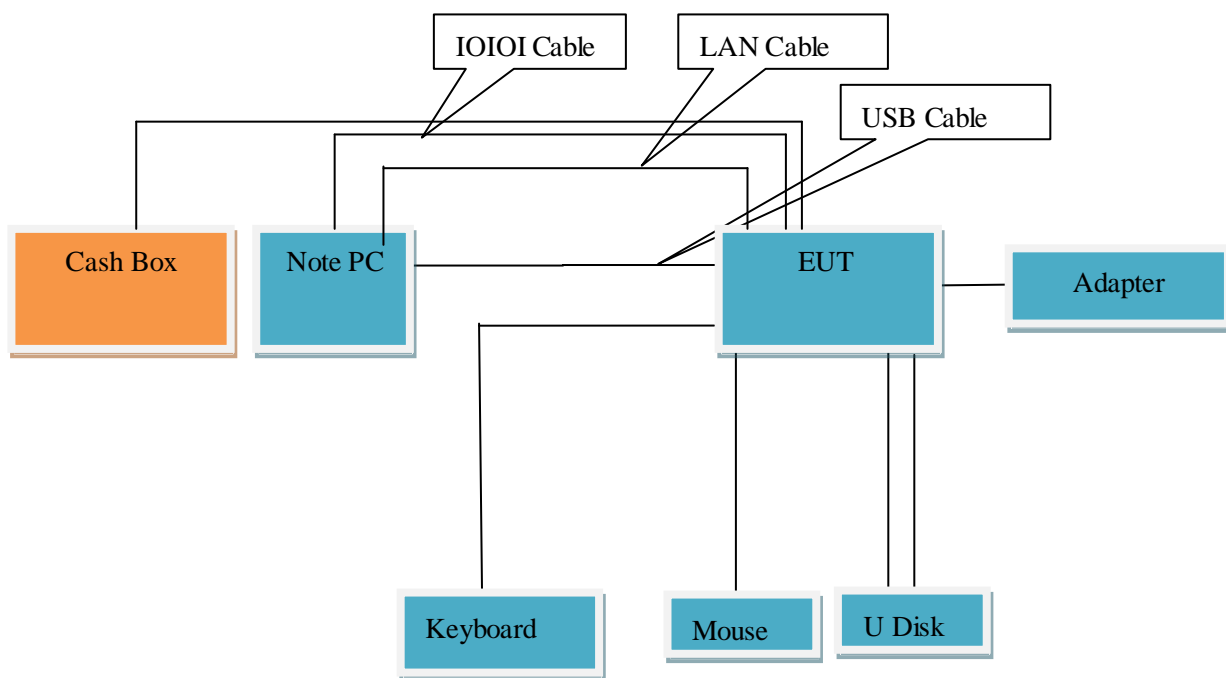

<Figure 1>Mode 1

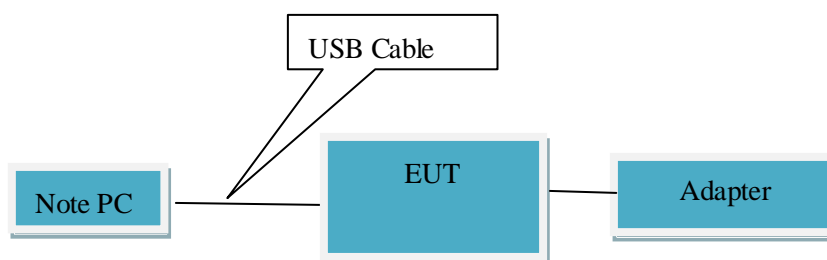

<Figure 2>Mode 2

## 8. Measurement Results

Only the worst test result was shown in this report.

### 8.1 Radiated Emission 30MHz-18GHz

#### Method of Measurement

For 30MHz -1000MHz, the EUT was placed on the top of a rotating 0.8-m table above the ground at a semi-anechoic chamber. The distance between the EUT and the received antenna was 3 meters. The table was rotated 360 degree and the received antenna mounted on a variable-height antenna tower was varied from 1m to 4m to find the maximum value of the field strength. Both horizontal and vertical polarizations of the antenna were set during the measurement. Tested in accordance with the procedures of ANSI C63.4-2014, section 8.3.

For 1000MHz -18000MHz, The maximal emission value was acquired by adjusting the antenna height, The table was rotated 360 degree to determine the maximum value of the field strength. Both horizontal and vertical polarizations of the antenna were set during the measurement.

#### Limits for Radiated Emission at a measuring distance of 3m

Frequency Range (MHz)	Quasi-Peak (dBuV/m)
30-88	40
88-216	43.5
216-960	46
Above 960	54

Frequency Range (MHz)	Peak (dBuV/m)	Average (dBuV/m)
Above 1000	74	54

#### Test conditions

Frequency Range (MHz)	RBW/VBW	Sweep Time (s)
30-1000	120kHz/300kHz	Auto
1000-18000	1MHz/3MHz	Auto

#### Uncertainty Measurement

The measurement uncertainty is 4.98dB (30MHz -1000MHz) and 5.06dB (1GHz -18GHz) (k=2)

## Test Results

N08 Sample Mode 2: Data link mode<Figure 2>

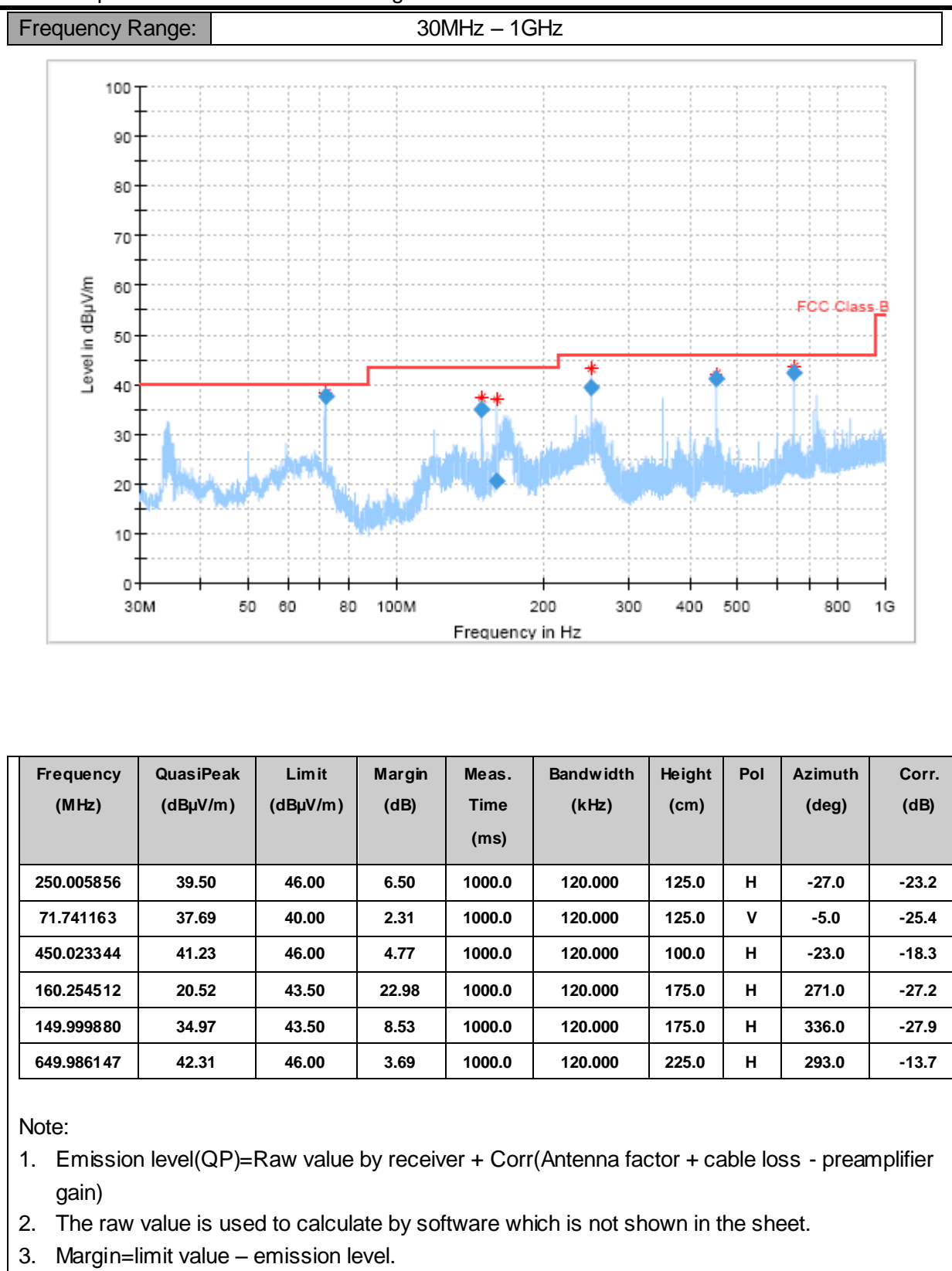

N01 Sample Mode 2: Data link mode<Figure 2>

Frequency Range:

30MHz – 1GHz

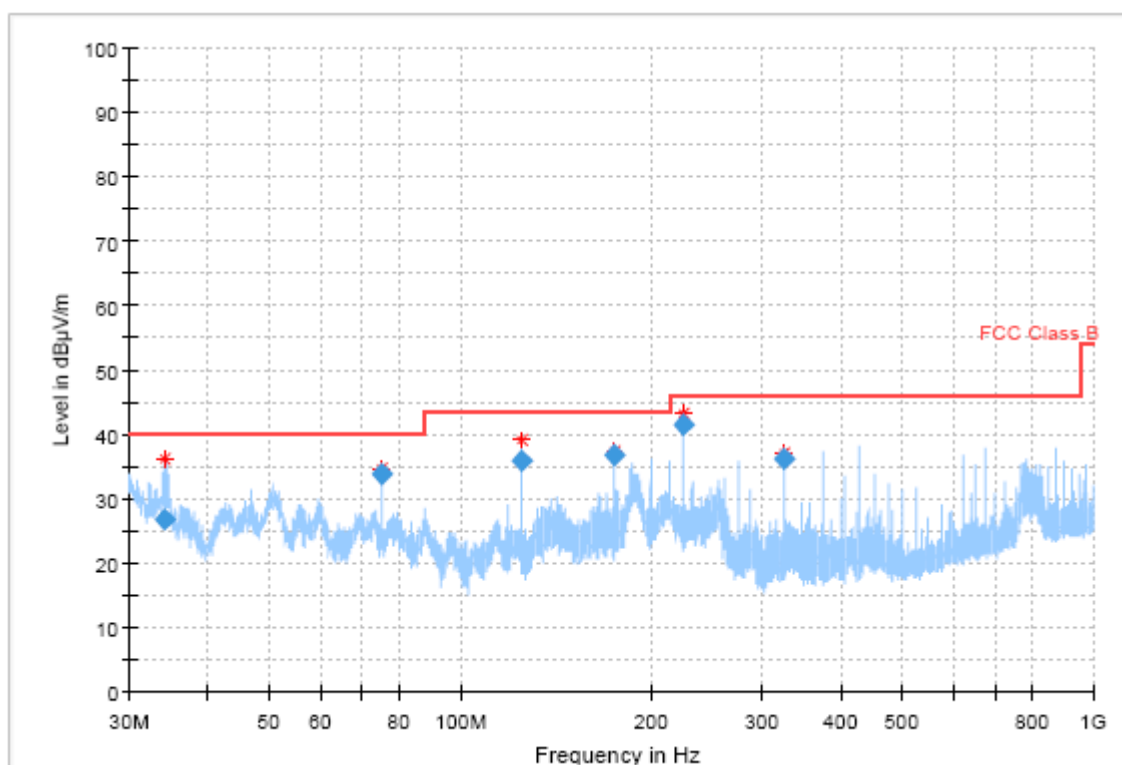

Frequency (MHz)	QuasiPeak (dBµV/m)	Limit (dBµV/m)	Margin (dB)	Meas. Time (ms)	Bandwidth (kHz)	Height (cm)	Pol	Azimuth (deg)	Corr. (dB)
34.082533	26.87	40.00	13.13	1000.0	120.000	100.0	V	70.0	-22.0
74.996315	33.87	40.00	6.13	1000.0	120.000	125.0	V	54.0	-26.2
124.991285	35.97	43.50	7.53	1000.0	120.000	175.0	H	96.0	-26.6
175.018067	36.78	43.50	6.72	1000.0	120.000	180.0	H	-1.0	-26.0
224.995421	41.56	46.00	4.44	1000.0	120.000	180.0	H	330.0	-23.8
324.997229	36.18	46.00	9.82	1000.0	120.000	100.0	H	-23.0	-21.4

Note:

1. Emission level(QP)=Raw value by receiver + Corr(Antenna factor + cable loss - preamplifier gain)
2. The raw value is used to calculate by software which is not shown in the sheet.
3. Margin=limit value – emission level.

N08 Sample Mode 1: Working mode \_Full system <Figure 1>

Frequency Range:	1GHz –18GHz, Horizontal
------------------	-------------------------

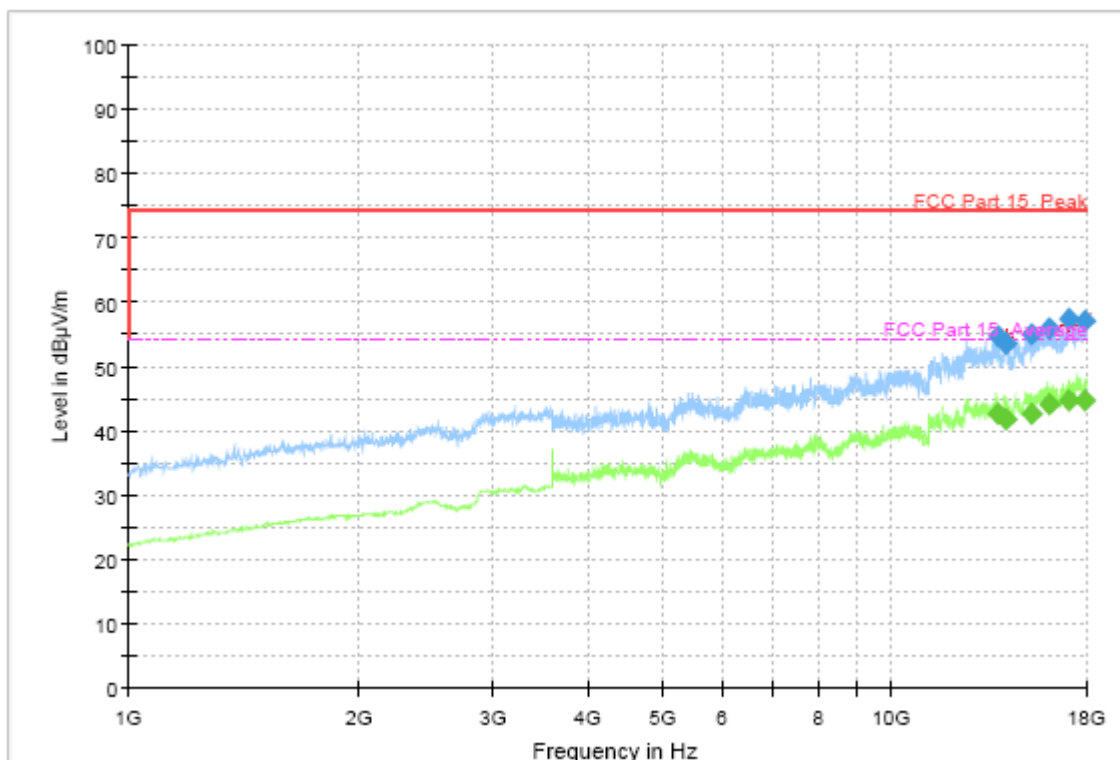

## Final Result

Frequency (MHz)	MaxPeak (dBuV/m)	Average (dBuV/m)	Limit (dBuV/m)	Margin	Meas. Time	Bandwidth	Height	Po I	Azimuth	Corr. (dB)
13736.200000	54.76	---	74.00	19.24	100.0	1000.000	200.0	H	359.0	18.8
13736.200000	---	42.54	54.00	11.46	100.0	1000.000	200.0	H	359.0	18.8
14093.800000	53.57	---	74.00	20.43	100.0	1000.000	100.0	H	146.0	19.3
14093.800000	---	41.65	54.00	12.35	100.0	1000.000	100.0	H	146.0	19.3
15263.600000	54.89	---	74.00	19.11	100.0	1000.000	200.0	H	175.0	20.7
15263.600000	---	42.78	54.00	11.22	100.0	1000.000	200.0	H	175.0	20.7
16102.200000	55.79	---	74.00	18.21	100.0	1000.000	200.0	H	222.0	22.5
16102.200000	---	44.18	54.00	9.82	100.0	1000.000	200.0	H	222.0	22.5
17071.200000	57.48	---	74.00	16.52	100.0	1000.000	100.0	H	7.0	23.9
17071.200000	---	44.79	54.00	9.21	100.0	1000.000	100.0	H	7.0	23.9
17890.600000	56.99	---	74.00	17.01	100.0	1000.000	100.0	H	0.0	24.4
17890.600000	---	44.61	54.00	9.39	100.0	1000.000	100.0	H	0.0	24.4

Note:

1. Emission level(peak or average)=Raw value by receiver + Corr(Antenna factor+ cable loss - preamplifier gain)
2. The raw value is used to calculate by software which is not shown in the sheet.
3. Margin=limit value – emission level.



Frequency Range:

1GHz –18GHz, Vertical

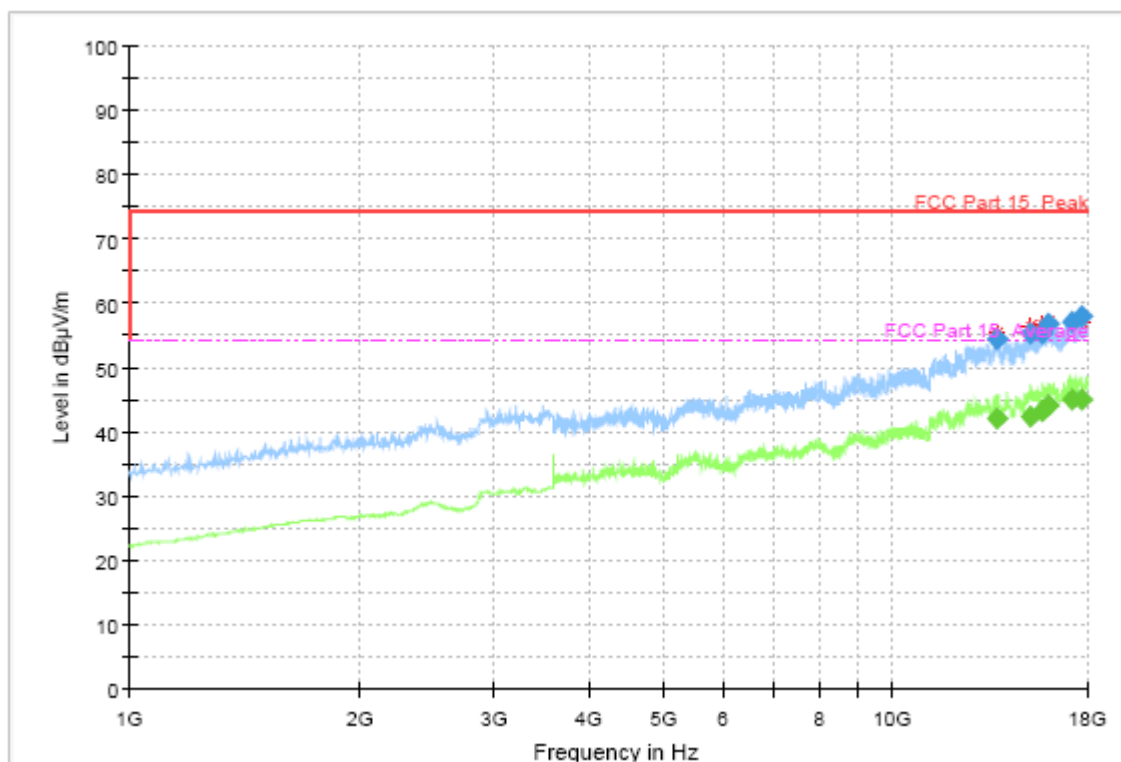

## Final Result

Frequency (MHz)	MaxPeak (dBuV/m)	Average (dBuV/m)	Limit (dBuV/m)	Margin (dB)	Meas. Time	Bandwidth (h)	Height (t)	Po (l)	Azimuth	Corr. (dB)
13691.600000	---	42.10	54.00	11.90	100.0	1000.000	200.0	V	0.0	18.8
13691.600000	54.43	---	74.00	19.57	100.0	1000.000	200.0	V	0.0	18.8
15191.000000	---	42.35	54.00	11.65	100.0	1000.000	100.0	V	76.0	20.7
15191.000000	55.28	---	74.00	18.72	100.0	1000.000	100.0	V	76.0	20.7
15661.000000	55.23	---	74.00	18.77	100.0	1000.000	200.0	V	330.0	21.6
15661.000000	---	43.17	54.00	10.83	100.0	1000.000	200.0	V	330.0	21.6
16020.800000	---	44.14	54.00	9.86	100.0	1000.000	200.0	V	121.0	22.4
16020.800000	56.77	---	74.00	17.23	100.0	1000.000	200.0	V	121.0	22.4
17144.000000	---	44.90	54.00	9.10	100.0	1000.000	200.0	V	214.0	24.1
17144.000000	57.06	---	74.00	16.94	100.0	1000.000	200.0	V	214.0	24.1
17689.800000	57.85	---	74.00	16.15	100.0	1000.000	100.0	V	98.0	24.3
17689.800000	---	44.89	54.00	9.11	100.0	1000.000	100.0	V	98.0	24.3

Note:

1. Emission level(peak or average)=Raw value by receiver + Corr(Antenna factor+ cable loss - preamplifier gain)
2. The raw value is used to calculate by software which is not shown in the sheet.
3. Margin=limit value – emission level.

N08 Sample Mode 1: Working mode Full system <Figure 1>

N01 Sample Mode 1: Working mode \_Full system <Figure 1>

Frequency Range:	1GHz –18GHz, Horizontal
------------------	-------------------------

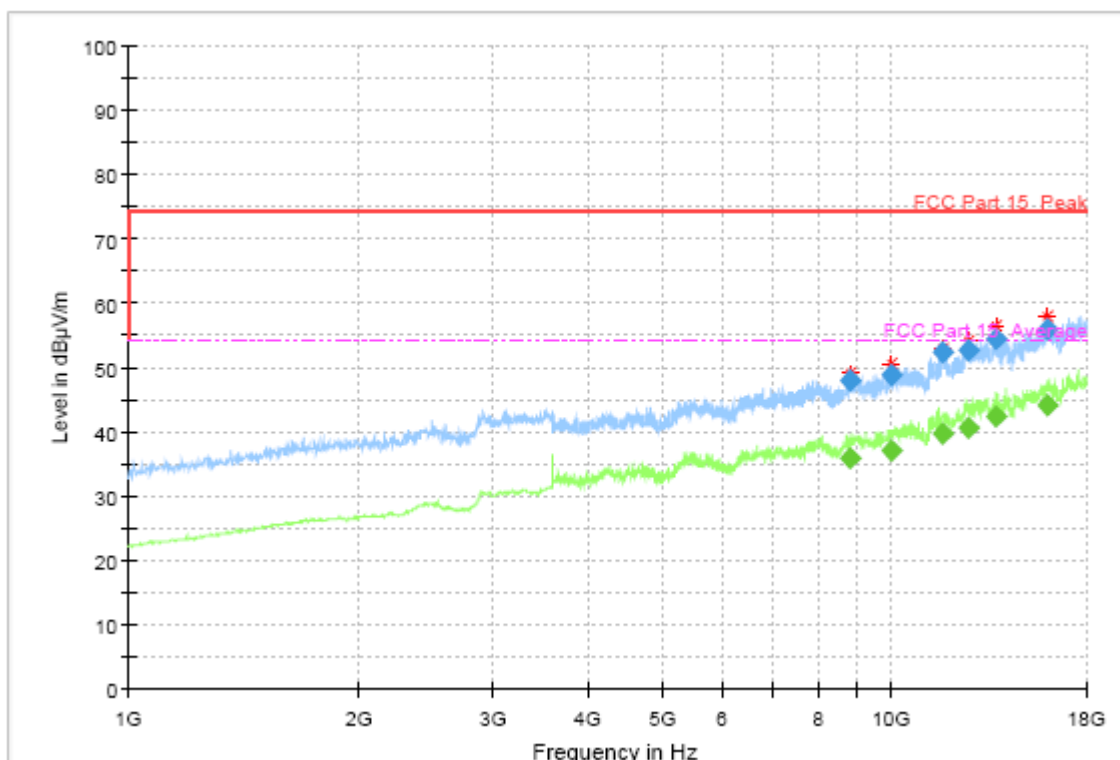

## Final Result

Frequency (MHz)	MaxPeak (dBuV/m)	Average (dBuV/m)	Limit (dBuV/m)	Margin (dB)	Meas. Time	Bandwidth (Hz)	Height (m)	Po (l)	Azimuth	Corr. (dB)
8806.400000	48.01	---	74.00	25.99	100.0	1000.000	100.0	H	162.0	9.7
8806.400000	---	35.93	54.00	18.07	100.0	1000.000	100.0	H	162.0	9.7
9985.800000	---	37.18	54.00	16.82	100.0	1000.000	198.0	H	315.0	11.3
9985.800000	48.86	---	74.00	25.14	100.0	1000.000	198.0	H	315.0	11.3
11653.200000	52.34	---	74.00	21.66	100.0	1000.000	100.0	H	36.0	15.2
11653.200000	---	39.64	54.00	14.36	100.0	1000.000	100.0	H	36.0	15.2
12620.200000	52.72	---	74.00	21.28	100.0	1000.000	198.0	H	245.0	16.8
12620.200000	---	40.65	54.00	13.35	100.0	1000.000	198.0	H	245.0	16.8
13730.400000	54.46	---	74.00	19.54	100.0	1000.000	198.0	H	210.0	18.8
13730.400000	---	42.22	54.00	11.78	100.0	1000.000	198.0	H	210.0	18.8
16003.200000	---	44.11	54.00	9.89	100.0	1000.000	100.0	H	24.0	22.3
16003.200000	55.74	---	74.00	18.26	100.0	1000.000	100.0	H	24.0	22.3

Note:

1. Emission level(peak or average)=Raw value by receiver + Corr(Antenna factor+ cable loss - preamplifier gain)
2. The raw value is used to calculate by software which is not shown in the sheet.
3. Margin=limit value – emission level.

Frequency Range:

1GHz –18GHz, Vertical

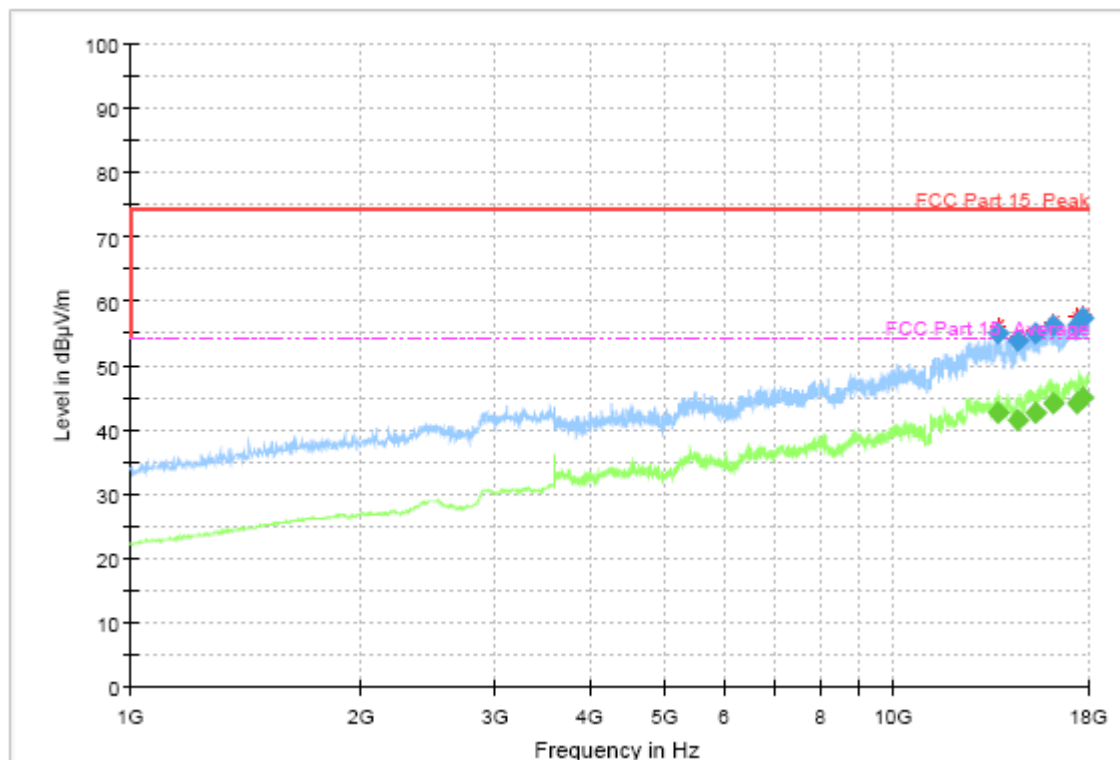

## Final Result

Frequency (MHz)	MaxPeak (dBuV/m)	Average (dBuV/m)	Limit (dBuV/m)	Margin (dB)	Meas. Time	Bandwidth (h)	Height (t)	Po (l)	Azimuth	Corr. (dB)
13691.800000	---	42.62	54.00	11.38	100.0	1000.000	100.0	V	177.0	18.8
13691.800000	54.94	---	74.00	19.06	100.0	1000.000	100.0	V	177.0	18.8
14492.200000	53.88	---	74.00	20.12	100.0	1000.000	100.0	V	7.0	19.1
14492.200000	---	41.44	54.00	12.56	100.0	1000.000	100.0	V	7.0	19.1
15330.200000	---	42.59	54.00	11.41	100.0	1000.000	100.0	V	154.0	20.9
15330.200000	54.90	---	74.00	19.10	100.0	1000.000	100.0	V	154.0	20.9
16126.000000	56.13	---	74.00	17.87	100.0	1000.000	200.0	V	288.0	22.4
16126.000000	---	44.14	54.00	9.86	100.0	1000.000	200.0	V	288.0	22.4
17392.400000	56.23	---	74.00	17.77	100.0	1000.000	200.0	V	346.0	24.1
17392.400000	---	44.21	54.00	9.79	100.0	1000.000	200.0	V	346.0	24.1
17653.400000	57.41	---	74.00	16.59	100.0	1000.000	198.0	V	107.0	24.4
17653.400000	---	45.02	54.00	8.98	100.0	1000.000	198.0	V	107.0	24.4

Note:

1. Emission level(peak or average)=Raw value by receiver + Corr(Antenna factor+ cable loss - preamplifier gain)
2. The raw value is used to calculate by software which is not shown in the sheet.
3. Margin=limit value – emission level.

## 8.2 AC Conducted Emission

### Method of Measurement

For equipment that is designed to be connected to the public utility (AC) power line, the radio frequency voltage that is conducted back onto the AC power line on any frequency or frequencies with the band 150 kHz to 30MHz shall not exceed the limits. Both lines of the power mains connected to the EUT were checked for maximum conducted interference. Tested in accordance with the procedures of ANSI C63.4-2014, section 7.3

### Limit of AC Conducted Emission

Frequency Range (MHz)	Conducted Limit (dBuV)	
	Quasi-peak	Average
0.15-0.5	66 to 56*	56 to 46*
0.5-5	56	46
5-30	60	50

\*Decreases with the logarithm of the frequency

### Test Condition in Charging Mode

Voltage (V)	Frequency (Hz)	RBW	Sweep Time (s)
120	60	9 kHz	Auto

### Uncertainty Measurement

The measurement uncertainty is 3.66dB (k=2).

### Test Results

N08 Sample Mode 2: Data link mode<Figure 2>

Frequency Range:

150kHz – 30MHz

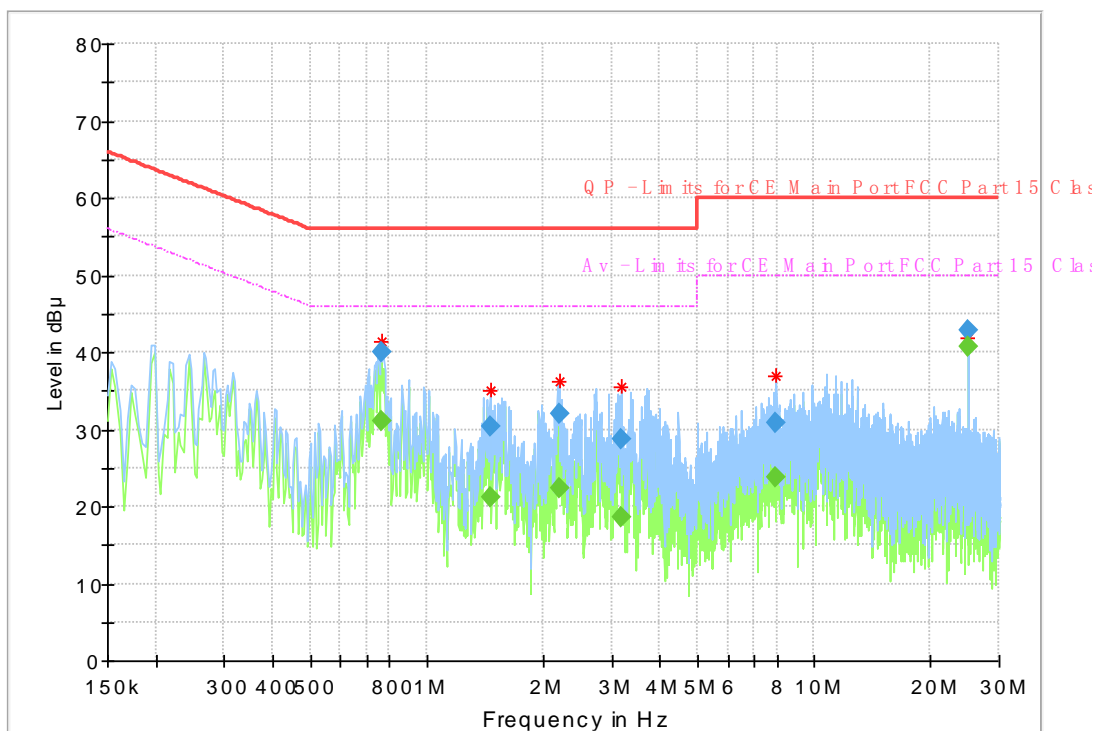

Frequency (MHz)	QuasiPeak (dBµ V)	Average (dBµ V)	Limit (dBµ V)	Margin (dB)	Meas. Time	Bandwidth (kHz)	Line	Filter	Corr. (dB)
0.761925	---	30.95	46.00	15.05	1000.0	9.000	L1	ON	9.7
0.761925	40.11	---	56.00	15.89	1000.0	9.000	L1	ON	9.7
1.455938	30.44	---	56.00	25.56	1000.0	9.000	N	ON	9.7
1.455938	---	21.12	46.00	24.88	1000.0	9.000	N	ON	9.7
2.194725	---	22.33	46.00	23.67	1000.0	9.000	L1	ON	9.7
2.194725	32.04	---	56.00	23.96	1000.0	9.000	L1	ON	9.7
3.183506	---	18.63	46.00	27.37	1000.0	9.000	N	ON	9.7
3.183506	28.79	---	56.00	27.21	1000.0	9.000	N	ON	9.7
7.993088	30.79	---	60.00	29.21	1000.0	9.000	L1	ON	9.8
7.993088	---	23.86	50.00	26.14	1000.0	9.000	L1	ON	9.8
25.000125	---	40.59	50.00	9.41	1000.0	9.000	N	ON	9.9
25.000125	42.72	---	60.00	17.28	1000.0	9.000	N	ON	9.9

Note:

1. Emission level(quasi-peak or Average peak)=Raw value by receiver + Corr(Insertion loss+ cable loss)
2. The raw value is used to calculate by software which is not shown in the sheet.
3. Margin=limit value – emission level.
4. L1 and N line is all have been tested, the result of them is synthesized in the above data diagram.

N01 Sample Mode 2: Data link mode<Figure 2>

Frequency Range: 150kHz – 30MHz

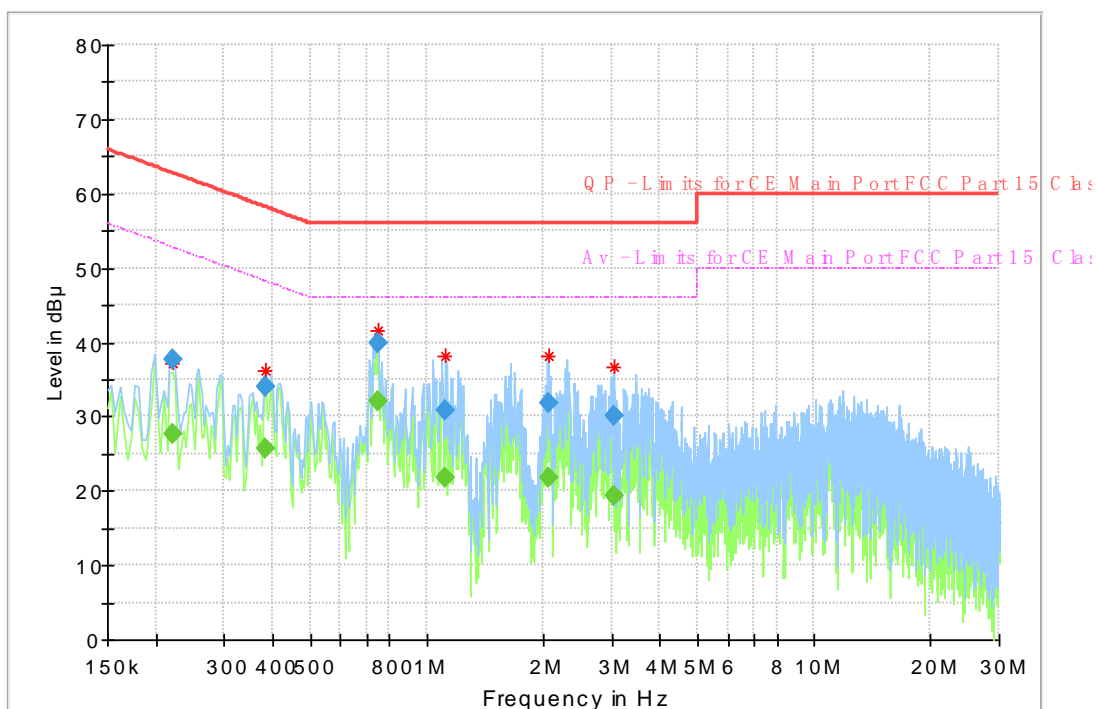

Frequency (MHz)	QuasiPeak (dBµ V)	Average (dBµ V)	Limit (dBµ V)	Margin (dB)	Meas. Time	Bandwidth (kHz)	Line	Filter	Corr. (dB)
0.220894	37.67	---	62.79	25.11	1000.0	9.000	N	ON	9.7
0.220894	---	27.71	52.79	25.08	1000.0	9.000	N	ON	9.7
0.385069	33.88	---	58.17	24.28	1000.0	9.000	L1	ON	9.7
0.385069	---	25.61	48.17	22.56	1000.0	9.000	L1	ON	9.7
0.747000	---	32.02	46.00	13.98	1000.0	9.000	N	ON	9.7
0.747000	39.90	---	56.00	16.10	1000.0	9.000	N	ON	9.7
1.120125	---	21.76	46.00	24.24	1000.0	9.000	N	ON	9.7
1.120125	30.88	---	56.00	25.12	1000.0	9.000	N	ON	9.7
2.056669	31.84	---	56.00	24.16	1000.0	9.000	L1	ON	9.7
2.056669	---	21.78	46.00	24.22	1000.0	9.000	L1	ON	9.7
3.030525	30.07	---	56.00	25.93	1000.0	9.000	L1	ON	9.7
3.030525	---	19.33	46.00	26.67	1000.0	9.000	L1	ON	9.7

Note:

1. Emission level(quasi-peak or Average peak)=Raw value by receiver + Corr(Insertion loss+ cable loss)
2. The raw value is used to calculate by software which is not shown in the sheet.
3. Margin=limit value – emission level.
4. L1 and N line is all have been tested, the result of them is synthesized in the above data diagram.

\*\*\*\*\*END OF REPORT\*\*\*\*\*