



TEST REPORT

No. I18D00191-EMC01

For

Client : Shanghai Sunmi Technology Co.,Ltd.

Production: POS System

Model Name : L1320/L1322

Brand Name: SUNMI

FCC ID: 2AH25T2MINI

Hardware Version: V1.03

Software Version: MST2MINI_EQ000_2EE0.123BBE2.953076

2_180824_100_V01_T15

Issued date: 2018-12-19

Note:

The test results in this test report relate only to the devices specified in this report. This report shall not be reproduced except in full without the written approval of ECIT Shanghai.

Test Laboratory:

ECIT Shanghai, East China Institute of Telecommunications

Add: 7F, G Area, No.668, Beijing East Road, Huangpu District, Shanghai, P. R. China

Tel: (+86)-021-63843300, E-Mail: welcome@ecit.org.cn

Revision Version

Report Number	Revision	Date	Memo
I18D00191-EMC01	00	2018-12-19	Initial creation of test report

CONTENTS

1. TEST LABORATORY	5
1.1. TESTING LOCATION	5
1.2. TESTING ENVIRONMENT	5
1.3. PROJECT DATA.....	5
1.4. SIGNATURE.....	5
2. CLIENT INFORMATION	6
2.1. APPLICANT INFORMATION.....	6
2.2. MANUFACTURER INFORMATION.....	6
3. EQUIPMENT UNDER TEST (EUT) AND ANCILLARY EQUIPMENT (AE)	7
3.1. ABOUT EUT.....	7
3.2. INTERNAL IDENTIFICATION OF EUT USED DURING THE TEST	7
3.3. INTERNAL IDENTIFICATION OF AE USED DURING THE TEST	7
4. REFERENCE DOCUMENTS.....	8
4.1. REFERENCE DOCUMENTS FOR TESTING	8
5. TEST RESULTS.....	9
5.1. SUMMARY OF TEST RESULTS.....	9
5.2. STATEMENTS.....	9
6. TEST EQUIPMENTS UTILIZED.....	10
6.1 RADIATED EMISSION EQUIPMENTS LIST.....	10
6.2 AC CONDUCTED EMISSION EQUIPMENTS LIST	10
7. SYSTEM CONFIGURATION DURING TEST.....	11
7.1 TEST MODE.....	11
7.2 CONNECTION DIAGRAM OF TEST SYSTEM.....	12
8. MEASUREMENT RESULTS.....	13
8.1 RADIATED EMISSION 30MHZ-18GHZ.....	13

8.2 AC CONDUCTED EMISSION..... 20

1. Test Laboratory

1.1. Testing Location

Company Name: ECIT Shanghai, East China Institute of Telecommunications
Address: 7F, G Area, No. 668, Beijing East Road, Huangpu District, Shanghai,
P. R. China
Postal Code: 200001
Telephone: 86-21-63843300
Fax: 86-21-63843301
FCC registration No: 958356

1.2. Testing Environment

Normal Temperature: 15-35°C
Relative Humidity: 30-60%RH

1.3. Project data

Project Leader: Zhou Yan
Testing Start Date: 2018-10-12
Testing End Date: 2018-12-10

1.4. Signature



Qin Yabin

(Prepared this test report)



You Jinjun

(Reviewed this test report)

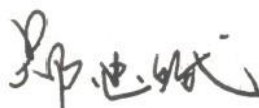

Zheng Zhongbin

(Approved this test report)

2. Client Information

2.1. Applicant Information

Company Name: Shanghai Sunmi Technology Co.,Ltd.
Address : Room 505, KIC Plaza, No.388 Song Hu Road, Yang Pu District,
Shanghai, China
Telephone: 8618721763396
Postcode: 200433

2.2. Manufacturer Information

Company Name: Shanghai Sunmi Technology Co.,Ltd.
Address : Room 505, KIC Plaza, No.388 Song Hu Road, Yang Pu District,
Shanghai, China
Telephone: 8618721763396
Postcode: 200433

3. Equipment under Test (EUT) and Ancillary Equipment (AE)

3.1. About EUT

ProductName	POS System
Model name	L1320/L1322
GSM Frequency Band	GSM850/GSM1900
UMTS Frequency Band	WCDMA Band II / V
CDMA Frequency Band	BC0
LTE Frequency Band	LTE 38/41
Additional Communication Function	BT4.0, BLE; WIFI 802.11b,g,n;

3.2. Internal Identification of EUT used during the test

EUT ID*	SN or IMEI	HW Version	SW Version	Date of receipt
N02(L1320)	/	V1.03	MST2MINI_EQ000_2EE0.123BB E2.9530762_180824_100_V01_T 15	2018-09-17
N01(L1322)	/	V1.03	MST2MINI_EQ000_2EE0.123BB E2.9530762_180824_100_V01_T 15	2018-09-17

*EUT ID: is used to identify the test sample in the lab internally.

3.3. Internal Identification of AE used during the test

AE ID*	Description	Model	SN
CA04	Adapter	TPA—97050100UU	/
UA01	AC Cable	/	/
EA02	IOIOI Cable	/	/
AE1	USB Cable	/	/
AE2	LAN Cable	/	/
AE3	Cash Box	/	/
AE4	Keyboard	/	/
AE5	Mouse	/	/
AE6	Notebook PC	DELL Latitude E6510	/
AE7	SanDisk Ultra32GB	MicroSDHC UHS-I	/
AE8	U disk	DT101 G2	/
AE9	Earphone	/	/
AE10	USB Cable	/	/

*AE ID: is used to identify the test sample in the lab internally.

4. Reference Documents

4.1. Reference Documents for testing

The following documents listed in this section are referred for testing.

Reference	Title	Version
FCC Part 15, Subpart B	Radio frequency devices	10-1-17 Edition
ANSI C63.4	Method of Measurement of Radio-Noise Emissions from Low-Voltage Electrical and Electronic Equipment in the Range of 9 kHz to 40 GHz	2014

5. Test Results

5.1. Summary of Test Results

Items	Test List	Clause in FCC rules	Verdict
1	Radiated Emission	15.109(a)	Pass
2	AC Conducted Emission	15.107(a)	Pass

5.2. Statements

The L1320/L1322, supporting GSM/WCDMA/CDMA/LTE/BT/WLAN.etc, manufactured by Shanghai Sunmi Technology Co.,Ltd. is a variant product for testing. ECIT only performed test cases which identified with Pass/Fail/Inc result in section 5.1.

ECIT has verified that the compliance of the tested device specified in section 3 of this test report is successfully evaluated according to the procedure and test methods as defined in type certification requirement listed in section 4 of this test report.

Note: This project on the basis of the I18D00189-EMC01 original report. Test content for the original report of the worst mode, embodied in the report data is the worst mode. Other information reference original report.

6. Test Equipments Utilized

6.1 Radiated Emission Equipments list

No.	Name	Type	Series Number	Producer	Cal. Date	Cal. interval
1	Universal Radio Communication	CMU200	123126	R&S	2018-05-11	1 Year
2	Test Receiver	ESU40	100307	R&S	2018-05-11	1 Year
3	Trilog Antenna	VULB9163	VULB9163-515	Schwarzbeck	2017-02-25	3 Year
4	Double Ridged Guide	ETS-3117	00135890	ETS	2017-01-11	3 Year
5	EMI Test Software	EMC32 V9.15	NA	R&S	NA	NA

6.2 AC Conducted Emission Equipments list

No.	Name	Type	Series Number	Producer	Cal. Date	Cal. interval
1	Universal Radio	CMU200	123123	R&S	2018-05-11	1 Year
2	Test Receiver	ESCI	101235	R&S	2018-05-11	1 Year
3	2-Line V-Network	ENV216	101380	R&S	2018-05-11	1 Year
4	EMI Test Software	EMC32 V10.35.02	NA	R&S	NA	NA

7. System Configuration during Test

7.1 Test Mode

N02 Sample (L1320)

Test Item	Function Type
AC Conducted Emission	Mode 2: Data link mode<Figure 2>
Radiated Emission	Mode 1: Working mode _Full system <Figure 1> Mode 2: Data link mode<Figure 2>
Remark: 1. All test modes are performed, only the worst cases test data are recorded in this report. 2. Data Link with PC means data application transferred mode between EUT and PC.	

N01 Sample (L1322)

Test Item	Function Type
AC Conducted Emission	Mode 2: Data link mode<Figure 2>
Radiated Emission	Mode 1: Working mode _Full system <Figure 1> Mode 2: Data link mode<Figure 2>
Remark: 3. All test modes are performed, only the worst cases test data are recorded in this report. 4. Data Link with PC means data application transferred mode between EUT and PC.	

Note: The full system include LAN cable, cash box, keyboard, mouse, earphone, printer, U disk , POS and notebook PC.

7.2 Connection Diagram of Test System

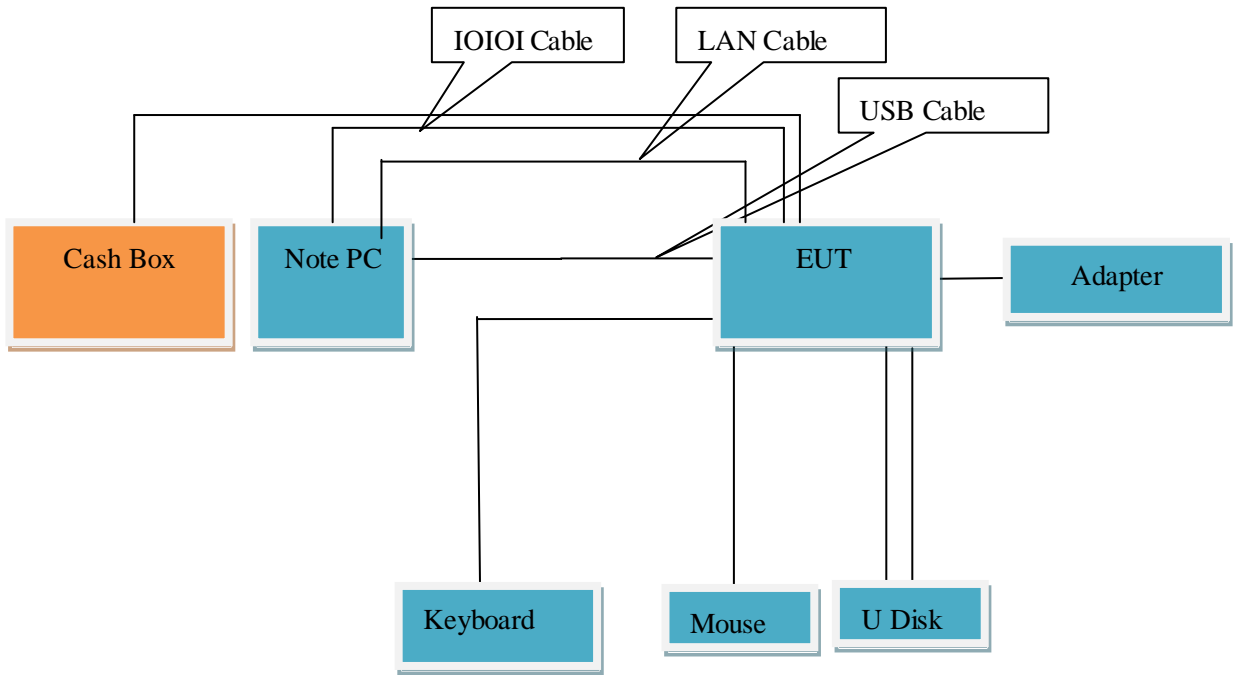

<Figure 1>Mode 1

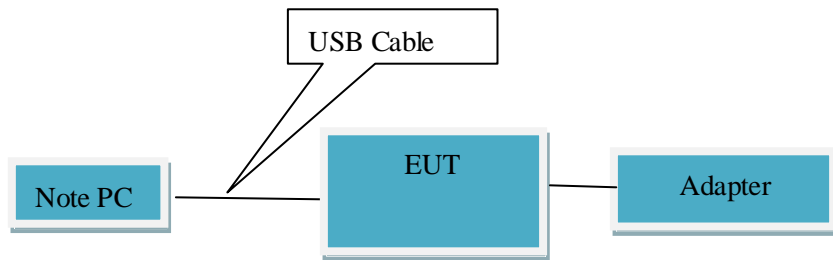

<Figure 2>Mode 2

8. Measurement Results

Only the worst test result was shown in this report.

8.1 Radiated Emission 30MHz-18GHz

Method of Measurement

For 30MHz -1000MHz, the EUT was placed on the top of a rotating 0.8-m table above the ground at a semi-anechoic chamber. The distance between the EUT and the received antenna was 3 meters. The table was rotated 360 degree and the received antenna mounted on a variable-height antenna tower was varied from 1m to 4m to find the maximum value of the field strength. Both horizontal and vertical polarizations of the antenna were set during the measurement. Tested in accordance with the procedures of ANSI C63.4-2014, section 8.3.

For 1000MHz -18000MHz, The maximal emission value was acquired by adjusting the antenna height, The table was rotated 360 degree to determine the maximum value of the field strength. Both horizontal and vertical polarizations of the antenna were set during the measurement.

Limits for Radiated Emission at a measuring distance of 3m

Frequency Range (MHz)	Quasi-Peak (dBuV/m)
30-88	40
88-216	43.5
216-960	46
Above 960	54

Frequency Range (MHz)	Peak (dBuV/m)	Average (dBuV/m)
Above 1000	74	54

Test conditions

Frequency Range (MHz)	RBW/VBW	Sweep Time (s)
30-1000	120kHz/300kHz	Auto
1000-18000	1MHz/3MHz	Auto

Uncertainty Measurement

The measurement uncertainty is 4.98dB (30MHz -1000MHz) and 5.06dB (1GHz -18GHz) (k=2)

Test Results

N02 Sample Mode 2: Data link mode<Figure 2>

Frequency Range: 30MHz – 1GHz

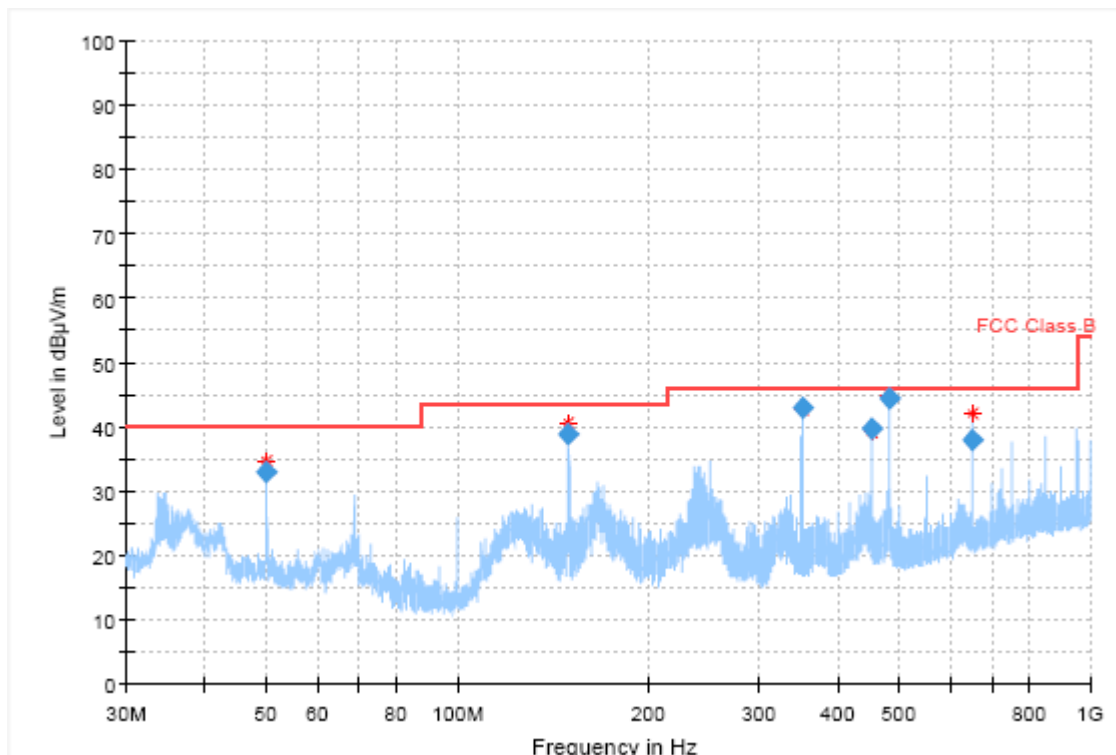

Frequency (MHz)	QuasiPeak (dBµV/m)	Limit (dBµV/m)	Margin (dB)	Meas. Time (ms)	Bandwidth (kHz)	Height (cm)	Pol	Azimuth (deg)	Corr. (dB)
50.010213	32.87	40.00	7.13	1000.0	120.000	100.0	V	-28.0	-20.0
150.029064	38.96	43.50	4.54	1000.0	120.000	225.0	H	12.0	-27.9
349.990240	42.83	46.00	3.17	1000.0	120.000	100.0	H	123.0	-20.9
450.000680	39.83	46.00	6.17	1000.0	120.000	99.0	H	30.0	-18.3
479.993107	44.45	46.00	1.55	1000.0	120.000	100.0	H	-1.0	-17.6
650.001187	37.85	46.00	8.15	1000.0	120.000	124.0	H	254.0	-13.7

Note:

1. Emission level(QP)=Raw value by receiver + Corr(Antenna factor + cable loss - preamplifier gain)
2. The raw value is used to calculate by software which is not shown in the sheet.
3. Margin=limit value – emission level.

N01 Sample Mode 2: Data link mode<Figure 2>

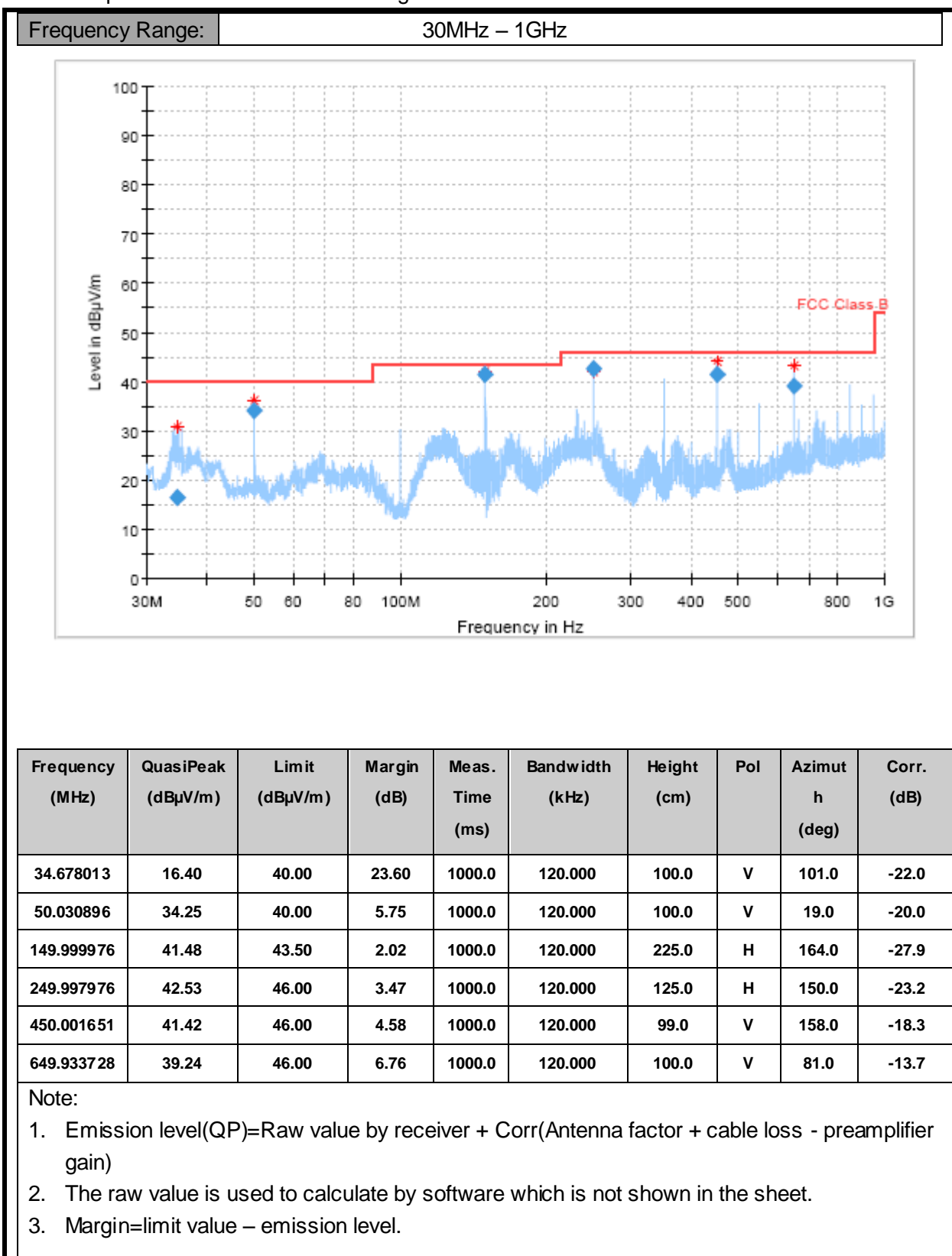

N02 Sample Mode 1: Working mode _Full system <Figure 1>

Frequency Range:	1GHz –18GHz, Horizontal
------------------	-------------------------

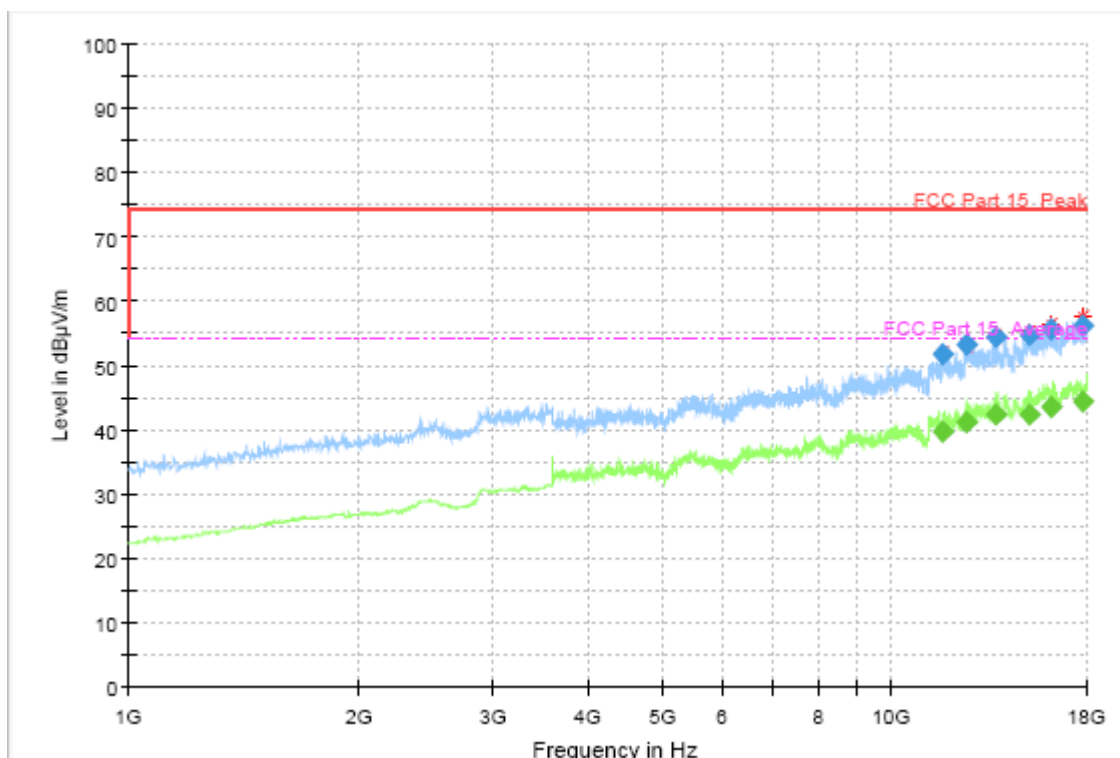

Final Result

Frequency (MHz)	MaxPeak (dBuV/m)	Average (dBuV/m)	Limit (dBuV/m)	Margin	Meas. Time	Bandwidth	Height	Po	Azimuth	Corr. (dB)
11651.600000	51.82	---	74.00	22.18	100.0	1000.000	200.0	H	320.0	15.2
11651.600000	---	39.78	54.00	14.22	100.0	1000.000	200.0	H	320.0	15.2
12515.200000	---	41.04	54.00	12.96	100.0	1000.000	200.0	H	285.0	16.6
12515.200000	53.23	---	74.00	20.77	100.0	1000.000	200.0	H	285.0	16.6
13686.000000	---	42.44	54.00	11.56	100.0	1000.000	200.0	H	180.0	18.8
13686.000000	54.55	---	74.00	19.45	100.0	1000.000	200.0	H	180.0	18.8
15163.400000	54.56	---	74.00	19.44	100.0	1000.000	100.0	H	33.0	20.7
15163.400000	---	42.41	54.00	11.59	100.0	1000.000	100.0	H	33.0	20.7
16204.600000	55.63	---	74.00	18.37	100.0	1000.000	200.0	H	121.0	22.3
16204.600000	---	43.57	54.00	10.43	100.0	1000.000	200.0	H	121.0	22.3
17830.600000	56.11	---	74.00	17.89	100.0	1000.000	200.0	H	0.0	24.3
17830.600000	---	44.41	54.00	9.59	100.0	1000.000	200.0	H	0.0	24.3

Note:

1. Emission level(peak or average)=Raw value by receiver + Corr(Antenna factor+ cable loss - preamplifier gain)
2. The raw value is used to calculate by software which is not shown in the sheet.
3. Margin=limit value – emission level.

Frequency Range:

1GHz –18GHz, Vertical

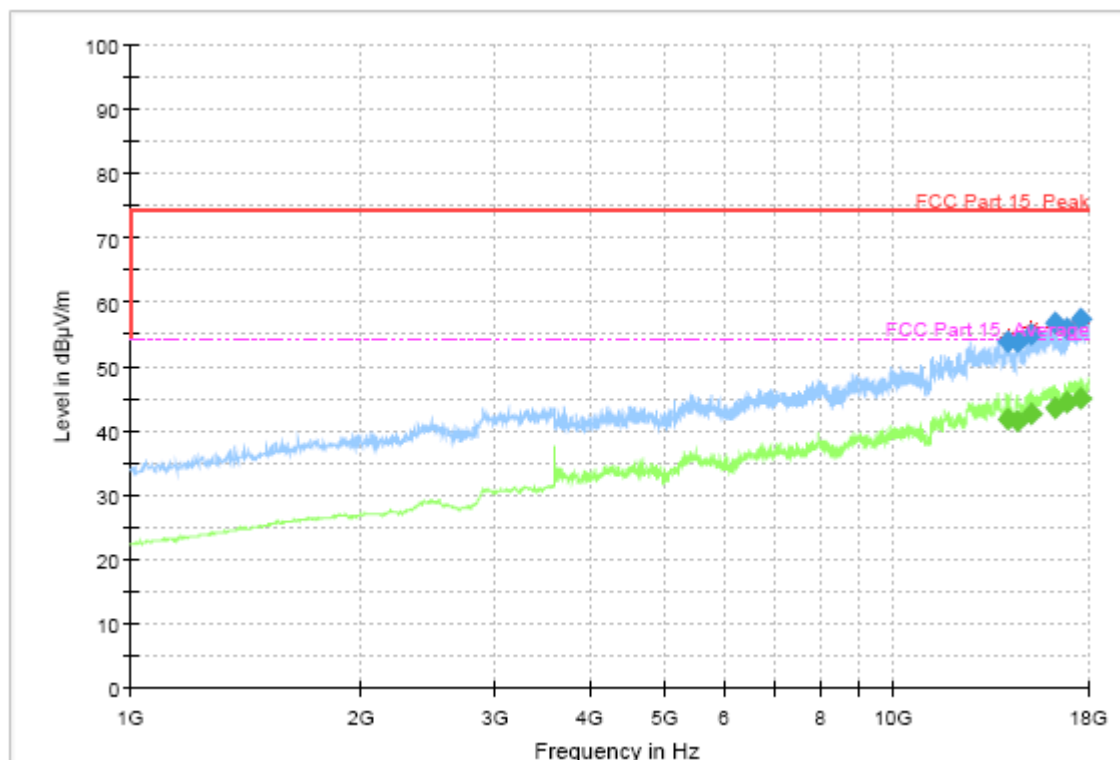

Final Result

Frequency (MHz)	MaxPeak (dBuV/m)	Average (dBuV/m)	Limit (dBuV/m)	Margin (dB)	Meas. Time	Bandwidth (Hz)	Height	Po	Azimuth	Corr. (dB)
14074.000000	53.86	---	74.00	20.14	100.0	1000.000	197.8	V	267.0	19.3
14074.000000	---	41.70	54.00	12.30	100.0	1000.000	197.8	V	267.0	19.3
14552.400000	---	41.35	54.00	12.65	100.0	1000.000	197.8	V	291.0	19.2
14552.400000	53.74	---	74.00	20.26	100.0	1000.000	197.8	V	291.0	19.2
15173.600000	54.87	---	74.00	19.13	100.0	1000.000	197.8	V	24.0	20.7
15173.600000	---	42.56	54.00	11.44	100.0	1000.000	197.8	V	24.0	20.7
16260.200000	56.68	---	74.00	17.32	100.0	1000.000	197.8	V	59.0	22.5
16260.200000	---	43.66	54.00	10.34	100.0	1000.000	197.8	V	59.0	22.5
16858.400000	56.00	---	74.00	18.00	100.0	1000.000	197.8	V	0.0	23.3
16858.400000	---	44.31	54.00	9.69	100.0	1000.000	197.8	V	0.0	23.3
17626.600000	---	44.97	54.00	9.03	100.0	1000.000	99.8	V	325.0	24.5
17626.600000	57.40	---	74.00	16.60	100.0	1000.000	99.8	V	325.0	24.5

Note:

1. Emission level(peak or average)=Raw value by receiver + Corr(Antenna factor+ cable loss - preamplifier gain)
2. The raw value is used to calculate by software which is not shown in the sheet.
3. Margin=limit value – emission level.

N01 Sample Mode 1: Working mode _Full system <Figure 1>

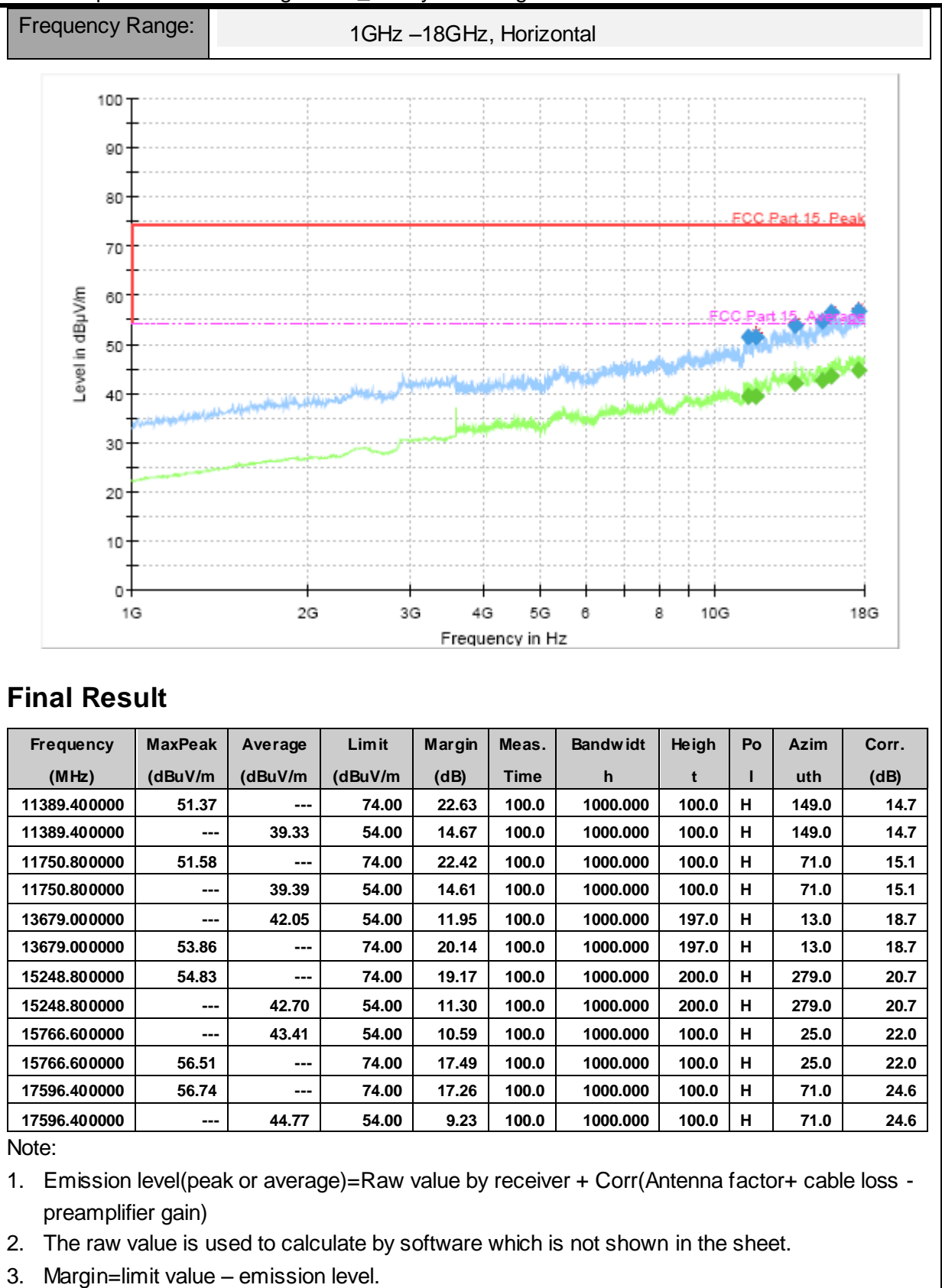

Frequency Range:

1GHz –18GHz, Vertical

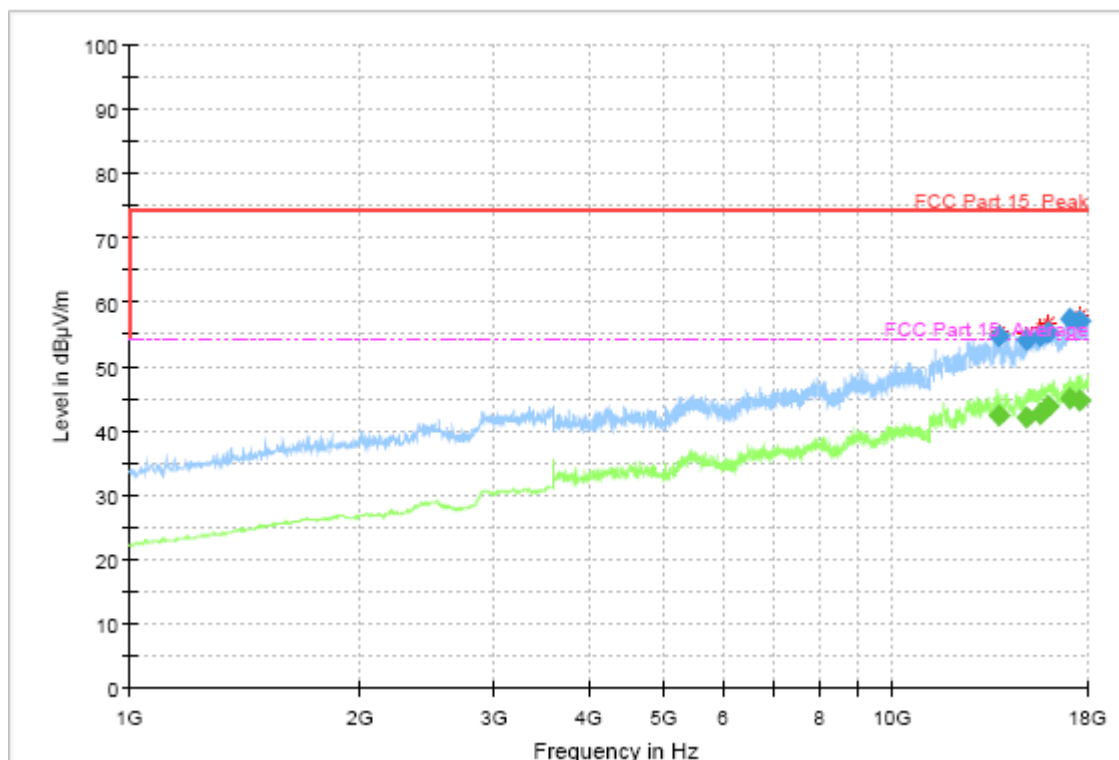

Final Result

Frequency (MHz)	MaxPeak (dBuV/m)	Average (dBuV/m)	Limit (dBuV/m)	Margin (dB)	Meas. Time	Bandwidth (h)	Height (t)	Po (l)	Azimuth	Corr. (dB)
13733.00000	54.64	---	74.00	19.36	100.0	1000.000	198.0	V	100.0	18.8
13733.00000	---	42.29	54.00	11.71	100.0	1000.000	198.0	V	100.0	18.8
14929.60000	---	42.16	54.00	11.84	100.0	1000.000	200.0	V	227.0	20.1
14929.60000	53.99	---	74.00	20.01	100.0	1000.000	200.0	V	227.0	20.1
15585.80000	54.72	---	74.00	19.28	100.0	1000.000	200.0	V	168.0	21.2
15585.80000	---	42.59	54.00	11.41	100.0	1000.000	200.0	V	168.0	21.2
15959.00000	55.44	---	74.00	18.56	100.0	1000.000	100.0	V	168.0	22.2
15959.00000	---	43.69	54.00	10.31	100.0	1000.000	100.0	V	168.0	22.2
17091.60000	57.38	---	74.00	16.62	100.0	1000.000	200.0	V	227.0	24.0
17091.60000	---	44.91	54.00	9.09	100.0	1000.000	200.0	V	227.0	24.0
17609.80000	---	44.77	54.00	9.23	100.0	1000.000	198.0	V	0.0	24.5
17609.80000	57.00	---	74.00	17.00	100.0	1000.000	198.0	V	0.0	24.5

Note:

1. Emission level(peak or average)=Raw value by receiver + Corr(Antenna factor+ cable loss - preamplifier gain)
2. The raw value is used to calculate by software which is not shown in the sheet.
3. Margin=limit value – emission level.

8.2 AC Conducted Emission

Method of Measurement

For equipment that is designed to be connected to the public utility (AC) power line, the radio frequency voltage that is conducted back onto the AC power line on any frequency or frequencies with the band 150 kHz to 30MHz shall not exceed the limits. Both lines of the power mains connected to the EUT were checked for maximum conducted interference. Tested in accordance with the procedures of ANSI C63.4-2014, section 7.3

Limit of AC Conducted Emission

Frequency Range (MHz)	Conducted Limit (dBuV)	
	Quasi-peak	Average
0.15-0.5	66 to 56*	56 to 46*
0.5-5	56	46
5-30	60	50

*Decreases with the logarithm of the frequency

Test Condition in Charging Mode

Voltage (V)	Frequency (Hz)	RBW	Sweep Time (s)
120	60	9 kHz	Auto

Uncertainty Measurement

The measurement uncertainty is 3.66dB (k=2).

Test Results

N02 Sample Mode 2: Data link mode<Figure 2>

Frequency Range: 150kHz – 30MHz

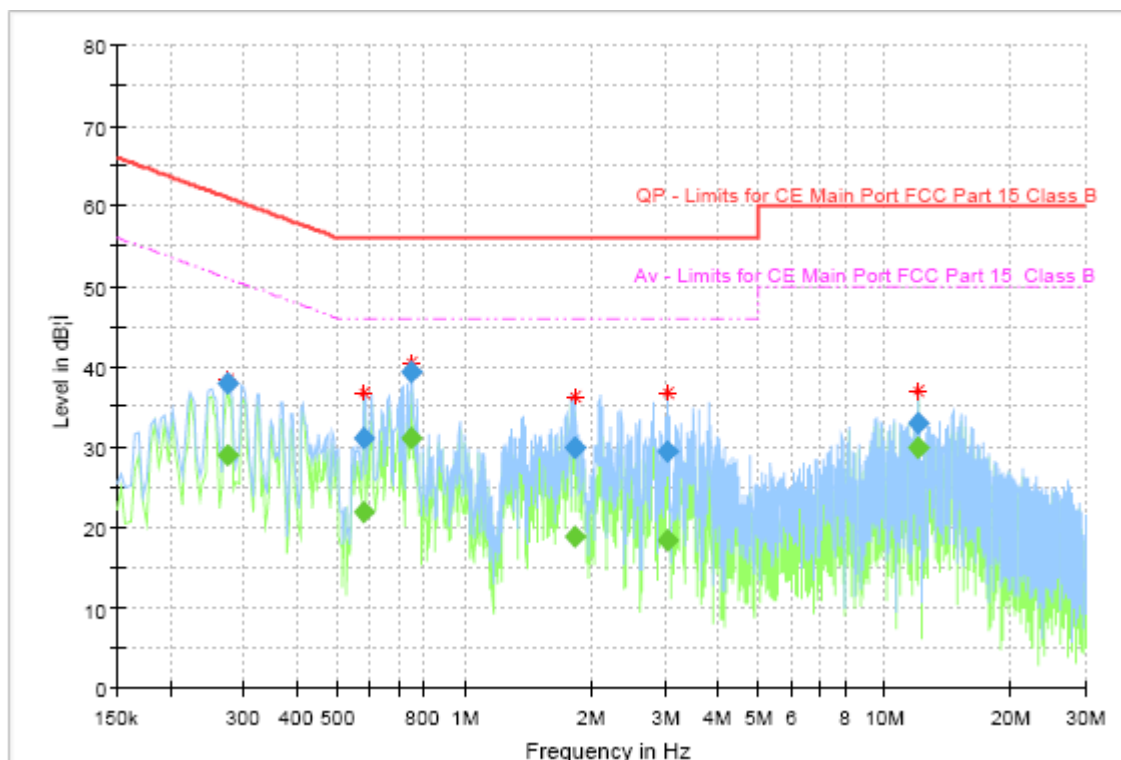

Frequency (MHz)	QuasiPeak (dBµ V)	Average (dBµ V)	Limit (dBµ V)	Margin (dB)	Meas. Time	Bandwidth (kHz)	Line	Filter	Corr. (dB)
0.273131	37.96	---	61.02	23.06	1000.0	9.000	N	ON	9.7
0.273131	---	28.96	51.02	22.06	1000.0	9.000	N	ON	9.7
0.579094	30.96	---	56.00	25.04	1000.0	9.000	N	ON	9.7
0.579094	---	21.93	46.00	24.07	1000.0	9.000	N	ON	9.7
0.750731	---	31.02	46.00	14.98	1000.0	9.000	N	ON	9.7
0.750731	39.37	---	56.00	16.63	1000.0	9.000	N	ON	9.7
1.825331	---	18.93	46.00	27.07	1000.0	9.000	L1	ON	9.7
1.825331	29.88	---	56.00	26.12	1000.0	9.000	L1	ON	9.7
3.052912	---	18.30	46.00	27.70	1000.0	9.000	N	ON	9.7
3.052912	29.30	---	56.00	26.70	1000.0	9.000	N	ON	9.7
12.004181	---	29.85	50.00	20.15	1000.0	9.000	L1	ON	9.9
12.004181	33.04	---	60.00	26.96	1000.0	9.000	L1	ON	9.9

Note:

1. Emission level(quasi-peak or Average peak)=Raw value by receiver + Corr(Insertion loss+ cable loss)
2. The raw value is used to calculate by software which is not shown in the sheet.
3. Margin=limit value – emission level.
4. L1 and N line is all have been tested, the result of them is synthesized in the above data diagram.

N01 Sample Mode 2: Data link mode<Figure 2>

Frequency Range: 150kHz – 30MHz

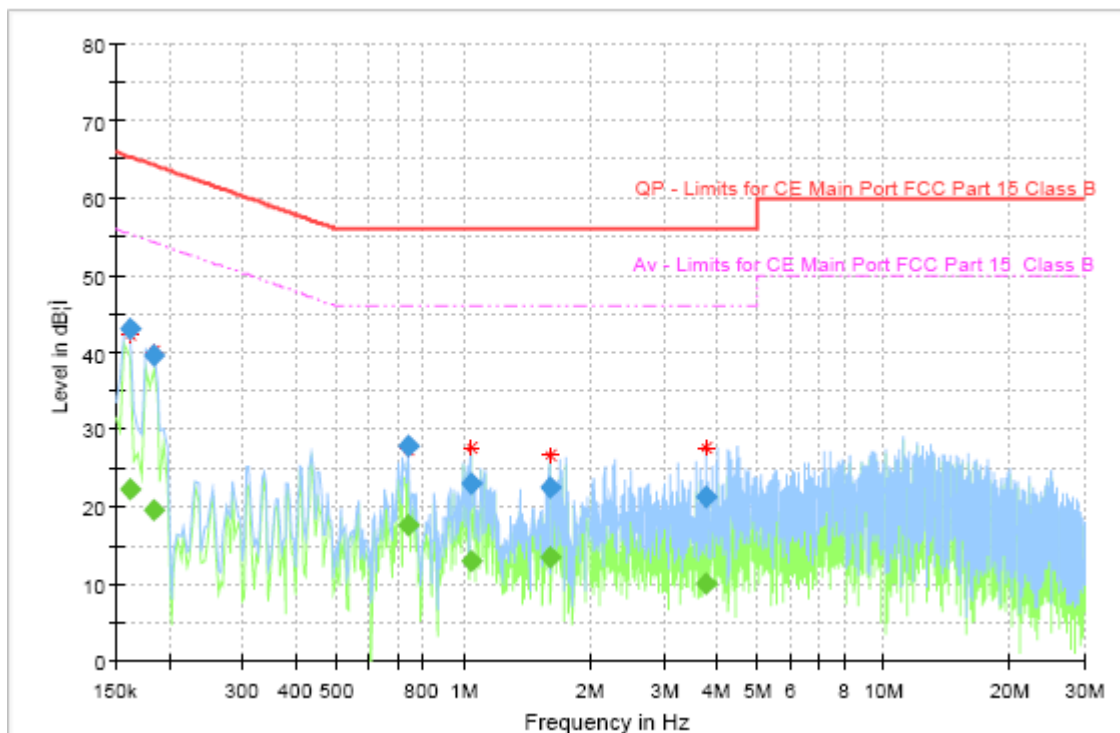

Frequency (MHz)	QuasiPeak (dBμ V)	Average (dBμ V)	Limit (dBμ V)	Margin (dB)	Meas. Time	Bandwidth (kHz)	Line	Filter	Corr. (dB)
0.161194	---	22.18	55.40	33.22	1000.0	9.000	N	ON	9.7
0.161194	42.94	---	65.40	22.47	1000.0	9.000	N	ON	9.7
0.183581	---	19.48	54.32	34.85	1000.0	9.000	N	ON	9.7
0.183581	39.73	---	64.32	24.59	1000.0	9.000	N	ON	9.7
0.739538	---	17.58	46.00	28.42	1000.0	9.000	L1	ON	9.7
0.739538	27.91	---	56.00	28.09	1000.0	9.000	L1	ON	9.7
1.041769	22.89	---	56.00	33.11	1000.0	9.000	L1	ON	9.7
1.041769	---	13.01	46.00	32.99	1000.0	9.000	L1	ON	9.7
1.608919	22.52	---	56.00	33.48	1000.0	9.000	L1	ON	9.7
1.608919	---	13.34	46.00	32.66	1000.0	9.000	L1	ON	9.7
3.780506	---	9.93	46.00	36.07	1000.0	9.000	N	ON	9.8
3.780506	21.36	---	56.00	34.64	1000.0	9.000	N	ON	9.8

Note:

1. Emission level(quasi-peak or Average peak)=Raw value by receiver + Corr(Insertion loss+ cable loss)
2. The raw value is used to calculate by software which is not shown in the sheet.
3. Margin=limit value – emission level.
4. L1 and N line is all have been tested, the result of them is synthesized in the above data diagram.

*****END OF REPORT*****