



TEST REPORT

No. I19D00028-EMC01

For

**Client : Shanghai Sunmi Technology
Co.,Ltd.**

Production: POS Base

Model Name : ND070

Brand Name: SUNMI

FCC ID: 2AH25ND070

Hardware Version: NA

Software Version: NA

Issued date: 2019-03-12

NOTE

1. The test results in this test report relate only to the devices specified in this report.
2. This report shall not be reproduced except in full without the written approval of East China Institute of Telecommunications..
3. The measurement uncertainty is not taken into account when deciding conformity, and the results of measurement (or the average of measurement results) are directly used as the criterion for the stating conformity.

Test Laboratory:

East China Institute of Telecommunications

Add: 7-8F, G Area, No.668, Beijing East Road, Huangpu District, Shanghai, P. R. China

Tel: +862163843300

FAX: +862163843301

E-Mail: welcome@ecit.org.cn

Revision Version

Report Number	Revision	Date	Memo
I19D00028-EMC01	00	2019-03-12	Initial creation of test report

CONTENTS

1. TEST LABORATORY	6
1.1. TESTING LOCATION	6
1.2. TESTING ENVIRONMENT	6
1.3. PROJECT DATA.....	6
1.4. SIGNATURE.....	6
2. CLIENT INFORMATION	7
2.1. APPLICANT INFORMATION.....	7
2.2. MANUFACTURER INFORMATION.....	7
3. EQUIPMENT UNDER TEST (EUT) AND ANCILLARY EQUIPMENT (AE)	8
3.1. ABOUT EUT.....	8
3.2. INTERNAL IDENTIFICATION OF EUT USED DURING THE TEST	8
3.3. INTERNAL IDENTIFICATION OF AE USED DURING THE TEST	8
4. REFERENCE DOCUMENTS.....	9
4.1. REFERENCE DOCUMENTS FOR TESTING	9
5. TEST RESULTS.....	10
5.1. SUMMARY OF TEST RESULTS.....	10
5.2. STATEMENTS.....	10
6. TEST EQUIPMENTS UTILIZED.....	11
6.1 RADIATED EMISSION EQUIPMENTS LIST.....	11
6.2 AC CONDUCTED EMISSION EQUIPMENTS LIST	11
7. SYSTEM CONFIGURATION DURING TEST.....	12
7.1 TEST MODE.....	12
7.2 CONNECTION DIAGRAM OF TEST SYSTEM.....	13
8. MEASUREMENT RESULTS.....	14
8.1 RADIATED EMISSION 30MHZ-18GHZ.....	14

8.2 AC CONDUCTED EMISSION..... 21

1. Test Laboratory

1.1. Testing Location

Company Name: ECIT Shanghai, East China Institute of Telecommunications
Address: 7F, G Area, No. 668, Beijing East Road, Huangpu District, Shanghai,
P. R. China
Postal Code: 200001
Telephone: 86-21-63843300
Fax: 86-21-63843301
FCC registration No: 958356

1.2. Testing Environment

Normal Temperature: 15-35°C
Relative Humidity: 30-60%RH

1.3. Project data

Project Leader: Yu Anlu
Testing Start Date: 2019-03-05
Testing End Date: 2019-03-08

1.4. Signature

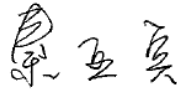

Qin Yabin
(Prepared this test report)



You Jinjun
(Reviewed this test report)

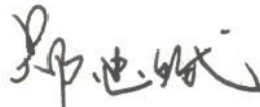

Zheng Zhongbin
(Approved this test report)

2. Client Information

2.1. Applicant Information

Company Name: Shanghai Sunmi Technology Co.,Ltd.
Address : Room 505, KIC Plaza, No.388 Song Hu Road, Yang Pu District,
Shanghai, China
Telephone: 86-18721763396
Postcode: 200433

2.2. Manufacturer Information

Company Name: Shanghai Sunmi Technology Co.,Ltd.
Address : Room 505, KIC Plaza, No.388 Song Hu Road, Yang Pu District,
Shanghai, China
Telephone: 86-18721763396
Postcode: 200433

3. Equipment under Test (EUT) and Ancillary Equipment (AE)

3.1. About EUT

EUT Description	POS Base
Model name	ND070

3.2. Internal Identification of EUT used during the test

EUT ID*	SN or IMEI	HW Version	SW Version	Date of receipt
N01	/	N/A	N/A	2019-03-05
N02	NF01D91A00027	N/A	N/A	2019-03-07

*EUT ID: is used to identify the test sample in the lab internally.

3.3. Internal Identification of AE used during the test

AE ID*	Description	Model	SN
CA01	Adapter	TPA-23A0502000UU01	/
UA01	USB	/	/
AE1	Keyboard	KB212-B	CN-0Y88XT-65890-12I -005Q-A00
AE2	Mouse	MS111-P	CN-011D3V-71581-19 J-1A64
AE3	Wireless data POS System	T5921	/

*AE ID: is used to identify the test sample in the lab internally.

4. Reference Documents

4.1. Reference Documents for testing

The following documents listed in this section are referred for testing.

Reference	Title	Version
FCC Part 15, Subpart B	Radio frequency devices	10-1-17 Edition
ANSI C63.4	Method of Measurement of Radio-Noise Emissions from Low-Voltage Electrical and Electronic Equipment in the Range of 9 kHz to 40 GHz	2014

5. Test Results

5.1. Summary of Test Results

Items	Test List	Clause in FCC rules	Verdict
1	Radiated Emission	15.109(a)	Pass
2	AC Conducted Emission	15.107(a)	Pass

5.2. Statements

The ND070, manufactured by Shanghai Sunmi Technology Co.,Ltd. is a new product for testing. ECIT performed test cases which identified with Pass/Fail/Inc result in section 5.1.

ECIT has verified that the compliance of the tested device specified in section 3 of this test report is successfully evaluated according to the procedure and test methods as defined in type certification requirement listed in section 4 of this test report.

6. Test Equipments Utilized

6.1 Radiated Emission Equipments list

No.	Name	Type	Series Number	Producer	Cal. Date	Cal. interval
1	Universal Radio Communication	CMU200	123126	R&S	2018-05-11	1 Year
2	Test Receiver	ESU40	100307	R&S	2018-05-11	1 Year
3	Trilog Antenna	VULB9163	VULB9163-515	Schwarzbeck	2017-02-25	3 Year
4	Double Ridged Guide	ETS-3117	00135890	ETS	2017-01-11	3 Year
5	EMI Test Software	EMC32 V9.15	NA	R&S	NA	NA

6.2 AC Conducted Emission Equipments list

No.	Name	Type	Series Number	Producer	Cal. Date	Cal. interval
1	Universal Radio	CMU200	123123	R&S	2018-05-11	1 Year
2	Test Receiver	ESCI	101235	R&S	2018-05-11	1 Year
3	2-Line V-Network	ENV216	101380	R&S	2018-05-11	1 Year
4	EMI Test Software	EMC32 V10.35.02	NA	R&S	NA	NA

7. System Configuration during Test

7.1 Test Mode

Test Item	Function Type
AC Conducted Emission	Mode 1: Charging mode+CA01+UA01+AE1+AE2+AE3<Figure 1> Mode 2: Charging mode+CA01+UA01+AE2+AE3<Figure 2>
Radiated Emission	Mode 1: Charging mode+CA01+UA01+AE1+AE2+AE3<Figure 1> Mode 2: Charging mode+CA01+UA01+AE2+AE3<Figure 2>
Remark: 1. All test modes are performed, only the worst cases test data are recorded in this report.	

7.2 Connection Diagram of Test System

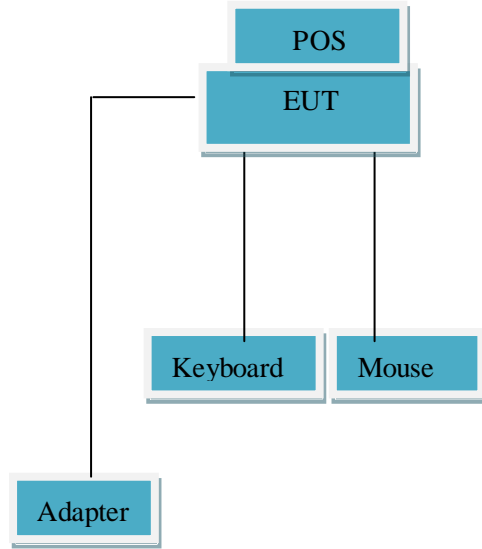

<Figure 1>

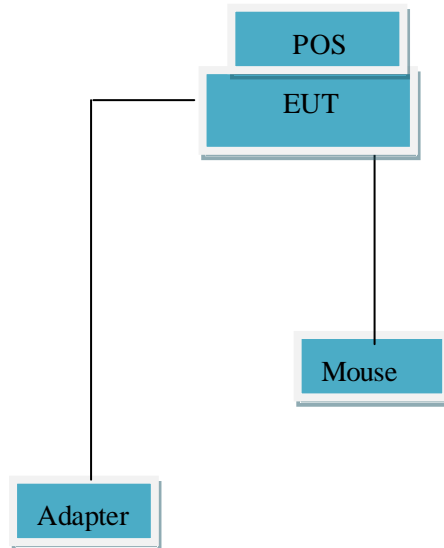

<Figure 2>

8. Measurement Results

Only the worst test result was shown in this report.

8.1 Radiated Emission 30MHz-18GHz

Method of Measurement

For 30MHz -1000MHz, the EUT was placed on the top of a rotating 0.8-m table above the ground at a semi-anechoic chamber. The distance between the EUT and the received antenna was 3 meters. The table was rotated 360 degree and the received antenna mounted on a variable-height antenna tower was varied from 1m to 4m to find the maximum value of the field strength. Both horizontal and vertical polarizations of the antenna were set during the measurement. Tested in accordance with the procedures of ANSI C63.4-2014, section 8.3.

For 1000MHz-18000MHz, The maximal emission value was acquired by adjusting the antenna height, The table was rotated 360 degree to determine the maximum value of the field strength. Both horizontal and vertical polarizations of the antenna were set during the measurement.

Limits for Radiated Emission at a measuring distance of 3m

Frequency Range (MHz)	Quasi-Peak (dBuV/m)
30-88	40
88-216	43.5
216-960	46
Above 960	54

Frequency Range (MHz)	Peak (dBuV/m)	Average (dBuV/m)
Above 1000	74	54

Test conditions

Frequency Range (MHz)	RBW/VBW	Sweep Time (s)
30-1000	120kHz/300kHz	Auto
1000-18000	1MHz/3MHz	Auto

Uncertainty Measurement

The measurement uncertainty is 4.98dB (30MHz -1000MHz) and 5.06dB (1GHz -18GHz) (k=2)

Test Results

Mode 1: Charging mode+CA01+UA01+AE1+AE2+AE3<Figure 1>

Frequency Range: 30MHz – 1GHz

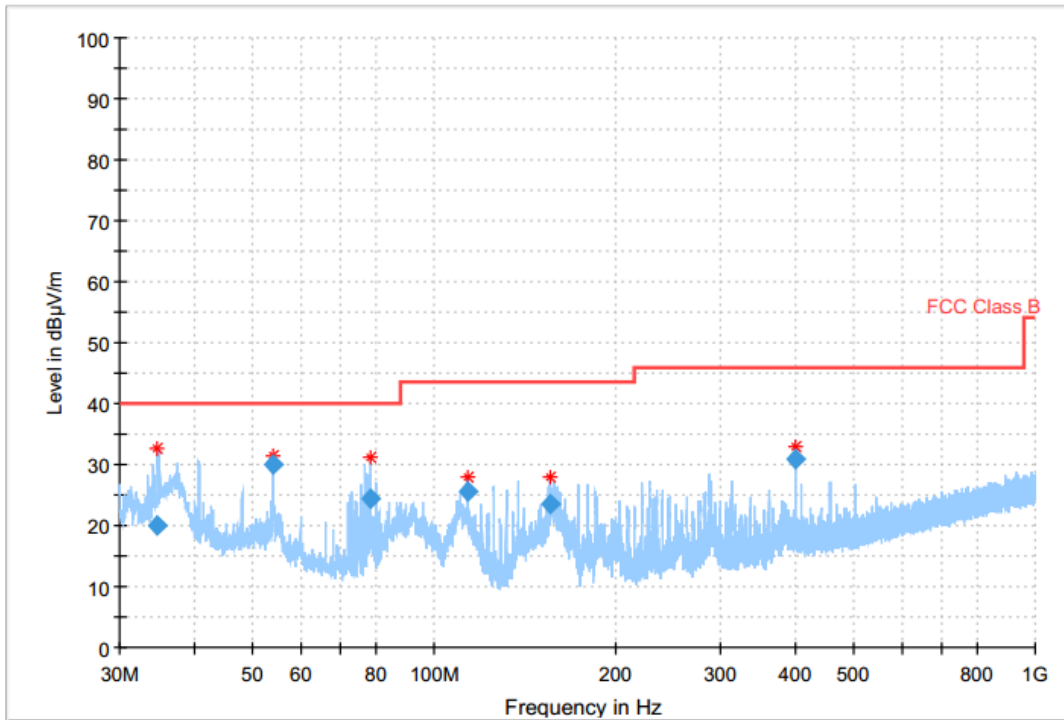

Final_Result

Frequency (MHz)	QuasiPeak (dBµV/m)	Limit (dBµV/m)	Margin (dB)	Meas. Time (s)	Bandwidth (kHz)	Height (cm)	Pol	Azimuth (deg)	Corr. (dB)
34.693277	19.98	40.00	20.02	1000.0	120.000	100.0	V	154.0	-27.7
53.997832	30.14	40.00	9.86	1000.0	120.000	100.0	V	86.0	-26.2
78.588512	24.28	40.00	15.72	1000.0	120.000	175.0	V	134.0	-31.8
114.042512	25.56	43.50	17.94	1000.0	120.000	174.0	H	188.0	-28.3
156.031771	23.59	43.50	19.91	1000.0	120.000	223.0	H	92.0	-30.7
400.037539	30.76	46.00	15.24	1000.0	120.000	100.0	H	252.0	-24.0

Note:

1. Emission level(QP)=Raw value by receiver + Corr(Antenna factor + cable loss - preamplifier gain)
2. The raw value is used to calculate by software which is not shown in the sheet.
3. Margin=limit value – emission level.

Mode 1: Charging mode+CA01+UA01+AE1+AE2+AE3<Figure 1>

Frequency Range:

1GHz –18GHz, Horizontal

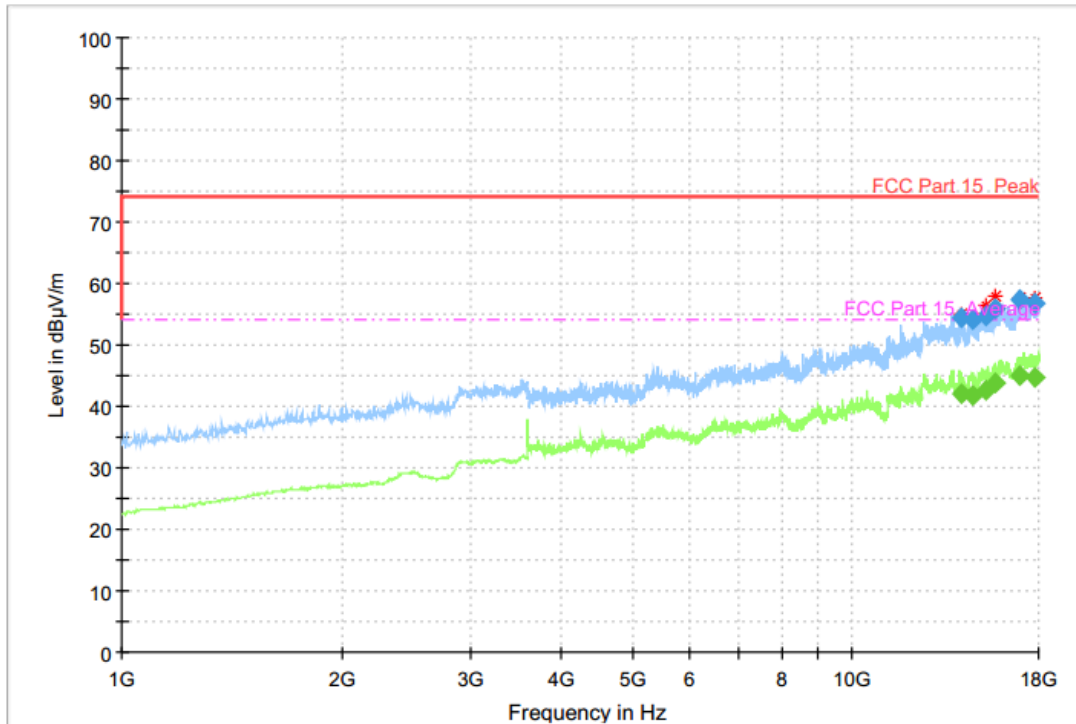

Final Result

Frequency (MHz)	MaxPeak (dBuV/m)	Average (dBuV/m)	Limit (dBuV/m)	Margin	Meas. Time	Bandwidth	Height	Polarization	Azimuth	Corr. (dB)
14063.800000	---	42.03	54.00	11.97	100.0	1000.000	100.0	H	194.0	19.2
14063.800000	54.43	---	74.00	19.57	100.0	1000.000	100.0	H	194.0	19.2
14651.800000	54.07	---	74.00	19.93	100.0	1000.000	100.0	H	0.0	19.7
14651.800000	---	41.91	54.00	12.09	100.0	1000.000	100.0	H	0.0	19.7
15212.400000	54.64	---	74.00	19.36	100.0	1000.000	100.0	H	264.0	20.7
15212.400000	---	42.69	54.00	11.31	100.0	1000.000	100.0	H	264.0	20.7
15704.800000	55.94	---	74.00	18.06	100.0	1000.000	200.0	H	201.0	21.8
15704.800000	---	43.77	54.00	10.23	100.0	1000.000	200.0	H	201.0	21.8
17004.200000	---	45.01	54.00	8.99	100.0	1000.000	100.0	H	155.0	23.7
17004.200000	57.38	---	74.00	16.62	100.0	1000.000	100.0	H	155.0	23.7
17788.200000	56.74	---	74.00	17.26	100.0	1000.000	100.0	H	155.0	24.3
17788.200000	---	44.66	54.00	9.34	100.0	1000.000	100.0	H	155.0	24.3

Note:

1. Emission level(peak or average)=Raw value by receiver + Corr (Antenna factor+ cable loss - preamplifier gain)
2. The raw value is used to calculate by software which is not shown in the sheet.
3. Margin=limit value – emission level.

Frequency Range:

1GHz –18GHz, Vertical

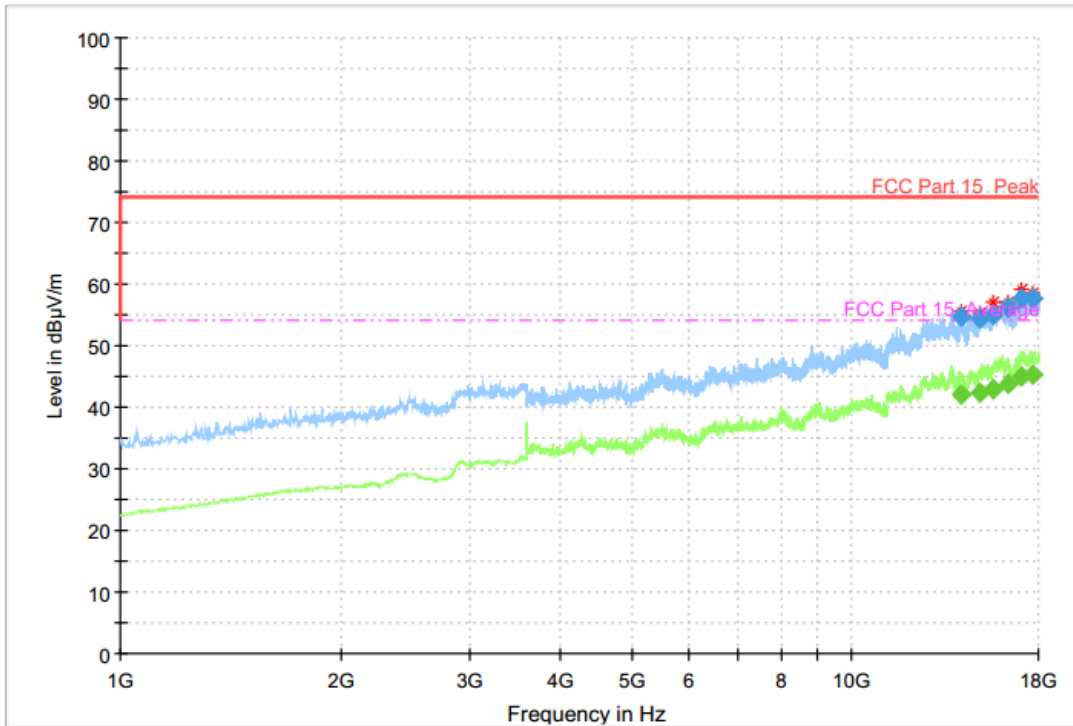

Final Result

Frequency (MHz)	MaxPeak (dBuV/m)	Average (dBuV/m)	Limit (dBuV/m)	Margin (dB)	Meas. Time	Bandwidth (h)	Height (t)	Po (l)	Azimuth	Corr. (dB)
14127.000000	---	42.11	54.00	11.89	100.0	1000.000	200.0	V	270.0	19.3
14127.000000	54.62	---	74.00	19.38	100.0	1000.000	200.0	V	270.0	19.3
14946.000000	54.51	---	74.00	19.49	100.0	1000.000	100.0	V	0.0	20.2
14946.000000	---	42.33	54.00	11.67	100.0	1000.000	100.0	V	0.0	20.2
15583.600000	---	42.81	54.00	11.19	100.0	1000.000	100.0	V	187.0	21.2
15583.600000	54.90	---	74.00	19.10	100.0	1000.000	100.0	V	187.0	21.2
16341.600000	56.05	---	74.00	17.95	100.0	1000.000	200.0	V	342.0	22.8
16341.600000	---	43.74	54.00	10.26	100.0	1000.000	200.0	V	342.0	22.8
17089.600000	---	45.10	54.00	8.90	100.0	1000.000	200.0	V	75.0	24.0
17089.600000	57.70	---	74.00	16.30	100.0	1000.000	200.0	V	75.0	24.0
17653.400000	---	45.33	54.00	8.67	100.0	1000.000	100.0	V	358.0	24.4
17653.400000	57.67	---	74.00	16.33	100.0	1000.000	100.0	V	358.0	24.4

Note:

1. Emission level(peak or average)=Raw value by receiver + Corr(Antenna factor+ cable loss - preamplifier gain)
2. The raw value is used to calculate by software which is not shown in the sheet.
3. Margin=limit value – emission level.

Mode 2: Charging mode+CA01+UA01+AE2+AE3<Figure 2>

Frequency Range:

30MHz – 1GHz

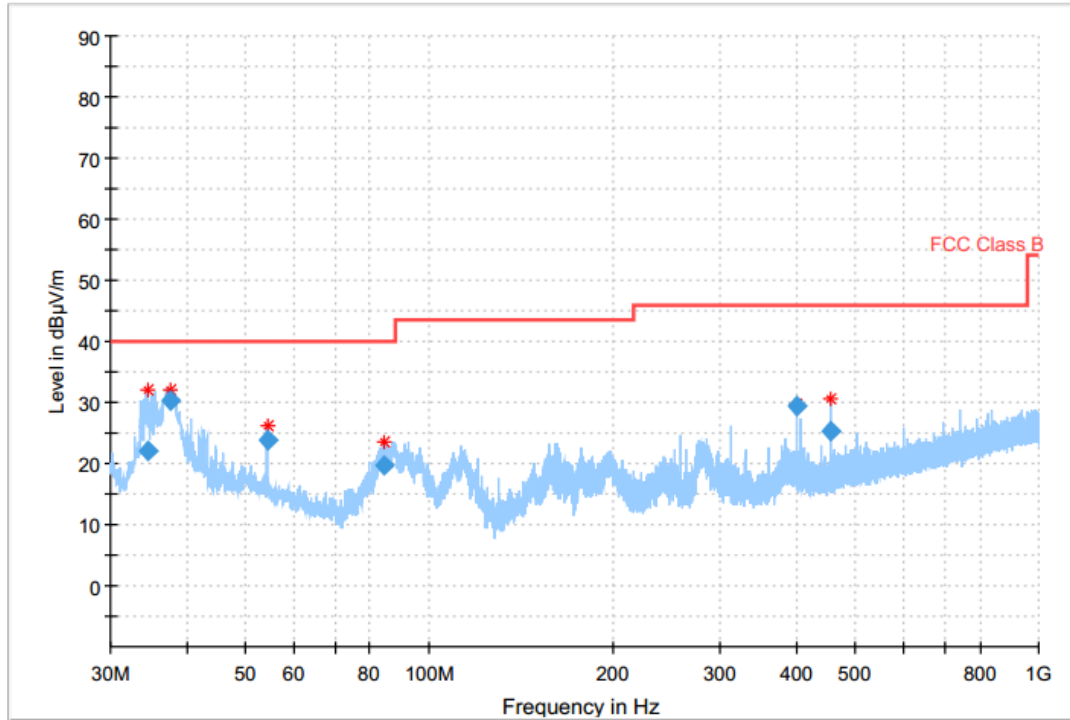

Final_Result

Frequency (MHz)	QuasiPeak (dBµV/m)	Limit (dBµV/m)	Margin (dB)	Meas. Time	Bandwidth (kHz)	Height (cm)	Pol	Azimuth (deg)	Corr. (dB)
34.499056	21.97	40.00	18.03	1000.0	120.000	175.0	V	115.0	-27.7
37.556824	30.24	40.00	9.76	1000.0	120.000	100.0	V	259.0	-27.1
54.279059	23.76	40.00	16.24	1000.0	120.000	197.0	V	71.0	-26.3
84.530421	19.78	40.00	20.22	1000.0	120.000	125.0	V	267.0	-30.9
399.988581	29.41	46.00	16.59	1000.0	120.000	225.0	V	167.0	-24.0
456.010552	25.43	46.00	20.57	1000.0	120.000	100.0	H	266.0	-23.2

Note:

1. Emission level(QP)=Raw value by receiver + Corr(Antenna factor + cable loss - preamplifier gain)
2. The raw value is used to calculate by software which is not shown in the sheet.
3. Margin=limit value – emission level.

Mode 2: Charging mode+CA01+UA01+AE2+AE3<Figure 2>

Frequency Range:

1GHz –18GHz, Horizontal

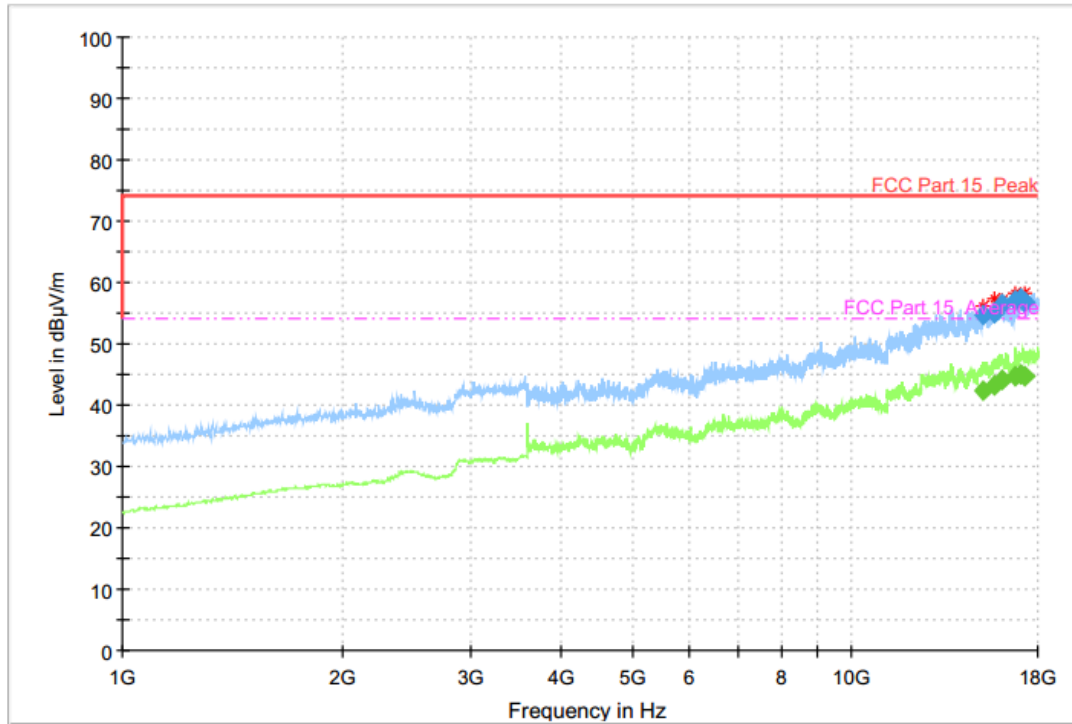

Final Result

Frequency (MHz)	MaxPeak (dBuV/m)	Average (dBuV/m)	Limit (dBuV/m)	Margi n	Meas. Time	Bandwidt h	Heigh t	Po l	Azim uth	Corr. (dB)
15134.200000	54.78	---	74.00	19.22	100.0	1000.000	100.0	H	203.0	20.6
15134.200000	---	42.43	54.00	11.57	100.0	1000.000	100.0	H	203.0	20.6
15657.400000	55.08	---	74.00	18.92	100.0	1000.000	100.0	H	0.0	21.6
15657.400000	---	43.19	54.00	10.81	100.0	1000.000	100.0	H	0.0	21.6
16055.000000	---	44.26	54.00	9.74	100.0	1000.000	100.0	H	24.0	22.5
16055.000000	56.60	---	74.00	17.40	100.0	1000.000	100.0	H	24.0	22.5
16764.800000	---	44.57	54.00	9.43	100.0	1000.000	100.0	H	265.0	23.5
16764.800000	57.15	---	74.00	16.85	100.0	1000.000	100.0	H	265.0	23.5
17077.800000	---	45.03	54.00	8.97	100.0	1000.000	100.0	H	97.0	23.9
17077.800000	57.48	---	74.00	16.52	100.0	1000.000	100.0	H	97.0	23.9
17310.200000	---	44.81	54.00	9.19	100.0	1000.000	100.0	H	119.0	24.1
17310.200000	56.65	---	74.00	17.35	100.0	1000.000	100.0	H	119.0	24.1

Note:

1. Emission level(peak or average)=Raw value by receiver + Corr(Antenna factor+ cable loss - preamplifier gain)
2. The raw value is used to calculate by software which is not shown in the sheet.
3. Margin=limit value – emission level.

Frequency Range:

1GHz –18GHz, Vertical

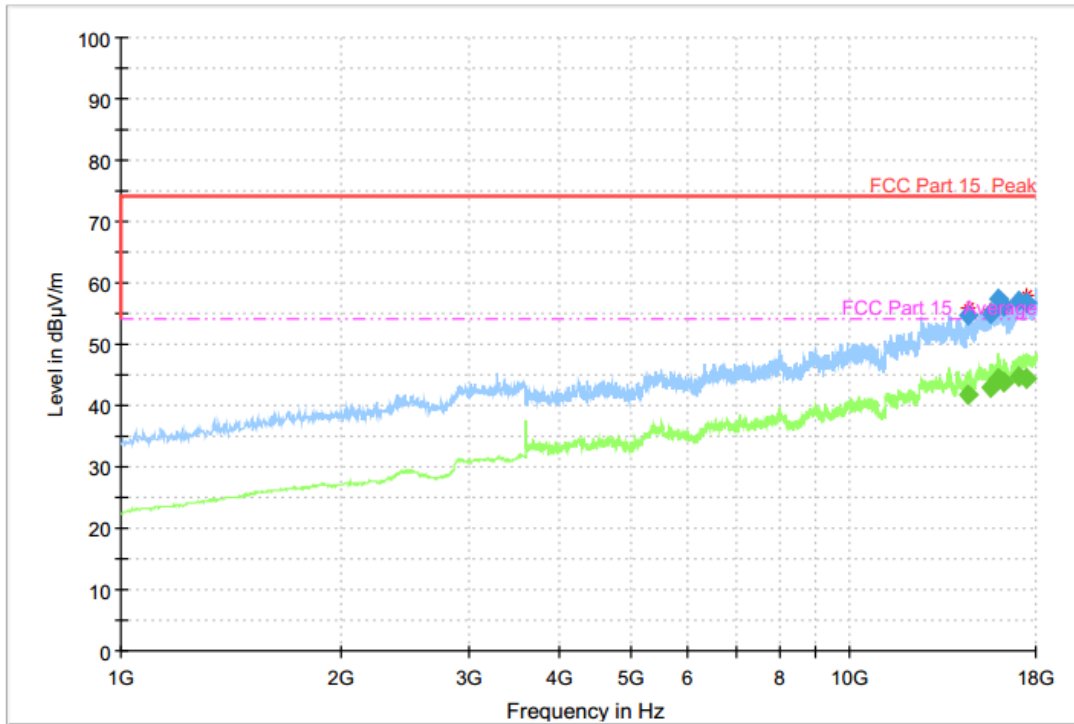

Final Result

Frequency (MHz)	MaxPeak (dBuV/m)	Average (dBuV/m)	Limit (dBuV/m)	Margin (dB)	Meas. Time	Bandwidth (h)	Height (t)	Po (l)	Azimuth	Corr. (dB)
14531.00000	---	41.65	54.00	12.35	100.0	1000.000	100.0	V	178.0	19.2
14531.00000	54.73	---	74.00	19.27	100.0	1000.000	100.0	V	178.0	19.2
15578.20000	---	42.88	54.00	11.12	100.0	1000.000	100.0	V	147.0	21.2
15578.20000	54.96	---	74.00	19.04	100.0	1000.000	100.0	V	147.0	21.2
16005.20000	57.33	---	74.00	16.67	100.0	1000.000	100.0	V	64.0	22.3
16005.20000	---	44.35	54.00	9.65	100.0	1000.000	100.0	V	64.0	22.3
16304.00000	---	43.84	54.00	10.16	100.0	1000.000	100.0	V	95.0	22.7
16304.00000	56.17	---	74.00	17.83	100.0	1000.000	100.0	V	95.0	22.7
17055.20000	---	44.85	54.00	9.15	100.0	1000.000	200.0	V	54.0	23.9
17055.20000	56.93	---	74.00	17.07	100.0	1000.000	200.0	V	54.0	23.9
17459.60000	56.77	---	74.00	17.23	100.0	1000.000	100.0	V	84.0	24.3
17459.60000	---	44.41	54.00	9.59	100.0	1000.000	100.0	V	84.0	24.3

Note:

1. Emission level(peak or average)=Raw value by receiver + Corr(Antenna factor+ cable loss - preamplifier gain)
2. The raw value is used to calculate by software which is not shown in the sheet.
3. Margin=limit value – emission level.

8.2 AC Conducted Emission

Method of Measurement

For equipment that is designed to be connected to the public utility (AC) power line, the radio frequency voltage that is conducted back onto the AC power line on any frequency or frequencies with the band 150 kHz to 30MHz shall not exceed the limits. Both lines of the power mains connected to the EUT were checked for maximum conducted interference. Tested in accordance with the procedures of ANSI C63.4-2014, section 7.3

Limit of AC Conducted Emission

Frequency Range (MHz)	Conducted Limit (dBuV)	
	Quasi-peak	Average
0.15-0.5	66 to 56*	56 to 46*
0.5-5	56	46
5-30	60	50

*Decreases with the logarithm of the frequency

Test Condition in Charging Mode

Voltage (V)	Frequency (Hz)	RBW	Sweep Time (s)
120	60	9 kHz	Auto

Uncertainty Measurement

The measurement uncertainty is 3.66dB (k=2).

Test Results

Mode 1: Charging mode+CA01+UA01+AE1+AE2+AE3<Figure 1>

Frequency Range:

150kHz – 30MHz

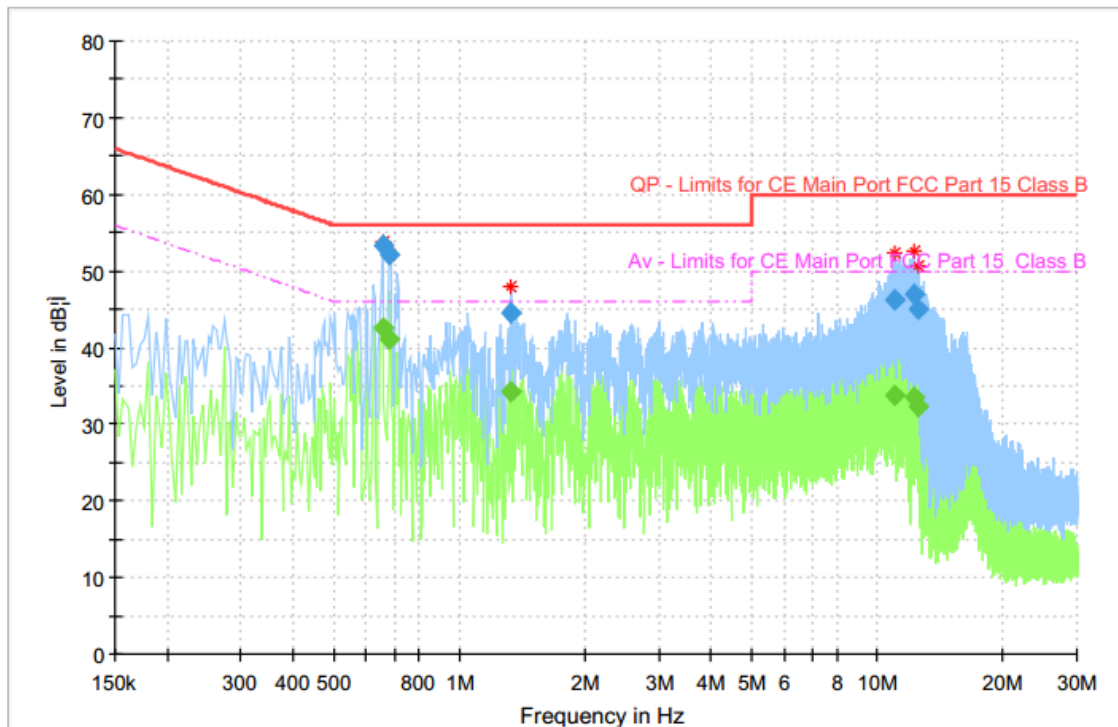

Frequency (MHz)	QuasiPeak (dBµ V)	Average (dBµ V)	Limit (dBµ V)	Margin (dB)	Meas. Time	Bandwidth (kHz)	Line	Filter	Corr. (dB)
0.657450	---	42.58	46.00	3.42	15000.	9.000	L1	ON	9.7
0.657450	53.24	---	56.00	2.76	15000.	9.000	L1	ON	9.7
0.676106	---	41.09	46.00	4.91	15000.	9.000	L1	ON	9.7
0.676106	52.00	---	56.00	4.00	15000.	9.000	L1	ON	9.7
1.332806	---	34.19	46.00	11.81	15000.	9.000	L1	ON	9.7
1.332806	44.61	---	56.00	11.39	15000.	9.000	L1	ON	9.7
11.000475	---	33.81	50.00	16.19	15000.	9.000	L1	ON	9.9
11.000475	46.20	---	60.00	13.80	15000.	9.000	L1	ON	9.9
12.261638	---	33.55	50.00	16.45	15000.	9.000	L1	ON	9.9
12.261638	46.86	---	60.00	13.14	15000.	9.000	L1	ON	9.9
12.500438	---	32.26	50.00	17.74	15000.	9.000	L1	ON	9.9
12.500438	45.12	---	60.00	14.88	15000.	9.000	L1	ON	9.9

Note:

1. Emission level(quasi-peak or Average peak)=Raw value by receiver + Corr(Insertion loss+ cable loss)
2. The raw value is used to calculate by software which is not shown in the sheet.
3. Margin=limit value – emission level.
4. L1 and N line is all have been tested, the result of them is synthesized in the above data diagram.

Mode 2: Charging mode+CA01+UA01+AE2+AE3<Figure 2>

Frequency Range:

150kHz – 30MHz

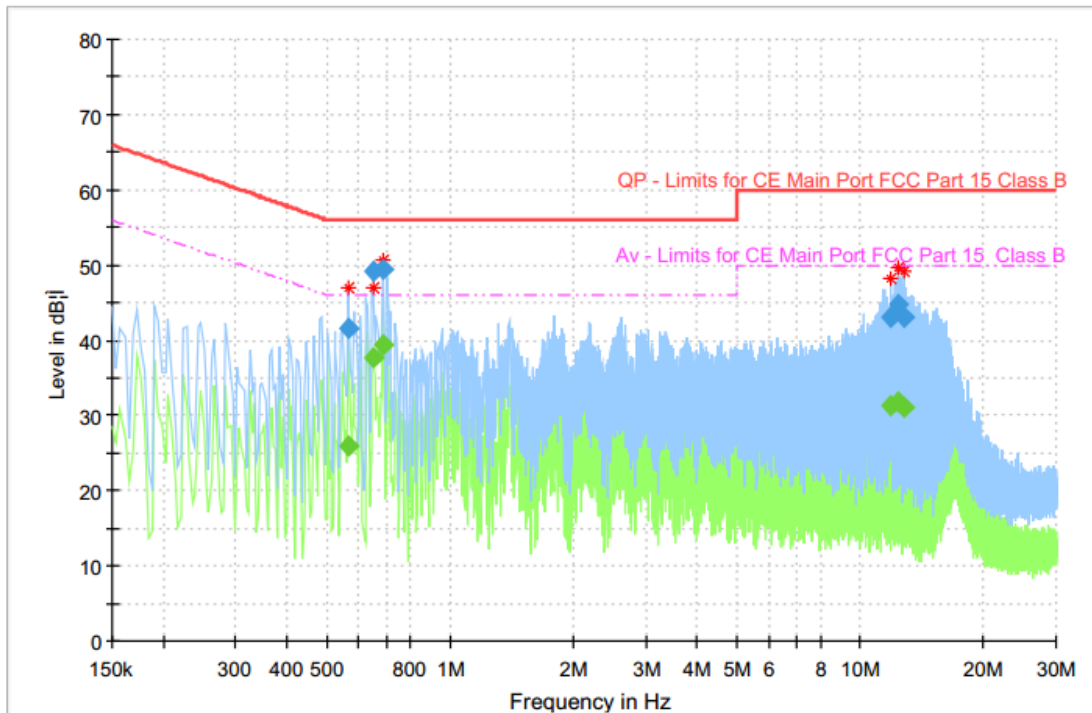

Frequency (MHz)	QuasiPeak (dBµ V)	Average (dBµ V)	Limit (dBµ V)	Margin (dB)	Meas. Time	Bandwidth (kHz)	Line	Filter	Corr. (dB)
0.564169	---	25.81	46.00	20.19	15000.	9.000	L1	ON	9.7
0.564169	41.62	---	56.00	14.38	15000.	9.000	L1	ON	9.7
0.649988	---	37.68	46.00	8.32	15000.	9.000	L1	ON	9.7
0.649988	49.07	---	56.00	6.93	15000.	9.000	L1	ON	9.7
0.683569	---	39.51	46.00	6.49	15000.	9.000	L1	ON	9.7
0.683569	49.47	---	56.00	6.53	15000.	9.000	L1	ON	9.7
11.884781	---	31.21	50.00	18.79	15000.	9.000	L1	ON	9.9
11.884781	43.02	---	60.00	16.98	15000.	9.000	L1	ON	9.9
12.366113	---	31.84	50.00	18.16	15000.	9.000	L1	ON	9.9
12.366113	44.84	---	60.00	15.16	15000.	9.000	L1	ON	9.9
12.757894	---	31.14	50.00	18.86	15000.	9.000	L1	ON	9.9
12.757894	43.11	---	60.00	16.89	15000.	9.000	L1	ON	9.9

Note:

1. Emission level(quasi-peak or Average peak)=Raw value by receiver + Corr(Insertion loss+ cable loss)
2. The raw value is used to calculate by software which is not shown in the sheet.
3. Margin=limit value – emission level.
4. L1 and N line is all have been tested, the result of them is synthesized in the above data diagram.

*****END OF REPORT*****