



FCC RF Test Report

APPLICANT : Shanghai Sunmi Science and Technology Co., Ltd.
EQUIPMENT : Wireless data ordering system
BRAND NAME : SUNMI
MODEL NAME : W5910
FCC ID : 2AH25M1
STANDARD : FCC 47 CFR Part 2, 22(H), 24(E)
CLASSIFICATION : PCS Licensed Transmitter (PCB)

The product was received on Jul. 27, 2016 and testing was completed on Sep. 12, 2016. We, SPORTON INTERNATIONAL (KUNSHAN) INC., would like to declare that the tested sample has been evaluated in accordance with the test procedures given in ANSI / TIA / EIA-603-D-2010 and has been in compliance with the applicable technical standards.

The test results in this report apply exclusively to the tested model / sample. Without written approval of SPORTON INTERNATIONAL (KUNSHAN) INC., the test report shall not be reproduced except in full.

Prepared by: James Huang / Manager

Approved by: Jones Tsai / Manager



SPORTON INTERNATIONAL (KUNSHAN) INC.
No. 3-2, PingXiang Road, Kunshan, Jiangsu Province, P. R. China



TABLE OF CONTENTS

REVISION HISTORY.....3

SUMMARY OF TEST RESULT4

1 GENERAL DESCRIPTION5

 1.1 Applicant.....5

 1.2 Manufacturer5

 1.3 Product Feature of Equipment Under Test5

 1.4 Product Specification of Equipment Under Test6

 1.5 Modification of EUT.....6

 1.6 Maximum ERP/EIRP Power, Frequency Tolerance, and Emission Designator7

 1.7 Testing Location8

 1.8 Applicable Standards8

2 TEST CONFIGURATION OF EQUIPMENT UNDER TEST.....9

 2.1 Test Mode.....9

 2.2 Connection Diagram of Test System10

 2.3 Support Unit used in test configuration10

 2.4 Measurement Results Explanation Example11

3 CONDUCTED TEST RESULT.....12

 3.1 Measuring Instruments.....12

 3.2 Test Setup12

 3.3 Test Result of Conducted Test.....12

 3.4 Conducted Output Power and ERP/EIRP13

 3.5 Peak-to-Average Ratio13

 3.6 99% Occupied Bandwidth and 26dB Bandwidth Measurement.....14

 3.7 Conducted Band Edge15

 3.8 Conducted Spurious Emission16

 3.9 Frequency Stability.....17

4 RADIATED TEST ITEMS18

 4.1 Measuring Instruments.....18

 4.2 Test Setup18

 4.3 Test Result of Radiated Test.....18

 4.4 Field Strength of Spurious Radiation Measurement19

5 LIST OF MEASURING EQUIPMENT20

6 UNCERTAINTY OF EVALUATION21

APPENDIX A. TEST RESULTS OF CONDUCTED TEST

APPENDIX B. TEST RESULTS OF RADIATED TEST

APPENDIX C. TEST SETUP PHOTOGRAPHS



SUMMARY OF TEST RESULT

Report Section	FCC Rule	Description	Limit	Result	Remark
3.4	§2.1046	Conducted Output Power	Reporting Only	PASS	-
	§22.913(a)(2)	Effective Radiated Power	< 7 Watts	PASS	-
	§24.232(c)	Equivalent Isotropic Radiated Power	< 2 Watts	PASS	-
3.5	§24.232(d)	Peak-to-Average Ratio	< 13 dB	PASS	-
3.6	§2.1049 §22.917(b) §24.238(b)	Occupied Bandwidth	Reporting Only	PASS	-
3.7	§2.1051 §22.917(a) §24.238(a)	Band Edge Measurement	< 43+10log10(P[Watts])	PASS	-
3.8	§2.1051 §22.917(a) §24.238(a)	Conducted Emission	< 43+10log10(P[Watts])	PASS	-
3.9	§2.1055 §22.355	Frequency Stability for Temperature & Voltage	< 2.5 ppm	PASS	-
	§2.1055 §24.235		Within Authorized Band		
4.4	§2.1053 §22.917(a) §24.238(a)	Field Strength of Spurious Radiation	< 43+10log10(P[Watts])	PASS	Under limit 32.52 dB at 1672.000 MHz



1 General Description

1.1 Applicant

Shanghai Sunmi Science and Technology Co., Ltd.

Room 505, KIC Plaza, No.388 Song Hu Road, Yang Pu District, Shanghai, China

1.2 Manufacturer

Shanghai Longcheer Technology Co., Ltd.

Building 1, No.401, Caobao Rd, Xuhui District, Shanghai, P. R. China

1.3 Product Feature of Equipment Under Test

Product Feature	
Equipment	Wireless data ordering system
Brand Name	SUNMI
Model Name	W5910
FCC ID	2AH25M1
EUT supports Radios application	GPRS/EGPRS/WCDMA/HSPA/ HSPA+ (16QAM uplink is not supported)/ WLAN 2.4GHz 802.11b/g/n HT20/HT40 Bluetooth v3.0 + EDR/Bluetooth v4.0 LE
HW Version	LWDM591
SW Version	LWDJ610
IMEI Code	Conducted : 865843024542257 Radiation : 865843024542067 ERP/EIRP: 865843024542513
EUT Stage	Identical Prototype

Remark: The above EUT's information was declared by manufacturer. Please refer to the specifications or user's manual for more detailed description.

1.4 Product Specification of Equipment Under Test

Standards-related Product Specification	
Tx Frequency	GPRS/EDGE: 850: 824.2 MHz ~ 848.8 MHz 1900: 1850.2 MHz ~ 1909.8MHz WCDMA: Band V: 826.4 MHz ~ 846.6 MHz Band II: 1852.4 MHz ~ 1907.6 MHz
Rx Frequency	GPRS/EDGE: 850: 869.2 MHz ~ 893.8 MHz 1900: 1930.2 MHz ~ 1989.8 MHz WCDMA: Band V: 871.4 MHz ~ 891.6 MHz Band II: 1932.4 MHz ~ 1987.6 MHz
Maximum Output Power to Antenna	GPRS/EDGE: 850: 32.31 dBm 1900: 29.76 dBm WCDMA: Band V: 23.46 dBm Band II: 22.28 dBm
Antenna Type	PIFA Antenna
Antenna Gain	Cellular Band: -4.00 dBi PCS Band: -2.00 dBi
Type of Modulation	GPRS: GMSK EDGE: GMSK / 8PSK WCDMA: BPSK (Uplink) HSDPA: QPSK (Uplink) HSUPA: QPSK (Uplink) HSPA+ : 16QAM (16QAM uplink is not supported)

1.5 Modification of EUT

No modifications are made to the EUT during all test items.



1.6 Maximum ERP/EIRP Power, Frequency Tolerance, and Emission Designator

FCC Rule	System	Type of Modulation	Maximum ERP/EIRP (W)	Frequency Tolerance (ppm)	Emission Designator
Part 22	GSM850 GPRS class 8	GMSK	0.4130	0.0610 ppm	243KGXW
Part 22	GSM850 EDGE class 8	8PSK	0.1002	0.0215 ppm	255KG7W
Part 22	WCDMA Band V RMC 12.2Kbps	BPSK	0.0538	0.0526 ppm	4M16F9W
Part 24	GSM1900 GPRS class 8	GMSK	0.5970	0.0404 ppm	243KGXW
Part 24	GSM1900 EDGE class 8	8PSK	0.2438	0.0223 ppm	252KG7W
Part 24	WCDMA Band II RMC 12.2Kbps	BPSK	0.1067	0.0723 ppm	4M15F9W



1.7 Testing Location

Test Site	SPORTON INTERNATIONAL (KUNSHAN) INC.	
Test Site Location	No. 3-2, PingXiang Road, Kunshan, Jiangsu Province, P. R. China TEL: +86-0512-5790-0158 FAX: +86-0512-5790-0958	
Test Site No.	Sporton Site No.	
	TH01-KS	

Test Site	SPORTON INTERNATIONAL (SHENZHEN) INC.	
Test Site Location	1F & 2F, Building A, Morning Business Center, No. 4003 ShiGu Rd., Xili Town, Nanshan District, Shenzhen, Guangdong, P. R. China TEL: +86-755-8637-9589 FAX: +86-755-8637-9595	
Test Site No.	Sporton Site No.	FCC Registration No.
	03CH02-SZ	566869

Note: The test site complies with ANSI C63.4 2014 requirement.

1.8 Applicable Standards

According to the specifications of the manufacturer, the EUT must comply with the requirements of the following standards:

- 47 CFR Part 2, 22(H), 24(E)
- ANSI / TIA / EIA-603-D-2010
- FCC KDB 971168 D01 Power Meas. License Digital Systems v02r02
- FCC KDB 412172 D01 Determining ERP and EIRP v01r01

Remark:

1. All test items were verified and recorded according to the standards and without any deviation during the test.
2. This EUT has also been tested and complied with the requirements of FCC Part 15, Subpart B, recorded in a separate test report.



2 Test Configuration of Equipment Under Test

2.1 Test Mode

Antenna port conducted and radiated test items were performed according to KDB 971168 D01 Power Meas. License Digital Systems v02r02 with maximum output power.

Radiated measurements were performed with rotating EUT in different three orthogonal test planes to find the maximum emission.

Radiated emissions were investigated from 30 MHz to 10th harmonic.

All modes and data rates and positions were investigated.

Test modes are chosen to be reported as the worst case configuration below:

Test Modes		
Band	Radiated TCs	Conducted TCs
GSM 850	<ul style="list-style-type: none">■ GPRS class 8 Link■ EDGE class 8 Link	<ul style="list-style-type: none">■ GPRS class 8 Link■ EDGE class 8 Link
GSM 1900	<ul style="list-style-type: none">■ GPRS class 8 Link■ EDGE class 8 Link	<ul style="list-style-type: none">■ GPRS class 8 Link■ EDGE class 8 Link
WCDMA Band V	<ul style="list-style-type: none">■ RMC 12.2Kbps Link	<ul style="list-style-type: none">■ RMC 12.2Kbps Link
WCDMA Band II	<ul style="list-style-type: none">■ RMC 12.2Kbps Link	<ul style="list-style-type: none">■ RMC 12.2Kbps Link

2.2 Connection Diagram of Test System

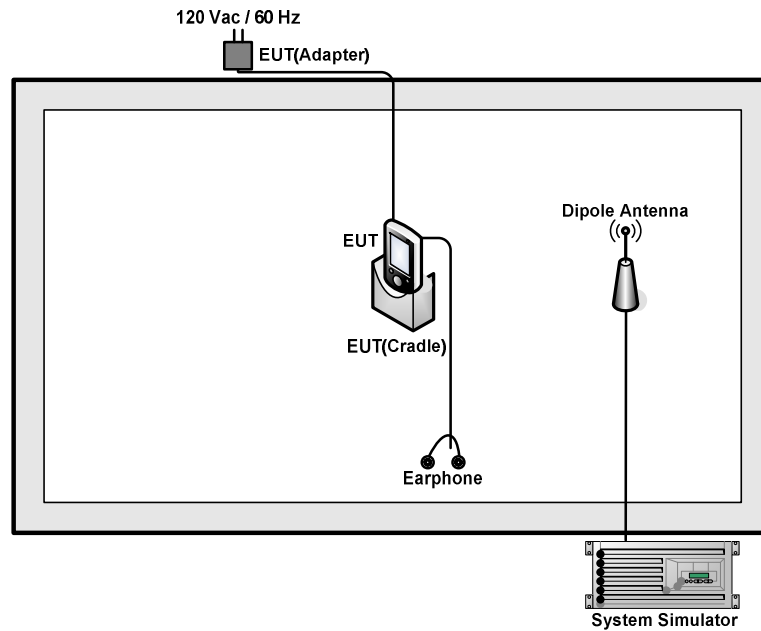

2.3 Support Unit used in test configuration

Item	Equipment	Trade Name	Model No.	FCC ID	Data Cable	Power Cord
1.	System Simulator	R&S	CMU 200	N/A	N/A	Unshielded, 1.8 m
2.	DC Power Supply	GW INSTRON	GPS-3030D	N/A	N/A	Unshielded, 1.8 m
3.	Earphone	Apple	MC690ZP/A	N/A	Shielded, 1.0m	N/A



2.4 Measurement Results Explanation Example

For all conducted test items:

The offset level is set in the spectrum analyzer to compensate the RF cable loss and attenuator factor between RF conducted output port and spectrum analyzer. With the offset compensation, the spectrum analyzer reading level will be exactly the RF output level.

The spectrum analyzer offset is derived from RF cable loss and attenuator factor.

Offset = RF cable loss + attenuator factor.

The following shows an offset computation example with RF cable loss 4.5 dB and a 10dB attenuator.

Example :

$$\begin{aligned} \text{Offset(dB)} &= \text{RF cable loss(dB)} + \text{attenuator factor(dB)}. \\ &= 4.5 + 10 = 14.5 \text{ (dB)} \end{aligned}$$

3 Conducted Test Result

3.1 Measuring Instruments

See list of measuring instruments of this test report.

3.2 Test Setup

3.2.1 Conducted Output Power



3.2.2 Peak-to-Average Ratio, Occupied Bandwidth, Conducted Band-Edge and Conducted Spurious Emission

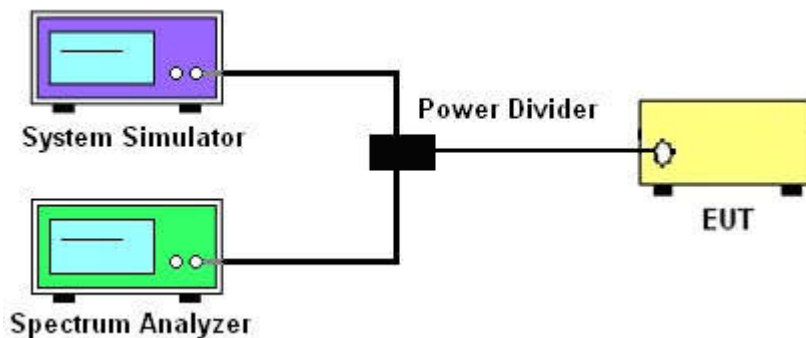

3.2.3 Frequency Stability

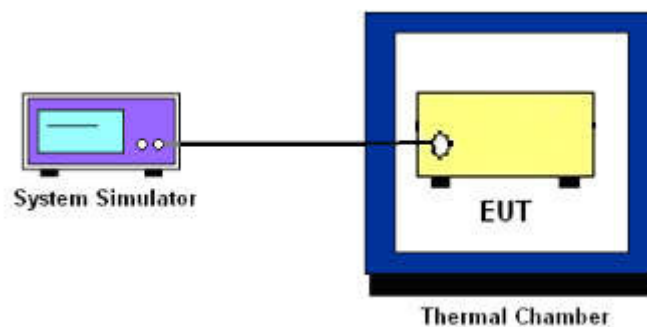

3.3 Test Result of Conducted Test

Please refer to Appendix A.



3.4 Conducted Output Power and ERP/EIRP

3.4.1 Description of the Conducted Output Power and ERP/EIRP

A system simulator was used to establish communication with the EUT. Its parameters were set to enforce EUT transmitting at the maximum power. The measured power in the radio frequency on the transmitter output terminals shall be reported.

The ERP of mobile transmitters must not exceed 7 Watts for GSM850 and WCDMA Band V.

The EIRP of mobile transmitters must not exceed 2 Watts for GSM1900 and WCDMA Band II.

The EIRP of mobile transmitters must not exceed 1 Watts for WCDMA Band IV.

According to KDB 412172 D01 Power Approach,

$EIRP = P_T + G_T - L_C$, $ERP = EIRP - 2.15$, where

P_T = transmitter output power in dBm

G_T = gain of the transmitting antenna in dBi

L_C = signal attenuation in the connecting cable between the transmitter and antenna in dB

3.4.2 Test Procedures

1. The transmitter output port was connected to the system simulator.
2. Set EUT at maximum power through system simulator.
3. Select lowest, middle, and highest channels for each band and different modulation.
4. Measure the maximum burst average power for GSM and maximum average power for other modulation signal.

3.5 Peak-to-Average Ratio

3.5.1 Description of the PAR Measurement

The peak-to-average ratio (PAR) of the transmission may not exceed 13 dB.

3.5.2 Test Procedures

1. The testing follows FCC KDB 971168 D01 v02r02 Section 5.7.1.
2. The EUT was connected to spectrum analyzer and system simulator via a power divider.
3. Set EUT to transmit at maximum output power.
4. When the duty cycle is less than 98%, then signal gating will be implemented on the spectrum analyzer by triggering from the system simulator.
5. Set the CCDF (Complementary Cumulative Distribution Function) option of the spectrum analyzer.

Record the maximum PAPR level associated with a probability of 0.1%.



3.6 99% Occupied Bandwidth and 26dB Bandwidth Measurement

3.6.1 Description of 99% Occupied Bandwidth and 26dB Bandwidth Measurement

The occupied bandwidth is the width of a frequency band such that, below the lower and above the upper frequency limits, the mean powers emitted are each equal to a specified percentage 0.5% of the total mean transmitted power.

The 26 dB emission bandwidth is defined as the frequency range between two points, one above and one below the carrier frequency, at which the spectral density of the emission is attenuated 26 dB below the maximum in-band spectral density of the modulated signal. Spectral density (power per unit bandwidth) is to be measured with a detector of resolution bandwidth equal to approximately 1.0% of the emission bandwidth.

3.6.2 Test Procedures

1. The testing follows FCC KDB 971168 v02r02 Section 4.2.
2. The EUT was connected to spectrum analyzer and system simulator via a power divider.
3. The spectrum analyzer center frequency is set to the nominal EUT channel center frequency. The span range for the spectrum analyzer shall be between two and five times the anticipated OBW.
4. The nominal resolution bandwidth (RBW) shall be in the range of 1 to 5 % of the anticipated OBW, and the VBW shall be at least 3 times the RBW.
5. Set the detection mode to peak, and the trace mode to max hold.
6. Determine the reference value: Set the EUT to transmit a modulated signal. Allow the trace to stabilize. Set the spectrum analyzer marker to the highest level of the displayed trace.
(this is the reference value)
7. Determine the “-26 dB down amplitude” as equal to (Reference Value – X).
8. Place two markers, one at the lowest and the other at the highest frequency of the envelope of the spectral display such that each marker is at or slightly below the “-X dB down amplitude” determined in step 6. If a marker is below this “-X dB down amplitude” value it shall be placed as close as possible to this value. The OBW is the positive frequency difference between the two markers.
9. Use the 99 % power bandwidth function of the spectrum analyzer and report the measured bandwidth.



3.7 Conducted Band Edge

3.7.1 Description of Conducted Band Edge Measurement

The power of any emission outside of the authorized operating frequency ranges must be lower than the transmitter power (P) by a factor of at least $43 + 10 \log (P)$ dB.

3.7.2 Test Procedures

1. The testing follows FCC KDB 971168 D01 v02r02 Section 6.0.
2. The EUT was connected to the spectrum analyzer and system simulator via a power divider.
3. The RF output of EUT was connected to the spectrum analyzer by an RF cable and attenuator. The path loss was compensated to the results for each measurement.
4. The band edges of low and high channels for the highest RF powers were measured.
5. The RF fundamental frequency should be excluded against the limit line in the operating frequency band.
6. The limit line is derived from $43 + 10\log(P)$ dB below the transmitter power P(Watts)
= $P(W) - [43 + 10\log(P)]$ (dB)
= $[30 + 10\log(P)]$ (dBm) - $[43 + 10\log(P)]$ (dB)
= -13dBm.



3.8 Conducted Spurious Emission

3.8.1 Description of Conducted Spurious Emission Measurement

The power of any emission outside of the authorized operating frequency ranges must be lower than the transmitter power (P) by a factor of at least $43 + 10 \log (P)$ dB.

It is measured by means of a calibrated spectrum analyzer and scanned from 30 MHz up to a frequency including its 10th harmonic.

3.8.2 Test Procedures

1. The testing follows FCC KDB 971168 D01 v02r02 Section 6.0.
2. The EUT was connected to the spectrum analyzer and system simulator via a power divider.
3. The RF output of EUT was connected to the spectrum analyzer by an RF cable and attenuator. The path loss was compensated to the results for each measurement.
4. The middle channel for the highest RF power within the transmitting frequency was measured.
5. The conducted spurious emission for the whole frequency range was taken.
6. The RF fundamental frequency should be excluded against the limit line in the operating frequency band.
7. The limit line is derived from $43 + 10\log(P)$ dB below the transmitter power P(Watts)
= $P(W) - [43 + 10\log(P)]$ (dB)
= $[30 + 10\log(P)]$ (dBm) - $[43 + 10\log(P)]$ (dB)
= -13dBm.



3.9 Frequency Stability

3.9.1 Description of Frequency Stability Measurement

The frequency stability shall be measured by variation of ambient temperature and variation of primary supply voltage to ensure that the fundamental emission stays within the authorized frequency block. The frequency stability of the transmitter shall be maintained within $\pm 0.00025\%$ ($\pm 2.5\text{ppm}$) of the center frequency.

3.9.2 Test Procedures for Temperature Variation

1. The testing follows FCC KDB 971168 D01 v02r02 Section 9.0.
2. The EUT was set up in the thermal chamber and connected with the system simulator.
3. With power OFF, the temperature was decreased to -30°C and the EUT was stabilized before testing. Power was applied and the maximum change in frequency was recorded within one minute.
4. With power OFF, the temperature was raised in 10°C steps up to 50°C . The EUT was stabilized at each step for at least half an hour. Power was applied and the maximum frequency change was recorded within one minute.

3.9.3 Test Procedures for Voltage Variation

1. The testing follows FCC KDB 971168 D01 v02r02 Section 9.0.
2. The EUT was placed in a temperature chamber at $20\pm 5^{\circ}\text{C}$ and connected with the system simulator.
3. The power supply voltage to the EUT was varied from 85% to 115% of the nominal value measured at the input to the EUT.
4. The variation in frequency was measured for the worst case.

4 Radiated Test Items

4.1 Measuring Instruments

See list of measuring instruments of this test report.

4.2 Test Setup

4.2.1 For radiated test from 30MHz to 1GHz

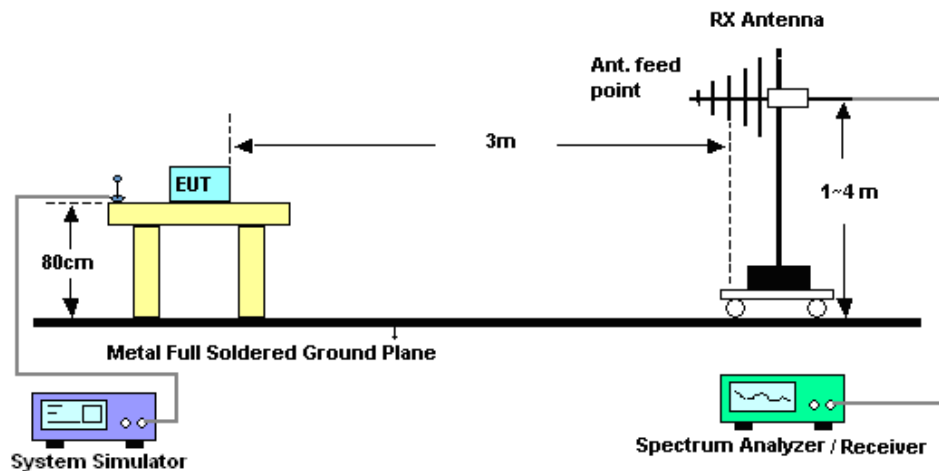

4.2.2 For radiated test above 1GHz

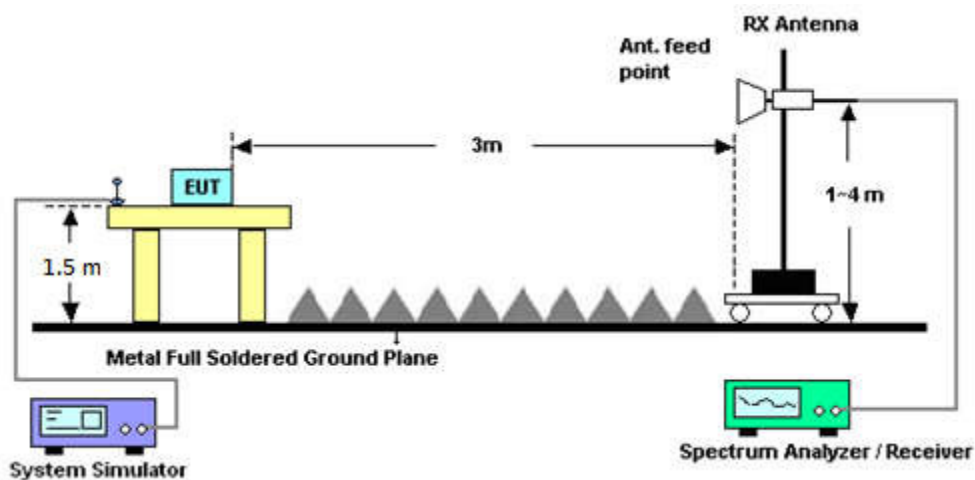

4.3 Test Result of Radiated Test

Please refer to Appendix B.



4.4 Field Strength of Spurious Radiation Measurement

4.4.1 Description of Field Strength of Spurious Radiated Measurement

The power of any emission outside of the authorized operating frequency ranges must be attenuated below the transmitter power (P) by a factor of at least $43 + 10 \log (P)$ dB. The spectrum is scanned from 30 MHz up to a frequency including its 10th harmonic.

4.4.2 Test Procedures

1. The testing follows FCC KDB 971168 D01 v02r02 Section 5.8 and ANSI / TIA-603-D-2010 Section 2.2.12.
2. The EUT was placed on a rotatable wooden table 0.8 meters for frequency below 1GHz and 1.5 meter for frequency above 1GHz above the ground.
3. The EUT was set 3 meters from the receiving antenna, which was mounted on the antenna tower.
4. The table was rotated 360 degrees to determine the position of the highest spurious emission.
5. The height of the receiving antenna is varied between one meter and four meters to search for the maximum spurious emission for both horizontal and vertical polarizations.
6. Make the measurement with the spectrum analyzer's RBW = 1MHz, VBW = 3MHz, taking record of maximum spurious emission.
7. A horn antenna was substituted in place of the EUT and was driven by a signal generator.
8. Tune the output power of signal generator to the same emission level with EUT maximum spurious emission.
9. Taking the record of output power at antenna port.
10. Repeat step 7 to step 8 for another polarization.
11. $EIRP \text{ (dBm)} = S.G. \text{ Power} - Tx \text{ Cable Loss} + Tx \text{ Antenna Gain}$
12. $ERP \text{ (dBm)} = EIRP - 2.15$
13. The RF fundamental frequency should be excluded against the limit line in the operating frequency band.
14. The limit line is derived from $43 + 10\log(P)$ dB below the transmitter power P(Watts)
= $P(W) - [43 + 10\log(P)] \text{ (dB)}$
= $[30 + 10\log(P)] \text{ (dBm)} - [43 + 10\log(P)] \text{ (dB)}$
= -13dBm.



5 List of Measuring Equipment

Instrument	Manufacturer	Model No.	Serial No.	Characteristics	Calibration Date	Test Date	Due Date	Remark
Spectrum Analyzer	R&S	FSV40	101040	10Hz~40GHz	Aug. 09, 2016	Sep. 12, 2016	Aug. 08, 2017	Conducted (TH01-KS)
Thermal Chamber	Ten Billion	TTC-B3S	TBN-960502	-40~+150°C	Oct. 24, 2015	Sep. 12, 2016	Oct. 23, 2016	Conducted (TH01-KS)
Spectrum Analyzer	R&S	FSV40	101041	10kHz~40GHz;Max x 30dBm	Oct. 20, 2015	Sep. 08, 2016	Oct. 19, 2016	Radiation (03CH02-SZ)
Bilog Antenna	TeseQ	CBL6112D	35407	30MHz~2GHz	May 21, 2016	Sep. 08, 2016	May 20, 2017	Radiation (03CH02-SZ)
Double Ridge Horn Antenna	SCHWARZBECK	BBHA 9120D	9120D-1285	1GHz~18GHz	Jan. 11, 2016	Sep. 08, 2016	Jan. 10, 2017	Radiation (03CH02-SZ)
SHF-EHF Horn	com-power	AH-840	101071	18GHz~40GHz	Aug. 10, 2016	Sep. 08, 2016	Aug. 09, 2017	Radiation (03CH02-SZ)
Amplifier	HP	8447F	3113A04622	9kHz~1300MHz / 30 dB	Jul. 16, 2016	Sep. 08, 2016	Jul. 15, 2017	Radiation (03CH02-SZ)
Amplifier	Agilent	8449B	3008A01023	1GHz~26.5GHz	Oct. 20, 2015	Sep. 08, 2016	Oct. 19, 2016	Radiation (03CH02-SZ)
AC Power Source	Chroma	61601	616010002470	N/A	NCR	Sep. 08, 2016	NCR	Radiation (03CH02-SZ)
Turn Table	Chaintek	T-200	N/A	0~360 degree	NCR	Sep. 08, 2016	NCR	Radiation (03CH02-SZ)
Antenna Mast	Chaintek	MBS-400	N/A	1 m~4 m	NCR	Sep. 08, 2016	NCR	Radiation (03CH02-SZ)

NCR: No Calibration Required



6 Uncertainty of Evaluation

Uncertainty of Radiated Emission Measurement (30 MHz ~ 1000 MHz)

Measuring Uncertainty for a Level of Confidence of 95% ($U = 2Uc(y)$)	2.5dB
---	-------

Uncertainty of Radiated Emission Measurement (1GHz ~ 18GHz)

Measuring Uncertainty for a Level of Confidence of 95% ($U = 2Uc(y)$)	3.3dB
---	-------

Uncertainty of Radiated Emission Measurement (18GHz ~ 40GHz)

Measuring Uncertainty for a Level of Confidence of 95% ($U = 2Uc(y)$)	3.7dB
---	-------



Appendix A. Test Results of Conducted Test

Conducted Output Power(Average power)

Conducted Power (*Unit: dBm)						
Band	GSM850			GSM1900		
Channel	128	189	251	512	661	810
Frequency	824.2	836.4	848.8	1850.2	1880.0	1909.8
GPRS class 8	32.14	32.31	32.21	29.54	29.62	29.76
GPRS class 10	30.92	31.05	30.86	28.79	28.88	29.02
GPRS class 11	29.07	29.12	28.91	27.09	27.16	27.28
GPRS class 12	27.79	27.78	27.55	25.04	25.13	25.28
EGPRS class 8	26.14	26.07	26.16	25.87	25.81	25.73
EGPRS class 10	25.12	25.12	25.24	25.02	24.94	24.83
EGPRS class 11	23.16	23.17	23.08	23.19	23.12	22.94
EGPRS class 12	21.19	21.02	21.15	21.25	21.16	20.96

Conducted Power (*Unit: dBm)						
Band	WCDMA Band V			WCDMA Band II		
Channel	4132	4182	4233	9262	9400	9538
Frequency	826.4	836.4	846.6	1852.4	1880	1907.6
RMC 12.2Kbps	23.24	23.38	23.46	22.28	22.02	21.99
HSDPA Subtest-1	22.34	22.54	22.50	22.07	21.86	21.86
HSDPA Subtest-2	22.30	22.49	22.50	22.07	21.83	21.88
HSDPA Subtest-3	21.83	22.00	22.02	21.60	21.12	21.32
HSDPA Subtest-4	21.75	21.99	21.99	21.56	21.38	21.23
HSUPA Subtest-1	20.37	20.57	20.57	20.20	20.06	19.93
HSUPA Subtest-2	20.34	20.55	20.58	20.19	20.03	19.83
HSUPA Subtest-3	21.37	21.58	21.58	21.23	21.00	20.90
HSUPA Subtest-4	19.84	20.02	20.02	19.68	19.54	19.36
HSUPA Subtest-5	22.40	22.60	22.60	22.20	22.00	22.00



ERP/EIRP

GPRS 850 (G_T - L_C= -4.00dB)			
Channel	128	189	251
	(Low)	(Mid)	(High)
Frequency (MHz)	824.2	836.4	848.8
Conducted Power (dBm)	32.14	32.31	32.21
Conducted Power (Watts)	1.6368	1.7022	1.6634
ERP(dBm)	25.99	26.16	26.06
ERP(Watts)	0.3972	0.4130	0.4036

EDGE 850 (G_T - L_C= -4.00dB)			
Channel	128	189	251
	(Low)	(Mid)	(High)
Frequency (MHz)	824.2	836.4	848.8
Conducted Power (dBm)	26.14	26.07	26.16
Conducted Power (Watts)	0.4111	0.4046	0.4130
ERP(dBm)	19.99	19.92	20.01
ERP(Watts)	0.0998	0.0982	0.1002



GPRS 1900 ($G_T - L_C = -2.00\text{dB}$)			
Channel	512	661	810
	(Low)	(Mid)	(High)
Frequency (MHz)	1850.2	1880	1909.8
Conducted Power (dBm)	29.54	29.62	29.76
Conducted Power (Watts)	0.8995	0.9162	0.9462
EIRP(dBm)	27.54	27.62	27.76
EIRP(Watts)	0.5675	0.5781	0.5970

EDGE 1900 ($G_T - L_C = -2.00\text{dB}$)			
Channel	512	661	810
	(Low)	(Mid)	(High)
Frequency (MHz)	1850.2	1880	1909.8
Conducted Power (dBm)	25.87	25.81	25.73
Conducted Power (Watts)	0.3864	0.3811	0.3741
EIRP(dBm)	23.87	23.81	23.73
EIRP(Watts)	0.2438	0.2404	0.2360



WCDMA Band V ($G_T - L_C = -4.00\text{dB}$)			
Channel	4132	4182	4233
	(Low)	(Mid)	(High)
Frequency (MHz)	826.4	836.4	846.6
Conducted Power (dBm)	23.24	23.38	23.46
Conducted Power (Watts)	0.2109	0.2178	0.2218
ERP(dBm)	17.09	17.23	17.31
ERP(Watts)	0.0512	0.0528	0.0538

WCDMA Band II ($G_T - L_C = -2.00\text{dB}$)			
Channel	9262	9400	9538
	(Low)	(Mid)	(High)
Frequency (MHz)	1852.4	1880	1907.6
Conducted Power (dBm)	22.28	22.02	21.99
Conducted Power (Watts)	0.1690	0.1592	0.1581
EIRP(dBm)	20.28	20.02	19.99
EIRP(Watts)	0.1067	0.1005	0.0998



Peak-to-Average Ratio

Mode	GSM850(dB)		Limit: 13dB
Mod.	GPRS class 8	EDGE class 8	Result
Lowest CH	0.12	2.78	PASS
Middle CH	0.12	2.87	
Highest CH	0.20	2.84	

Mode	GSM1900(dB)		Limit: 13dB
Mod.	GPRS class 8	EDGE class 8	Result
Lowest CH	0.12	3.13	PASS
Middle CH	0.17	3.45	
Highest CH	0.12	3.28	

Mode	WCDMA Band V(dB)	WCDMA Band II(dB)	Limit: 13dB
Mod.	RMC 12.2Kbps	RMC 12.2Kbps	Result
Lowest CH	3.39	3.25	PASS
Middle CH	3.45	3.30	
Highest CH	3.39	3.25	

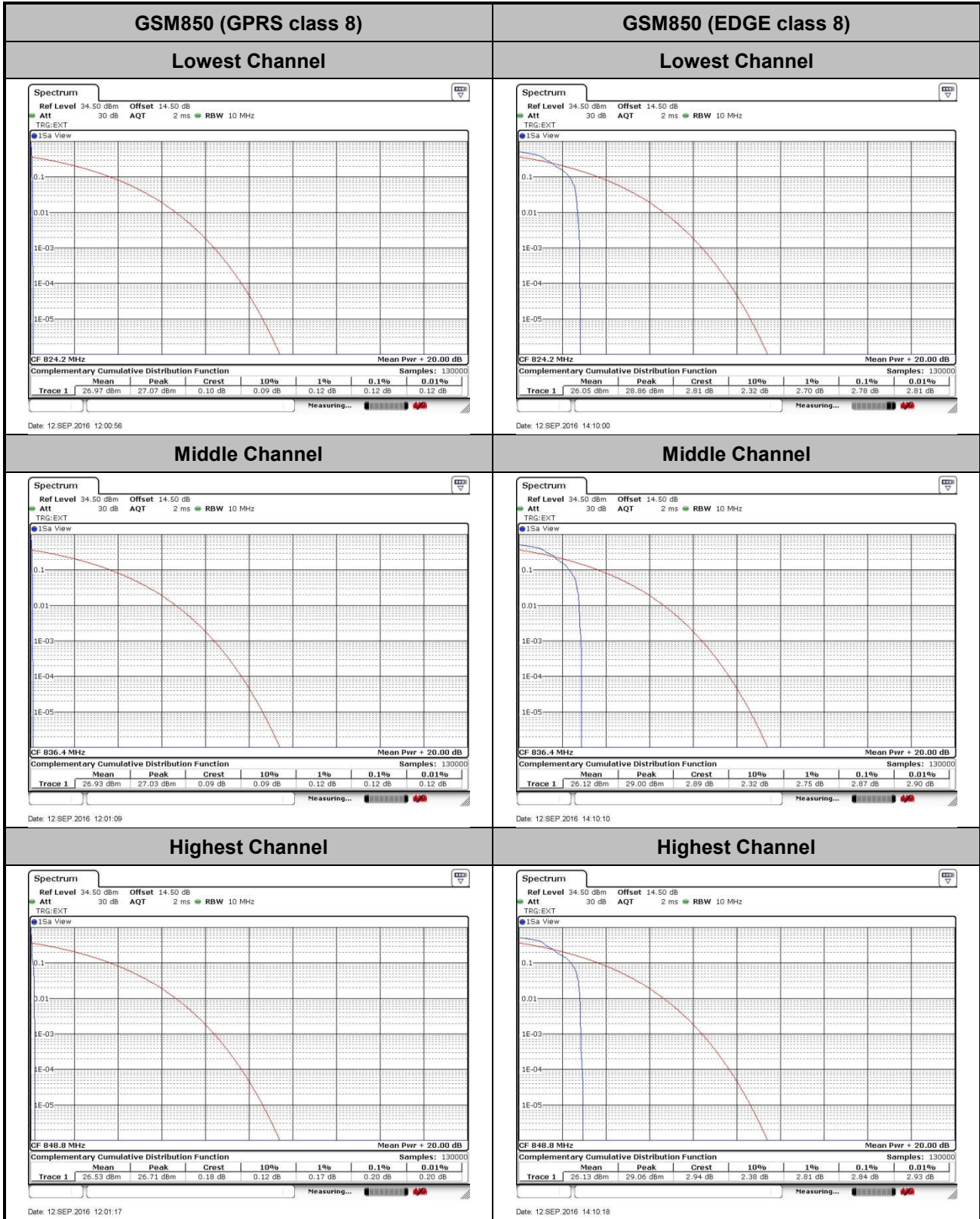

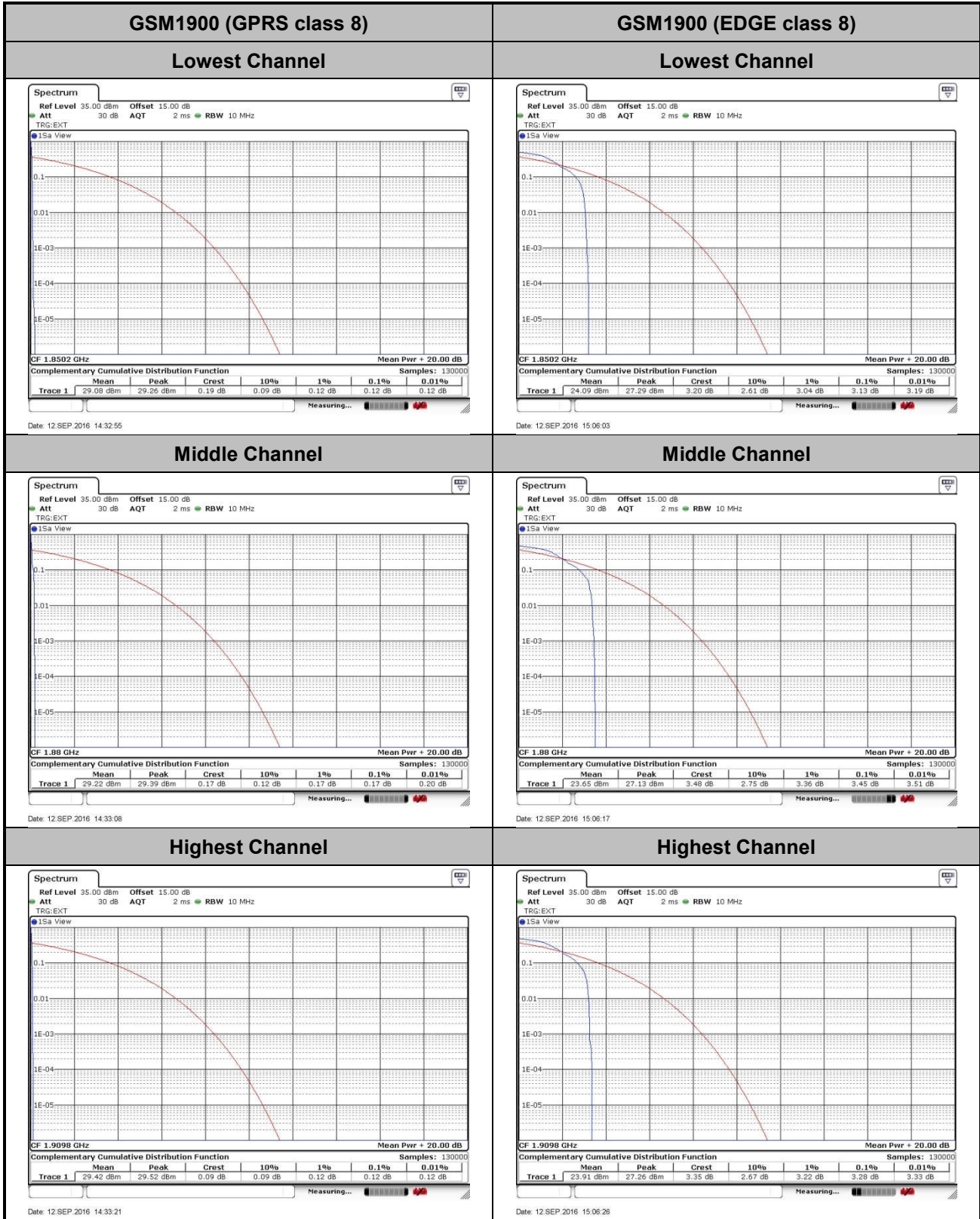

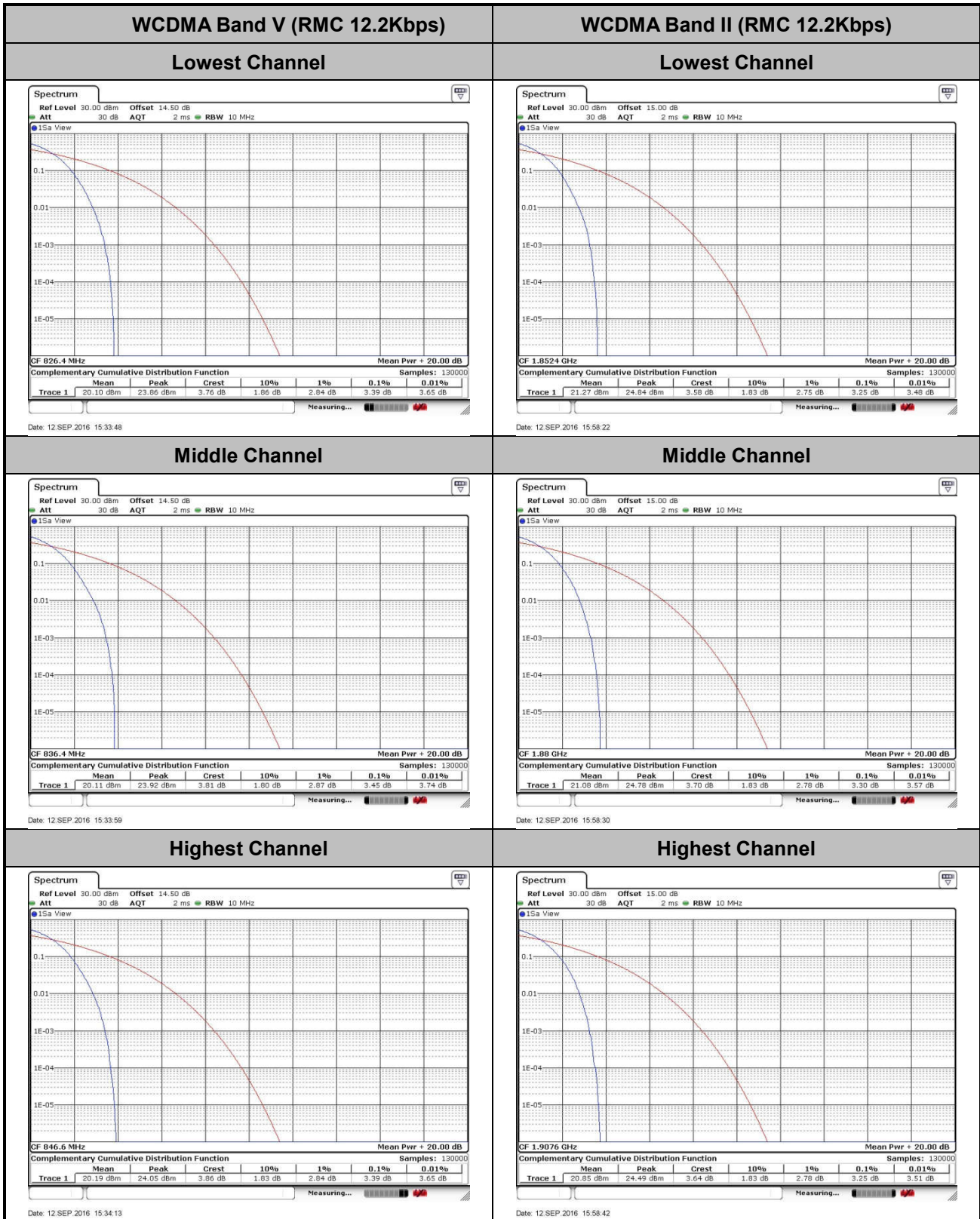



26dB Bandwidth

Mode	GSM850(MHz)	
Mod.	GPRS class 8	EDGE class 8
Lowest CH	0.317	0.321
Middle CH	0.318	0.324
Highest CH	0.318	0.322

Mode	GSM1900(MHz)	
Mod.	GPRS class 8	EDGE class 8
Lowest CH	0.316	0.322
Middle CH	0.317	0.314
Highest CH	0.318	0.315

Mode	WCDMA Band V(MHz)	WCDMA Band II(MHz)
Mod.	RMC 12.2Kbps	RMC 12.2Kbps
Lowest CH	4.67	4.67
Middle CH	4.68	4.67
Highest CH	4.67	4.67

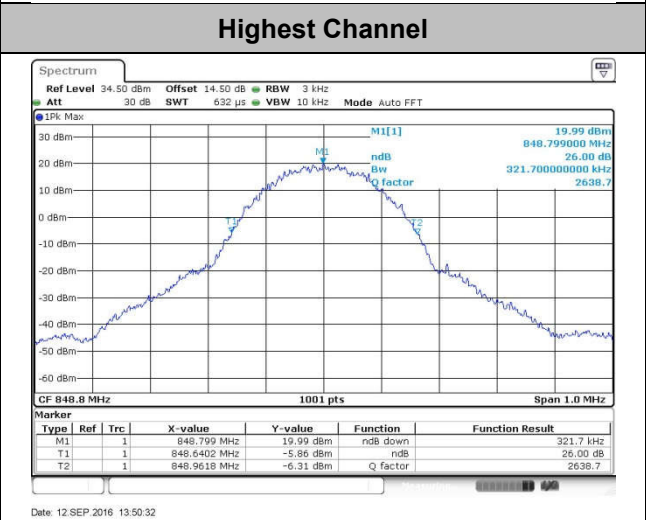
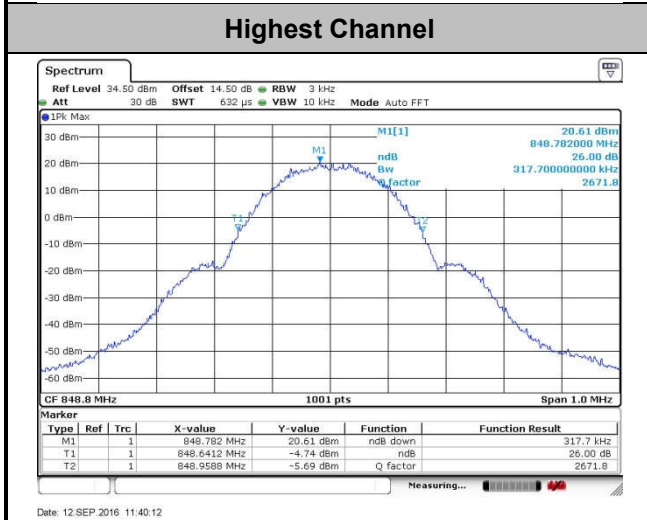
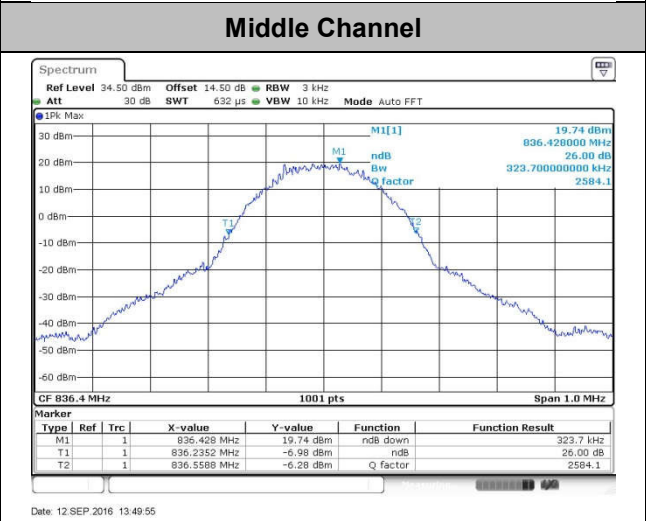
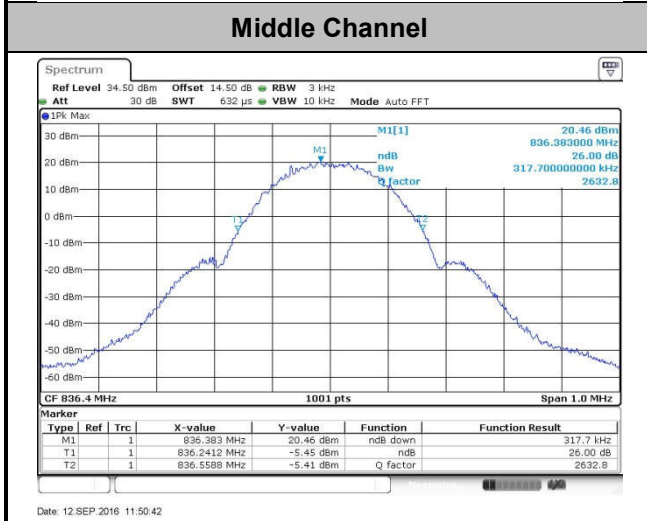
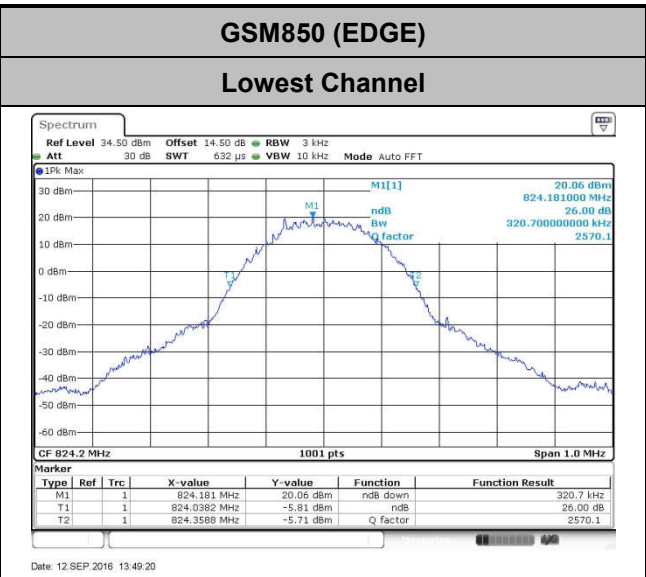
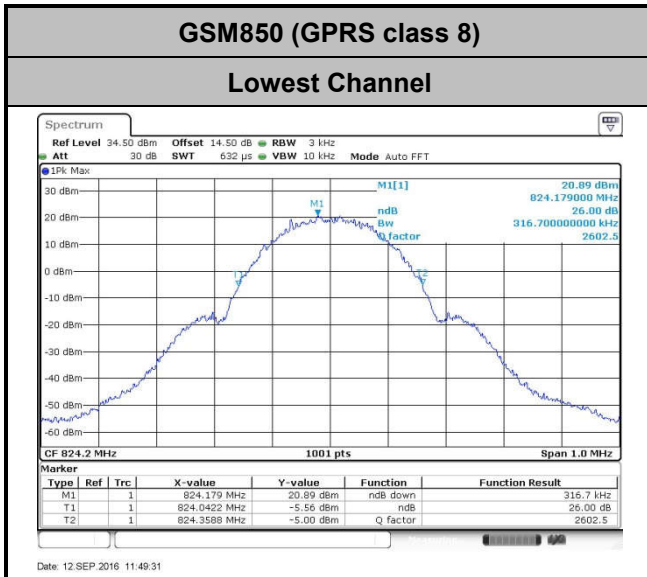



GSM1900 (GPRS class 8)

Lowest Channel

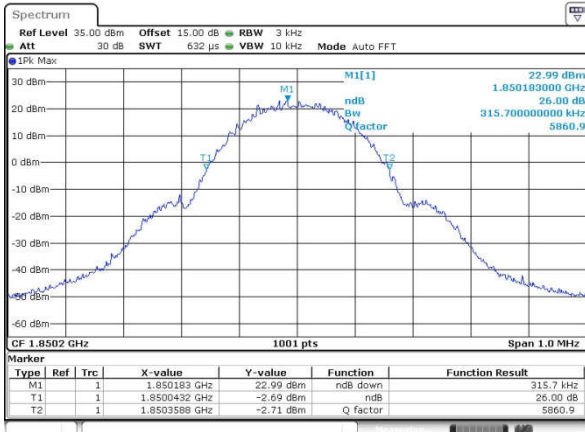

Date: 12 SEP 2016 14:18:44

GSM1900 (EDGE class 8)

Lowest Channel

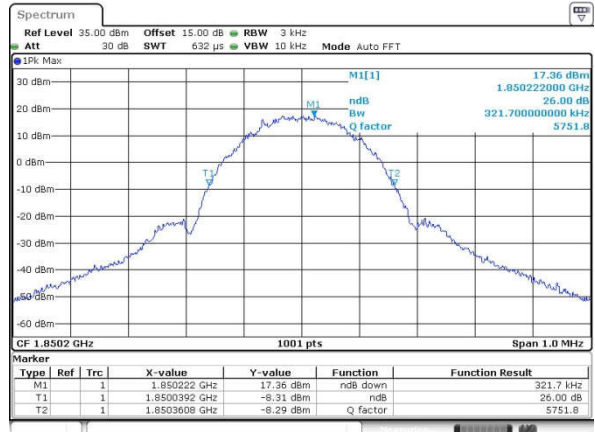

Date: 12 SEP 2016 14:37:59

Middle Channel

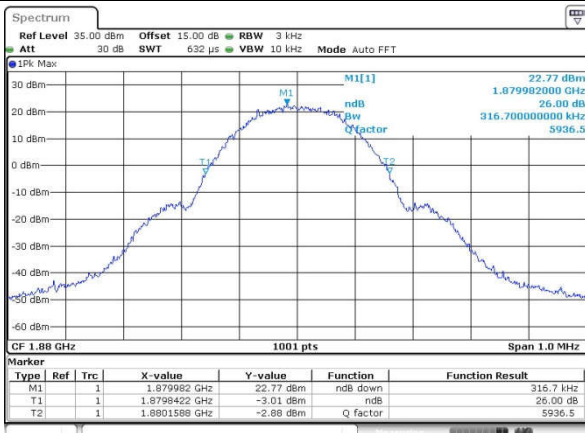

Date: 12 SEP 2016 14:19:21

Middle Channel

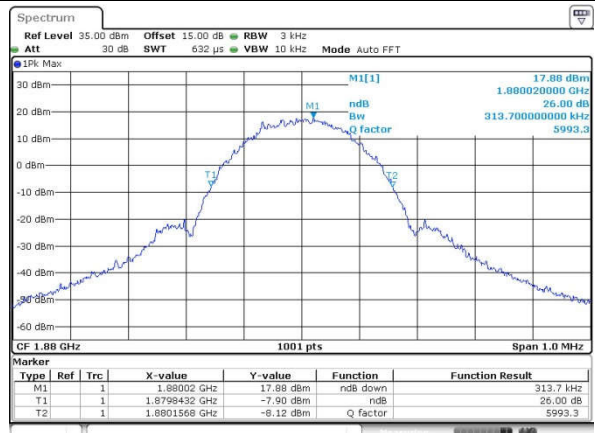

Date: 12 SEP 2016 14:38:35

Highest Channel

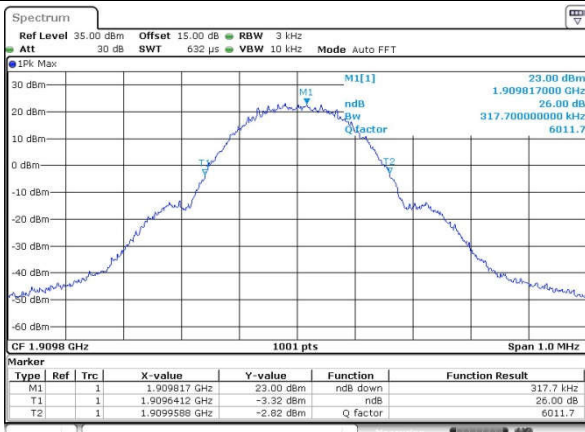

Date: 12 SEP 2016 14:20:19

Highest Channel

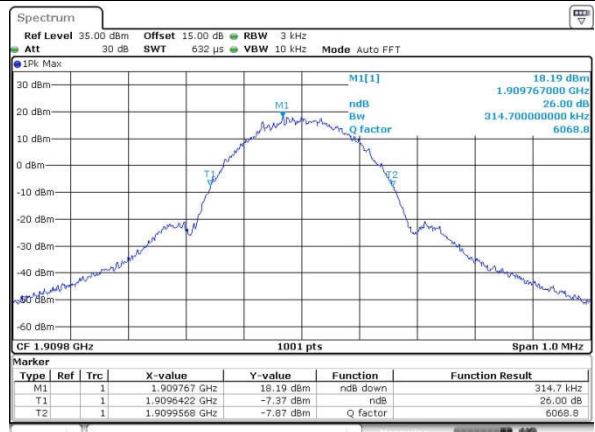

Date: 12 SEP 2016 14:39:12



WCDMA Band V (RMC 12.2Kbps)

Lowest Channel

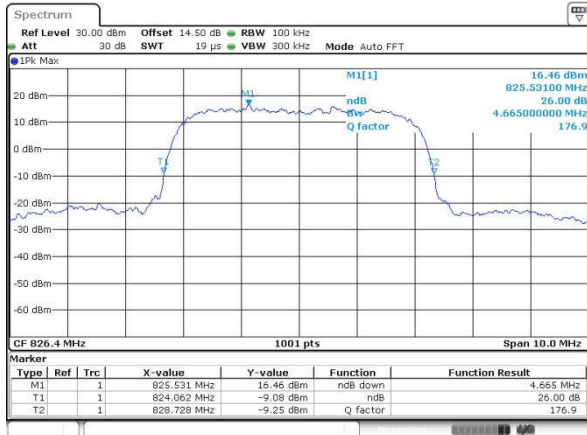

Date: 12 SEP 2016 15:13:28

WCDMA Band II (RMC 12.2Kbps)

Lowest Channel

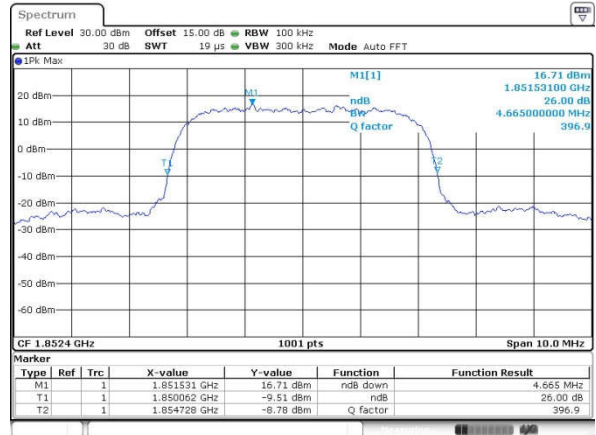

Date: 12 SEP 2016 15:35:49

Middle Channel

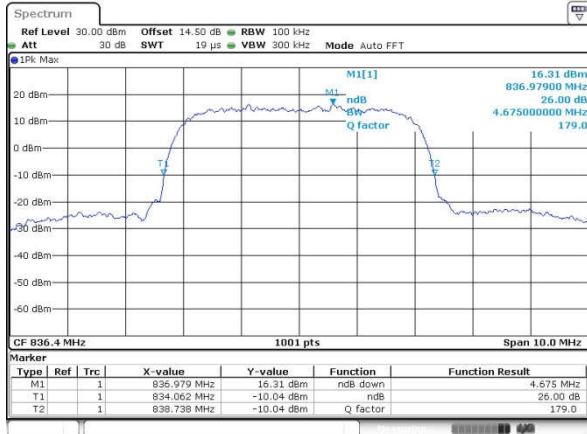

Date: 12 SEP 2016 15:14:20

Middle Channel

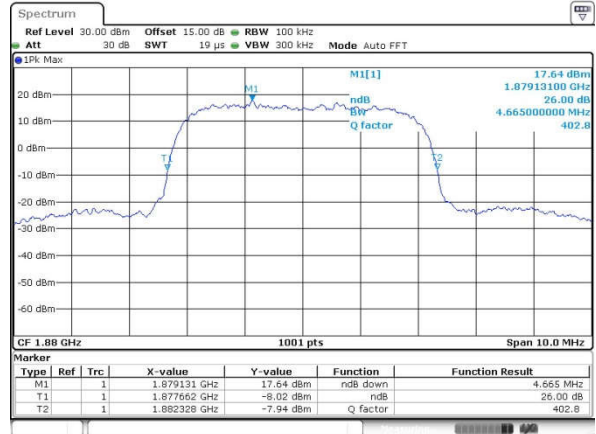

Date: 12 SEP 2016 15:36:54

Highest Channel

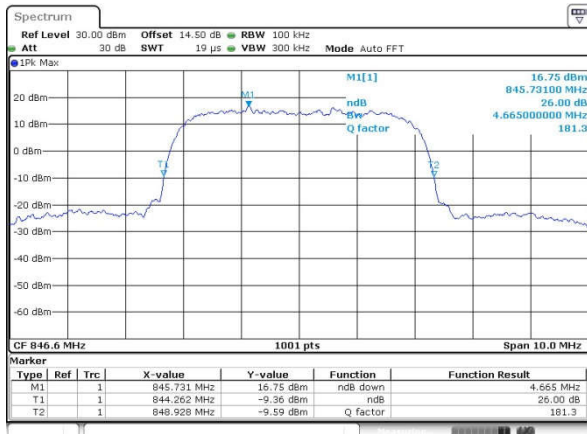

Date: 12 SEP 2016 15:14:57

Highest Channel

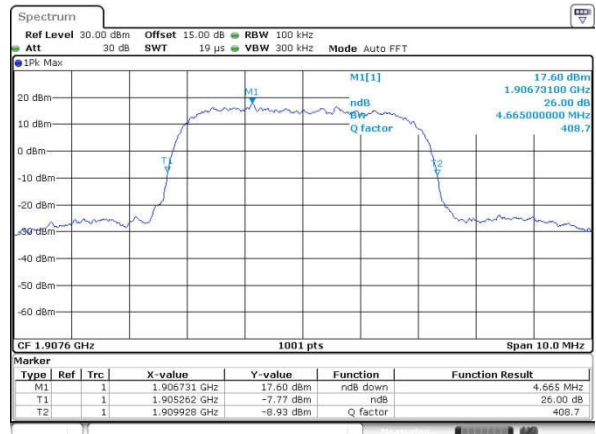

Date: 12 SEP 2016 15:37:31



Occupied Bandwidth

Mode	GSM850(MHz)	
Mod.	GPRS class 8	EDGE class 8
Lowest CH	0.242	0.255
Middle CH	0.243	0.253
Highest CH	0.242	0.249

Mode	GSM1900(MHz)	
Mod.	GPRS class 8	EDGE class 8
Lowest CH	0.243	0.252
Middle CH	0.242	0.251
Highest CH	0.241	0.249

Mode	WCDMA Band V	WCDMA Band II
Mod.	RMC 12.2Kbps	RMC 12.2Kbps
Lowest CH	4.16	4.15
Middle CH	4.14	4.15
Highest CH	4.15	4.15



GSM850 (GPRS class 8)

Lowest Channel

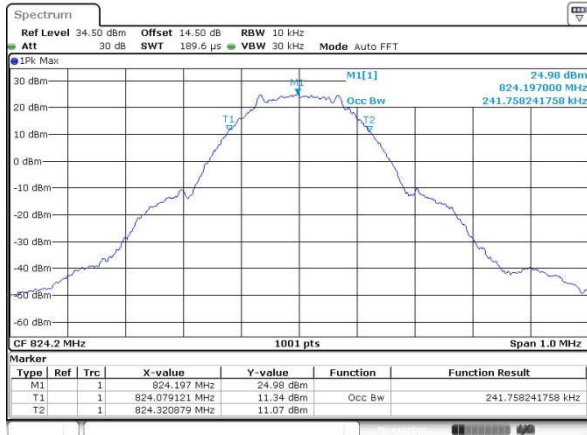

Date: 12 SEP 2016 11:44:16

GSM850 (EDGE class 8)

Lowest Channel

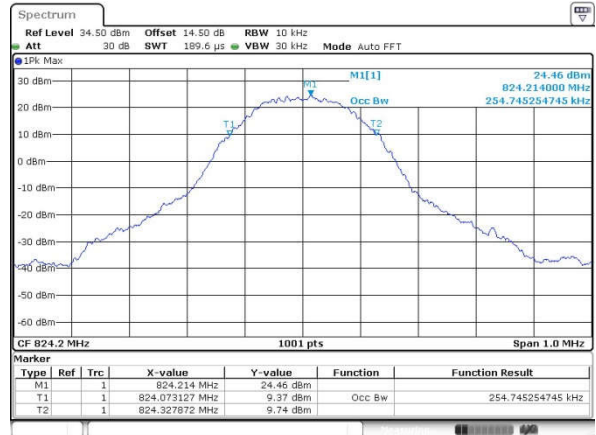

Date: 12 SEP 2016 13:56:26

Middle Channel

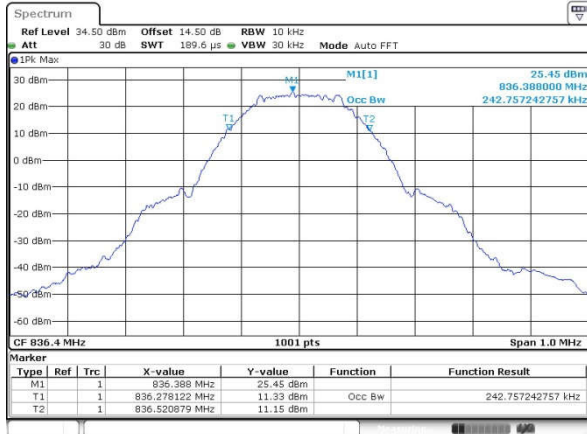

Date: 12 SEP 2016 11:44:53

Middle Channel

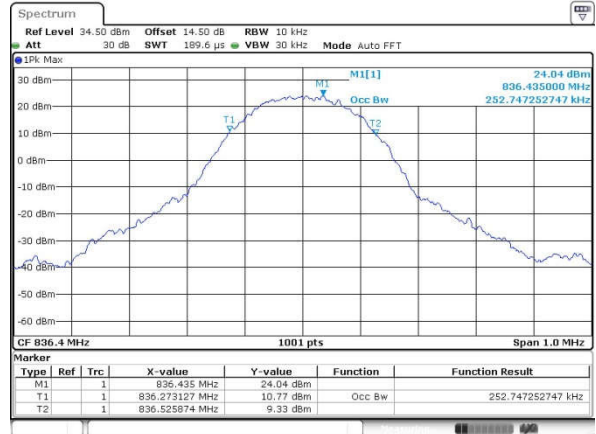

Date: 12 SEP 2016 13:57:08

Highest Channel

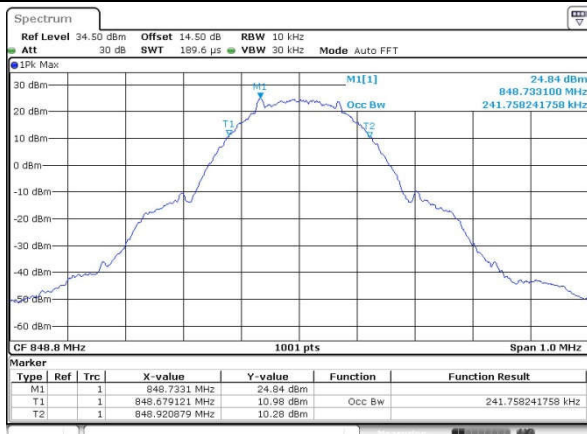

Date: 12 SEP 2016 11:46:22

Highest Channel

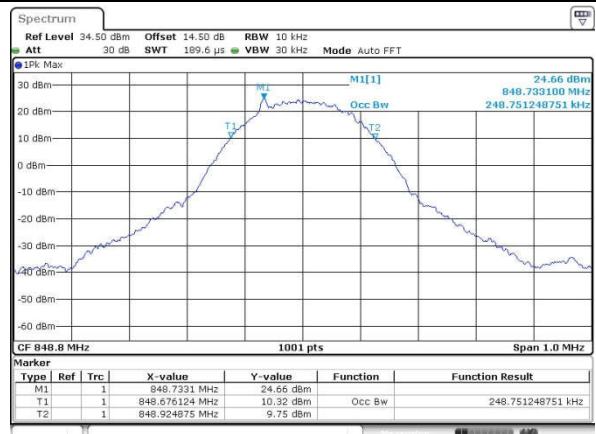

Date: 12 SEP 2016 13:58:24



GSM1900 (GPRS class 8)

Lowest Channel

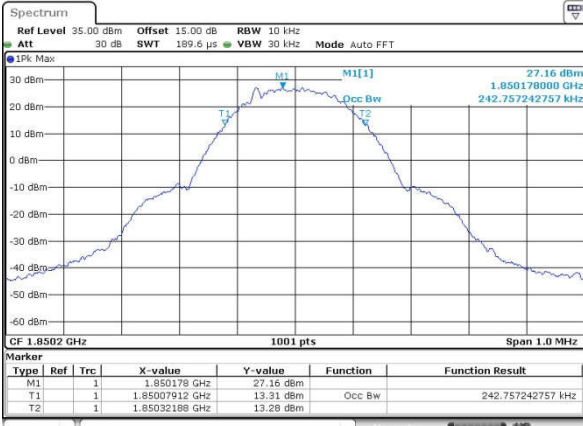

Date: 12 SEP 2016 14:21:07

GSM1900 (EDGE class 8)

Lowest Channel

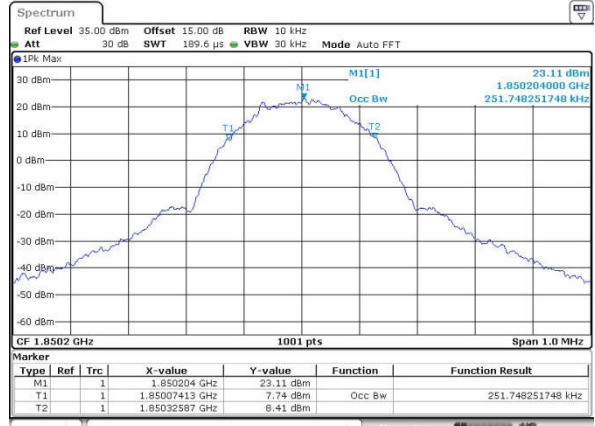

Date: 12 SEP 2016 14:47:38

Middle Channel

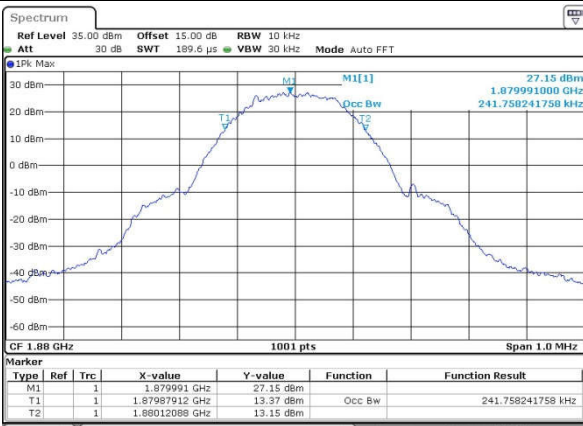

Date: 12 SEP 2016 14:22:11

Middle Channel

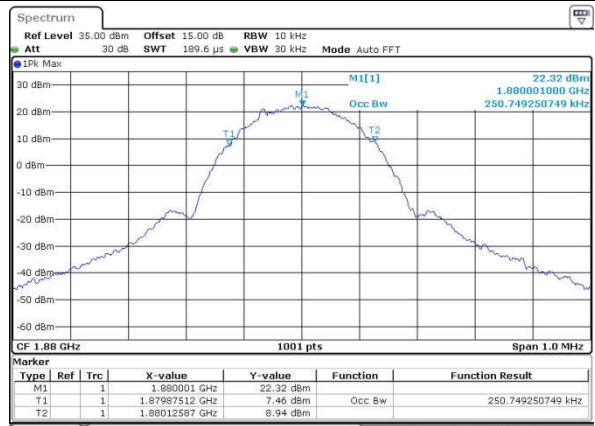

Date: 12 SEP 2016 14:48:15

Highest Channel

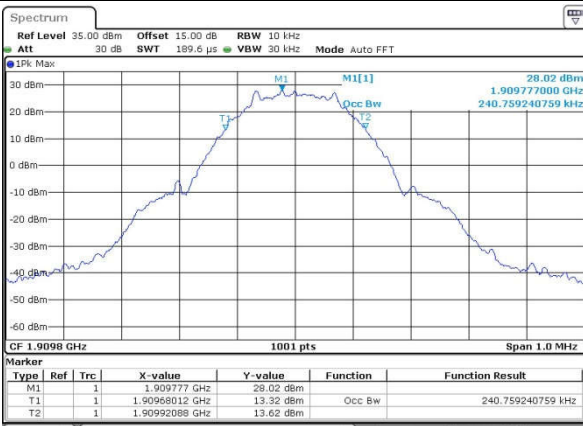

Date: 12 SEP 2016 14:22:58

Highest Channel

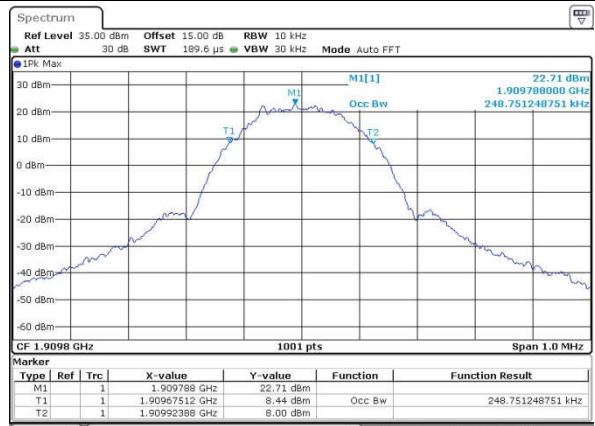

Date: 12 SEP 2016 14:48:50



WCDMA Band V (RMC 12.2Kbps)

Lowest Channel

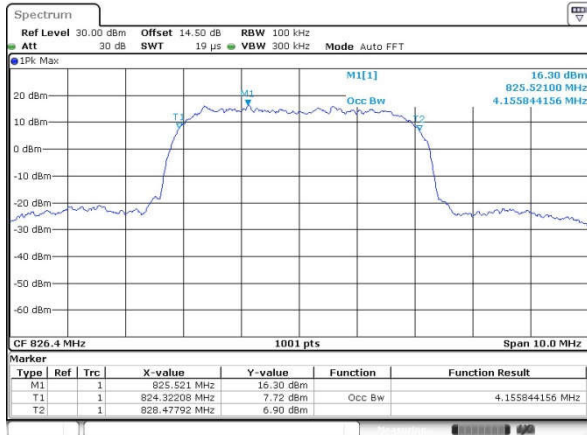

Date: 12 SEP 2016 15:19:00

WCDMA Band II (RMC 12.2Kbps)

Lowest Channel

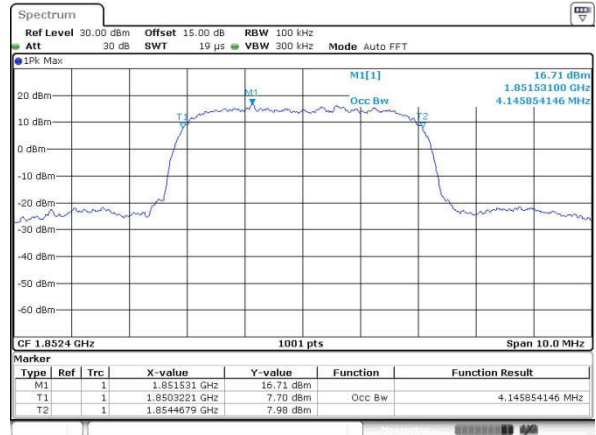

Date: 12 SEP 2016 15:45:20

Middle Channel

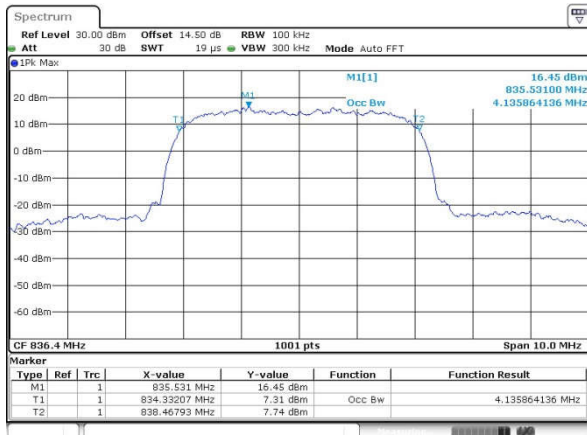

Date: 12 SEP 2016 15:19:36

Middle Channel

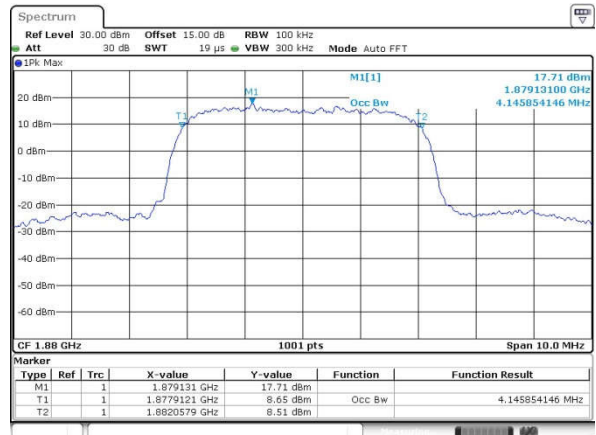

Date: 12 SEP 2016 15:46:10

Highest Channel

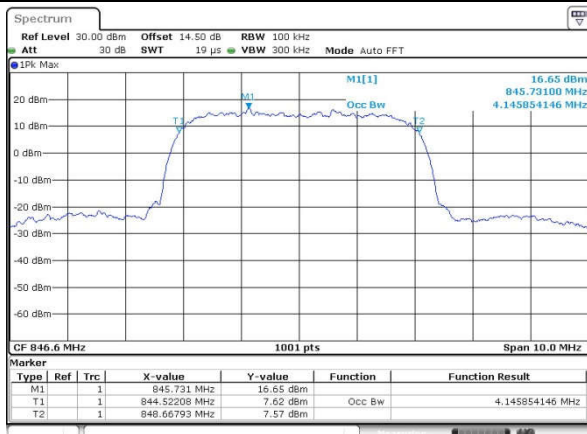

Date: 12 SEP 2016 15:20:24

Highest Channel

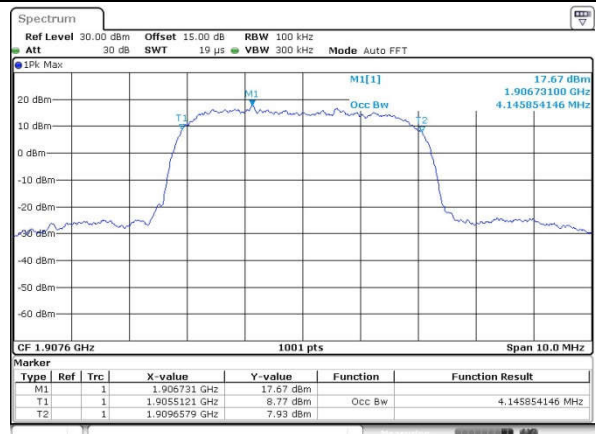

Date: 12 SEP 2016 15:46:56



Conducted Band Edge

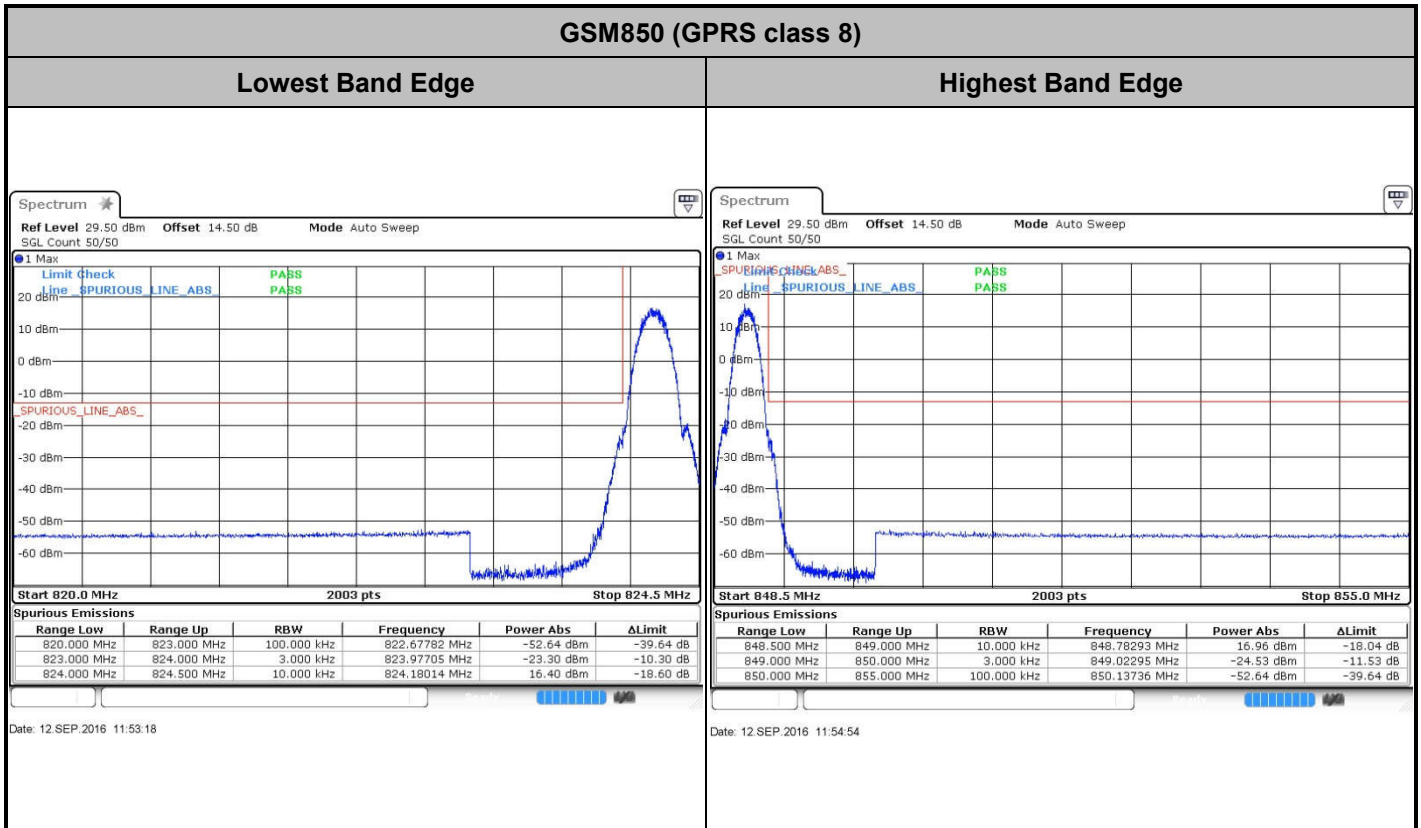

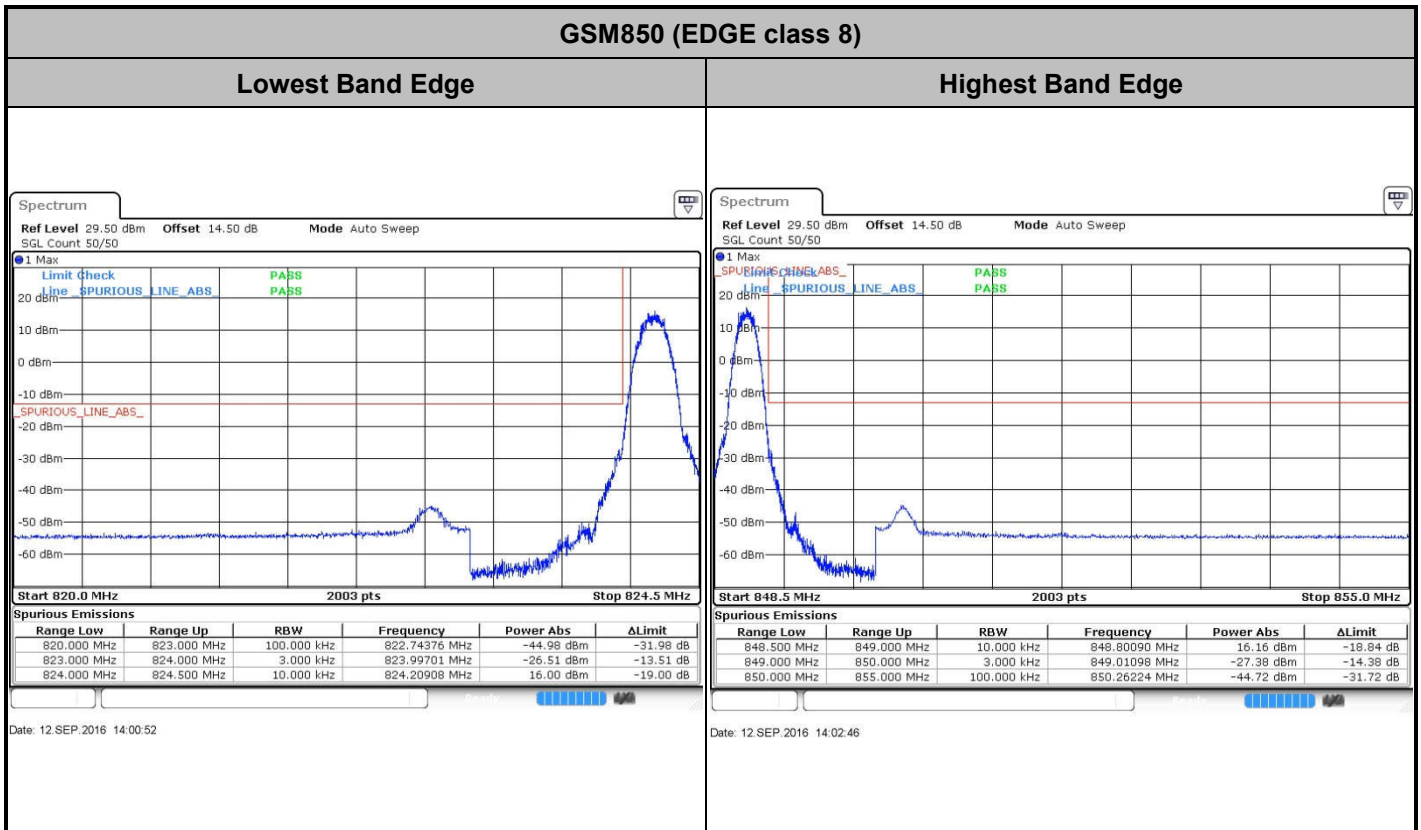



GSM1900 (GPRS class 8)

Lowest Band Edge

Highest Band Edge

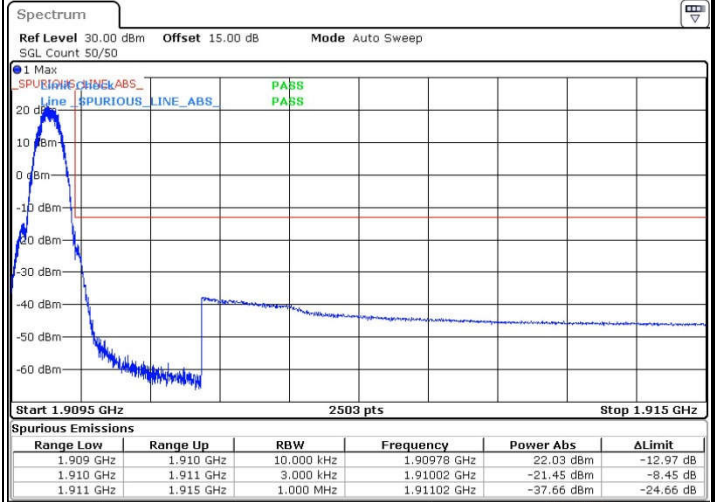
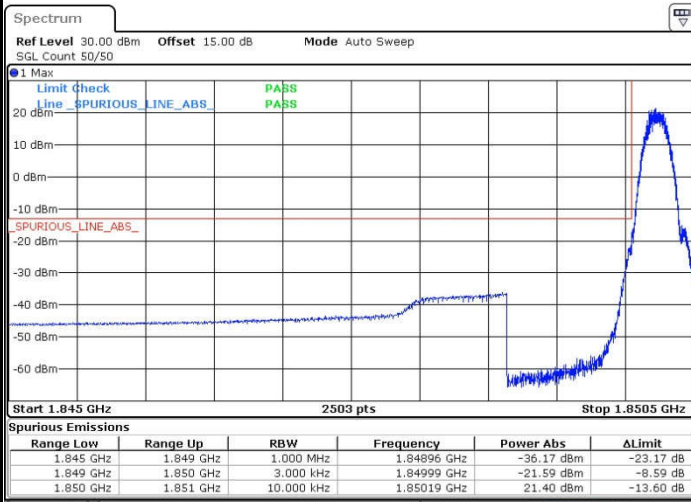

Date: 12.SEP.2016 14:26:51

Date: 12.SEP.2016 14:28:29

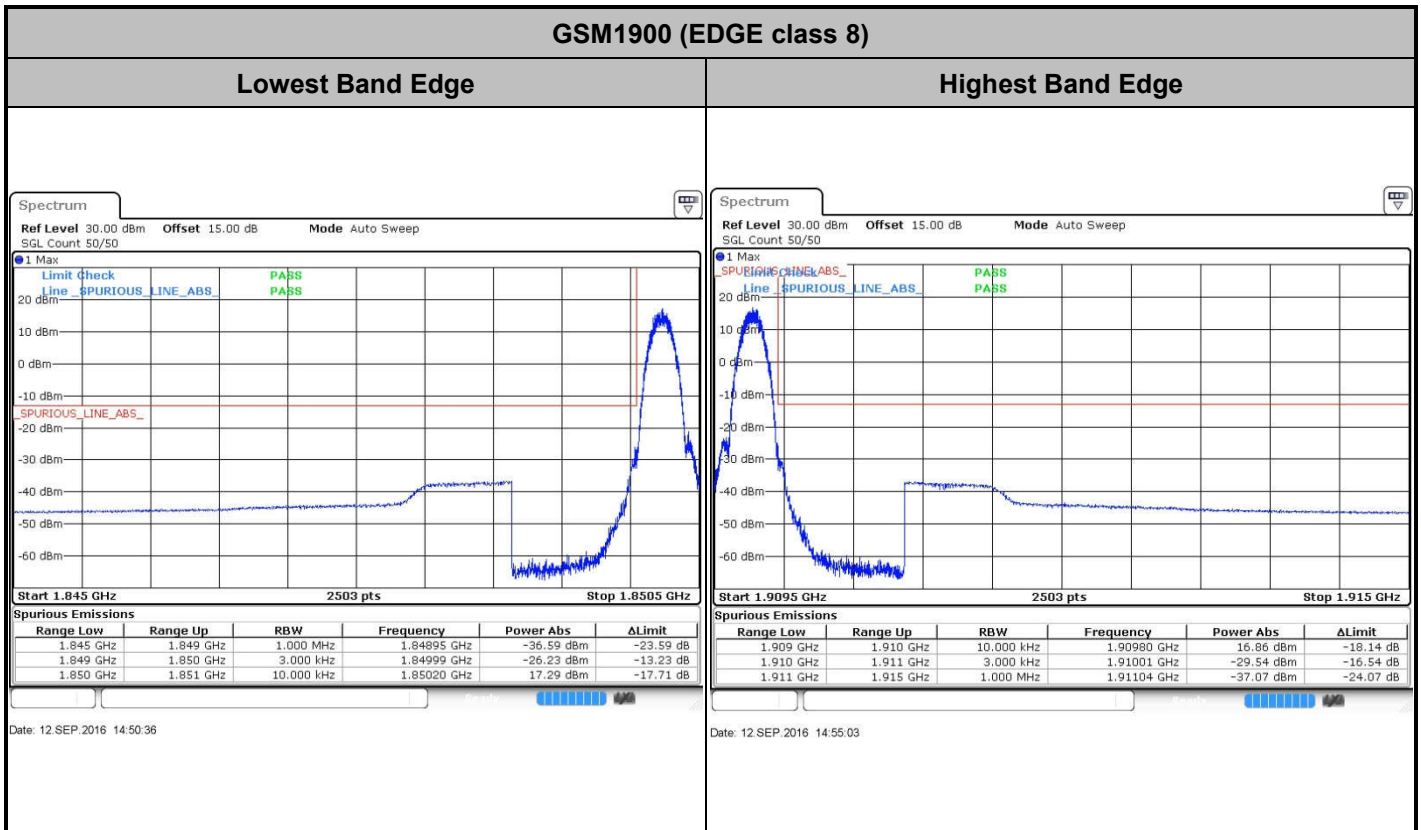



WCDMA Band V (RMC 12.2Kbps)

Lowest Band Edge

Highest Band Edge



Date: 12.SEP.2016 15:23:34

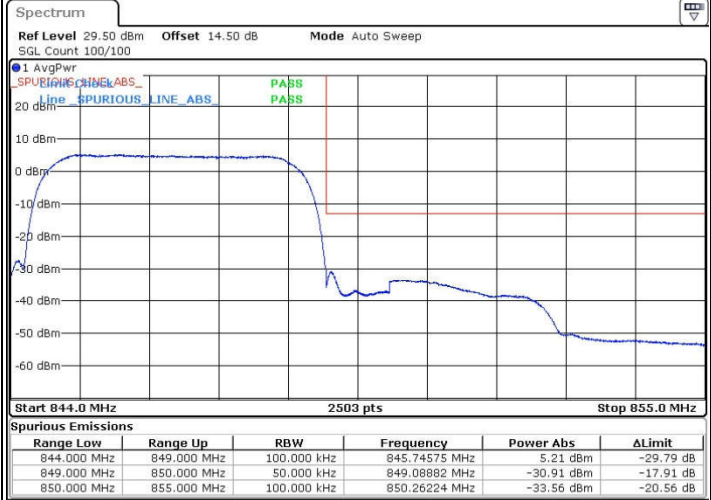

Date: 12.SEP.2016 15:28:24

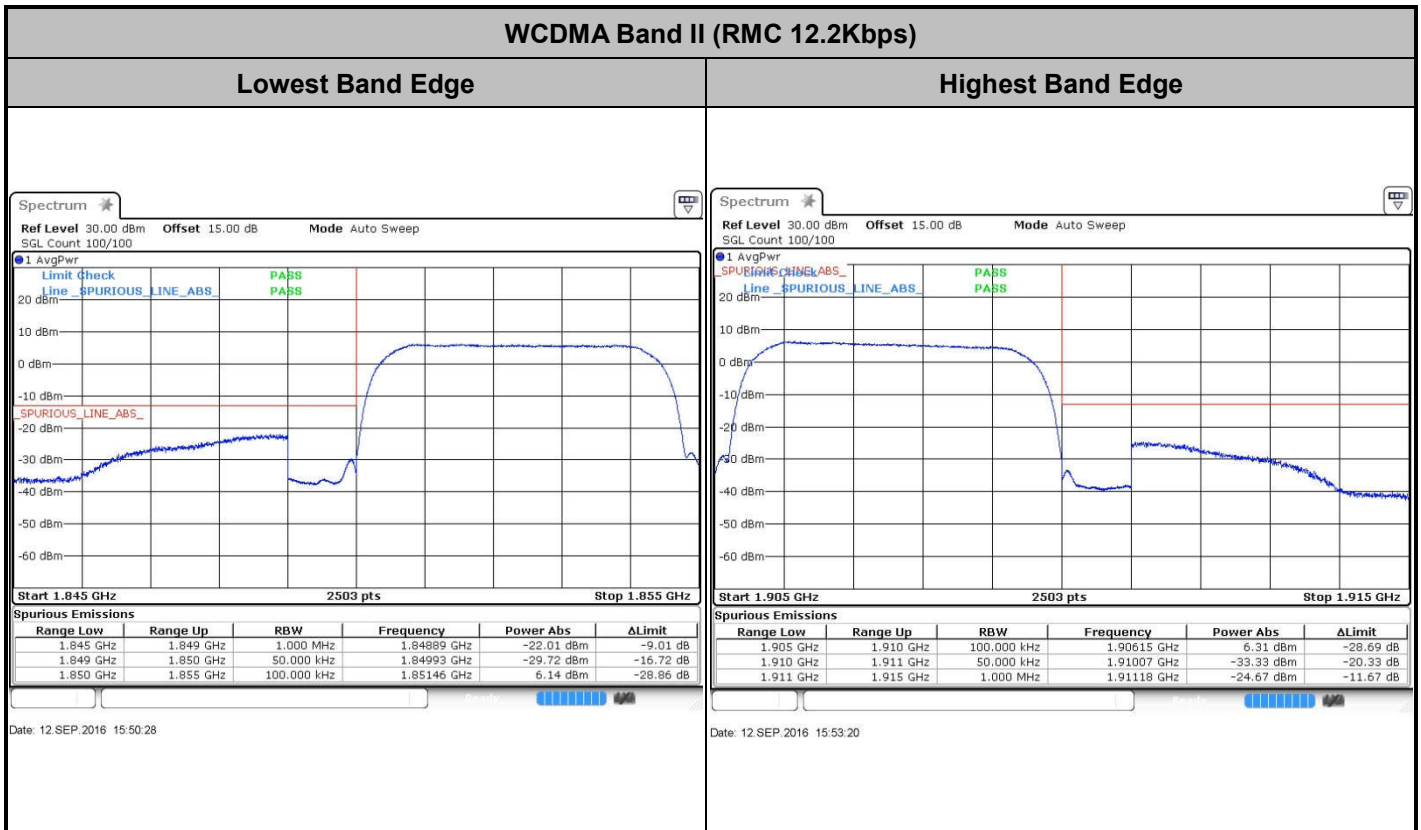



Conducted Spurious Emission

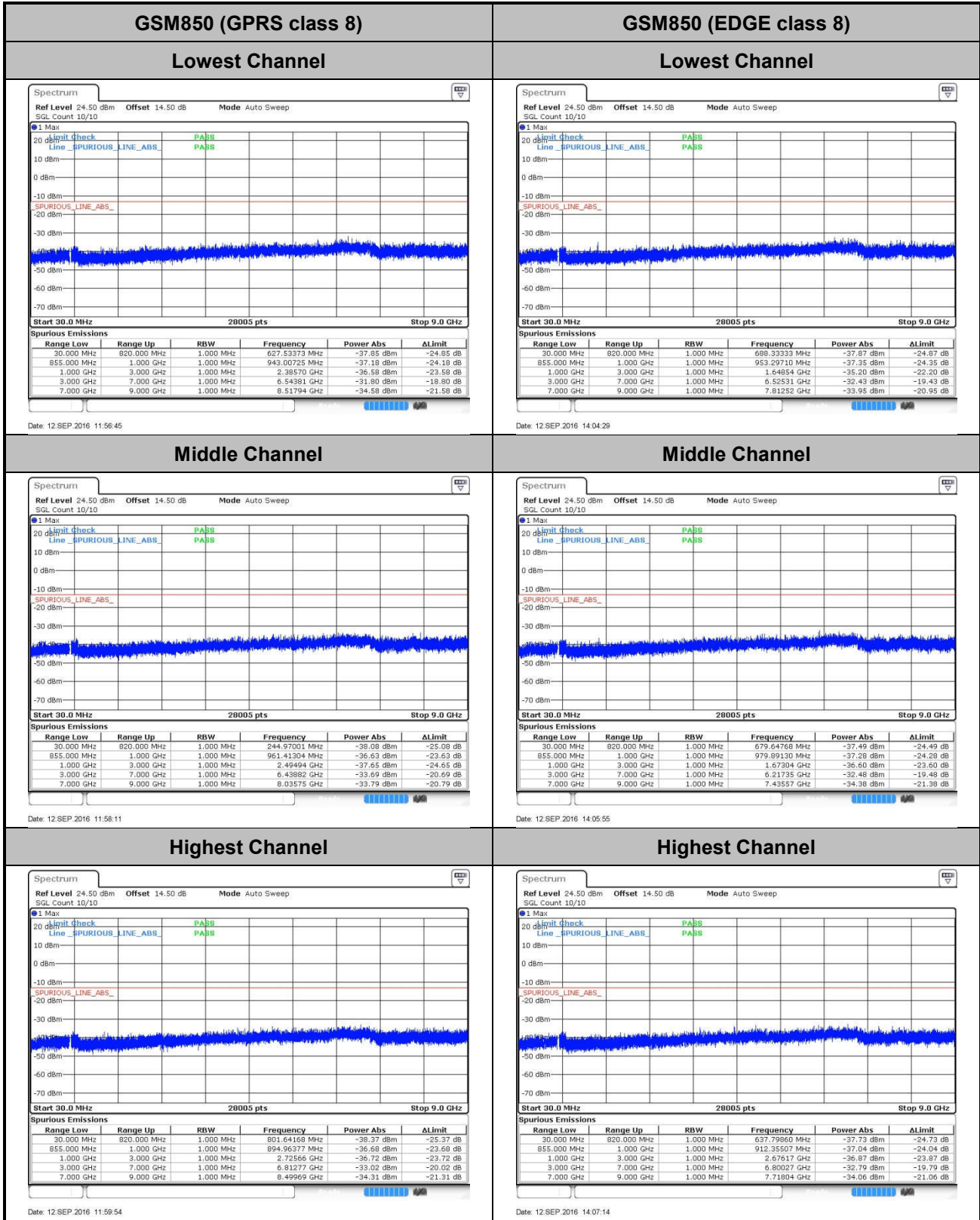

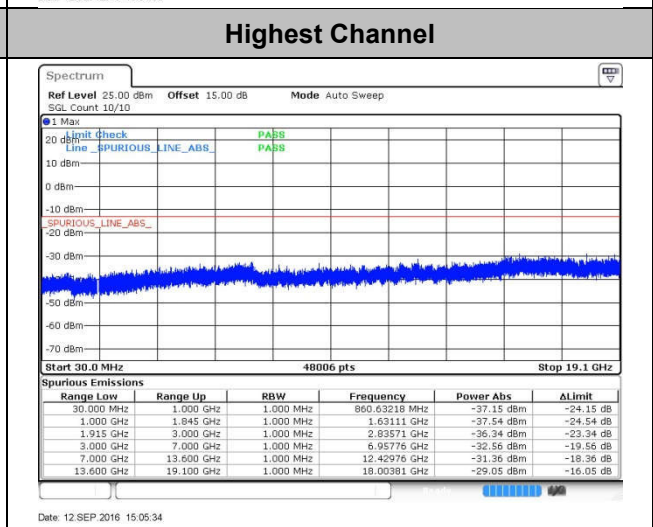
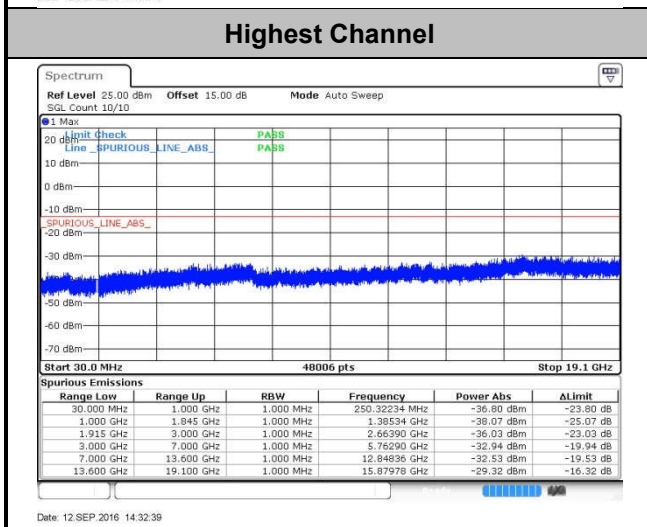
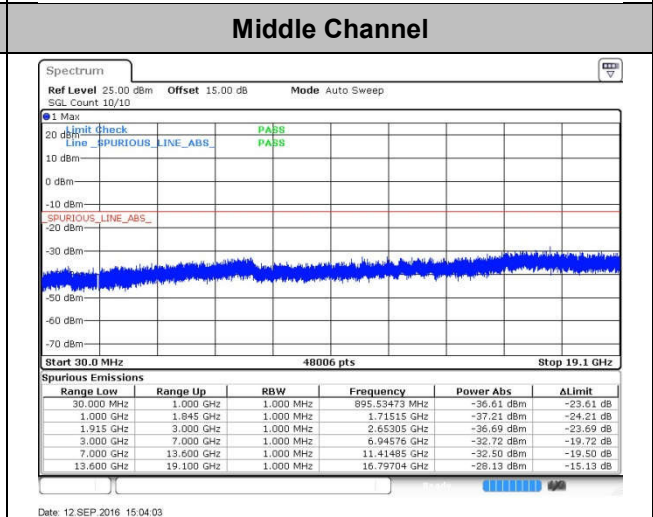
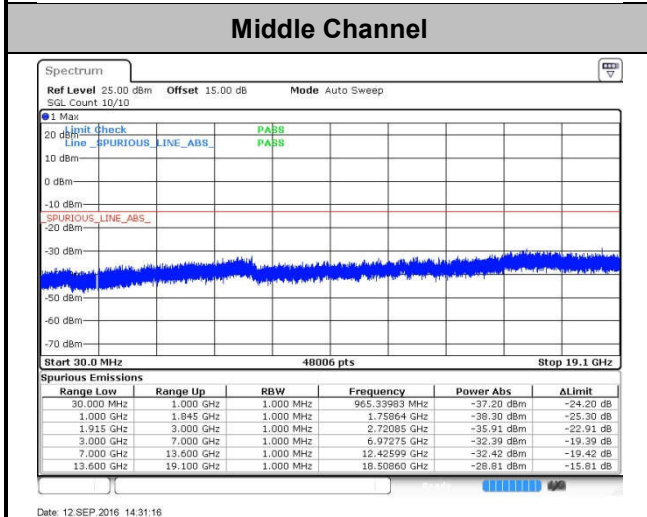
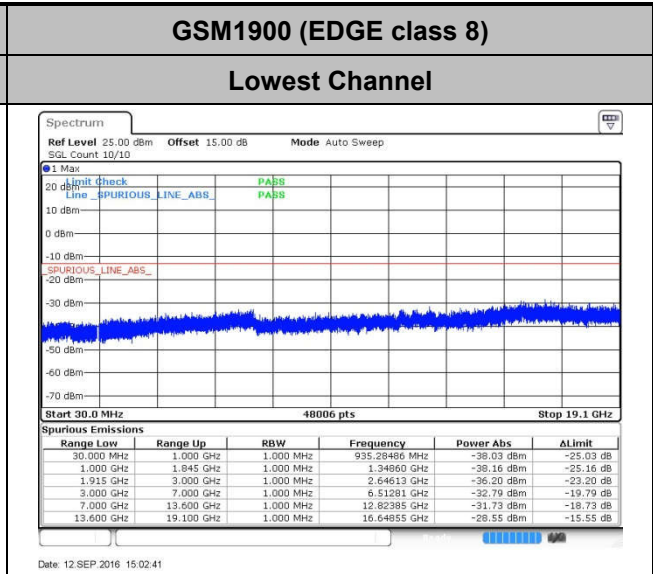
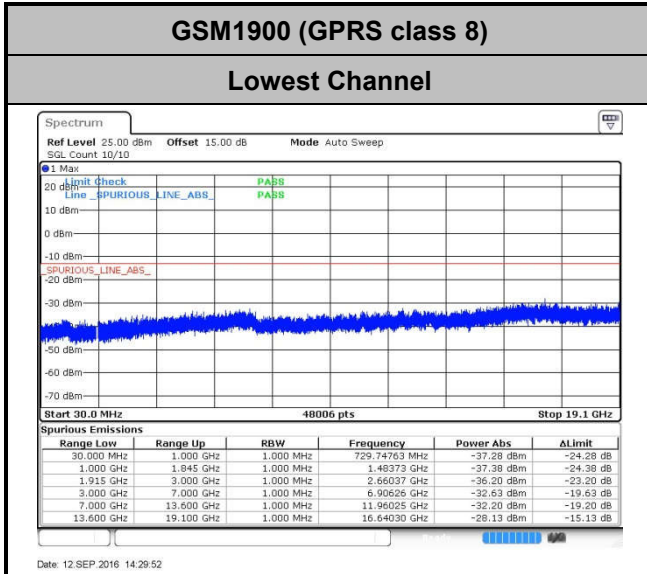



WCDMA Band V (RMC 12.2Kbps)

Lowest Channel

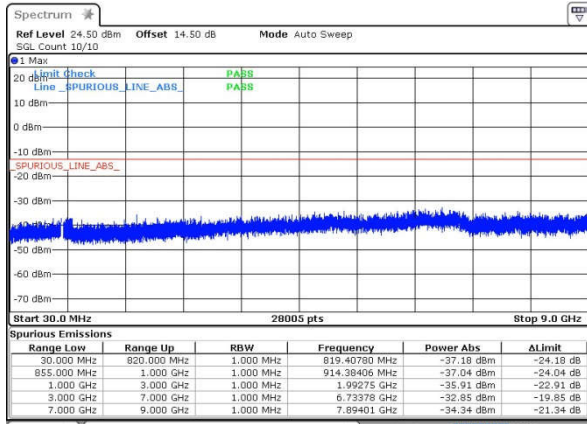

Date: 12 SEP 2016 15:28:06

WCDMA Band II (RMC 12.2Kbps)

Lowest Channel

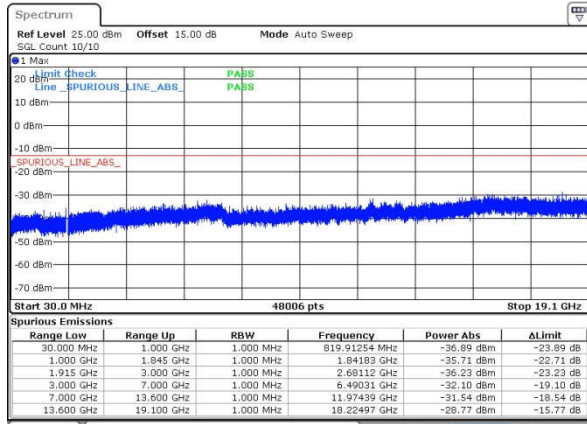

Date: 12 SEP 2016 15:55:02

Middle Channel

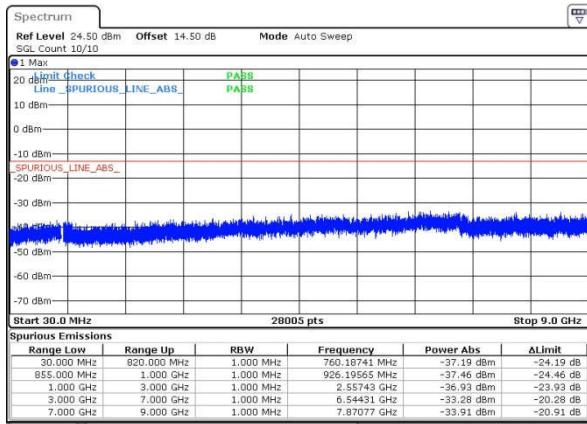

Date: 12 SEP 2016 15:30:40

Middle Channel

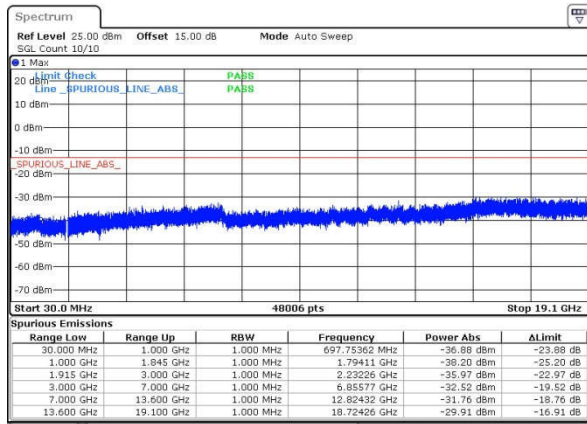

Date: 12 SEP 2016 15:56:28

Highest Channel

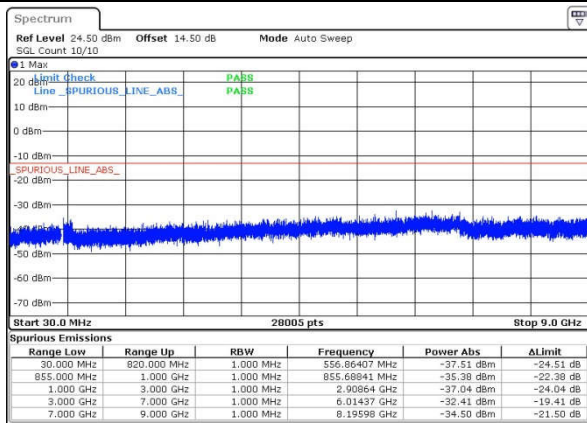

Date: 12 SEP 2016 15:32:06

Highest Channel

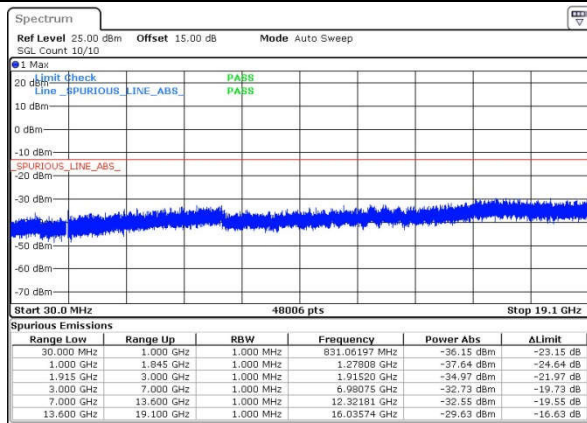

Date: 12 SEP 2016 15:57:59



Frequency Stability

Test Conditions	Middle Channel	GSM850 (GPRS class 8)	GSM850 (EDGE class 8)	Limit 2.5ppm
Temperature (°C)	Voltage (Volt)	Deviation (ppm)		Result
50	Normal Voltage	0.0574	0.0036	PASS
40	Normal Voltage	0.0586	0.0072	
30	Normal Voltage	0.0610	0.0012	
20(Ref.)	Normal Voltage	0.0000	0.0000	
10	Normal Voltage	0.0550	0.0108	
0	Normal Voltage	0.0574	0.0155	
-10	Normal Voltage	0.0012	0.0096	
-20	Normal Voltage	0.0514	0.0143	
-30	Normal Voltage	0.0048	0.0120	
20	Maximum Voltage	0.0538	0.0155	
20	Normal Voltage	0.0060	0.0072	
20	Battery End Point	0.0526	0.0215	

Note: Normal Voltage = 4V. ; Battery End Point (BEP) = 3.6 V. ; Maximum Voltage =4.35 V



Test Conditions	Middle Channel	GSM1900 (GPRS class 8)	GSM1900 (EDGE class 8)	Limit Note 2.
Temperature (°C)	Voltage (Volt)	Deviation (ppm)		Result
50	Normal Voltage	0.0074	0.0037	PASS
40	Normal Voltage	0.0112	0.0074	
30	Normal Voltage	0.0064	0.0090	
20(Ref.)	Normal Voltage	0.0000	0.0000	
10	Normal Voltage	0.0404	0.0069	
0	Normal Voltage	0.0016	0.0085	
-10	Normal Voltage	0.0011	0.0223	
-20	Normal Voltage	0.0378	0.0016	
-30	Normal Voltage	0.0021	0.0011	
20	Maximum Voltage	0.0085	0.0016	
20	Normal Voltage	0.0069	0.0027	
20	Battery End Point	0.0043	0.0053	

Note:

1. Normal Voltage = 4V. ; Battery End Point (BEP) = 3.6 V. ; Maximum Voltage =4.35 V
2. The frequency fundamental emissions stay within the authorized frequency block based on the frequency deviation measured is small.



Test Conditions	Middle Channel	WCDMA Band V (RMC 12.2Kbps)	Limit 2.5ppm
Temperature (°C)	Voltage (Volt)	Deviation (ppm)	Result
50	Normal Voltage	0.0490	PASS
40	Normal Voltage	0.0526	
30	Normal Voltage	0.0466	
20(Ref.)	Normal Voltage	0.0000	
10	Normal Voltage	0.0407	
0	Normal Voltage	0.0036	
-10	Normal Voltage	0.0024	
-20	Normal Voltage	0.0036	
-30	Normal Voltage	0.0371	
20	Maximum Voltage	0.0048	
20	Normal Voltage	0.0060	
20	Battery End Point	0.0215	

Note: Normal Voltage = 4V. ; Battery End Point (BEP) = 3.6 V. ; Maximum Voltage =4.35 V



Test Conditions	Middle Channel	WCDMA Band II (RMC 12.2Kbps)	Limit Note 2.
Temperature (°C)	Voltage (Volt)	Deviation (ppm)	Result
50	Normal Voltage	0.0495	PASS
40	Normal Voltage	0.0426	
30	Normal Voltage	0.0723	
20(Ref.)	Normal Voltage	0.0000	
10	Normal Voltage	0.0128	
0	Normal Voltage	0.0473	
-10	Normal Voltage	0.0048	
-20	Normal Voltage	0.0489	
-30	Normal Voltage	0.0495	
20	Maximum Voltage	0.0085	
20	Normal Voltage	0.0117	
20	Battery End Point	0.0394	

Note:

1. Normal Voltage = 4V. ; Battery End Point (BEP) = 3.6 V. ; Maximum Voltage =4.35 V
2. The frequency fundamental emissions stay within the authorized frequency block based on the frequency deviation measured is small.



Appendix B. Test Results of Radiated Test

Radiated Spurious Emission

GSM850 (GPRS class 8)									
Channel	Frequency (MHz)	ERP (dBm)	Limit (dBm)	Over Limit (dB)	SPA Reading (dBm)	S.G. Power (dBm)	TX Cable loss (dB)	TX Antenna Gain (dBi)	Polarization (H/V)
Middle	1672	-45.52	-13	-32.52	-52.68	-49.93	2.84	9.40	H
	2510	-53.08	-13	-40.08	-60.49	-57.83	3.7	10.60	H
	3346	-55.59	-13	-42.59	-66.48	-61.67	4.37	12.60	H
	1672	-47.37	-13	-34.37	-53.45	-51.78	2.84	9.40	V
	2510	-55.05	-13	-42.05	-61.94	-59.80	3.70	10.60	V
	3346	-56.76	-13	-43.76	-66.98	-62.84	4.37	12.60	V

Remark: Spurious emissions within 30-1000MHz were found more than 20dB below limit line.

GSM850 (EDGE class 8)									
Channel	Frequency (MHz)	ERP (dBm)	Limit (dBm)	Over Limit (dB)	SPA Reading (dBm)	S.G. Power (dBm)	TX Cable loss (dB)	TX Antenna Gain (dBi)	Polarization (H/V)
Middle	1672	-57.53	-13	-44.53	-62.20	-61.94	2.84	9.40	H
	2510	-60.46	-13	-47.46	-67.87	-65.21	3.7	10.60	H
	3346	-57.02	-13	-44.02	-67.91	-63.10	4.37	12.60	H
	1672	-58.78	-13	-45.78	-62.23	-63.19	2.84	9.40	V
	2510	-61.55	-13	-48.55	-68.44	-66.30	3.70	10.60	V
	3346	-58.48	-13	-45.48	-68.70	-64.56	4.37	12.60	V

Remark: Spurious emissions within 30-1000MHz were found more than 20dB below limit line.

GSM1900 (GPRS class 8)									
Channel	Frequency (MHz)	EIRP (dBm)	Limit (dBm)	Over Limit (dB)	SPA Reading (dBm)	S.G. Power (dBm)	TX Cable loss (dB)	TX Antenna Gain (dBi)	Polarization (H/V)
Middle	3760	-48.36	-13	-35.36	-63.02	-56.11	4.85	12.60	H
	5640	-50.82	-13	-37.82	-69.10	-58.34	5.58	13.10	H
	7520	-48.57	-13	-35.57	-70.15	-53.31	6.56	11.30	H
	3760	-50.37	-13	-37.37	-65.46	-58.12	4.85	12.6	V
	5640	-51.04	-13	-38.04	-69.91	-58.56	5.58	13.1	V
	7520	-48.43	-13	-35.43	-70.13	-53.17	6.56	11.3	V

Remark: Spurious emissions within 30-1000MHz were found more than 20dB below limit line.



GSM1900 (EDGE class 8)									
Channel	Frequency (MHz)	EIRP (dBm)	Limit (dBm)	Over Limit (dB)	SPA Reading (dBm)	S.G. Power (dBm)	TX Cable loss (dB)	TX Antenna Gain (dBi)	Polarization (H/V)
Middle	3760	-52.28	-13	-39.28	-66.94	-60.03	4.85	12.60	H
	5640	-51.11	-13	-38.11	-69.39	-58.63	5.58	13.10	H
	7520	-48.25	-13	-35.25	-69.83	-52.99	6.56	11.30	H
	3760	-53.59	-13	-40.59	-68.68	-61.34	4.85	12.6	V
	5640	-50.83	-13	-37.83	-69.7	-58.35	5.58	13.1	V
	7520	-47.87	-13	-34.87	-69.57	-52.61	6.56	11.3	V

Remark: Spurious emissions within 30-1000MHz were found more than 20dB below limit line.

WCDMA Band V(RMC 12.2Kbps)									
Channel	Frequency (MHz)	ERP (dBm)	Limit (dBm)	Over Limit (dB)	SPA Reading (dBm)	S.G. Power (dBm)	TX Cable loss (dB)	TX Antenna Gain (dBi)	Polarization (H/V)
Middle	1672	-53.60	-13	-40.60	-58.34	-58.01	2.84	9.40	H
	2510	-60.35	-13	-47.35	-67.76	-65.10	3.7	10.60	H
	3346	-56.96	-13	-43.96	-67.85	-63.04	4.37	12.60	H
	4180	-52.68	-13	-39.68	-65.37	-58.28	4.85	12.60	H
	1672	-53.48	-13	-40.48	-57.79	-57.89	2.84	9.40	V
	2510	-61.67	-13	-48.67	-68.56	-66.42	3.70	10.60	V
	3346	-57.91	-13	-44.91	-68.13	-63.99	4.37	12.60	V
	4180	-53.79	-13	-40.79	-65.84	-59.39	4.85	12.60	V

Remark: Spurious emissions within 30-1000MHz were found more than 20dB below limit line.

WCDMA Band II(RMC 12.2Kbps)									
Channel	Frequency (MHz)	EIRP (dBm)	Limit (dBm)	Over Limit (dB)	SPA Reading (dBm)	S.G. Power (dBm)	TX Cable loss (dB)	TX Antenna Gain (dBi)	Polarization (H/V)
Middle	3760	-53.42	-13	-40.42	-68.08	-61.17	4.85	12.60	H
	5640	-51.24	-13	-38.24	-69.52	-58.76	5.58	13.10	H
	7520	-48.02	-13	-35.02	-69.60	-52.76	6.56	11.30	H
	3760	-52.72	-13	-39.72	-67.81	-60.47	4.85	12.6	V
	5640	-50.50	-13	-37.50	-69.37	-58.02	5.58	13.1	V
	7520	-48.13	-13	-35.13	-69.83	-52.87	6.56	11.3	V

Remark: Spurious emissions within 30-1000MHz were found more than 20dB below limit line.



Appendix C. Test Setup Photographs