



# TEST REPORT

**No. I18D00141-EMC01**

*For*

**Client : Shanghai Sunmi Technology Co.,Ltd.**

**Production: Handheld Wireless Terminal**

**Model Name : T8900/T8901**

**Hardware Version: 2DD021\_V2.01**

**Software Version: L2\_V2.6\_20180621**

**FCC ID: 2AH25L2**

**Issued date: 2018-09-19**

**Note:**

The test results in this test report relate only to the devices specified in this report. This report shall not be reproduced except in full without the written approval of ECIT Shanghai.

**Test Laboratory:**

ECIT Shanghai, East China Institute of Telecommunications

Add: 7F, G Area, No.668, Beijing East Road, Huangpu District, Shanghai, P. R. China

Tel: (+86)-021-63843300, E-Mail: [welcome@ecit.org.cn](mailto:welcome@ecit.org.cn)

**Revision Version**

Report Number	Revision	Date	Memo
I18D00141-EMC01	00	2018-09-19	Initial creation of test report

## CONTENTS

<b>1. TEST LABORATORY .....</b>	<b>5</b>
<b>1.1. TESTING LOCATION .....</b>	<b>5</b>
<b>1.2. TESTING ENVIRONMENT .....</b>	<b>5</b>
<b>1.3. PROJECT DATA.....</b>	<b>5</b>
<b>1.4. SIGNATURE.....</b>	<b>5</b>
<b>1.5. CLIENT INFORMATION .....</b>	<b>6</b>
<b>1.6. APPLICANT INFORMATION.....</b>	<b>6</b>
<b>1.7. MANUFACTURER INFORMATION.....</b>	<b>6</b>
<b>2. EQUIPMENT UNDER TEST (EUT) AND ANCILLARY EQUIPMENT (AE) .....</b>	<b>7</b>
<b>2.1. ABOUT EUT.....</b>	<b>7</b>
<b>3.2. INTERNAL IDENTIFICATION OF EUT USED DURING THE TEST .....</b>	<b>7</b>
<b>3.3. INTERNAL IDENTIFICATION OF AE USED DURING THE TEST .....</b>	<b>7</b>
<b>4. REFERENCE DOCUMENTS.....</b>	<b>8</b>
<b>4.1 REFERENCE DOCUMENTS FOR TESTING.....</b>	<b>8</b>
<b>5. TEST RESULTS.....</b>	<b>9</b>
<b>5.1 SUMMARY OF TEST RESULTS .....</b>	<b>9</b>
<b>5.2 STATEMENTS.....</b>	<b>9</b>
<b>6. TEST EQUIPMENT UTILIZED .....</b>	<b>10</b>
<b>6.1 RADIATED EMISSION EQUIPMENT LIST .....</b>	<b>10</b>
<b>6.1 AC CONDUCTED EMISSION EQUIPMENT LIST .....</b>	<b>10</b>
<b>7. SYSTEM CONFIGURATION DURING TEST.....</b>	<b>11</b>
<b>7.1 TEST MODE.....</b>	<b>11</b>
<b>7.2 CONNECTION DIAGRAM OF TEST SYSTEM.....</b>	<b>12</b>
<b>8. MEASUREMENT RESULTS.....</b>	<b>13</b>
<b>8.1 RADIATED EMISSION 30MHZ-18GHZ.....</b>	<b>13</b>

**8.2 AC CONDUCTED EMISSION..... 20**

## 1. Test Laboratory

### 1.1. Testing Location

Company Name: ECIT Shanghai, East China Institute of Telecommunications  
Address: 7F, G Area, No. 668, Beijing East Road, Huangpu District, Shanghai,  
P. R. China  
Postal Code: 200001  
Telephone: 86-21-63843300  
Fax: 86-21-63843301  
FCC registration No: 489729

### 1.2. Testing Environment

Normal Temperature: 15-35°C  
Relative Humidity: 30-60%RH

### 1.3. Project data

Project Leader: Yu Anlu  
Testing Start Date: 2018-08-13  
Testing End Date: 2018-09-14

### 1.4. Signature

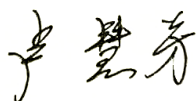

**Lu Huifang**  
(Prepared this test report)



**You Jinjun**  
(Reviewed this test report)

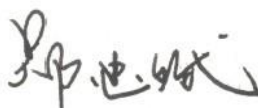

**Zheng Zhongbin**  
Director of the laboratory  
(Approved this test report)

**1.5. Client Information****1.6. Applicant Information**

Company Name: Shanghai Sunmi Technology Co.,Ltd.  
Address : Room 505, KIC Plaza, No.388 Song Hu Road, Yang Pu District,  
Shanghai, China  
Telephone: 18721763396  
Post: 200433

**1.7. Manufacturer Information**

Company Name: Shanghai Sunmi Technology Co.,Ltd.  
Address : Room 505, KIC Plaza, No.388 Song Hu Road, Yang Pu District,  
Shanghai, China  
Telephone: 18721763396  
Post: 200433

## 2. Equipment under Test (EUT) and Ancillary Equipment (AE)

### 2.1. About EUT

EUT Description	Handheld Wireless Terminal
Model name	T8900/T8901
GSM Frequency Band	GSM850/GSM1900/ GSM900/GSM1800
WCDMA Frequency Band	Band II /BandIV/Band V /Band I
CDMA Frequency Band	BC0/BC1
LTE Frequency Band	LTE 2/4/7/17/28
Additional Communication Function	BT4.0,BLE;WIFI 802.11a,b,g,n;

### 3.2. Internal Identification of EUT used during the test

EUT ID*	SN or IMEI	HW Version	SW Version	Date of receipt
N07	868591030045958	2DD021_V2.01	L2_V2.6_20180621	2018.08.13
N04	868591030001035	2DD021_V2.01	L2_V2.6_20180621	2018.08.13

\*EUT ID: is used to identify the test sample in the lab internally.

### 3.3. Internal Identification of AE used during the test

AE ID*	Description	Model	SN
UA04	USB Cable	NA	NA
CA06	Adapter	TPA-10D050200UU01	NA
AE1	Desktop PC	OptiPlex 790 DT	X8RP1 A01 APCC
AE2	Notebook PC	ThinkPad Edge E430	0B65911
AE3	LAN Cable	NA	NA
AE4	VGA Cable	NA	NA
AE5	RS232 Cable	NA	NA
AE6	Keyboard	KB212-B	CN-0Y88XT-65890-12I-005Q-A00
AE7	Mouse	MS111-P	CN-011D3V-71581-19J-1A64
AE8	Adapter	NA	NA
AE9	Earphone	NA	NA
AE10	Monitor	Dell E1709Wc	NA
AE11	SanDisk Ultra32GB	microSDHC UHS-I	NA

\*AE ID: is used to identify the test sample in the lab internally.

## 4. Reference Documents

### 4.1 Reference Documents for testing

The following documents listed in this section are referred for testing.

Reference	Title	Version
FCC Part 15, Subpart B	Radio frequency devices	10-1-10 Edition
ANSI C63.4	Method of Measurement of Radio-Noise Emissions from Low-Voltage Electrical and Electronic Equipment in the Range of 9 kHz to 40 GHz	2014



## 5. Test Results

### 5.1 Summary of Test Results

Items	Test List	Clause in FCC rules	Verdict
1	Radiated Emission	15.109(a)	Pass
2	AC Conducted Emission	15.107(a)	Pass

### 5.2 Statements

The T8900/T8901 supporting GSM/WCDMA/LTE/CDMA/BT/WLAN, manufactured by Shanghai Sunmi Technology Co.,Ltd. is a new product for testing. ECIT only performed test cases which identified with Pass/Fail/ Inc result in section 5.1.

ECIT has verified that the compliance of the tested device specified in section 3 of this test report is successfully evaluated according to the procedure and test methods as defined in type certification requirement listed in section 4 of this test report.

## 6. Test Equipment Utilized

### 6.1 Radiated Emission Equipment list

No.	Name	Type	Series Number	Producer	Cal. Date	Cal. interval
1	Universal Radio Communication	CMU200	123126	R&S	2018-05-11	1 Year
2	Universal Radio Communication	CMW500	104178	R&S	2018-05-11	1 Year
3	Test Receiver	ESU40	100307	R&S	2018-05-11	1 Year
4	Trilog Antenna	VULB9163	VULB9163-515	Schwarzbeck	2017-02-25	3 Year
5	Double Ridged Guide	ETS-3117	00135885	ETS	2017-01-11	3 Year
6	EMI Test Software	EMC32 V9.15	NA	R&S	NA	NA

### 6.1 AC Conducted Emission Equipment list

No.	Name	Type	Series Number	Producer	Cal. Date	Cal. interval
1	Universal Radio	CMU200	123123	R&S	2018-05-11	1 Year
2	Universal Radio Communication	CMW500	104178	R&S	2018-05-11	1 Year
3	Test Receiver	ESCI	101235	R&S	2018-05-11	1 Year
4	2-Line V-Network	ENV216	101380	R&S	2018-05-11	1 Year
5	EMI Test Software	EMC32 V9.12	NA	R&S	NA	NA

## 7. System Configuration during Test

### 7.1 Test Mode

Test Item	Function Type
AC Conducted Emission	Mode 1: Full System Mode(N07) <Figure 1> Mode 2: Adapter charging(N07) <Figure 2>
AC Conducted Emission	Mode 1: Full System Mode(N04) <Figure 1> Mode 2: Adapter charging(N04) <Figure 2>
Radiated Emission	Mode 1: Full System Mode(N07) <Figure 1> Mode 2: Adapter charging (N07)<Figure 2>
Radiated Emission	Mode 1: Full System Mode(N04) <Figure 1> Mode 2: Adapter charging (N04)<Figure 2>
Remark: 1.All test modes are performed, only the worst cases test data are recorded in this report. 2.Full System Mode means Data Link with PC, Print Mode and Ping with PC. 3.Data Link with PC means data application transferred mode between EUT and PC.	

### 7.2 Connection Diagram of Test System

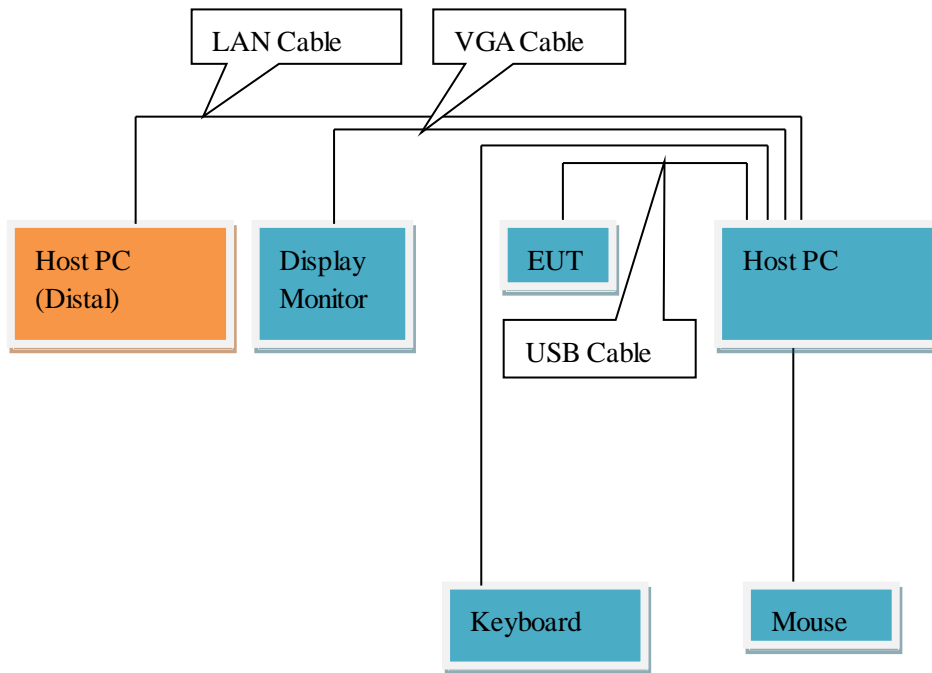

<Figure 1>

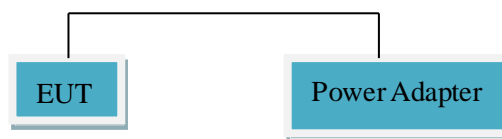

<Figure 2>

## 8. Measurement Results

Only the worst test result was shown in this report.

### 8.1 Radiated Emission 30MHz-18GHz

#### Method of Measurement

For 30-1000MHz, the EUT was placed on the top of a rotating 0.8m table above the ground at a semi-anechoic chamber. The distance between the EUT and the received antenna was 3 meters. The table was rotated 360 degree and the received antenna mounted on a variable-height antenna tower was varied from 1m to 4m to find the maximum value of the field strength. Both horizontal and vertical polarizations of the antenna were set during the measurement. Tested in accordance with the procedures of ANSI C63.4-2014, section 8.3.

For 1000-18000MHz, The maximal emission value was acquired by adjusting the antenna height, The table was rotated 360 degree to determine the maximum value of the field strength. Both horizontal and vertical polarizations of the antenna were set during the measurement.

#### Limits for Radiated Emission at a measuring distance of 3m

Frequency Range (MHz)	Quasi-Peak (dBuV/m)
30-88	40
88-216	43.5
216-960	46
Above 960	54

Frequency Range (MHz)	Peak (dBuV/m)	Average (dBuV/m)
Above 1000	74	54

#### Test conditions

Frequency Range (MHz)	RBW/VBW	Sweep Time (s)
30-1000	120KHz/300KHz	Auto
1000-18000	1MHz/3MHz	Auto

#### Uncertainty Measurement

The measurement uncertainty(30MHz-1000MHz) is 4.98 dB (k=2).

The measurement uncertainty(1000MHz-18000MHz) is 5.06 dB (k=2).

## Test Results

Mode 1: Full System mode with PC (N07)

Frequency Range: 30MHz – 1GHz

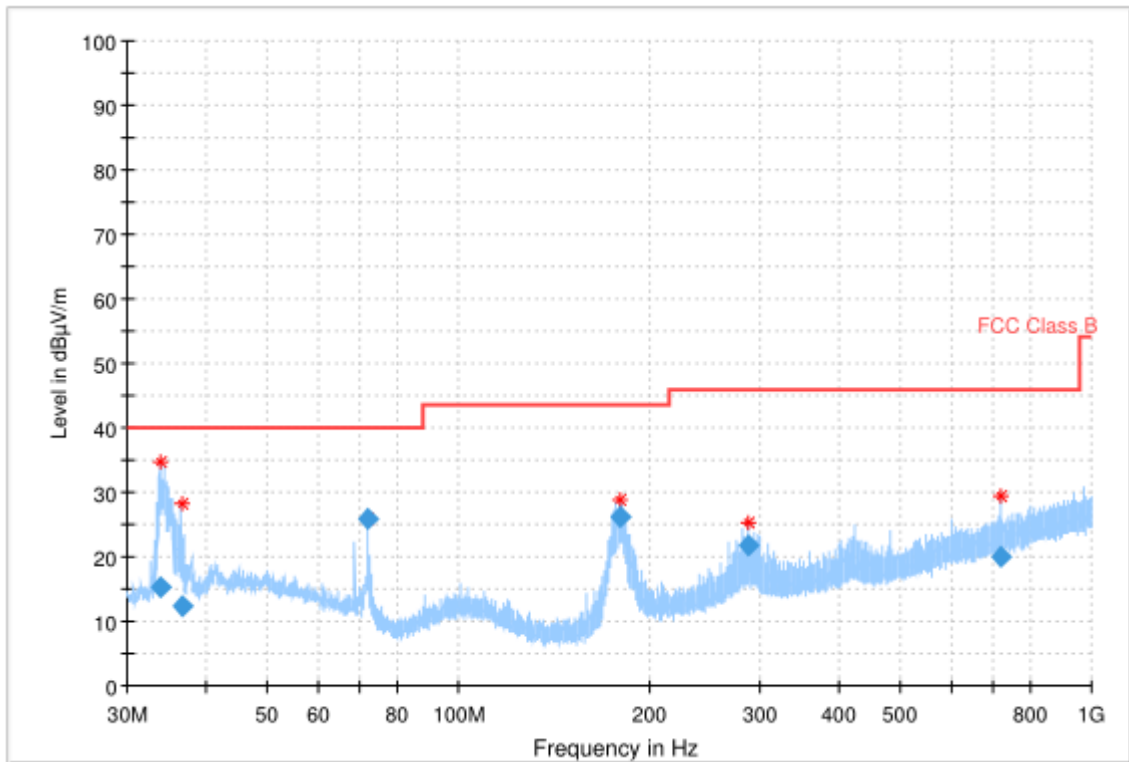

Frequency (MHz)	QuasiPeak (dBµV/m)	Limit (dBµV/m)	Margin (dB)	Meas. Time (ms)	Bandwidth (kHz)	Height (cm)	Pol	Azimuth (deg)	Corr. (dB)
33.967997	15.41	40.00	24.59	1000.0	120.000	100.0	V	34.0	-22.0
36.651005	12.24	40.00	27.76	1000.0	120.000	99.0	V	105.0	-21.6
72.005992	26.01	40.00	13.99	1000.0	120.000	222.0	H	161.0	-25.5
179.930893	26.18	43.50	17.32	1000.0	120.000	124.0	H	98.0	-25.8
287.552901	21.74	46.00	24.26	1000.0	120.000	125.0	H	84.0	-22.3
719.982211	19.95	46.00	26.05	1000.0	120.000	222.0	H	45.0	-12.7

Note:

1. Emission level(QP)=Raw value by receiver + Corr(Antenna factor + cable loss - preamplifier gain)
2. The raw value is used to calculate by software which is not shown in the sheet.
3. Margin=limit value – emission level.

Mode 2: Adapter charging(N07)

Frequency Range:

1GHz –18GHz

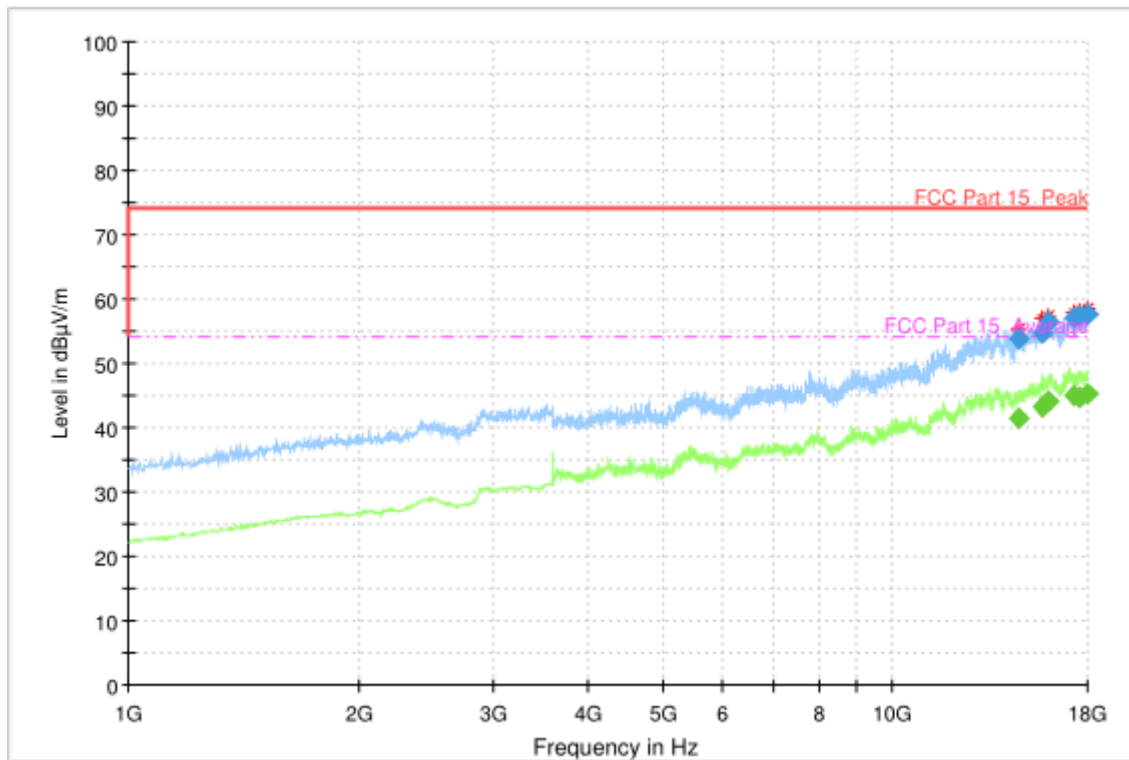

## Final Result

Frequency (MHz)	MaxPeak (dBuV/m)	Average (dBuV/m)	Limit (dBuV/m)	Margin (dB)	Meas. Time	Bandwidth (kHz)	Height (cm)	Pol	Azimuth (deg)
14616.600000	53.97	---	74.00	20.03	100.0	1000.000	100.0	H	335.0
14616.600000	---	41.55	54.00	12.45	100.0	1000.000	100.0	H	335.0
15714.200000	54.77	---	74.00	19.23	100.0	1000.000	100.0	H	113.0
15714.200000	---	43.12	54.00	10.88	100.0	1000.000	100.0	H	113.0
16024.200000	56.55	---	74.00	17.45	100.0	1000.000	100.0	H	312.0
16024.200000	---	44.03	54.00	9.97	100.0	1000.000	100.0	H	312.0
17229.000000	57.15	---	74.00	16.85	100.0	1000.000	200.0	H	0.0
17229.000000	---	44.92	54.00	9.08	100.0	1000.000	200.0	H	0.0
17574.600000	57.26	---	74.00	16.74	100.0	1000.000	100.0	H	54.0
17574.600000	---	44.83	54.00	9.17	100.0	1000.000	100.0	H	54.0
17990.000000	57.78	---	74.00	16.22	100.0	1000.000	100.0	H	0.0
17990.000000	---	45.22	54.00	8.78	100.0	1000.000	100.0	H	0.0

Note:

- 1.Emission level(peak or average)=Raw value by receiver + Corr(Antenna factor+ cable loss - preamplifier gain)
- 2.The raw value is used to calculate by software which is not shown in the sheet.
- 3.Margin=limit value – emission level.

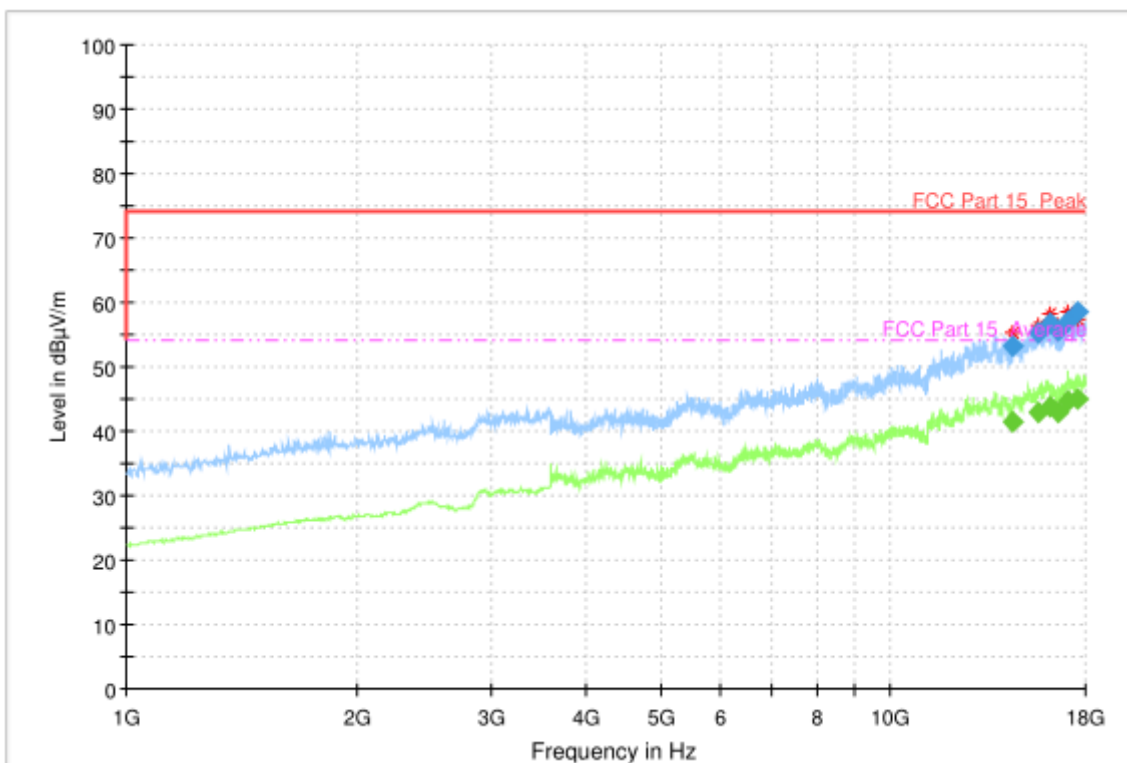

## Final Result

Frequency (MHz)	MaxPeak (dBuV/m)	Average (dBuV/m)	Limit (dBuV/m)	Margin (dB)	Meas. Time	Bandwidth (kHz)	Height (cm)	PoI	Azimuth (deg)
14486.800000	53.11	---	74.00	20.89	100.0	1000.000	100.0	V	144.0
14486.800000	---	41.60	54.00	12.40	100.0	1000.000	100.0	V	144.0
15647.600000	55.41	---	74.00	18.59	100.0	1000.000	100.0	V	32.0
15647.600000	---	42.89	54.00	11.11	100.0	1000.000	100.0	V	32.0
16133.000000	56.90	---	74.00	17.10	100.0	1000.000	200.0	V	0.0
16133.000000	---	43.84	54.00	10.16	100.0	1000.000	200.0	V	0.0
16606.600000	55.72	---	74.00	18.28	100.0	1000.000	100.0	V	0.0
16606.600000	---	42.86	54.00	11.14	100.0	1000.000	100.0	V	0.0
17034.400000	---	44.70	54.00	9.30	100.0	1000.000	200.0	V	325.0
17034.400000	57.11	---	74.00	16.89	100.0	1000.000	200.0	V	325.0
17622.600000	---	45.03	54.00	8.97	100.0	1000.000	100.0	V	359.0
17622.600000	58.47	---	74.00	15.53	100.0	1000.000	100.0	V	359.0

Note:

- 1.Emission level(peak or average)=Raw value by receiver + Corr(Antenna factor+ cable loss - preamplifier gain)
- 2.The raw value is used to calculate by software which is not shown in the sheet.
- 3.Margin=limit value – emission level.



Mode 1: Full System mode with PC (N04)

Frequency Range:

30MHz – 1GHz

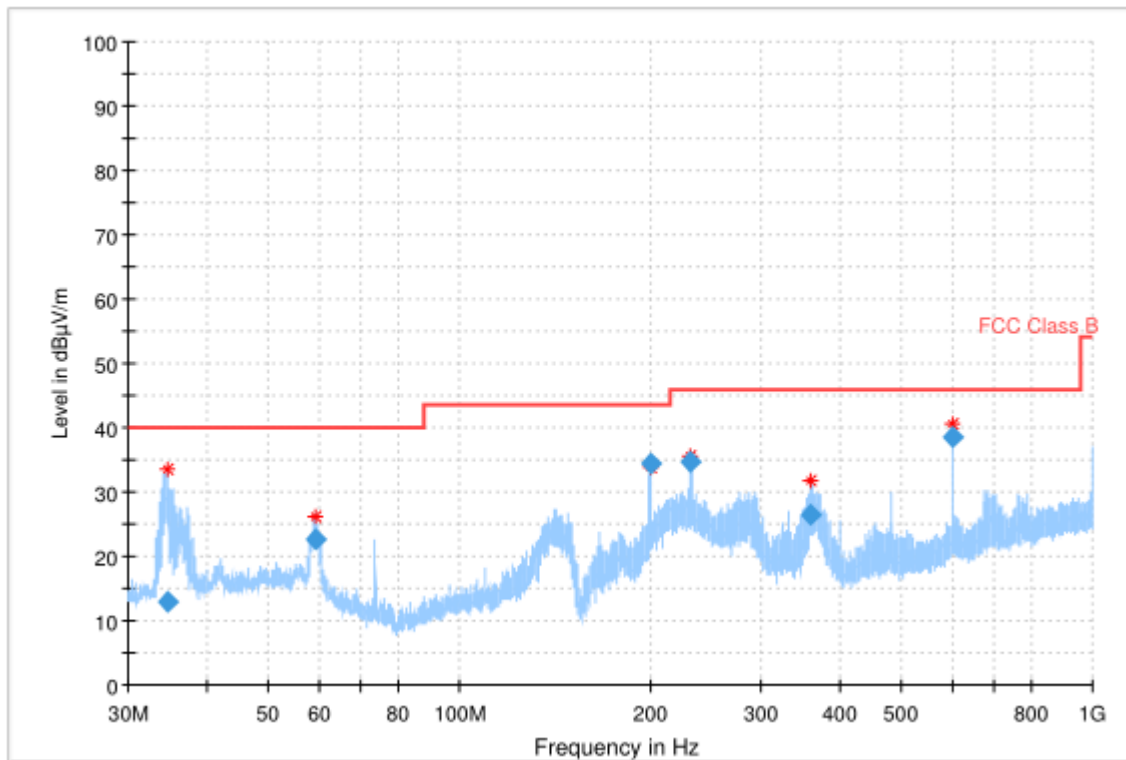

Frequency (MHz)	QuasiPeak (dBµV/m)	Limit (dBµV/m)	Margin (dB)	Meas. Time (ms)	Bandwidth (kHz)	Height (cm)	PoI	Azimuth (deg)	Corr. (dB)
34.566128	13.07	40.00	26.93	1000.0	120.000	100.0	V	118.0	-22.0
59.191376	22.55	40.00	17.45	1000.0	120.000	106.0	V	142.0	-22.1
200.004243	34.43	43.50	9.07	1000.0	120.000	125.0	H	76.0	-24.5
232.380144	34.80	46.00	11.20	1000.0	120.000	106.0	H	-27.0	-23.6
358.397949	26.47	46.00	19.53	1000.0	120.000	125.0	H	32.0	-20.6
600.011856	38.52	46.00	7.48	1000.0	120.000	125.0	H	123.0	-14.7

Note:

1. Emission level(QP)=Raw value by receiver + Corr(Antenna factor + cable loss - preamplifier gain)
2. The raw value is used to calculate by software which is not shown in the sheet.
3. Margin=limit value – emission level.

Mode 2: Adapter charging(N04)

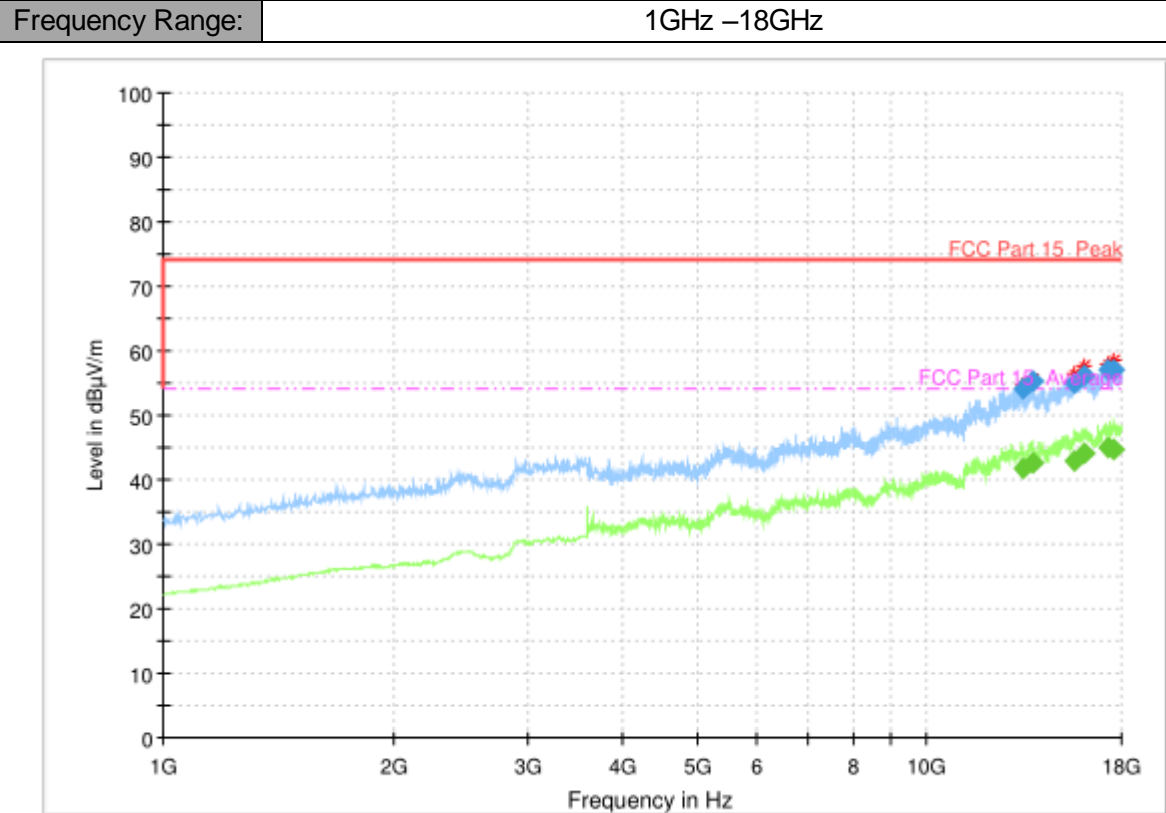

## Final Result

Frequency (MHz)	MaxPeak (dBuV/m)	Average (dBuV/m)	Limit (dBuV/m)	Margin (dB)	Meas. Time	Bandwidth (kHz)	Height (cm)	PoI	Azimuth (deg)
13353.000000	---	41.86	54.00	12.14	100.0	1000.000	100.0	H	0.0
13353.000000	54.12	---	74.00	19.88	100.0	1000.000	100.0	H	0.0
13757.200000	---	42.52	54.00	11.48	100.0	1000.000	100.0	H	351.0
13757.200000	55.42	---	74.00	18.58	100.0	1000.000	100.0	H	351.0
15642.800000	55.14	---	74.00	18.86	100.0	1000.000	100.0	H	0.0
15642.800000	---	42.86	54.00	11.14	100.0	1000.000	100.0	H	0.0
16034.600000	---	44.18	54.00	9.82	100.0	1000.000	100.0	H	0.0
16034.600000	56.19	---	74.00	17.81	100.0	1000.000	100.0	H	0.0
17221.200000	---	45.13	54.00	8.87	100.0	1000.000	100.0	H	315.0
17221.200000	56.99	---	74.00	17.01	100.0	1000.000	100.0	H	315.0
17594.400000	56.99	---	74.00	17.01	100.0	1000.000	100.0	H	156.0
17594.400000	---	44.79	54.00	9.21	100.0	1000.000	100.0	H	156.0

Note:

- 1.Emission level(peak or average)=Raw value by receiver + Corr(Antenna factor+ cable loss - preamplifier gain)
- 2.The raw value is used to calculate by software which is not shown in the sheet.
- 3.Margin=limit value – emission level.

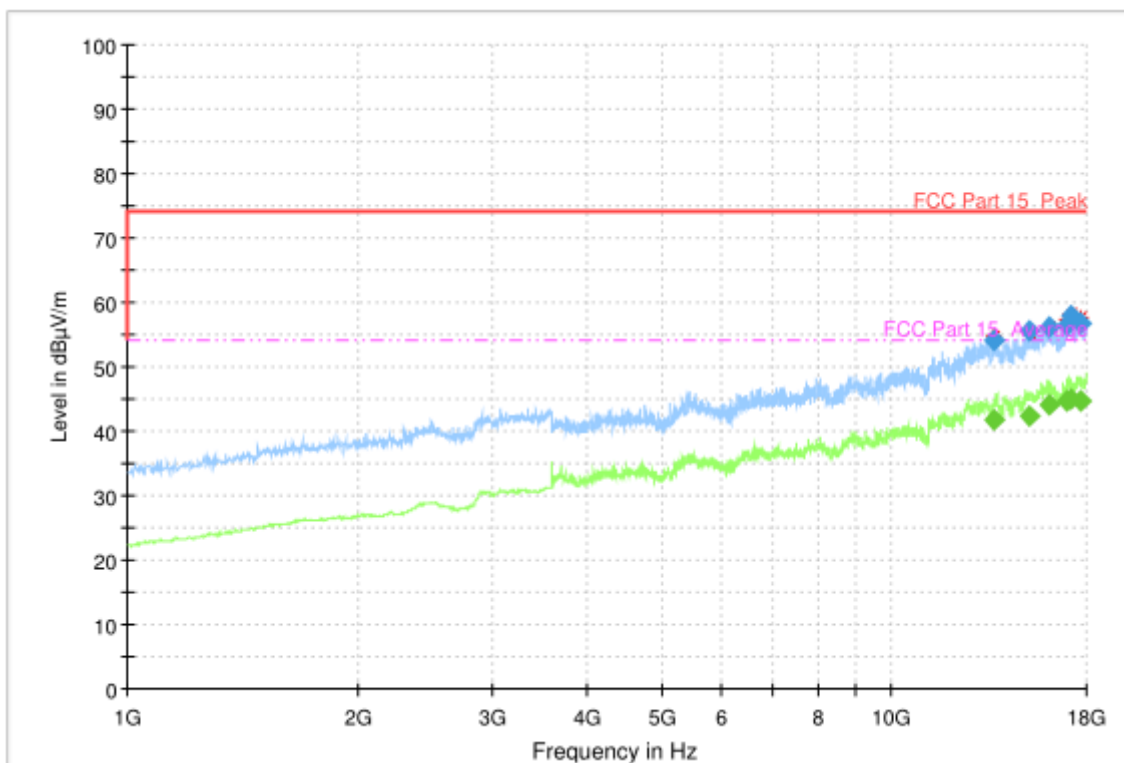

## Final Result

Frequency (MHz)	MaxPeak (dBuV/m)	Average (dBuV/m)	Limit (dBuV/m)	Margin (dB)	Meas. Time	Bandwidth (kHz)	Height (cm)	PoI	Azimuth (deg)
13603.600000	---	41.62	54.00	12.38	100.0	1000.000	100.0	V	87.0
13603.600000	54.03	---	74.00	19.97	100.0	1000.000	100.0	V	87.0
15164.600000	---	42.38	54.00	11.62	100.0	1000.000	100.0	V	176.0
15164.600000	55.54	---	74.00	18.46	100.0	1000.000	100.0	V	176.0
16066.400000	56.09	---	74.00	17.91	100.0	1000.000	100.0	V	267.0
16066.400000	---	44.17	54.00	9.83	100.0	1000.000	100.0	V	267.0
16953.800000	56.59	---	74.00	17.41	100.0	1000.000	100.0	V	232.0
16953.800000	---	44.58	54.00	9.42	100.0	1000.000	100.0	V	232.0
17185.000000	---	45.13	54.00	8.87	100.0	1000.000	100.0	V	278.0
17185.000000	57.92	---	74.00	16.08	100.0	1000.000	100.0	V	278.0
17715.400000	---	44.78	54.00	9.22	100.0	1000.000	200.0	V	302.0
17715.400000	56.87	---	74.00	17.13	100.0	1000.000	200.0	V	302.0

**Note:**

- 1.Emission level(peak or average)=Raw value by receiver + Corr(Antenna factor+ cable loss - preamplifier gain)
- 2.The raw value is used to calculate by software which is not shown in the sheet.
- 3.Margin=limit value – emission level.

## 8.2 AC Conducted Emission

### Method of Measurement

For equipment that is designed to be connected to the public utility (AC) power line, the radio frequency voltage that is conducted back onto the AC power line on any frequency or frequencies with the band 150 kHz to 30MHz shall not exceed the limits. Both lines of the power mains connected to the EUT were checked for maximum conducted interference. Tested in accordance with the procedures of ANSI C63.4-2014, section 7.3

### Limit of Conducted Emission

Frequency Range (MHz)	Conducted Limit (dBuV)	
	Quasi-peak	Average
0.15-0.5	66 to 56*	56 to 46*
0.5-5	56	46
5-30	60	50

\*Decreases with the logarithm of the frequency

### Test Condition in Charging Mode

Voltage (V)	Frequency (Hz)	RBW	Sweep Time (s)
120	60	9 KHz	Auto

### Uncertainty Measurement

The measurement uncertainty is 3.66dB (k=2).

### Test Results

Mode 1: Adapter charging(N07)

Frequency Range:

150kHz – 30MHz

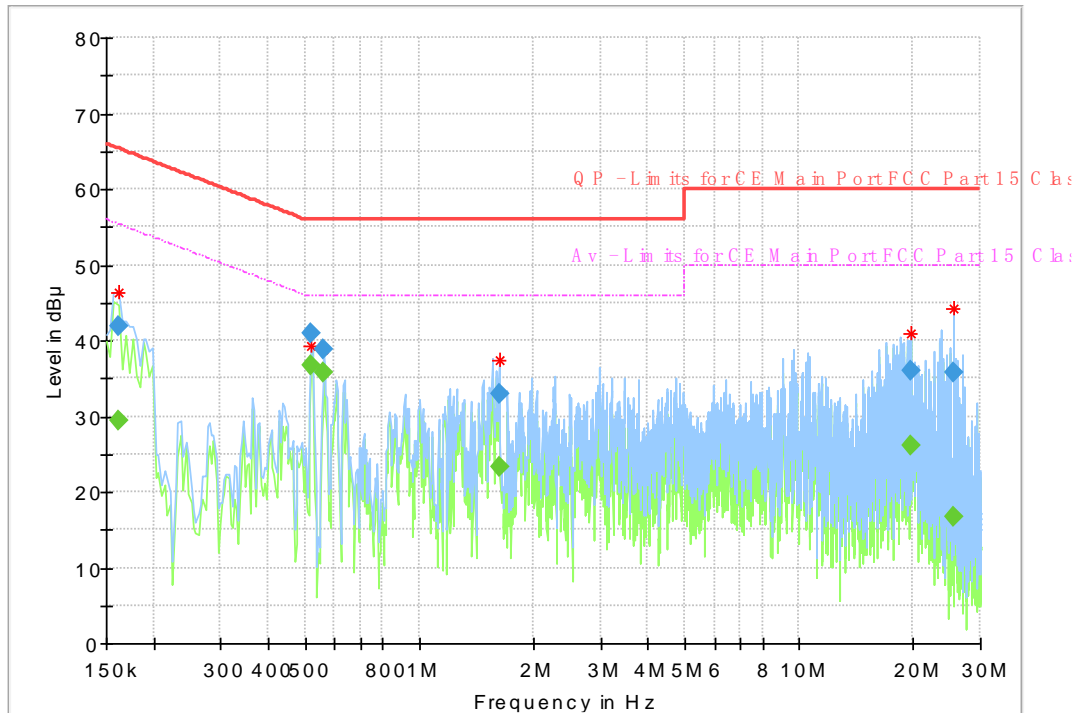

Frequency (MHz)	QuasiPeak (dBμ V)	Average (dBμ V)	Limit (dBμ V)	Margin (dB)	Meas. Time	Bandwidth (kHz)	Line	Filter	Corr. (dB)
0.161194	---	29.30	55.40	26.10	1000.0	9.000	N	ON	9.7
0.161194	41.79	---	65.40	23.61	1000.0	9.000	N	ON	9.7
0.519394	---	36.62	46.00	9.38	1000.0	9.000	N	ON	9.7
0.519394	41.03	---	56.00	14.97	1000.0	9.000	N	ON	9.7
0.560438	38.91	---	56.00	17.09	1000.0	9.000	N	ON	9.7
0.560438	---	35.80	46.00	10.20	1000.0	9.000	N	ON	9.7
1.620112	---	23.18	46.00	22.82	1000.0	9.000	L1	ON	9.7
1.620112	33.03	---	56.00	22.97	1000.0	9.000	L1	ON	9.7
19.597275	---	26.22	50.00	23.78	1000.0	9.000	L1	ON	9.9
19.597275	35.92	---	60.00	24.08	1000.0	9.000	L1	ON	9.9
25.391906	35.86	---	60.00	24.14	1000.0	9.000	L1	ON	9.9
25.391906	---	16.63	50.00	33.37	1000.0	9.000	L1	ON	9.9

Note:

1. Emission level (quasi-peak or Average peak) = Raw value by receiver + Corr (Insertion loss + cable loss)
2. The raw value is used to calculate by software which is not shown in the sheet.
3. Margin = limit value – emission level.
4. L1 and N line is all have been tested, the result of them is synthesized in the above data diagram.

Mode 1: Adapter charging(N04)

Frequency Range:

150kHz – 30MHz

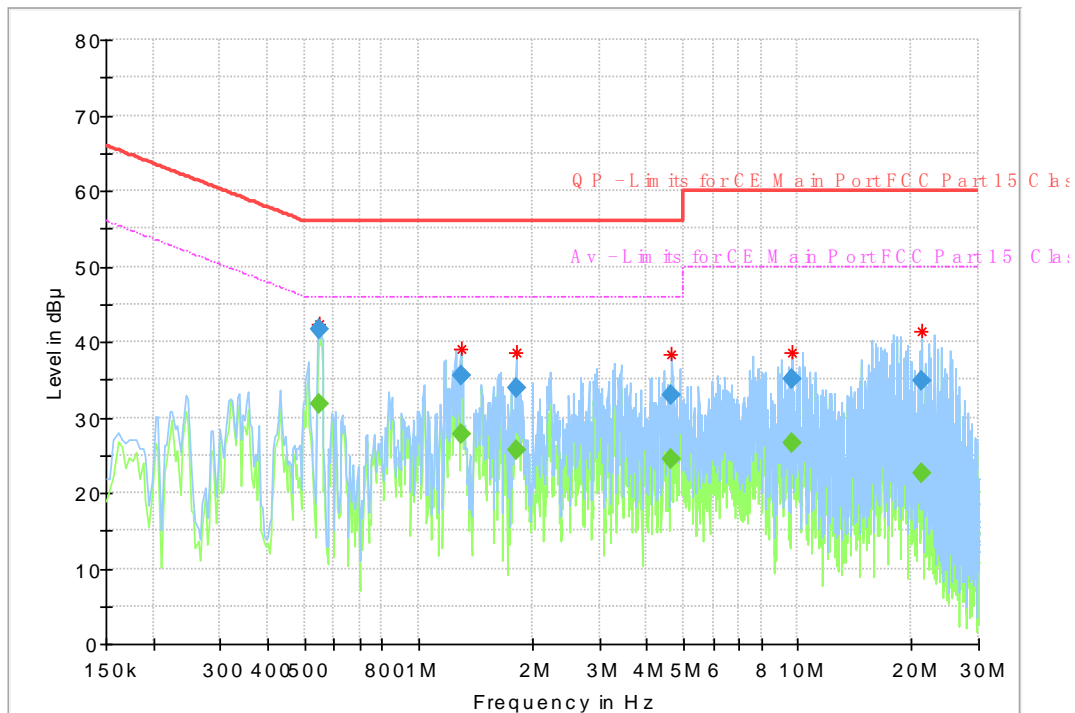

Frequency (MHz)	QuasiPeak (dB μV)	Average (dB μV)	Limit (dB μV)	Margin (dB)	Meas. Time	Bandwidth (kHz)	Line	Filter	Corr. (dB)
0.545512	---	31.85	46.00	14.15	1000.0	9.000	L1	ON	9.7
0.545512	41.68	---	56.00	14.32	1000.0	9.000	L1	ON	9.7
1.291762	---	27.74	46.00	18.26	1000.0	9.000	L1	ON	9.7
1.291762	35.43	---	56.00	20.57	1000.0	9.000	L1	ON	9.7
1.810406	---	25.64	46.00	20.36	1000.0	9.000	L1	ON	9.7
1.810406	34.00	---	56.00	22.00	1000.0	9.000	L1	ON	9.7
4.661081	---	24.46	46.00	21.54	1000.0	9.000	L1	ON	9.8
4.661081	32.92	---	56.00	23.08	1000.0	9.000	L1	ON	9.8
9.694538	---	26.48	50.00	23.52	1000.0	9.000	L1	ON	9.8
9.694538	35.02	---	60.00	24.98	1000.0	9.000	L1	ON	9.8
21.280069	---	22.60	50.00	27.40	1000.0	9.000	L1	ON	9.9
21.280069	34.73	---	60.00	25.27	1000.0	9.000	L1	ON	9.9

Note:

1. Emission level (quasi-peak or Average peak) = Raw value by receiver + Corr (Insertion loss + cable loss)
2. The raw value is used to calculate by software which is not shown in the sheet.
3. Margin = limit value – emission level.
4. L1 and N line is all have been tested, the result of them is synthesized in the above data diagram.

\*\*\*\*\*END OF REPORT\*\*\*\*\*