



**中认信通**  
CHINA CERTIFICATION ICT CO., LTD (DONGGUAN)



## TEST REPORT

**Applicant: Shanghai Sunmi Technology Co.,Ltd.**

Address: Room 505, KIC Plaza, No.388 Song Hu Road, Yang Pu District, Shanghai,  
China

**FCC ID: 2AH25D2SKT**

**Product Name: POS System**

**Model Number: L1583, L1553, L3553, L1581, L1582**

**Standard(s): 47 CFR Part 15, Subpart C(15.247)**  
**ANSI C63.10-2013**  
**KDB 558074 D01 15.247 Meas Guidance v05r02**

The above equipment has been tested and found compliance with the requirement of the relative standards by China Certification ICT Co., Ltd (Dongguan)

**Report Number: CR22010036-00A**

**Date Of Issue: 2022-05-26**

**Reviewed By: Sun Zhong**

*Sun Zhong*

Title: Manager

**Test Laboratory: China Certification ICT Co., Ltd (Dongguan)**

No. 113, Pingkang Road, Dalang Town, Dongguan,  
Guangdong, China  
Tel: +86-769-82016888

**Test Facility**

The Test site used by China Certification ICT Co., Ltd (Dongguan) to collect test data is located on the No. 113, Pingkang Road, Dalang Town, Dongguan, Guangdong, China.

The lab has been recognized as the FCC accredited lab under the KDB 974614 D01 and is listed in the FCC Public Access Link (PAL) database, FCC Registration No. : 442868, the FCC Designation No. : CN1314.

The lab has been recognized by Innovation, Science and Economic Development Canada to test to Canadian radio equipment requirements, the CAB identifier: CN0123.

**Declarations**

China Certification ICT Co., Ltd (Dongguan) is not responsible for the authenticity of any test data provided by the applicant. Data included from the applicant that may affect test results are marked with a triangle symbol “▲”. Customer model name, addresses, names, trademarks etc. are not considered data.

Unless otherwise stated the results shown in this test report refer only to the sample(s) tested.

This report cannot be reproduced except in full, without prior written approval of the Company.

This report is valid only with a valid digital signature. The digital signature may be available only under the Adobe software above version 7.0.

This report may contain data that are not covered by the accreditation scope and shall be marked with an asterisk “★”.

## CONTENTS

<b>TEST FACILITY .....</b>	<b>2</b>
<b>DECLARATIONS.....</b>	<b>2</b>
<b>1. GENERAL INFORMATION .....</b>	<b>5</b>
<b>1.1 PRODUCT DESCRIPTION FOR EQUIPMENT UNDER TEST (EUT) .....</b>	<b>5</b>
<b>1.2 DESCRIPTION OF TEST CONFIGURATION.....</b>	<b>7</b>
1.2.2 Support Equipment List and Details .....	8
1.2.3 Support Cable List and Details .....	8
1.2.4 Block Diagram of Test Setup.....	9
<b>1.3 MEASUREMENT UNCERTAINTY .....</b>	<b>11</b>
<b>2. SUMMARY OF TEST RESULTS .....</b>	<b>12</b>
<b>3. REQUIREMENTS AND TEST PROCEDURES .....</b>	<b>13</b>
<b>3.1 AC LINE CONDUCTED EMISSIONS.....</b>	<b>13</b>
3.1.1 Applicable Standard.....	13
3.1.2 EUT Setup.....	14
3.1.3 EMI Test Receiver Setup .....	14
3.1.4 Test Procedure .....	15
3.1.5 Corrected Amplitude & Margin Calculation.....	15
<b>3.2 RADIATION SPURIOUS EMISSIONS.....</b>	<b>16</b>
3.2.1 Applicable Standard.....	16
3.2.2 EUT Setup.....	16
3.2.3 EMI Test Receiver & Spectrum Analyzer Setup .....	17
3.2.4 Test Procedure .....	17
3.2.5 Corrected Amplitude & Margin Calculation.....	17
<b>3.3 6 DB EMISSION BANDWIDTH:.....</b>	<b>18</b>
3.3.1 Applicable Standard.....	18
3.3.2 EUT Setup.....	18
3.3.3 Test Procedure .....	18
<b>3.4 MAXIMUM PEAK CONDUCTED OUTPUT POWER:.....</b>	<b>19</b>
3.4.1 Applicable Standard.....	19
3.4.2 EUT Setup.....	19
3.4.3 Test Procedure .....	19
<b>3.5 MAXIMUM POWER SPECTRAL DENSITY: .....</b>	<b>20</b>
3.5.1 Applicable Standard.....	20
3.5.2 EUT Setup.....	20
3.5.3 Test Procedure .....	20
<b>3.6 100 KHZ BANDWIDTH OF FREQUENCY BAND EDGE: .....</b>	<b>21</b>
3.6.1 Applicable Standard.....	21
3.6.2 EUT Setup.....	21
3.6.3 Test Procedure .....	21
<b>3.7 DUTY CYCLE:.....</b>	<b>22</b>
3.7.1 EUT Setup.....	22

---

3.7.2 Test Procedure .....	22
<b>3.8 ANTENNA REQUIREMENT .....</b>	<b>22</b>
3.8.1 Applicable Standard .....	22
3.8.2 Judgment .....	22
<b>4. Test DATA AND RESULTS .....</b>	<b>23</b>
<b>4.1 AC LINE CONDUCTED EMISSIONS .....</b>	<b>23</b>
<b>4.2 RADIATION SPURIOUS EMISSIONS .....</b>	<b>26</b>
<b>4.3 6 dB EMISSION BANDWIDTH: .....</b>	<b>35</b>
<b>4.4 MAXIMUM CONDUCTED OUTPUT POWER: .....</b>	<b>40</b>
<b>4.5 MAXIMUM POWER SPECTRAL DENSITY: .....</b>	<b>41</b>
<b>4.6 100 kHz BANDWIDTH OF FREQUENCY BAND EDGE: .....</b>	<b>46</b>
<b>4.7 DUTY CYCLE: .....</b>	<b>51</b>
<b>5. RF EXPOSURE EVALUATION .....</b>	<b>54</b>
<b>5.1 MAXIMUM PERMISSIBLE EXPOSURE (MPE) .....</b>	<b>54</b>
5.1.1 APPLICABLE STANDARD .....	54
5.1.2 PROCEDURE .....	54
5.1.3 CALCULATED RESULT .....	54

## 1. GENERAL INFORMATION

### 1.1 Product Description for Equipment under Test (EUT)

<b>EUT Name:</b>	POS System
<b>EUT Models:</b>	L1583
<b>Multipel Model:</b>	L1553, L3553, L1581, L1582
<b>Operation Frequency:</b>	2412-2462 MHz(802.11b/g/n ht20) 2402-2480MHz(BLE)
<b>Maximum Peak Output Power (Conducted):</b>	21.91dBm(802.11b/g/n) 7.23 dBm(BLE)
<b>Modulation Type:</b>	DSSS, OFDM(802.11b/g/n) GFSK(BLE)
<b>Rated Input Voltage:</b>	DC 24V from Adapter
<b>Serial Number:</b>	CR22010036-RF-S1(L1583 Type-1)
<b>EUT Received Date:</b>	2022.2.7
<b>EUT Received Status:</b>	Good

Note: The multiple models are electrically identical with Test model, please refer to the declaration letter for more detail, which was provided by manufacturer. The L1583 model was reported for AC line conducted emissions and Radiation test, since L1583 model were proved to be compliance with 15.209 emission requirements in BT report CR22010036-00B, and the worst is L1583 model.

### Operation Frequency Detail:

#### For 802.11b/g/n ht20:

Channel	Frequency (MHz)	Channel	Frequency (MHz)
1	2412	7	2442
2	2417	8	2447
3	2422	9	2452
4	2427	10	2457
5	2432	11	2462
6	2437	/	/

Per section 15.31(m), the lowest frequency, middle frequency, and highest frequency were performed the test as below:

Test Channel	Frequency (MHz)
Lowest	2412
Middle	2437
Highest	2462

**For BLE:**

Channel	Frequency (MHz)	Channel	Frequency (MHz)
0	2402	20	2442
1	2404	...	...
...	...	...	...
...	...	...	...
..	...	38	2478
19	2440	39	2480

Per section 15.31(m), the lowest frequency, middle frequency, and highest frequency were performed the test as below:

Test Channel	Frequency (MHz)
Lowest	2402
Middle	2440
Highest	2480

**Antenna Information Detail ▲ :**

Antenna Manufacturer	Antenna Type	input impedance (Ohm)	Antenna Gain /Frequency Range	§15.203 Requirement
Shanghai Sunmi Technology Co.,Ltd.	FPC	50	1.86dBi/2.4~2.5GHz	Compliance
The Method of §15.203 Compliance: <input checked="" type="checkbox"/> Antenna must be permanently attached to the unit. <input type="checkbox"/> Antenna must use a unique type of connector to attach to the EUT. <input type="checkbox"/> Unit must be professionally installed, and installer shall be responsible for verifying that the correct antenna is employed with the unit.				

**Accessory Information:**

Accessory Description	Manufacturer	Model	Parameters
L3553 Adapter	jiangsu Chenyang Electron Co.,Ltd.	CYZS36-240150	Input: 100-240V~50/60Hz 1.5A Output: DC 24V 1.5A 36W
L1553&L1583 Adapter	jiangsu Chenyang Electron Co.,Ltd.	CYSE65-240250	Input: 100-240V~50/60Hz 1.7A Output: DC 24V 2.5A 60W

## 1.2 Description of Test Configuration

### 1.2.1 EUT Operation Condition:

#### For 802.11b/g/n:

<b>EUT Operation Mode:</b>	The system was configured for testing in Engineering Mode, which was provided by the manufacturer.			
<b>Equipment Modifications:</b>	No			
<b>EUT Exercise Software:</b>	test command			
The software " test command "was provided by manufacturer. The maximum power was configured as below, that was provided by the manufacturer▲:				
Test Modes	Data Rate	Power Level Setting		
		Lowest Channel	Middle Channel	Highest Channel
802.11b	1Mbps	Default	Default	Default
802.11g	6Mbps	Default	Default	Default
802.11n ht20	MCS0	Default	Default	Default
The above are the worst-case data rates, which are determined for each mode based upon investigations by measuring the average power and PSD across all data rates, bandwidths, and modulations.				

#### For BLE:

<b>EUT Operation Mode:</b>	The system was configured for testing in Engineering Mode, which was provided by the manufacturer.		
<b>Equipment Modifications:</b>	No		
<b>EUT Exercise Software:</b>	test command		
The software " test command "was provided by manufacturer. The maximum power was configured as below, that was provided by the manufacturer▲:			
Test Modes	Power Level Setting		
	Lowest Channel	Middle Channel	Highest Channel
1Mbps	Default	Default	Default

**1.2.2 Support Equipment List and Details**

Manufacturer	Description	Model	Serial Number
SanDisk	USB Disk	16 GB	BL201026210Z
SanDisk	TF Card	16 GB	1183DRECV11N
PHILIPS	Keyboard	SPT6234	K234210510746
PHILIPS	Mouse	SPT6234	C234210506222
Kingston	USB Disk	DTI/2GB	CH 031308
TOTO LINK	Router	X5000R	X5000RK9T0560
Unknown	Load	Unknown	L01
Unknown	Load	Unknown	L02
Unknown	Earphone	Unknown	Ear01

**1.2.3 Support Cable List and Details**

Cable Description	Shielding Type	Ferrite Core	Length (m)	From Port	To
Keyboard Cable	No	No	1.2	Keyboard	USB Port of EUT
Earphone Cable	No	No	0.8	EUT	Earphone
Mouse Cable	No	No	1	USB port of EUT	Mouse
RJ45 Cable	No	No	3	EUT	Router
RJ11 Cable	No	No	3	EUT	Load
Cable	No	No	3	EUT	load



### 1.2.4 Block Diagram of Test Setup

AC line conducted emissions:

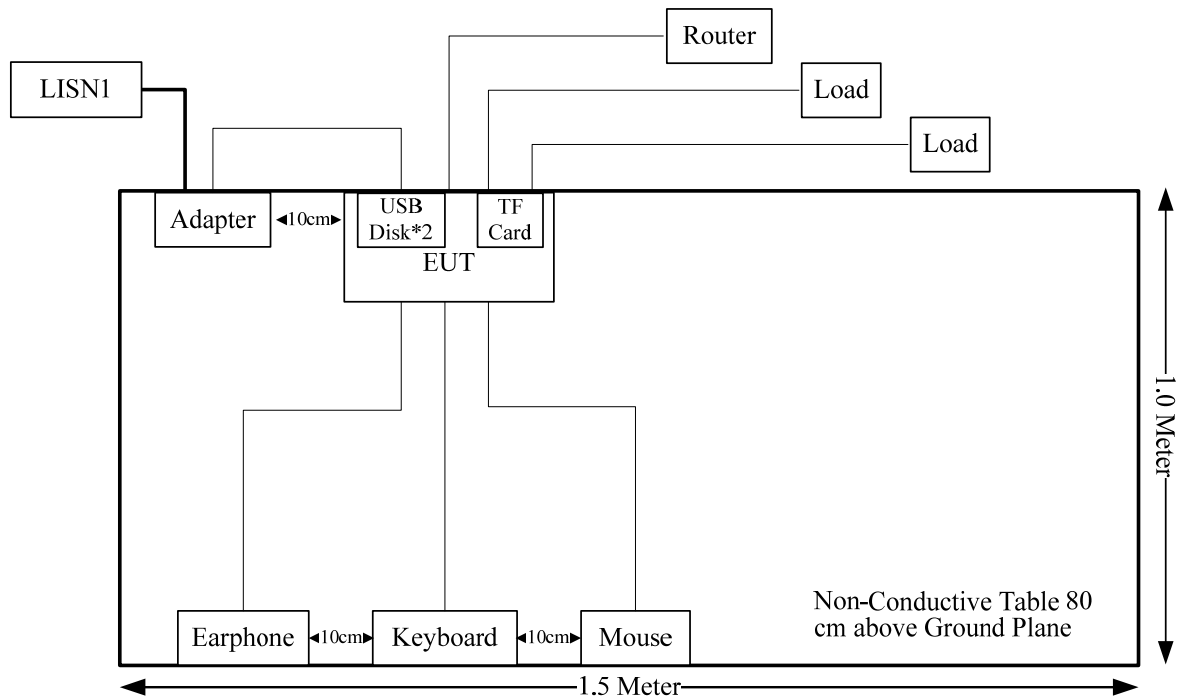

Spurious emissions:  
Below 1GHz:

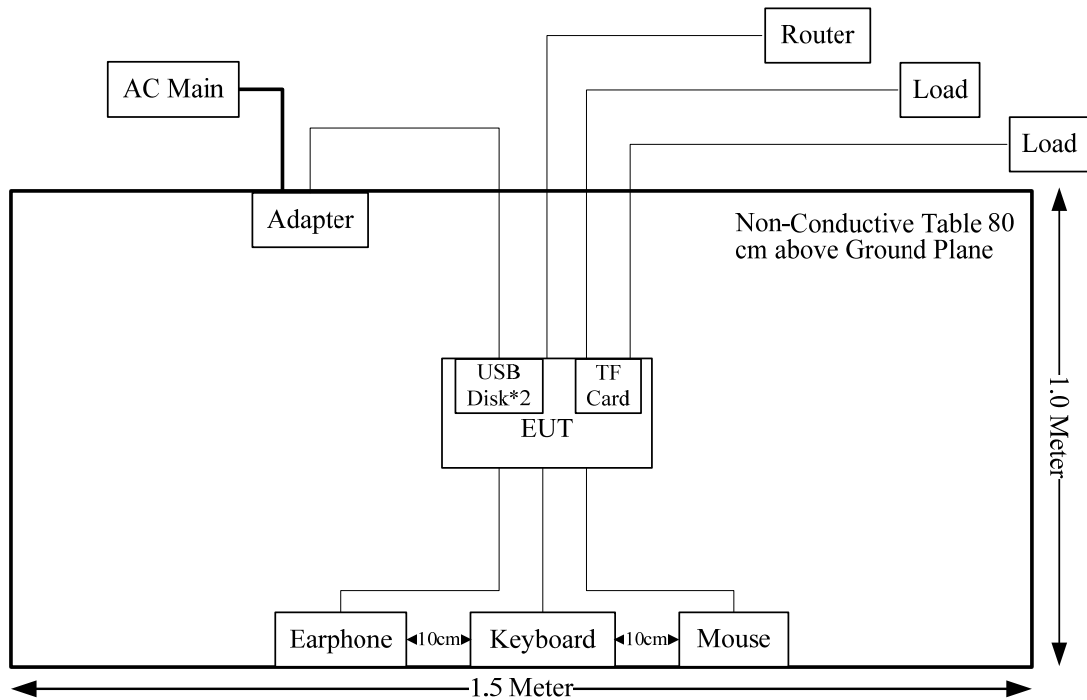

Above 1GHz:

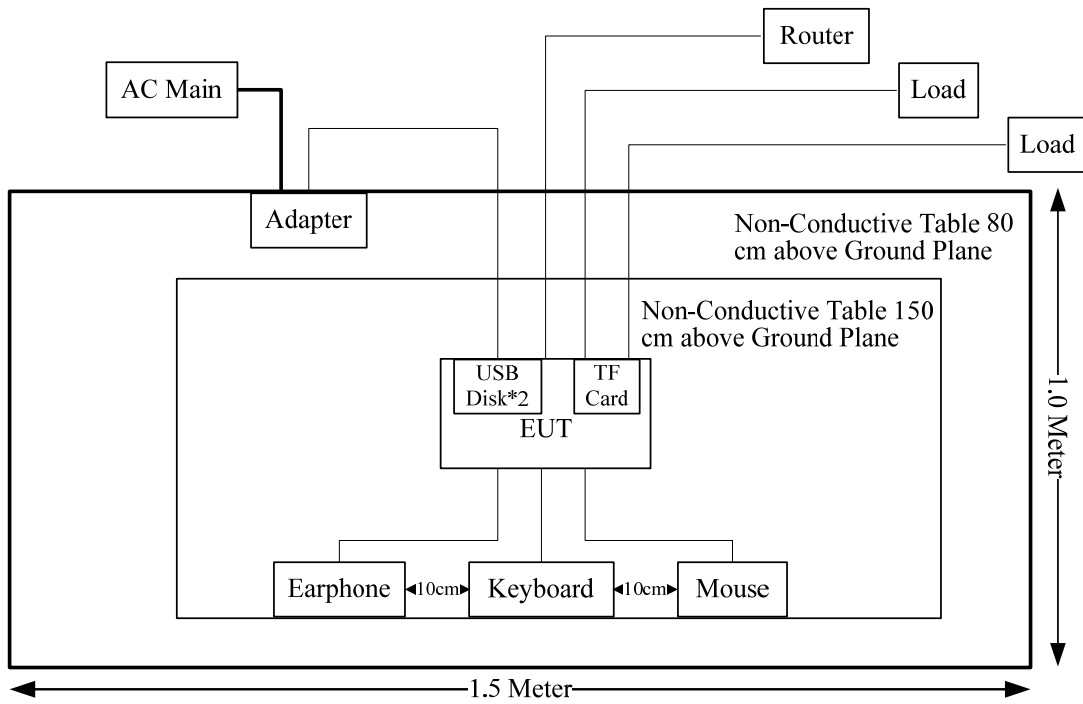

### 1.3 Measurement Uncertainty

Otherwise required by the applicant or Product Regulations, Decision Rule in this report did not consider the uncertainty. The extended uncertainty given in this report is obtained by combining the standard uncertainty times the coverage factor K with the 95% confidence interval.

Parameter	Measurement Uncertainty
Occupied Channel Bandwidth	±5 %
RF output power, conducted	±0.61dB
Power Spectral Density, conducted	±0.61 dB
Unwanted Emissions, radiated	30M~200MHz: 4.15 dB,200M~1GHz: 5.61 dB,1G~6GHz: 5.14 dB, 6G~18GHz: 5.93 dB,18G~26.5G:5.47 dB,26.5G~40G:5.63 dB
Unwanted Emissions, conducted	±1.26 dB
Temperature	±1 °C
Humidity	±5%
DC and low frequency voltages	±0.4%
Duty Cycle	1%
AC Power Lines Conducted Emission	2.8 dB (150 kHz to 30 MHz)

## 2. SUMMARY OF TEST RESULTS

Standard(s) Section	Test Items	Result
§15.203	Antenna Requirement	Compliance
§15.207(a)	AC line conducted emissions	Compliance
§15.205, §15.209, §15.247(d)	Spurious Emissions	Compliance
§15.247 (a)(2)	6 dB Bandwidth	Compliance
§15.247(b)(3)	Maximum Conducted Output Power	Compliance
§15.247(d)	100 kHz Bandwidth of Frequency Band Edge	Compliance
§15.247(e)	Power Spectral Density	Compliance
§15.247 (i) & §1.1310 & §2.1091	Maximum Permissible Exposure (MPE)	Compliance

### 3. REQUIREMENTS AND TEST PROCEDURES

#### 3.1 AC Line Conducted Emissions

##### 3.1.1 Applicable Standard

FCC§15.207(a).

(a) Except as shown in paragraphs (b) and (c) of this section, for an intentional radiator that is designed to be connected to the public utility (AC) power line, the radio frequency voltage that is conducted back onto the AC power line on any frequency or frequencies, within the band 150 kHz to 30 MHz, shall not exceed the limits in the following table, as measured using a 50  $\mu$ H/50 ohms line impedance stabilization network (LISN). Compliance with the provisions of this paragraph shall be based on the measurement of the radio frequency voltage between each power line and ground at the power terminal. The lower limit applies at the boundary between the frequency ranges.

Frequency of emission (MHz)	Conducted limit (dB $\mu$ V)	
	Quasi-peak	Average
0.15-0.5	66 to 56*	56 to 46*
0.5-5	56	46
5-30	60	50

\*Decreases with the logarithm of the frequency.

(b) The limit shown in paragraph (a) of this section shall not apply to carrier current systems operating as intentional radiators on frequencies below 30 MHz. In lieu thereof, these carrier current systems shall be subject to the following standards:

- (1) For carrier current system containing their fundamental emission within the frequency band 535-1705 kHz and intended to be received using a standard AM broadcast receiver: no limit on conducted emissions.
- (2) For all other carrier current systems: 1000  $\mu$ V within the frequency band 535-1705 kHz, as measured using a 50  $\mu$ H/50 ohms LISN.
- (3) Carrier current systems operating below 30 MHz are also subject to the radiated emission limits in §15.205, §15.209, §15.221, §15.223, or §15.227, as appropriate.

(c) Measurements to demonstrate compliance with the conducted limits are not required for devices which only employ battery power for operation and which do not operate from the AC power lines or contain provisions for operation while connected to the AC power lines. Devices that include, or make provisions for, the use of battery chargers which permit operating while charging, AC adapters or battery eliminators or that connect to the AC power lines indirectly, obtaining their power through another device which is connected to the AC power lines, shall be tested to demonstrate compliance with the conducted limits.

### 3.1.2 EUT Setup

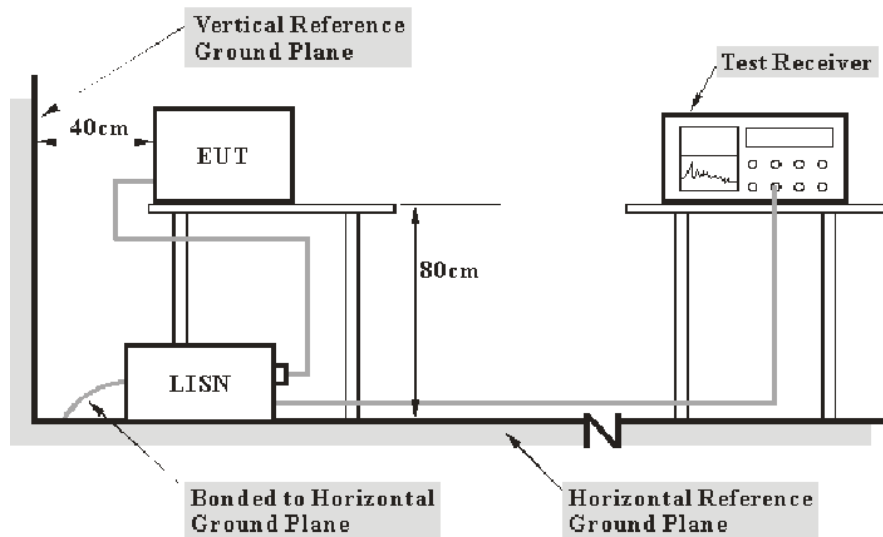

- Note: 1. Support units were connected to second LISN.  
 2. Both of LISNs (AMN) 80 cm from EUT and at the least 80 cm from other units and other metal planes support units.

The setup of EUT is according with per ANSI C63.10-2013 measurement procedure. The specification used was with the FCC Part 15.207 limits.

The spacing between the peripherals was 10 cm.

The adapter or EUT was connected to the main LISN with a 120 V/60 Hz AC power source.

### 3.1.3 EMI Test Receiver Setup

The EMI test receiver was set to investigate the spectrum from 150 kHz to 30 MHz.

During the conducted emission test, the EMI test receiver was set with the following configurations:

Frequency Range	IF B/W
150 kHz – 30 MHz	9 kHz

### 3.1.4 Test Procedure

The frequency and amplitude of the six highest ac power-line conducted emissions relative to the limit, measured over all the current-carrying conductors of the EUT power cords, and the operating frequency or frequency to which the EUT is tuned (if appropriate), should be reported, unless such emissions are more than 20 dB below the limit. AC power-line conducted emissions measurements are to be separately carried out only on each of the phase (“hot”) line(s) and (if used) on the neutral line(s), but not on the ground [protective earth] line(s). If less than six emission frequencies are within 20 dB of the limit, then the noise level of the measuring instrument at representative frequencies should be reported. The specific conductor of the power-line cord for each of the reported emissions should be identified. Measure the six highest emissions with respect to the limit on each current-carrying conductor of each power cord associated with the EUT (but not the power cords of associated or peripheral equipment that are part of the test configuration). Then, report the six highest emissions with respect to the limit from among all the measurements identifying the frequency and specific current-carrying conductor identified with the emission. The six highest emissions should be reported for each of the current-carrying conductors, or the six highest emissions may be reported over all the current-carrying conductors.

### 3.1.5 Corrected Amplitude & Margin Calculation

The basic equation is as follows:

Result = Reading + Factor

Factor = attenuation caused by cable loss + voltage division factor of AMN

The “**Margin**” column of the following data tables indicates the degree of compliance within the applicable limit. The equation for margin calculation is as follows:

Margin = Limit – Result

## 3.2 Radiation Spurious Emissions

### 3.2.1 Applicable Standard

FCC §15.247 (d);

In any 100 kHz bandwidth outside the frequency band in which the spread spectrum or digitally modulated intentional radiator is operating, the radio frequency power that is produced by the intentional radiator shall be at least 20 dB below that in the 100 kHz bandwidth within the band that contains the highest level of the desired power, based on either an RF conducted or a radiated measurement, provided the transmitter demonstrates compliance with the peak conducted power limits. If the transmitter complies with the conducted power limits based on the use of RMS averaging over a time interval, as permitted under paragraph (b)(3) of this section, the attenuation required under this paragraph shall be 30 dB instead of 20 dB. Attenuation below the general limits specified in §15.209(a) is not required. In addition, radiated emissions which fall in the restricted bands, as defined in §15.205(a), must also comply with the radiated emission limits specified in §15.209(a) (see §15.205(c)).

### 3.2.2 EUT Setup

**Below 1GHz:**

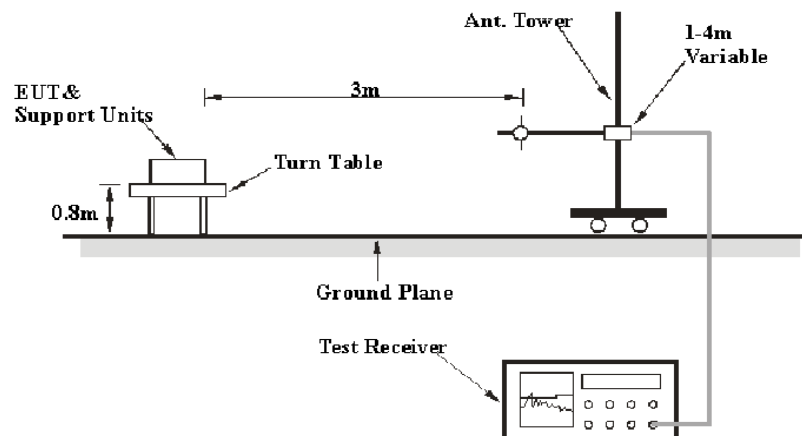

**Above 1GHz:**

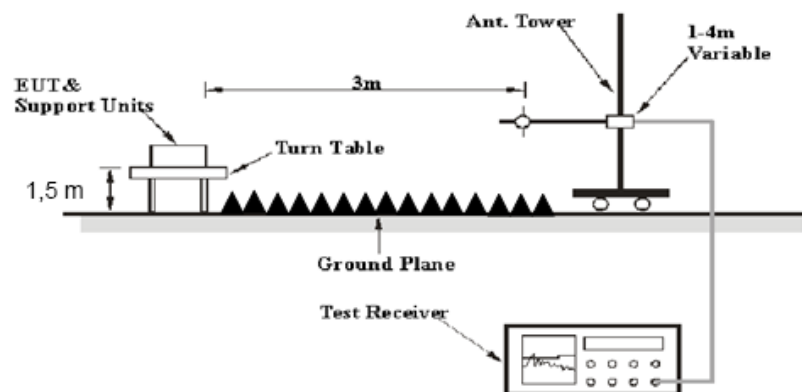

The radiated emissions were performed in the 3 meters distance, using the setup accordance with the ANSI C63.10-2013. The specification used was the FCC 15.209, and FCC 15.247 limits.



The external I/O cables were draped along the test table and formed a bundle 30 to 40 cm long in the middle.

The spacing between the peripherals was 10 cm.

### 3.2.3 EMI Test Receiver & Spectrum Analyzer Setup

The system was investigated from 30 MHz to 25 GHz.

During the radiated emission test, the EMI test receiver & Spectrum Analyzer Setup were set with the following configurations:

30MHz-1000MHz:

Measurement	RBW	Video B/W	IF B/W
QP	120 kHz	300 kHz	120kHz

1GHz- 25GHz:

Measurement	Duty cycle	RBW	Video B/W
PK	Any	1MHz	3 MHz
AV	>98%	1MHz	10 Hz
	<98%	1MHz	1/T

Note: T is minimum transmission duration

If the maximized peak measured value complies with under the QP/Average limit more than 6dB, then it is unnecessary to perform an QP/Average measurement.

### 3.2.4 Test Procedure

Maximizing procedure was performed on the highest emissions to ensure that the EUT complied with all installation combinations.

Data was recorded in Quasi-peak detection mode for frequency range of 30 MHz-1 GHz, peak and Average detection modes for frequencies above 1 GHz.

### 3.2.5 Corrected Amplitude & Margin Calculation

The basic equation is as follows:

Result = Reading + Factor

Factor = Antenna Factor + Cable Loss- Amplifier Gain

The “**Margin**” column of the following data tables indicates the degree of compliance within the applicable limit. The equation for margin calculation is as follows:

Margin = Limit – Result

### 3.3 6 dB Emission Bandwidth:

#### 3.3.1 Applicable Standard

FCC §15.247 (a)(2)

Systems using digital modulation techniques may operate in the 902-928 MHz, 2400-2483.5 MHz, and 5725-5850 MHz bands. The minimum 6 dB bandwidth shall be at least 500 kHz.

#### 3.3.2 EUT Setup

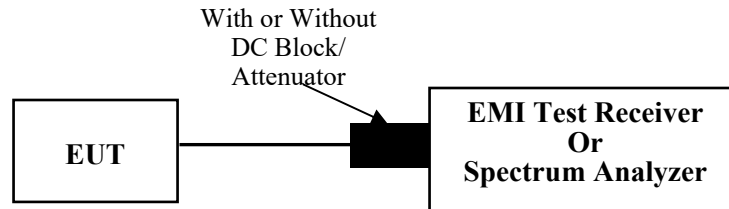

#### 3.3.3 Test Procedure

According to ANSI C63.10-2013 Section 11.8

- a) Set RBW = 100 kHz.
- b) Set the video bandwidth (VBW)  $\geq 3 \times$  RBW.
- c) Detector = Peak.
- d) Trace mode = max hold.
- e) Sweep = auto couple.
- f) Allow the trace to stabilize.
- g) Measure the maximum width of the emission that is constrained by the frequencies associated with the two outermost amplitude points (upper and lower frequencies) that are attenuated by 6 dB relative to the maximum level measured in the fundamental emission.

### 3.4 Maximum peak conducted output power:

#### 3.4.1 Applicable Standard

FCC §15.247 (b)(3)

For systems using digital modulation in the 902-928 MHz, 2400-2483.5 MHz, and 5725-5850 MHz bands: 1 Watt. As an alternative to a peak power measurement, compliance with the one Watt limit can be based on a measurement of the maximum conducted output power. Maximum Conducted Output Power is defined as the total transmit power delivered to all antennas and antenna elements averaged across all symbols in the signaling alphabet when the transmitter is operating at its maximum power control level. Power must be summed across all antennas and antenna elements. The average must not include any time intervals during which the transmitter is off or is transmitting at a reduced power level. If multiple modes of operation are possible (e.g., alternative modulation methods), the maximum conducted output power is the highest total transmit power occurring in any mode.

#### 3.4.2 EUT Setup

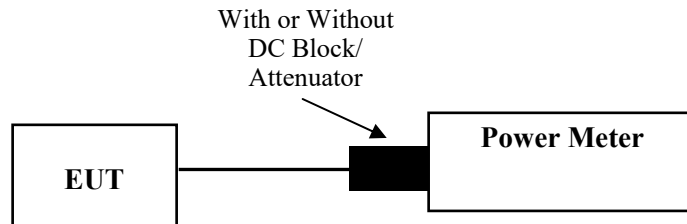

#### 3.4.3 Test Procedure

According to ANSI C63.10-2013 Section 11.9.1.3

The maximum peak conducted output power may be measured using a broadband peak RF power meter. The power meter shall have a video bandwidth that is greater than or equal to the DTS bandwidth and shall use a fast-responding diode detector.

- a) Set the EUT in transmitting mode.
- b) Remove the antenna from the EUT and then connect a low loss RF cable from the antenna port to test equipment.
- c) Add a correction factor to the display.
- d) Set the power meter to test peak output power, record the result.

### 3.5 Maximum power spectral density:

#### 3.5.1 Applicable Standard

FCC §15.247 (e)

For digitally modulated systems, the power spectral density conducted from the intentional radiator to the antenna shall not be greater than 8 dBm in any 3 kHz band during any time interval of continuous transmission. This power spectral density shall be determined in accordance with the provisions of paragraph (b) of this section. The same method of determining the conducted output power shall be used to determine the power spectral density.

#### 3.5.2 EUT Setup

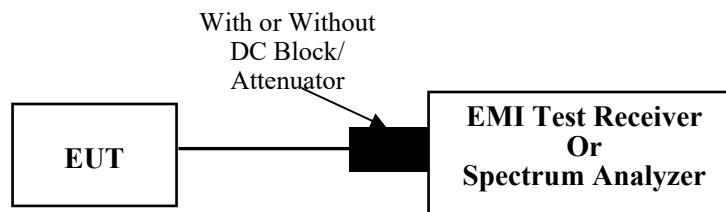

#### 3.5.3 Test Procedure

According to ANSI C63.10-2013 Section 11.10.2

- a) Set analyzer center frequency to DTS channel center frequency.
- b) Set the span to 1.5 times the DTS bandwidth.
- c) Set the RBW to  $3 \text{ kHz} \leq \text{RBW} \leq 100 \text{ kHz}$ .
- d) Set the VBW  $\geq [3 \cdot \text{RBW}]$ .
- e) Detector = peak.
- f) Sweep time = auto couple.
- g) Trace mode = max hold.
- h) Allow trace to fully stabilize.
- i) Use the peak marker function to determine the maximum amplitude level within the RBW.
- j) If measured value exceeds requirement, then reduce RBW (but no less than 3 kHz) and repeat.

### 3.6 100 kHz Bandwidth of Frequency Band Edge:

#### 3.6.1 Applicable Standard

FCC §15.247 (d);

In any 100 kHz bandwidth outside the frequency band in which the spread spectrum or digitally modulated intentional radiator is operating, the radio frequency power that is produced by the intentional radiator shall be at least 20 dB below that in the 100 kHz bandwidth within the band that contains the highest level of the desired power, based on either an RF conducted or a radiated measurement, provided the transmitter demonstrates compliance with the peak conducted power limits. If the transmitter complies with the conducted power limits based on the use of RMS averaging over a time interval, as permitted under paragraph (b)(3) of this section, the attenuation required under this paragraph shall be 30 dB instead of 20 dB. Attenuation below the general limits specified in §15.209(a) is not required. In addition, radiated emissions which fall in the restricted bands, as defined in §15.205(a), must also comply with the radiated emission limits specified in §15.209(a) (see §15.205(c)).

#### 3.6.2 EUT Setup

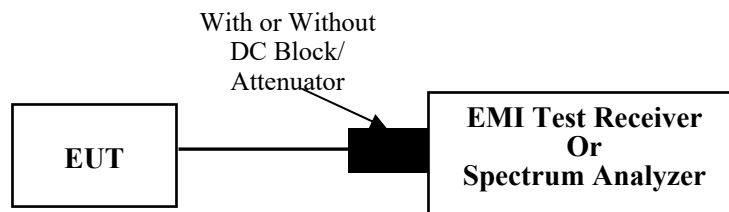

#### 3.6.3 Test Procedure

According to ANSI C63.10-2013 Section 11.11

- a) Set the center frequency and span to encompass frequency range to be measured.
- b) Set the RBW = 100 kHz.
- c) Set the VBW  $\geq [3 \times \text{RBW}]$ .
- d) Detector = peak.
- e) Sweep time = auto couple.
- f) Trace mode = max hold.
- g) Allow trace to fully stabilize.
- h) Use the peak marker function to determine the maximum amplitude level.

Ensure that the amplitude of all unwanted emissions outside of the authorized frequency band (excluding restricted frequency bands) is attenuated by at least the minimum requirements specified in 11.11. Report the three highest emissions relative to the limit.

### 3.7 Duty Cycle:

#### 3.7.1 EUT Setup

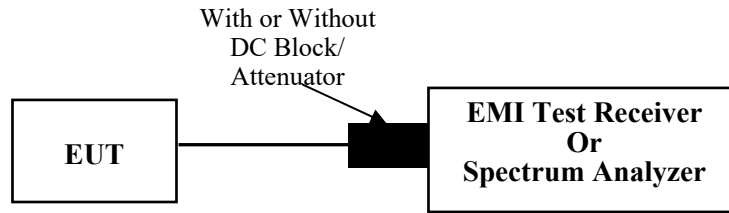

#### 3.7.2 Test Procedure

According to ANSI C63.10-2013 Section 11.6

The zero-span mode on a spectrum analyzer or EMI receiver if the response time and spacing between bins on the sweep are sufficient to permit accurate measurements of the ON and OFF times of the transmitted signal:

- 1) Set the center frequency of the instrument to the center frequency of the transmission.
- 2) Set  $RBW \geq OBW$  if possible; otherwise, set RBW to the largest available value.
- 3) Set  $VBW \geq RBW$ . Set detector = peak or average.
- 4) The zero-span measurement method shall not be used unless both RBW and VBW are  $> 50/T$  and the number of sweep points across duration T exceeds 100. (For example, if VBW and/or RBW are limited to 3 MHz, then the zero-span method of measuring the duty cycle shall not be used if  $T \leq 16.7 \mu s$ .)

### 3.8 Antenna Requirement

#### 3.8.1 Applicable Standard

FCC §15.203

An intentional radiator shall be designed to ensure that no antenna other than that furnished by the responsible party shall be used with the device. The use of a permanently attached antenna or of an antenna that uses a unique coupling to the intentional radiator shall be considered sufficient to comply with the provisions of this section. The manufacturer may design the unit so that a broken antenna can be replaced by the user, but the use of a standard antenna jack or electrical connector is prohibited. This requirement does not apply to carrier current devices or to devices operated under the provisions of §§15.211, 15.213, 15.217, 15.219, 15.221, or §15.236. Further, this requirement does not apply to intentional radiators that must be professionally installed, such as perimeter protection systems and some field disturbance sensors, or to other intentional radiators which, in accordance with §15.31(d), must be measured at the installation site. However, the installer shall be responsible for ensuring that the proper antenna is employed so that the limits in this part are not exceeded.

#### 3.8.2 Judgment

Please refer to the Antenna Information detail in Section 1.

## 4. Test DATA AND RESULTS

### 4.1 AC Line Conducted Emissions

Serial Number:	CR22010036-RF-S1(L1583 Type-1)	Test Date:	2022-02-09
Test Site:	CE	Test Mode:	Transmitting(802.11g low channel was the worst)
Tester:	Nick Tang	Test Result:	Pass

#### Environmental Conditions:

Temperature: (°C)	24	Relative Humidity: (%)	71	ATM Pressure: (kPa)	101.5
----------------------	----	---------------------------	----	------------------------	-------

#### Test Equipment List and Details:

Manufacturer	Description	Model	Serial Number	Calibration Date	Calibration Due Date
R&S	LISN	ENV216	101134	2021-04-25	2022-04-24
R&S	EMI Test Receiver	ESR3	102726	2021-07-22	2022-07-21
MICRO-COAX	Coaxial Cable	UTIFLEX	C-0200-01	2021-08-08	2022-08-07
Audix	Test Software	E3	190306 (V9)	N/A	N/A

\* Statement of Traceability: China Certification ICT Co., Ltd (Dongguan) attests that all calibrations have been performed, traceable to National Primary Standards and International System of Units (SI).

Model: L1583 Type-1

Line:

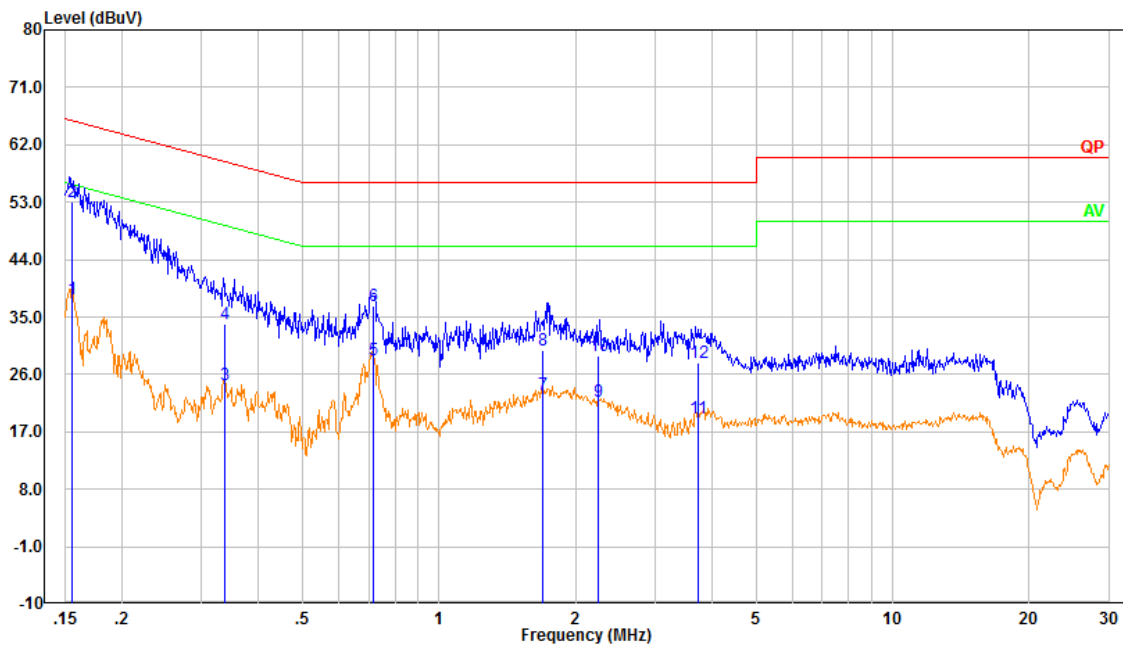

No.	Frequency (MHz)	Reading (dBμV)	Factor (dB)	Result (dBμV)	Limit (dBμV)	Margin (dB)	Detector
1	0.156	28.28	9.61	37.89	55.70	17.81	Average
2	0.156	43.39	9.61	53.00	65.70	12.70	QP
3	0.337	14.66	9.61	24.27	49.28	25.01	Average
4	0.337	24.26	9.61	33.87	59.28	25.41	QP
5	0.717	18.75	9.62	28.37	46.00	17.63	Average
6	0.717	27.08	9.62	36.70	56.00	19.30	QP
7	1.695	13.17	9.63	22.80	46.00	23.20	Average
8	1.695	20.15	9.63	29.78	56.00	26.22	QP
9	2.246	12.15	9.63	21.78	46.00	24.22	Average
10	2.246	19.18	9.63	28.81	56.00	27.19	QP
11	3.730	9.41	9.65	19.06	46.00	26.94	Average
12	3.730	18.16	9.65	27.81	56.00	28.19	QP



Neutral:

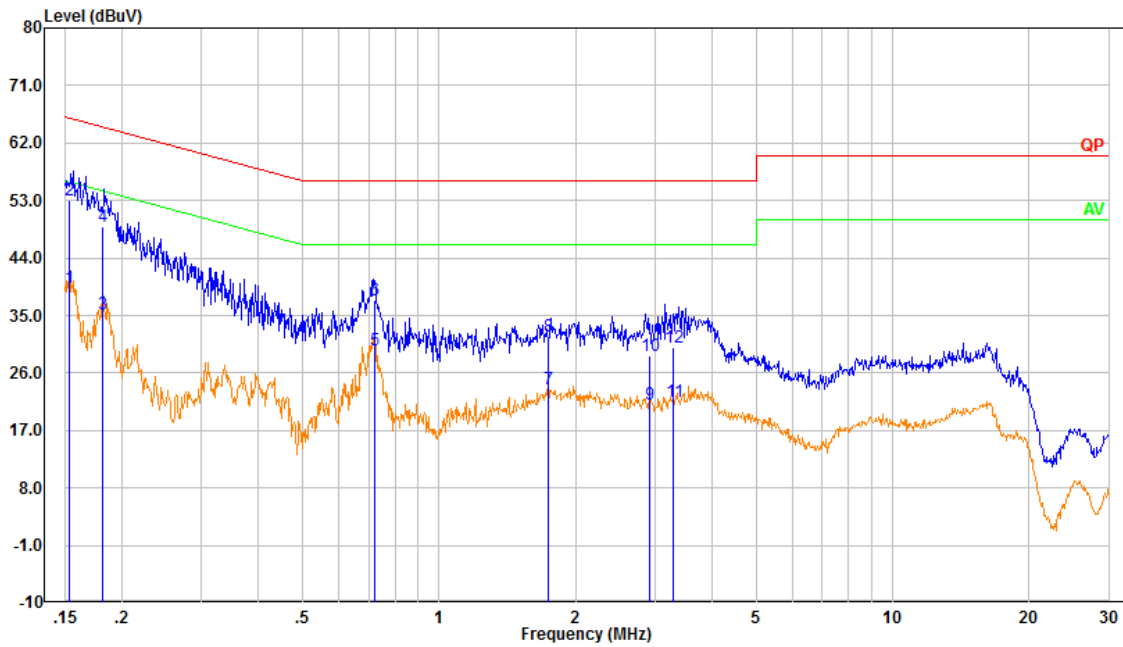

No.	Frequency (MHz)	Reading (dBμV)	Factor (dB)	Result (dBμV)	Limit (dBμV)	Margin (dB)	Detector
1	0.153	29.80	9.61	39.41	55.83	16.42	Average
2	0.153	43.46	9.61	53.07	65.83	12.76	QP
3	0.181	25.70	9.61	35.31	54.44	19.13	Average
4	0.181	39.20	9.61	48.81	64.44	15.63	QP
5	0.723	19.92	9.62	29.54	46.00	16.46	Average
6	0.723	27.74	9.62	37.36	56.00	18.64	QP
7	1.745	13.78	9.63	23.41	46.00	22.59	Average
8	1.745	22.18	9.63	31.81	56.00	24.19	QP
9	2.915	11.42	9.65	21.07	46.00	24.93	Average
10	2.915	19.09	9.65	28.74	56.00	27.26	QP
11	3.289	11.92	9.65	21.57	46.00	24.43	Average
12	3.289	20.40	9.65	30.05	56.00	25.95	QP

## 4.2 Radiation Spurious Emissions

Serial Number:	CR22010036-RF-S1(L1583 Type-1)	Test Date:	2022-02-09~2022-05-06
Test Site:	966-2, 966-1	Test Mode:	Transmitting
Tester:	Great Qiao, Adam Guo	Test Result:	Pass

### Environmental Conditions:

Temperature: (°C)	18.1~23.1	Relative Humidity: (%)	52~58	ATM Pressure: (kPa)	101.3~101.5
----------------------	-----------	------------------------------	-------	------------------------	-------------

### Test Equipment List and Details:

Manufacturer	Description	Model	Serial Number	Calibration Date	Calibration Due Date
ETS-Lindgren	Horn Antenna	3115	9912-5985	2020-10-13	2023-10-12
R&S	Spectrum Analyzer	FSV40	101591	2021-07-22	2022-07-21
MICRO-COAX	Coaxial Cable	UFA210A-1-1200-70U300	217423-008	2021-08-08	2022-08-07
MICRO-COAX	Coaxial Cable	UFA210A-1-2362-300300	235780-001	2021-08-08	2022-08-07
Mini	Pre-amplifier	ZVA-183-S+	5969001149	2021-11-10	2022-11-09
Audix	Test Software	E3	201021 (V9)	N/A	N/A
PASTERNAK	Horn Antenna	PE9852/2F-20	112002	2021-02-05	2024-02-04
AH	Preamplifier	PAM-1840VH	190	2021-11-19	2022-11-18
MICRO-COAX	Coaxial Cable	UFB142A-1-2362-200200	235772-001	2021-08-08	2022-08-07
E-Microwave	Band Rejection Filter	2400-2483.5MHz	OE01902424	2021-08-08	2022-08-07
Sunol Sciences	Antenna	JB6	A082520-5	2020-10-19	2023-10-18
R&S	EMI Test Receiver	ESR3	102724	2021-07-22	2022-07-21
TIMES MICROWAVE	Coaxial Cable	LMR-600-UltraFlex	C-0470-02	2021-07-18	2022-07-17
TIMES MICROWAVE	Coaxial Cable	LMR-600-UltraFlex	C-0780-01	2021-07-18	2022-07-17
Sonoma	Amplifier	310N	186165	2021-07-18	2022-07-17

\* Statement of Traceability: China Certification ICT Co., Ltd (Dongguan) attests that all calibrations have been performed, traceable to National Primary Standards and International System of Units (SI).

### 1) 30MHz-1GHz(802.11b Low channel was the worst)

Model: L1583 Type-1

Horizontal:

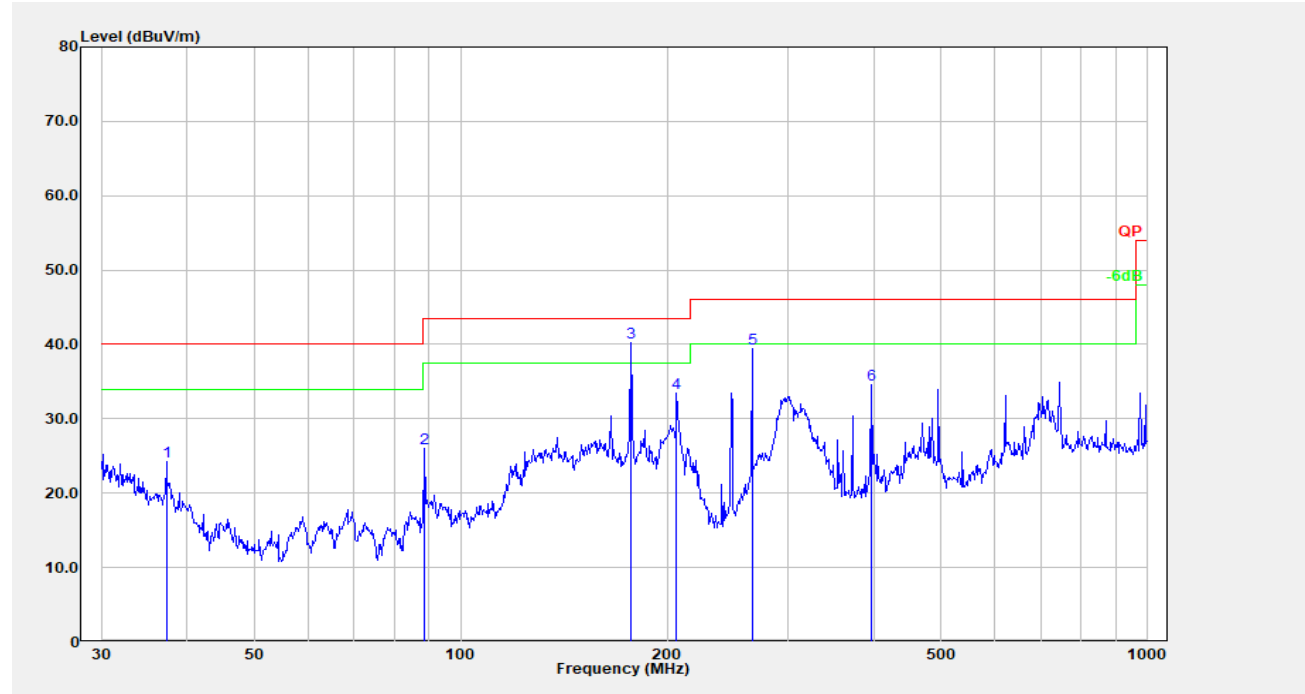

No.	Frequency (MHz)	Reading (dB $\mu$ V)	Factor (dB/m)	Result (dB $\mu$ V/m)	Limit (dB $\mu$ V/m)	Margin (dB)	Detector
1	37.285	33.57	-9.40	24.17	40.00	15.83	Peak
2	88.652	43.21	-17.26	25.95	43.50	17.55	Peak
3	176.888	53.79	-13.62	40.17	43.50	3.33	QP
4	206.398	45.93	-12.55	33.38	43.50	10.12	Peak
5	265.676	51.86	-12.44	39.42	46.00	6.58	Peak
6	396.242	43.63	-9.05	34.58	46.00	11.42	Peak

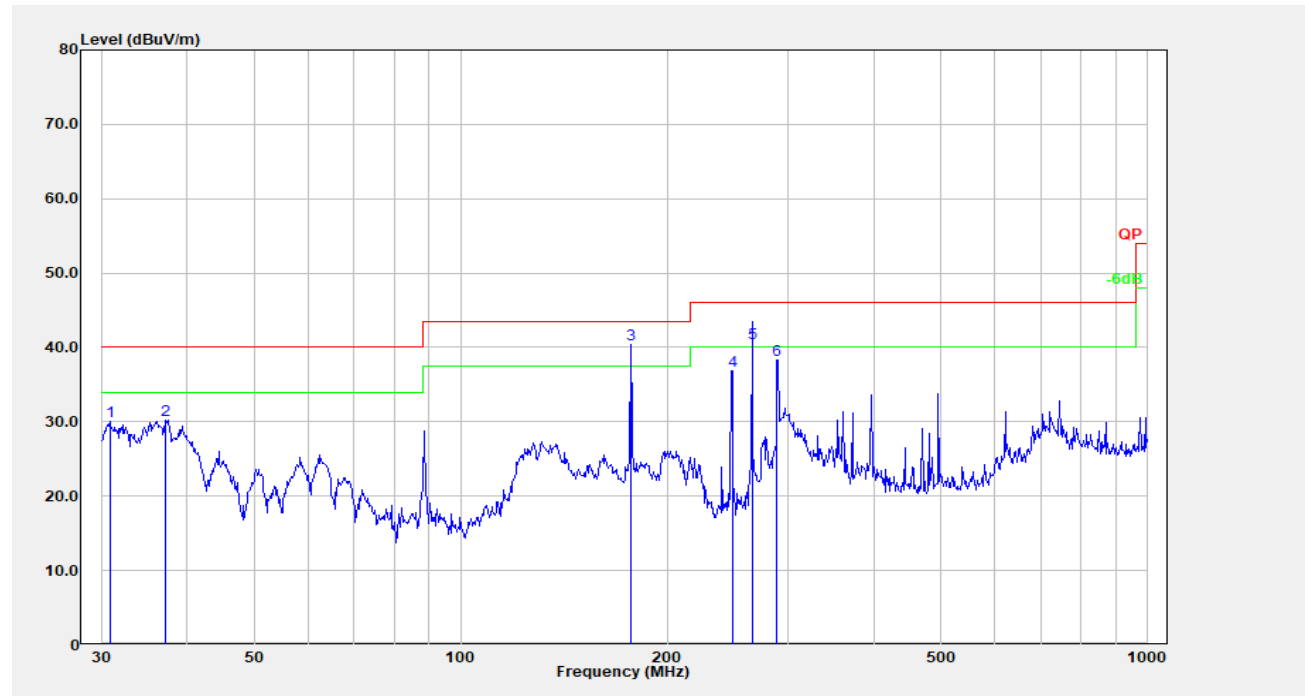
**Vertical:**

No.	Frequency (MHz)	Reading (dB $\mu$ V)	Factor (dB/m)	Result (dB $\mu$ V/m)	Limit (dB $\mu$ V/m)	Margin (dB)	Detector
1	30.853	34.43	-4.45	29.99	40.00	10.01	Peak
2	37.155	39.53	-9.30	30.23	40.00	9.77	Peak
3	176.888	53.96	-13.62	40.34	43.50	3.16	QP
4	248.552	50.05	-13.23	36.82	46.00	9.18	Peak
5	265.676	52.97	-12.44	40.53	46.00	5.47	QP
6	289.002	49.56	-11.28	38.28	46.00	7.72	Peak

**2) 1-25GHz(L1583 Type-1 was the worst):  
802.11b Mode:**

Frequency (MHz)	Receiver		Polar (H/V)	Factor (dB/m)	Result (dB $\mu$ V/m)	Limit (dB $\mu$ V/m)	Margin (dB)
	Reading (dB $\mu$ V)	Detector					
Low Channel: 2412 MHz							
2412.00	70.10	PK	H	31.53	101.63	N/A	N/A
2412.00	67.53	AV	H	31.53	99.06	N/A	N/A
2412.00	70.90	PK	V	31.53	102.43	N/A	N/A
2412.00	67.99	AV	V	31.53	99.52	N/A	N/A
2390.00	27.35	PK	V	31.46	58.81	74.00	15.19
2390.00	14.50	AV	V	31.46	45.96	54.00	8.04
4824.00	34.81	PK	V	10.94	45.75	74.00	28.25
4824.00	21.64	AV	V	10.94	32.58	54.00	21.42
7236.00	31.54	PK	V	14.44	45.98	74.00	28.02
7236.00	20.67	AV	V	14.44	35.11	54.00	18.89
Middle Channel: 2437 MHz							
2437.00	70.49	PK	H	31.60	102.09	N/A	N/A
2437.00	68.02	AV	H	31.60	99.62	N/A	N/A
2437.00	70.54	PK	V	31.60	102.14	N/A	N/A
2437.00	67.90	AV	V	31.60	99.50	N/A	N/A
4874.00	34.20	PK	V	11.05	45.25	74.00	28.75
4874.00	21.89	AV	V	11.05	32.94	54.00	21.06
7311.00	32.83	PK	V	14.80	47.63	74.00	26.37
7311.00	20.67	AV	V	14.80	35.47	54.00	18.53
High Channel: 2462MHz							
2462.00	71.05	PK	H	31.63	102.68	N/A	N/A
2462.00	68.48	AV	H	31.63	100.11	N/A	N/A
2462.00	71.16	PK	V	31.63	102.79	N/A	N/A
2462.00	68.28	AV	V	31.63	99.91	N/A	N/A
2483.50	27.81	PK	V	31.64	59.45	74.00	14.55
2483.50	14.80	AV	V	31.64	46.44	54.00	7.56
4924.00	34.78	PK	V	11.18	45.96	74.00	28.04
4924.00	21.22	AV	V	11.18	32.40	54.00	21.60
7386.00	31.86	PK	V	14.89	46.75	74.00	27.25
7386.00	22.18	AV	V	14.89	37.07	54.00	16.93

**802.11g Mode:**

Frequency (MHz)	Receiver		Polar (H/V)	Factor (dB/m)	Result (dB $\mu$ V/m)	Limit (dB $\mu$ V/m)	Margin (dB)
	Reading (dB $\mu$ V)	Detector					
Low Channel: 2412 MHz							
2412.00	71.19	PK	H	31.53	102.72	N/A	N/A
2412.00	60.79	AV	H	31.53	92.32	N/A	N/A
2412.00	73.83	PK	V	31.53	105.36	N/A	N/A
2412.00	62.63	AV	V	31.53	94.16	N/A	N/A
2390.00	33.73	PK	V	31.46	65.19	74.00	8.81
2390.00	15.96	AV	V	31.46	47.42	54.00	6.58
4824.00	33.68	PK	V	10.94	44.62	74.00	29.38
4824.00	22.68	AV	V	10.94	33.62	54.00	20.38
7236.00	34.42	PK	V	14.44	48.86	74.00	25.14
7236.00	22.37	AV	V	14.44	36.81	54.00	17.19
Middle Channel: 2437 MHz							
2437.00	71.22	PK	H	31.60	102.82	N/A	N/A
2437.00	60.18	AV	H	31.60	91.78	N/A	N/A
2437.00	74.01	PK	V	31.60	105.61	N/A	N/A
2437.00	62.18	AV	V	31.60	93.78	N/A	N/A
4874.00	32.63	PK	V	11.05	43.68	74.00	30.32
4874.00	20.46	AV	V	11.05	31.51	54.00	22.49
7311.00	32.11	PK	V	14.80	46.91	74.00	27.09
7311.00	20.97	AV	V	14.80	35.77	54.00	18.23
High Channel: 2462MHz							
2462.00	71.19	PK	H	31.63	102.82	N/A	N/A
2462.00	60.86	AV	H	31.63	92.49	N/A	N/A
2462.00	73.44	PK	V	31.63	105.07	N/A	N/A
2462.00	62.81	AV	V	31.63	94.44	N/A	N/A
2483.50	32.54	PK	V	31.64	64.18	74.00	9.82
2483.50	16.86	AV	V	31.64	48.50	54.00	5.50
4924.00	33.21	PK	V	11.18	44.39	74.00	29.61
4924.00	20.97	AV	V	11.18	32.15	54.00	21.85
7386.00	32.23	PK	V	14.89	47.12	74.00	26.88
7386.00	22.20	AV	V	14.89	37.09	54.00	16.91

**802.11n ht20 Mode:**

Frequency (MHz)	Receiver		Polar (H/V)	Factor (dB/m)	Result (dB $\mu$ V/m)	Limit (dB $\mu$ V/m)	Margin (dB)
	Reading (dB $\mu$ V)	Detector					
Low Channel: 2412 MHz							
2412.00	70.69	PK	H	31.53	102.22	N/A	N/A
2412.00	60.40	AV	H	31.53	91.93	N/A	N/A
2412.00	72.34	PK	V	31.53	103.87	N/A	N/A
2412.00	62.05	AV	V	31.53	93.58	N/A	N/A
2390.00	30.95	PK	V	31.46	62.41	74.00	11.59
2390.00	16.27	AV	V	31.46	47.73	54.00	6.27
4824.00	33.40	PK	V	10.94	44.34	74.00	29.66
4824.00	22.82	AV	V	10.94	33.76	54.00	20.24
7236.00	32.55	PK	V	14.44	46.99	74.00	27.01
7236.00	20.67	AV	V	14.44	35.11	54.00	18.89
Middle Channel: 2437 MHz							
2437.00	69.74	PK	H	31.60	101.34	N/A	N/A
2437.00	59.80	AV	H	31.60	91.40	N/A	N/A
2437.00	71.41	PK	V	31.60	103.01	N/A	N/A
2437.00	60.58	AV	V	31.60	92.18	N/A	N/A
4874.00	33.02	PK	V	11.05	44.07	74.00	29.93
4874.00	21.74	AV	V	11.05	32.79	54.00	21.21
7311.00	32.47	PK	V	14.80	47.27	74.00	26.73
7311.00	20.98	AV	V	14.80	35.78	54.00	18.22
High Channel: 2462MHz							
2462.00	70.13	PK	H	31.63	101.76	N/A	N/A
2462.00	60.27	AV	H	31.63	91.90	N/A	N/A
2462.00	73.48	PK	V	31.63	105.11	N/A	N/A
2462.00	62.86	AV	V	31.63	94.49	N/A	N/A
2483.50	34.30	PK	V	31.64	65.94	74.00	8.06
2483.50	16.86	AV	V	31.64	48.50	54.00	5.50
4924.00	32.89	PK	V	11.18	44.07	74.00	29.93
4924.00	22.20	AV	V	11.18	33.38	54.00	20.62
7386.00	31.84	PK	V	14.89	46.73	74.00	27.27
7386.00	19.89	AV	V	14.89	34.78	54.00	19.22

**BLE:**

Frequency (MHz)	Receiver		Polar (H/V)	Factor (dB/m)	Result (dB $\mu$ V/m)	Limit (dB $\mu$ V/m)	Margin (dB)
	Reading (dB $\mu$ V)	Detector					
Low Channel: 2402 MHz							
2402.00	69.18	PK	H	31.51	100.69	N/A	N/A
2402.00	62.62	AV	H	31.51	94.13	N/A	N/A
2402.00	66.45	PK	V	31.51	97.96	N/A	N/A
2402.00	60.16	AV	V	31.51	91.67	N/A	N/A
2390.00	27.88	PK	H	31.46	59.34	74.00	14.66
2390.00	13.79	AV	H	31.46	45.25	54.00	8.75
4804.00	34.56	PK	H	10.91	45.47	74.00	28.53
4804.00	22.10	AV	H	10.91	33.01	54.00	20.99
7206.00	33.98	PK	H	14.22	48.20	74.00	25.80
7206.00	22.60	AV	H	14.22	36.82	54.00	17.18
Middle Channel: 2440 MHz							
2440.00	68.23	PK	H	31.60	99.83	N/A	N/A
2440.00	61.96	AV	H	31.60	93.56	N/A	N/A
2440.00	66.19	PK	V	31.60	97.79	N/A	N/A
2440.00	59.28	AV	V	31.60	90.88	N/A	N/A
4880.00	32.20	PK	H	11.07	43.27	74.00	30.73
4880.00	20.48	AV	H	11.07	31.55	54.00	22.45
7320.00	32.89	PK	H	14.80	47.69	74.00	26.31
7320.00	20.61	AV	H	14.80	35.41	54.00	18.59
High Channel: 2480 MHz							
2480.00	69.76	PK	H	31.64	101.40	N/A	N/A
2480.00	63.42	AV	H	31.64	95.06	N/A	N/A
2480.00	66.90	PK	V	31.64	98.54	N/A	N/A
2480.00	60.14	AV	V	31.64	91.78	N/A	N/A
2483.50	30.78	PK	H	31.64	62.42	74.00	11.58
2483.50	14.39	AV	H	31.64	46.03	54.00	7.97
4960.00	34.76	PK	H	11.23	45.99	74.00	28.01
4960.00	21.22	AV	H	11.23	32.45	54.00	21.55
7440.00	34.12	PK	H	15.26	49.38	74.00	24.62
7440.00	22.29	AV	H	15.26	37.55	54.00	16.45



**Worst Test plots(BLE mode high channel was the worst)**

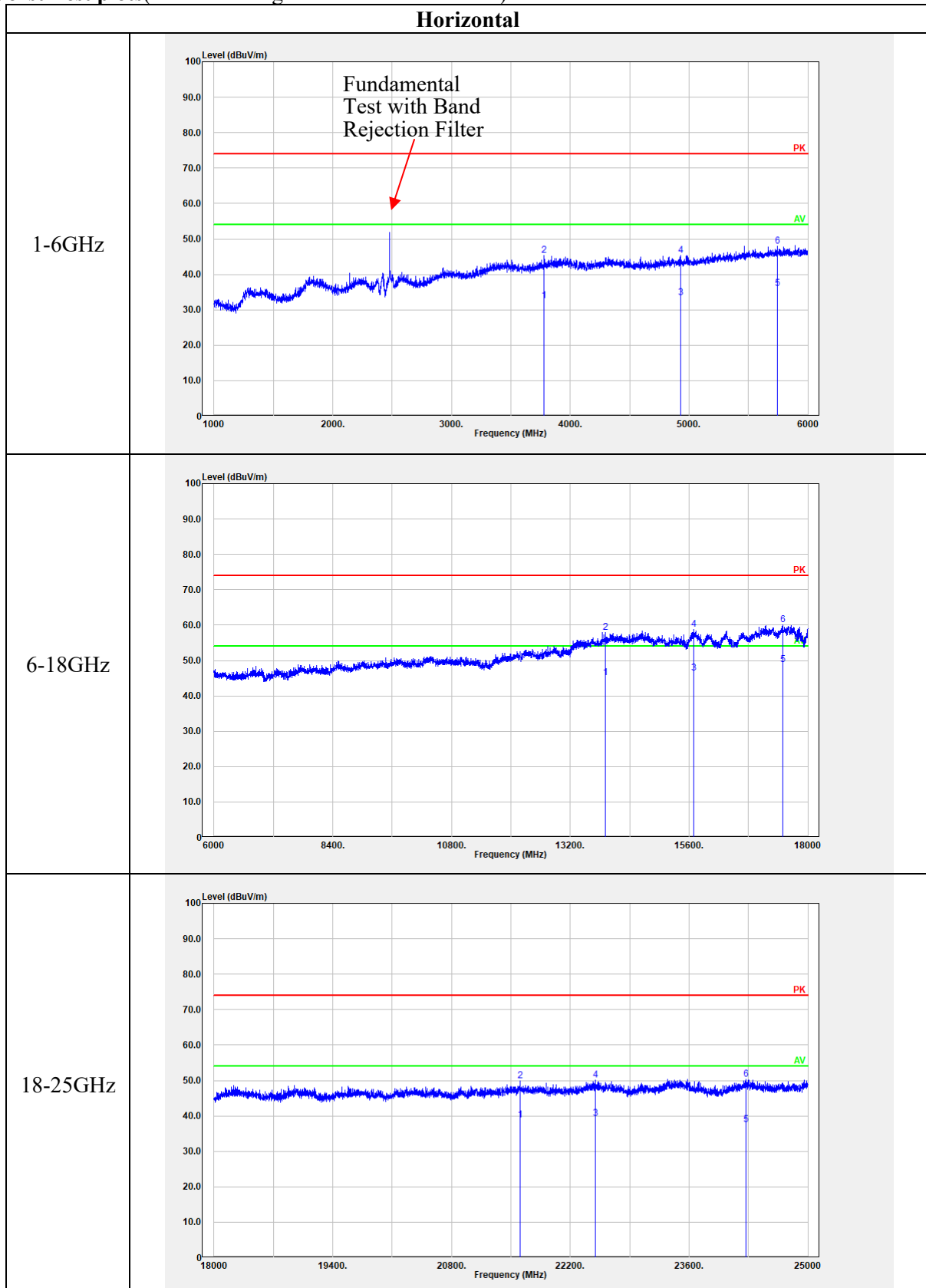

Vertical

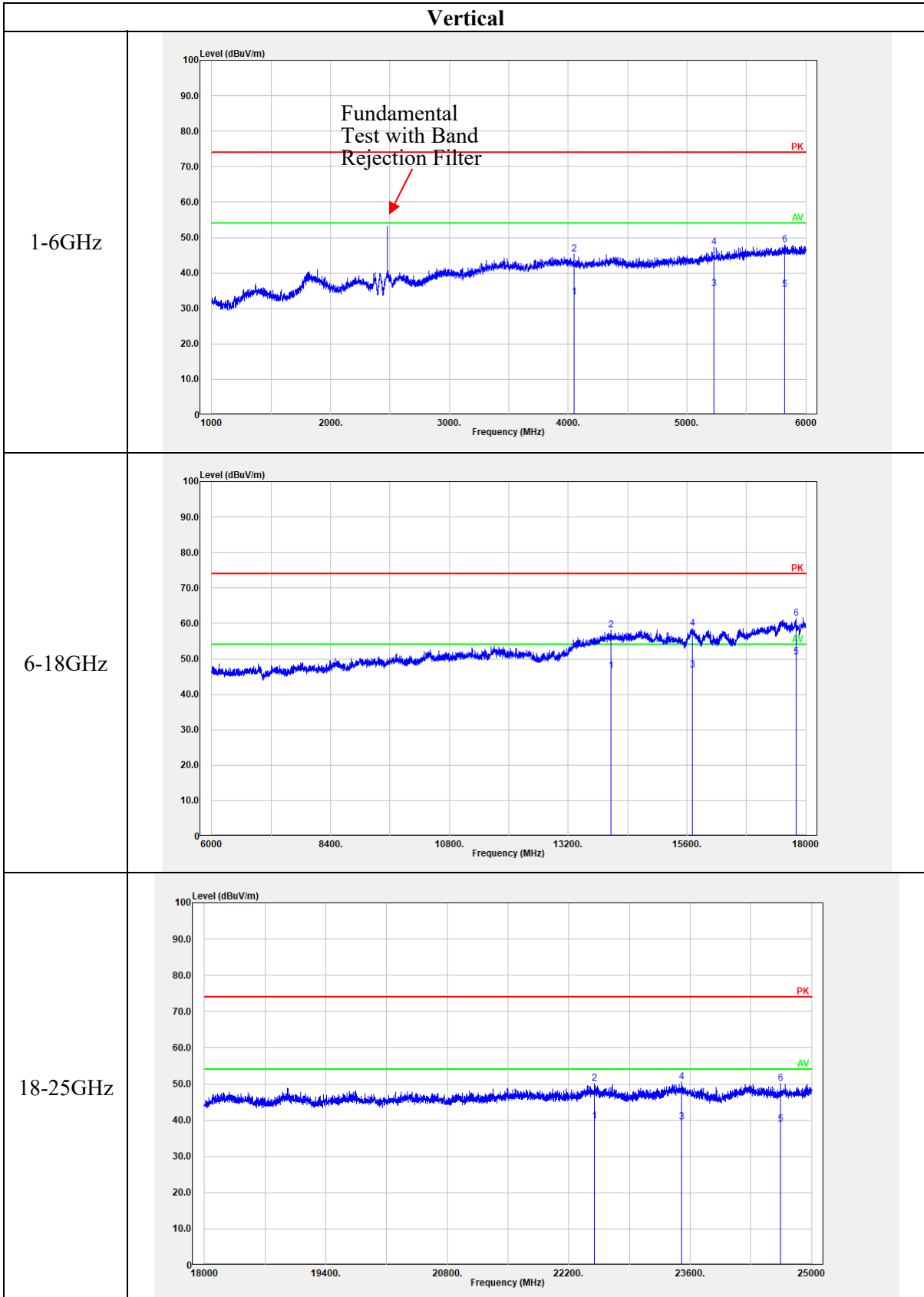

**4.3 6 dB Emission Bandwidth:**

Serial Number:	CR22010036-RF-S1	Test Date:	2022/3/25
Test Site:	RF	Test Mode:	Transmitting
Tester:	Mark Wang	Test Result:	Pass

**Environmental Conditions:**

Temperature: (°C)	25.9	Relative Humidity: (%)	60	ATM Pressure: (kPa)	100.2
----------------------	------	------------------------------	----	------------------------	-------

**Test Equipment List and Details:**

Manufacturer	Description	Model	Serial Number	Calibration Date	Calibration Due Date
R&S	Spectrum Analyzer	FSV40	101943	2021-10-10	2022-10-09
zhuoxiang	Coaxial Cable	SMA-178	211001	Each time	N/A
eastsheep	Coaxial Attenuator	2W-SMA-JK-18G	21060301	2021-08-08	2022-08-07
HuiXunDa	DC Block	SMA-JK 18G	DCB181108042	2022-01-21	2023-01-20

\* Statement of Traceability: China Certification ICT Co., Ltd (Dongguan) attests that all calibrations have been performed, traceable to National Primary Standards and International System of Units (SI).

**Test Data:**

Test Modes	Test Frequency (MHz)	6 dB Bandwidth (MHz)	Limit (MHz)
802.11b	2412	10.029	0.5
	2437	10.029	0.5
	2462	9.986	0.5
802.11g	2412	15.412	0.5
	2437	15.412	0.5
	2462	15.716	0.5
802.11n ht20	2412	15.456	0.5
	2437	15.369	0.5
	2462	15.76	0.5
BLE	2402	0.729	0.5
	2440	0.729	0.5
	2480	0.729	0.5

### 6dB Emission Bandwidth

802.11b  
Lowest Channel

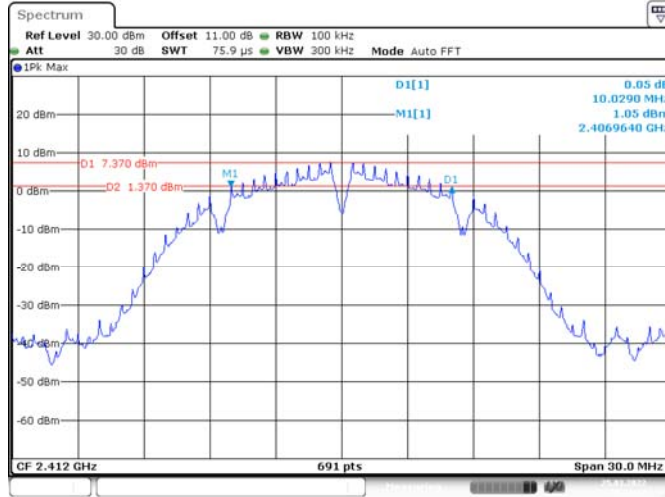

802.11b  
Middle Channel

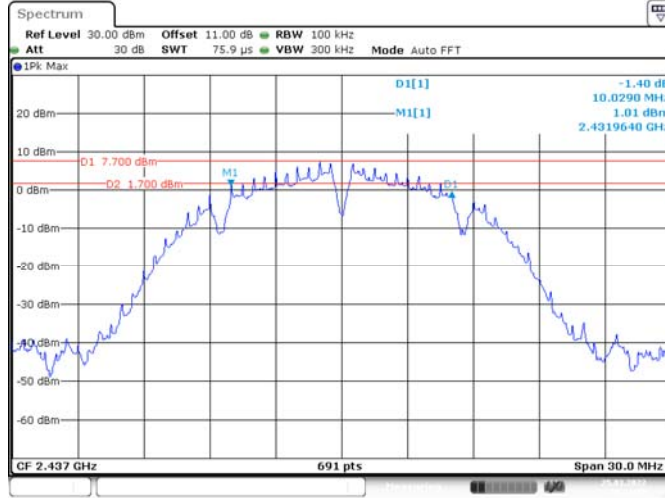

802.11b  
Highest Channel

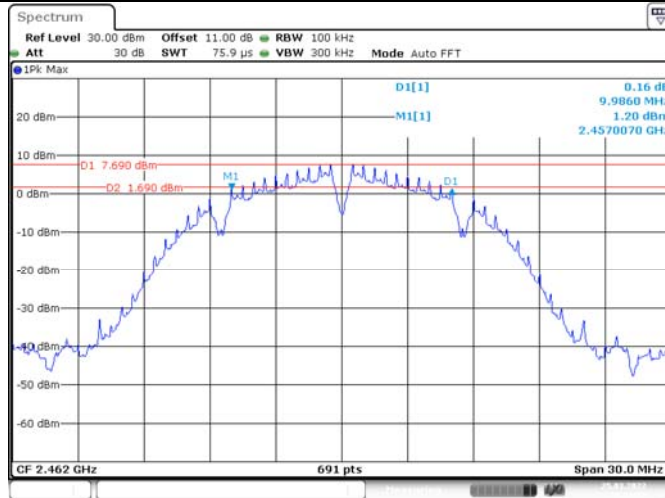

### 6dB Emission Bandwidth

802.11g  
Lowest Channel

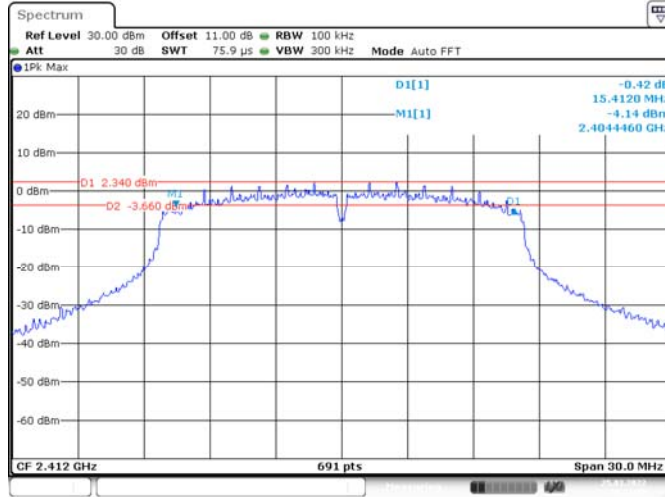

802.11g  
Middle Channel

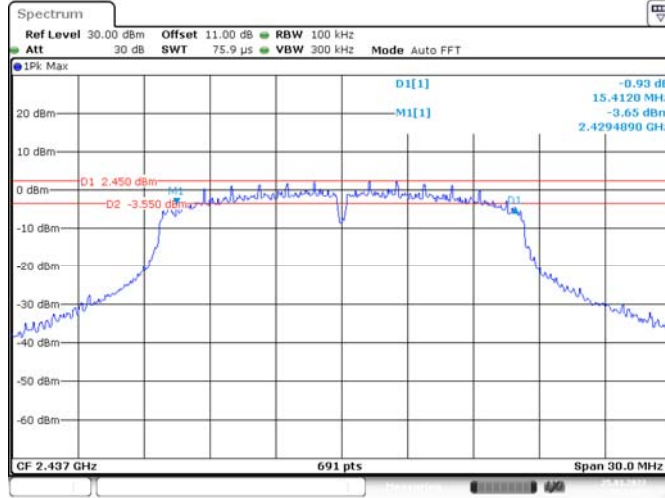

802.11g  
Highest Channel

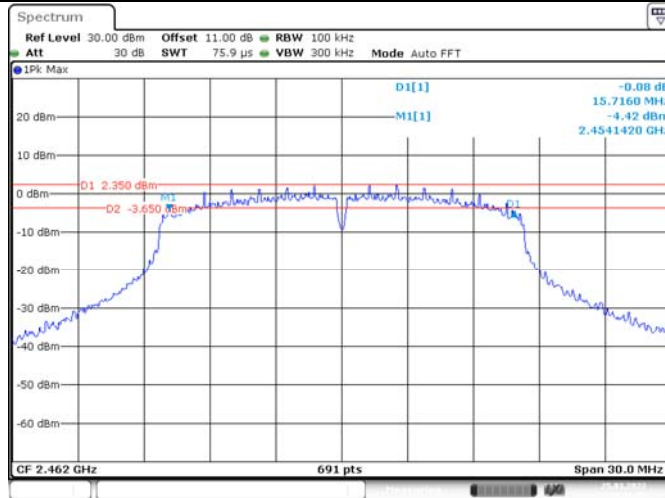

### 6dB Emission Bandwidth

802.11n ht20  
Lowest Channel

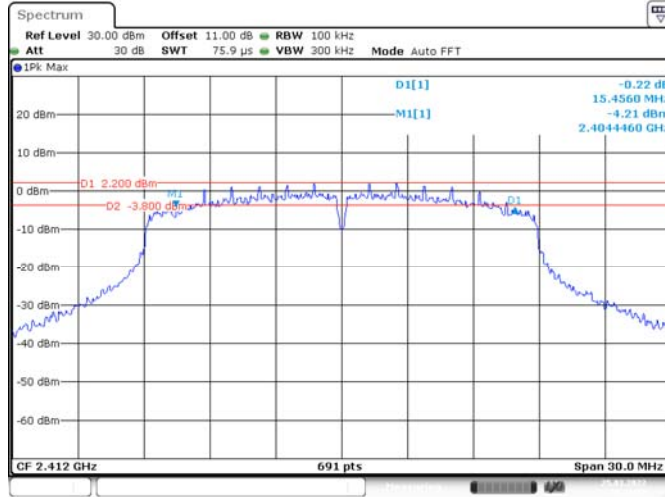

Date: 25 MAR 2022 10:20:33

802.11n ht20  
Middle Channel

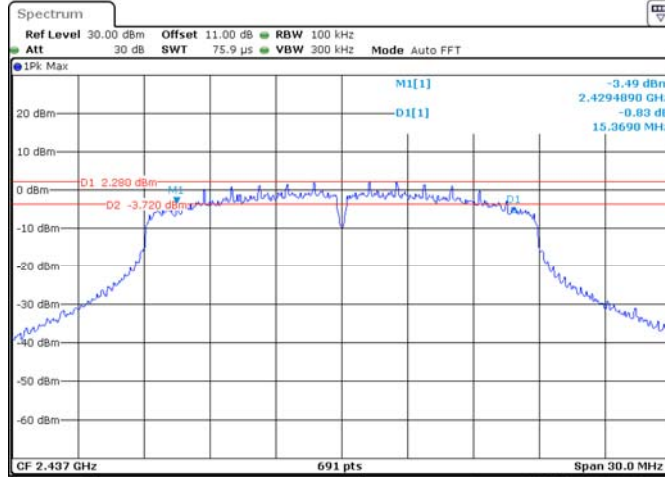

Date: 25 MAR 2022 10:18:05

802.11n ht20  
Highest Channel



Date: 25 MAR 2022 10:15:15

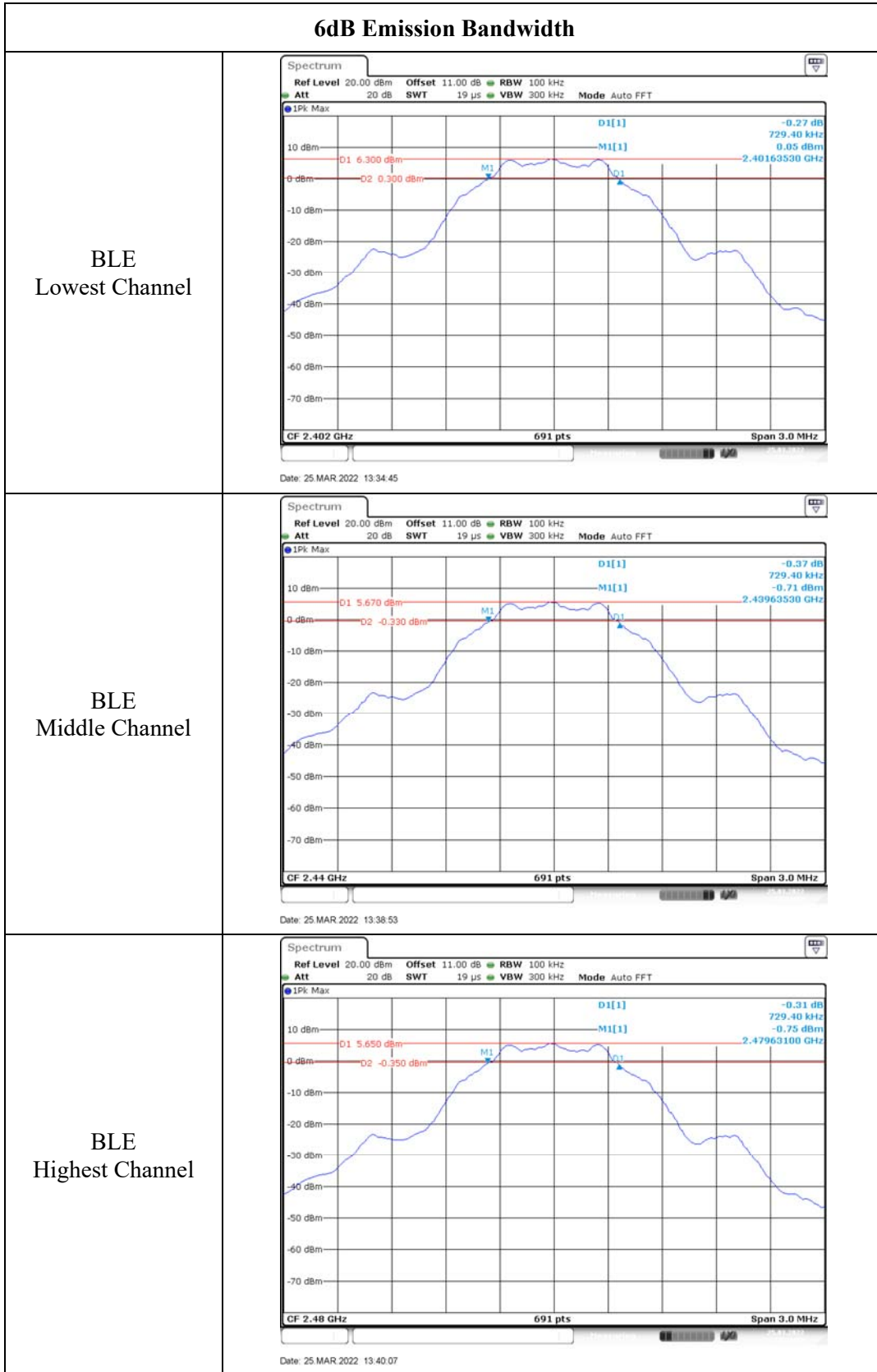

**4.4 Maximum conducted output power:**

Serial Number:	CR22010036-RF-S1	Test Date:	2022-03-25
Test Site:	RF	Test Mode:	Transmitting
Tester:	Mark Wang	Test Result:	Pass

**Environmental Conditions:**

Temperature: (°C)	25.9	Relative Humidity: (%)	60	ATM Pressure: (kPa)	100.2
----------------------	------	------------------------------	----	------------------------	-------

**Test Equipment List and Details:**

Manufacturer	Description	Model	Serial Number	Calibration Date	Calibration Due Date
Agilent	USB Wideband Power Sensor	U2021XA	MY54080015	2021-07-22	2022-07-21
zhuoxiang	Coaxial Cable	SMA-178	211001	Each time	N/A
eastsheep	Coaxial Attenuator	2W-SMA-JK-18G	21060301	2021-08-08	2022-08-07
HuiXunDa	DC Block	SMA-JK 18G	DCB181108042	2022-01-21	2023-01-20

\* Statement of Traceability: China Certification ICT Co., Ltd (Dongguan) attests that all calibrations have been performed, traceable to National Primary Standards and International System of Units (SI).

**Test Data:**

Test Modes	Test Channel	Test Frequency (MHz)	Maximum Conducted Peak Output Power (dBm)	Limit (dBm)
802.11b	Lowest	2412	18.94	30
	Middle	2437	18.82	30
	Highest	2462	18.87	30
802.11g	Lowest	2412	21.69	30
	Middle	2437	21.91	30
	Highest	2462	21.65	30
802.11n ht20	Lowest	2412	21.53	30
	Middle	2437	21.49	30
	Highest	2462	21.69	30
BLE	Lowest	2402	7.04	30
	Middle	2440	7.23	30
	Highest	2480	6.88	30



**4.5 Maximum power spectral density:**

Serial Number:	CR22010036-RF-S1	Test Date:	2022-03-25
Test Site:	RF	Test Mode:	Transmitting
Tester:	Mark Wang	Test Result:	Pass

**Environmental Conditions:**

Temperature: (°C)	25.9	Relative Humidity: (%)	60	ATM Pressure: (kPa)	100.2
----------------------	------	---------------------------	----	------------------------	-------

**Test Equipment List and Details:**

Manufacturer	Description	Model	Serial Number	Calibration Date	Calibration Due Date
R&S	Spectrum Analyzer	FSV40	101943	2021-10-10	2022-10-09
zhuoxiang	Coaxial Cable	SMA-178	211001	Each time	N/A
eastsheep	Coaxial Attenuator	2W-SMA-JK-18G	21060301	2021-08-08	2022-08-07
HuiXunDa	DC Block	SMA-JK 18G	DCB181108042	2022-01-21	2023-01-20

\* Statement of Traceability: China Certification ICT Co., Ltd (Dongguan) attests that all calibrations have been performed, traceable to National Primary Standards and International System of Units (SI).

**Test Data:**

Test Channel	Test Frequency (MHz)	Power Spectral Density (dBm/3kHz)	Limit (dBm/3kHz)
802.11b	2412	-4.72	8.00
	2437	-4.65	8.00
	2462	-5.07	8.00
802.11g	2412	-10.42	8.00
	2437	-10.48	8.00
	2462	-11.4	8.00
802.11n ht20	2412	-10.9	8.00
	2437	-10.47	8.00
	2462	-11.04	8.00
BLE	2402	-8.74	8.00
	2440	-8.00	8.00
	2480	-8.08	8.00

Maximum power spectral density

802.11b  
Lowest Channel

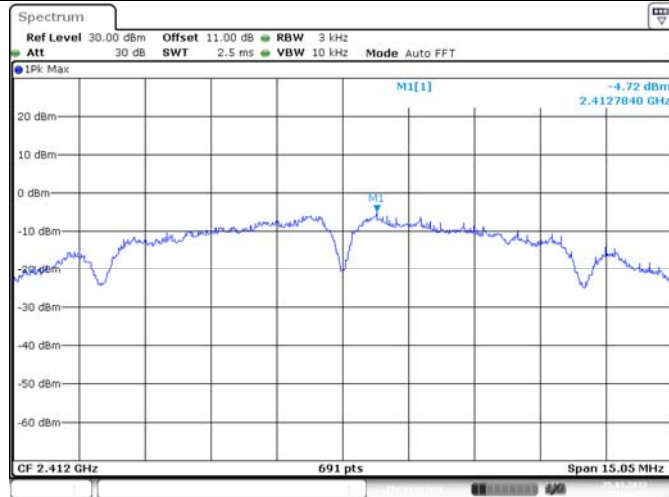

Date: 25 MAR 2022 11:23:30

802.11b  
Middle Channel

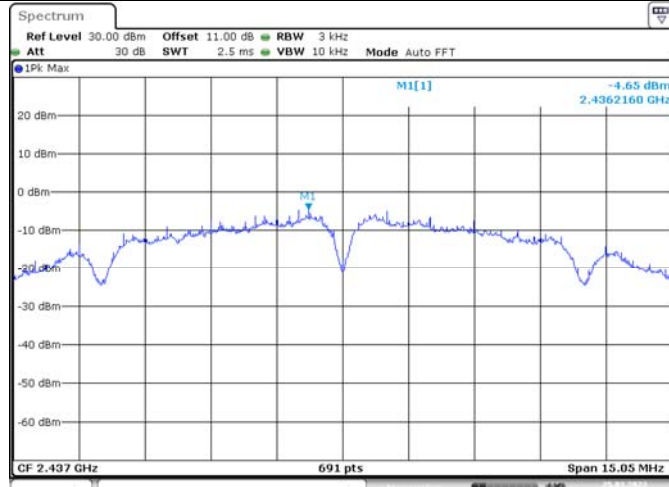

Date: 25 MAR 2022 11:25:00

802.11b  
Highest Channel



Date: 25 MAR 2022 11:26:25

### Maximum power spectral density

802.11g  
Lowest Channel

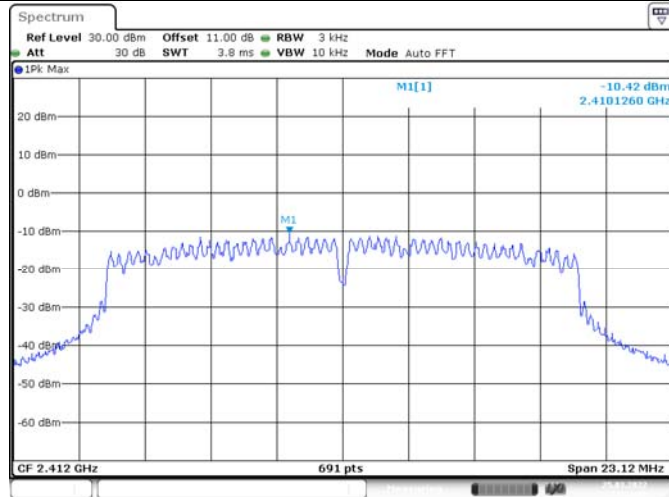

Date: 25 MAR 2022 11:31:06

802.11g  
Middle Channel

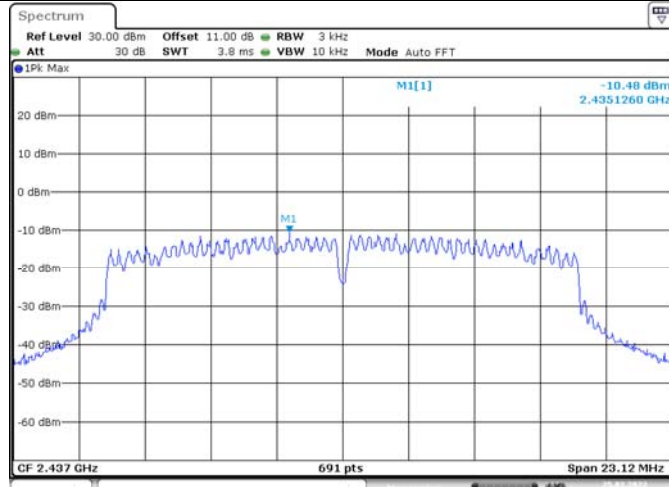

Date: 25 MAR 2022 11:29:38

802.11g  
Highest Channel

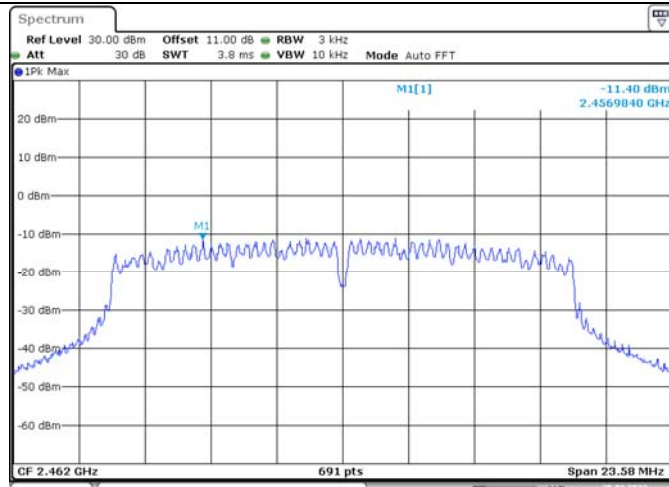

Date: 25 MAR 2022 11:27:45

**Maximum power spectral density**

802.11n ht20  
Lowest Channel

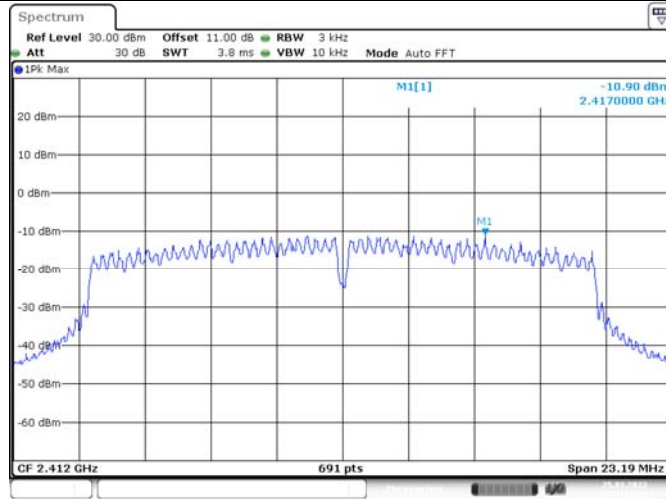

Date: 25 MAR 2022 11:32:35

802.11n ht20  
Middle Channel

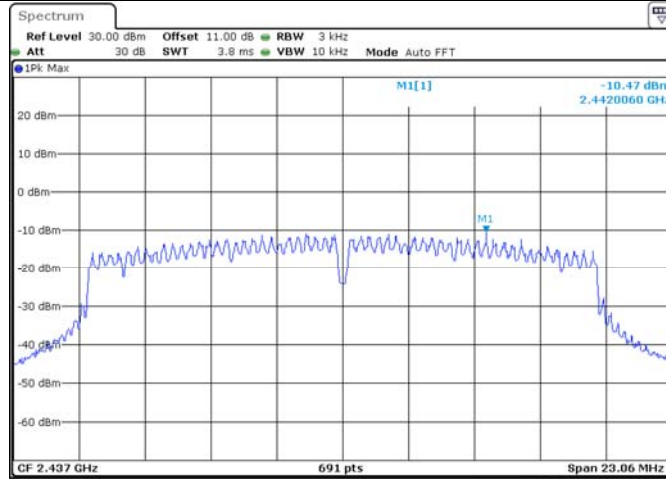

Date: 25 MAR 2022 11:34:57

802.11n ht20  
Highest Channel

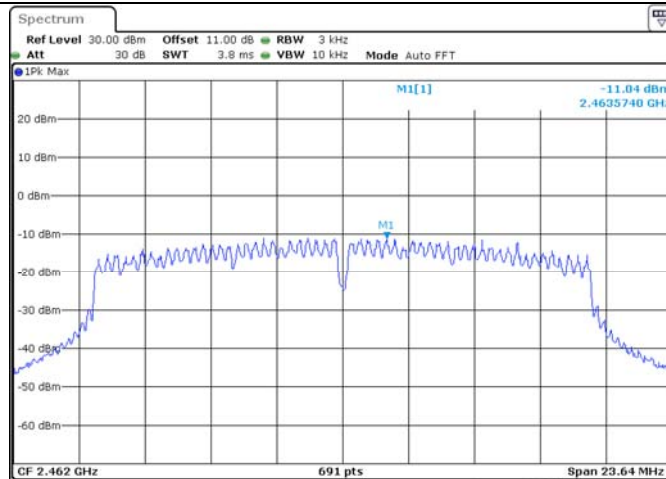

Date: 25 MAR 2022 11:36:44

### Maximum power spectral density

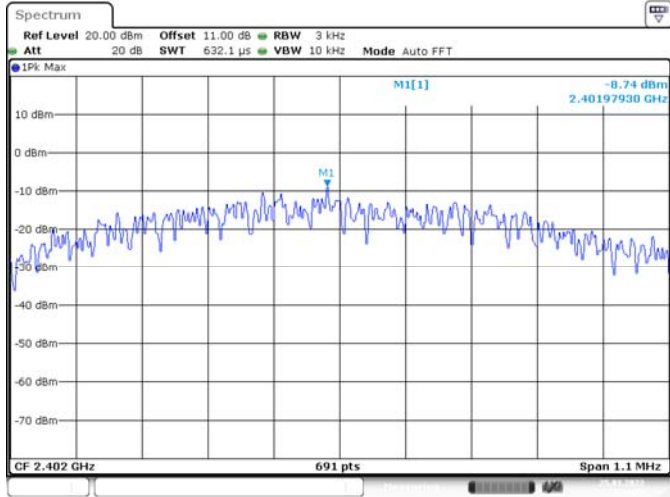
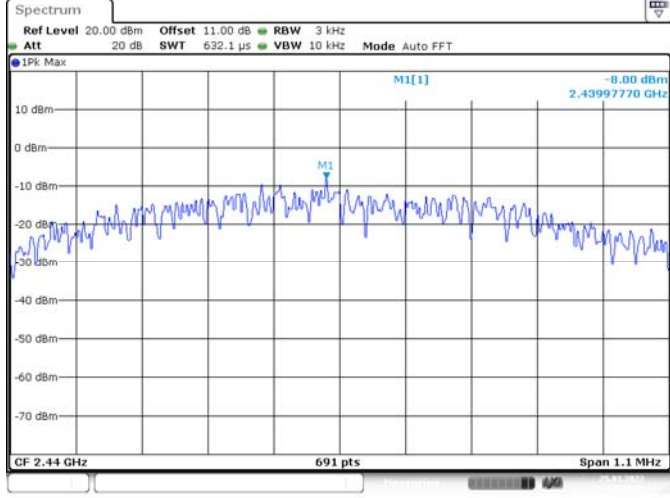
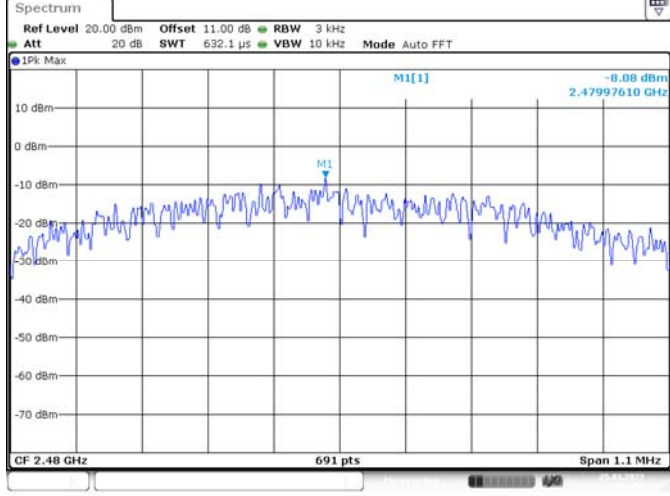
<p>BLE Lowest Channel</p>	 <p>The spectrum plot shows a noisy signal centered around 2.402 GHz. The y-axis represents power spectral density in dBm, ranging from -70 to 10. A peak is marked at -8.74 dBm at 2.40197930 GHz. The plot includes parameters: Ref Level 20.00 dBm, Att 20 dB, Offset 11.00 dB, RBW 3 kHz, Mode Auto FFT, and Span 1.1 MHz.</p>
<p>BLE Middle Channel</p>	 <p>The spectrum plot shows a noisy signal centered around 2.44 GHz. The y-axis represents power spectral density in dBm, ranging from -70 to 10. A peak is marked at -8.00 dBm at 2.43997770 GHz. The plot includes parameters: Ref Level 20.00 dBm, Att 20 dB, Offset 11.00 dB, RBW 3 kHz, Mode Auto FFT, and Span 1.1 MHz.</p>
<p>BLE Highest Channel</p>	 <p>The spectrum plot shows a noisy signal centered around 2.48 GHz. The y-axis represents power spectral density in dBm, ranging from -70 to 10. A peak is marked at -8.08 dBm at 2.47997610 GHz. The plot includes parameters: Ref Level 20.00 dBm, Att 20 dB, Offset 11.00 dB, RBW 3 kHz, Mode Auto FFT, and Span 1.1 MHz.</p>

**4.6 100 kHz Bandwidth of Frequency Band Edge:**

Serial Number:	CR22010036-RF-S1	Test Date:	2022-03-25
Test Site:	RF	Test Mode:	Transmitting
Tester:	Mark Wang	Test Result:	Pass

Environmental Conditions:					
Temperature: (°C)	25.9	Relative Humidity: (%)	60	ATM Pressure: (kPa)	100.2

**Test Equipment List and Details:**

Manufacturer	Description	Model	Serial Number	Calibration Date	Calibration Due Date
R&S	Spectrum Analyzer	FSV40	101943	2021-10-10	2022-10-09
zhuoxiang	Coaxial Cable	SMA-178	211001	Each time	N/A
eastsheep	Coaxial Attenuator	2W-SMA-JK-18G	21060301	2021-08-08	2022-08-07
HuiXunDa	DC Block	SMA-JK 18G	DCB181108042	2022-01-21	2023-01-20

*\* Statement of Traceability: China Certification ICT Co., Ltd (Dongguan) attests that all calibrations have been performed, traceable to National Primary Standards and International System of Units (SI).*

### 100 kHz Bandwidth of Frequency Band Edge

802.11b  
Lowest Band edge

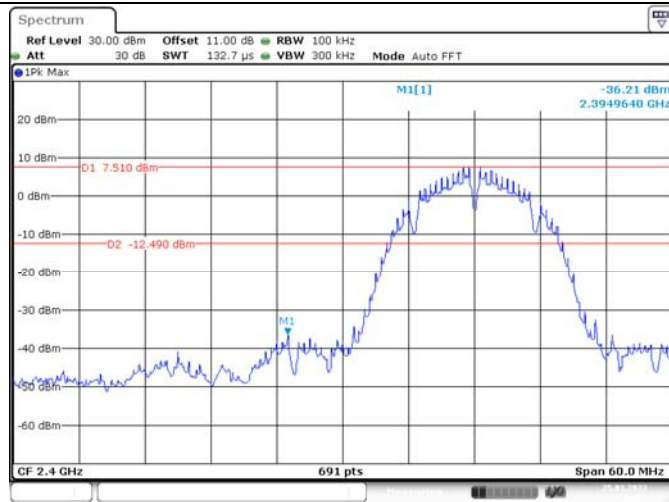

Date: 25 MAR 2022 10:56:03

802.11b  
Highest Band edge

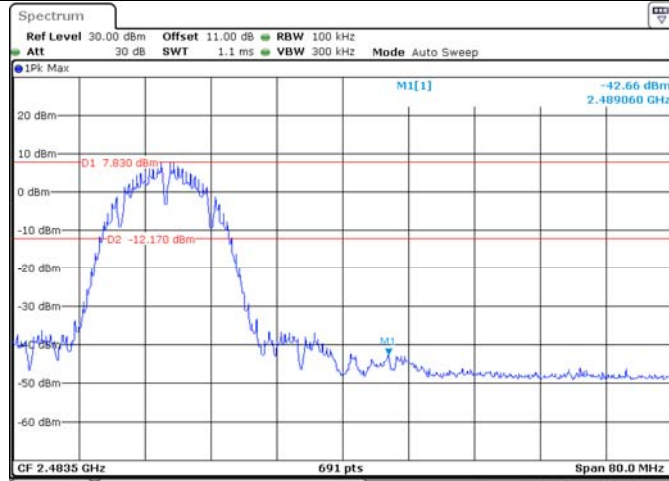

Date: 25 MAR 2022 11:15:44

### 100 kHz Bandwidth of Frequency Band Edge

802.11g  
Lowest Band edge

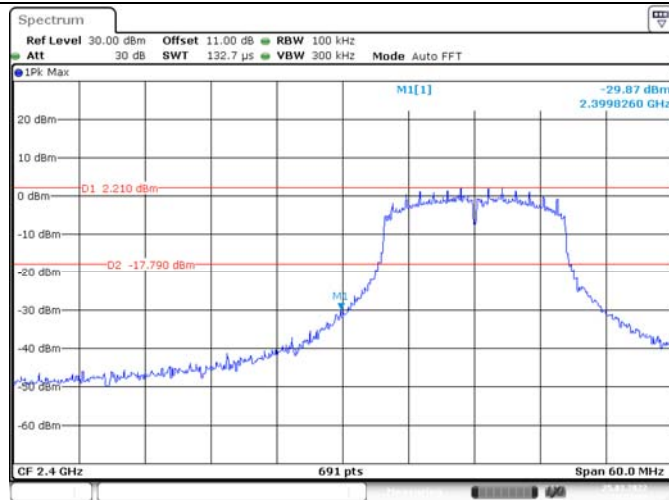

Date: 25 MAR 2022 10:57:44

802.11g  
Highest Band edge

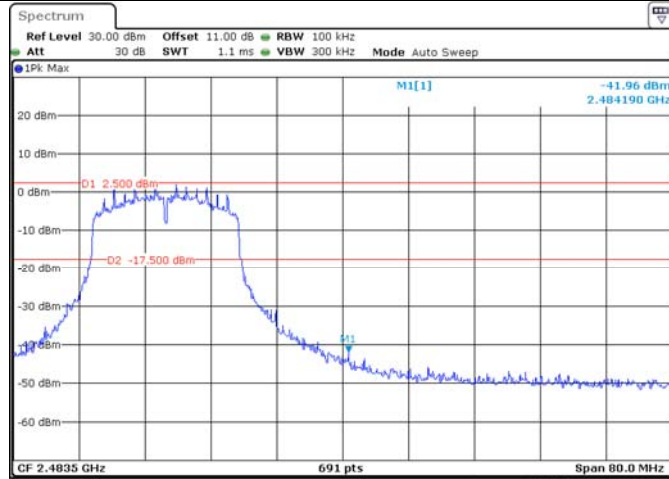

Date: 25 MAR 2022 11:01:29



### 100 kHz Bandwidth of Frequency Band Edge

802.11n ht20  
Lowest Band edge

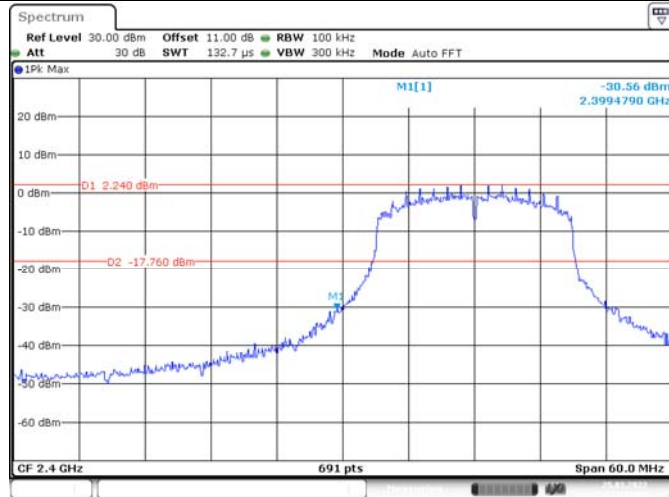

Date: 25 MAR 2022 11:00:08

802.11n ht20  
Highest Band edge

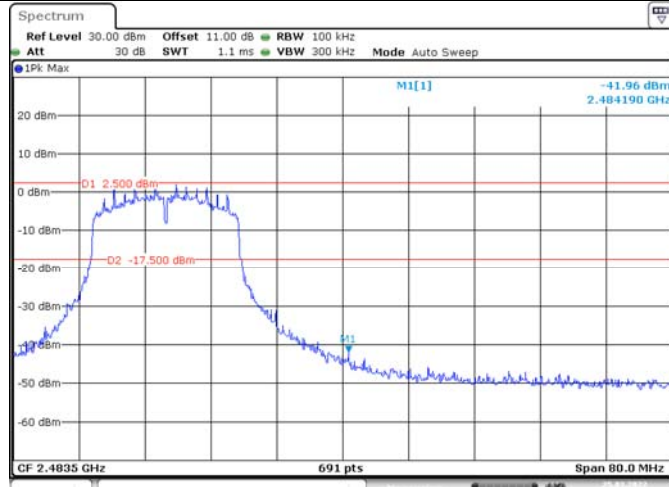

Date: 25 MAR 2022 11:01:29

### 100 kHz Bandwidth of Frequency Band Edge

BLE  
Lowest Band edge

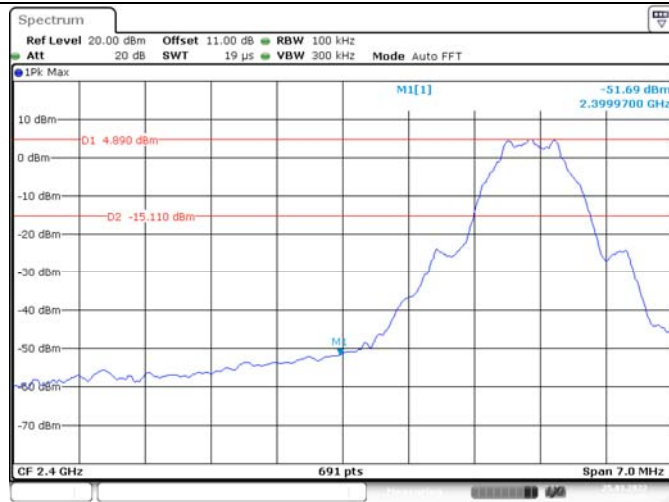

BLE  
Highest Band edge

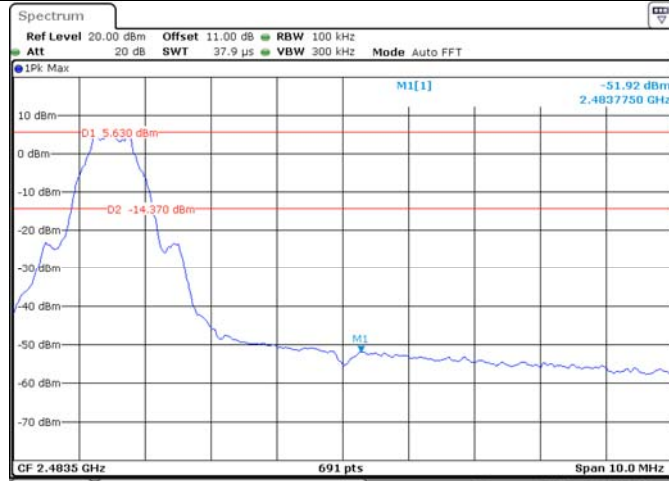

**4.7 Duty Cycle:**

Serial Number:	CR22010036-RF-S1	Test Date:	2022-03-25
Test Site:	RF	Test Mode:	Transmitting
Tester:	Mark Wang	Test Result:	Pass

**Environmental Conditions:**

Temperature: (°C)	25.9	Relative Humidity: (%)	60	ATM Pressure: (kPa)	100.2
----------------------	------	------------------------------	----	------------------------	-------

**Test Equipment List and Details:**

Manufacturer	Description	Model	Serial Number	Calibration Date	Calibration Due Date
R&S	Spectrum Analyzer	FSV40	101943	2021-10-10	2022-10-09
zhuoxiang	Coaxial Cable	SMA-178	211001	Each time	N/A
eastsheep	Coaxial Attenuator	2W-SMA-JK-18G	21060301	2021-08-08	2022-08-07
HuiXunDa	DC Block	SMA-JK 18G	DCB181108042	2022-01-21	2023-01-20

*\* Statement of Traceability: China Certification ICT Co., Ltd (Dongguan) attests that all calibrations have been performed, traceable to National Primary Standards and International System of Units (SI).*

**Test Data:**

Test Modes	Ton (ms)	Ton+off (ms)	Duty cycle (%)
802.11b	100	100	100.00
802.11g	100	100	100.00
802.11n ht20	100	100	100.00
BLE	0.42	0.62	67.74

### Duty Cycle

802.11b

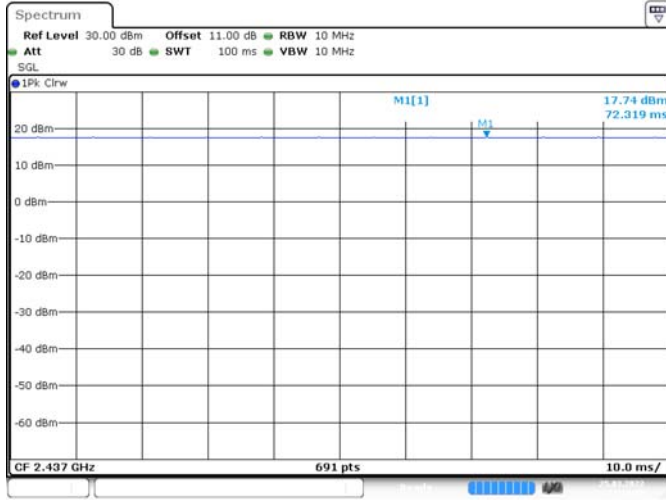

Date: 25 MAR 2022 11:18:18

802.11g

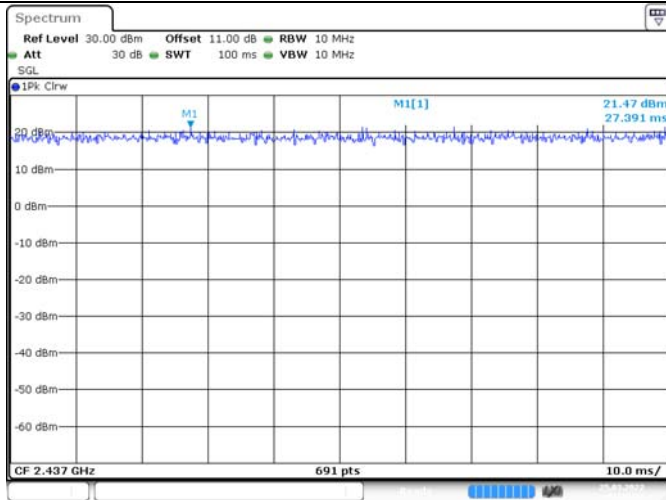

Date: 25 MAR 2022 11:19:41

802.11n ht20

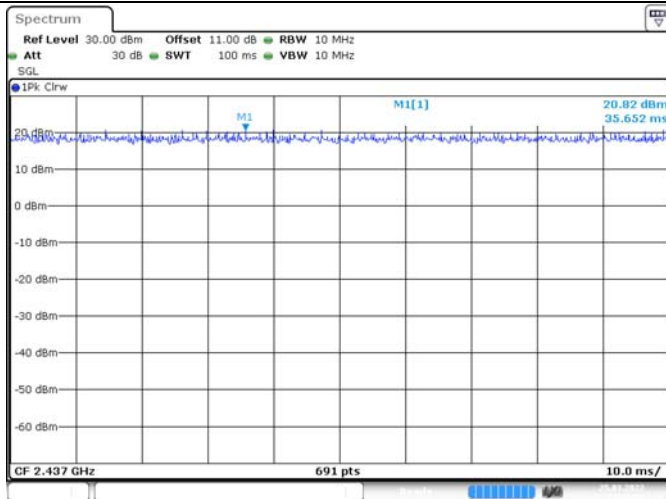

Date: 25 MAR 2022 11:20:44

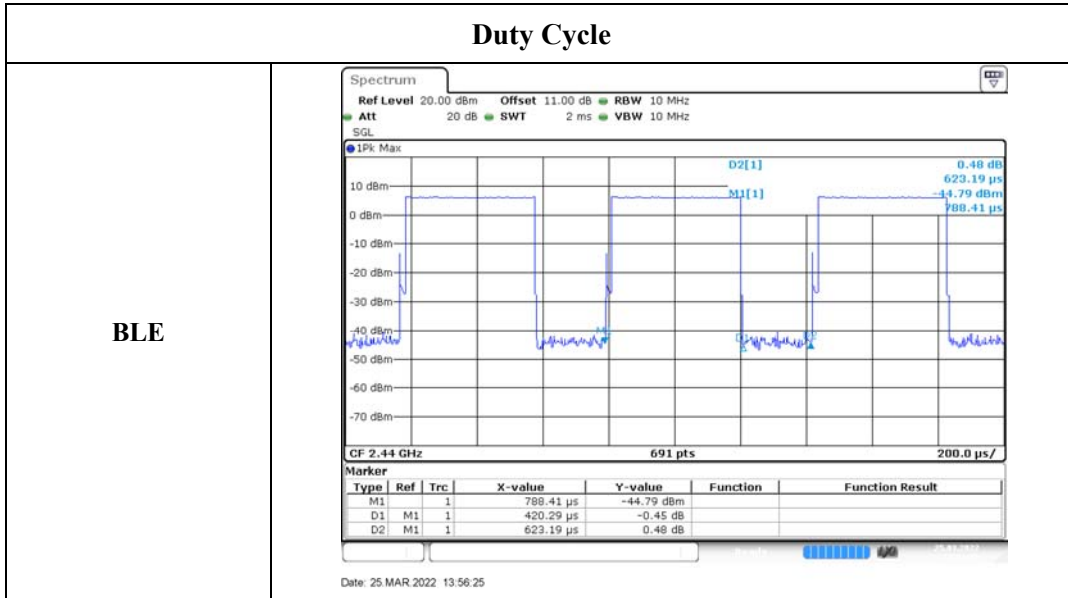

## 5. RF EXPOSURE EVALUATION

### 5.1 MAXIMUM PERMISSIBLE EXPOSURE (MPE)

#### 5.1.1 Applicable Standard

FCC §15.247 (i) & §1.1310 & §2.1091

Systems operating under the provisions of this section shall be operated in a manner that ensures that the public is not exposed to radio frequency energy levels in excess of the Commission's guidelines. See §1.1307(b)(1) of this chapter.

Limits for Maximum Permissible Exposure (MPE) (§1.1310, §2.1091)

(B) Limits for General Population/Uncontrolled Exposure				
Frequency Range (MHz)	Electric Field Strength (V/m)	Magnetic Field Strength (A/m)	Power Density (mW/cm <sup>2</sup> )	Averaging Time (minutes)
0.3–1.34	614	1.63	*(100)	30
1.34–30	824/f	2.19/f	*(180/f <sup>2</sup> )	30
30–300	27.5	0.073	0.2	30
300–1500	/	/	f/1500	30
1500–100,000	/	/	1.0	30

f = frequency in MHz; \* = Plane-wave equivalent power density;

According to §1.1310 and §2.1091 RF exposure is calculated.

#### 5.1.2 Procedure

Prediction of power density at the distance of the applicable MPE limit

$S = PG/4\pi R^2$  = power density (in appropriate units, e.g. mW/cm<sup>2</sup>);

P = power input to the antenna (in appropriate units, e.g., mW);

G = power gain of the antenna in the direction of interest relative to an isotropic radiator, the power gain factor, is normally numeric gain;

R = distance to the center of radiation of the antenna (appropriate units, e.g., cm);

#### 5.1.3 Calculated Result

Operation Modes	Frequency (MHz)	Antenna Gain		Conducted output power including Tune-up Tolerance		Evaluation Distance (cm)	Power Density (mW/cm <sup>2</sup> )	MPE Limit (mW/cm <sup>2</sup> )
		(dBi)	(numeric)	(dBm)	(mW)			
BDR/EDR	2402-2480	1.86	1.53	10	10.00	20	0.0030	1.0
BLE	2402-2480	1.86	1.53	8	6.31	20	0.0019	1.0
Wi-Fi	2412-2462	1.86	1.53	22	158.49	20	0.0482	1.0

Note: The Wi-Fi and Bluetooth can't transmit simultaneously.

**Result:** The device meet FCC MPE at 20 cm distance.

===== **END OF REPORT** =====