



尚远科技 (中国) 有限公司
sunnyway Technology (china) Co., LTD.

Test report

测试仪器	CMW500
场地	上海尚远科技
签名	包嘉铭

Information:	
Manufacturer	Shanghai Sunmi Technology Co.,Ltd./商米
Model Name	BL260/电子价签2.6寸
Date	2022/5/6
Designer	年孟伟
Serial Number/ESN/IMEI	N/A
Band:	WIFI2.4G

防止漏看, 查看报告请往下翻页, 直到出现thanks

Matching Circuit:

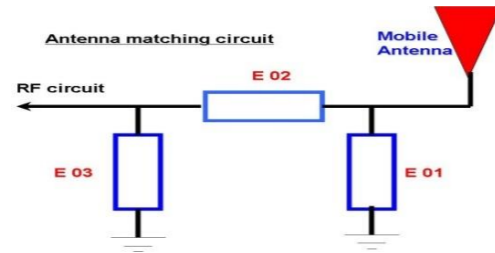

Element	Value	WIFI天线		
E1(0402)	0.75pF			
E2(0402)	0oum			
E3(0402)	N/A			

项目图片

天线版本及图片

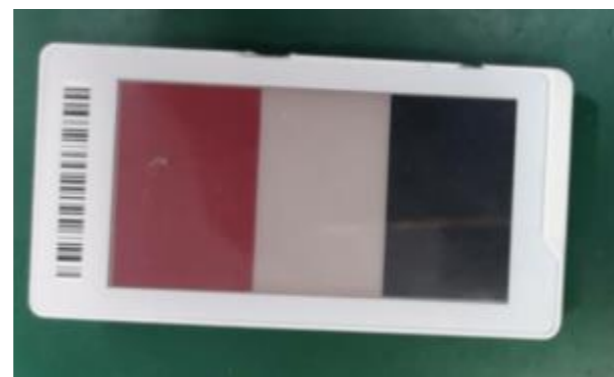

测试数据:



天线效率

Freq	Effi	Gain
------	------	------

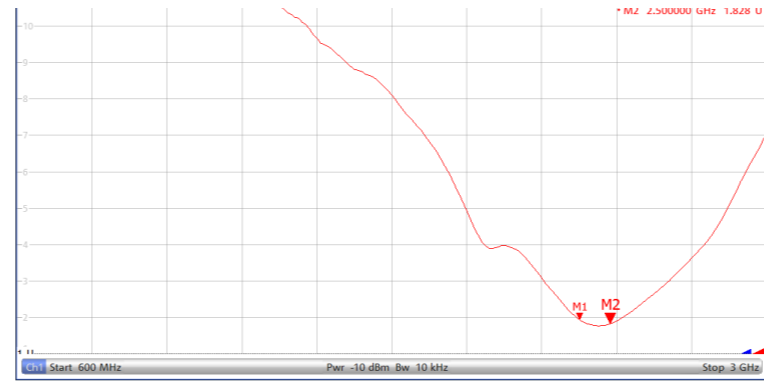
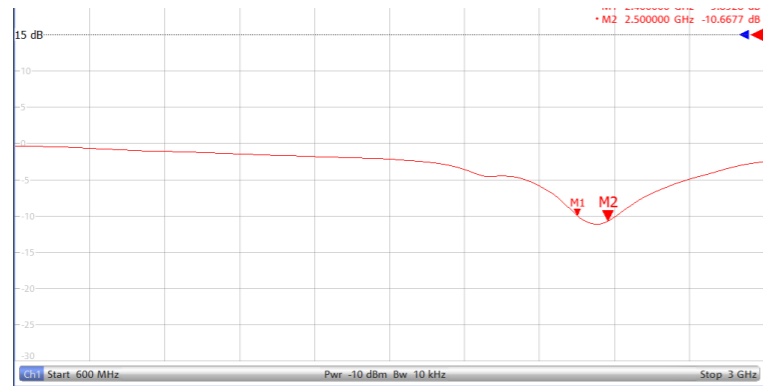

(MHz)	(%)	(dBi)
2400	28.86	-0.59
2410	28.2	-0.73
2420	28.71	-0.82
2430	29.76	-0.87
2440	29.97	-0.81
2450	29.55	-0.5
2460	29.38	-0.78
2470	28.56	-1.14
2480	29.05	-1.53
2490	29.5	-1.32
2500	28.87	-1.51

2400.000MHz

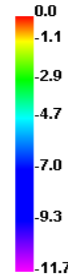
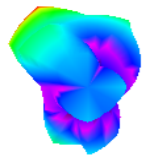

2400.000MHz H

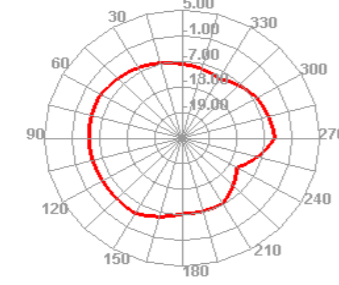

2450.000MHz

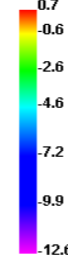
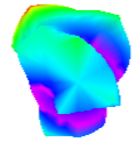

2450.000MHz H

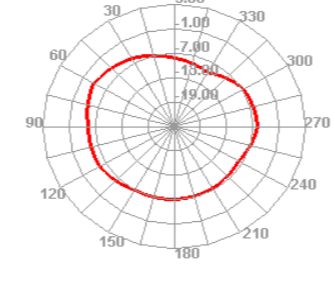

2500.000MHz

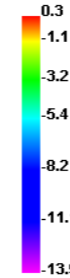
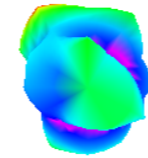

2500.000MHz H

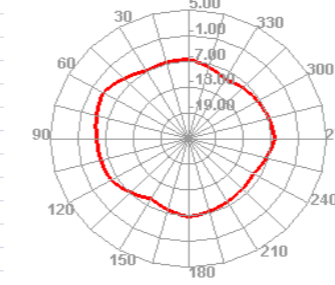

2400.000MHz E1

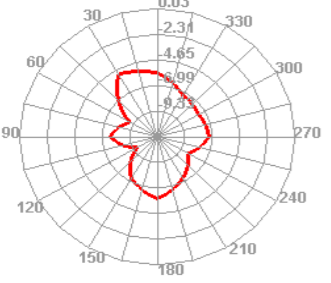

2400.000MHz E2

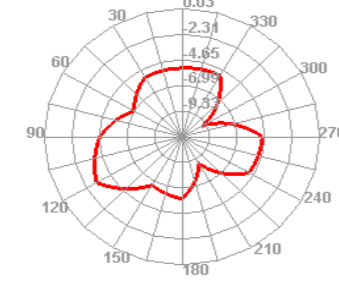

2450.000MHz E1

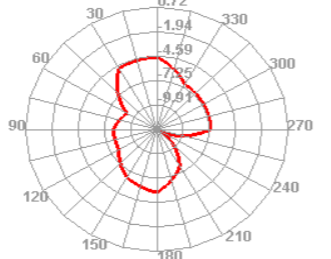

2450.000MHz E2

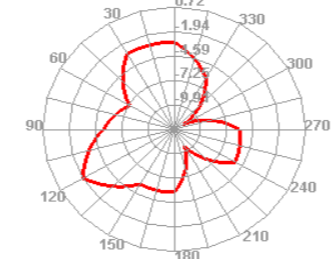

2500.000MHz E1

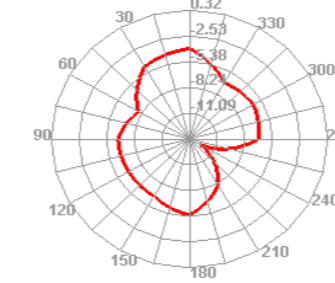

2500.000MHz E2

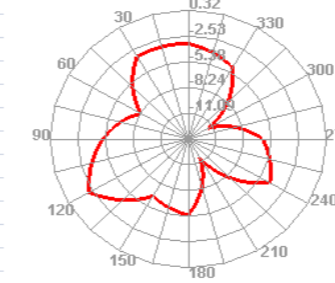

NFC调试:

样机S11



标准板

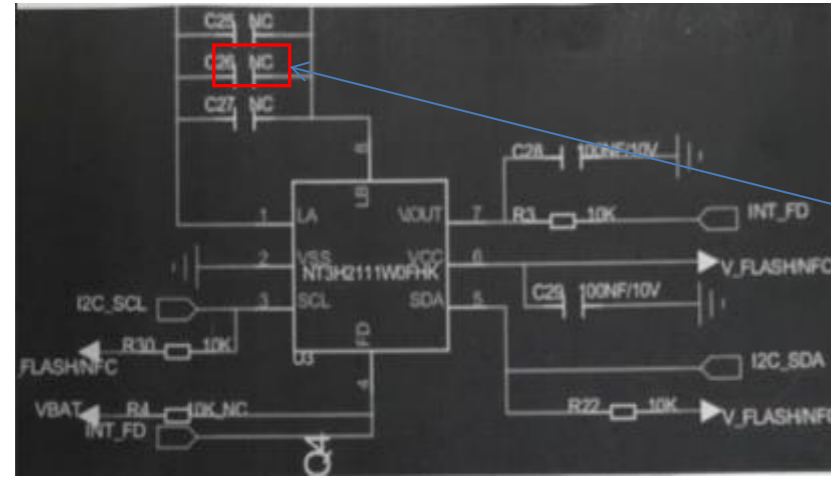

C26匹配18pF (0201)

NFC读卡距离

测试机器 (华为P20)	读卡距离	
	标准板	电子价签
	22mm	20mm

环境处理

未增加环境处理

总结

THANKS !