

FCC Test Report

Product Name	BF-IDU07
Model No.	BIS U-620-068-111-00-S115, BIS U-620-068-111-00-ST29, BIS U-626-069-111-06-ST31, BIS U-626-069-111-06-ST32
FCC ID.	2AGZY-BFIDU07

Applicant	Balluff GmbH
Address	Schurwaldstrasse 9, Neuhausen a.d.F. 73765, Germany

Date of Receipt	Dec. 19, 2019
Issued Date	Jan. 25, 2021
Report No.	19C0313R-RFUSP23V00
Report Version	V1.0



The test results relate only to the samples tested.

The test results shown in the test report are traceable to the national/international standard through the calibration report of the equipment and evaluated measurement uncertainty herein.

This report must not be used to claim product endorsement by TAF or any agency of the government.

The test report shall not be reproduced without the written approval of DEKRA Testing and Certification Co., Ltd.

Measurement uncertainties evaluated for each testing system and associated connections are given here to provide the system information for reference. Compliance determinations do not take into account measurement uncertainties for each testing system, but are based on the results of the compliance measurement.

Test Report

Issued Date: Jan. 25, 2021

Report No.: 19C0313R-RFUSP23V00



Product Name	BF-IDU07
Applicant	Balluff GmbH
Address	Schurwaldstrasse 9, Neuhausen a.d.F. 73765, Germany
Manufacturer	Balluff GmbH
Model No.	BIS U-620-068-111-00-S115, BIS U-620-068-111-00-ST29, BIS U-626-069-111-06-ST31, BIS U-626-069-111-06-ST32
FCC ID.	2AGZY-BFIDU07
EUT Rated Voltage	DC 24V (Power by Supply)
EUT Test Voltage	DC 24V (Power by Supply)
Trade Name	BALLUFF
Applicable Standard	FCC CFR Title 47 Part 15 Subpart C ANSI C63.4: 2014, ANSI C63.10: 2013
Test Result	Complied

Documented By :



(Senior Adm. Specialist / Joanne Lin)

Tested By :

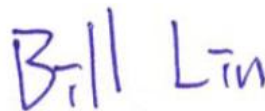

(Senior Engineer / Bill Lin)

Approved By :



(Director / Vincent Lin)

TABLE OF CONTENTS

Description	Page
1. GENERAL INFORMATION	5
1.1. EUT Description.....	5
1.2. Tested System Details.....	7
1.3. Configuration of Tested System	8
1.4. EUT Exercise Software	12
1.5. Test Facility	13
1.6. List of Test Equipment.....	14
1.7. Uncertainty	15
2. CONDUCTED EMISSION	16
2.1. Test Setup	16
2.2. Limits.....	16
2.3. Test Procedure	17
2.4. Test Result of Conducted Emission	18
3. PEAK POWER OUTPUT	26
3.1. Test Setup	26
3.2. Limit	26
3.3. Test Procedure	26
3.4. Test Result of Peak Power Output	27
4. RADIATED EMISSION	28
4.1. Test Setup	28
4.2. Limits.....	29
4.3. Test Procedure	30
4.4. Test Result of Radiated Emission	31
5. RF ANTENNA CONDUCTED TEST	45
5.1. Test Setup	45
5.2. Limits.....	45
5.3. Test Procedure	45
5.4. Test Result of RF Antenna Conducted Test	46
6. BAND EDGE	47
6.1. Test Setup	47
6.2. Limit	48
6.3. Test Procedure	48
6.4. Test Result of Band Edge	49
7. CHANNEL NUMBER.....	51
7.1. Test Setup	51
7.2. Limit	51
7.3. Test Procedure	51
7.4. Test Result of Channel Number.....	52
8. CHANNEL SEPARATION.....	53
8.1. Test Setup	53
8.2. Limit	53
8.3. Test Procedure	53
8.4. Test Result of Channel Separation.....	54
9. DWELL TIME.....	56
9.1. Test Setup	56
9.2. Limit	56
9.3. Test Procedure	56
9.4. Test Result of Dwell Time	57
10. OCCUPIED BANDWIDTH	59
10.1. Test Setup	59
10.2. Limits.....	59
10.3. Test Procedure	59
10.4. Test Result of Occupied Bandwidth	60
11. DUTY CYCLE.....	62
11.1. Test Setup	62
11.2. Test Result of Duty Cycle.....	63
12. EMI REDUCTION METHOD DURING COMPLIANCE TESTING	64

Attachment 1: EUT Test Photographs

Attachment 2: EUT Detailed Photographs

Revision History

Report No.	Version	Description	Issued Date
19C0313R-RFUSP23V00	V1.0	Initial issue of report.	2020-11-12

1. GENERAL INFORMATION

1.1. EUT Description

Product Name	BF-IDU07
Trade Name	BALLUFF
Model No.	BIS U-620-068-111-00-S115, BIS U-620-068-111-00-ST29, BIS U-626-069-111-06-ST31, BIS U-626-069-111-06-ST32
FCC ID.	2AGZY-BFIDU07
Frequency Range	902.75-927.25MHz
Channel Number	50
Type of Modulation	FHSS:ASK
Antenna Type	Patch Antenna
Channel Control	Auto
Antenna Gain	Refer to the table "Antenna List"

Antenna List

No.	Manufacturer	Product No.	Antenna Type	Peak Gain	Peak Gain
1	BALLUFF	BIS U-303-C1-TNCB	Patch Antenna	8.5dBic	5.5dBi

Note:

- (1) The antenna of EUT conforms to FCC 15.203.
- (2) Only the higher gain antenna was tested and recorded in this report.
- (3) dBi = dBic - 3

Center Frequency of Each Channel:

Channel No.	Frequency (MHz)	Channel No.	Frequency (MHz)
1	902.75	26	915.25
2	903.25	27	915.75
3	903.75	28	916.25
4	904.25	29	916.75
5	904.75	30	917.25
6	905.25	31	917.75
7	905.75	32	918.25
8	906.25	33	918.75
9	906.75	34	919.25
10	907.25	35	919.75
11	907.75	36	920.25
12	908.25	37	920.75
13	908.75	38	921.25
14	909.25	39	921.75
15	909.75	40	922.25
16	910.25	41	922.75
17	910.75	42	923.25
18	911.25	43	923.75
19	911.75	44	924.25
20	912.25	45	924.75
21	912.75	46	925.25
22	913.25	47	925.75
23	913.75	48	926.25
24	914.25	49	926.75
25	914.75	50	927.25

Note:

1. The EUT is an BF-IDU07 with built-in RFID transceiver.
2. The identification of test sample is BIS U-620-068-111-00-ST29.
3. The different of each model is shown as below:

Model No.	Interface	Digital I/O	Mainboard		Connectors	
			PCB	PCBA	PCB	PCBA
BIS U-620-068-111-00-S115	Serial RS232	No	338536	338143	338523	338105
BIS U-620-068-111-00-ST29	Serial RS232	Yes		338143	338523	338107
BIS U-626-069-111-06-ST31	Industrial Ethernet	No		338147	338525	338109
BIS U-626-069-111-06-ST32	Industrial Ethernet	Yes		338147	338525	338111
			PCB: Platine ohne Bauteile PCBA: PCB Assembled (Bestückungsvarianten)			

4. These tests were conducted on a sample for the purpose of demonstrating compliance of transmitter with Part 15 Subpart C Paragraph 15.247 for spread spectrum devices.
5. BIS U-620-068-111-00-ST29 is worst.
6. Regarding to the operation frequency, the lowest, middle and highest frequency are selected to perform the test.

Test Mode	Mode 1: Transmit
-----------	------------------

1.2. Tested System Details

The types for all equipment, plus descriptions of all cables used in the tested system (including inserted cards) are:

Model No.		BIS U-620-068-111-00-S115 BIS U-620-068-111-00-ST29 BIS U-626-069-111-06-ST31 BIS U-626-069-111-06-ST32			
Product		Manufacturer	Model No.	Serial No.	Power Cord
1	Notebook PC	DELL	Inspiron 15 3000	GT5JPJ2	N/A
2	DC Power Supply	KEYSIGHT	E36234A	MY59001234E36234A	N/A

Model No.		BIS U-620-068-111-00-S115			
Signal Cable Type		Signal Cable Description			
A	VGA Cable	Non-Shielded, 2.1m			
B	RS232 to USB Cable	Non-shielded, 0.4m			
C	Power Cable	Non-shielded, 1m			
D	Ground Cable	Non-shielded, 2.9m			

Model No.		BIS U-620-068-111-00-ST29			
Signal Cable Type		Signal Cable Description			
A	VGA Cable	Non-Shielded, 2.1m			
B	RS232 to USB Cable	Non-shielded, 0.4m			
C	Power Cable	Non-shielded, 1m			
D	Digital I/O Cable	Non-shielded, 2.2m			
E	Ground Cable	Non-shielded, 2.9m			

Model No.		BIS U-626-069-111-06-ST31			
Signal Cable Type		Signal Cable Description			
A	LAN Cable	Non-Shielded, 5.2m			
B	Power Cable	Non-shielded, 1.1m			
C	Ground Cable	Non-shielded, 2.9m			

Model No.		BIS U-626-069-111-06-ST32			
Signal Cable Type		Signal Cable Description			
A	LAN Cable	Non-Shielded, 5.2m			
B	Digital I/O Cable	Non-shielded, 2.2m			
C	Power Cable	Non-shielded, 1.1m			
D	Ground Cable	Non-shielded, 2.9m			

1.3. Configuration of Tested System

BIS U-620-068-111-00-S115 (Conducted Emission)

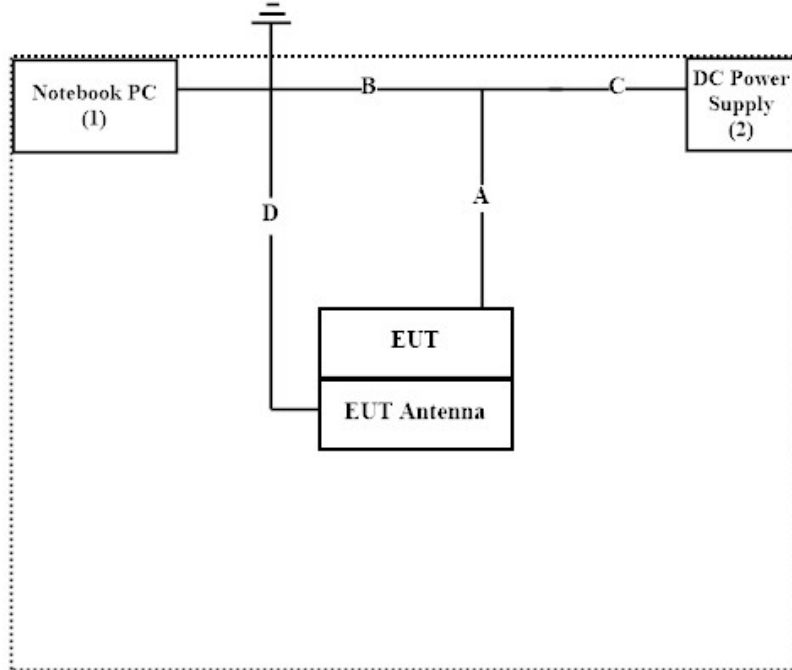

BIS U-620-068-111-00-S115 (Radiated Emission)

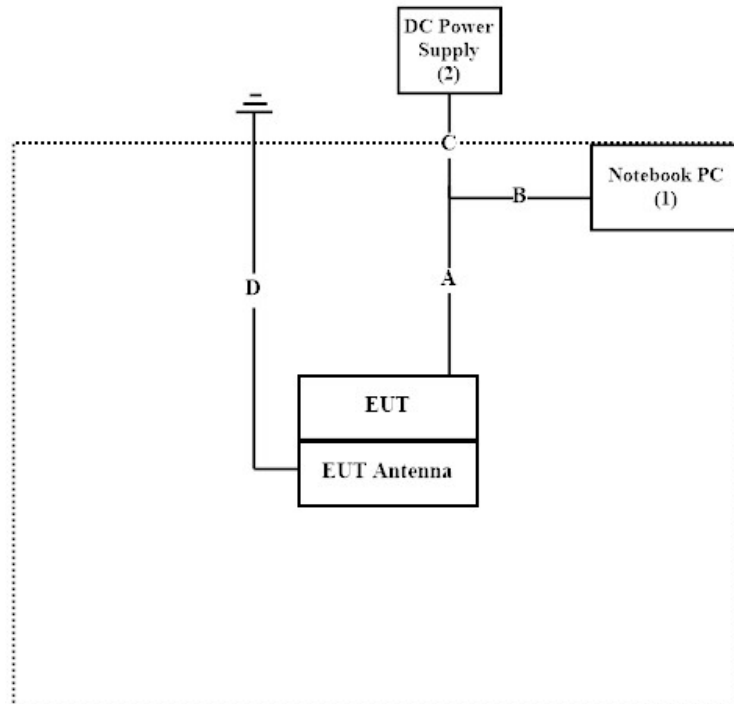

BIS U-620-068-111-00-ST29 (Conducted Emission)

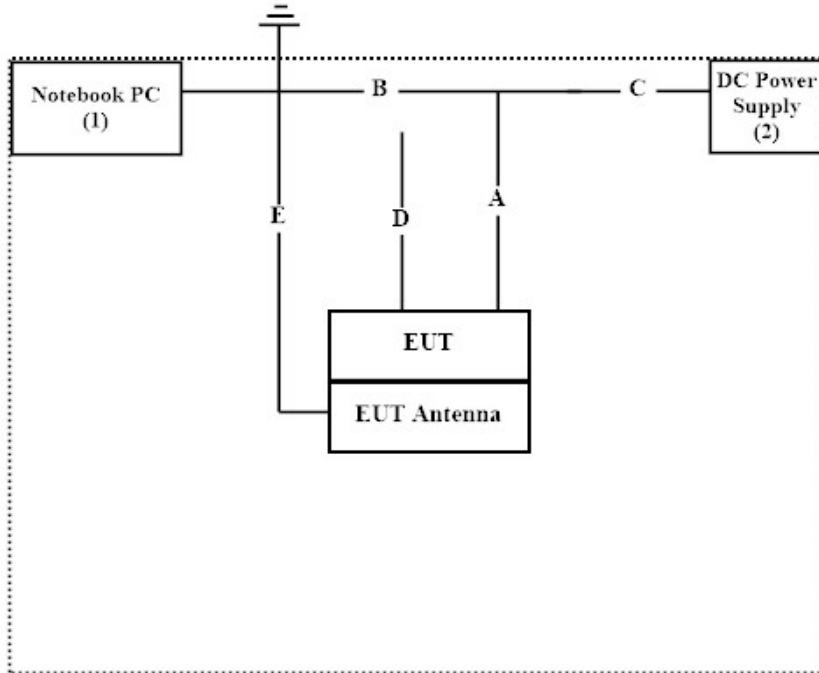

BIS U-620-068-111-00-ST29 (Radiated Emission)

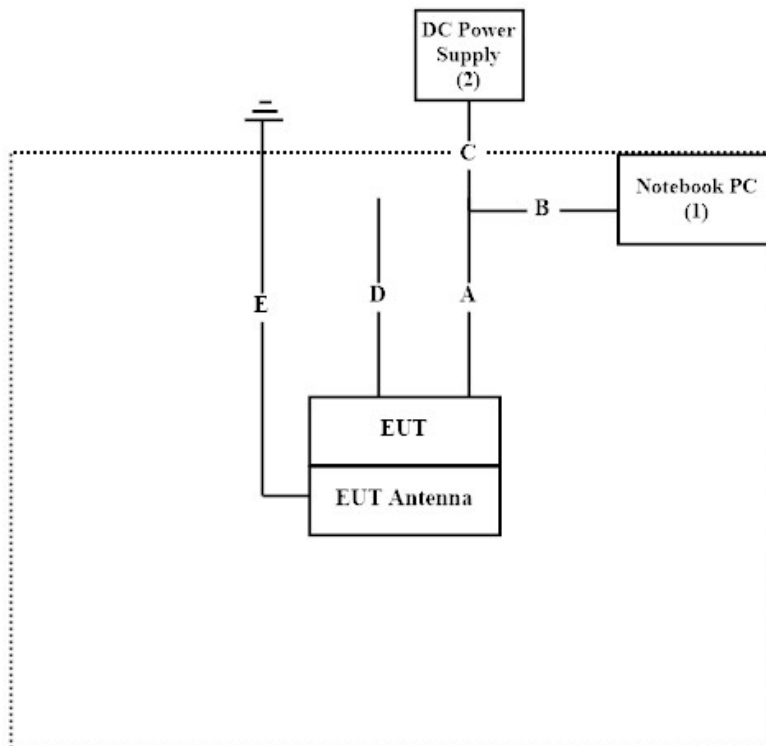

BIS U-626-069-111-06-ST31 (Conducted Emission)

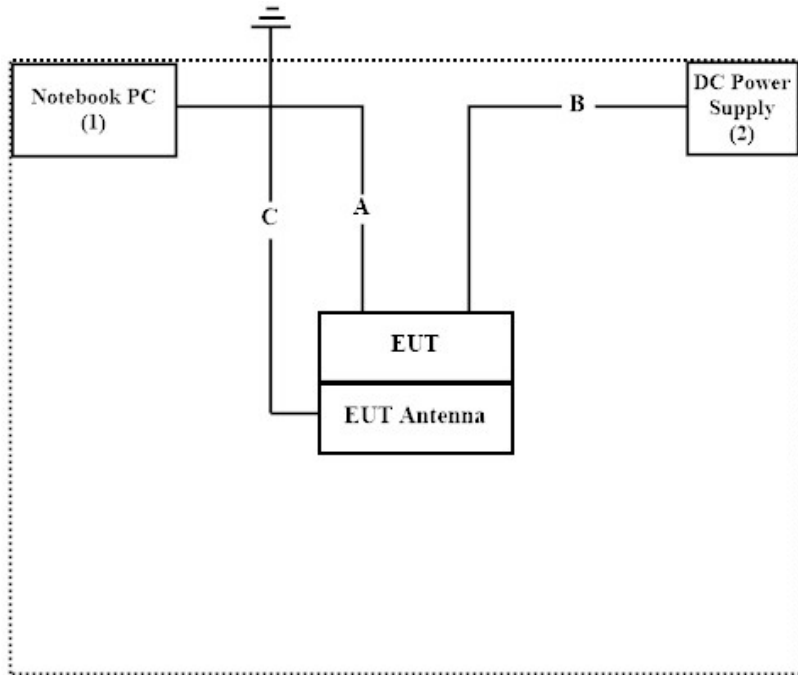

BIS U-626-069-111-06-ST31 (Radiated Emission)

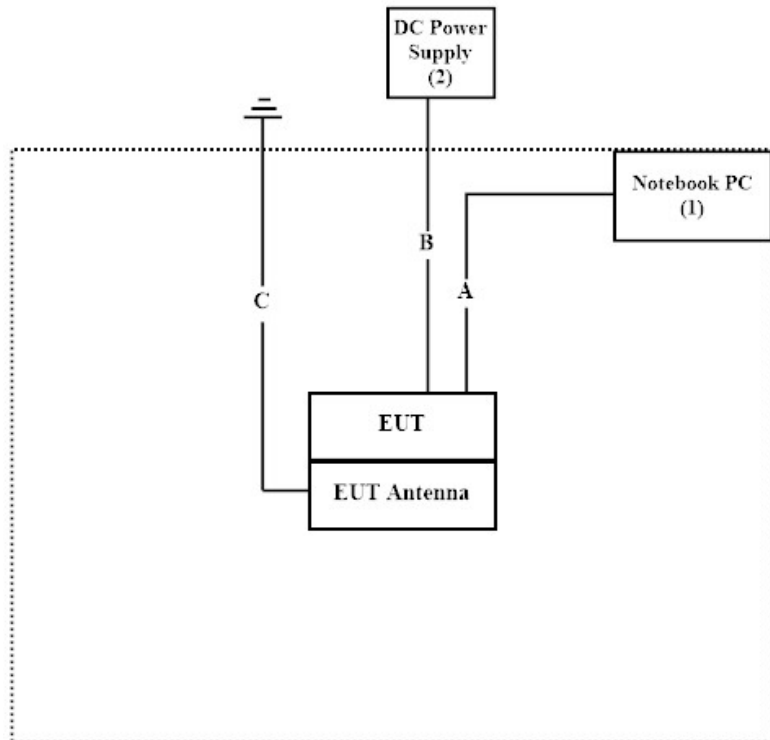

BIS U-626-069-111-06-ST32 (Conducted Emission)

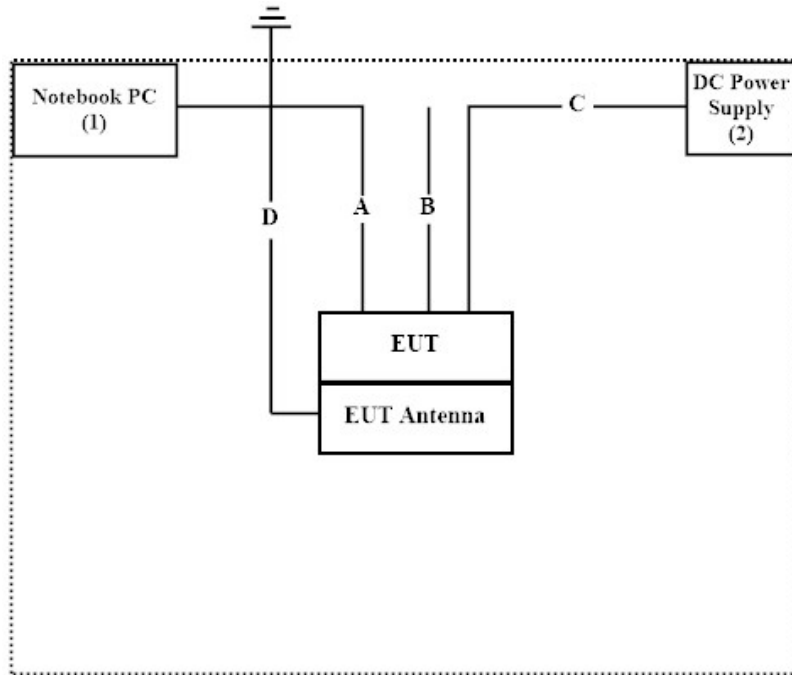

BIS U-626-069-111-06-ST32 (Radiated Emission)

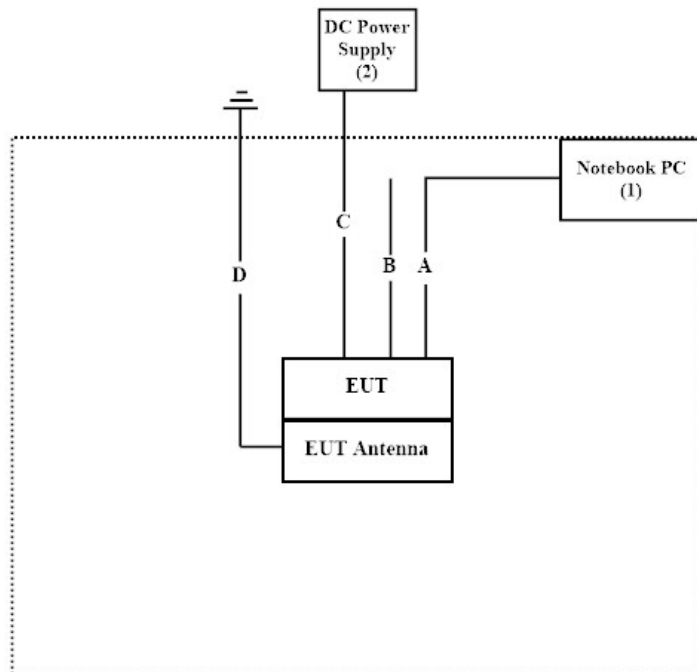

1.4. EUT Exercise Software

1. Setup the EUT as shown in Section 1.4.
2. Execute software “Dashboard Configuration Tool Version 4.6.0.5” on the Notebook PC.
3. Configure the test mode, the test channel.
4. Press “OK” to start the continuous Transmit.
5. Verify that the EUT works properly.

1.5. Test Facility

Ambient conditions in the laboratory:

Performed Item	Items	Required	Actual
Conducted Emission	Temperature (°C)	10~40 °C	22.2°C
	Humidity (%RH)	10~90 %	60.7%
Radiated Emission	Temperature (°C)	10~40 °C	24.0°C
	Humidity (%RH)	10~90 %	58.2%
Conductive	Temperature (°C)	10~40 °C	22°C
	Humidity (%RH)	10~90 %	55%

USA : FCC Registration Number: TW0023

Canada : IC Registration Number: 25880

Site Description : Accredited by TAF
Accredited Number: 3023

Test Laboratory : DEKRA Testing and Certification Co., Ltd
Address : No.159, Sec. 2, Wenhua 1st Rd., Linkou Dist.,
New Taipei City 24457, Taiwan, R.O.C.

Phone number : 886-2-2602-7968
Fax number : 866-2-2602-3286
Email address : info.tw@dekra.com
Website : <http://www.dekra.com.tw>

1.6. List of Test Equipment

For Conduction measurements /ASR1

	Equipment	Manufacturer	Model No.	Serial No.	Cali. Data	Due. Data
X	EMI Test Receiver	R&S	ESR7	101601	2020.05.28	2021.05.27
X	Two-Line V-Network	R&S	ENV216	101306	2020.03.25	2021.03.24
X	Two-Line V-Network	R&S	ENV216	101307	2020.04.17	2021.04.16
X	Coaxial Cable	DEKRA	RG400_BNC	RF001	2020.05.24	2021.05.23

Note:

1. All equipments are calibrated every one year.
2. The test instruments marked with "X" are used to measure the final test results.
3. Test Software version : DEKRA Testing System V1.2.

For Conducted measurements /ASR2

	Equipment	Manufacturer	Model No.	Serial No.	Cali. Data	Due. Data
X	Spectrum Analyzer	R&S	FSV30	103466	2019.12.16	2020.12.15
X	Peak Power Analyzer	KEYSIGHT	8900B	MY51000539	2020.05.13	2021.05.12
X	Power Sensor	KEYSIGHT	N1923A	MY59240002	2020.05.22	2021.05.21
X	Power Sensor	KEYSIGHT	N1923A	MY59240003	2020.05.22	2021.05.21
	Bluetooth Tester	R&S	CBT	101238	2020.02.10	2021.02.11

Note:

1. All equipments are calibrated every one year.
2. The test instruments marked with "X" are used to measure the final test results.
3. Test Software version : DEKRA Conduction Test System V9.0.5.

For Radiated measurements /ACB1

	Equipment	Manufacturer	Model No.	Serial No.	Cali. Data	Due. Data
X	Loop Antenna	AMETEK	HLA6121	49611	2020.03.16	2021.03.15
X	Bi-Log Antenna	SCHWARZBECK	VULB9168	9168-953	2020.01.03	2021.01.02
X	Horn Antenna	ETS-Lindgren	3117	00203800	2019.12.12	2020.12.11
	Horn Antenna	Com-Power	AH-840	101087	2020.06.08	2021.06.07
X	Pre-Amplifier	EMCI	EMC001330	980316	2020.06.23	2021.06.22
X	Pre-Amplifier	EMCI	EMC051835SE	980311	2020.06.23	2021.06.22
	Pre-Amplifier	EMCI	EMC05820SE	980310	2020.06.24	2021.06.23
	Pre-Amplifier	EMCI	EMC184045SE	980314	2020.06.10	2021.06.09
	Filter	MICRO TRONICS	BRM50702	G251	2020.09.17	2021.09.16
	Filter	MICRO TRONICS	BRM50716	G188	2020.09.17	2021.09.16
X	EMI Test Receiver	R&S	ESR7	101602	2019.12.16	2020.12.15
X	Spectrum Analyzer	R&S	FSV40	101148	2020.03.16	2021.03.15
X	Coaxial Cable	SUHNER	SUCOFLEX 106	RF002	2020.07.03	2021.07.02
	Mircoflex Cable	HUBER SUHNER	SUCOFLEX 102	MY3381/2	2020.06.10	2021.06.09

Note:

1. All equipments are calibrated every one year.
2. The test instruments marked with "X" are used to measure the final test results.
3. Test Software version : DEKRA Testing System V1.2.

1.7. Uncertainty

Uncertainties have been calculated according to the DEKRA internal document, and is described in each test chapter of this report.

The reported expanded uncertainties are based on a standard uncertainty multiplied by a coverage factor of $k=2$, providing a level of confidence of approximately 95%.

Measurement uncertainties evaluated for each testing system and associated connections are given here to provide the system information for reference. Compliance determinations do not take into account measurement uncertainties for each testing system, but are based on the results of the compliance measurement.

Test item	Uncertainty	
Conducted Emission	±3.42 dB	
Peak Power Output	Power Meter ±0.91 dB	
Radiated Emission	Under 1GHz ±4.06 dB	Above 1GHz ±3.73 dB
RF Antenna Conducted Test	±2.53 dB	
Band Edge	Under 1GHz ±4.06 dB	Above 1GHz ±3.73 dB
Channel Number	±682.83 Hz	
Channel Separation	±2.53 dB	
Dwell Time	±2.31 ms	
Occupied Bandwidth	±682.83 Hz	
Duty Cycle	±2.31 ms	

2. Conducted Emission

2.1. Test Setup

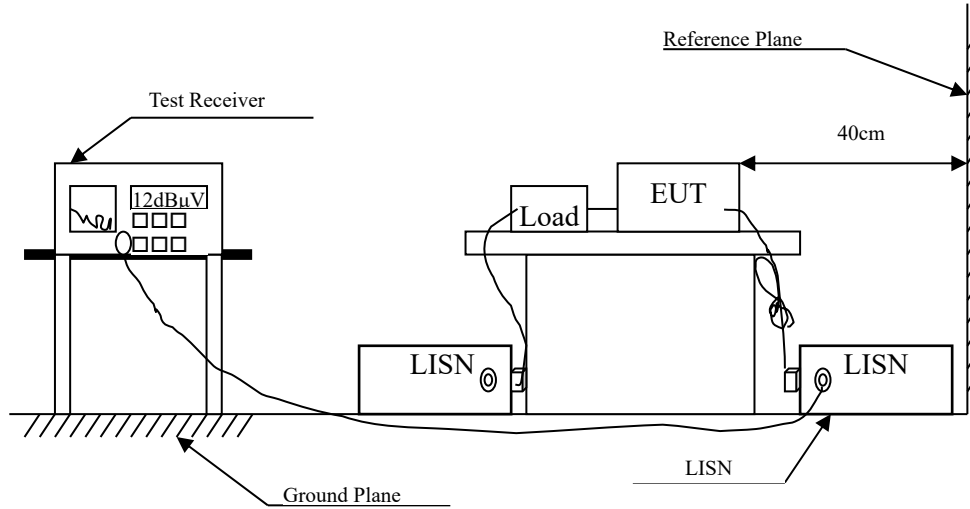

2.2. Limits

FCC Part 15 Subpart C Paragraph 15.207 (dB μ V) Limit		
Frequency MHz	Limits	
	QP	AV
0.15 - 0.50	66-56	56-46
0.50-5.0	56	46
5.0 - 30	60	50

Remarks: In the above table, the tighter limit applies at the band edges.

2.3. Test Procedure

The EUT and Peripherals are connected to the main power through a line impedance stabilization network (L.I.S.N.). This provides a 50 ohm /50uH coupling impedance for the measuring equipment. The peripheral devices are also connected to the main power through a LISN that provides a 50ohm /50uH coupling impedance with 50ohm termination. (Please refer to the block diagram of the test setup and photographs.)

Both sides of A.C. line are checked for maximum conducted interference. In order to find the maximum emission, the relative positions of equipment and all the interface cables must be changed according to ANSI C63.4: 2014 on conducted measurement.

Conducted emissions were investigated over the frequency range from 0.15MHz to 30MHz using a receiver bandwidth of 9kHz.

The EUT setup and the test procedure are according to ANSI C63.4, 2014 to comply with the requirements of FCC 47CFR Subpart C.

2.4. Test Result of Conducted Emission

Product : BF-IDU07
 Test Item : Conducted Emission Test
 Power Line : L 1
 Test Mode : Mode 1: Transmit (915.25MHz)
 Test Date : 2020/11/06
 Model No. : BIS U-620-068-111-00-S115

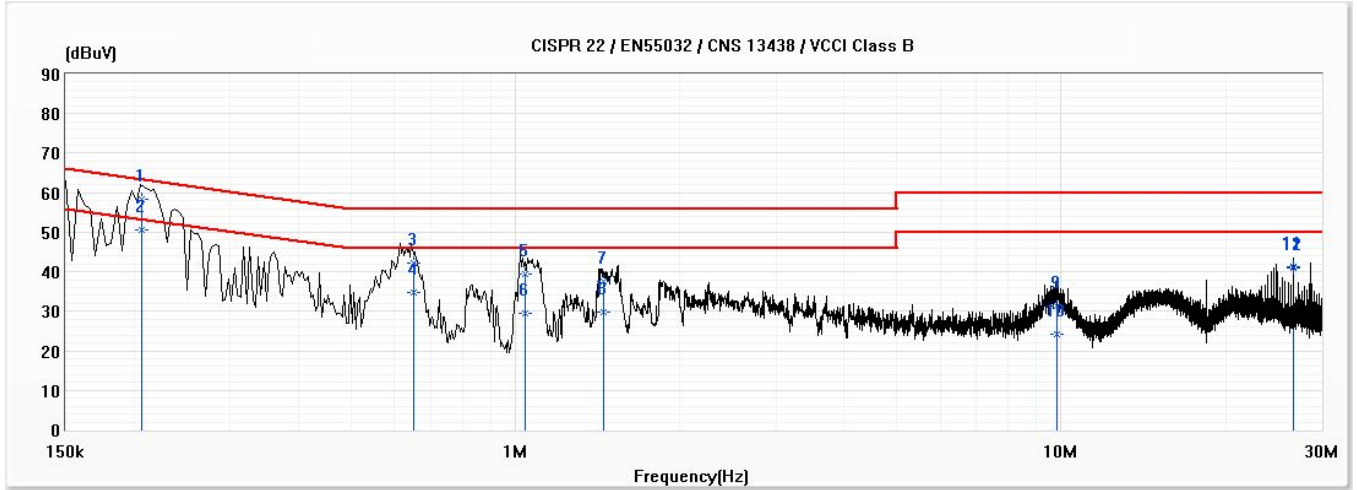

No	Frequency (MHz)	Emission Level (dBμV)	Limit (dBμV)	Margin (dB)	Reading Level (dBμV)	Correct Factor (dB)	Detector Type
1	0.207	58.34	63.32	-4.98	48.69	9.65	QP
*2	0.207	50.50	53.32	-2.82	40.85	9.65	AV
3	0.651	42.31	56.00	-13.69	32.64	9.67	QP
4	0.651	34.77	46.00	-11.23	25.10	9.67	AV
5	1.043	39.31	56.00	-16.69	29.61	9.69	QP
6	1.043	29.54	46.00	-16.46	19.85	9.69	AV
7	1.450	37.54	56.00	-18.46	27.84	9.70	QP
8	1.450	29.66	46.00	-16.34	19.96	9.70	AV
9	9.847	31.19	60.00	-28.81	21.30	9.89	QP
10	9.847	24.21	50.00	-25.79	14.32	9.89	AV
11	26.624	41.43	60.00	-18.57	31.47	9.96	QP
12	26.624	40.88	50.00	-9.12	30.93	9.96	AV

Note:

1. All Reading Levels are Quasi-Peak and average value.
2. “ * “ means the worst emission level.
3. Measurement Level = Reading Level + Correct Factor

Product : BF-IDU07
 Test Item : Conducted Emission Test
 Power Line : N
 Test Mode : Mode 1: Transmit (915.25 MHz)
 Test Date : 2020/11/06
 Model No. : BIS U-620-068-111-00-S115

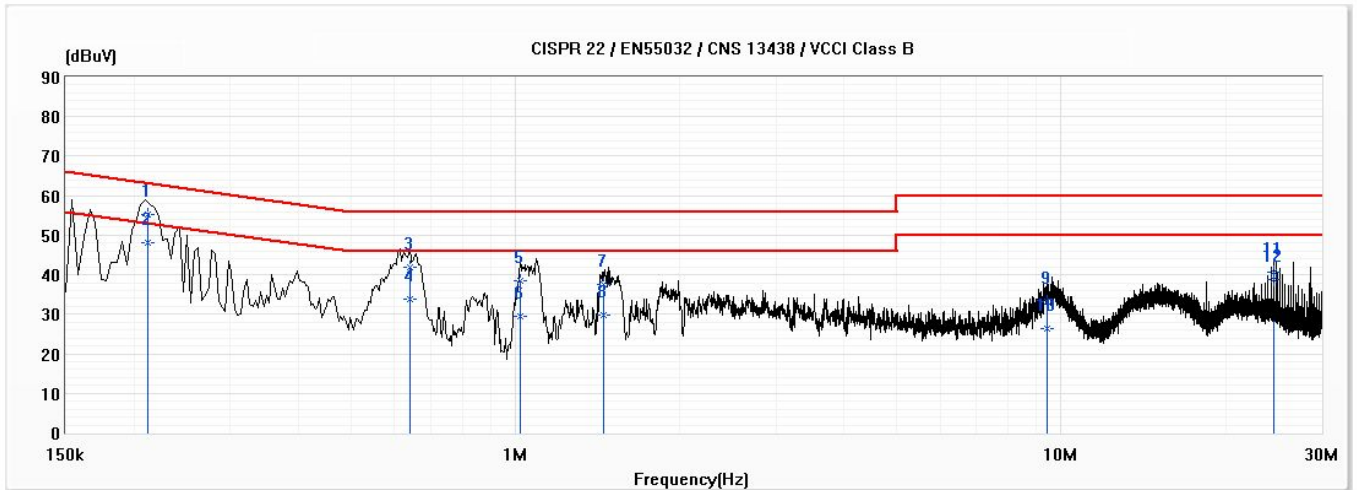

No	Frequency (MHz)	Emission Level (dBμV)	Limit (dBμV)	Margin (dB)	Reading Level (dBμV)	Correct Factor (dB)	Detector Type
1	0.212	55.21	63.11	-7.91	45.53	9.67	QP
*2	0.212	48.12	53.11	-4.99	38.45	9.67	AV
3	0.641	41.95	56.00	-14.05	32.27	9.68	QP
4	0.641	33.83	46.00	-12.17	24.15	9.68	AV
5	1.020	38.53	56.00	-17.47	28.84	9.69	QP
6	1.020	29.41	46.00	-16.59	19.72	9.69	AV
7	1.450	37.53	56.00	-18.47	27.82	9.70	QP
8	1.450	29.73	46.00	-16.27	20.02	9.70	AV
9	9.420	33.30	60.00	-26.70	23.41	9.89	QP
10	9.420	26.42	50.00	-23.58	16.52	9.89	AV
11	24.536	40.71	60.00	-19.29	30.64	10.08	QP
12	24.536	38.94	50.00	-11.06	28.86	10.08	AV

Note:

1. All Reading Levels are Quasi-Peak and average value.
2. “ * “ means the worst emission level.
3. Measurement Level = Reading Level + Correct Factor

Product : BF-IDU07
 Test Item : Conducted Emission Test
 Power Line : L 1
 Test Mode : Mode 1: Transmit (915.25MHz)
 Test Date : 2020/11/06
 Model No. : BIS U-620-068-111-00-ST29

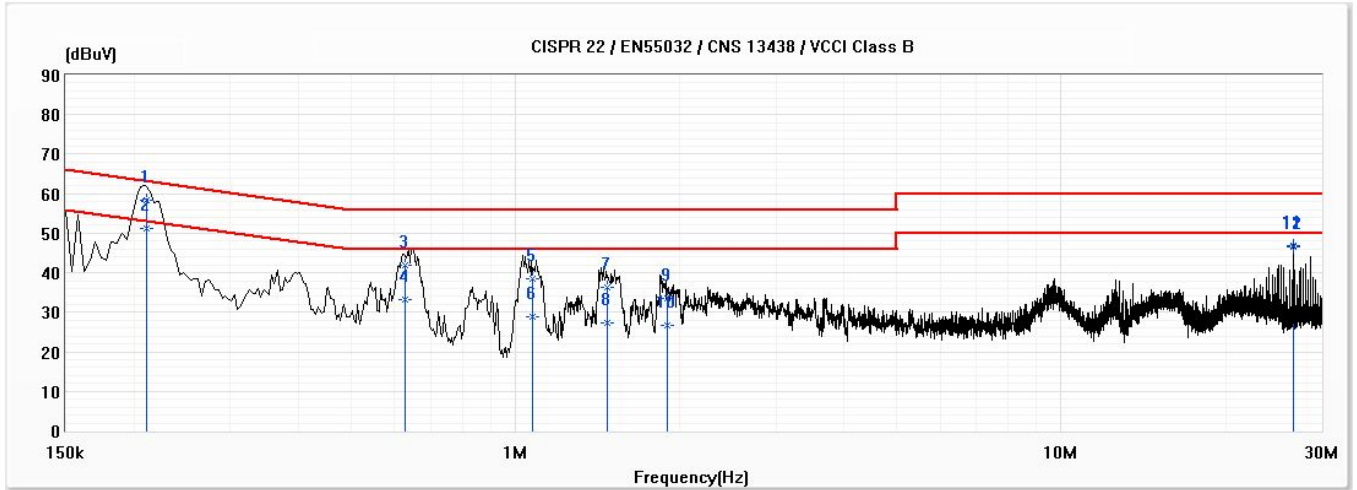

No	Frequency (MHz)	Emission Level (dBμV)	Limit (dBμV)	Margin (dB)	Reading Level (dBμV)	Correct Factor (dB)	Detector Type
1	0.211	58.45	63.17	-4.72	48.80	9.65	QP
*2	0.211	51.15	53.17	-2.03	41.49	9.65	AV
3	0.627	41.92	56.00	-14.08	32.25	9.67	QP
4	0.627	33.21	46.00	-12.79	23.54	9.67	AV
5	1.075	38.35	56.00	-17.65	28.66	9.69	QP
6	1.075	28.84	46.00	-17.16	19.14	9.69	AV
7	1.474	36.35	56.00	-19.65	26.64	9.70	QP
8	1.474	27.25	46.00	-18.75	17.55	9.70	AV
9	1.902	33.56	56.00	-22.44	23.84	9.72	QP
10	1.902	26.83	46.00	-19.17	17.12	9.72	AV
11	26.624	46.84	60.00	-13.16	36.88	9.96	QP
12	26.624	46.64	50.00	-3.36	36.68	9.96	AV

Note:

1. All Reading Levels are Quasi-Peak and average value.
2. “ * “ means the worst emission level.
3. Measurement Level = Reading Level + Correct Factor

Product : BF-IDU07
 Test Item : Conducted Emission Test
 Power Line : N
 Test Mode : Mode 1: Transmit (915.25 MHz)
 Test Date : 2020/11/06
 Model No. : BIS U-620-068-111-00-ST29

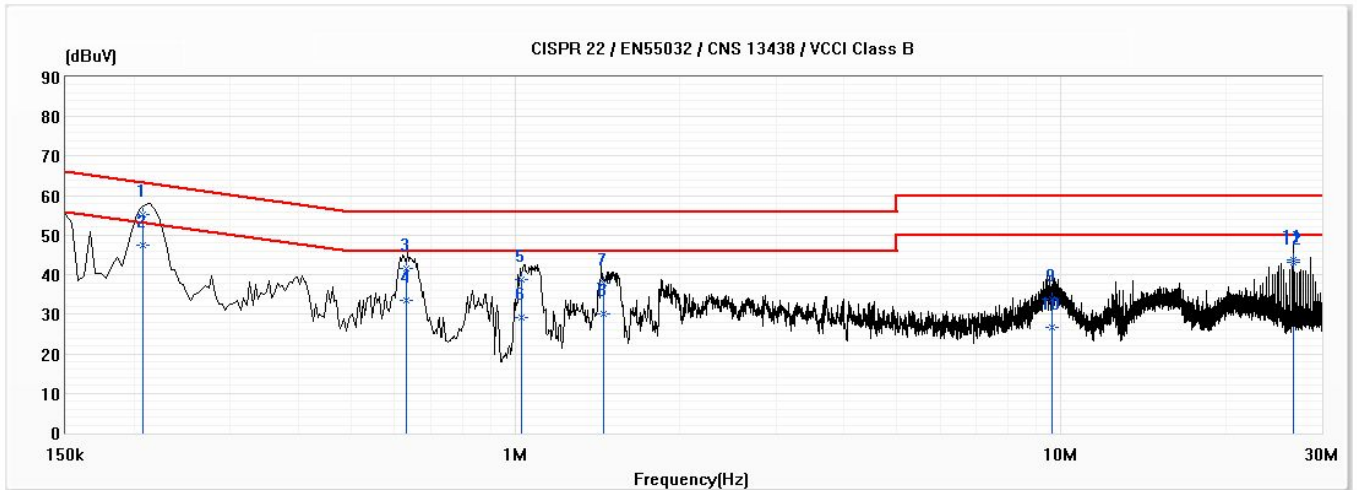

No	Frequency (MHz)	Emission Level (dBμV)	Limit (dBμV)	Margin (dB)	Reading Level (dBμV)	Correct Factor (dB)	Detector Type
1	0.208	55.23	63.29	-8.06	45.56	9.67	QP
*2	0.208	47.36	53.29	-5.93	37.69	9.67	AV
3	0.630	41.69	56.00	-14.31	32.01	9.68	QP
4	0.630	33.37	46.00	-12.63	23.70	9.68	AV
5	1.028	38.82	56.00	-17.18	29.12	9.69	QP
6	1.028	29.06	46.00	-16.94	19.36	9.69	AV
7	1.449	37.75	56.00	-18.25	28.05	9.70	QP
8	1.449	30.24	46.00	-15.76	20.53	9.70	AV
9	9.607	33.77	60.00	-26.23	23.86	9.91	QP
10	9.607	26.62	50.00	-23.38	16.71	9.91	AV
11	26.624	43.65	60.00	-16.35	33.56	10.08	QP
12	26.624	43.28	50.00	-6.72	33.20	10.08	AV

Note:

1. All Reading Levels are Quasi-Peak and average value.
2. “ * “ means the worst emission level.
3. Measurement Level = Reading Level + Correct Factor

Product : BF-IDU07
 Test Item : Conducted Emission Test
 Power Line : L 1
 Test Mode : Mode 1: Transmit (915.25MHz)
 Test Date : 2020/11/06
 Model No. : BIS U-626-069-111-06-ST31

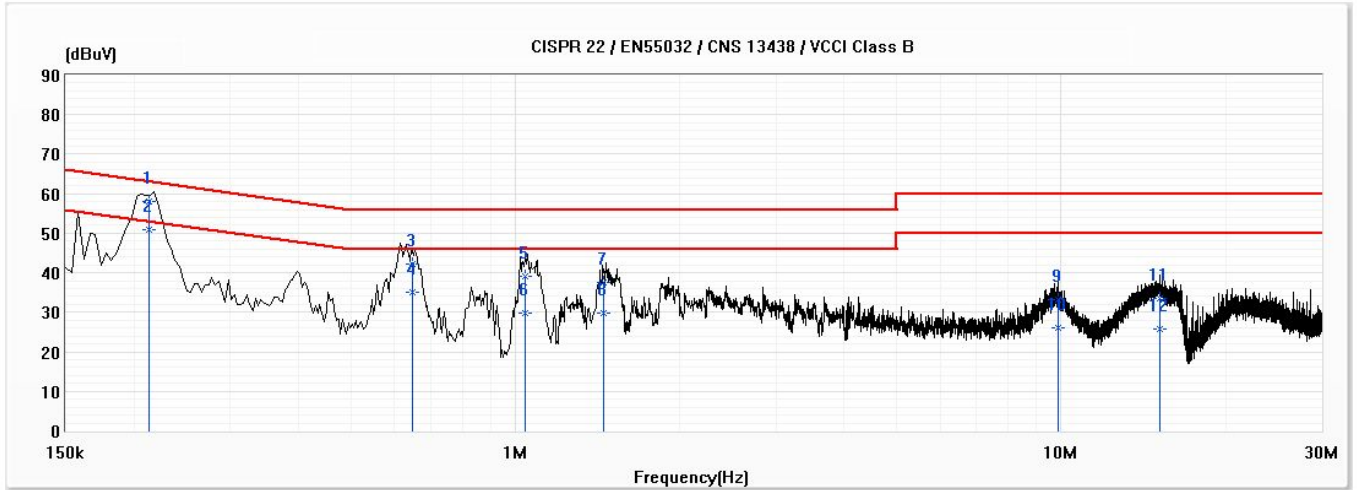

No	Frequency (MHz)	Emission Level (dBμV)	Limit (dBμV)	Margin (dB)	Reading Level (dBμV)	Correct Factor (dB)	Detector Type
1	0.214	58.04	63.07	-5.03	48.39	9.65	QP
*2	0.214	50.98	53.07	-2.09	41.33	9.65	AV
3	0.648	42.36	56.00	-13.64	32.69	9.67	QP
4	0.648	35.09	46.00	-10.91	25.42	9.67	AV
5	1.044	39.17	56.00	-16.83	29.48	9.69	QP
6	1.044	29.64	46.00	-16.36	19.95	9.69	AV
7	1.449	37.55	56.00	-18.45	27.84	9.70	QP
8	1.449	29.91	46.00	-16.09	20.21	9.70	AV
9	9.872	33.32	60.00	-26.68	23.44	9.89	QP
10	9.872	26.11	50.00	-23.89	16.22	9.89	AV
11	15.190	33.52	60.00	-26.48	23.58	9.94	QP
12	15.190	25.78	50.00	-24.22	15.83	9.94	AV

Note:

1. All Reading Levels are Quasi-Peak and average value.
2. “ * “ means the worst emission level.
3. Measurement Level = Reading Level + Correct Factor

Product : BF-IDU07
 Test Item : Conducted Emission Test
 Power Line : N
 Test Mode : Mode 1: Transmit (915.25 MHz)
 Test Date : 2020/11/06
 Model No. : BIS U-626-069-111-06-ST31

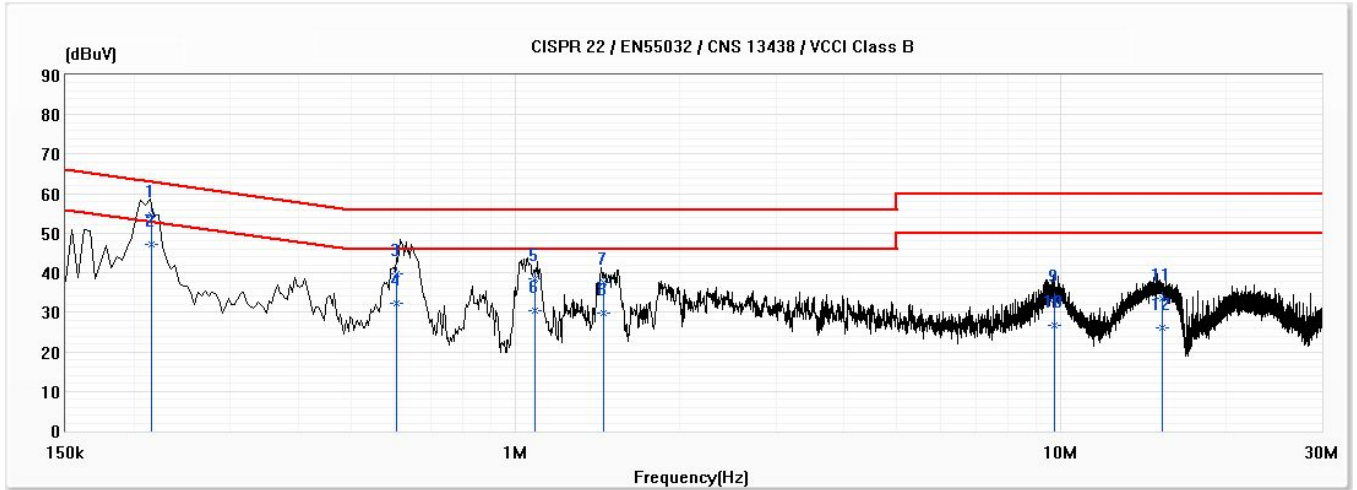

No	Frequency (MHz)	Emission Level (dBμV)	Limit (dBμV)	Margin (dB)	Reading Level (dBμV)	Correct Factor (dB)	Detector Type
1	0.215	54.69	63.00	-8.31	45.02	9.67	QP
*2	0.215	47.19	53.00	-5.81	37.52	9.67	AV
3	0.606	39.77	56.00	-16.23	30.09	9.67	QP
4	0.606	32.21	46.00	-13.79	22.54	9.67	AV
5	1.087	38.46	56.00	-17.54	28.76	9.69	QP
6	1.087	30.42	46.00	-15.58	20.73	9.69	AV
7	1.450	37.49	56.00	-18.51	27.78	9.70	QP
8	1.450	29.91	46.00	-16.09	20.20	9.70	AV
9	9.713	33.36	60.00	-26.64	23.45	9.91	QP
10	9.713	26.54	50.00	-23.46	16.64	9.91	AV
11	15.288	33.65	60.00	-26.35	23.65	10.00	QP
12	15.288	25.93	50.00	-24.07	15.93	10.00	AV

Note:

1. All Reading Levels are Quasi-Peak and average value.
2. “ * “ means the worst emission level.
3. Measurement Level = Reading Level + Correct Factor

Product : BF-IDU07
 Test Item : Conducted Emission Test
 Power Line : L 1
 Test Mode : Mode 1: Transmit (915.25MHz)
 Test Date : 2020/11/06
 Model No. : BIS U-626-069-111-06-ST32

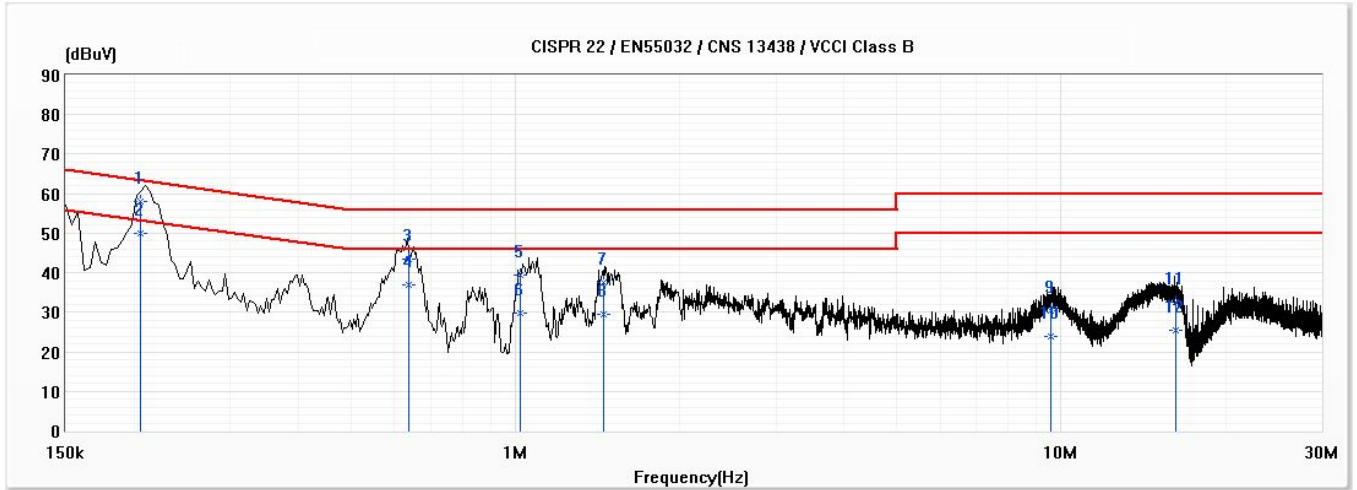

No	Frequency (MHz)	Emission Level (dBμV)	Limit (dBμV)	Margin (dB)	Reading Level (dBμV)	Correct Factor (dB)	Detector Type
1	0.205	57.97	63.39	-5.42	48.32	9.65	QP
*2	0.205	50.08	53.39	-3.31	40.43	9.65	AV
3	0.639	43.36	56.00	-12.64	33.69	9.67	QP
4	0.639	37.02	46.00	-8.98	27.35	9.67	AV
5	1.023	39.44	56.00	-16.56	29.75	9.69	QP
6	1.023	29.86	46.00	-16.14	20.17	9.69	AV
7	1.451	37.48	56.00	-18.52	27.78	9.70	QP
8	1.451	29.59	46.00	-16.41	19.89	9.70	AV
9	9.587	30.55	60.00	-29.45	20.67	9.89	QP
10	9.587	23.80	50.00	-26.20	13.92	9.89	AV
11	16.200	32.66	60.00	-27.34	22.71	9.95	QP
12	16.200	25.58	50.00	-24.42	15.63	9.95	AV

Note:

1. All Reading Levels are Quasi-Peak and average value.
2. “ * “ means the worst emission level.
3. Measurement Level = Reading Level + Correct Factor

Product : BF-IDU07
 Test Item : Conducted Emission Test
 Power Line : N
 Test Mode : Mode 1: Transmit (915.25 MHz)
 Test Date : 2020/11/06
 Model No. : BIS U-626-069-111-06-ST32

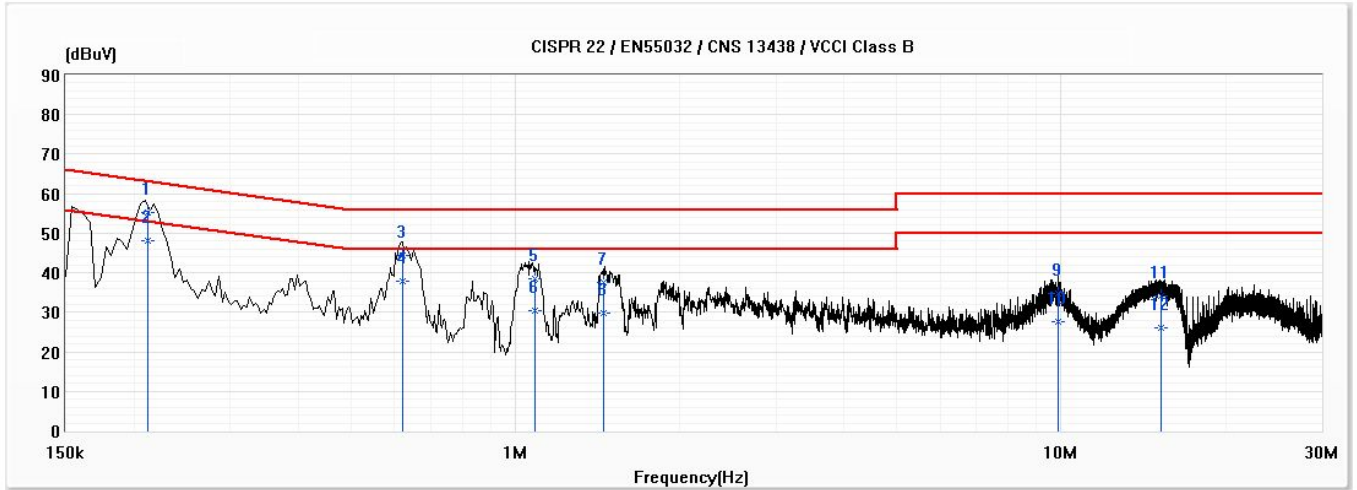

No	Frequency (MHz)	Emission Level (dBμV)	Limit (dBμV)	Margin (dB)	Reading Level (dBμV)	Correct Factor (dB)	Detector Type
1	0.212	55.32	63.12	-7.81	45.65	9.67	QP
*2	0.212	48.21	53.12	-4.92	38.54	9.67	AV
3	0.622	44.50	56.00	-11.50	34.83	9.67	QP
4	0.622	37.83	46.00	-8.17	28.15	9.67	AV
5	1.087	38.41	56.00	-17.59	28.72	9.69	QP
6	1.087	30.54	46.00	-15.46	20.85	9.69	AV
7	1.449	37.49	56.00	-18.51	27.78	9.70	QP
8	1.449	29.94	46.00	-16.06	20.23	9.70	AV
9	9.867	34.66	60.00	-25.34	24.76	9.91	QP
10	9.867	27.52	50.00	-22.48	17.62	9.91	AV
11	15.234	34.11	60.00	-25.89	24.11	10.00	QP
12	15.234	26.22	50.00	-23.78	16.23	10.00	AV

Note:

1. All Reading Levels are Quasi-Peak and average value.
2. “ * “ means the worst emission level.
3. Measurement Level = Reading Level + Correct Factor

3. Peak Power Output

3.1. Test Setup

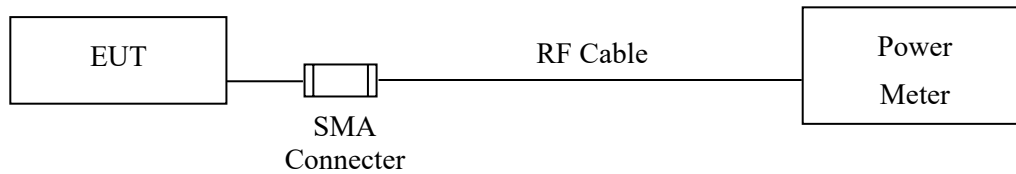

3.2. Limit

According to FCC Section 15.247(b)(2). For frequency hopping systems operating in the 902-928 MHz band: 1 watt for systems employing at least 50 hopping channels; and, 0.25 watts for systems employing less than 50 hopping channels, but at least 25 hopping channels.

3.3. Test Procedure

Tested according to FHSS test procedure of KDB 558074 section 9 (b for compliance to FCC 47CFR 15.247 requirements.

3.4. Test Result of Peak Power Output

Product : BF-IDU07
Test Item : Peak Power Output
Test Mode : Mode 1: Transmit
Test Date : 2020/07/23

Channel No.	Frequency (MHz)	Measurement (dBm)	Required Limit	Result
Channel 1	902.75	27.78	1 Watt= 30 dBm	Pass
Channel 26	915.25	27.09	1 Watt= 30 dBm	Pass
Channel 50	927.25	26.61	1 Watt= 30 dBm	Pass

4. Radiated Emission

4.1. Test Setup

Radiated Emission Under 30MHz

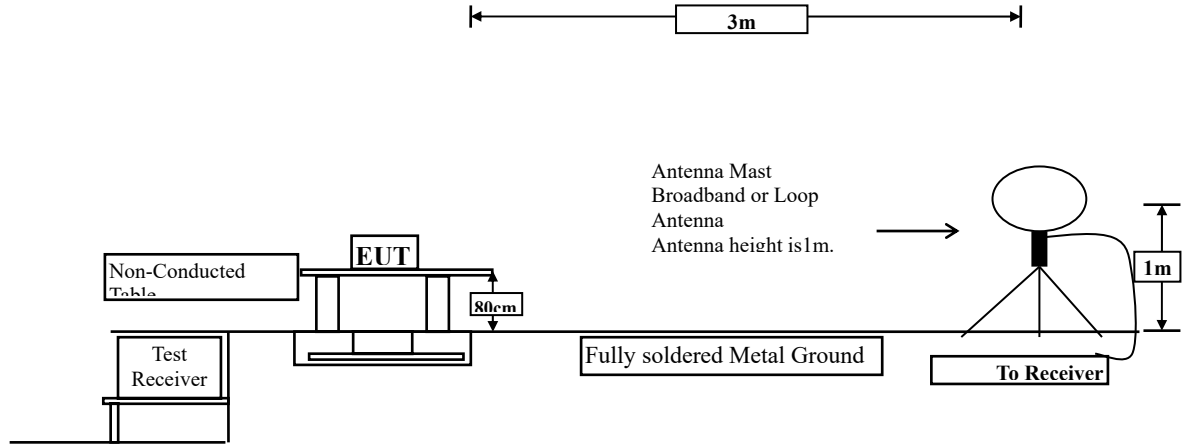

Radiated Emission Below 1GHz

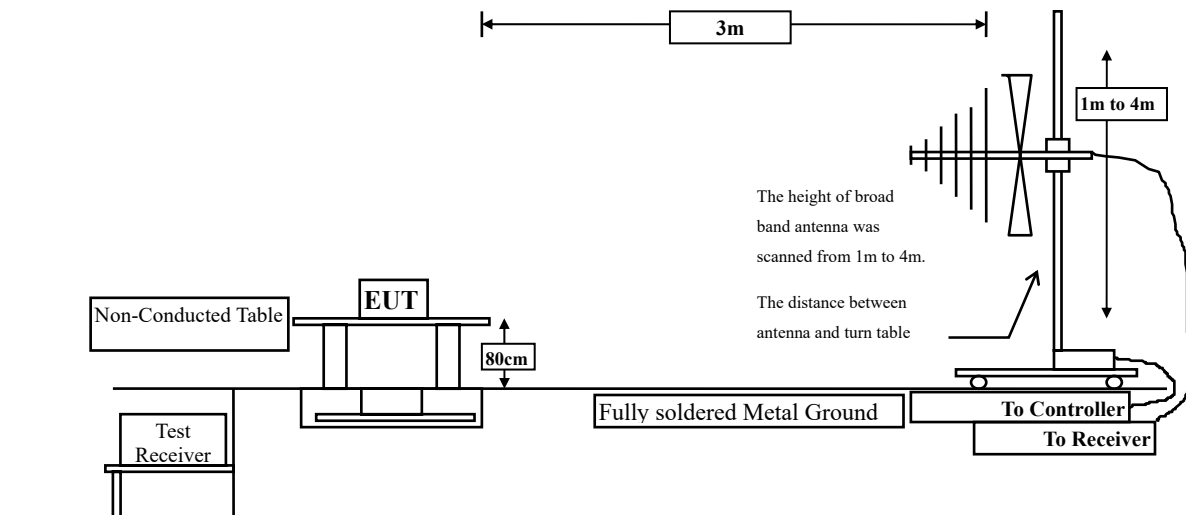

Radiated Emission Above 1GHz

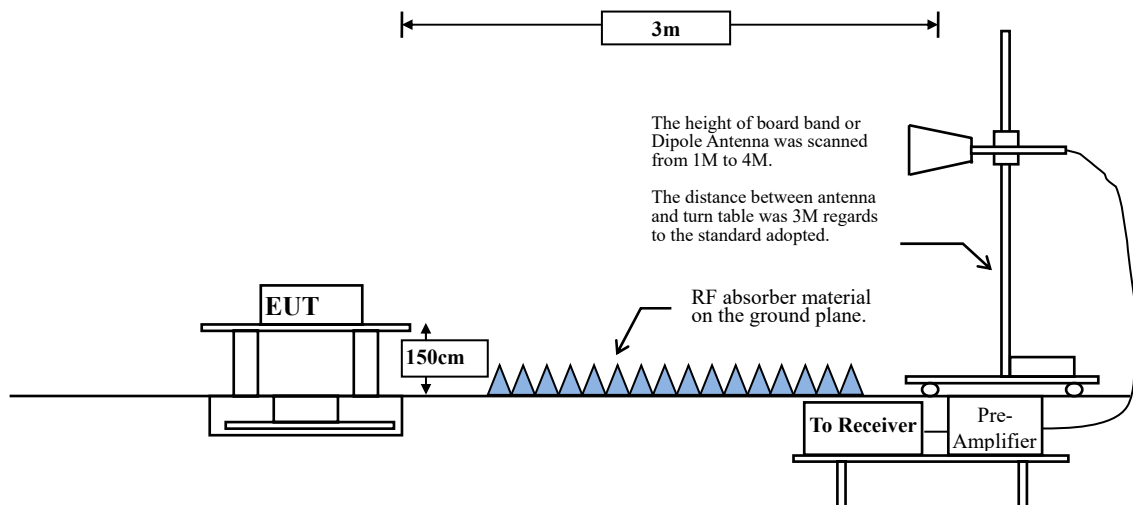

4.2. Limits

➤ General Radiated Emission Limits

Emissions radiated outside of the specified frequency bands, except for harmonics, shall be attenuated by at least 20dB below the level of the fundamental or to the general radiated emission limits in paragraph 15.209, whichever is the lesser attenuation.

FCC Part 15 Subpart C Paragraph 15.209 Limits		
Frequency MHz	Field strength (microvolts/meter)	Measurement distance (meter)
0.009-0.490	2400/F(kHz)	300
0.490-1.705	24000/F(kHz)	30
1.705-30	30	30
30-88	100	3
88-216	150	3
216-960	200	3
Above 960	500	3

- Remarks:
1. RF Voltage (dBuV) = 20 log RF Voltage (uV)
 2. In the Above Table, the tighter limit applies at the band edges.
 3. Distance refers to the distance in meters between the measuring instrument antenna and the closed point of any part of the device or system.

4.3. Test Procedure

The EUT was setup according to ANSI C63.10, 2013 and tested compliance to FCC 47CFR 15.247 requirements.

Measuring the frequency range below 1GHz, the EUT is placed on a turn table which is 0.8 meter above ground, when measuring the frequency range above 1GHz, the EUT is placed on a turn table which is 1.5 meter above ground.

The turn table is rotated 360 degrees to determine the position of the maximum emission level.

The EUT was positioned such that the distance from antenna to the EUT was 3 meters.

The antenna is scanned between 1 meter and 4 meters to find out the maximum emission level. This is repeated for both horizontal and vertical polarization of the antenna. In order to find the maximum emission, all of the interface cables were manipulated according to ANSI C63.10: 2013 on radiated measurement.

The resolution bandwidth below 30MHz setting on the field strength meter is 9kHz and 30MHz~1GHz is 120kHz and above 1GHz is 1MHz.

Radiated emission measurements below 30MHz are made using Loop Antenna and 30MHz~1GHz are made using broadband Bilog antenna and above 1GHz are made using Horn Antennas.

The measurement is divided into the Preliminary Measurement and the Final Measurement.

The suspected frequencies are searched for in Preliminary Measurement with the measurement antenna kept pointed at the source of the emission both in azimuth and elevation, with the polarization of the antenna oriented for maximum response. The antenna is pointed at an angle towards the source of the emission, and the EUT is rotated in both height and polarization to maximize the measured emission. The emission is kept within the illumination area of the 3 dB bandwidth of the antenna. The measurement frequency range from 9kHz - 10th Harmonic of fundamental was investigated.

4.4. Test Result of Radiated Emission

Product : BF-IDU07
 Test Item : Harmonic Radiated Emission
 Test Mode : Mode 1: Transmit (902.75MHz)
 Test Date : 2020/09/25
 Model No. : BIS U-620-068-111-00-ST29

Horizontal

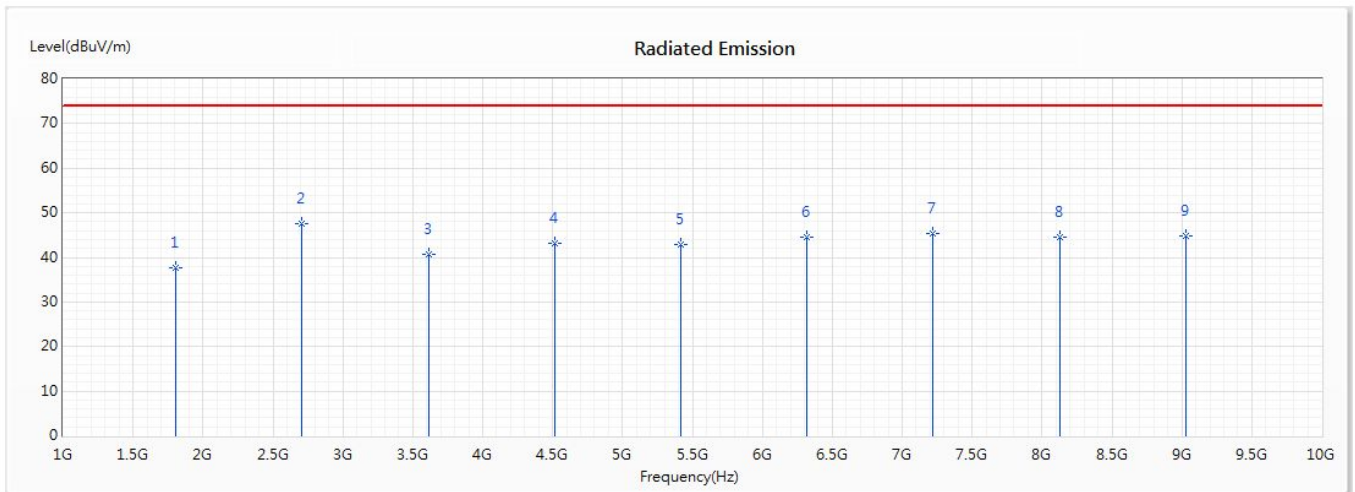

No	Frequency (MHz)	Emission Level (dBμV/m)	Limit (dBμV/m)	Margin (dB)	Reading Level (dBμV)	Correct Factor (dB/m)	Detector Type
1	1805.5	37.70	74.00	-36.30	44.84	-7.14	PK
* 2	2708.25	47.46	74.00	-26.54	51.05	-3.59	PK
3	3611	40.79	74.00	-33.21	43.71	-2.92	PK
4	4513.75	43.20	74.00	-30.80	44.37	-1.17	PK
5	5416.5	42.94	74.00	-31.06	43.69	-0.75	PK
6	6319.25	44.59	74.00	-29.41	43.23	1.36	PK
7	7222	45.46	74.00	-28.54	43.26	2.20	PK
8	8124.75	44.46	74.00	-29.54	41.85	2.61	PK
9	9027.5	44.93	74.00	-29.07	41.57	3.36	PK

Note:

1. All Readings below 1GHz are Quasi-Peak, above 1GHz are performed with peak and/or average measurements as necessary.
2. Peak measurements: RBW = 1MHz, VBW = 3 MHz, Sweep: Auto.
3. Measurement Level = Reading Level + Correct Factor.
4. Correct Factor = Antenna factor + Cable loss – Amplifier gain.
5. The average measurement was not performed when the peak measured data under the limit of average detection.
6. The emission levels of other frequencies are very lower than the limit and not show in test report.

Product : BF-IDU07
 Test Item : Harmonic Radiated Emission
 Test Mode : Mode 1: Transmit (902.75MHz)
 Test Date : 2020/09/25
 Model No. : BIS U-620-068-111-00-ST29

Vertical

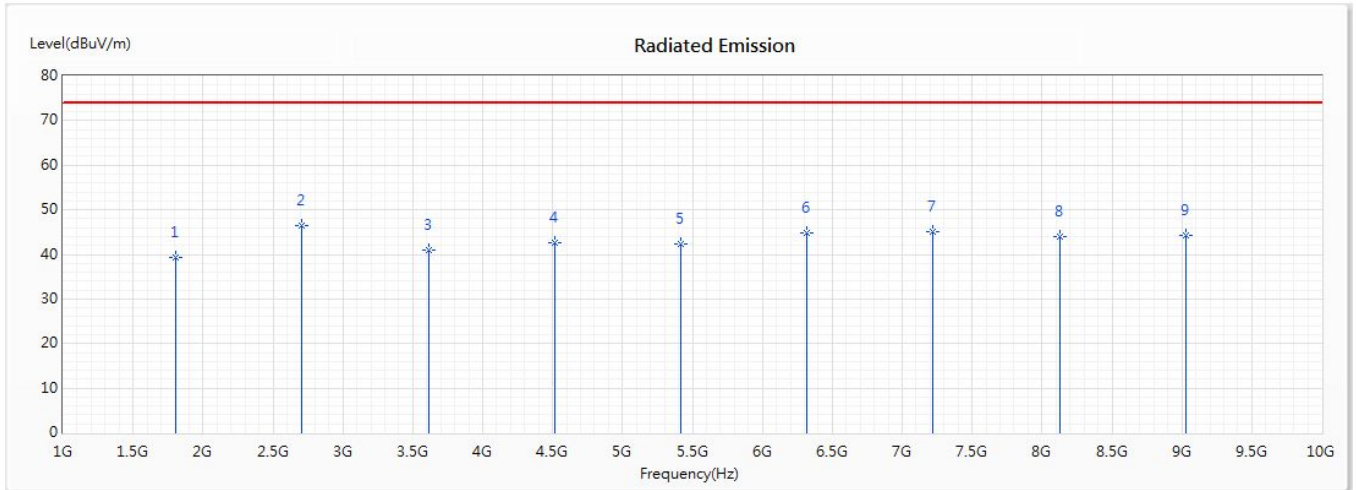

No	Frequency (MHz)	Emission Level (dBμV/m)	Limit (dBμV/m)	Margin (dB)	Reading Level (dBμV)	Correct Factor (dB/m)	Detector Type
1	1805.5	39.45	74.00	-34.55	46.59	-7.14	PK
* 2	2708.25	46.37	74.00	-27.63	49.96	-3.59	PK
3	3611	40.98	74.00	-33.02	43.90	-2.92	PK
4	4513.75	42.52	74.00	-31.48	43.69	-1.17	PK
5	5416.5	42.39	74.00	-31.61	43.14	-0.75	PK
6	6319.25	44.73	74.00	-29.27	43.37	1.36	PK
7	7222	45.11	74.00	-28.89	42.91	2.20	PK
8	8124.75	44.09	74.00	-29.91	41.48	2.61	PK
9	9027.5	44.28	74.00	-29.72	40.92	3.36	PK

Note:

1. All Readings below 1GHz are Quasi-Peak, above 1GHz are performed with peak and/or average measurements as necessary.
2. Peak measurements: RBW = 1MHz, VBW = 3 MHz, Sweep: Auto.
3. Measurement Level = Reading Level + Correct Factor.
4. Correct Factor = Antenna factor + Cable loss – Amplifier gain.
5. The average measurement was not performed when the peak measured data under the limit of average detection.
6. The emission levels of other frequencies are very lower than the limit and not show in test report.

Product : BF-IDU07
 Test Item : Harmonic Radiated Emission
 Test Mode : Mode 1: Transmit (915.25MHz)
 Test Date : 2020/09/25
 Model No. : BIS U-620-068-111-00-ST29

Horizontal

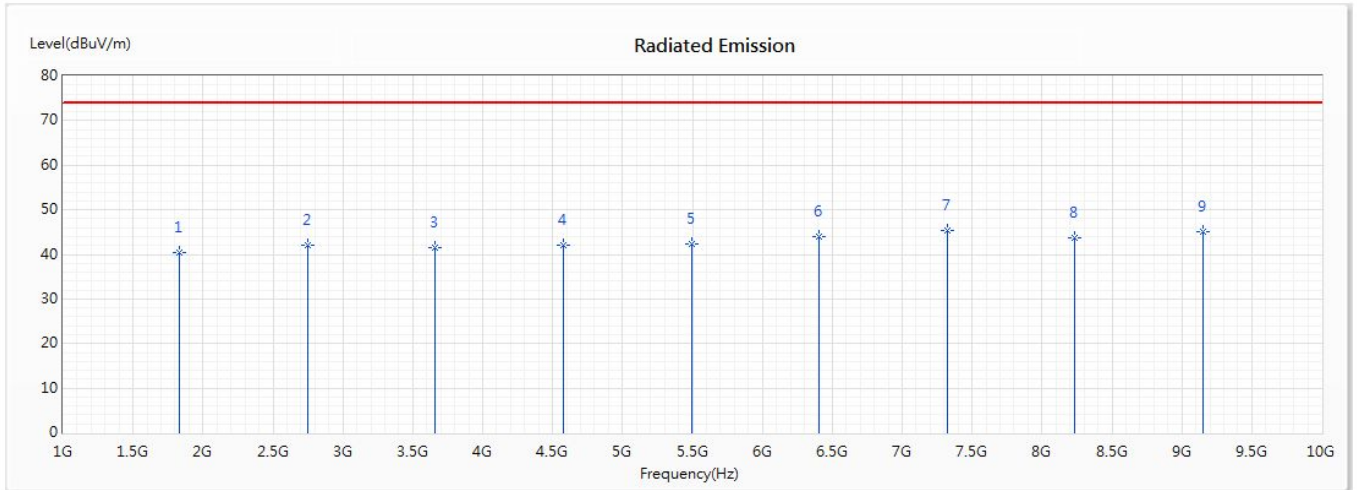

No	Frequency (MHz)	Emission Level (dBμV/m)	Limit (dBμV/m)	Margin (dB)	Reading Level (dBμV)	Correct Factor (dB/m)	Detector Type
1	1830.5	40.48	74.00	-33.52	47.23	-6.75	PK
2	2745.75	41.98	74.00	-32.02	45.62	-3.64	PK
3	3661	41.44	74.00	-32.56	44.35	-2.91	PK
4	4576.25	42.10	74.00	-31.90	43.18	-1.08	PK
5	5491.5	42.43	74.00	-31.57	43.05	-0.62	PK
6	6406.75	44.01	74.00	-29.99	42.41	1.60	PK
* 7	7322	45.29	74.00	-28.71	43.12	2.17	PK
8	8237.525	43.68	74.00	-30.32	40.97	2.71	PK
9	9152.5	44.99	74.00	-29.01	41.47	3.52	PK

Note:

1. All Readings below 1GHz are Quasi-Peak, above 1GHz are performed with peak and/or average measurements as necessary.
2. Peak measurements: RBW = 1MHz, VBW = 3 MHz, Sweep: Auto.
3. Measurement Level = Reading Level + Correct Factor.
4. Correct Factor = Antenna factor + Cable loss – Amplifier gain.
5. The average measurement was not performed when the peak measured data under the limit of average detection.
6. The emission levels of other frequencies are very lower than the limit and not show in test report.

Product : BF-IDU07
 Test Item : Harmonic Radiated Emission
 Test Mode : Mode 1: Transmit (915.25MHz)
 Test Date : 2020/09/25
 Model No. : BIS U-620-068-111-00-ST29

Vertical

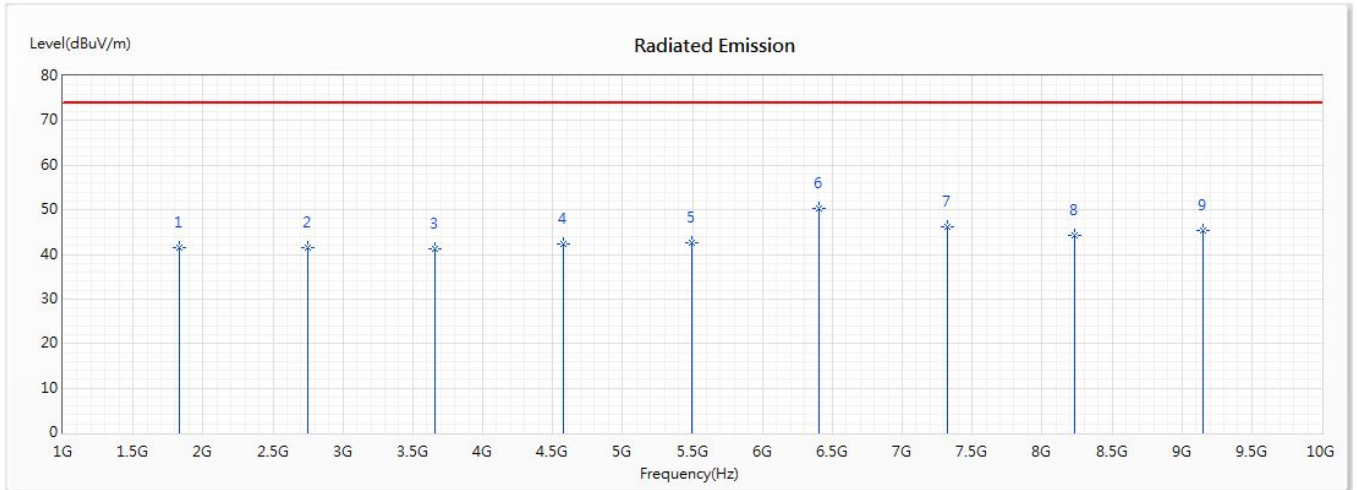

No	Frequency (MHz)	Emission Level (dBμV/m)	Limit (dBμV/m)	Margin (dB)	Reading Level (dBμV)	Correct Factor (dB/m)	Detector Type
1	1830.5	41.41	74.00	-32.59	48.16	-6.75	PK
2	2745.75	41.56	74.00	-32.44	45.20	-3.64	PK
3	3661	41.23	74.00	-32.77	44.14	-2.91	PK
4	4576.25	42.27	74.00	-31.73	43.35	-1.08	PK
5	5491.5	42.58	74.00	-31.42	43.20	-0.62	PK
* 6	6406.75	50.43	74.00	-23.57	48.83	1.60	PK
7	7322	46.32	74.00	-27.68	44.15	2.17	PK
8	8237.25	44.20	74.00	-29.80	41.49	2.71	PK
9	9152.5	45.40	74.00	-28.60	41.88	3.52	PK

Note:

1. All Readings below 1GHz are Quasi-Peak, above 1GHz are performed with peak and/or average measurements as necessary.
2. Peak measurements: RBW = 1MHz, VBW = 3 MHz, Sweep: Auto.
3. Measurement Level = Reading Level + Correct Factor.
4. Correct Factor = Antenna factor + Cable loss – Amplifier gain.
5. The average measurement was not performed when the peak measured data under the limit of average detection.
6. The emission levels of other frequencies are very lower than the limit and not show in test report.

Product : BF-IDU07
 Test Item : Harmonic Radiated Emission
 Test Mode : Mode 1: Transmit (927.25MHz)
 Test Date : 2020/09/25
 Model No. : BIS U-620-068-111-00-ST29

Horizontal

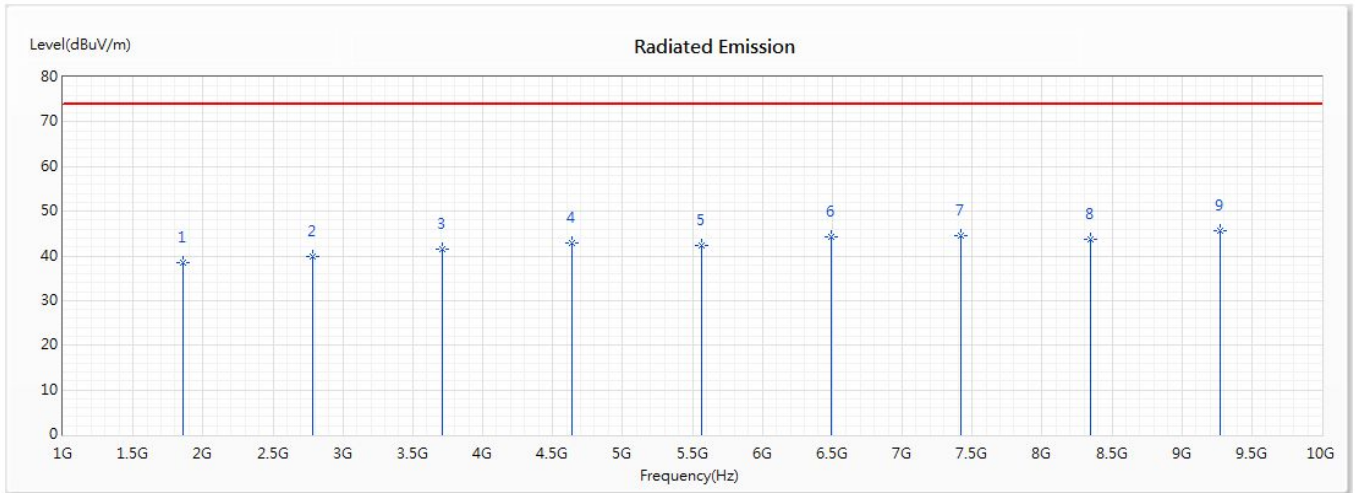

No	Frequency (MHz)	Emission Level (dBμV/m)	Limit (dBμV/m)	Margin (dB)	Reading Level (dBμV)	Correct Factor (dB/m)	Detector Type
1	1854.5	38.50	74.00	-35.50	44.92	-6.42	PK
2	2781.75	39.96	74.00	-34.04	43.66	-3.70	PK
3	3709	41.40	74.00	-32.60	44.36	-2.96	PK
4	4636.25	42.97	74.00	-31.03	44.10	-1.13	PK
5	5563.5	42.39	74.00	-31.61	42.94	-0.55	PK
6	6490.75	44.18	74.00	-29.82	42.44	1.74	PK
7	7418	44.59	74.00	-29.41	42.44	2.15	PK
8	8345.25	43.77	74.00	-30.23	41.11	2.66	PK
* 9	9272.5	45.52	74.00	-28.48	41.85	3.67	PK

Note:

1. All Readings below 1GHz are Quasi-Peak, above 1GHz are performed with peak and/or average measurements as necessary.
2. Peak measurements: RBW = 1MHz, VBW = 3 MHz, Sweep: Auto.
3. Measurement Level = Reading Level + Correct Factor.
4. Correct Factor = Antenna factor + Cable loss – Amplifier gain.
5. The average measurement was not performed when the peak measured data under the limit of average detection.
6. The emission levels of other frequencies are very lower than the limit and not show in test report.

Product : BF-IDU07
 Test Item : Harmonic Radiated Emission
 Test Mode : Mode 1: Transmit (927.25MHz)
 Test Date : 2020/09/25
 Model No. : BIS U-620-068-111-00-ST29

Vertical

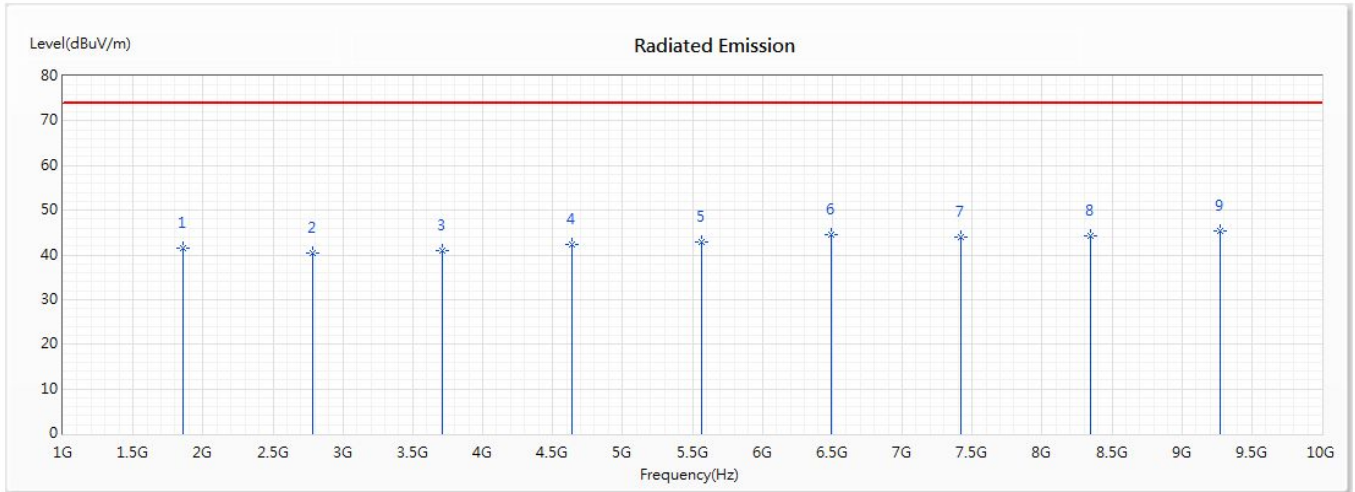

No	Frequency (MHz)	Emission Level (dBμV/m)	Limit (dBμV/m)	Margin (dB)	Reading Level (dBμV)	Correct Factor (dB/m)	Detector Type
1	1854.5	41.41	74.00	-32.59	47.83	-6.42	PK
2	2781.75	40.31	74.00	-33.69	44.01	-3.70	PK
3	3709	40.95	74.00	-33.05	43.91	-2.96	PK
4	4636.25	42.42	74.00	-31.58	43.55	-1.13	PK
5	5563.5	42.79	74.00	-31.21	43.34	-0.55	PK
6	6490.75	44.42	74.00	-29.58	42.68	1.74	PK
7	7418	44.06	74.00	-29.94	41.91	2.15	PK
8	8345.25	44.17	74.00	-29.83	41.51	2.66	PK
* 9	9272.5	45.31	74.00	-28.69	41.64	3.67	PK

Note:

1. All Readings below 1GHz are Quasi-Peak, above 1GHz are performed with peak and/or average measurements as necessary.
2. Peak measurements: RBW = 1MHz, VBW = 3 MHz, Sweep: Auto.
3. Measurement Level = Reading Level + Correct Factor.
4. Correct Factor = Antenna factor + Cable loss – Amplifier gain.
5. The average measurement was not performed when the peak measured data under the limit of average detection.
6. The emission levels of other frequencies are very lower than the limit and not show in test report.

Product : BF-IDU07
 Test Item : General Radiated Emission
 Test Mode : Mode 1: Transmit (915.25MHz)
 Test Date : 2020/09/21
 Model No. : BIS U-620-068-111-00-S115

Horizontal

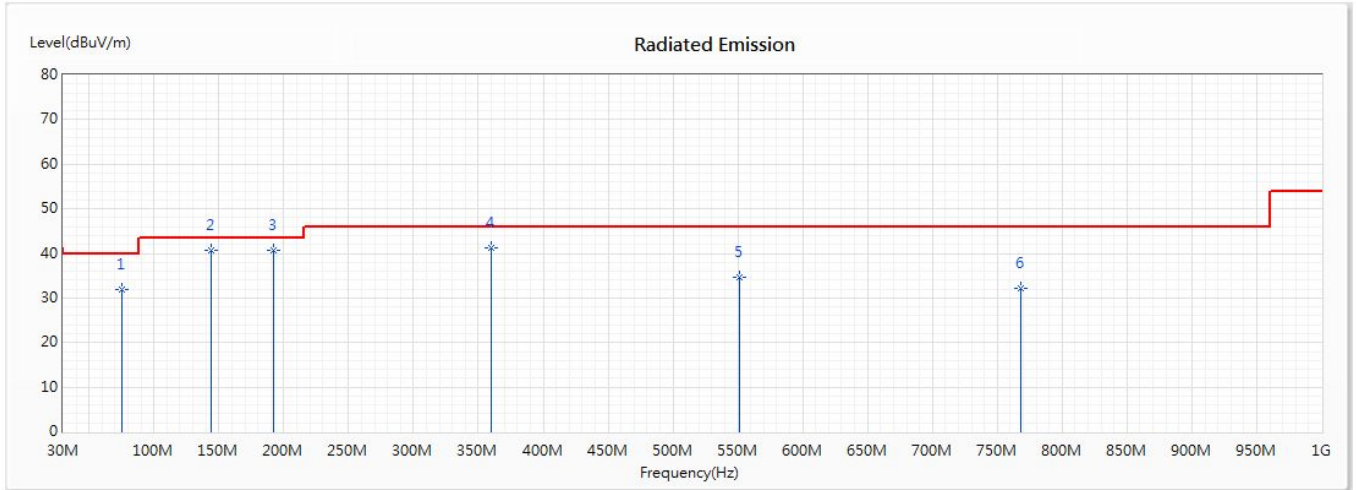

No	Frequency (MHz)	Emission Level (dBμV/m)	Limit (dBμV/m)	Margin (dB)	Reading Level (dBμV)	Correct Factor (dB/m)	Detector Type
1	74.986	31.82	40.00	-8.18	45.65	-13.83	QP
* 2	143.87	40.74	43.50	-2.76	51.27	-10.53	QP
3	191.667	40.55	43.50	-2.95	52.56	-12.01	QP
4	360.362	41.15	46.00	-4.85	48.51	-7.36	QP
5	551.551	34.53	46.00	-11.47	38.10	-3.57	QP
6	768.043	32.25	46.00	-13.75	31.95	0.30	QP

Note:

1. All Readings below 1GHz are Quasi-Peak, above 1GHz are performed with peak and/or average measurements as necessary.
2. Measurement Level = Reading Level + Correct Factor.
3. Correct Factor = Antenna factor + Cable loss – Amplifier gain.
4. The emission levels of other frequencies are very lower than the limit and not show in test report.
5. No emission found between lowest internal used/generated frequency to 30MHz.

Product : BF-IDU07
 Test Item : General Radiated Emission
 Test Mode : Mode 1: Transmit (915.25MHz)
 Test Date : 2020/09/21
 Model No. : BIS U-620-068-111-00-S115

Vertical

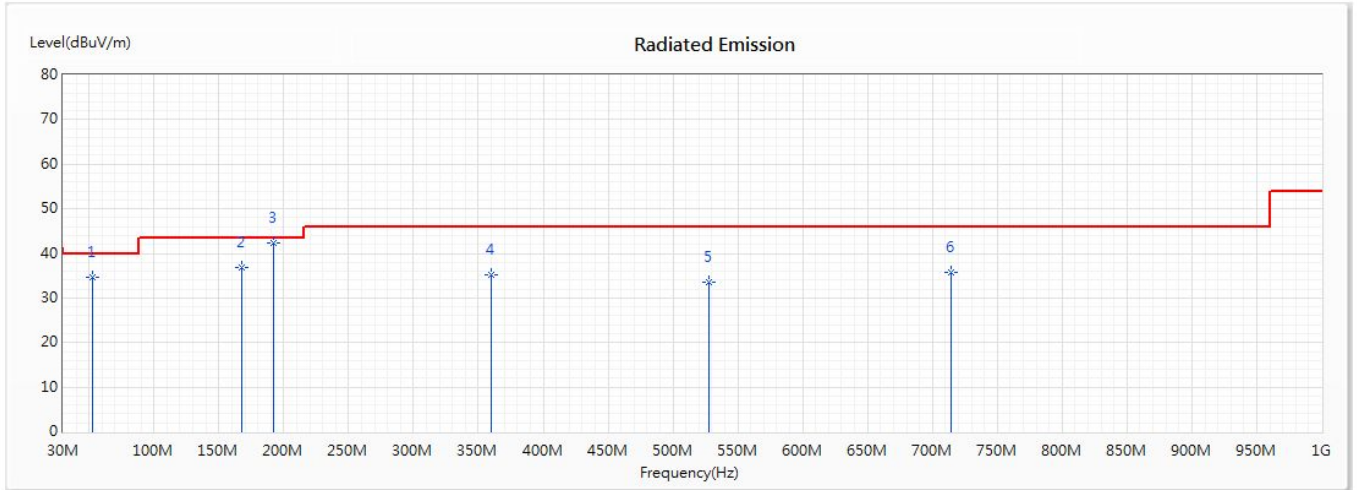

No	Frequency (MHz)	Emission Level (dBμV/m)	Limit (dBμV/m)	Margin (dB)	Reading Level (dBμV)	Correct Factor (dB/m)	Detector Type
1	52.493	34.64	40.00	-5.36	44.75	-10.11	QP
2	167.768	36.72	43.50	-6.78	46.88	-10.16	QP
* 3	192.015	42.20	43.50	-1.30	54.24	-12.04	QP
4	360.362	35.23	46.00	-10.77	42.59	-7.36	QP
5	527.652	33.62	46.00	-12.38	37.47	-3.85	QP
6	714.623	35.74	46.00	-10.26	36.44	-0.70	QP

Note:

1. All Readings below 1GHz are Quasi-Peak, above 1GHz are performed with peak and/or average measurements as necessary.
2. Measurement Level = Reading Level + Correct Factor.
3. Correct Factor = Antenna factor + Cable loss – Amplifier gain.
4. The emission levels of other frequencies are very lower than the limit and not show in test report.
5. No emission found between lowest internal used/generated frequency to 30MHz.

Product : BF-IDU07
 Test Item : General Radiated Emission
 Test Mode : Mode 1: Transmit (915.25MHz)
 Test Date : 2020/09/21
 Model No. : BIS U-620-068-111-00-ST29

Horizontal

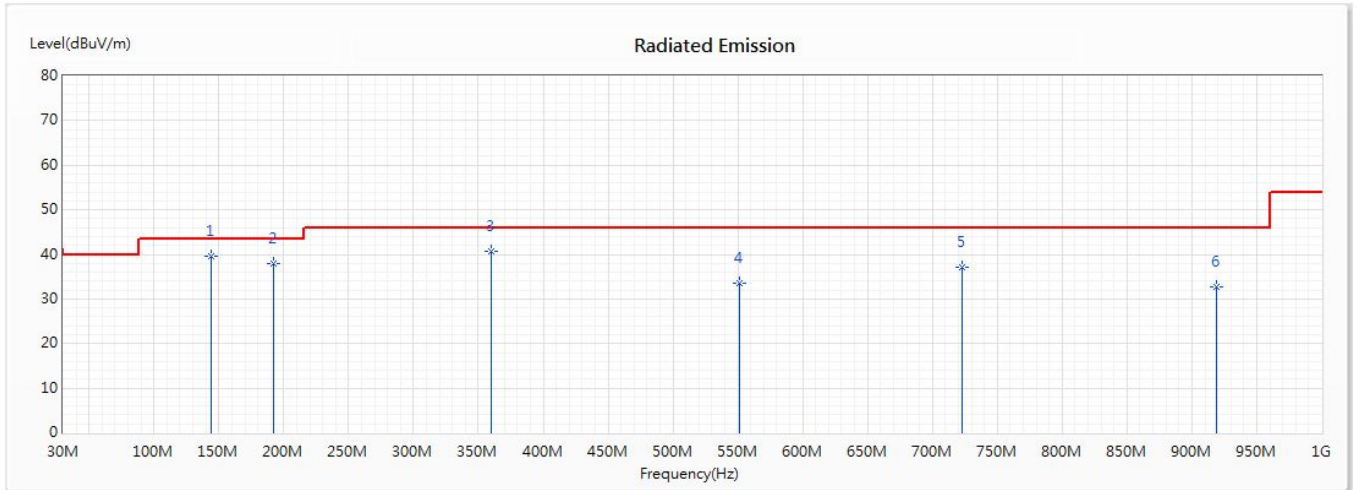

No	Frequency (MHz)	Emission Level (dBμV/m)	Limit (dBμV/m)	Margin (dB)	Reading Level (dBμV)	Correct Factor (dB/m)	Detector Type
* 1	143.87	39.50	43.50	-4.00	50.03	-10.53	QP
2	191.667	37.84	43.50	-5.66	49.85	-12.01	QP
3	360.362	40.67	46.00	-5.33	48.03	-7.36	QP
4	551.551	33.60	46.00	-12.40	37.17	-3.57	QP
5	723.058	37.11	46.00	-8.89	37.64	-0.53	QP
6	918.464	32.69	46.00	-13.31	30.59	2.10	QP

Note:

1. All Readings below 1GHz are Quasi-Peak, above 1GHz are performed with peak and/or average measurements as necessary.
2. Measurement Level = Reading Level + Correct Factor.
3. Correct Factor = Antenna factor + Cable loss – Amplifier gain.
4. The emission levels of other frequencies are very lower than the limit and not show in test report.
5. No emission found between lowest internal used/generated frequency to 30MHz.

Product : BF-IDU07
 Test Item : General Radiated Emission
 Test Mode : Mode 1: Transmit (915.25MHz)
 Test Date : 2020/09/21
 Model No. : BIS U-620-068-111-00-ST29

Vertical

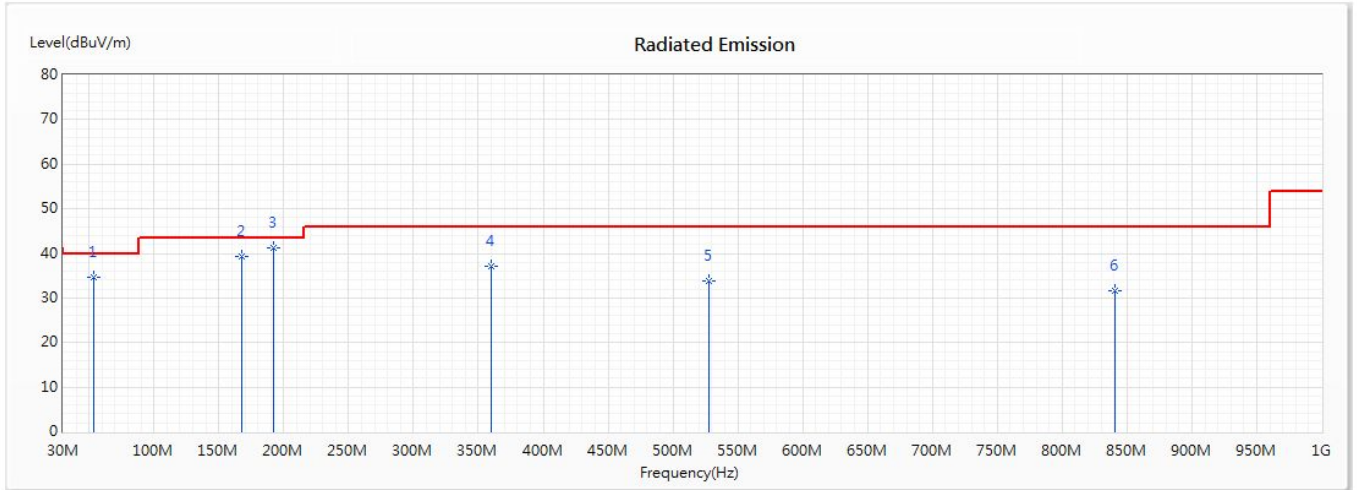

No	Frequency (MHz)	Emission Level (dBμV/m)	Limit (dBμV/m)	Margin (dB)	Reading Level (dBμV)	Correct Factor (dB/m)	Detector Type
1	53.899	34.69	40.00	-5.31	44.88	-10.19	QP
2	167.768	39.43	43.50	-4.07	49.59	-10.16	QP
* 3	191.997	41.20	43.50	-2.30	53.24	-12.04	QP
4	360.362	37.11	46.00	-8.89	44.47	-7.36	QP
5	527.652	33.75	46.00	-12.25	37.60	-3.85	QP
6	841.145	31.65	46.00	-14.35	30.52	1.13	QP

Note:

1. All Readings below 1GHz are Quasi-Peak, above 1GHz are performed with peak and/or average measurements as necessary.
2. Measurement Level = Reading Level + Correct Factor.
3. Correct Factor = Antenna factor + Cable loss – Amplifier gain.
4. The emission levels of other frequencies are very lower than the limit and not show in test report.
5. No emission found between lowest internal used/generated frequency to 30MHz.

Product : BF-IDU07
 Test Item : General Radiated Emission
 Test Mode : Mode 1: Transmit (915.25MHz)
 Test Date : 2020/09/24
 Model No. : BIS U-626-069-111-06-ST31

Horizontal

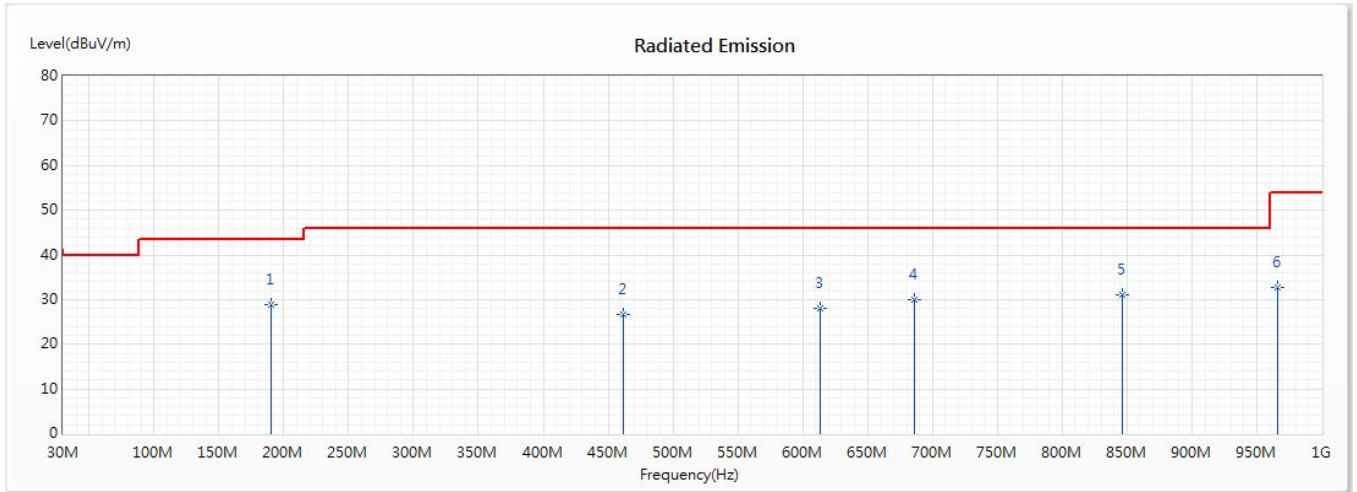

No	Frequency (MHz)	Emission Level (dBμV/m)	Limit (dBμV/m)	Margin (dB)	Reading Level (dBμV)	Correct Factor (dB/m)	Detector Type
* 1	190.261	28.91	43.50	-14.59	40.86	-11.95	QP
2	461.58	26.80	46.00	-19.20	31.80	-5.00	QP
3	613.406	28.07	46.00	-17.93	30.06	-1.99	QP
4	686.507	30.05	46.00	-15.95	31.27	-1.22	QP
5	846.768	31.12	46.00	-14.88	29.83	1.29	QP
6	966.261	32.64	54.00	-21.36	29.85	2.79	QP

Note:

1. All Readings below 1GHz are Quasi-Peak, above 1GHz are performed with peak and/or average measurements as necessary.
2. Measurement Level = Reading Level + Correct Factor.
3. Correct Factor = Antenna factor + Cable loss – Amplifier gain.
4. The emission levels of other frequencies are very lower than the limit and not show in test report.
5. No emission found between lowest internal used/generated frequency to 30MHz.

Product : BF-IDU07
 Test Item : General Radiated Emission
 Test Mode : Mode 1: Transmit (915.25MHz)
 Test Date : 2020/09/24
 Model No. : BIS U-626-069-111-06-ST31

Vertical

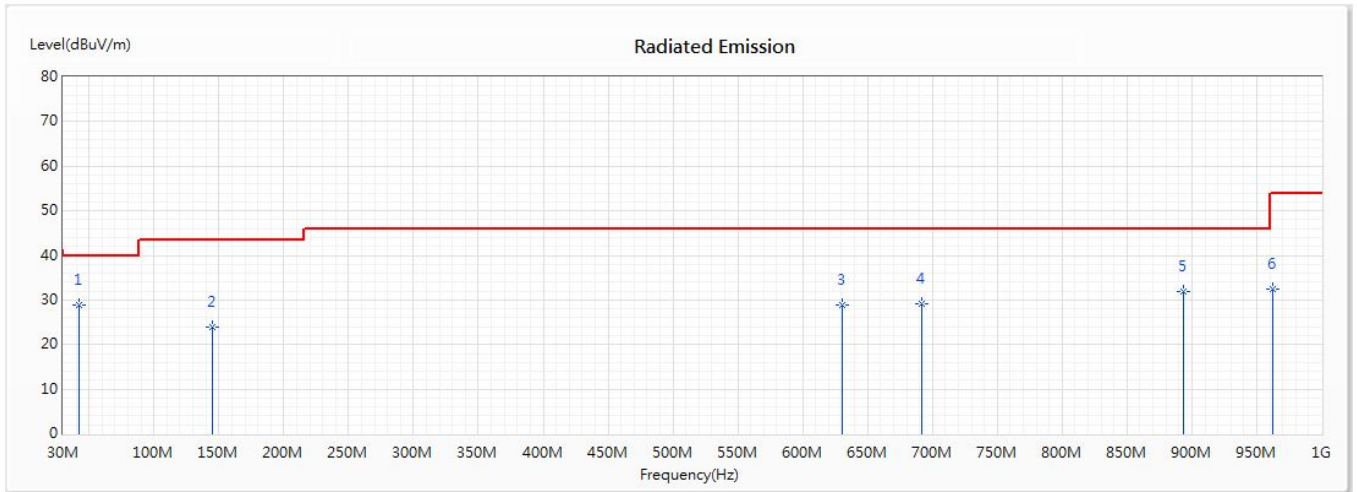

No	Frequency (MHz)	Emission Level (dBμV/m)	Limit (dBμV/m)	Margin (dB)	Reading Level (dBμV)	Correct Factor (dB/m)	Detector Type
* 1	42.652	28.97	40.00	-11.03	39.50	-10.53	QP
2	145.275	23.97	43.50	-19.53	34.48	-10.51	QP
3	630.275	28.88	46.00	-17.12	30.74	-1.86	QP
4	692.13	29.18	46.00	-16.82	30.47	-1.29	QP
5	893.159	31.82	46.00	-14.18	30.15	1.67	QP
6	962.043	32.34	54.00	-21.66	29.63	2.71	QP

Note:

1. All Readings below 1GHz are Quasi-Peak, above 1GHz are performed with peak and/or average measurements as necessary.
2. Measurement Level = Reading Level + Correct Factor.
3. Correct Factor = Antenna factor + Cable loss – Amplifier gain.
4. The emission levels of other frequencies are very lower than the limit and not show in test report.
5. No emission found between lowest internal used/generated frequency to 30MHz.

Product : BF-IDU07
 Test Item : General Radiated Emission
 Test Mode : Mode 1: Transmit (915.25MHz)
 Test Date : 2020/09/24
 Model No. : BIS U-626-069-111-06-ST32

Horizontal

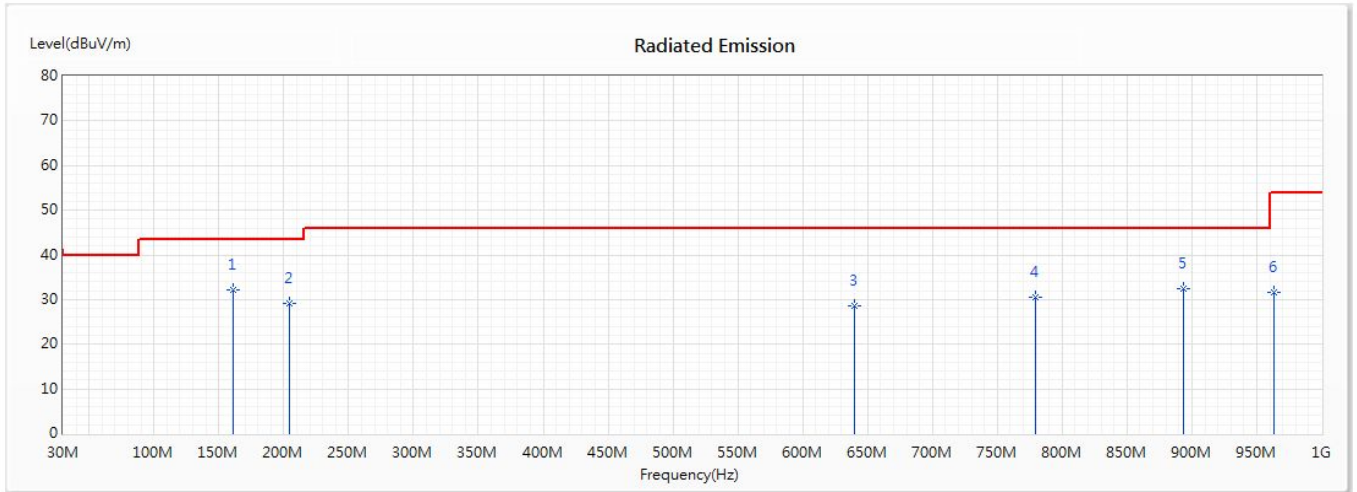

No	Frequency (MHz)	Emission Level (dBμV/m)	Limit (dBμV/m)	Margin (dB)	Reading Level (dBμV)	Correct Factor (dB/m)	Detector Type
* 1	160.739	32.28	43.50	-11.22	42.37	-10.09	QP
2	204.319	29.05	43.50	-14.45	41.38	-12.33	QP
3	640.116	28.71	46.00	-17.29	30.57	-1.86	QP
4	779.29	30.62	46.00	-15.38	30.16	0.46	QP
5	893.159	32.38	46.00	-13.62	30.71	1.67	QP
6	963.449	31.75	54.00	-22.25	28.98	2.77	QP

Note:

1. All Readings below 1GHz are Quasi-Peak, above 1GHz are performed with peak and/or average measurements as necessary.
2. Measurement Level = Reading Level + Correct Factor.
3. Correct Factor = Antenna factor + Cable loss – Amplifier gain.
4. The emission levels of other frequencies are very lower than the limit and not show in test report.
5. No emission found between lowest internal used/generated frequency to 30MHz.

Product : BF-IDU07
 Test Item : General Radiated Emission
 Test Mode : Mode 1: Transmit (915.25MHz)
 Test Date : 2020/09/21
 Model No. : BIS U-626-069-111-06-ST32

Vertical

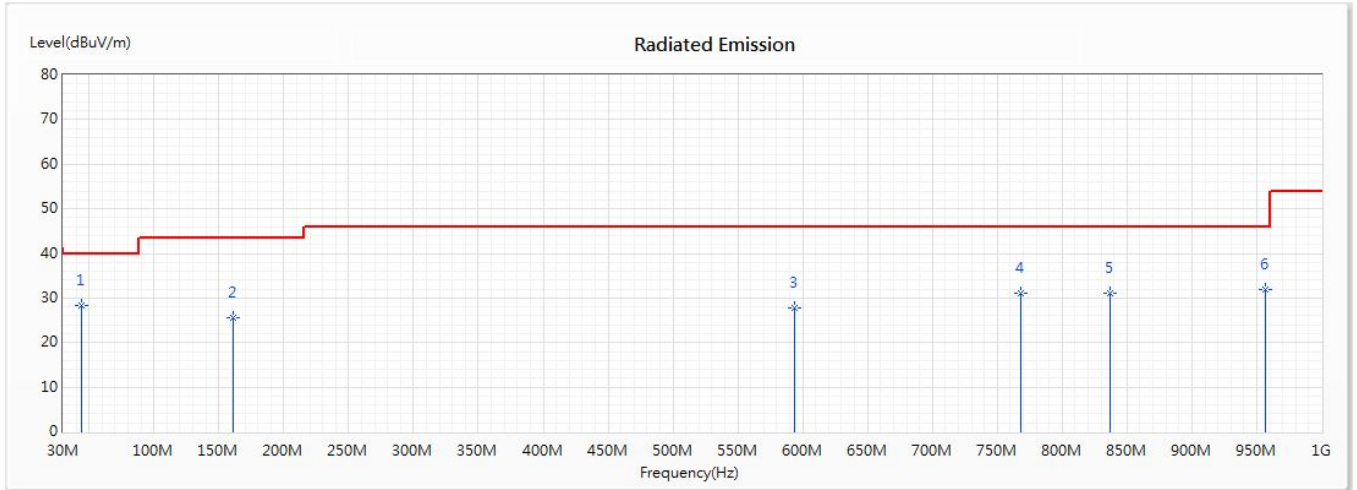

No	Frequency (MHz)	Emission Level (dBμV/m)	Limit (dBμV/m)	Margin (dB)	Reading Level (dBμV)	Correct Factor (dB/m)	Detector Type
* 1	44.058	28.21	40.00	-11.79	38.69	-10.48	QP
2	160.739	25.48	43.50	-18.02	35.57	-10.09	QP
3	593.725	27.70	46.00	-18.30	30.07	-2.37	QP
4	768.043	30.95	46.00	-15.05	30.65	0.30	QP
5	836.928	31.20	46.00	-14.80	30.15	1.05	QP
6	956.42	31.92	46.00	-14.08	29.30	2.62	QP

Note:

1. All Readings below 1GHz are Quasi-Peak, above 1GHz are performed with peak and/or average measurements as necessary.
2. Measurement Level = Reading Level + Correct Factor.
3. Correct Factor = Antenna factor + Cable loss – Amplifier gain.
4. The emission levels of other frequencies are very lower than the limit and not show in test report.
5. No emission found between lowest internal used/generated frequency to 30MHz.

5. RF Antenna Conducted Test

5.1. Test Setup

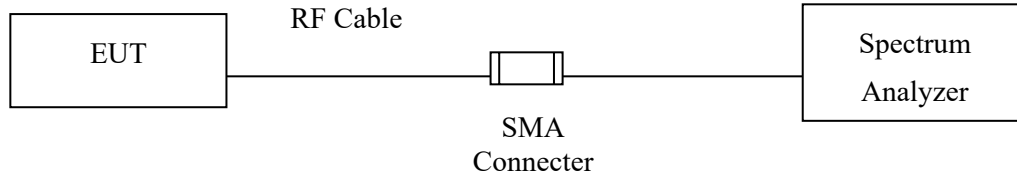

5.2. Limits

According to FCC Section 15.247(d). In any 100 kHz bandwidth outside the frequency band in which the spread spectrum or digitally modulated intentional radiator is operating, the radio frequency power that is produced by the intentional radiator shall be at least 20 dB below that in the 100 kHz bandwidth within the band that contains the highest level of the desired power, based on either an RF conducted or measurement, provided the transmitter demonstrates compliance with the peak conducted power limits. If the transmitter complies with the conducted power limits based on the use of RMS averaging over a time interval, the attenuation required under this paragraph shall be 30 dB instead of 20 dB.

5.3. Test Procedure

Tested according to FHSS test procedure of KDB558074 section 9 b) for compliance to FCC 47CFR 15.247 requirements.

5.4. Test Result of RF Antenna Conducted Test

Product : BF-IDU07
 Test Item : RF Antenna Conducted Test
 Test Mode : Mode 1: Transmit
 Test Date : 2020/07/23

Figure Channel 1:

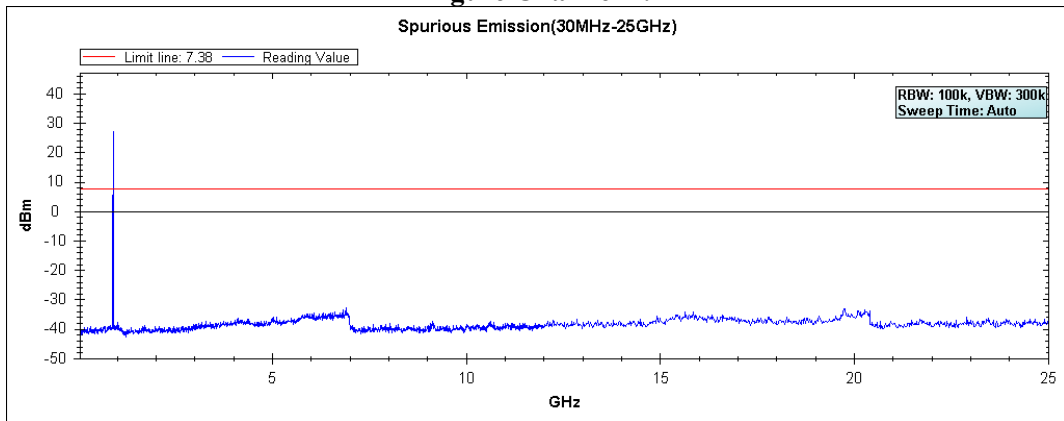

Figure Channel 26:

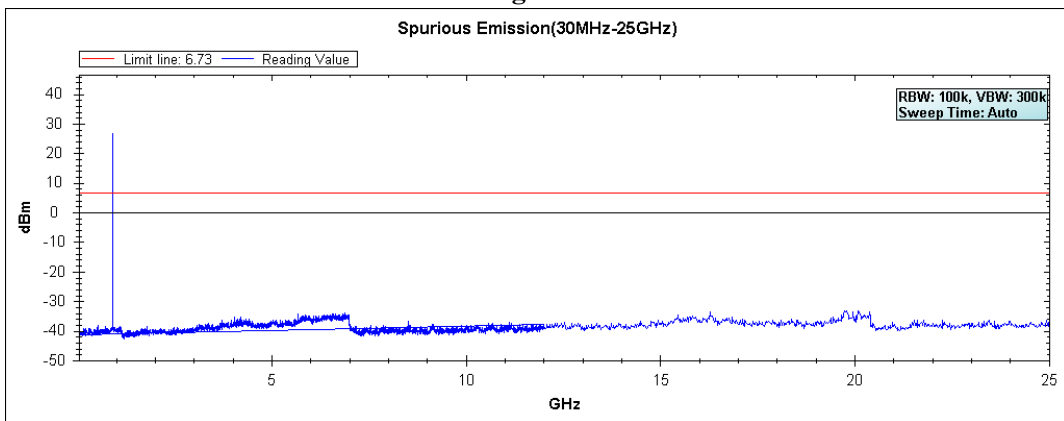
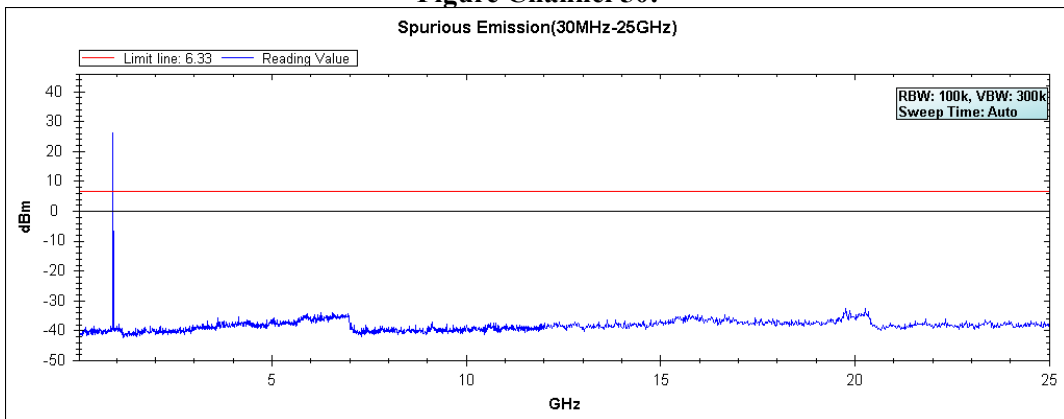

Figure Channel 50:



Note: The above test pattern is synthesized by multiple of the frequency range.

6. Band Edge

6.1. Test Setup

RF Conducted Measurement

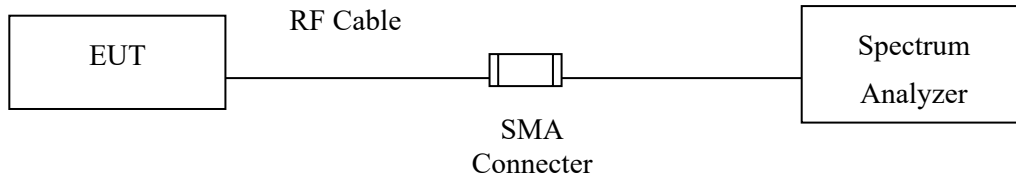

RF Radiated Measurement:

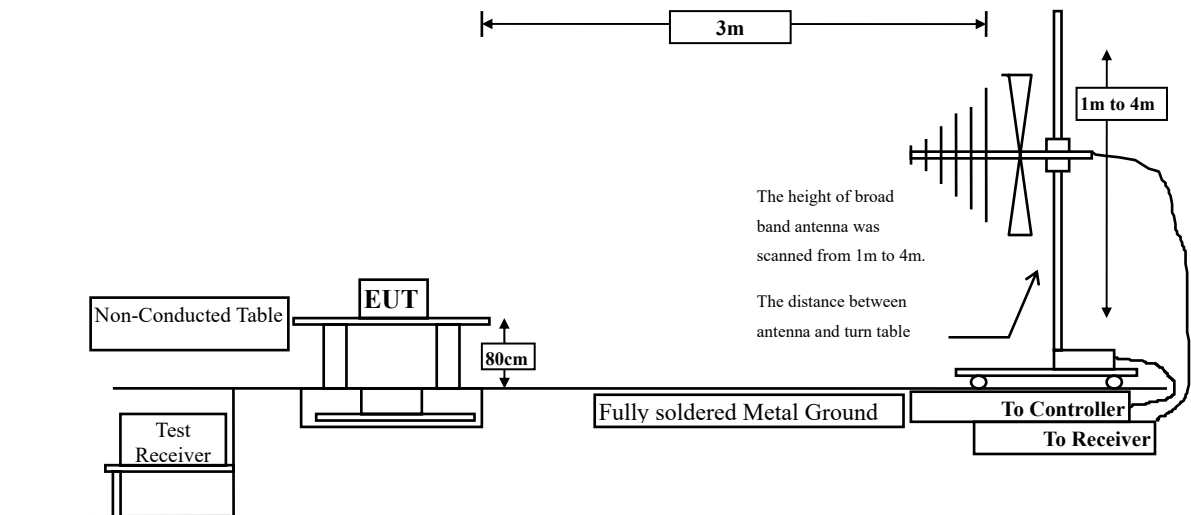

6.2. Limit

According to FCC Section 15.247(d). In any 100 kHz bandwidth outside the frequency band in which the spread spectrum or digitally modulated intentional radiator is operating, the radio frequency power that is produced by the intentional radiator shall be at least 20 dB below that in the 100 kHz bandwidth within the band that contains the highest level of the desired power, based on either an RF conducted or measurement, provided the transmitter demonstrates compliance with the peak conducted power limits. If the transmitter complies with the conducted power limits based on the use of RMS averaging over a time interval, the attenuation required under this paragraph shall be 30 dB instead of 20 dB. Attenuation below the general limits specified in Section 15.209(a) is not required. In addition, radiated emissions which fall in the restricted bands, as defined in Section 15.205(a), must also comply with the radiated emission limits specified in Section 15.209(a) (see Section 15.205(c)).

6.3. Test Procedure

The EUT is placed on a turn table which is 0.8 meter above ground. The turn table is rotated 360 degrees to determine the position of the maximum emission level. The EUT was positioned such that the distance from antenna to the EUT was 3 meters.

The antenna can move up and down between 1 meter and 4 meters to find out the maximum emission level.

Both horizontal and vertical polarization of the antenna are set on measurement. In order to find the maximum emission, all of the interface cables must be manipulated according to ANSI C63.10: 2013 on radiated measurement.

The bandwidth setting below 1GHz and above 1GHz on the field strength meter is 120 kHz and 1MHz, respectively.

6.4. Test Result of Band Edge

Product : BF-IDU07
 Test Item : Band Edge
 Test Mode : Mode 1: Transmit (Hopping off)
 Test Date : 2020/07/23

Measurement Level	Result
Δ (dB)	
> 20	PASS

Figure Channel 1:

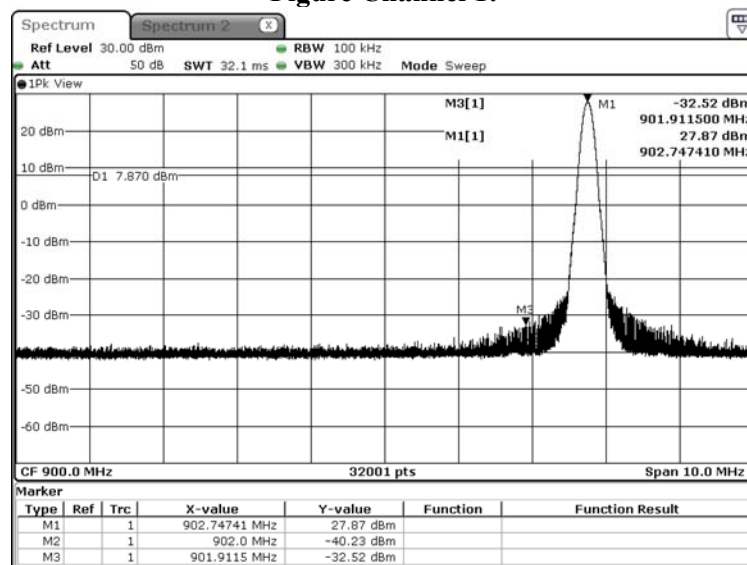

Date: 23 JUL 2020 13:42:33

Figure Channel 50:

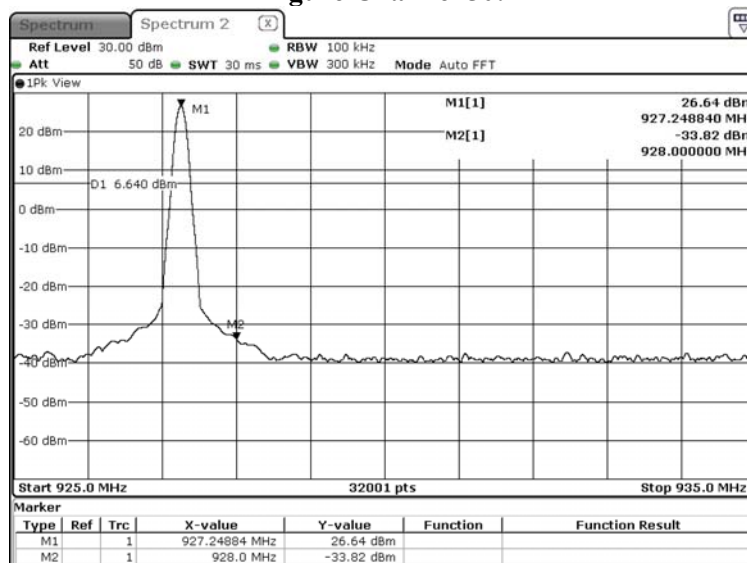

Date: 23 JUL 2020 13:45:29

Product : BF-IDU07
 Test Item : Band Edge
 Test Mode : Mode 1: Transmit (Hopping on)
 Test Date : 2020/07/23

Measurement Level	Result
Δ (dB)	
> 20	PASS

Figure Channel Hopping 1:

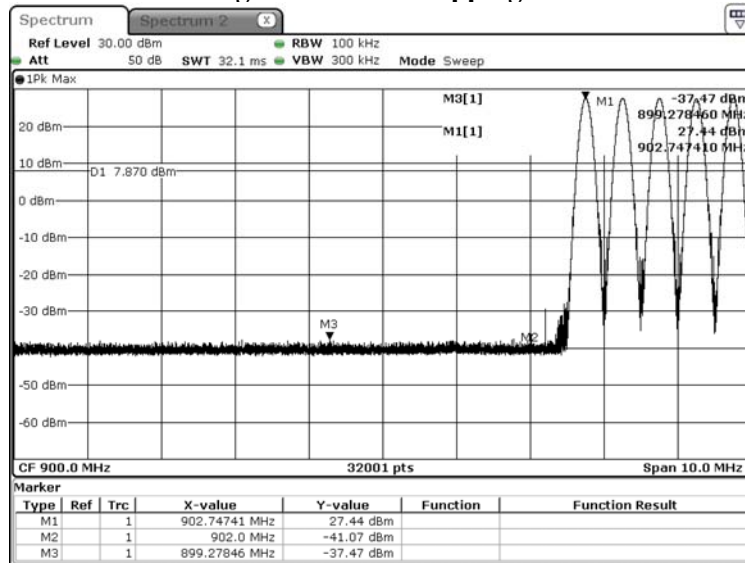

Date: 23 JUL 2020 13:48:57

Figure Channel Hopping 50:

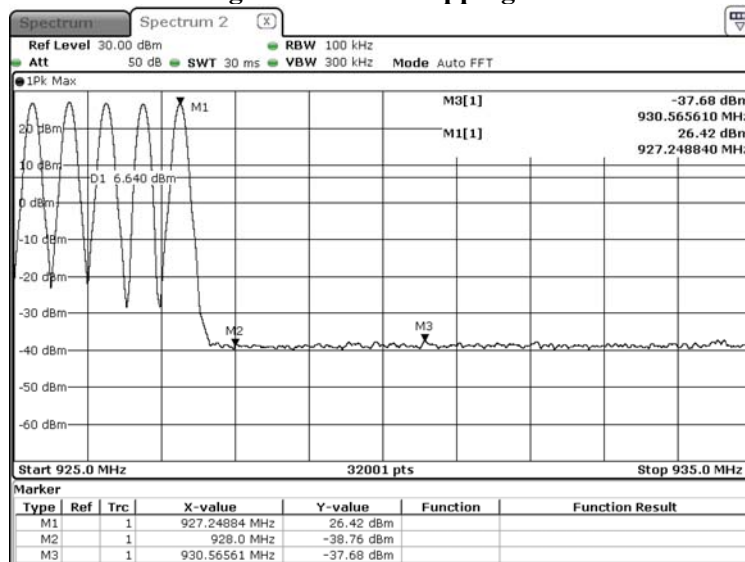

Date: 23 JUL 2020 13:47:09

7. Channel Number

7.1. Test Setup

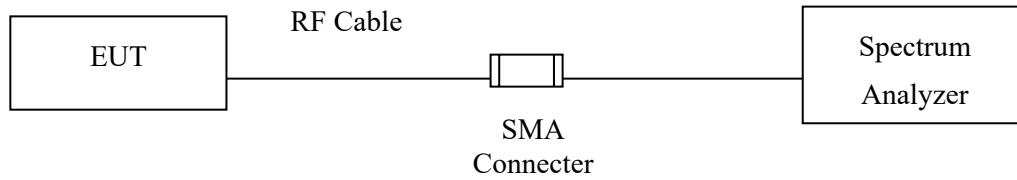

7.2. Limit

According to FCC Section 15.247(a)(1)(i). For frequency hopping systems operating in the 902-928 MHz band: if the 20 dB bandwidth of the hopping channel is less than 250 kHz, the system shall use at least 50 hopping frequencies; if the 20 dB bandwidth of the hopping channel is 250 kHz or greater, the system shall use at least 25 hopping frequencies.

7.3. Test Procedure

Tested according to FHSS test procedure of KDB558074 section 9 (b for compliance to FCC 47CFR 15.247 requirements).

7.4. Test Result of Channel Number

Product : BF-IDU07
 Test Item : Channel Number
 Test Mode : Mode 1: Transmit
 Test Date : 2020/07/22

Frequency Range (MHz)	Measurement (Hopping Channel)	Required Limit (Hopping Channel)	Result
902.75 ~ 927.25	50	≧ 50	Pass

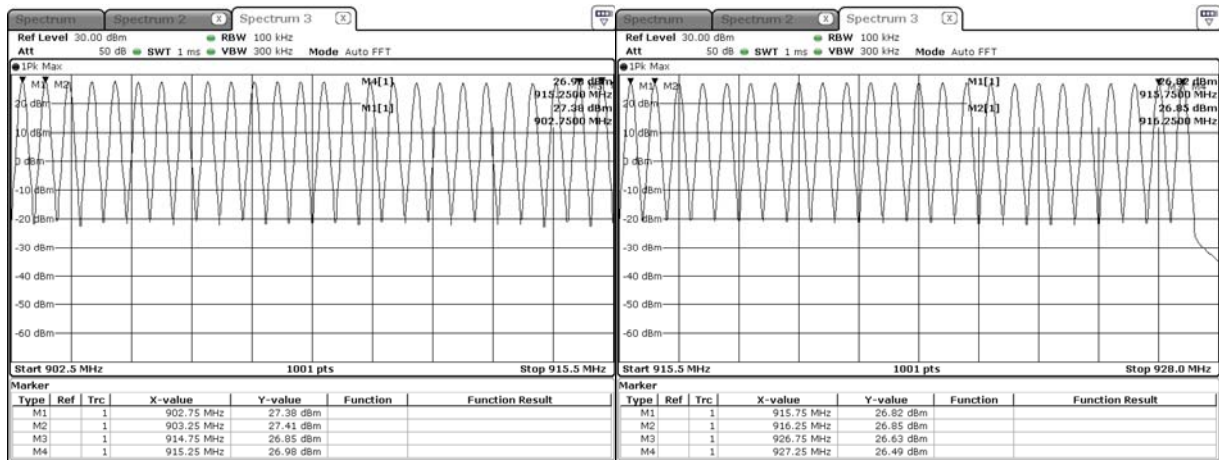

Date: 22 JUL 2020 17:02:50

Date: 22 JUL 2020 17:00:42

8. Channel Separation

8.1. Test Setup

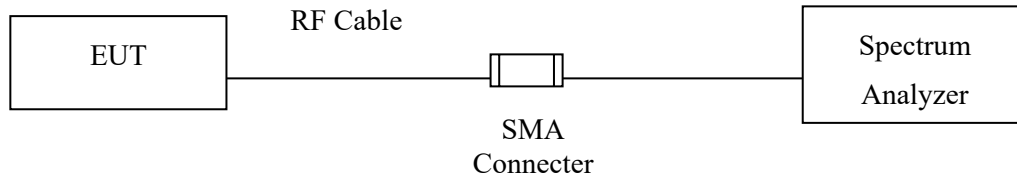

8.2. Limit

According to FCC Section 15.247(a)(1). Frequency hopping systems shall have hopping channel carrier frequencies separated by a minimum of 25 kHz or the 20 dB bandwidth of the hopping channel, whichever is greater.

8.3. Test Procedure

Tested according to FHSS test procedure of KDB558074 section 9 (b for compliance to FCC 47CFR 15.247 requirements.

8.4. Test Result of Channel Separation

Product : BF-IDU07
 Test Item : Channel Separation
 Test Mode : Mode 1: Transmit
 Test Date : 2020/07/23

Channel No.	Frequency (MHz)	Measurement Level (kHz)	Limit (kHz)	Limit of 20dB Bandwidth (kHz)	Result
1	902.75	500	>25 kHz	70.9	Pass
26	915.25	500	>25 kHz	70.9	Pass
50	927.25	500	>25 kHz	67.9	Pass

NOTE: The 20dB Bandwidth is refer to section 10.

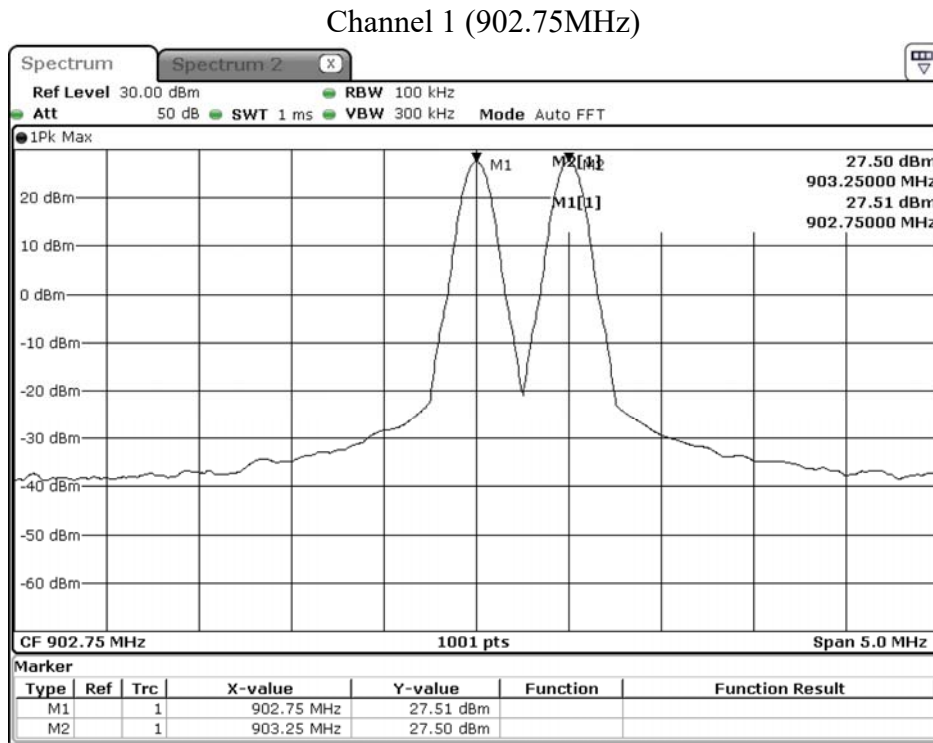

Date: 23. JUL 2020 10:01:09

Channel 26 (915.25MHz)

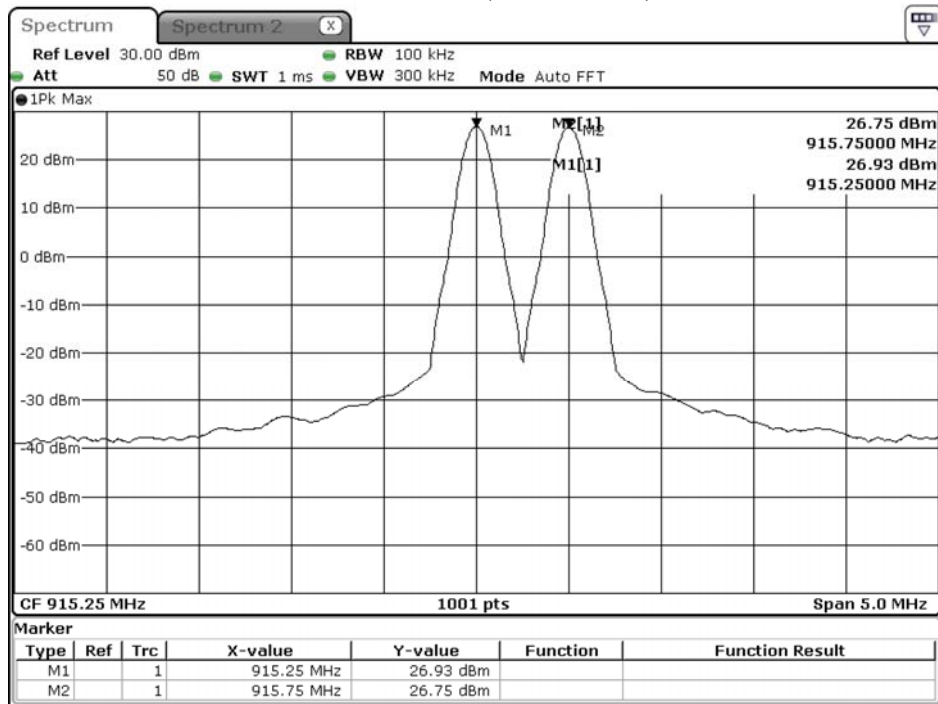

Date: 23.JUL.2020 10:02:42

Channel 50 (927.25MHz)

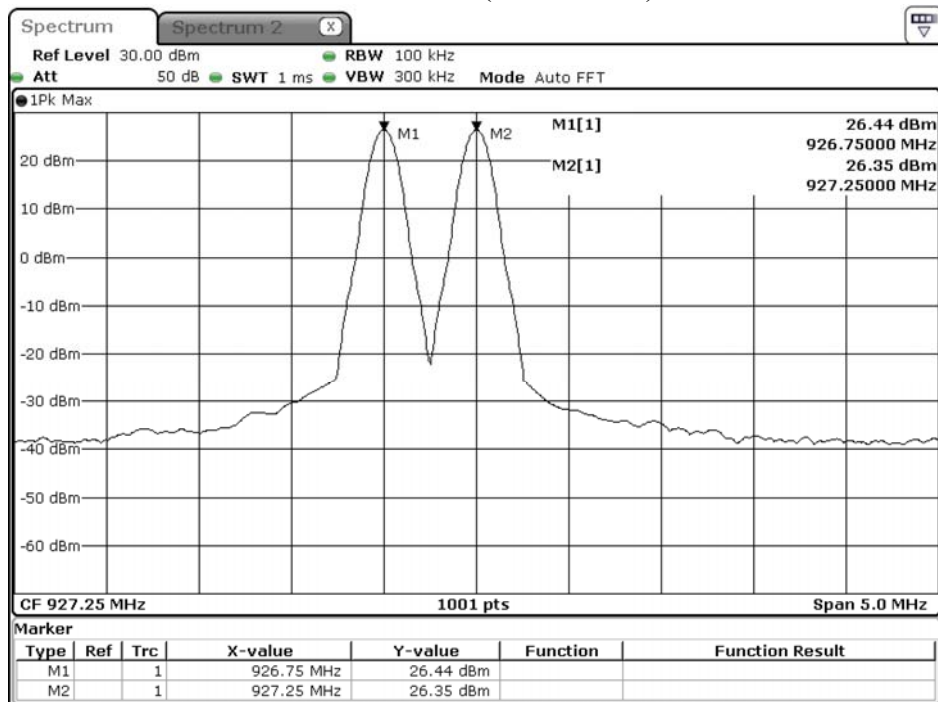

Date: 23.JUL.2020 10:04:23

9. Dwell Time

9.1. Test Setup

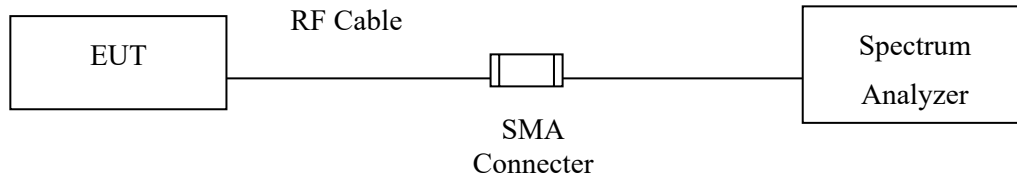

9.2. Limit

According to FCC Section 15.247(a)(1)(i). For frequency hopping systems operating in the 902-928 MHz band: if the 20 dB bandwidth of the hopping channel is less than 250 kHz, the system shall use at least 50 hopping frequencies and the average time of occupancy on any frequency shall not be greater than 0.4 seconds within a 20 second period; if the 20 dB bandwidth of the hopping channel is 250 kHz or greater, the system shall use at least 25 hopping frequencies and the average time of occupancy on any frequency shall not be greater than 0.4 seconds within a 10 second period.

9.3. Test Procedure

Tested according to FHSS test procedure of KDB558074 section 9 (b for compliance to FCC 47CFR 15.247 requirements).

9.4. Test Result of Dwell Time

Product : BF-IDU07
 Test Item : Dwell Time
 Test Mode : Mode 1: Transmit
 Test Date : 2020/07/23

Frequency (MHz)	Time slot length (ms)	Hopping of Number	Sweep time (ms)	Dwell Time (ms)	Limit (ms)	Result
902.75	21.100	8	20000	168.800	400	Pass
915.25	21.100	8	20000	168.800	400	Pass
927.25	21.400	8	20000	171.200	400	Pass

Dwell time = Time slot length(ms)*Hopping of Number

CH 1 Time slot length

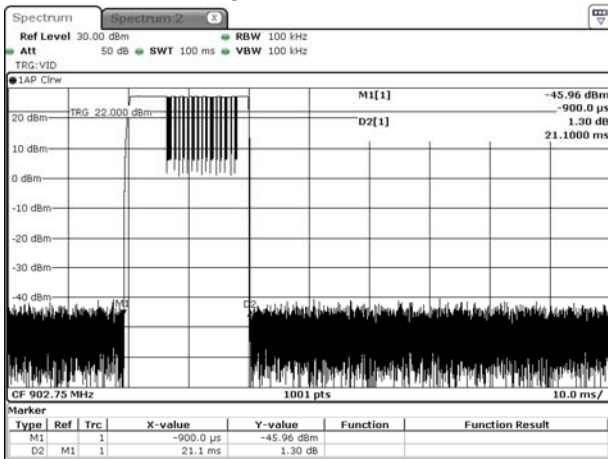

Date: 23 JUL 2020 11:00:28

CH 1 Hopping of Number

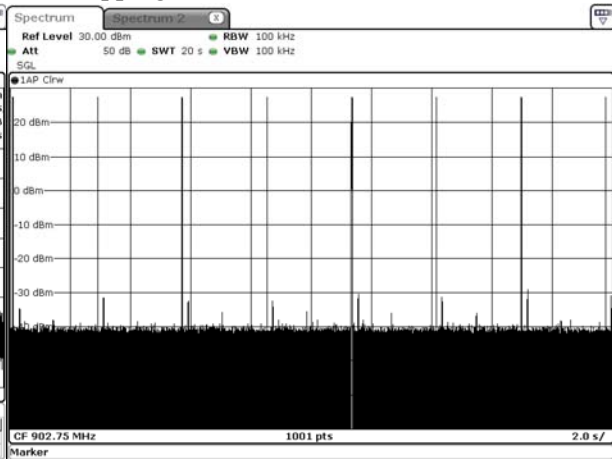

Date: 23 JUL 2020 10:57:37

CH 26 Time slot length

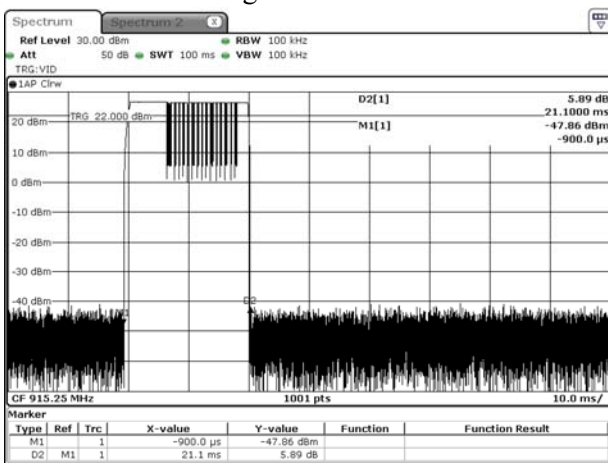

Date: 23 JUL 2020 11:01:18

CH 26 Hopping of Number

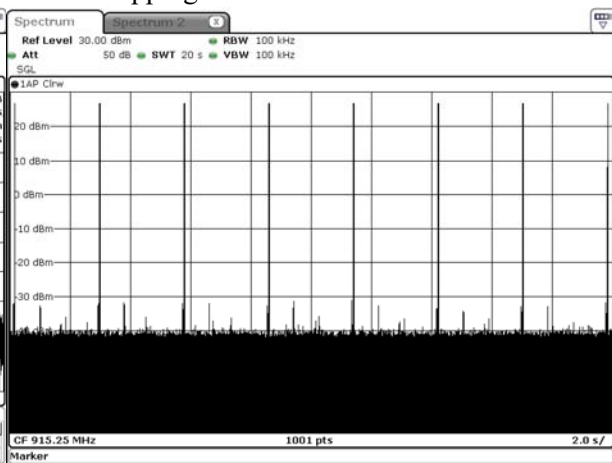

Date: 23 JUL 2020 10:44:03

CH 50 Time slot length

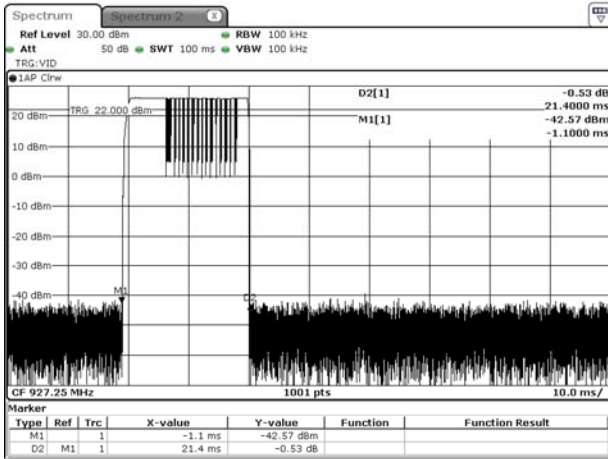

Date: 23.JUL.2020 11:02:11

CH 50 Hopping of Number

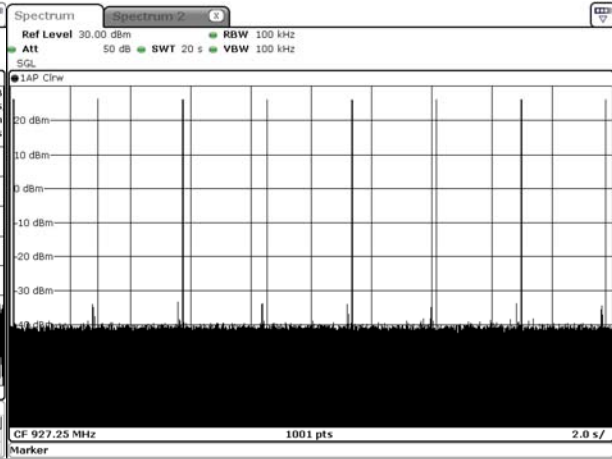

Date: 23.JUL.2020 10:53:48

10. Occupied Bandwidth

10.1. Test Setup

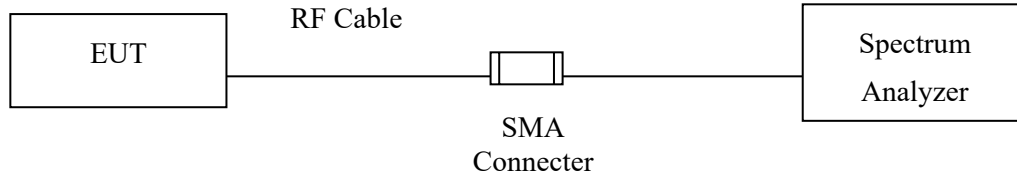

10.2. Limits

According to FCC Section 15.247(a)(1)(i). For frequency hopping systems operating in the 902-928 MHz band: if the 20 dB bandwidth of the hopping channel is less than 250 kHz, the system shall use at least 50 hopping frequencies and the average time of occupancy on any frequency shall not be greater than 0.4 seconds within a 20 second period; if the 20 dB bandwidth of the hopping channel is 250 kHz or greater, the system shall use at least 25 hopping frequencies and the average time of occupancy on any frequency shall not be greater than 0.4 seconds within a 10 second period. The maximum allowed 20 dB bandwidth of the hopping channel is 500 kHz

10.3. Test Procedure

Tested according to FHSS test procedure of KDB558074 section 9 (b for compliance to FCC 47CFR 15.247 requirements.

10.4. Test Result of Occupied Bandwidth

Product : BF-IDU07
 Test Item : Occupied Bandwidth Data
 Test Mode : Mode 1: Transmit

Channel No.	Frequency (MHz)	Measurement Level (kHz)	Required Limit (kHz)	Result
1	902.75	47.80	< 500kHz	Pass
26	915.25	46.30	< 500kHz	Pass
50	927.25	47.80	< 500kHz	Pass

Figure Channel 1:

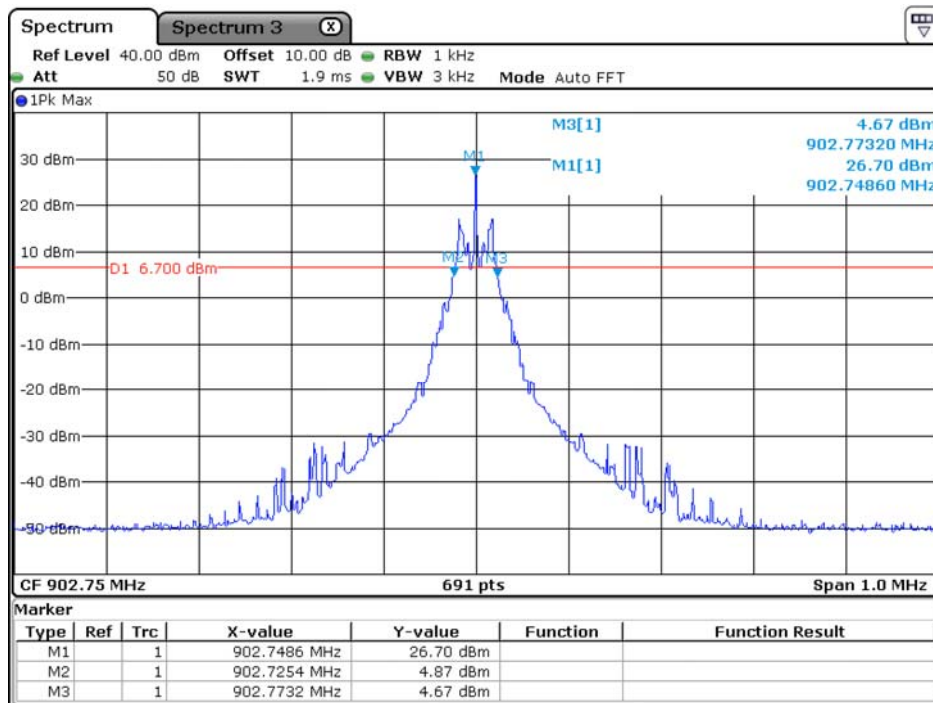

Date: 25 JAN.2021 16:30:10

Figure Channel 26:

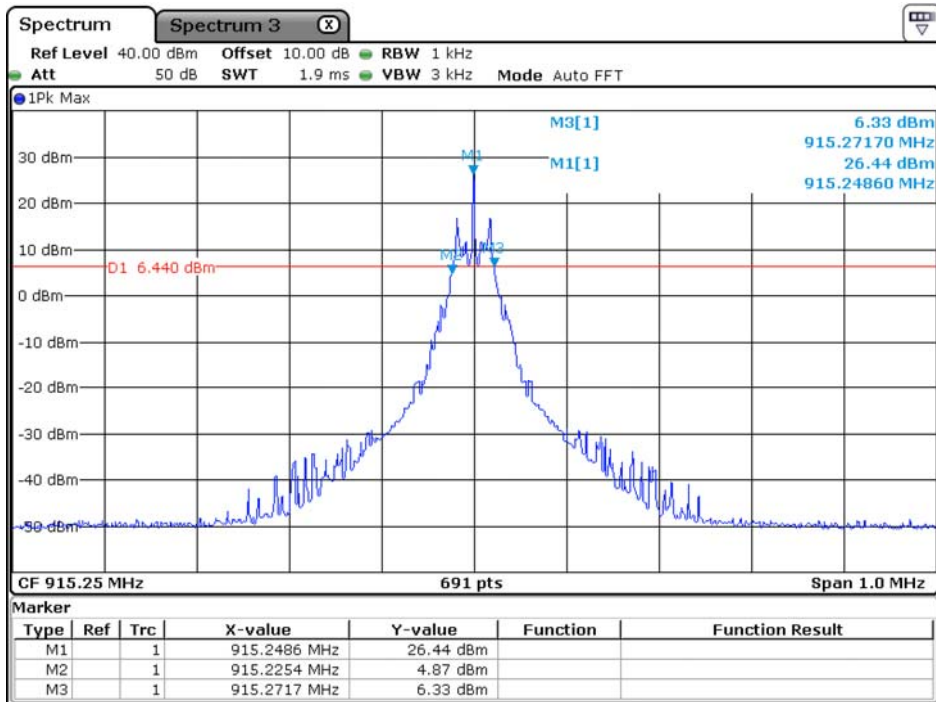

Date: 25.JAN.2021 16:27:06

Figure Channel 50:

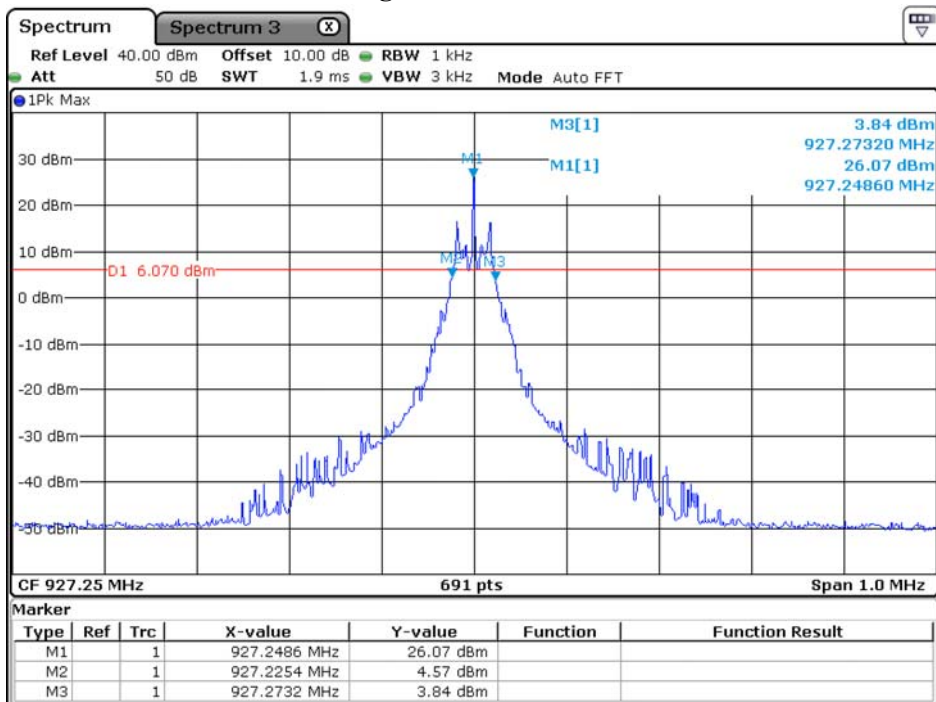

Date: 25.JAN.2021 16:25:34

11. Duty Cycle

11.1. Test Setup

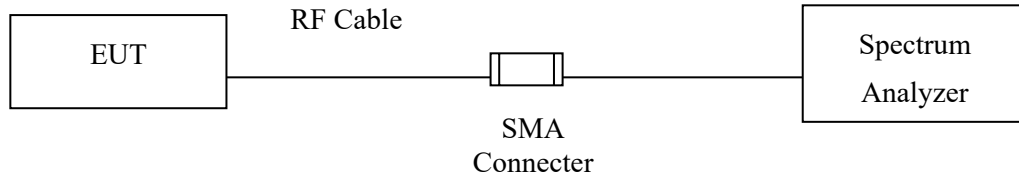

11.2. Test Result of Duty Cycle

Product : BF-IDU07
 Test Item : Duty Cycle Data
 Test Mode : Mode 1: Transmit

Figure Channel 1:

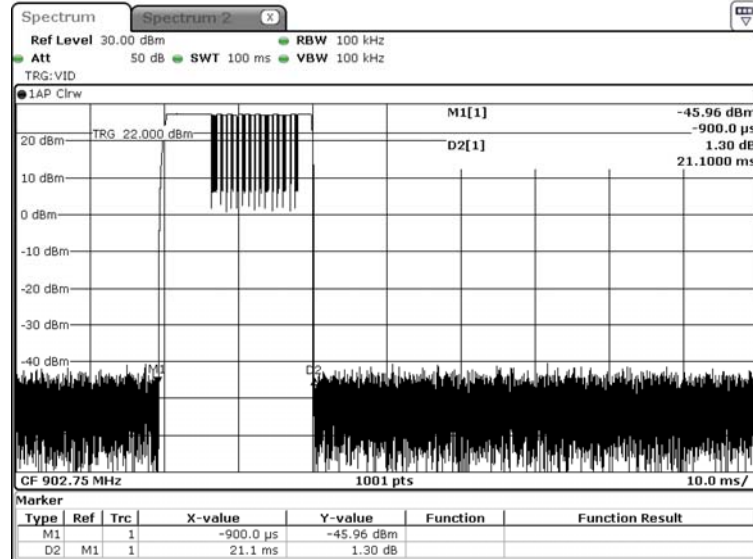

Date: 23 JUL 2020 11:00:28

Time on of 100ms= 21.100ms

Duty Cycle= $\frac{21.1\text{ms}}{100\text{ms}} = 0.211$

Duty Cycle correction factor= $20 \text{ LOG } 0.211 = -13.514 \text{ dB}$

Duty Cycle correction factor	-13.514	dB
-------------------------------------	----------------	-----------

12. EMI Reduction Method During Compliance Testing

No modification was made during testing.