

*wireless - sans fil*

# LS35X

GAMING HEADSET | CASQUE DE JEU



USER GUIDE  
GUIDE D'UTILISATION  
BEDIENUNGSANLEITUNG  
GUÍA DE USO  
MANUALE D'USO



1



2



3

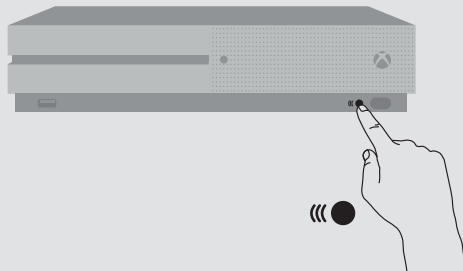

## XBOX ONE

**EN** To complete setup for Xbox One and enable surround sound go to:

**FR** Pour terminer la configuration de la Xbox One et activer le son surround, allez à:

**DE** Um Setup für Xbox One abzuschließen und Surround-Sound zu aktivieren, gehe zu:

**IT** Per completare l'installazione di Xbox One e attivare il suono surround, vai a:

**ES** Para completar la configuración de Xbox One y habilitar el sonido envolvente, vaya a:



<https://bit.ly/2Oryut0>

## !!! IMPORTANT | WICHTIG | IMPORTANTE !!!

## PC

**EN** For detailed setup instructions for PC go to:

**FR** Pour des instructions de configuration détaillées pour PC, allez à:

**DE** Für detaillierte Setup-Anweisungen für PC gehen Sie zu:

**IT** Per istruzioni dettagliate sulla configurazione del PC, consultare:

**ES** Para obtener instrucciones de configuración detalladas para PC, vaya a:



<https://bit.ly/2vxTB5F>



[L]



**Center Button  
Game Mute**

**Game Volume Wheel**

**Power/Charging LED**

Solid = ON/Connected/Charged  
 Slow Blink = Not Connected  
 Fast Blink = Connecting  
 Pulsing = Charging

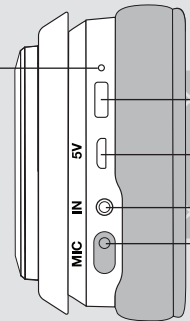

**Power Button**

**USB Charging Port**

**Mobile 3.5mm Port  
Microphone Port**



[R]

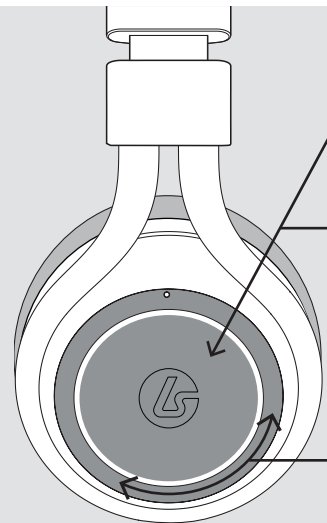

**Mic Monitoring**

Mic Monitor On/Off = Press and hold  
for 3 seconds

**Mic Mute**

Mute/Unmute = Short Press

LED on Boom Mic  
illuminates when muted

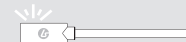

**Game / Chat  
Balance**

**Connect Button**

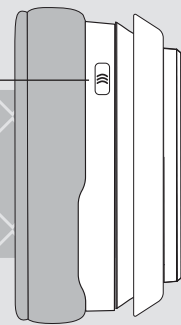

EN

## ACCESSORIES



## MICROPHONE

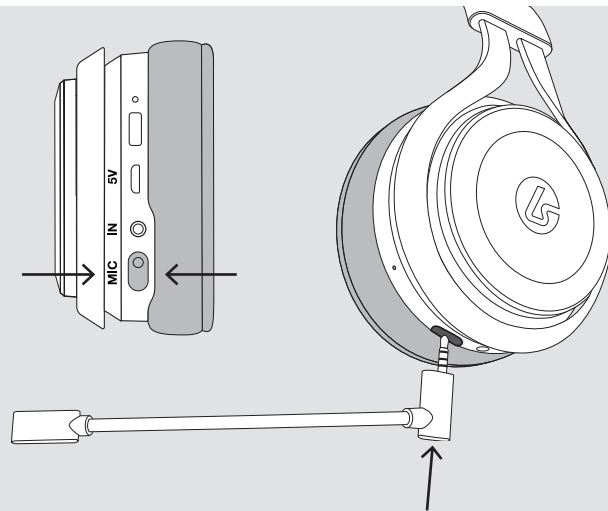
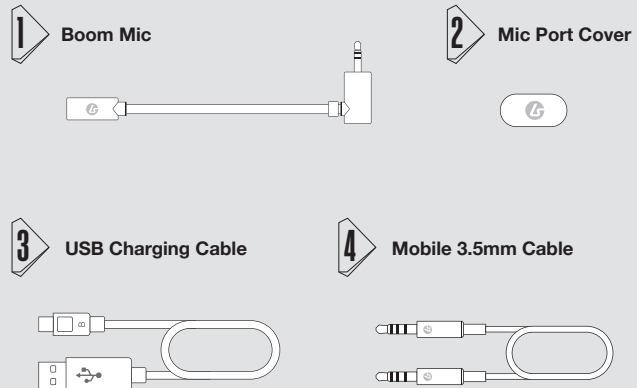

## CHARGING



Pulsing = Charging  
Solid = Charged

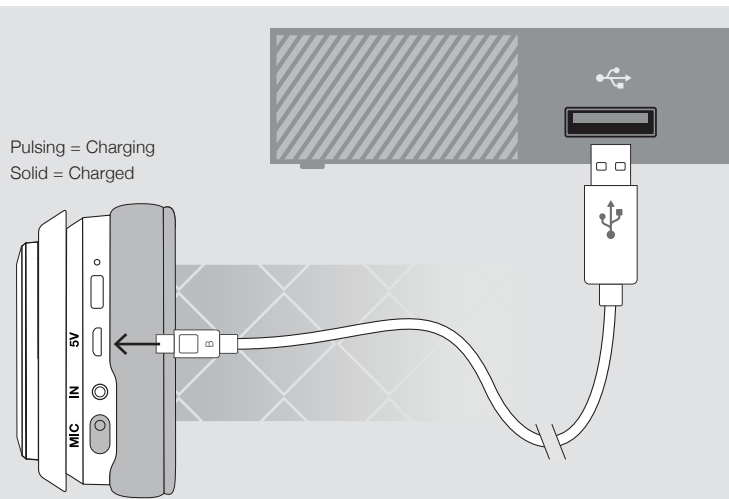

## MOBILE SETUP



EN

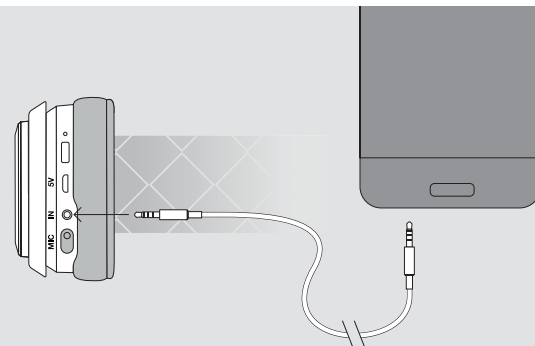

Connect the included 3.5mm cable between the headset and your mobile device.

Press the left earcup center button to control your mobile device (on supported devices). When the headset is powered on, the volume and mic mute features function.

The headset can also be used when powered off, but only the left earcup button will function.

**Model No:** LS35X    **IC:** 21203-LS35X    **LucidSound, Inc.**    Made in China

RF Frequency: 2.412-2.462GHz, 5.15-5.85 GHz  
 Manufacturer: LucidSound, Inc.  
 Importer: Information can be found at lucidsound.com

#### FCC Statement

This equipment has been tested and found to comply with the limits for a Class B digital device, pursuant to part 15 of the FCC rules. These limits are designed to provide reasonable protection against harmful interference in a residential installation. This equipment generates, uses and can radiate radio frequency energy and, if not installed and used in accordance with the instructions, may cause harmful interference to radio communications. However, there is no guarantee that interference will not occur in a particular installation. If this equipment does cause harmful interference to radio or television reception, which can be determined by turning the equipment off and on, the user is encouraged to try to correct the interference by one or more of the following measures:

- Reorient or relocate the receiving antenna.
- Increase the separation between the equipment and receiver.
- Connect the equipment into an outlet on a circuit different from that to which the receiver is connected.
- Consult the dealer or an experienced radio/TV technician for help.

This equipment complies with Part 15 of the FCC Rules. Operation is subject to the following two conditions:

- (1) This device may not cause harmful interference, and
- (2) This device must accept any interference received, including interference that may cause undesired operation.

This device complies with FCC SAR exposure limits set forth for an uncontrolled environment The equipment can be used in close proximity to the human body without any restrictions.

#### Caution!

The manufacturer is not responsible for any radio or TV interference caused by unauthorized modifications to this equipment. Such modifications could void the user authority to operate the equipment.

This device complies with FCC exposure limits set forth for an uncontrolled environment

This device complies with Industry Canada licence-exempt RSS-247 standard. Operation is subject to the following two conditions: (1) this device may not cause interference, and (2) this device must accept any interference, including interference that may cause undesired operation of the device.

#### IC Radiation Exposure Statement:

This equipment complies with IC RSS-102 radiation exposure limits set forth for an uncontrolled environment. This equipment should be installed and operated with minimum distance 0 cm between the radiator and your body.

#### EU DECLARATION OF CONFORMITY



Hereby we guarantee that snakebyte distribution GmbH, located at 13 Konrad-Zuse-Str., Schwerte 58239, Germany, is marketing this device LS35X under the brand name LucidSound and complies with the legal requirements and the requirements of Directive 2014/53/EU. This notification is listed under:  
[lucidsound.com/EUDOC](http://lucidsound.com/EUDOC).

#### WEEE (Waste Electrical and Electronic Equipment Directive)

If you eventually want to dispose of this product at a later time, please observe the following instructions: Electronic equipment should not be disposed of together with household waste. Please recycle the device if the appropriate recycling ways are available to you. Please contact your local authority or retailer and ask them for advice on recycling.

#### RoHS

This product has been certified as RoHS compliant in accordance with Directive 2011/65/CE.

#### Disposal of Batteries/Rechargeable Batteries

Please follow regional guidelines for the disposal of rechargeable batteries or contact local authorities, your household waste disposal service or the shop where you purchased the product. Batteries/rechargeable batteries must not be disposed of into the normal household garbage. Please use a rechargeable battery disposal in your neighborhood or community, if available.



#### Warranty

LucidSound, Inc. warrants this product to be free from defects in materials and workmanship for the warranty period. This non-transferable, 1-year limited warranty is only to you, the first end-user purchaser. If a defect covered by this warranty occurs AND you provide proof of purchase, LucidSound, Inc., at its option, will repair or replace the product at no charge (excluding shipping).

The LucidSound, Inc., 1-year limited warranty is available to customers worldwide. Your sole and exclusive remedy is repair or replacement of your LucidSound product. In no event shall LucidSound's liability exceed the original purchase price of the product. This warranty does not apply to: (a) normal wear and tear or abusive use; (b) industrial, professional or commercial use; (c) if the product has been tampered with or modified. This non-transferable warranty is only valid in the region/country in which the headset was originally purchased.

To receive warranty service, please contact us at:

**lucidsound.com**  
**(toll free) 888-661-4469**  
**1-760-579-6969**

#### Europe

LucidSound, Inc. 2-year limited warranty is available to customers in Europe.

#### Australia

Our goods come with guarantees that cannot be excluded under the Australian Consumer Law. You are entitled to a 1 year replacement warranty in which you are entitled to have the goods repaired or replaced if the goods fail to be of acceptable quality and the failure does not amount to a major failure.

What you must do:

If a defect has appeared within 90 days from the date of purchase, the product may be returned to the retailer for a replacement.

If a defect has appeared after 90 days from the date of purchase, you must initiate a repair by following the online repair process at [www.lucidsound.com.au](http://www.lucidsound.com.au).

Once all details are completed, you will receive a return authorisation number. Then, label and ship your LucidSound

headset – including the return authorisation (RA) number, freight prepaid, to LucidSound's authorised repair centre.

LucidSound  
 c/o Tecworks International Pty Ltd  
 Unit 1 / 12 Tollis Place  
 Seven Hills NSW 2141

Please ensure the return authorisation (RA) number is prominently displayed on the outside of your packaging. The cost incurred to return the product to the retailer or to the authorised repair centre as part of a Warranty claim are your responsibility.

What we will do:

During the Warranty Period, we will, at our option, repair or replace the product or any defective parts. We will also bear the reasonable costs of standard return shipping. If this cannot be done, then we will refund the purchase price to you.

AU wholesale distributor:

Bluemouth Interactive Pty Ltd, Level 2, 2 Darling Street, South Yarra, Victoria, 3141  
**Email: [support@bluemouth.com.au](mailto:support@bluemouth.com.au)**

©2019 Lucid Sound, Inc. 5939 Darwin Ct., Suite 100, Carlsbad, CA 92008 U.S.A. Microsoft, Xbox, Xbox "Sphere" Design, Xbox One, and Windows are registered trademarks of the Microsoft group of companies. All other trademarks are the property of their respective owners. The shape and design of this product are a trade dress of Lucid Sound, Inc., its subsidiaries and affiliates. All rights reserved. All other product names and images are trademarks or registered trademarks of their respective owners. Made in China. Product features, appearance and specifications may be subject to change without notice. Please retain this information for future reference.



[G]

**Diode Alimentation**

allumé = allumé/connecté/chargée  
 clignotement lent = pas connecté  
 clignotement rapide = en train de se connecter  
 pulser = en charge

**Bouton Central**  
 Coupure du son du jeu

**Volume du jeu**

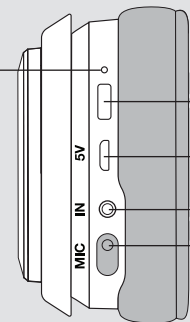

**Bouton alimentation**

**Port de charge USB**

**Prise Mobile 3,5mm**

**Prise Micro**

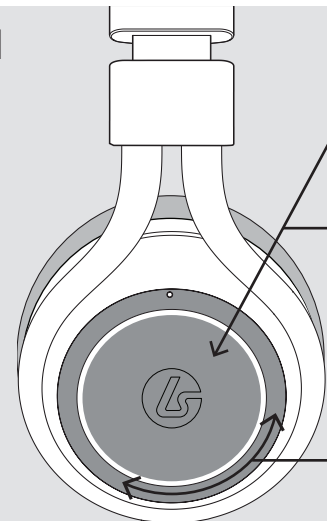

[D]

**Mic Monitoring**

Mic Monitor Marche/Arrêt = Appuyez pendant 3 secondes

**Mic Mute**

Marche/Arrêt = Pression courte

La DEL du micro s'allume en mode muet

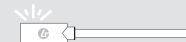

**Jeu / Chat Balance**

**Bouton «Connect»**

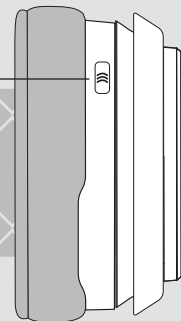

FR

## ACCESSOIRES



## MICRO EXTERNE



1

Micro externe

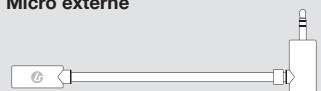

2

Couverture du prise micro externe



3

Câble de recharge USB

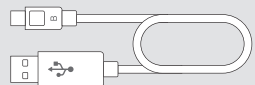

4

Câble mobile 3,5mm

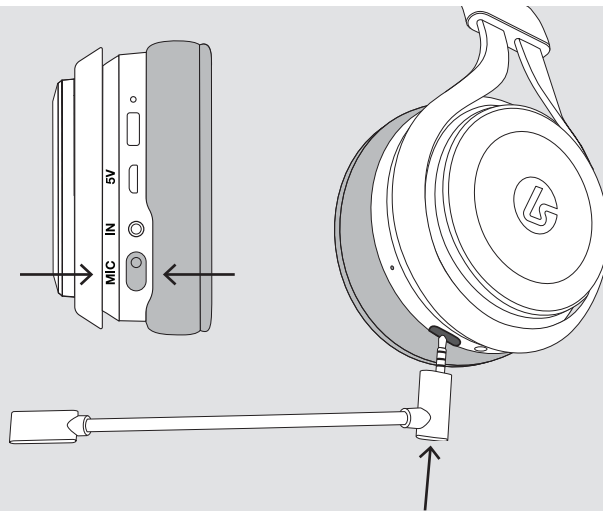
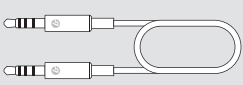

## CHARGEMENT



Pulser = en charge  
Allumé = chargée

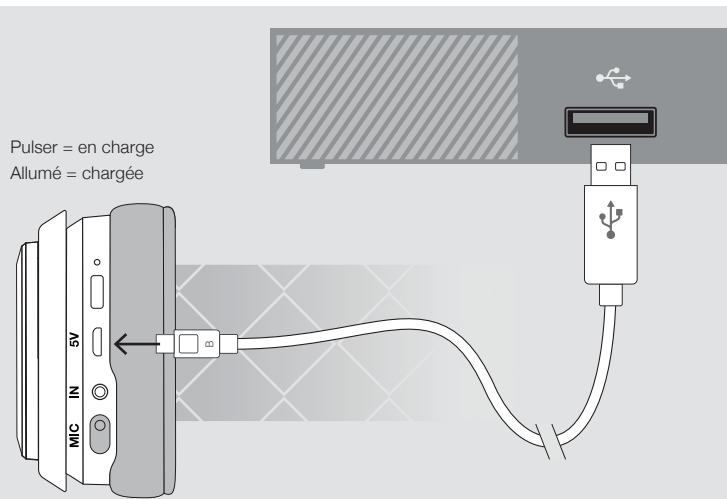

## MOBILE



FR

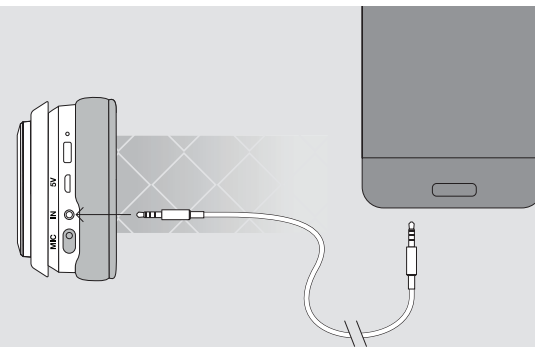

Connectez le câble 3,5 mm inclus entre le casque et votre appareil mobile.

Appuyez sur le bouton central de l'oreillette gauche pour contrôler votre appareil mobile (sur les appareils pris en charge). Lorsque le casque est allumé, les fonctions de volume et de sourdine du microphone fonctionnent.

Le kit oreillette peut également être utilisé lorsqu'il est éteint, mais seul le bouton d'oreille gauche fonctionnera.

**Model No:** LS35X      **IC:** 21203-LS35X      LucidSound, Inc.  
Fabriqué en Chine

Fréquence RF: 2.412-2.462GHz, 5.15-5.85 GHz  
Fabricant: LucidSound, Inc.

Importateur: des informations peuvent être trouvées chez [lucidsound.com](http://lucidsound.com)

Le manuel d'utilisation des appareils radio exempts de licence doit contenir l'énoncé qui suit, ou l'équivalent, à un endroit bien en vue et/ou sur les appareils :

Le présent appareil est conforme aux CNR d'Industrie Canada applicables aux appareils radio exempts de licence. L'exploitation est autorisée aux deux conditions suivantes : (1) l'appareil ne doit pas produire de brouillage, et (2) l'utilisateur de l'appareil doit accepter tout brouillage radioélectrique subi, même si le brouillage est susceptible d'en compromettre le fonctionnement.

#### Déclaration d'exposition à la radiation:

Cet équipement respecte les limites d'exposition aux rayonnements IC RSS-102 définies pour un environnement non contrôlé. Cet équipement doit être installé et mis en marche à une distance minimale de 0.5 cm qui sépare l'élément rayonnant de votre corps.

 **DEEE (directive sur les déchets d'équipements électriques et électroniques)**  
Cet équipement respecte les limites d'exposition aux rayonnements IC RSS-102 définies pour un environnement non contrôlé. Cet équipement doit être installé et mis en marche à une distance minimale de 0.5 cm qui sépare l'élément rayonnant de votre corps.

#### RoHS

Ce produit a été certifié conforme RoHS conformément à la directive 2011/65 / CE.

#### Mise au rebut des batteries / batteries rechargeables

Veuillez suivre les directives régionales pour l'élimination des piles rechargeables ou contacter les autorités locales, votre service d'élimination des déchets ménagers ou le magasin où vous avez acheté le produit. Les piles / piles rechargeables ne doivent pas être jetées dans les ordures



LI-ION

ménagères normales. Veuillez utiliser une batterie rechargeable dans votre quartier ou votre communauté, si disponible.

#### DÉCLARATION DE CONFORMITÉ DE L'UE



Par la présente, nous garantissons que snakebyte distribution GmbH, située au 13 Konrad-Zuse-Str., Schwerte 58239 Allemagne, commercialise cet appareil LS35X sous la marque LucidSound et répond aux exigences légales et aux exigences de la directive 2014/53 / UE. Cette notification est répertoriée sous:

[lucidsound.com/EUDOC](http://lucidsound.com/EUDOC)

#### Garantie

Lucid Sound Inc garantit ce produit contre tout défaut de matériau ou de fabrication durant la période de garantie. Cette garantie limitée non transférable n'est valable que pour le premier acheteur du produit. Si un défaut couvert par cette garantie survient ET si vous avez la preuve d'achat du produit, Lucid Sound Inc, procèdera, à sa discrétion, au remplacement ou à la réparation du produit à sa charge (excepte les frais d'envoi).

La garantie limitée de 2 ans offerte par Lucid Sound Inc, est valable pour les clients Européens (Canada et États-Unis: 1 an). Le seul et unique remède est la réparation ou le remplacement de votre produit Lucid Sound. En aucun cas la responsabilité de Lucid Sound ne pourra excéder le montant initial d'achat du produit. Cette garantie ne s'applique pas à : (a) Usure normale due à l'utilisation ou utilisation abusive; (b) usage industriel, professionnel ou commercial ; (c) Si le produit a été modifié ou démonté.

Pour recevoir le service de garantie s'il vous plaît nous contacter à :

## lucidsound.com

© 2019 Lucid Sound, Inc. 5939 Darwin Ct., Suite 100, Carlsbad, CA 92008 U.S.A.

Microsoft, Xbox, Xbox "Sphere" Design, Xbox One, et Windows sont des marques déposées du groupe d'entreprises Microsoft. Toutes les autres marques commerciales appartiennent à leurs propriétaires respectifs.

Lucid Sound et le logo Lucid Sound sont des marques de commerce de Lucid Sound, Inc., de ses filiales et de ses sociétés affiliées. La forme et la conception de ce produit sont un habillage commercial de Lucid Sound, Inc., de ses filiales et de ses sociétés affiliées. Tous les droits sont réservés. Tous les autres noms de produits et images sont des marques commerciales ou des marques déposées de leurs propriétaires respectifs. Fabriqué en Chine. Les caractéristiques, l'apparence et les spécifications du produit peuvent faire l'objet de modifications sans préavis. Veuillez conserver cette information pour référence ultérieure.





[L]

**Power/Aufladen LED**

Durchgehendes Leuchten = EIN/verbunden/Aufladen  
 Langsames Blinken = Verbindungssuche  
 Schnelles Blinken = Aufladen  
 Pulsierend = Laden

**Mittlere Taste**  
 Gamesound aus/stumm

**Lautstärke Gamesound**

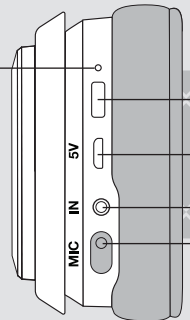

**Power-Koppeln Taste**

**USB-Ladeanschluss**

**Mobile 3,5mm Anschluss**  
**Mikrofonanschluss**

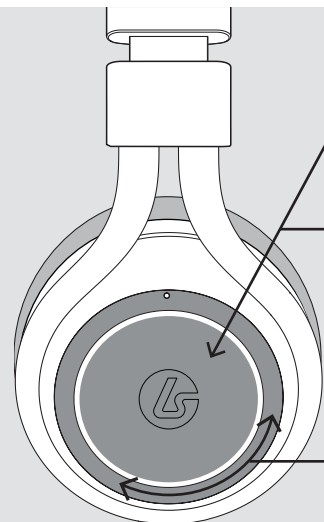

[R]

**Mikrofonmonitor**

Mikrofonmonitor aus/stumm = Drücken Sie für 3 Sekunden

**Mikrofon aus/stumm**

Mute/Unmute = Kurz drücken

LED am Mikrofonarm leuchtet, wenn das Mikrofon stumm geschaltet ist

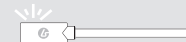

**Lautstärke Chat**

**Schaltfläche**  
**“Verbinden”**

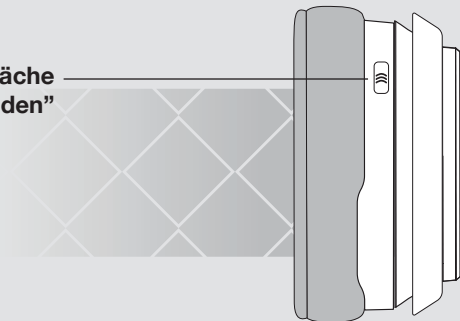

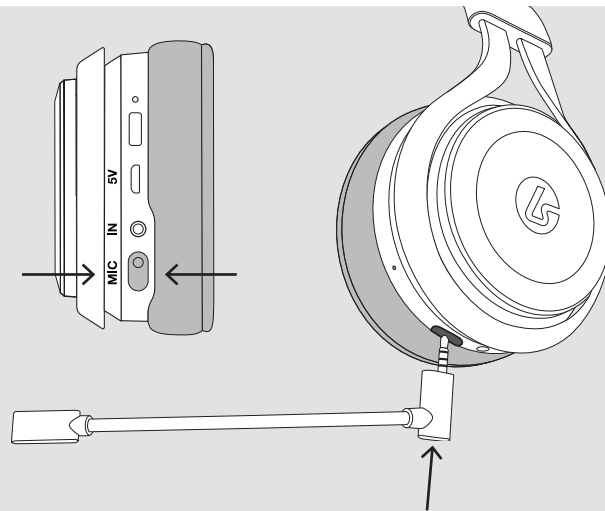
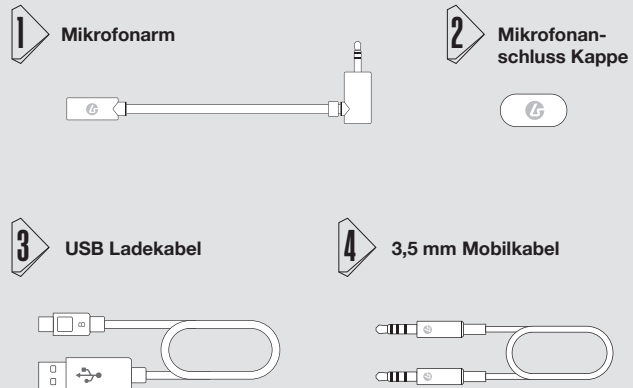

Pulsieren = Laden  
Solid = geladen

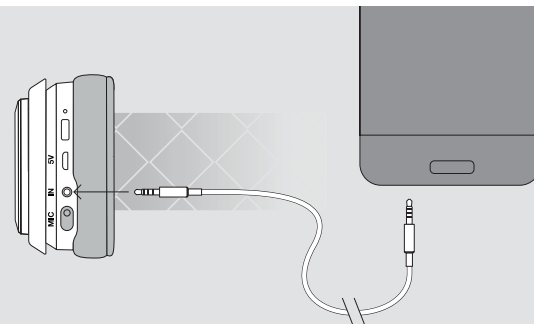
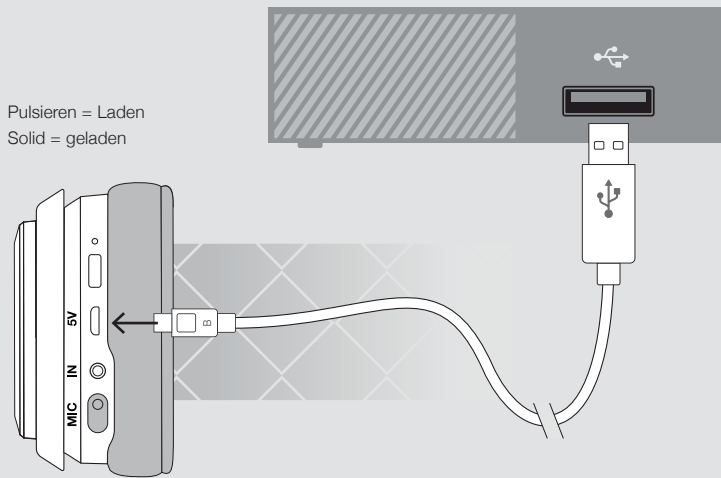

Schließen Sie das mitgelieferte 3,5-mm-Kabel zwischen dem Headset und Ihrem Mobilgerät an.

Drücken Sie die mittlere Taste der linken Ohrmuschel, um Ihr Mobilgerät zu steuern (auf unterstützten Geräten). Wenn das Headset eingeschaltet ist, funktionieren die Funktionen für Lautstärke und Mikrofonstummschaltung.

Das Headset kann auch verwendet werden, wenn es ausgeschaltet ist, aber nur die linke Ohrmuschelentaste funktioniert.

**Modell Nr:** LS35X      **IC:** 21203-LS35X      **LucidSound, Inc.**  
In China hergestellt

HF-Frequenz: 2.412-2.462GHz, 5.15-5.85 GHz  
Hersteller: LucidSound, Inc.  
Importeur: Informationen finden Sie unter lucidsound.com

Dieses Gerät entspricht dem lizenzfreien RSS-247-Standard von Industry Canada. Der Betrieb unterliegt den folgenden zwei Bedingungen: (1) Dieses Gerät darf keine Interferenzen verursachen, und (2) dieses Gerät muss jegliche Interferenz akzeptieren, einschließlich Interferenzen, die einen unerwünschten Betrieb des Geräts verursachen können.

#### IC-Strahlenbelastungserklärung:

Dieses Gerät entspricht den IC RSS-102 Strahlungsgrenzwerten, die für eine unkontrollierte Umgebung festgelegt sind. Dieses Gerät sollte mit einem Mindestabstand von 0,5 cm zwischen dem Heizkörper und Ihrem Körper installiert und betrieben werden.

#### KONFORMITÄTSERKLÄRUNG



Hiermit erklärt snakebyte distribution GmbH, Konrad-Zuse-Str. 13, Schwerte 58239 Germany, dass dieses Produkt den grundlegenden Anforderungen und anderen relevanten Auflagen der Richtlinien 2014/53/EU entspricht, soweit zutreffend. Die gemäß dem Konformitätsbewertungsverfahren erforderlichen technischen Unterlagen können an folgender Stelle eingesehen werden:

lucidsound.com/EUDOC

#### WEEE (Richtlinie über Elektro- und Elektronik-Altgeräte)

Wenn Sie dieses Produkt zu einem späteren Zeitpunkt entsorgen möchten, beachten Sie bitte folgende Hinweise: Elektronische Geräte dürfen nicht mit dem Hausmüll entsorgt werden. Bitte recyceln Sie das Gerät, wenn Ihnen die entsprechenden Recyclingmöglichkeiten zur Verfügung stehen. Bitte wenden Sie sich an Ihre örtliche Behörde oder Ihren Händler und fragen Sie nach einem Recycling-Rat.



#### RoHS

Dieses Produkt wurde gemäß der Richtlinie 2011/65 / CE als RoHS-konform zertifiziert.

#### Entsorgung von Batterien / Akkus

Bitte beachten Sie die regionalen Richtlinien zur Entsorgung von Akkus oder wenden Sie sich an die örtlichen Behörden, Ihren Hausmüll-Entsorgungsdienst oder das Geschäft, in dem Sie das Produkt erworben haben. Batterien / Akkus dürfen nicht in den normalen Hausmüll gegeben werden. Bitte verwenden Sie eine wiederaufladbare Batterie in Ihrer Nachbarschaft oder Gemeinde, falls verfügbar.



#### Garantie

Lucid Sound, Inc. garantiert, dass dieses Produkt frei von Mängeln in Material und Verarbeitung für den Garantiezeitraum ist. Diese nicht übertragbare, 2 Jahre Garantie (Canada und USA: 1 Jahre Garantie) ist nur für Sie, den ersten Käufer und Endbenutzer. Soweit ein Mangel, der von dieser Garantie gedeckt wird, auftritt und Sie über einen Nachweis über den Kauf des Produkt verfügen, wird Lucid Sound, Inc. nach eigenem Ermessen entweder reparieren oder das Produkt kostenlos (ohne Versandkosten zu Lucid Sound) ersetzen.

Die Lucid Sound, Inc. 2 Jahre Garantie ist für Kunden in Europe verfügbar (Canada und USA: 1 Jahre). Die einzige und ausschließliche Abhilfe ist Reparatur oder der Ersatz Ihres Lucid Sound Produkts. In keinem Fall überschreitet die Haftung von Lucid Sound, Inc. den ursprünglichen Kaufpreis des Produkts. Diese Garantie gilt nicht für: (a) normalen Verschleiß oder Missbrauch; (b) Industrie, berufliche

oder kommerzielle Zwecke; (c) wenn das Produkt manipuliert oder verändert wurde.

**Um Garantieservice zu erhalten kontaktieren Sie uns bitte wie folgt:**

**lucidsound.com**

©2018 Lucid Sound, Inc. 5939 Darwin Ct., Suite 100, Carlsbad, CA 92008 U.S.A.

Microsoft, Xbox, Xbox "Sphere" Design, Xbox One und Windows sind eingetragene Marken der Microsoft-Unternehmensgruppe. Alle anderen Marken sind Eigentum ihrer jeweiligen Inhaber.

Die Form und das Design dieses Produkts sind ein Handelskleid von Lucid Sound, Inc., seinen Tochtergesellschaften und Tochtergesellschaften. Alle Rechte vorbehalten. Alle anderen Produktnamen und Bilder sind Marken oder eingetragene Marken ihrer jeweiligen Eigentümer. In China hergestellt. Produktmerkmale, Aussehen und technische Daten können ohne vorherige Ankündigung geändert werden. Bitte bewahren Sie diese Informationen zum späteren Nachschlagen auf.



[S]



**Pulsante Centrale**  
**Silenziamento Gioco**

**Volume Gioco**

### LED di accensione

Fisso = ON / connesso / carica  
Blink Lento = no collegata  
Blink Veloce = collegamento  
Pulsante = ricarica

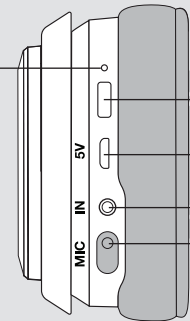

**Tasto di accensione**

**Porta di ricarica USB**

**Porta mobile da 3,5 mm**

**Porta Microfono**



[D]

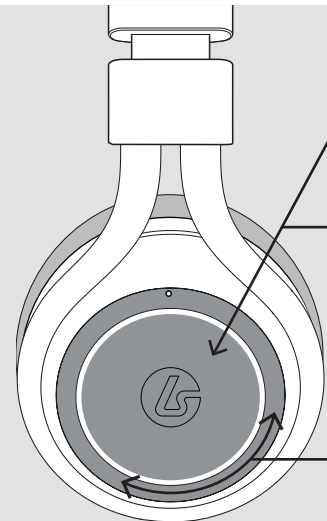

### Funzione "Mic-monitoring"

Mic Monitoring Disattivato/Riattivato =  
premere per 3 secondi

### Silenziamento Microfono

Disattivato/Riattivato = Breve Pres-  
sione

LED sul microfono si accende quando  
disattivato



**Gioco / Chat bilanciamento**

**Pulsante di connessione**

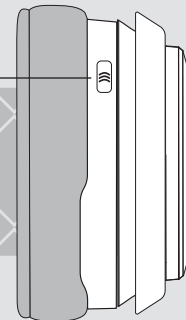

IT

## ACCESSORI



## MICROFONO



1

Microfono a braccio

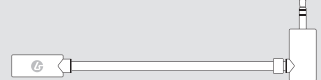

2

Coperchio della porta Mic



3

Cavo di ricarica USB

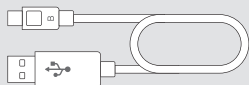

4

Cavo mobile da 3,5 mm

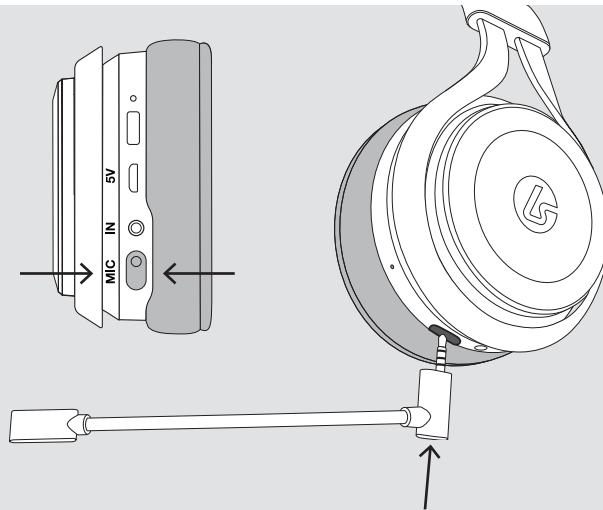
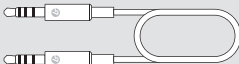

## RICARICA



Pulsante = Ricarica  
Fisso = Carica

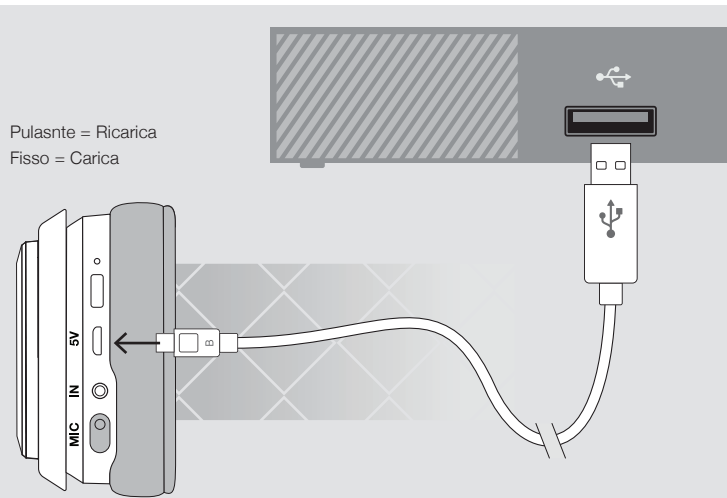

## CONFIGURAZIONE CELLULARE



IT

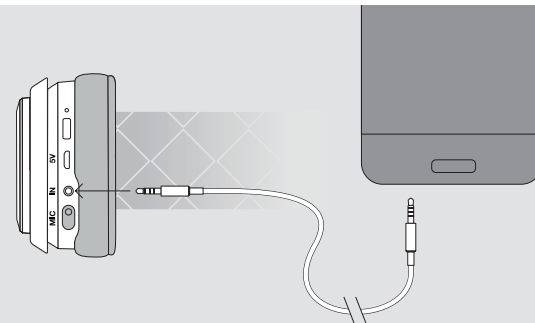

Collegare il cavo incluso da 3,5 mm tra l'auricolare e il dispositivo mobile.

Premere il pulsante centrale dell'orecchio sinistro per controllare il dispositivo mobile (sui dispositivi supportati). Quando l'auricolare è acceso, le funzioni di silenziamento del volume e del microfono funzionano.

L'auricolare può essere utilizzato anche quando è spento, ma funzionerà solo il pulsante sinistro dell'orecchio.

**Modello No:** LS35X      **IC:** 21203-LS35X      **LucidSound, Inc.**  
Fatto in Cina

Frequenza RF: 2.412-2.462GHz, 5.15-5.85 GHz  
Produttore: LucidSound, Inc.  
Importatore: informazioni possono essere trovate su [lucidsound.com](http://lucidsound.com)

Questo dispositivo è conforme allo standard RSS-247 esente da licenza Industry Canada. Il funzionamento è soggetto alle seguenti due condizioni: (1) questo dispositivo non può causare interferenze e (2) questo dispositivo deve accettare qualsiasi interferenza, incluse le interferenze che possono causare un funzionamento indesiderato del dispositivo.

#### Dichiarazione sull'esposizione alle radiazioni IC:

Questa apparecchiatura è conforme ai limiti di esposizione alle radiazioni IC RSS-102 stabiliti per un ambiente non controllato. Questa apparecchiatura deve essere installata e utilizzata con una distanza minima di 0,5 cm tra il radiatore e il corpo.

#### EU DECLARATION OF CONFORMITY



Con la presente garantiamo che snakebyte distribution GmbH, con sede in 13 Konrad-Zuse-Str., Schwerte 58239 Germania, commercializza questo dispositivo LS40 con il marchio LucidSound e soddisfa i requisiti legali e i requisiti della direttiva 2014/53 / UE. Questa notifica è elencata sotto:  
[lucidsound.com/EUDOC](http://lucidsound.com/EUDOC)

Non tentare di sostituire la batteria: potrebbe danneggiare la batteria, che potrebbe causare surriscaldamento, incendio e lesioni. La batteria agli ioni di litio nella cuffia deve essere riparata o riciclata da LucidSound o da un prestatore di servizi autorizzato e deve essere riciclato o smaltito separatamente dai rifiuti domestici. Smaltire le batterie in base alle leggi e alle linee guida ambientali locali.

#### DIRETTIVA RAEE (RIFIUTI DI APPARECCHIATURE ELETTRICHE ED ELETTRONICHE)

Se si desidera eliminare questo prodotto in un secondo momento, si prega di osservare le seguenti istruzioni: Le apparecchiature elettroniche non devono essere smaltite insieme ai rifiuti domestici. Si prega di riciclare il dispositivo se sono disponibili le modalità di riciclaggio appropriate. Si prega di contattare l'autorità locale o il rivenditore e chiedere loro consigli sul riciclaggio.

#### RoHS

Questo prodotto è stato certificato come conforme alla Direttiva RoHS in conformità alla Direttiva 2011/65 / CE.

#### Smaltimento di batterie / batterie ricaricabili

Seguire le linee guida regionali per lo smaltimento delle batterie ricaricabili o contattare le autorità locali, il servizio di smaltimento dei rifiuti domestici o il negozio in cui è stato acquistato il prodotto. Le batterie / le batterie ricaricabili non devono essere smaltite nei normali rifiuti domestici. Si prega di utilizzare uno smaltimento della batteria ricaricabile nel proprio quartiere o comunità, se disponibile.



#### Garanzia

La garanzia limitata di 1 anno di LucidSound, Inc. è disponibile per i clienti di tutto il mondo. Il tuo unico ed esclusivo rimedio è la riparazione o la sostituzione del tuo prodotto LucidSound. In nessun caso la responsabilità di LucidSound sarà superiore al prezzo di acquisto originale del prodotto. Questa garanzia non si applica a: (a) normale usura o uso abusivo; (b) uso industriale, professionale o commerciale; (c) se il prodotto è stato manomesso o modificato. Questa garanzia non trasferibile è

valida solo nella regione / paese in cui l'auricolare è stato originariamente acquistato.

#### Europa

La garanzia limitata di 2 anni di LucidSound, Inc. è disponibile per i clienti in Europa.

### Per ricevere il servizio di garanzia, ti preghiamo di contattarci a: [lucidsound.com](http://lucidsound.com)

© 2019 Lucid Sound, Inc. 5939 Darwin Ct., Suite 100, Carlsbad, CA 92008 U.S.A.

Microsoft, Xbox, Xbox Design "Sphere", Xbox One e Windows sono marchi registrati del gruppo di società Microsoft. Tutti gli altri marchi sono di proprietà dei rispettivi proprietari.

La forma e il design di questo prodotto sono una veste grafica di Lucid Sound, Inc., delle sue sussidiarie e affiliate. Tutti i diritti riservati. Tutti gli altri nomi di prodotti e immagini sono marchi o marchi registrati dei rispettivi proprietari. Fatto in Cina. Le caratteristiche, l'aspetto e le specifiche del prodotto possono essere soggetti a modifiche senza preavviso. Si prega di conservare queste informazioni per riferimento futuro.



[I]



[D]

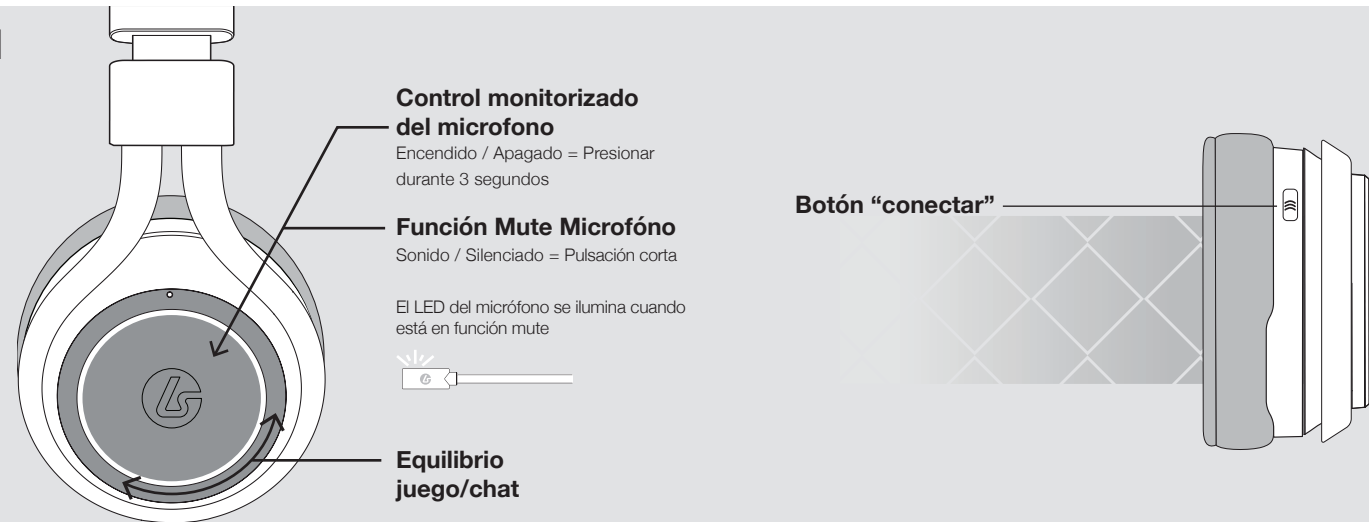

ES

# ACCESORIOS



# MICRÓFONO



1

Brazo de micro

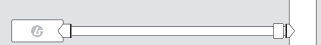

2

Puerto de micro cubierto



3

Cable de Carga USB

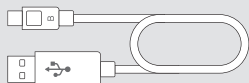

4

Cable móvil de 3.5mm

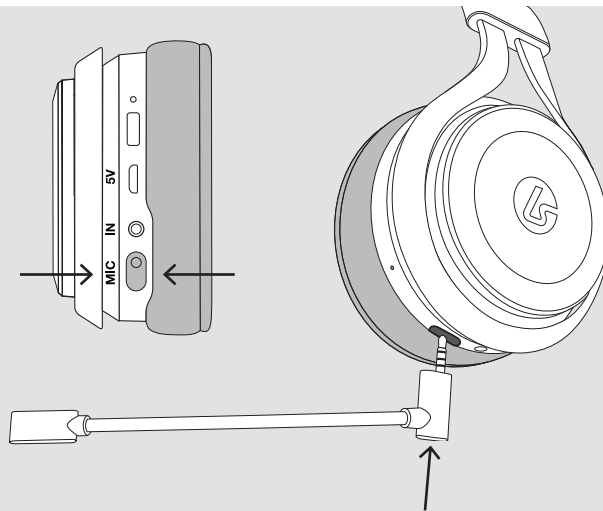
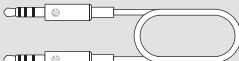

# CARGA



LED parpadea = Cargando  
Luz fija = Cargado

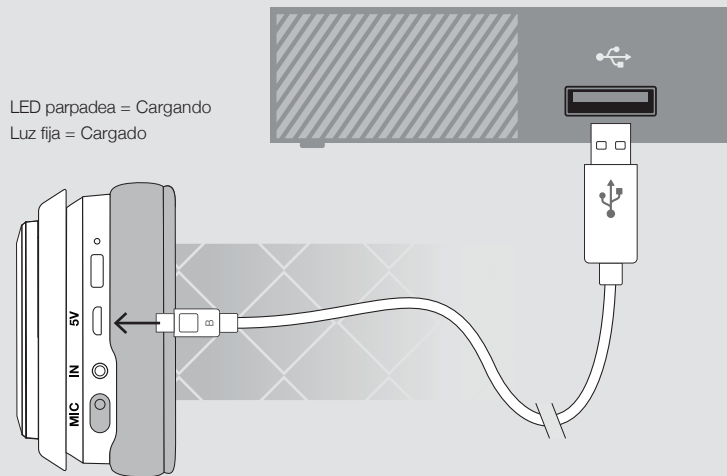

# CONFIGURACIÓN MÓVIL



ES

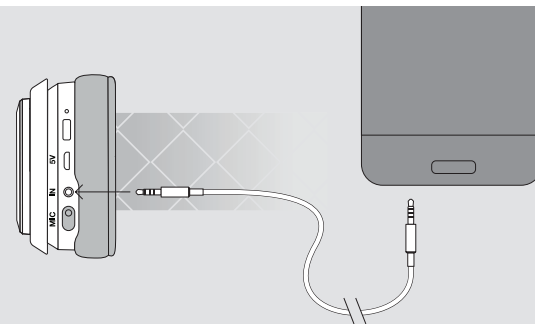

Conecte el cable de 3.5 mm incluido entre los auriculares y su dispositivo móvil.

Presione el botón central del auricular izquierdo para controlar su dispositivo móvil (en dispositivos compatibles). Cuando el auricular está encendido, funcionan las funciones de volumen y de silencio del micrófono.

Los auriculares también se pueden usar cuando están apagados, pero solo funcionará el botón izquierdo.



**Model No:** LS35X      **IC:** 21203-LS35X      **LucidSound, Inc.**  
Hecho en China

Frecuencia de RF: 2.412-2.462GHz, 5.15-5.85 GHz  
Fabricante: LucidSound, Inc.  
Importador: La información se puede encontrar en [lucidsound.com](http://lucidsound.com)

Este dispositivo cumple con el estándar RSS-247 exento de licencia de Industry Canada. El funcionamiento está sujeto a las siguientes dos condiciones: (1) este dispositivo no puede causar interferencias, y (2) este dispositivo debe aceptar cualquier interferencia, incluidas las que puedan causar un funcionamiento no deseado del dispositivo.

#### Declaración de exposición a la radiación IC:

Este equipo cumple con los límites de exposición a la radiación IC RSS-102 establecidos para un entorno no controlado. Este equipo debe instalarse y operarse con una distancia mínima de 0,5 cm entre el radiador y su cuerpo.

#### DECLARACIÓN DE CONFORMIDAD DE LA UE



De esta manera garantizamos que snakebyte distribution GmbH, ubicada en 13 Konrad-Zuse-Str., Schwerte 58239 Alemania, está comercializando este dispositivo LS40 bajo la marca LucidSound y cumple con los requisitos legales y los requisitos de la Directiva 2014/53 / EU. Esta notificación se encuentra debajo de:

[lucidsound.com/EUDOC](http://lucidsound.com/EUDOC)



#### RAEE (Directiva sobre residuos de aparatos eléctricos y electrónicos)

Si finalmente desea desechar este producto más adelante, tenga en cuenta las siguientes instrucciones: El equipo electrónico no se debe tirar junto con la basura doméstica. Recicle el dispositivo si dispone de las formas de reciclaje adecuadas. Comuníquese con su autoridad local o minorista y solicite asesoramiento sobre reciclaje.

#### RoHS

Este producto ha sido certificado como RoHS conforme a la Directiva 2011/65 / CE.

#### Eliminación de baterías / baterías recargables

Siga las pautas regionales para la eliminación de baterías recargables o comuníquese con las autoridades locales, el servicio de eliminación de desechos domésticos o la tienda donde compró el producto. Las baterías / baterías recargables no deben desecharse en la basura doméstica normal. Utilice una eliminación de batería recargable en su vecindario o comunidad, si está disponible.



LI-ION

#### Garantía

LucidSound, Inc. garantiza que este producto no presentará defectos en los materiales ni en la mano de obra durante el período de garantía. Esta garantía limitada intransferible de 1 año es solo para usted, el primer comprador del usuario final. Si se produce un defecto cubierto por esta garantía Y proporciona un comprobante de compra, LucidSound, Inc., a su elección, reparará o reemplazará el producto sin cargo (excluyendo el envío).

La garantía limitada de 1 año de LucidSound, Inc. está disponible para clientes de todo el mundo. Su único y exclusivo remedio es la reparación o el reemplazo de su producto LucidSound. En ningún caso, la responsabilidad de LucidSound superará el precio de compra original del producto. Esta garantía no se aplica a: (a) uso y desgaste normal o uso abusivo; (b) uso industrial, profesional o comercial; (c) si el producto ha sido alterado o modificado. Esta garantía intransferible solo es válida

en la región / país en el que se adquirió originalmente el auricular.

#### Europa

La garantía limitada de 2 años de LucidSound, Inc. está disponible para los clientes en Europa.

### Para recibir el servicio de garantía, contáctenos en: [lucidsound.com](http://lucidsound.com)

© 2019 Lucid Sound, Inc. 5939 Darwin Ct., Suite 100, Carlsbad, CA 92008 U.S.A.

Microsoft, Xbox, Xbox "Sphere" Design, Xbox One y Windows son marcas registradas del grupo de compañías de Microsoft. Todas las demás marcas comerciales son propiedad de sus respectivos dueños.

La forma y el diseño de este producto son una imagen comercial de Lucid Sound, Inc., sus subsidiarias y afiliadas. Todos los derechos reservados. Todos los demás nombres e imágenes de productos son marcas comerciales o marcas comerciales registradas de sus respectivos propietarios. Hecho en China. Las características, apariencia y especificaciones del producto pueden estar sujetas a cambios sin previo aviso. Por favor, guarde esta información para referencia futura.



