

Starry, Inc.

TEST REPORT

SCOPE OF WORK

Emissions Testing – 24 GHz Titan Radio, Model S01411

REPORT NUMBER

104689284BOX-001

ISSUE DATE

August 2, 2021

[LAST REVISED DATE]

October 12, 2021

DOCUMENT CONTROL NUMBER

Non-Specific Radio Report Shell Rev. August 2020
© 2020 INTERTEK



EMISSIONS TEST REPORT
(FULL COMPLIANCE)

Report Number: 104689284BOX-001

Project Number: G104689284

Report Issue Date: August 2, 2021

Report Last Revision Date: October 12, 2021

Model(s) Tested: S01411

Standards: FCC 47 CFR Part 30 Subpart C: 2021
FCC 47 CFR Part 2: 2021
FCC KDB 842590 D01 Upper Microwave Flexible Use Service v01r02, April 20, 2021

Tested by:
Intertek
70 Codman Hill Road
Boxborough, MA 01719
USA

Client:
Starry, Inc.
38 Chauncy St. Suite 200
Boston, MA 02111
USA

Report prepared by



Kouma Sinn / Engineering Supervisor

Report reviewed by



Vathana Ven / Engineering Supervisor

This report is for the exclusive use of Intertek's Client and is provided pursuant to the agreement between Intertek and its Client. Intertek's responsibility and liability are limited to the terms and conditions of the agreement. Intertek assumes no liability to any party, other than to the Client in accordance with the agreement, for any loss, expense or damage occasioned by the use of this report. Only the Client is authorized to permit copying or distribution of this report and then only in its entirety. Any use of the Intertek name or one of its marks for the sale or advertisement of the tested material, product or service must first be approved in writing by Intertek. The observations and test results in this report are relevant only to the sample tested. This report by itself does not imply that the material, product, or service is or has ever been under an Intertek certification program.

Table of Contents

1 Introduction and Conclusion 4

2 Test Summary 4

3 Client Information 5

4 Description of Equipment Under Test and Variant Models 5

5 System Setup and Method 7

6 Output Power & Human RF Exposure 9

7 Out of Band (OOB) Domain 27

8 Radiated Spurious Emissions 39

9 Occupied Bandwidths 61

10 Frequency Stability 76

11 AC Main Conducted Emissions 81

12 Revision History 85

13 Appendix A – Mixer Conversion Loss 86

14 Appendix B – Mixer Verification Certificates 113

15 Appendix C – Test Laboratory Accreditation Scope 117

1 Introduction and Conclusion

The tests indicated in section 2.0 were performed on the product constructed as described in section 4.0. The remaining test sections are the verbatim text from the actual data sheets used during the investigation. These test sections include the test name, the specified test Method, a list of the actual Test Equipment Used, documentation Photos, Results and raw Data. No additions, deviations, or exclusions have been made from the standard(s) unless specifically noted.

Based on the results of our investigation, we have concluded the product tested **complies** with the requirements of the standard(s) indicated. The results obtained in this test report pertain only to the item(s) tested. Intertek does not make any claims of compliance for samples or variants which were not tested.

2 Test Summary

Section	Test full name	Result
3	Client Information	--
4	Description of Equipment Under Test and Variant Models	--
5	System Setup and Method	--
6	Output Power & Human RF Exposure FCC §2.1046, FCC §30.202 (a) FCC §30.207	Pass
7	Out of Band (OOB) Domain FCC §30.203 (a) (b)	Pass
8	Radiated Spurious Emissions FCC §30.203 (a) (b)	Pass
9	Occupied Bandwidths FCC §2.1049	Pass
10	Frequency Stability* FCC §2.1055	Pass
11	AC Mains Conducted Emissions FCC 47 CFR Part 15 Subpart B (2021)	Pass
12	Revision History	--

*Notes: Frequency tolerance is not specified in FCC 47 CFR Part 30 Subpart C. Measurement was performed for reporting purpose.

3 Client Information

This EUT was tested at the request of:

Client: Starry, Inc.
38 Chauncy St Suite 200
Boston, MA 02111
USA

Contact: Robert White
Telephone: None
Fax: None
Email: rwhite@starry.com

4 Description of Equipment Under Test and Variant Models

Manufacturer: Starry, Inc.
38 Chauncy St Suite 200
Boston, MA 02111
USA

Equipment Under Test			
Description	Manufacturer	Model Number	Serial Number
24GHz Titan Radio	Starry, Inc.	S01411	2111000001

Receive Date:	June 10, 2021
Received Condition:	Good
Type:	Production

Description of Equipment Under Test (provided by client)

The equipment under test (EUT) is a Titan24 mmWave based station access point, operating between 24.25-25.25 GHz. It utilizes OFDMA IEEE 802.11ac, MCS0-MCS9. Channel bandwidths are 160 MHz and 20 MHz unconverted and transmitted/received at mmWave frequencies between 24.25 GHz and 25.25 GHz. Signals are conveyed in two polarizations – horizontal and vertical through patch array with a lens antenna. The antenna is a patch array (4x8) for each polarization and a lens. There are 4 1x8 columns per polarization.

The Titan24 base station is typically pole-mounted or building mounted.

Equipment Under Test Power Configuration			
Rated Voltage	Rated Current	Rated Frequency	Number of Phases
48 VDC	5.84 A	DC	N/A

Operating modes of the EUT:

No.	Descriptions of EUT Exercising
1	Continuous Transmitting

Software used by the EUT:

No.	Descriptions of EUT Exercising
1	Proprietary Software that controls the operation of the radio.

Radio/Receiver Characteristics	
Frequency Band(s)	24.27-24.29 GHz, 24.77-25.09 GHz, 24.34-24.36 GHz, 24.84-25.16 GHz
Modulation Type(s)	OFDMA
Maximum Output Power	53.03 dBm EIRP (With 4 Paths and Beamforming)
Test Channels	24.27 GHz, 24.28 GHz, 24.29 GHz 24.77 GHz, 24.97 GHz, 25.09 GHz 24.34 GHz, 24.35 GHz, 24.36 GHz 24.84 GHz, 25.04 GHz, 25.16 GHz
Occupied Bandwidth	158.266 MHz, 24.25 – 24.45 GHz 156.989 MHz, 24.75 – 25.25 GHz
MIMO Information (# of Transmit and Receive antenna ports)	8 TX / 8 RX ports, up to 4 spatial streams per polarization (8 in total), horizontal and vertical polarizations
Equipment Type	Proprietary upbanded and modified 802.11AC Radio
Antenna Type and Gain	Antenna Type and Gain*: 24.25-25.25 GHz Patch antenna array feeding lens, 20.3 dBi

*: Antenna Type and Gain are provided by Starry. Detail description of antenna is included in the *Operational Description* exhibit. Intertek takes no responsibility for the accuracy of the information provided.

Variant Models:

The following variant models were not tested as part of this evaluation, but have been identified by the manufacturer as being electrically identical models, depopulated models, or with reasonable similarity to the model(s) tested. Intertek does not make any claims of compliance for samples or variants which were not tested.

None

5 System Setup and Method

Cables					
ID	Description	Length (m)	Shielding	Ferrites	Termination
1	AC Cord	1	None	None	AC Mains
2	AC Adapter	1	None	Yes	Power Supply
3	Ethernet	10	None	None	Support Equipment
4	TNC	10	Yes	None	Support Equipment

Support Equipment			
Description	Manufacturer	Model Number	Serial Number
Monitor	Dell	P2317H	CN-03GJ21-74261-6BP-3TKM-A00
Keyboard	Dell	KB216t	CN-ORKRON-71616-6CD-1FLE-A03
Mouse	Dell	MS116t	CN-0DVORH-LO300-81G-1GFC
5-Port Gigabit Ethernet Switch	Netgear	GS305v3	5U81095VA3835
FCC System Tester	Starry	JBC313U591W-31ACB	19CF319X002872
Labsat GNSS Simulator	Racelogic	LS03	082600
Wireless Router	Opengear	ACM7004	70041901043136
Starry Link	Starry	500812	MAC: 00B6F2098A
48VDC Power Supply	Meanwell	GST200A48	None

5.1 Method:

Configuration as required by FCC 47CFR Part 30 Subpart C: 2021, FCC 47CFR Part 2: 2021, ANSI C63.26:2015, and FCC KDB 842590 D01 Upper Microwave Flexible Use Service v01r02 April 20, 2021.

5.2 EUT Block Diagram:

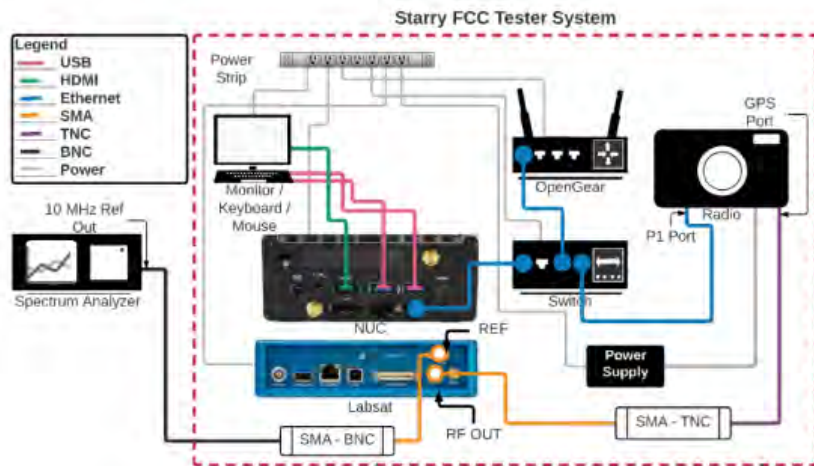

6 Output Power & Human RF Exposure

6.1 Requirements

FCC §30.202(a) Power limits.

For fixed and base stations operating in connection with mobile systems, the average power of the sum of all antenna elements is limited to an equivalent isotropically radiated power (EIRP) density of +75dBm/100 MHz. For channel bandwidths less than 100 megahertz the EIRP must be reduced proportionally and linearly based on the bandwidth relative to 100 megahertz.

FCC §30.207 Radio frequency (RF) safety.

Licenses and manufacturers are subject to the radio frequency radiation exposure requirements specified in §§ 1.1307(b), 1.1310, 2.1091, and 2.1093 of this chapter, as appropriate. Applications for equipment authorization of mobile or portable devices operating under this section must contain a statement confirming compliance with these requirements. Technical information showing the basis for this statement must be submitted to the Commission upon request.

FCC §1.1310 Radiofrequency radiation exposure limits

Table 1 below sets forth limits for Maximum Permissible Exposure (MPE) to radiofrequency electromagnetic field.

Table 1 – Limits for Maximum Permissible Exposure (MPE)

Frequency range (MHz)	Electric field strength (V/m)	Magnetic field strength (A/m)	Power Density (mW/cm ²)	Averaging time (minutes)
(A) Limits for Occupational/Controlled Exposure				
0.3-3.0	614	1.63	*100	6
3.0-30	1842/f	4.89/f	*900/f ²	6
30-300	61.4	0.163	1.0	6
300-1,500			f/300	6
1,500-100,000			5	6
(B) Limits for General Population/Uncontrolled Exposure				
0.3-1.34	614	1.63	*100	30
1.34-30	842/f	2.19/f	*180/f ²	30
30-300	27.5	0.073	0.2	30
300-1,500			f/1500	30
1,500-100,000			1.0	30

F = frequency in MHz

* = Plane-wave equivalent power density

6.2 Method

Tests are performed in accordance with FCC 47CFR Part 30 Subparts C: 2021, FCC 47CFR Part 2: 2021, FCC KDB 842590 D01 v01r02 Subclause 4.2, ANSI C63.26:2015 Subclause 5.5.4.

The procedure described in Subclause 5.5.4 (field strength method) of ANSI C63.26-2015 was utilized to determine maximum power. A field strength measurement was performed, and the field strength level was mathematically converted to an equivalent power level for comparison to the applicable limit. Subclause 4.2 of FCC KDB 842590 D01 v01r02 was utilized where radiated power spectral density (EIRP density) is subject to the limit.

The EUT was transmitting at its maximum data rate with MCS8 modulation. During measurement, EIRP radiated power was converted to conducted power by using antenna gain and distance factor. Power shown on the screenshots are conducted power.

- Connect the test antenna to a spectrum analyzer.
- Set spectrum analyzer’s RBW, VBW, detector, span, etc. to the proper values.
- Place the EUT 1.5 meters above the ground reference plane and the far field test distance of 3 meters from the edge of the EUT to the test antenna.
- Set the EUT to transmit continuously on a channel with modulation.
- As the surfaces of the EUT are scanned, keep the test antenna pointed toward the EUT and slowly vary the test antenna polarization to cover all possible polarizations and orientations of the emission. And vary the test antenna height from 1 to 4 meters to maximize the emission.
- Record the measured reading with the test antenna fixed at the maximized position, polarization, and orientation. Record the measurement distance.
- EIRP power is calculated by using the following equation:

$$EIRP = E_{Meas} + 20\log(d_{Meas}) - 104.7$$

where

- EIRP is the equivalent isotopically radiated power, in dBm
- E_{Meas} is the field strength of the emission at the measurement distance, in dB μ V/m
- d_{Meas} is the measurement distance, in m

- Measurements was made at 3 meters distance. Far Field Distance (Rm) Calculation: $Rm = 2D^2 / \lambda$, where: D = largest dimension of the antenna aperture in meters, λ = wavelength of the emission under investigation [$300/f_{MHz}$] in meters.

TEST SITE: 10m ALSE

The 10m ALSE is 13m (Length) x 21m (Depth) x 10m (Height) with the effective size in terms of space from the tips of the absorber is 12m (Length) x 20m (Depth) x 8.5m (Height). This chamber achieves broadband performance using a unique arrangement of hybrid and ferrite tile absorber. This chamber has a built in 3m diameter turntable (Embedded type). The metal structure of the table makes electrical connection around the entire circumference of the turntable to the ground plane with a metal brush type connection. The turntable is located on one end of the chamber and the antennas are mounted 3 and 10 meters away at the other end of the chamber on the adjustable an Antenna Mast. The antenna mast is a non-conductive bore sighted type with remote control of antenna height and polarization. The Antenna Mast and the turntable can be remotely controlled through the controller located in the adjacent Control room. A Styrofoam table 80 cm high is used for table-top equipment.

Measurement Uncertainty

Measurement	Frequency Range	Expanded Uncertainty (k=2)
Radiated Emissions, 10m	30-1000 MHz	5.0 dB
Radiated Emissions, 3m	30-1000 MHz	4.6 dB
Radiated Emissions, 3m	1-6 GHz	4.9 dB
Radiated Emissions, 3m	6-15 GHz	5.1 dB
Radiated Emissions, 3m	15-18 GHz	4.7 dB
Radiated Emissions, 3m	18-40 GHz	4.7 dB

Sample Calculation

Cable loss, antenna factor, and path loss at 3 meters were compensated in the Spectrum Analyzer as a dB offset without the EUT antenna factor. The EIRP power is calculated from field strength reading at 3 meters as below.

$EIRP (dBm) = E (dB\mu/m) + 20 * LOG (D) - 104.7$; where D is the measurement distance (in the far field region) in meters.

$EIRP (dBm) = E (dB\mu V/m) - 95.26$, where D = 3 m

$EIRP Output Power(dBm) = EIRP (dBm) - EUT antenna gain (dBi)$

6.3 Test Equipment Used:

Asset	Description	Manufacturer	Model	Serial	Cal Date	Cal Due
DAV007'	Weather Station Vantage Vue	Davis	6250	MS1912 12003	03/20/2021	03/20/2022
EMC04'	ANTENNA, RIDGED GUIDE, 18-40 GHZ	EMCO	3116	2090	01/28/2021	01/28/2022
ROS005-1'	Signal and Spectrum Analyzer	R&S	FSW43	100646	10/27/2020	10/27/2021
CBLHF2012-5M-2'	5m 9kHz-40GHz Coaxial Cable - SET2	Huber & Suhner	SF102	2526760 02	02/19/2021	02/19/2022

Software Utilized:

Name	Manufacturer	Version
None	--	--

6.4 Results – Output Power:

The sample tested was found to Comply.

Frequency (GHz)	Antenna Polarity	Bandwidth (MHz)	EIRP Power from Plots (1 path) (dBm)	*Multiple Paths + Beam Forming (dB)	Total EIRP Power** (dBm/20MHz)	Total EIRP Power (dBm/100MHz)	Power Limits (dBm/100MHz)	Margin (dB)
24.27	V	20	29.88	12.02	41.90	48.89	75	-26.11
24.28	V	20	32.64	12.02	44.66	51.65	75	-23.35
24.29	V	20	28.88	12.02	40.90	47.89	75	-27.11
24.77	V	20	30.39	12.02	42.41	49.40	75	-25.60
24.97	V	20	28.43	12.02	40.45	47.44	75	-27.56
25.09	V	20	28.65	12.02	40.67	47.66	75	-27.34
24.27	H	20	31.29	12.02	43.31	50.30	75	-24.70
24.28	H	20	34.02	12.02	46.04	53.03	75	-21.97
24.29	H	20	33.01	12.02	45.03	52.02	75	-22.98
24.77	H	20	32.49	12.02	44.51	51.50	75	-23.50
24.97	H	20	30.01	12.02	42.03	49.02	75	-25.98
25.09	H	20	30.98	12.02	43.00	49.99	75	-25.01

Frequency (GHz)	Antenna Polarity	Bandwidth (MHz)	EIRP Power from Plots (1 path) (dBm)	*Multiple Paths + Beam Forming (dB)	Total EIRP Power** (dBm/160MHz)	Total EIRP Power (dBm/100MHz)	Power Limits (dBm/100MHz)	Margin (dB)
24.34	V	160	35.79	12.02	47.81	45.77	75	-29.23
24.35	V	160	35.43	12.02	47.45	45.41	75	-29.59
24.36	V	160	35.78	12.02	47.80	45.76	75	-29.24
24.84	V	160	35.89	12.02	47.91	45.87	75	-29.13
25.04	V	160	36.74	12.02	48.76	46.72	75	-28.28
25.16	V	160	34.65	12.02	46.67	44.63	75	-30.37
24.34	H	160	35.92	12.02	47.94	45.90	75	-29.10
24.35	H	160	35.85	12.02	47.87	45.83	75	-29.17
24.36	H	160	35.43	12.02	47.45	45.41	75	-29.59
24.84	H	160	37.02	12.02	49.04	47.00	75	-28.00
25.04	H	160	36.93	12.02	48.95	46.91	75	-28.09
25.16	H	160	36.51	12.02	48.53	46.49	75	-28.51

*: Multiple Paths (4 paths) + Beam Forming (6 dBi) = 10*Log(4) + 6 dBi = 12.02 dBi.

** : Total EIRP Power = EIRP power from the plots in Section 6.7 + 12.02 dBi

6.5 Results – Human RF Exposure

MPE Safe Distance Calculation

RF exposure for licensed transmitter is handled at the time of licensing, however, an MPE calculation was performed in order to show the distance at which the device is compliant with the limits of §1.1310. The highest measured EIRP output power was used.

FCC Limit for General Population/Uncontrolled Exposure at 24 GHz = 1 mW/cm²

Power Density = [EIRP] / [4π x (D_{cm})²], where EIRP is in milliwatts and D is in centimeters

Setting the power density equal to the limit of 1 mW/cm² and solving for D_{cm} yields the following results.

Results:

EUT EIRP = EIRP Output Power+ Array Gain in dBi + Beam Forming in dBi

Power Density Limit = [EIRP] / [4π x (D_{cm})²]

1 mW/cm² = [EIRP] / [4π x (D_{cm})²]

D_{cm} = ([EIRP] / [4π])^{1/2}, where maximum EIRP = 53.03 dBm

Safe Distance, D_{cm} = 126.44 cm

6.6 Setup Photographs:

Setup Photographs are included in a separate file.

6.7 Plots:

EIRP Output Power (Vertical Polarity) – S01411_24.27GHz_BW20M_MCS8_Path 3_att16.5

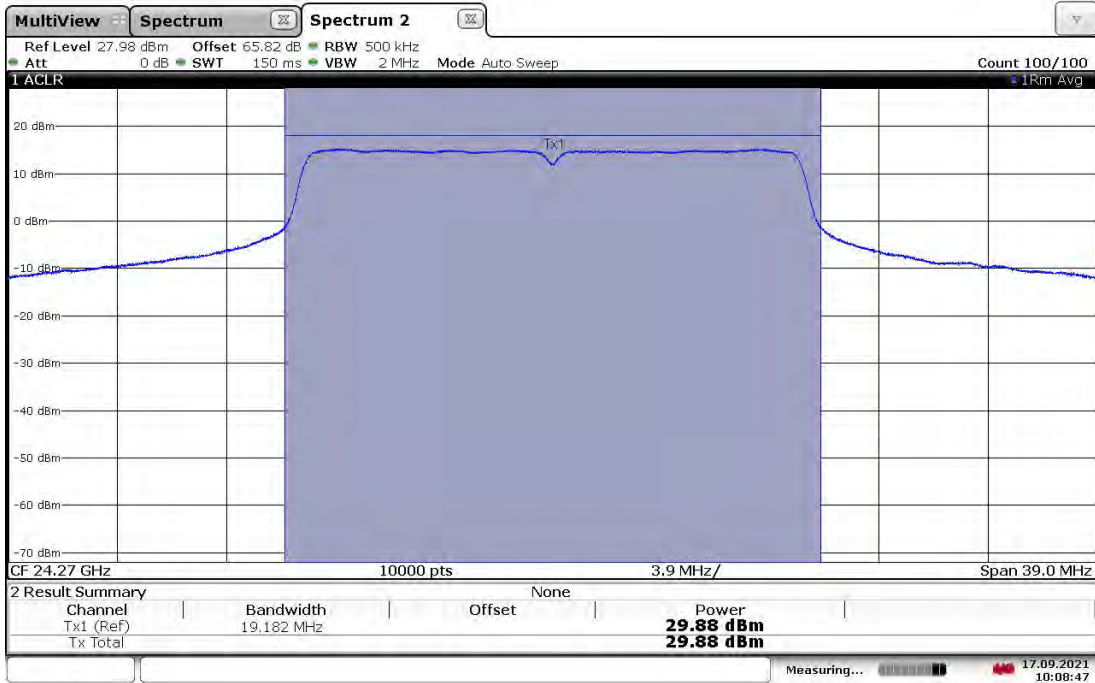

10:08:48 17.09.2021

EIRP Output Power (Vertical Polarity) – S01411_24.28GHz_BW20M_MCS8_Path 3_att16

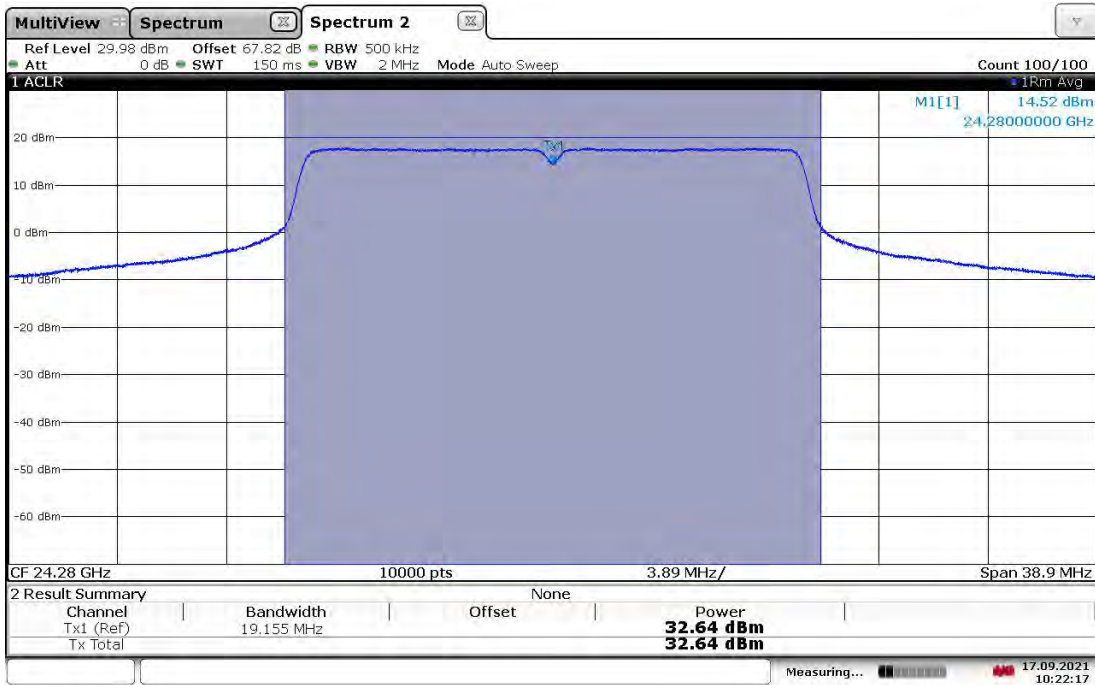

10:22:18 17.09.2021

EIRP Output Power (Vertical Polarity) – S01411_24.29GHz_BW20M_MCS8_Path 3_att13.5

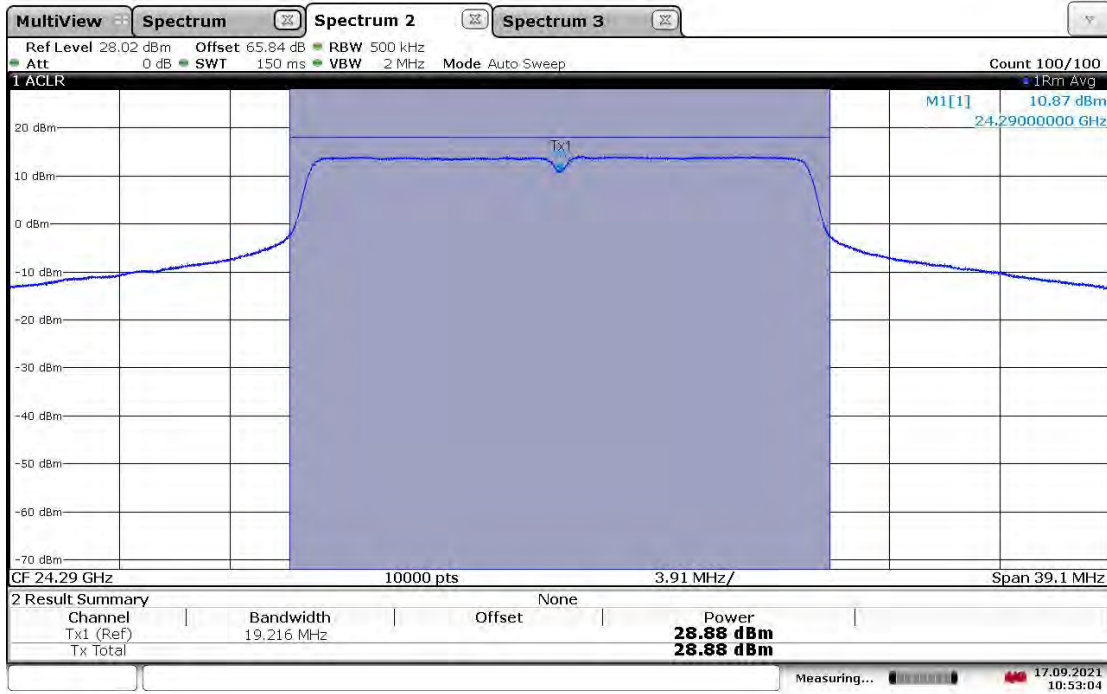

10:53:05 17.09.2021

EIRP Output Power (Vertical Polarity) – S01411_24.77GHz_BW20M_MCS8_Path 3_att18

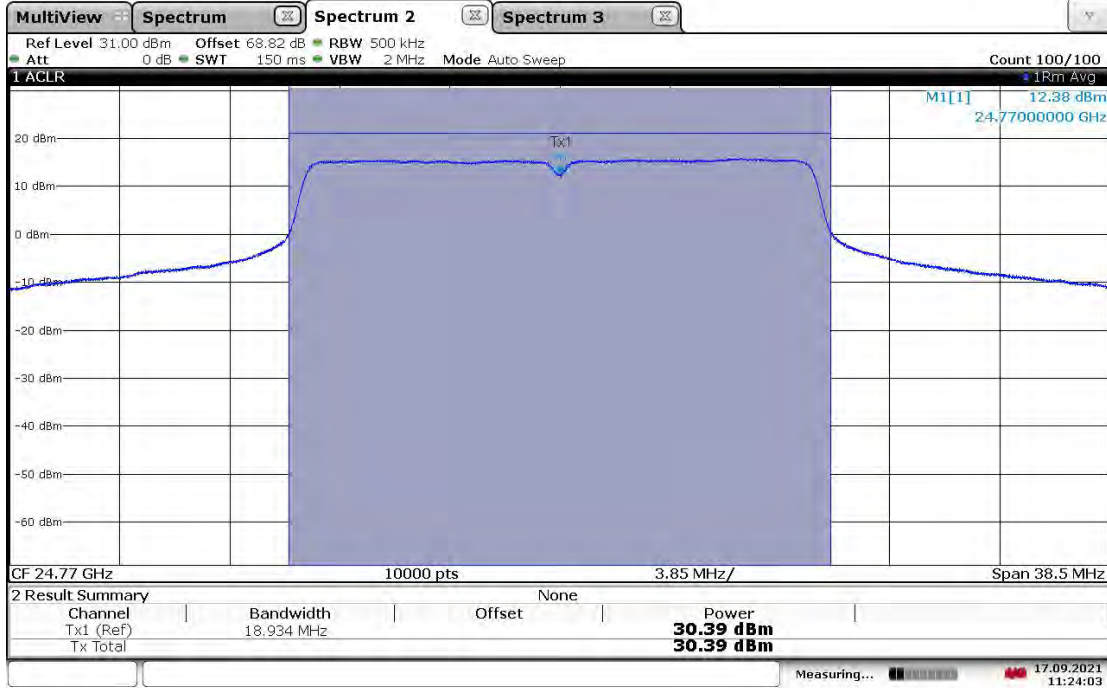

11:24:04 17.09.2021

EIRP Output Power (Vertical Polarity) – S01411_24.97GHz_BW20M_MCS8_Path 3_att18.5

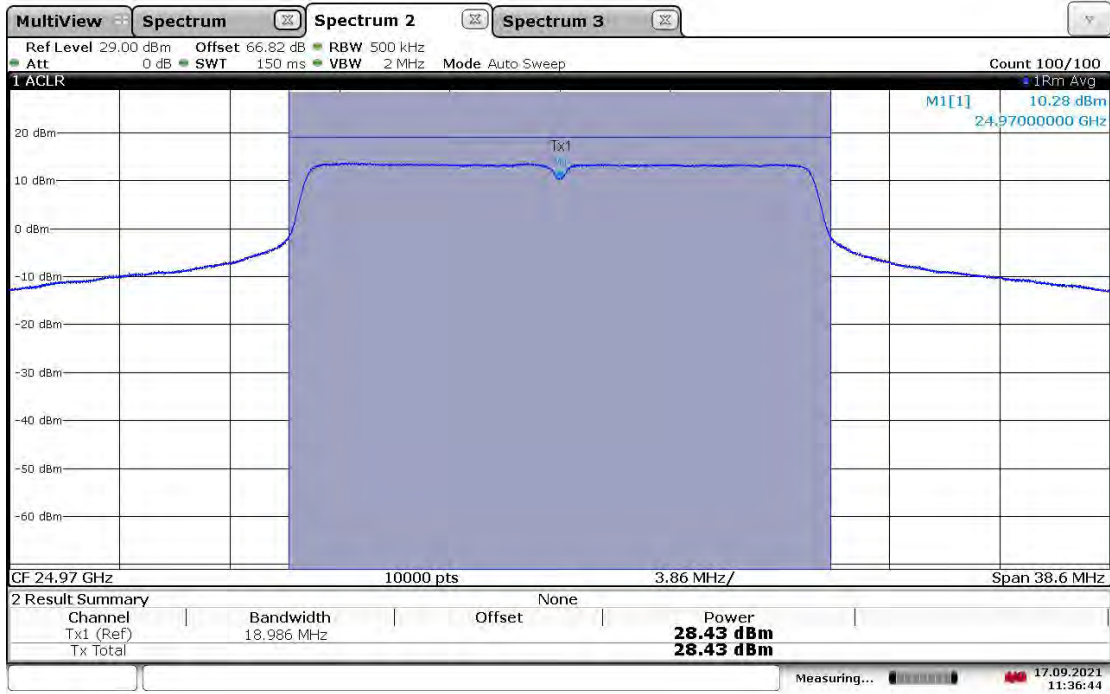

11:36:45 17.09.2021

EIRP Output Power (Vertical Polarity) – S01411_25.09GHz_BW20M_MCS8_Path 3_att16

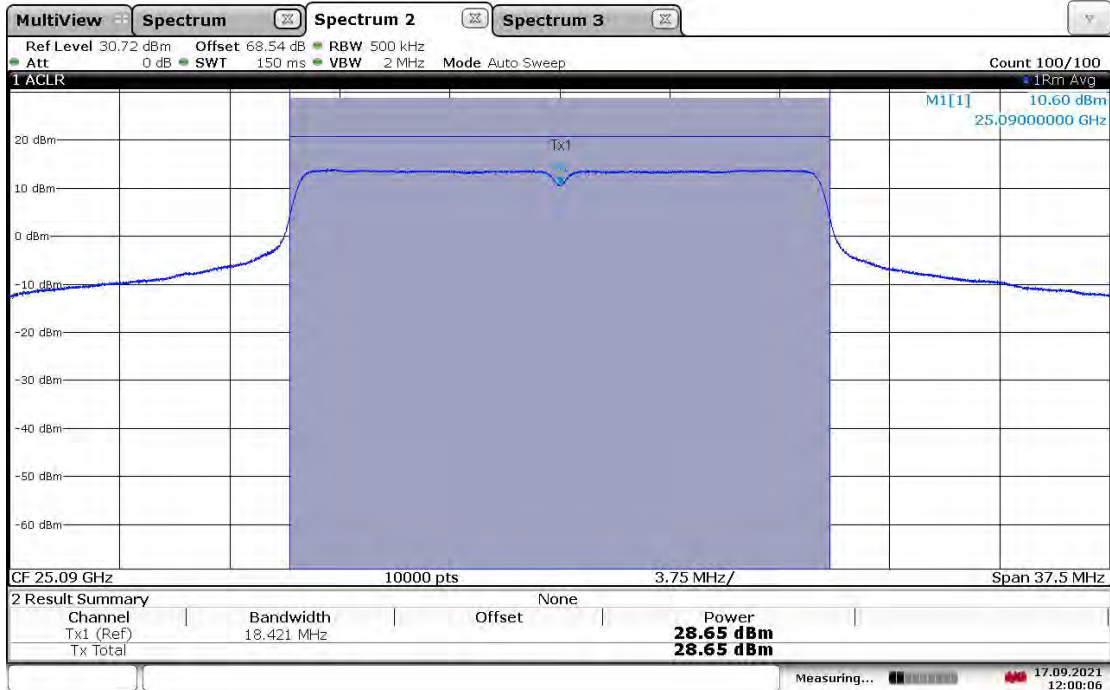

12:00:07 17.09.2021

EIRP Output Power (Horizontal Polarity) – S01411_24.27GHz_BW20M_MCS8_Path 3_att15

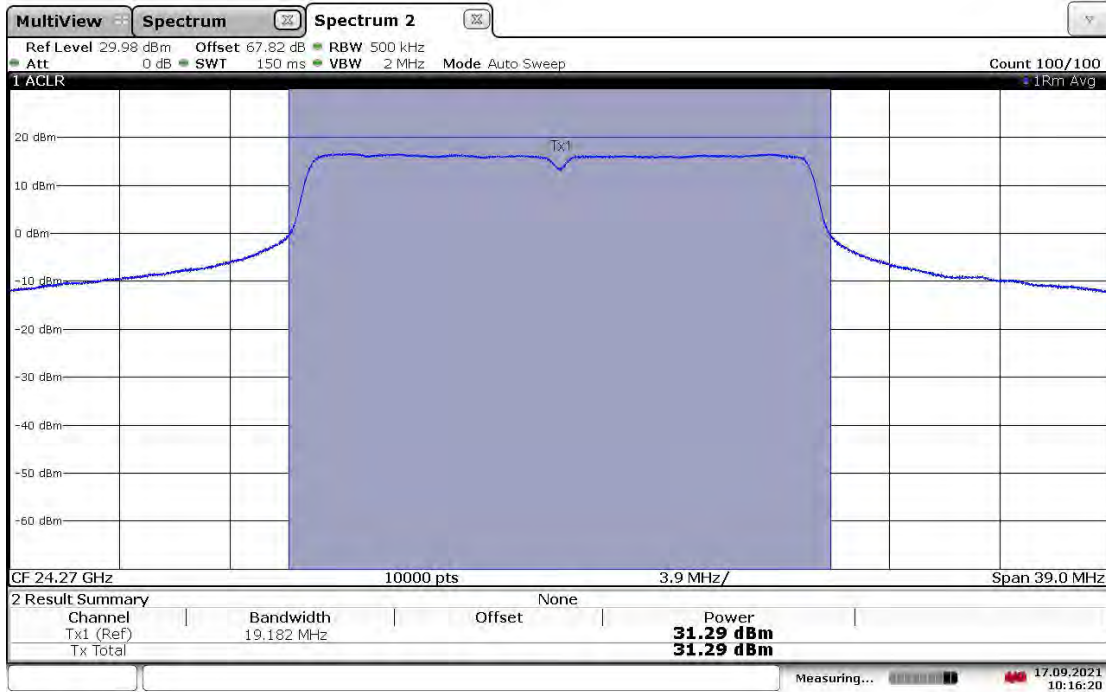

10:16:20 17.09.2021

EIRP Output Power (Horizontal Polarity) – S01411_24.28GHz_BW20M_MCS8_Path 3_att12

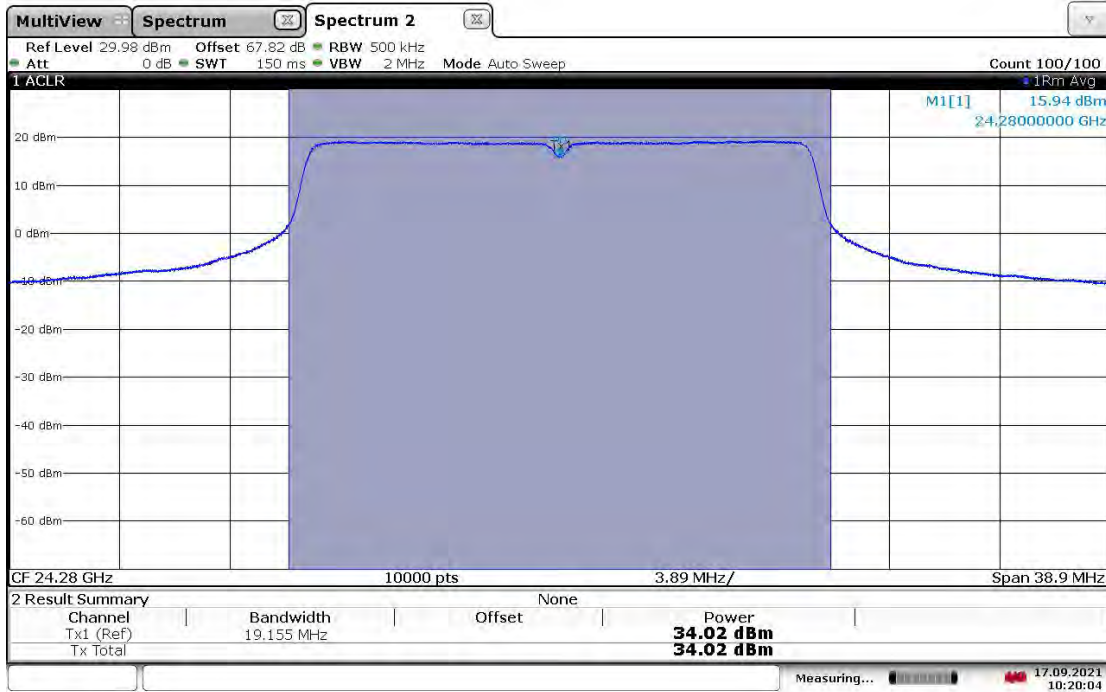

10:20:04 17.09.2021

EIRP Output Power (Horizontal Polarity) – S01411_24.29GHz_BW20M_MCS8_Path 3_att2

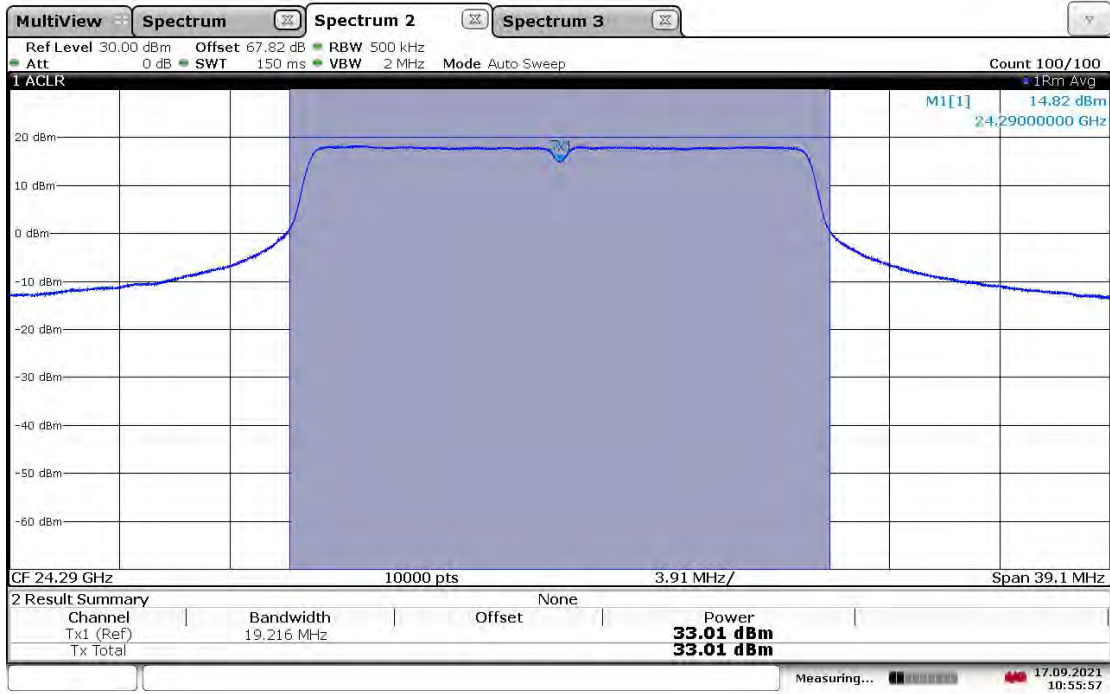

10:55:57 17.09.2021

EIRP Output Power (Horizontal Polarity) – S01411_24.77GHz_BW20M_MCS8_Path 3_att14

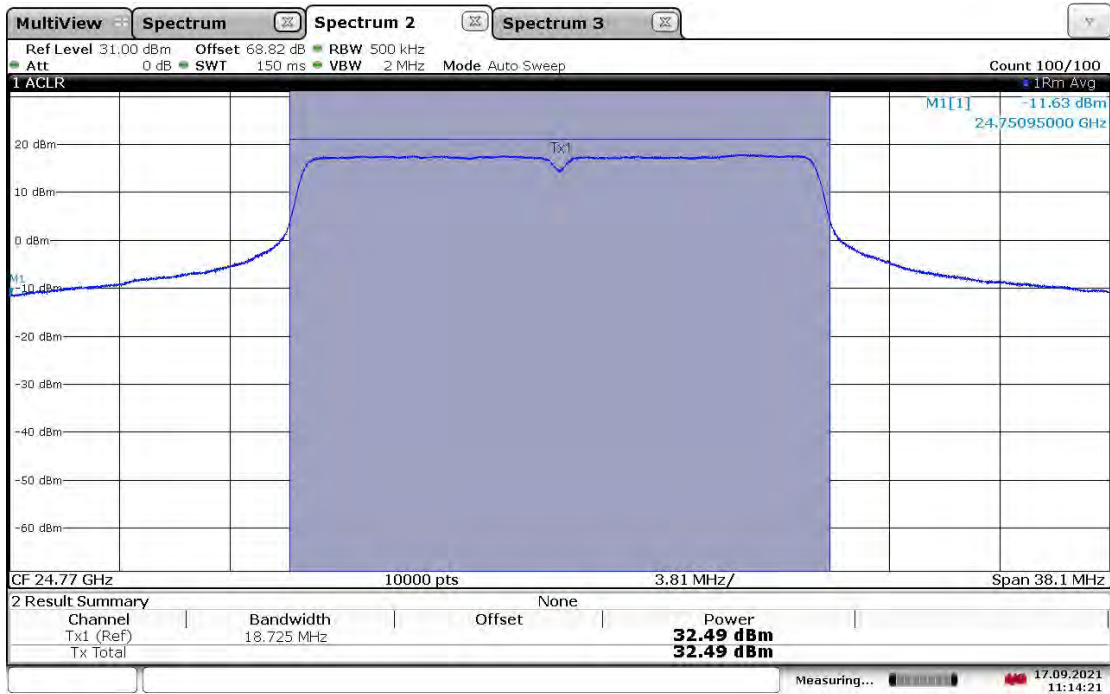

11:14:22 17.09.2021

EIRP Output Power (Horizontal Polarity) – S01411_24.97GHz_BW20M_MCS8_Path 3_att13

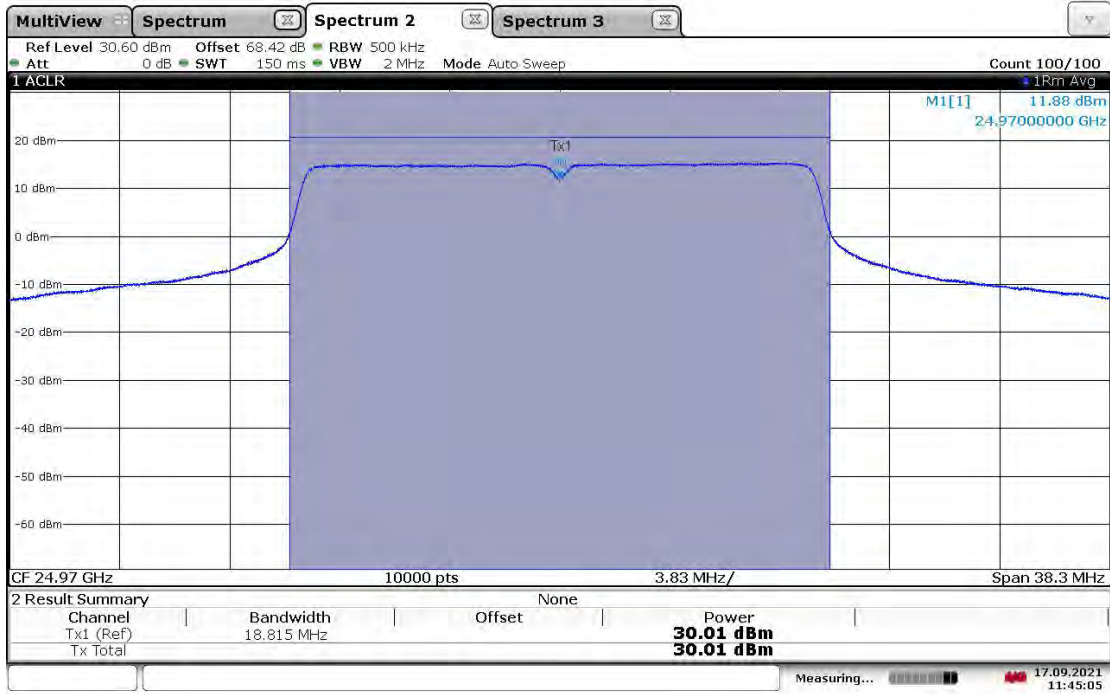

11:45:06 17.09.2021

EIRP Output Power (Horizontal Polarity) – S01411_25.09GHz_BW20M_MCS8_Path 3_att16

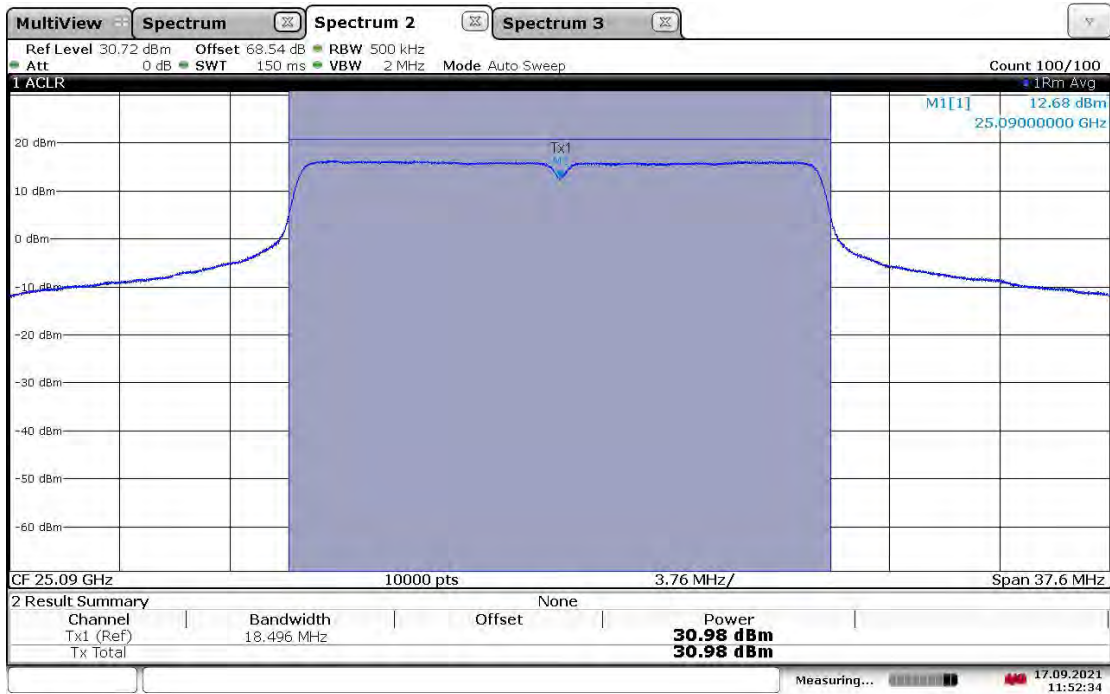

11:52:34 17.09.2021

EIRP Output Power (Vertical Polarity) – S01411_24.34GHz_BW160M_MCS8_Path 3_ATT12.5

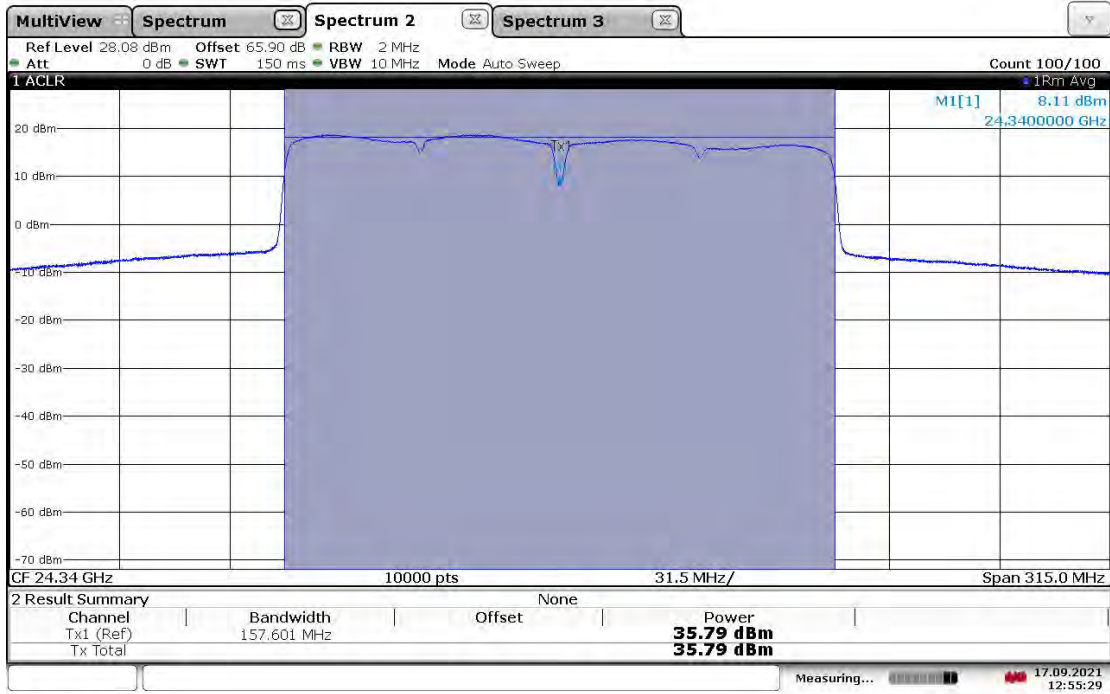

12:55:29 17.09.2021

EIRP Output Power (Vertical Polarity) – S01411_24.35MHz_BW160M_MCS8_Path 3_att12

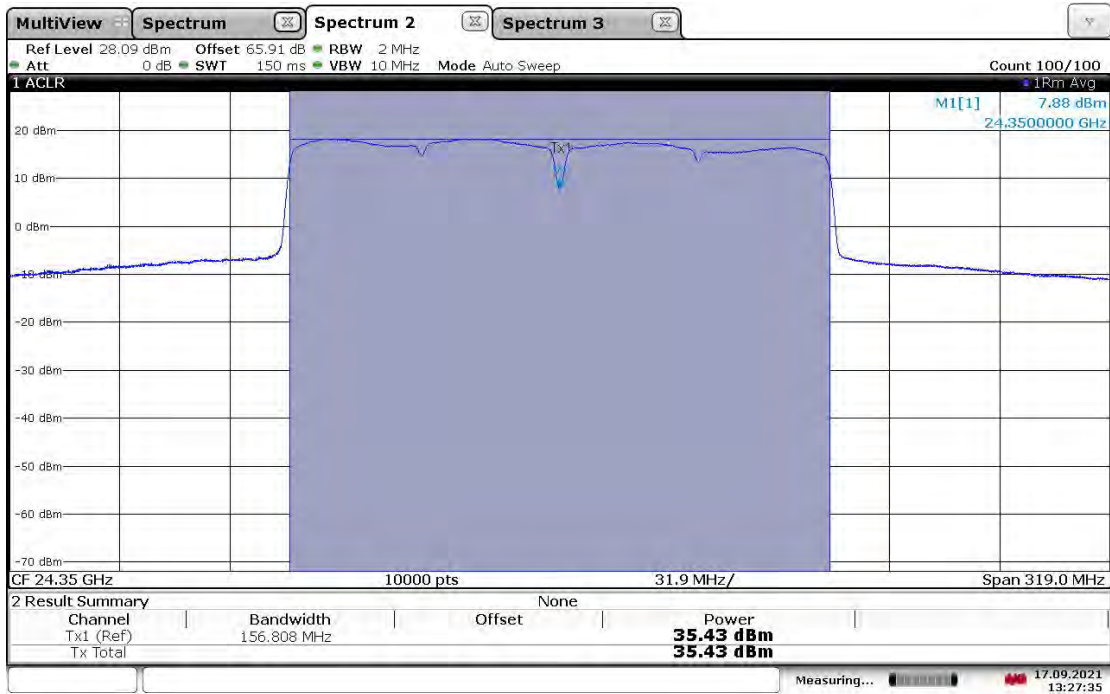

13:27:36 17.09.2021

EIRP Output Power (Vertical Polarity) – S01411_24.36GHz_BW160M_MCS8_Path 3_ATT8

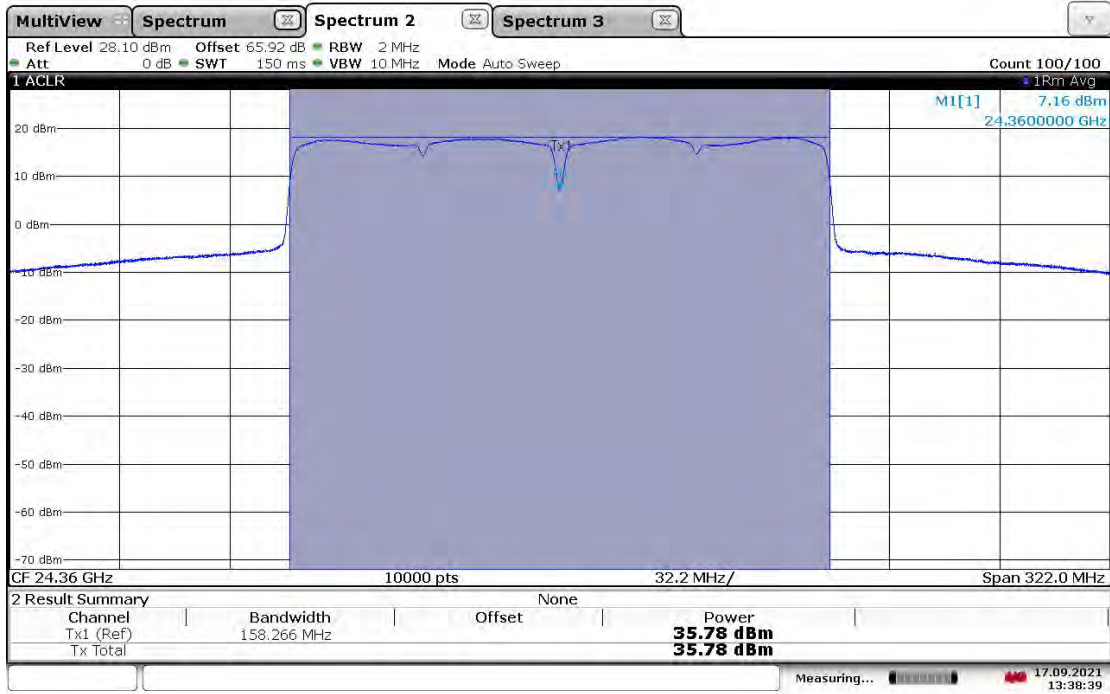

13:38:39 17.09.2021

EIRP Output Power (Vertical Polarity) – S01411_24.84GHz_BW160M_MCS8_Path 3_ATT12.5

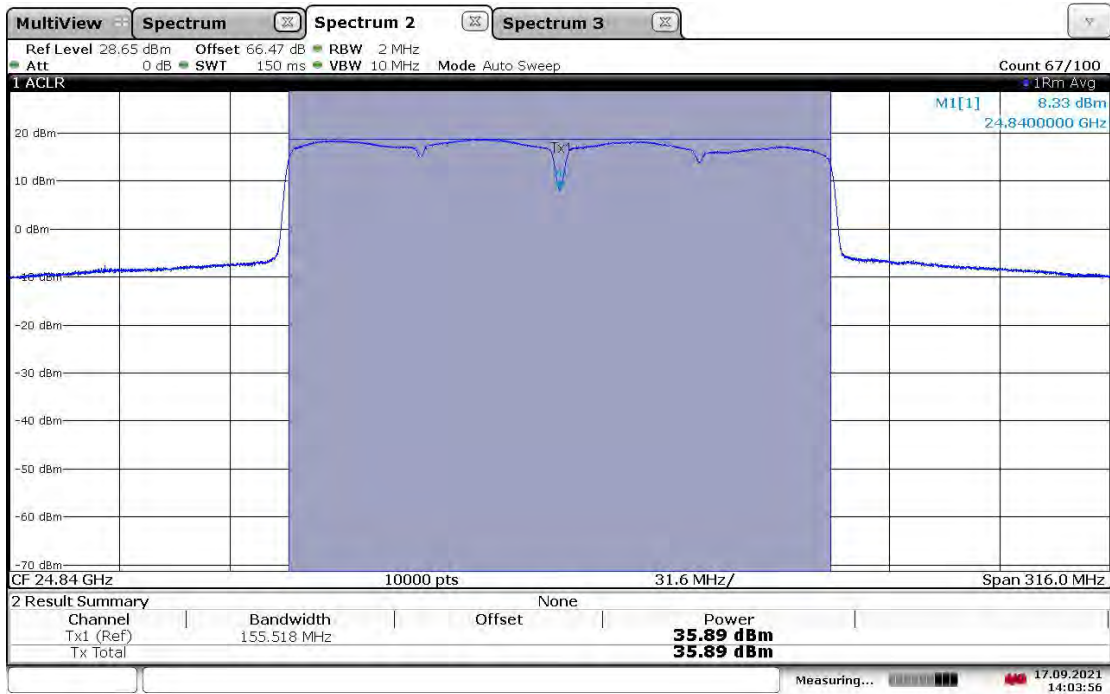

14:03:57 17.09.2021

EIRP Output Power (Vertical Polarity) – S01411_25.04GHz_BW160M_MCS8_Path 3_ATT12.5

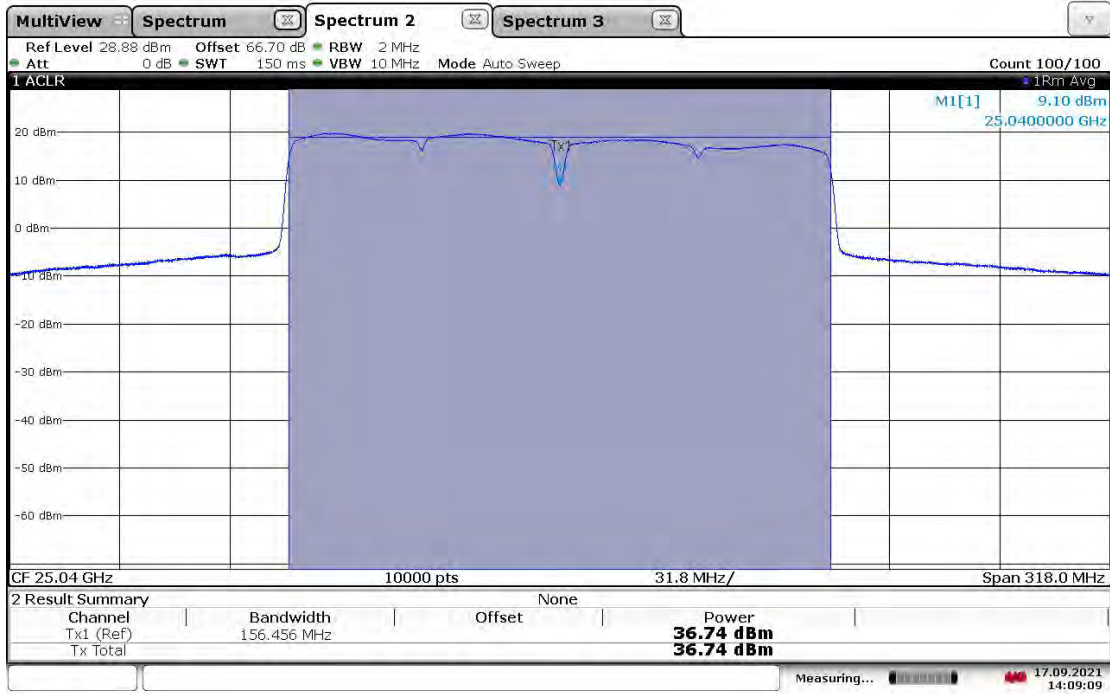

14:09:09 17.09.2021

EIRP Output Power (Vertical Polarity) – S01411_25.16GHz_BW160M_MCS8_Path 3_ATT10

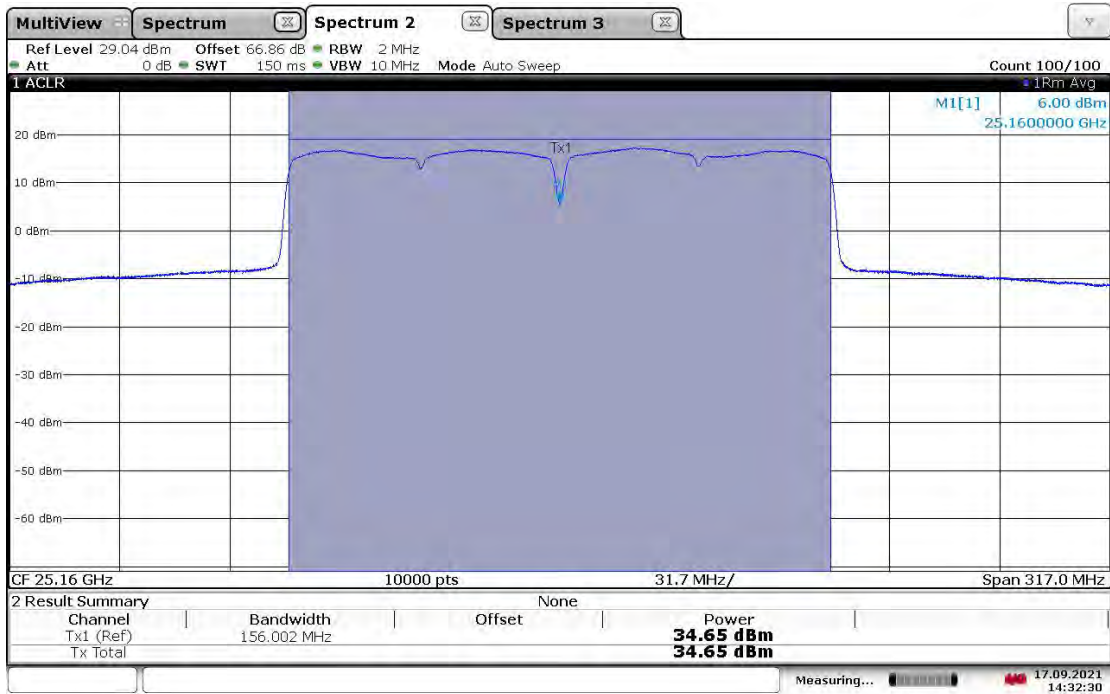

14:32:31 17.09.2021

EIRP Output Power (Horizontal Polarity) – S01411_24.34 MHz_BW160M_MCS8_Path 3_ATT12

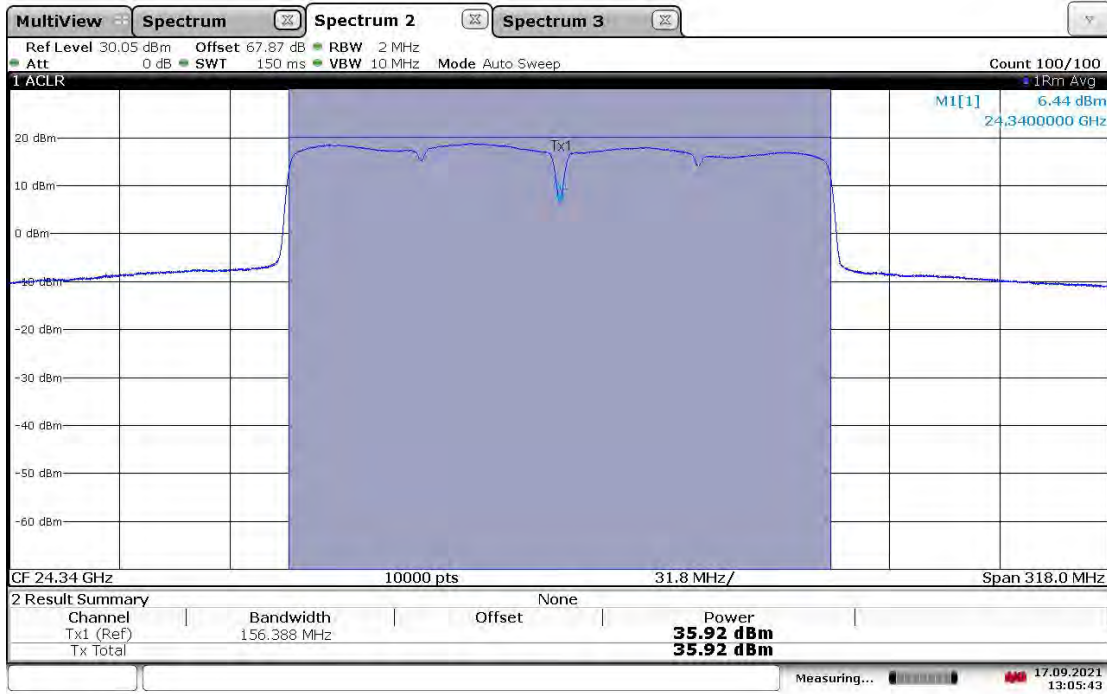

13:05:44 17.09.2021

EIRP Output Power (Horizontal Polarity) – S01411_24.35MHz_BW160M_MCS8_Path 3_ATT12

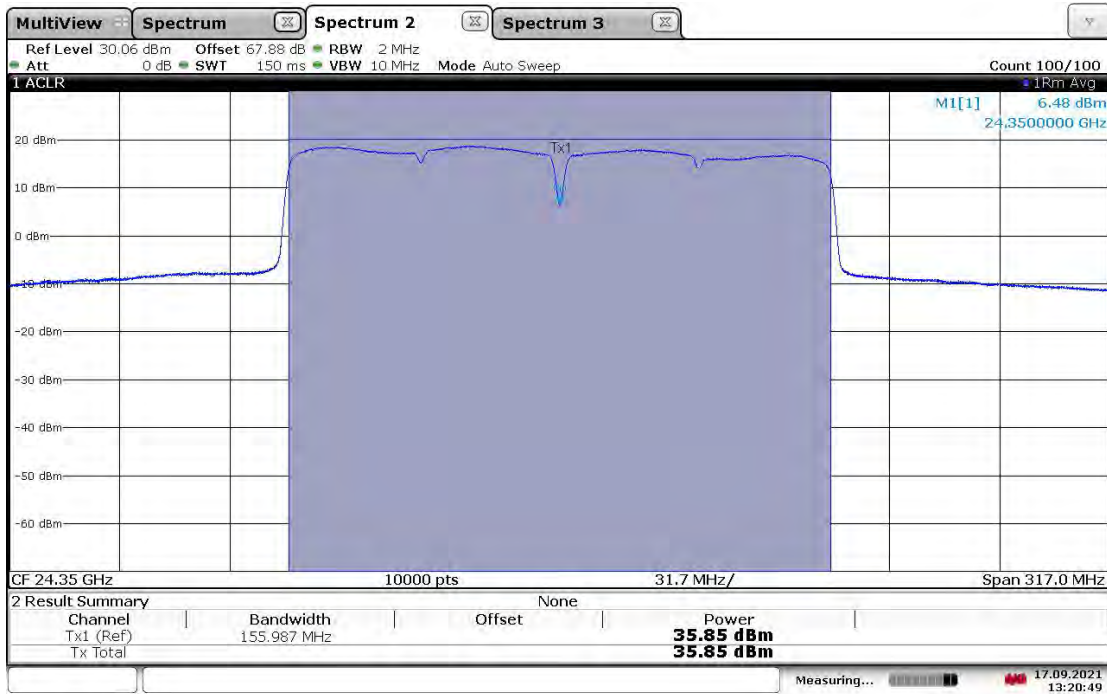

13:20:49 17.09.2021

EIRP Output Power (Horizontal Polarity) – S01411_24.36 GHz_BW160M_MCS8_Path 3_att1

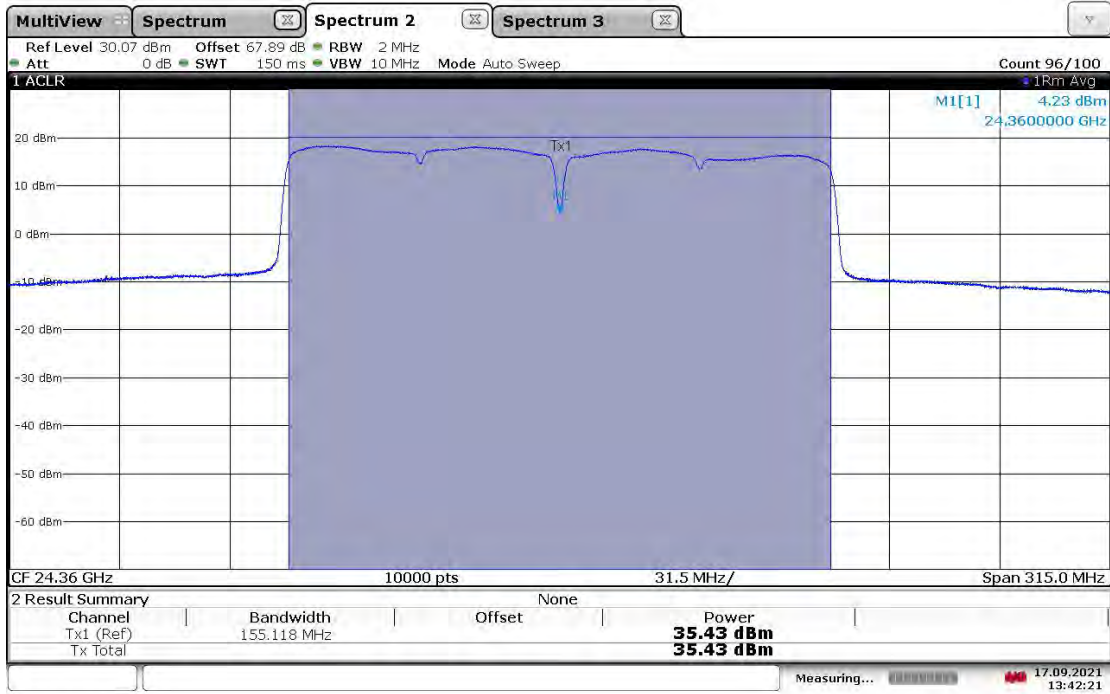

13:42:22 17.09.2021

EIRP Output Power (Horizontal Polarity) – S01411_24.84 GHz_BW160M_MCS8_Path 3_ATT11

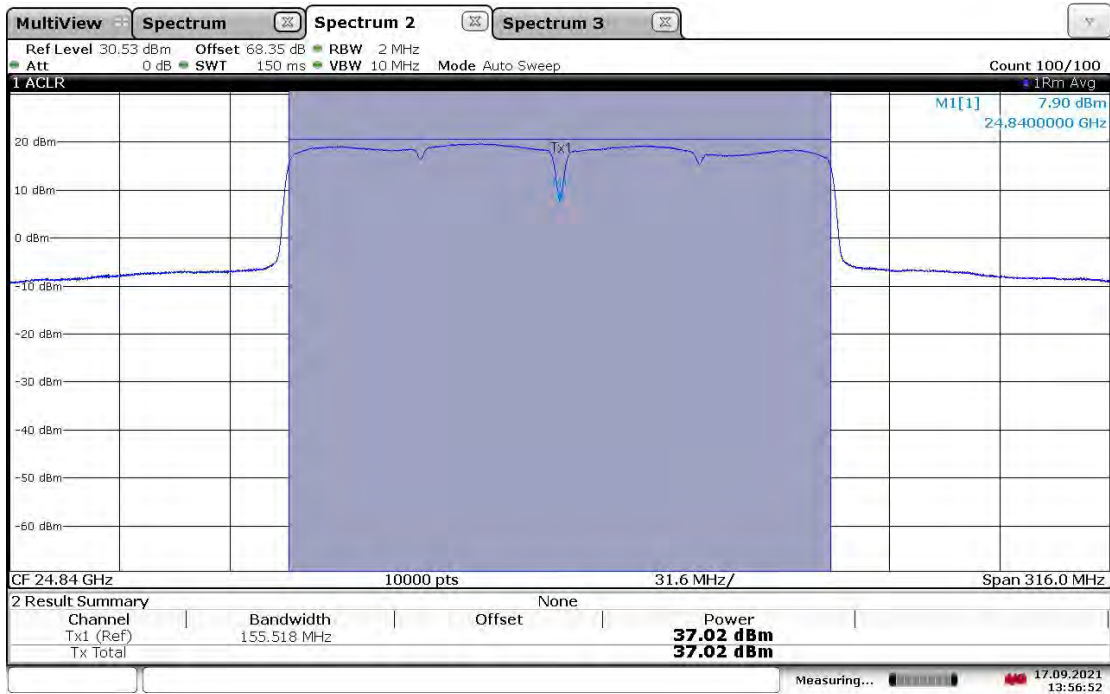

13:56:52 17.09.2021

EIRP Output Power (Horizontal Polarity) – S01411_25.04 GHz_BW160M_MCS8_Path 3_ATT8

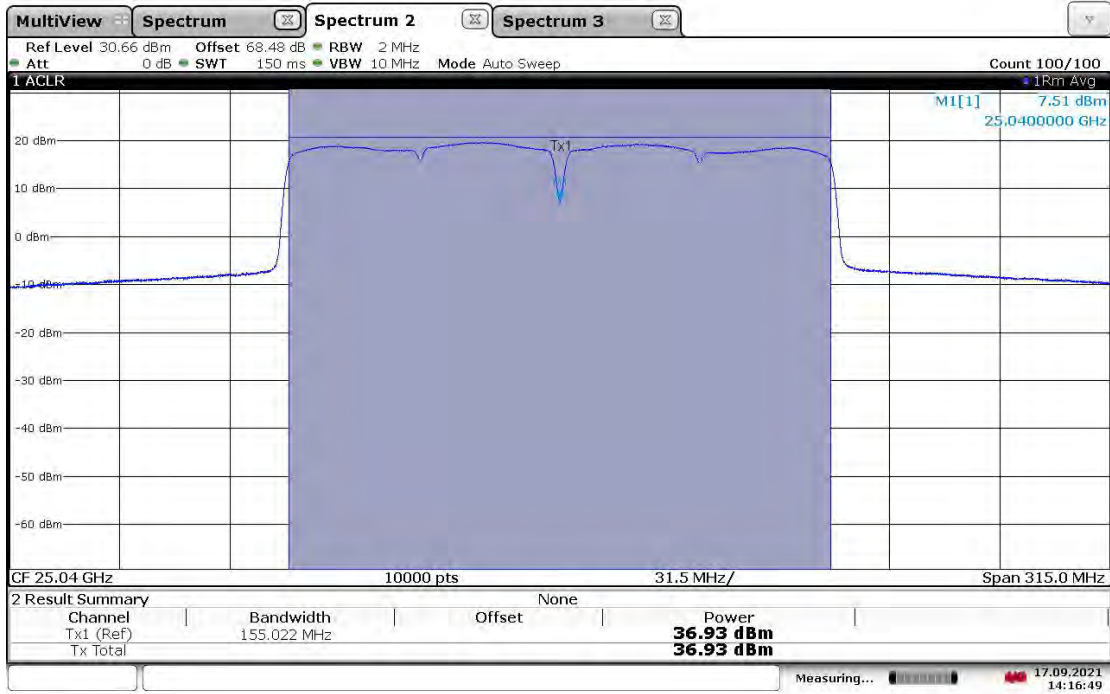

14:16:50 17.09.2021

EIRP Output Power(Horizontal Polarity) – S01411_25.16 GHz_BW160M_MCS8_Path 3_ATT12

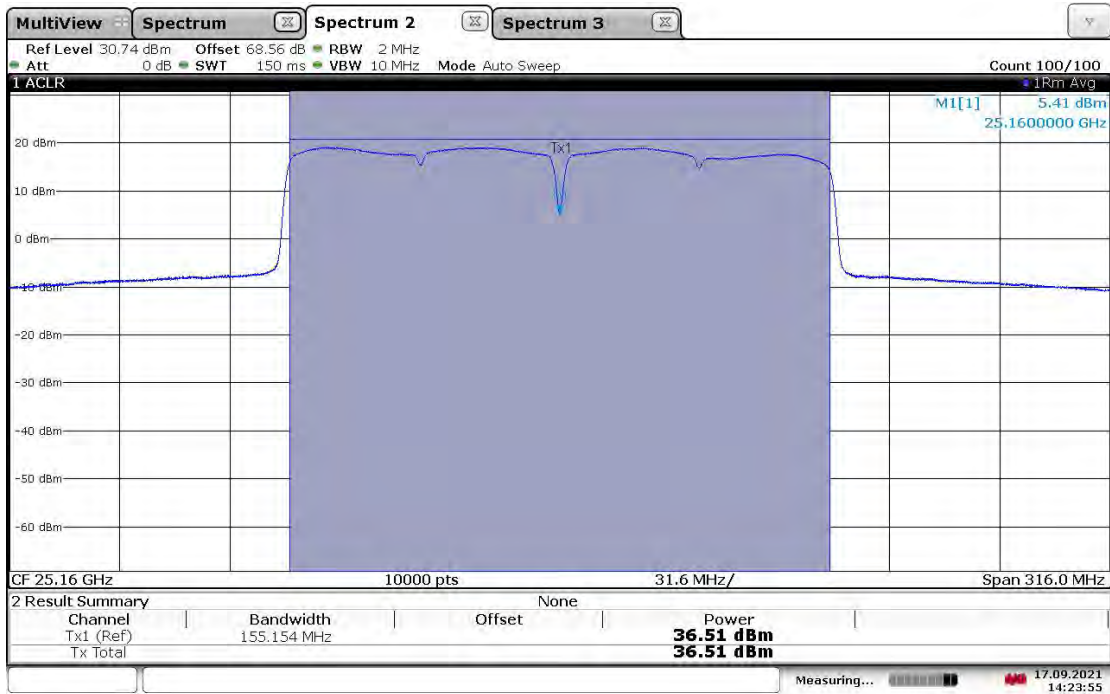

14:23:56 17.09.2021

Intertek

Report Number: 104689284BOX-001

Issued: 08/02/2021
Last Revised: 10/12/2021

Test Personnel: Kouma Sinn *KPS*
Supervising/Reviewing
Engineer: Vathana F. Ven *VFV*
(Where Applicable) FCC 47CFR Part 30 Subpart C
Product Standard: 48 VDC Via External P/S
Input Voltage:
Pretest Verification w/
BB Source: Yes

Test Date: 09/17/2021
Limit Applied: See Report Section 6.3
Ambient Temperature: 24 °C
Relative Humidity: 60 %
Atmospheric Pressure: 1008 mbars

Deviations, Additions, or Exclusions: None

7 Out of Band (OOB) Domain

7.1 Requirements

FCC §30.203 Emission limits.

- (a) The conductive power or the total radiated power of any emission outside a licensee's frequency block shall be -13 dBm/MHz or lower. However, in the bands immediately outside and adjacent to the licensee's frequency block, having a bandwidth equal to 10 percent of the channel bandwidth, the conductive power or the total radiated power of any emission shall be -5 dBm/MHz or lower.
- (b)
- (1) Compliance with this provision is based on the use of measurement instrumentation employing a resolution bandwidth of 1 megahertz or greater.
 - (2) When measuring the emission limits, the nominal carrier frequency shall be adjusted as close to the licensee's frequency block edges as the design permits.
 - (3) The measurements of emission power can be expressed in peak or average values

7.2 Method

Tests are performed in accordance with FCC 47CFR Part 30 Subpart C and KDB 842590 D01 v01r02 Subclause 4.4.2. The measurement was made on the maximum field strength in the same worst-case orientation as in Section 6.1

For band edge measurement, the single column gain (14 dBi) was subtracted and the 4xconducted gain ($10\log(4)$) was added to the offset.

TEST SITE: 10m ALSE

The 10m ALSE is 13m (Length) x 21m (Depth) x 10m (Height) with the effective size in terms of space from the tips of the absorber is 12m (Length) x 20m (Depth) x 8.5m (Height). This chamber achieves broadband performance using a unique arrangement of hybrid and ferrite tile absorber. This chamber has a built in 3m diameter turntable (Embedded type). The metal structure of the table makes electrical connection around the entire circumference of the turntable to the ground plane with a metal brush type connection. The turntable is located on one end of the chamber and the antennas are mounted 3 and 10 meters away at the other end of the chamber on the adjustable an Antenna Mast. The antenna mast is a non-conductive bore sighted type with remote control of antenna height and polarization. The Antenna Mast and the turntable can be remotely controlled through the controller located in the adjacent Control room. A Styrofoam table 80 cm high is used for table-top equipment.

Measurement Uncertainty

Measurement	Frequency Range	Expanded Uncertainty (k=2)
Radiated Emissions, 10m	30-1000 MHz	5.0 dB
Radiated Emissions, 3m	30-1000 MHz	4.6 dB
Radiated Emissions, 3m	1-6 GHz	4.9 dB
Radiated Emissions, 3m	6-15 GHz	5.1 dB
Radiated Emissions, 3m	15-18 GHz	4.7 dB
Radiated Emissions, 3m	18-40 GHz	4.7 dB

Sample Calculation

The field strength is calculated by adding the Antenna Factor and Cable Factor, and subtracting the Amplifier Gain (if any) from the measured reading. The basic equation with a sample calculation is as follows:

$$FS = RA + AF + CF - AG$$

Where

- FS = Field Strength in dBμV/m
- RA = Receiver Amplitude (including preamplifier) in dBμV
- CF = Cable Attenuation Factor in dB
- AF = Antenna Factor in dB
- AG = Amplifier Gain in dB

In the following table(s), the reading shown on the data table reflects the preamplifier gain. An example for the calculations in the following table is as follows.

Assume a receiver reading of 52.0 dBμV is obtained. The antenna factor of 7.4 dB and cable factor of 1.6 dB is added. The amplifier gain of 29 dB is subtracted, giving a field strength of 32 dBμV/m. This value in dBμV/m was converted to its corresponding level in μV/m.

RA = 52.0 dBμV
 AF = 7.4 dB/m
 CF = 1.6 dB
 AG = 29.0 dB
 FS = 32 dBμV/m

To convert from dBμV to μV or mV the following was used:

$$UF = 10^{(NF / 20)} \text{ where UF = Net Reading in } \mu\text{V}$$

$$NF = \text{Net Reading in dB}\mu\text{V}$$

Example:

$$FS = RA + AF + CF - AG = 52.0 + 7.4 + 1.6 - 29.0 = 32.0$$

$$UF = 10^{(32 \text{ dB}\mu\text{V} / 20)} = 39.8 \mu\text{V/m}$$

Alternately, when BAT-EMC Emission Software is used, the “Level” includes all losses and gains and is compared directly in the “Margin” column to the “Limit”. The “Correction” includes Antenna Factor, Preamp, and Cable Loss. These are already accounted for in the “Level” column.

7.3 Test Equipment Used:

Asset	Description	Manufacturer	Model	Serial	Cal Date	Cal Due
DAV007'	Weather Station Vantage Vue	Davis	6250	MS1912 12003	03/20/2021	03/20/2022
EMC04'	ANTENNA, RIDGED GUIDE, 18-40 GHZ	EMCO	3116	2090	01/28/2021	01/28/2022
ROS005-1'	Signal and Spectrum Analyzer	R&S	FSW43	100646	10/27/2020	10/27/2021
CBLHF2012-5M-2'	5m 9kHz-40GHz Coaxial Cable - SET2	Huber & Suhner	SF102	2526760 02	02/19/2021	02/19/2022

Software Utilized:

Name	Manufacturer	Version
None	--	--

7.4 Results:

The sample tested was found to Comply.

7.5 Setup Photographs:

Setup Photographs are included in a separate file.

7.6 Plots/Data:

Authorized Band 24.25-24.45 GHz, Emission Mask (V) – S01411_24.27GHz_BW20M_MCS8_Path 3_att16.5

Lower Edge – From Mark 1 to Mark 2 the limit is -5 dBm and outside of Mark 1 to the left the limit is -13 dBm

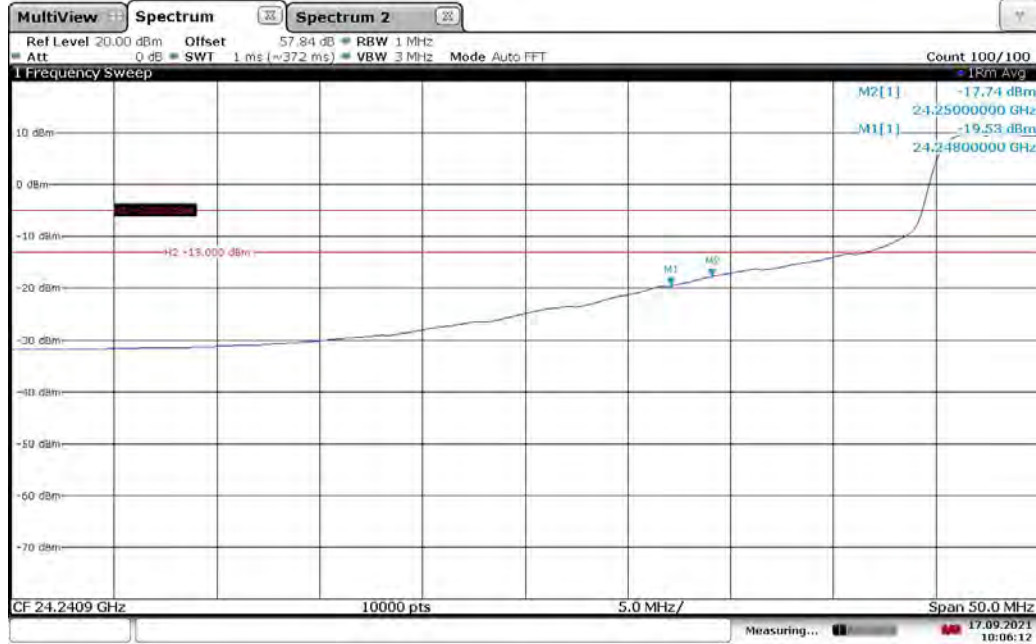

10:06:13 17.09.2021

Authorized Band 24.25-24.45 GHz, Emission Mask (H) – S01411_24.27GHz_BW20M_MCS8_Path 3_att15

Lower Edge – From Mark 1 to Mark 2 the limit is -5 dBm and outside of Mark 1 to the left the limit is -13 dBm



10:15:14 17.09.2021

Authorized Band 24.25-24.45 GHz, Emission Mask (V) – S01411_24.29GHz_BW20M_MCS8_Path 3_att13.5

Upper Edge – From Mark 1 to Mark 2 the limit is -5 dBm and outside of Mark 2 to the right the limit is -13 dBm

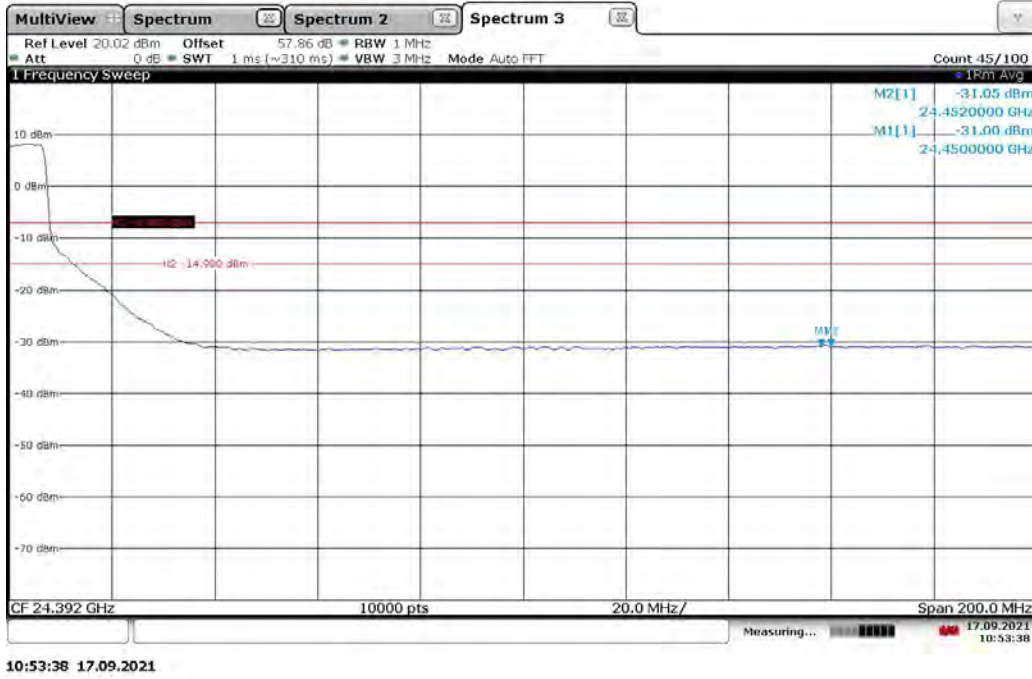

Authorized Band 24.25-24.45 GHz, Emission Mask (H) – S01411_24.29GHz_BW20M_MCS8_Path 3_att13.5

Upper Edge – From Mark 1 to Mark 2 the limit is -5 dBm and outside of Mark 2 to the right the limit is -13 dBm

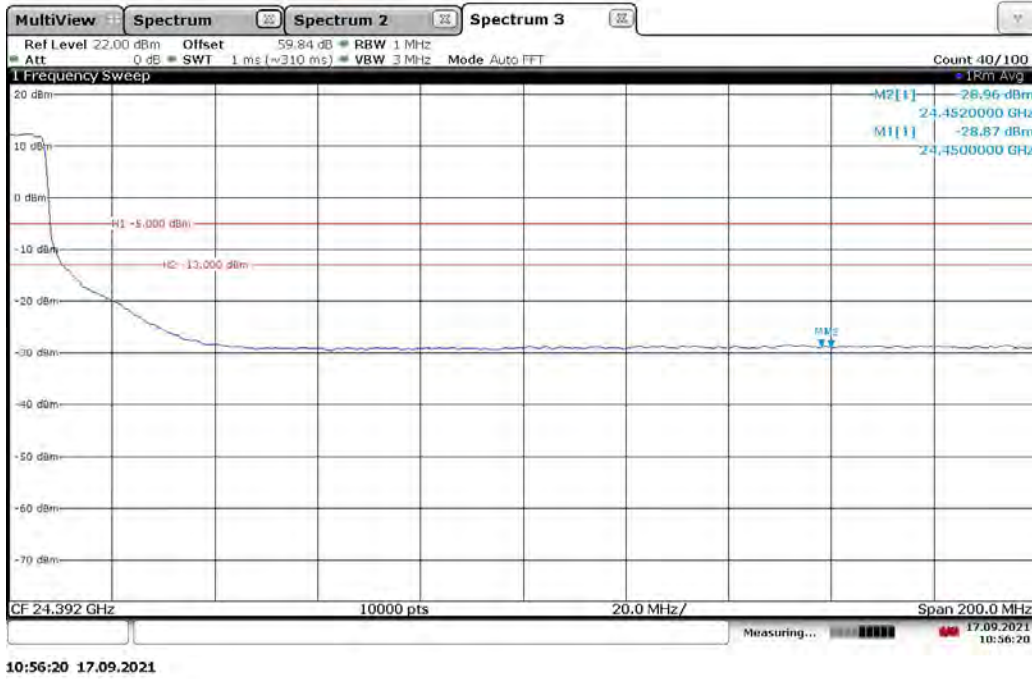

Authorized Band 24.75-25.25 GHz, Emission Mask (V) – S01411_24.77GHz_BW20M_MCS8_Path 3_att18
Lower Edge – From Mark 1 to Mark 2 the limit is -5 dBm and outside of Mark 1 to the left the limit is -13 dBm



11:25:10 17.09.2021

Authorized Band 24.75-25.25 GHz, Emission Mask (H) – S01411_24.77GHz_BW20M_MCS8_Path 3_att14
Lower Edge – From Mark 1 to Mark 2 the limit is -5 dBm and outside of Mark 1 to the left the limit is -13 dBm



11:15:24 17.09.2021

Authorized Band 24.75-25.25 GHz, Emission Mask (V) – S01411_25.09GHz_BW20M_MCS8_Path 3_att16

Upper Edge – From Mark 1 to Mark 2 the limit is -5 dBm and outside of Mark 2 to the right the limit is -13 dBm

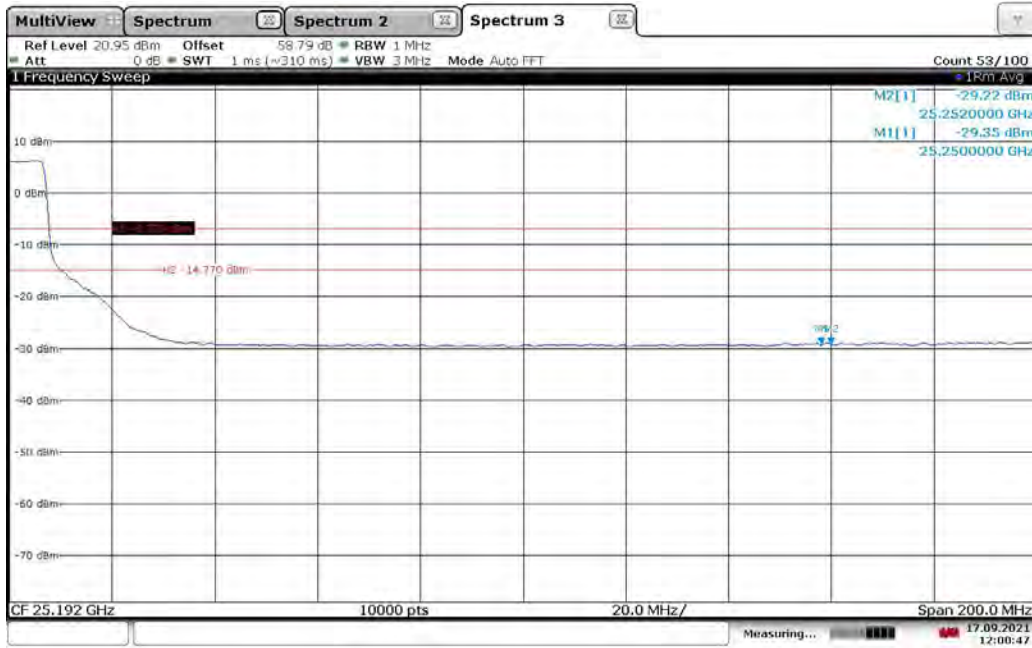

12:00:48 17.09.2021

Authorized Band 24.75-25.25 GHz, Emission Mask (H) – S01411_25.09GHz_BW20M_MCS8_Path 3_att15

Upper Edge – From Mark 1 to Mark 2 the limit is -5 dBm and outside of Mark 2 to the right the limit is -13 dBm

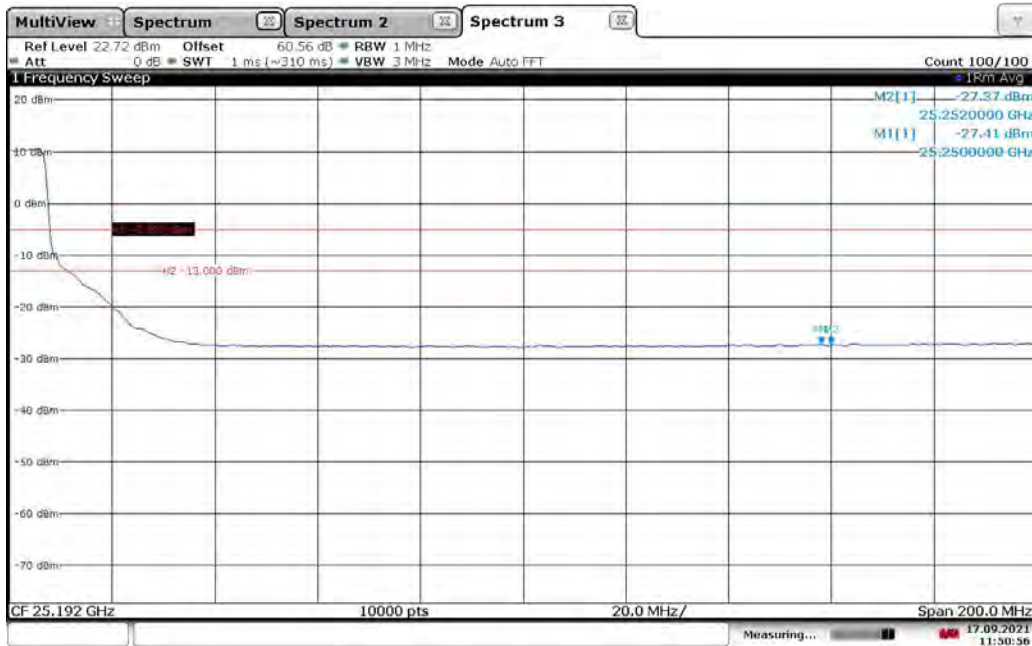

11:50:57 17.09.2021

Authorized Band 24.25-24.45 GHz, Emission Mask (V) – S01411_24.34 GHz_BW20M_MCS8_Path 3_att12.5
Lower Edge – From Mark 1 to Mark 2 the limit is -5 dBm and outside of Mark 1 to the left the limit is -13 dBm

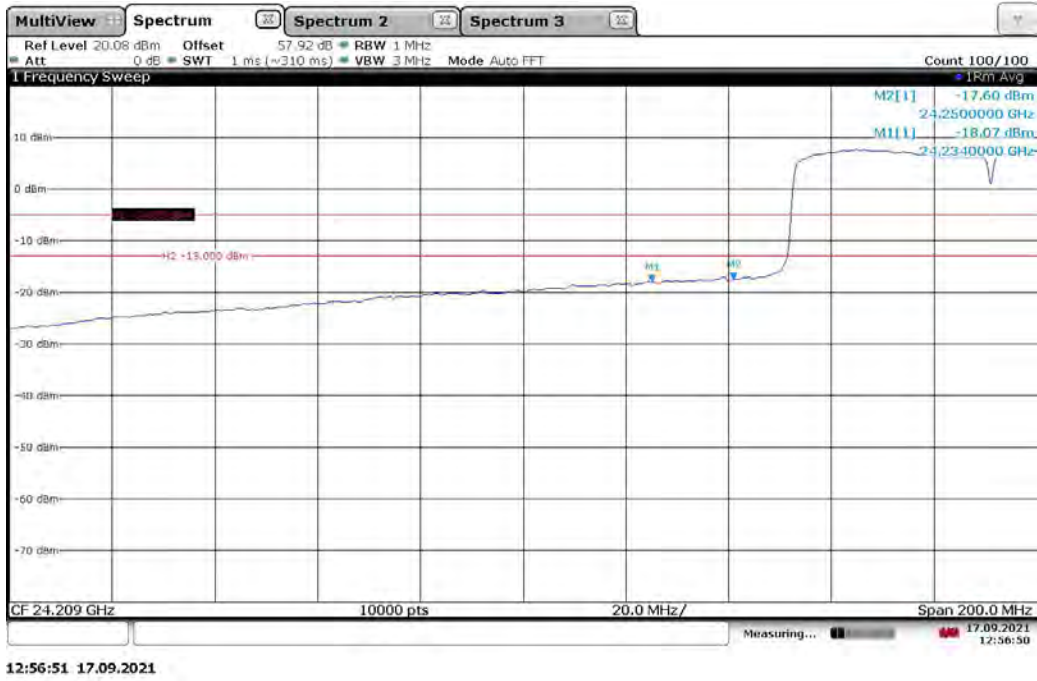

Authorized Band 24.25-24.45 GHz, Emission Mask (H) – S01411_24.34GHz_BW20M_MCS8_Path 3_att12
Lower Edge – From Mark 1 to Mark 2 the limit is -5 dBm and outside of Mark 1 to the left the limit is -13 dBm

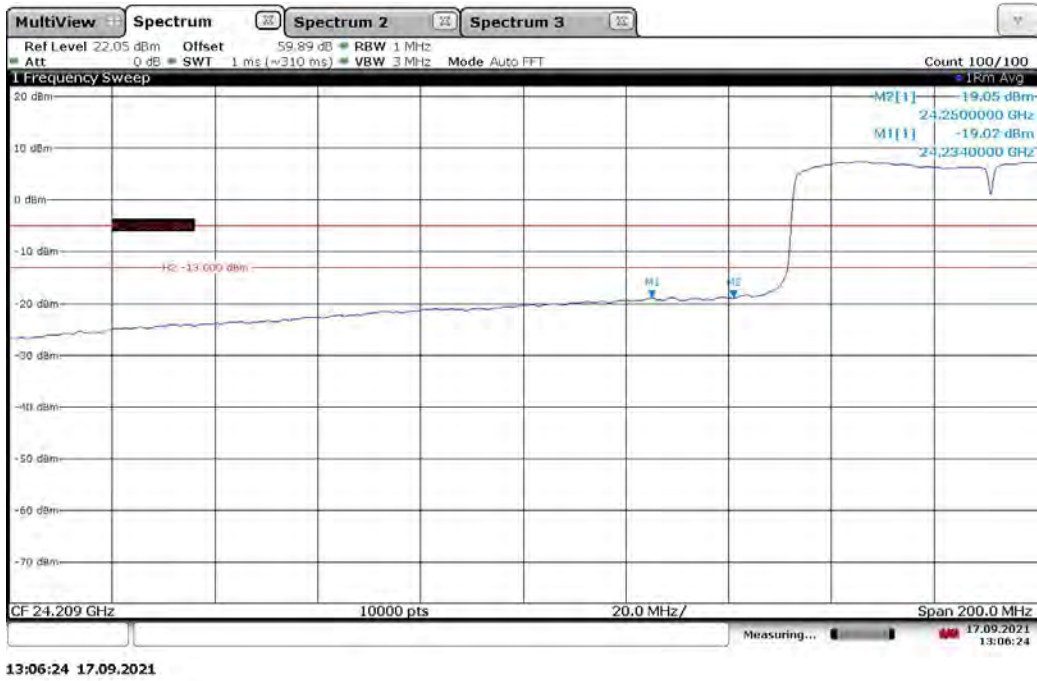

Authorized Band 24.25-24.45 GHz, Emission Mask (V) – S01411_24.36GHz_BW20M_MCS8_Path 3_att8

Upper Edge – From Mark 1 to Mark 2 the limit is -5 dBm and outside of Mark 2 to the right the limit is -13 dBm



Authorized Band 24.25-24.45 GHz, Emission Mask (H) – S01411_24.36 GHz_BW20M_MCS8_Path 3_att1

Upper Edge – From Mark 1 to Mark 2 the limit is -5 dBm and outside of Mark 2 to the right the limit is -13 dBm



Authorized Band 24.75-25.25 GHz, Emission Mask (V) – S01411_24.84GHz_BW20M_MCS8_Path 3_att11
Lower Edge – From Mark 1 to Mark 2 the limit is -5 dBm and outside of Mark 1 to the left the limit is -13 dBm

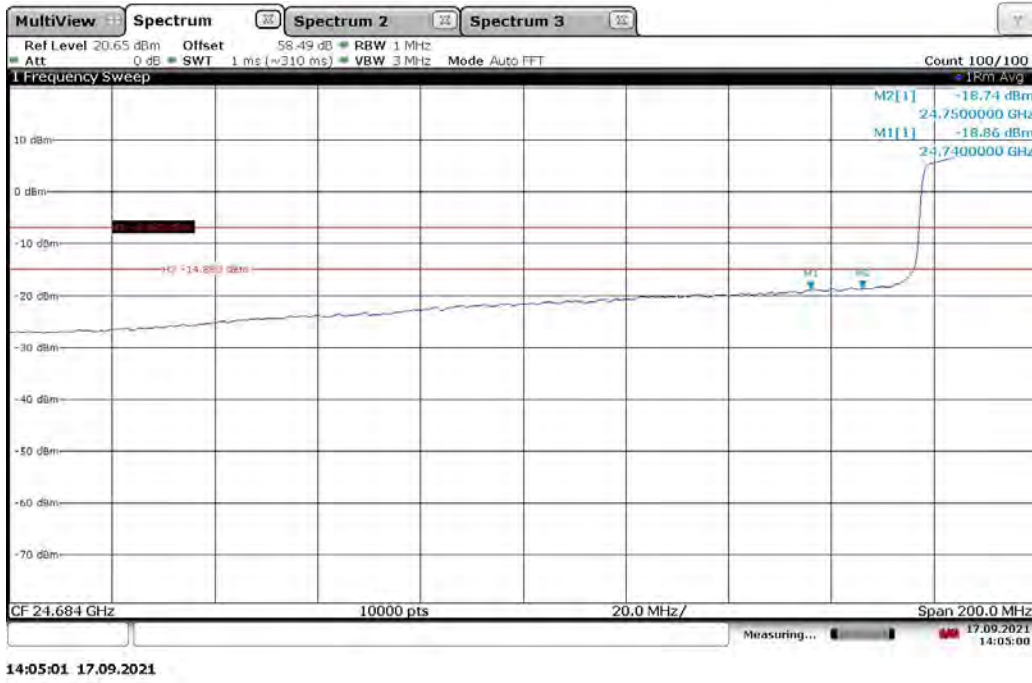

Authorized Band 24.75-25.25 GHz, Emission Mask (H) – S01411_24.84GHz_BW20M_MCS8_Path 3_att11
Lower Edge – From Mark 1 to Mark 2 the limit is -5 dBm and outside of Mark 1 to the left the limit is -13 dBm

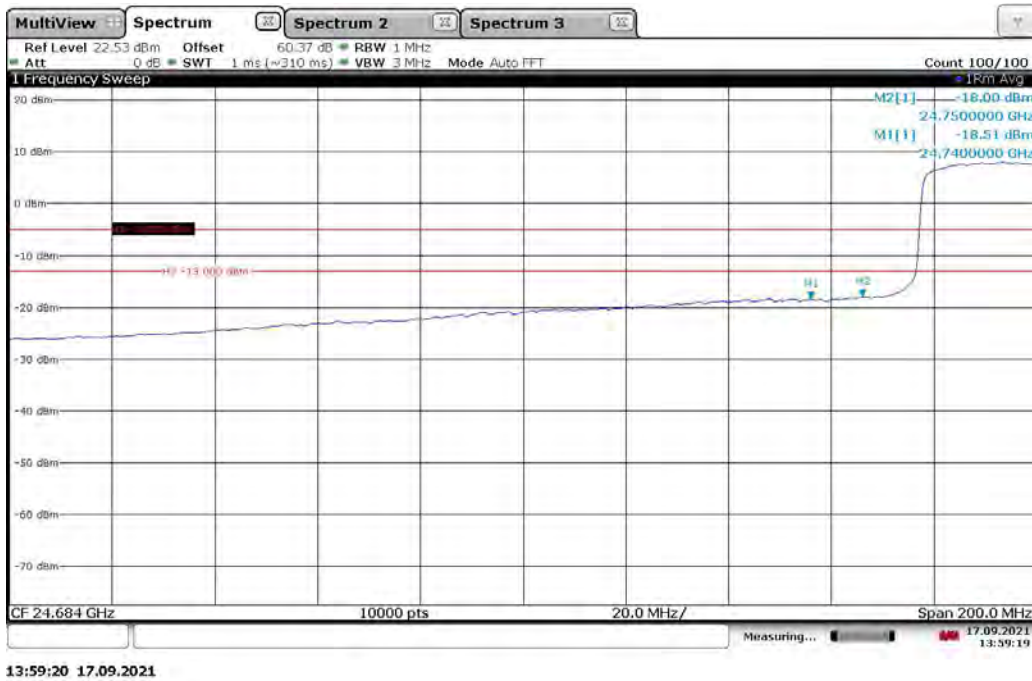

Authorized Band 24.75-25.25 GHz, Emission Mask (V) – S01411_25.16 GHz_BW20M_MCS8_Path 3_att10

Upper Edge – From Mark 1 to Mark 2 the limit is -5 dBm and outside of Mark 2 to the right the limit is -13 dBm



14:34:24 17.09.2021

Authorized Band 24.75-25.25 GHz, Emission Mask (H) – S01411_25.16 GHz_BW20M_MCS8_Path 3_att12

Upper Edge – From Mark 1 to Mark 2 the limit is -5 dBm and outside of Mark 2 to the right the limit is -13 dBm

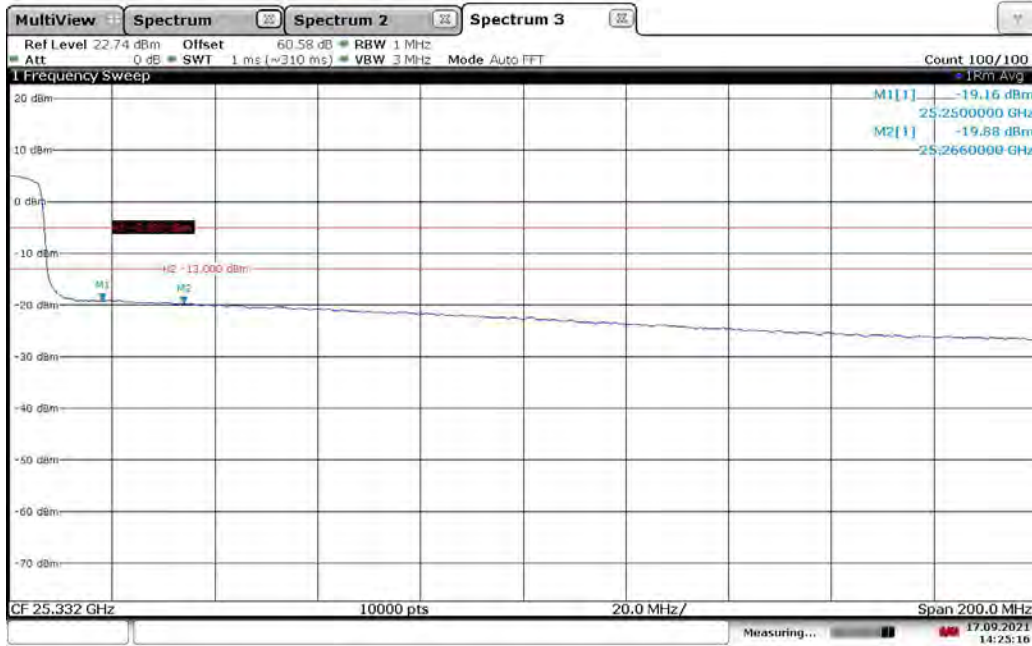

14:25:17 17.09.2021

Intertek

Report Number: 104689284BOX-001

Issued: 08/02/2021
Last Revised: 10/12/2021

Test Personnel: Kouma Sinn *KPS*
Supervising/Reviewing
Engineer:
(Where Applicable) Vathana F. Ven *VFV*
Product Standard: FCC 47CFR Part 30 Subpart C
Input Voltage: 48 VDC Via External P/S
Pretest Verification w/
BB Source: Yes

Test Date: 09/17/2021
Limit Applied: See Report Section 7.3
Ambient Temperature: 24 °C
Relative Humidity: 60 %
Atmospheric Pressure: 1008 mbars

Deviations, Additions, or Exclusions: None

8 Radiated Spurious Emissions

8.1 Requirements

FCC §30.203 Emission limits.

- (c) The conductive power or the total radiated power of any emission outside a licensee's frequency block shall be -13 dBm/MHz or lower. However, in the bands immediately outside and adjacent to the licensee's frequency block, having a bandwidth equal to 10 percent of the channel bandwidth, the conductive power or the total radiated power of any emission shall be -5 dBm/MHz or lower.
- (d)
 - (4) Compliance with this provision is based on the use of measurement instrumentation employing a resolution bandwidth of 1 megahertz or greater.
 - (5) When measuring the emission limits, the nominal carrier frequency shall be adjusted as close to the licensee's frequency block edges as the design permits.
 - (6) The measurements of emission power can be expressed in peak or average values

8.2 Method

Tests are performed in accordance with FCC 47CFR Part 30 Subpart C, KDB 842590 D01 v01r02 Subclause 4.4.3. From 9 kHz-1000 MHz testing was performed manually and from 1-13 GHz measurements were made using the BAT-EMC automated software. From 13-100 GHz measurement was made manually at 3 meters with test antenna and EUT fixed at 1.5 meters high. The EUT was rotated from 0 to 360 degrees to find the worst-case emissions.

TEST SITE: 10m ALSE

The 10m ALSE is 13m (Length) x 21m (Depth) x 10m (Height) with the effective size in terms of space from the tips of the absorber is 12m (Length) x 20m (Depth) x 8.5m (Height). This chamber achieves broadband performance using a unique arrangement of hybrid and ferrite tile absorber. This chamber has a built in 3m diameter turntable (Embedded type). The metal structure of the table makes electrical connection around the entire circumference of the turntable to the ground plane with a metal brush type connection. The turntable is located on one end of the chamber and the antennas are mounted 3 and 10 meters away at the other end of the chamber on the adjustable an Antenna Mast. The antenna mast is a non-conductive bore sighted type with remote control of antenna height and polarization. The Antenna Mast and the turntable can be remotely controlled through the controller located in the adjacent Control room. A Styrofoam table 80 cm high is used for table-top equipment.

Measurement Uncertainty

Measurement	Frequency Range	Expanded Uncertainty (k=2)
Radiated Emissions, 10m	30-1000 MHz	5.0 dB
Radiated Emissions, 3m	30-1000 MHz	4.6 dB
Radiated Emissions, 3m	1-6 GHz	4.9 dB
Radiated Emissions, 3m	6-15 GHz	5.1 dB
Radiated Emissions, 3m	15-18 GHz	4.7 dB
Radiated Emissions, 3m	18-40 GHz	4.7 dB

Sample Calculation

The field strength is calculated by adding the Antenna Factor and Cable Factor, and subtracting the Amplifier Gain (if any) from the measured reading. The basic equation with a sample calculation is as follows:

$$FS = RA + AF + CF - AG$$

Where

- FS = Field Strength in dB μ V/m
- RA = Receiver Amplitude (including preamplifier) in dB μ V
- CF = Cable Attenuation Factor in dB
- AF = Antenna Factor in dB
- AG = Amplifier Gain in dB

In the following table(s), the reading shown on the data table reflects the preamplifier gain. An example for the calculations in the following table is as follows.

Assume a receiver reading of 52.0 dB μ V is obtained. The antenna factor of 7.4 dB and cable factor of 1.6 dB is added. The amplifier gain of 29 dB is subtracted, giving a field strength of 32 dB μ V/m. This value in dB μ V/m was converted to its corresponding level in μ V/m.

RA = 52.0 dB μ V
AF = 7.4 dB/m
CF = 1.6 dB
AG = 29.0 dB
FS = 32 dB μ V/m

To convert from dB μ V to μ V or mV the following was used:

$$UF = 10^{(NF / 20)} \text{ where } UF = \text{Net Reading in } \mu\text{V}$$
$$NF = \text{Net Reading in dB}\mu\text{V}$$

Example:

$$FS = RA + AF + CF - AG = 52.0 + 7.4 + 1.6 - 29.0 = 32.0$$
$$UF = 10^{(32 \text{ dB}\mu\text{V} / 20)} = 39.8 \mu\text{V/m}$$

Alternately, when BAT-EMC Emission Software is used, the "Level" includes all losses and gains and is compared directly in the "Margin" column to the "Limit". The "Correction" includes Antenna Factor, Preamp, and Cable Loss. These are already accounted for in the "Level" column.

8.3 Test Equipment Used:

Test equipment used in June

Asset	Description	Manufacturer	Model	Serial	Cal Date	Cal Due
DAV007'	Weather Station Vantage Vue	Davis	6250	MS191212003	03/20/2021	03/20/2022
145109'	DC Block	Coaxial Components	5985-9	none	VBU	Verified
PRE11'	50dB gain pre-amp	Pasternack	PRE11	PRE11	09/11/2020	09/11/2021
145108'	EMI Test Receiver (20Hz - 40GHz)	Rohde & Schwarz	ESIB40	100209	06/08/2020	06/08/2021
HS002'	DC-18GHz cable 1.5M long	Huber & Suhner	SucoFlex 106A	HS002	11/25/2020	11/25/2021
145-406'	10m Track A In-floor Cable #1	Huber + Suhner	sucoflex 160-19220mm	001	07/13/2020	07/13/2021
IW001'	2 meter cable	Insulated Wire	2801-NPS	001	10/07/2020	10/07/2021
IW006'	DC-18GHz cable 8.4m long	Insulated Wire	2800-NPS	IW006	11/25/2020	11/25/2021
IW003'	8.4 meter cable	Insulated Wire	2800-NPS	003	10/08/2020	10/08/2021
PRE12'	Pre-amplifier	Com Power	PAM-118A	18040117	12/07/2020	12/07/2021
ETS002'	1-18GHz DRG Horn Antenna	ETS Lindgren	3117	00143260	08/03/2020	08/03/2021
145-414'	Cables 145-400 145-403 145-405 145-409	Huber + Suhner	3m Track A cables	multiple	06/25/2020	06/25/2021
IW002'	2 meter Armored cable	Insulated Wire	2800-NPS	002	09/23/2020	09/23/2021
DAV007'	Weather Station Vantage Vue	Davis	6250	MS191212003	03/20/2021	03/20/2022
EMC04'	ANTENNA, RIDGED GUIDE, 18-40 GHZ	EMCO	3116	2090	01/28/2021	01/28/2022
ROS005-1'	Signal and Spectrum Analyzer	Rohde and Shwartz	FSW43	100646	10/27/2020	10/27/2021
CBLHF2012-5M-2'	5m 9kHz-40GHz Coaxial Cable - SET2	Huber & Suhner	SF102	252676002	02/19/2021	02/19/2022
ETS003'	9kHz-30MHz Active Loop Antenna	ETS Lindgren	6502	00143396	07/28/2020	07/28/2021
---	40-60 GHz Spectrum Analyzer Extension Module	Virginia Diodes, Inc.	VDIWR19.0S AX-F	SAX835	03/31/2021	03/31/2023
---	60-90 GHz Spectrum Analyzer Extension Module	Virginia Diodes, Inc.	VDIWR12.0S AX-F	SAX836	04/12/2021	04/12/2023
---	90-140 GHz Spectrum Analyzer Extension Module	Virginia Diodes, Inc.	VDIWR8.0SA X-F	SAX837	06/11/2021	06/11/2023
---	140-220 GHz Spectrum Analyzer Extension Module	Virginia Diodes, Inc.	VDIWR5.1SA X-F	SAX838	05/11/2021	05/11/2023

Test equipment used in September

Asset	Description	Manufacturer	Model	Serial	Cal Date	Cal Due
DAV007	Weather Station Vantage Vue	Davis	6250	MS1912120 03	03/20/2021	03/20/2022
145108'	EMI Test Receiver (20Hz - 40GHz)	Rohde & Schwarz	ESIB40	100209	06/22/2021	06/22/2022
IW001'	2 meter cable	Insulated Wire	2801-NPS	001	10/07/2020	10/07/2021
145145'	Broadband Hybrid Antenna 30 MHz - 3 GHz	Sunol Sciences Corp.	JB3	A122313	06/09/2021	06/09/2022
HS002'	DC-18GHz cable 1.5M long	Huber & Suhner	SucoFlex 106A	HS002	11/25/2020	11/25/2021
PRE11'	50dB gain pre-amp	Pasternack	PRE11	PRE11	09/02/2021	09/02/2022
IW006'	DC-18GHz cable 8.4m long	Insulated Wire	2800-NPS	IW006	11/25/2020	11/25/2021
HS003'	10m under floor cable	Huber-Schuner	10m-1	HS003	02/17/2021	02/17/2022
IW001'	2 meter cable	Insulated Wire	2801-NPS	001	10/07/2020	10/07/2021
ETS005'	1-18GHz horn antenna	ETS-Lindgren	3117	00218279	09/28/2020	09/28/2021
IW002'	2 meter Armored cable	Insulated Wire	2800-NPS	002	09/23/2020	09/23/2021
IW003'	8.4 meter cable	Insulated Wire	2800-NPS	003	10/08/2020	10/08/2021
PRE12'	Pre-amplifier	Com Power	PAM-118A	18040117	12/07/2020	12/07/2021
145-414'	Cables 145-400 145-403 145-405 145-409	Huber + Suhner	3m Track A cables	multiple	07/09/2021	07/09/2022
145019'	Active Loop Antenna (9 KHz to 30 MHz)	EMCO	6502/1	9902-3267	02/17/2021	02/17/2022 2

Software Utilized:

Name	Manufacturer	Version
BAT-EMC	Nexio	3.18.0.16
EMI Boxborough.xls	Intertek	08/27/2010

8.4 Results:

The sample tested was found to Comply.

8.5 Setup Photographs:

Setup Photographs are included in a separate file.

8.6 Plots/Data:

9kHz-30 MHz Radiated Spurious Emissions

Company: Starry	Antenna & Cables: LF	Bands: N, LF, HF, SHF
Model #: Titan 24	Antenna: 145-019	145-019
Serial #: 2111000001	Cable(s): IW01, IW02, IW03	NONE.
Engineers: Vathana Ven	Location: 10m Chamber	Barometer: DAV007
Project #: G104689284	Date(s): 09/10/21	Filter: NONE
Standard: FCC Part 30, Subpart C	Temp/Humidity/Pressure: 23c	39% 1004mB
Receiver: R&S ESE (145-128) 06-22-2022	Limit Distance (m): 10	
PreAmp: PRE11	Test Distance (m): 10	
PreAmp Used? (Y or N): N	Voltage/Frequency: POE	Frequency Range: 9kHz-30MHz
Net = Reading (dBuV/m) + Antenna Factor (dB1/m) + Cable Loss (dB) - Preamp Factor (dB) - Distance Factor (dB)		
Peak: PK Quasi-Peak: QP Average: AVG RMS: RMS; NF = Noise Floor, RB = Restricted Band; Bandwidth denoted as RBW/VBW		

Detector Type	Ant. Pol. (V/H)	Frequency MHz	Reading dB(uV)	Antenna Factor dB(1/m)	Cable Loss dB	Pre-amp Factor dB	Distance Factor dB	EIRP Net dBm	EIRP Limit dBm	Margin dB	Bandwidth
Note: All channels, no emissions were detected above the measuring equipment noise floor, readings below were all for noise floor											
Note: EIRP Obtained by applying the path loss correction for a 3m test distance, E(dBuV/m)@10m - 84.7 = dBm EIRP											
PK	V	5.000	35.25	12.30	0.34	0.00	0.00	-36.81	-13.00	-23.81	1/3 MHz
PK	V	10.000	31.41	11.50	0.34	0.00	0.00	-41.45	-13.00	-28.45	1/3 MHz
PK	V	15.000	31.71	11.00	0.34	0.00	0.00	-41.65	-13.00	-28.65	1/3 MHz
PK	V	20.000	29.73	10.30	0.34	0.00	0.00	-44.33	-13.00	-31.33	1/3 MHz
PK	V	25.000	30.14	9.70	0.34	0.00	0.00	-44.52	-13.00	-31.52	1/3 MHz
PK	V	30.000	42.11	9.80	0.34	0.00	0.00	-32.45	-13.00	-19.45	1/3 MHz

Lower Band: Low Channel 24.34 GHz, 160 MHz Bandwidth, MCS0 Modulation, 30-1000 MHz

Radiated Spurious Emissions, Tx at Low Channel 24.34GHz

Company: Starry	Antenna & Cables: N	Bands: N, LF, HF, SHF
Model #: Titan 24	Antenna: 145-145	145-145
Serial #: 2111000001	Cable(s): IW01, HS002, HS003, 145-422	NONE.
Engineers: kouma Sinn	Location: 10m Chamber	Barometer: DAV007
Project #: G104689284	Date(s): 09/20/21	Filter: NONE
Standard: FCC Part 30, Subpart C	Temp/Humidity/Pressure: 22 C	48% 1019 mbar
Receiver: R&S ESE (145-128) 06-22-2022	Limit Distance (m): 10	
PreAmp: PRE11	Test Distance (m): 10	
PreAmp Used? (Y or N): Y	Voltage/Frequency: POE	Frequency Range: 30MHz - 1GHz
Net = Reading (dBuV/m) + Antenna Factor (dB1/m) + Cable Loss (dB) - Preamp Factor (dB) - Distance Factor (dB)		
Peak: PK Quasi-Peak: QP Average: AVG RMS: RMS; NF = Noise Floor, RB = Restricted Band; Bandwidth denoted as RBW/VBW		

Detector Type	Ant. Pol. (V/H)	Frequency MHz	Reading dB(uV)	Antenna Factor dB(1/m)	Cable Loss dB	Pre-amp Factor dB	Correction Factor dB	EIRP Net dBm	EIRP Limit dBm	Margin dB	Bandwidth
Note: Low CH 24.34GHz (Lower band)_Tx mode_MCS0_Path 3_160MHz BW_Att 12											
Note: EIRP Obtained by applying the path loss correction for a 10m test distance, E(dBuV/m)@10m - 84.7 = dBm EIRP											
PK	V	31.421	60.17	---	---	---	13.38	-37.91	-13.00	-24.91	1/3 MHz
PK	V	46.731	70.88	---	---	---	23.89	-37.71	-13.00	-24.71	1/3 MHz
PK	V	55.000	69.43	---	---	---	25.78	-41.05	-13.00	-28.05	1/3 MHz
PK	V	67.425	68.98	---	---	---	24.95	-40.67	-13.00	-27.67	1/3 MHz
PK	V	79.968	66.43	---	---	---	25.54	-43.81	-13.00	-30.81	1/3 MHz
PK	V	137.327	65.39	---	---	---	19.03	-38.34	-13.00	-25.34	1/3 MHz
PK	V	183.116	63.10	---	---	---	21.20	-42.80	-13.00	-29.80	1/3 MHz
PK	V	339.375	61.96	---	---	---	17.44	-40.18	-13.00	-27.18	1/3 MHz
PK	H	784.653	40.30	---	---	---	8.87	-53.27	-13.00	-40.27	1/3 MHz

Note: Correction Factor (dB) = Antenna Factor (dB) + Cable Loss (dB) - Pre-Amp Factor (dB)
EIRP Reading = Reading (dBuV/m) - Correction Factor (dB) - 84.7

Upper Band: Low Channel 24.84 GHz, 160 MHz Bandwidth, MCS0 Modulation, 30-1000 MHz

30-1000 MHz Radiated Spurious Emissions, Tx at Low Channel 24.84GHz

Company: Starry	Antenna & Cables: N	Bands: N, LF, HF, SHF
Model #: Titan 24	Antenna: 145-145	145-145
Serial #: 2111000001	Cable(s): IW01, HS002, HS003, 145-422	NONE.
Engineers: Kouma Sinn	Location: 10m Chamber	Barometer: DAV007
Project #: G104689284	Date(s): 09/20/21	Filter: NONE
Standard: FCC Part 30, Subpart C	Temp/Humidity/Pressure: 22 C	48% 1019 mbar
Receiver: R&S ESE (145-128) 06-22-2022	Limit Distance (m): 10	
PreAmp: PRE11	Test Distance (m): 10	
PreAmp Used? (Y or N): Y	Voltage/Frequency: POE	Frequency Range: 30MHz - 1GHz
Net = Reading (dBuV/m) + Antenna Factor (dB1/m) + Cable Loss (dB) - Preamp Factor (dB) - Distance Factor (dB)		
Peak: PK Quasi-Peak: QP Average: AVG RMS: RMS; NF = Noise Floor, RB = Restricted Band; Bandwidth denoted as RBW/VBW		

Detector Type	Ant. Pol. (V/H)	Frequency MHz	Reading dB(uV)	Antenna Factor dB(1/m)	Cable Loss dB	Pre-amp Factor dB	Correction Factor dB	EIRP Net dBm	EIRP Limit dBm	Margin dB	Bandwidth
Note: EIRP Obtained by applying the path loss correction for a 10m test distance, E(dBuV/m)@10m - 84.7 = dBm EIRP											
PK	V	31.105	64.42	---	---	---	13.11	-33.39	-13.00	-20.39	1/3 MHz
PK	V	34.000	67.83	---	---	---	15.66	-32.53	-13.00	-19.53	1/3 MHz
PK	V	37.000	68.24	---	---	---	17.67	-34.13	-13.00	-21.13	1/3 MHz
PK	V	67.074	71.53	---	---	---	25.28	-38.45	-13.00	-25.45	1/3 MHz
PK	V	79.968	65.24	---	---	---	25.54	-45.00	-13.00	-32.00	1/3 MHz
PK	V	96.000	68.47	---	---	---	23.53	-39.76	-13.00	-26.76	1/3 MHz
PK	V	112.000	65.59	---	---	---	19.55	-38.66	-13.00	-25.66	1/3 MHz
PK	V	139.000	63.58	---	---	---	19.26	-40.38	-13.00	-27.38	1/3 MHz
PK	V	238.400	66.23	---	---	---	20.66	-39.13	-13.00	-26.13	1/3 MHz
PK	V	512.768	57.44	---	---	---	13.50	-40.76	-13.00	-27.76	1/3 MHz
PK	H	786.253	42.57	---	---	---	8.83	-50.96	-13.00	-37.96	1/3 MHz

Note: Correction Factor (dB) = Antenna Factor (dB) + Cable Loss (dB) - Pre-Amp Factor (dB)
EIRP Reading = Reading (dBuV/m) - Correction Factor (dB) - 84.7

Upper Band: Mid Channel 25.04 GHz, 160 MHz Bandwidth, MCS0 Modulation, 30-1000 MHz

Radiated Spurious Emissions, Tx at Mid Channel 25.04GHz

Company: Starry	Antenna & Cables: N	Bands: N, LF, HF, SHF
Model #: Titan 24	Antenna: 145-145	145-145
Serial #: 2111000001	Cable(s): IW01, HS002, HS003, 145-422	NONE.
Engineers: Kouma Sinn	Location: 10m Chamber	Barometer: DAV007
Project #: G104689284	Date(s): 09/20/21	Filter: NONE
Standard: FCC Part 30, Subpart C	Temp/Humidity/Pressure: 22 C	48% 1019 mbar
Receiver: R&S ESE (145-128) 06-22-2022	Limit Distance (m): 10	
PreAmp: PRE11	Test Distance (m): 10	
PreAmp Used? (Y or N): Y	Voltage/Frequency: POE	Frequency Range: 30MHz - 1GHz
Net = Reading (dBuV/m) + Antenna Factor (dB1/m) + Cable Loss (dB) - Preamp Factor (dB) - Distance Factor (dB)		
Peak: PK Quasi-Peak: QP Average: AVG RMS: RMS; NF = Noise Floor, RB = Restricted Band; Bandwidth denoted as RBW/VBW		

Detector Type	Ant. Pol. (V/H)	Frequency MHz	Reading dB(uV)	Antenna Factor dB(1/m)	Cable Loss dB	Pre-amp Factor dB	Correction Factor dB	EIRP Net dBm	EIRP Limit dBm	Margin dB	Bandwidth
Note: Mid CH 25.04GHz (Upper band)_Tx mode_MCS0_Path 3_160MHz BW_Att8											
Note: EIRP Obtained by applying the path loss correction for a 10m test distance, E(dBuV/m)@10m - 84.7 = dBm EIRP											
PK	V	30.989	61.28	---	---	---	13.02	-36.44	-13.00	-23.44	1/3 MHz
PK	V	34.000	68.89	---	---	---	15.66	-31.47	-13.00	-18.47	1/3 MHz
PK	V	37.000	68.89	---	---	---	17.67	-33.48	-13.00	-20.48	1/3 MHz
PK	V	67.084	73.50	---	---	---	25.27	-36.47	-13.00	-23.47	1/3 MHz
PK	V	79.968	66.71	---	---	---	25.54	-43.53	-13.00	-30.53	1/3 MHz
PK	V	96.000	69.99	---	---	---	23.53	-38.24	-13.00	-25.24	1/3 MHz
PK	V	158.000	63.31	---	---	---	19.82	-41.21	-13.00	-28.21	1/3 MHz
PK	V	239.916	58.61	---	---	---	20.59	-46.68	-13.00	-33.68	1/3 MHz
PK	V	515.663	58.21	---	---	---	13.39	-39.88	-13.00	-26.88	1/3 MHz
PK	H	785.726	42.11	---	---	---	8.86	-51.45	-13.00	-38.45	1/3 MHz

Note: Correction Factor (dB) = Antenna Factor (dB) + Cable Loss (dB) - Pre-Amp Factor (dB)
EIRP Reading = Reading (dBuV/m) - Correction Factor (dB) - 84.7

Upper Band: High Channel 25.16GHz, 160 MHz Bandwidth, MCS0 Modulation, 30-1000 MHz

Radiated Spurious Emissions, Tx at 25.16GHz

Company: Starry	Antenna & Cables: N	Bands: N, LF, HF, SHF
Model #: Titan 24	Antenna: 145-145	145-145
Serial #: 2111000001	Cable(s): IW01, HS002, HS003, 145-422	NONE.
Engineers: Kouma Sinn	Location: 10m Chamber	Barometer: DAV007
Project #: G104689284	Date(s): 09/20/21	Filter: NONE
Standard: FCC Part 30, Subpart C	Temp/Humidity/Pressure: 22 C	48% 1019 mbar
Receiver: R&S ESE (145-128) 06-22-2022	Limit Distance (m): 10	
PreAmp: PRE11	Test Distance (m): 10	
PreAmp Used? (Y or N): Y	Voltage/Frequency: POE	Frequency Range: 30MHz - 1GHz
Net = Reading (dBuV/m) + Antenna Factor (dB1/m) + Cable Loss (dB) - Preamp Factor (dB) - Distance Factor (dB)		
Peak: PK Quasi-Peak: QP Average: AVG RMS: RMS; NF = Noise Floor, RB = Restricted Band; Bandwidth denoted as RBW/VBW		

Detector Type	Ant. Pol. (V/H)	Frequency MHz	Reading dB(uV)	Antenna Factor dB(1/m)	Cable Loss dB	Pre-amp Factor dB	Correction Factor dB	EIRP Net dBm	EIRP Limit dBm	Margin dB	Bandwidth
Note: High CH 25.16GHz (Upper band)_Tx mode_MCS0_Path 3_160MHz BW_Att10											
Note: EIRP Obtained by applying the path loss correction for a 10m test distance, E(dBuV/m)@10m - 84.7 = dBm EIRP											
PK	V	31.305	63.05	---	---	---	13.28	-34.93	-13.00	-21.93	1/3 MHz
PK	V	34.000	68.08	---	---	---	15.66	-32.28	-13.00	-19.28	1/3 MHz
PK	V	37.000	69.02	---	---	---	17.67	-33.35	-13.00	-20.35	1/3 MHz
PK	V	67.168	73.91	---	---	---	25.26	-36.05	-13.00	-23.05	1/3 MHz
PK	V	79.968	65.14	---	---	---	25.54	-45.10	-13.00	-32.10	1/3 MHz
PK	V	96.000	67.56	---	---	---	23.53	-40.67	-13.00	-27.67	1/3 MHz
PK	V	230.326	61.67	---	---	---	21.10	-44.13	-13.00	-31.13	1/3 MHz
PK	V	516.474	57.53	---	---	---	13.39	-40.56	-13.00	-27.56	1/3 MHz
PK	H	842.568	40.41	---	---	---	7.56	-51.85	-13.00	-38.85	1/3 MHz

Note: Correction Factor (dB) = Antenna Factor (dB) + Cable Loss (dB) - Pre-Amp Factor (dB)
EIRP Reading = Reading (dBuV/m) - Correction Factor (dB) - 84.7

Lower Band: Low Channel 24.34 GHz, 160 MHz Bandwidth, MCS0 Modulation, 1-18GHz

Test Information:

Date and Time	6/15/2021 6:56:37 PM
Client and Project Number	Starry_G104689248
Engineer	Vathana Ven
Temperature	24 deg C
Humidity	35%
Atmospheric Pressure	1008 mB
Comments	RE 1 to 13 GHz_Tantin 24_Low CH 24.34 GHz (Low band)_Tx mode_160MHz BW_MCS0

Graph:

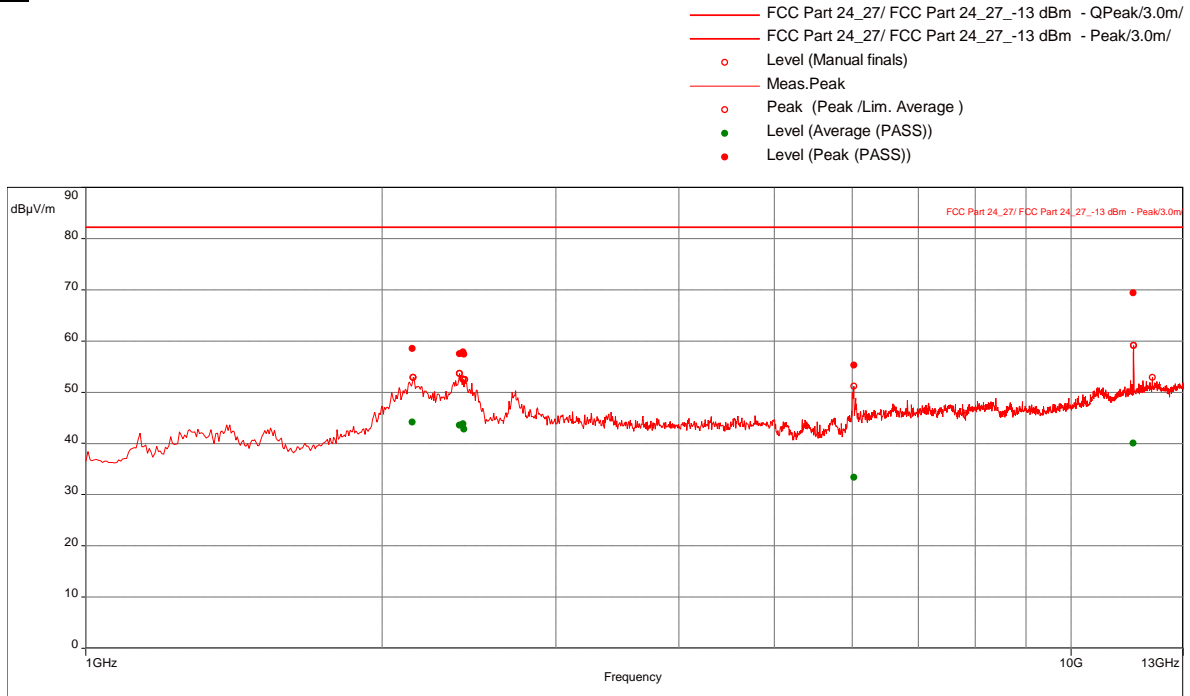

Results:

Peak (PASS) (6)

Frequency (MHz)	Level (dBµV/m)	Level (EIRP) (dBm)	Limit EIRP (dBm)	Margin (dB)	Azimuth (°)	Height (m)	Pol.	RBW (Hz)	Correction (dB)
2146.842105	58.49	-36.77	-13.0	-23.77	17.00	2.40	Horizontal	1000000.00	-16.52
2393.947368	57.46	-37.80	-13.0	-24.80	25.00	2.85	Horizontal	1000000.00	-15.53
2414.736842	57.85	-37.41	-13.0	-24.41	32.00	2.05	Horizontal	1000000.00	-15.39
2421.315789	57.38	-37.88	-13.0	-24.88	39.00	2.10	Horizontal	1000000.00	-15.34
6018.947368	55.32	-39.94	-13.0	-26.94	347.00	1.50	Horizontal	1000000.00	-8.12
11576.05263	69.43	-25.83	-13.0	-12.83	9.00	3.15	Horizontal	1000000.00	0.10

EIRP (dBm) = E (dBµ/m) + 20 * LOG (D) ; where D is the measurement distance (in the far field region) in m.

Peak (EIRP) = Peak (dBµ/m) – 95.20, where D = 3m

Scan from 13-18 GHz was performed manually and no emissions were detected above the measuring equipment noise floor.

Lower Band: Mid Channel 24.35 GHz, 160 MHz Bandwidth, MCS0 Modulation, 1-18 GHz

Test Information:

Date and Time	6/15/2021 7:01:09 PM
Client and Project Number	Starry_G104689248
Engineer	Vathana Ven
Temperature	24 deg C
Humidity	35%
Atmospheric Pressure	1008 mB
Comments	RE 1 to 13 GHz_Tantin 24_Mid CH 24.35 GHz (Low band)_Tx mode_160MHz BW_MCS0

Graph:

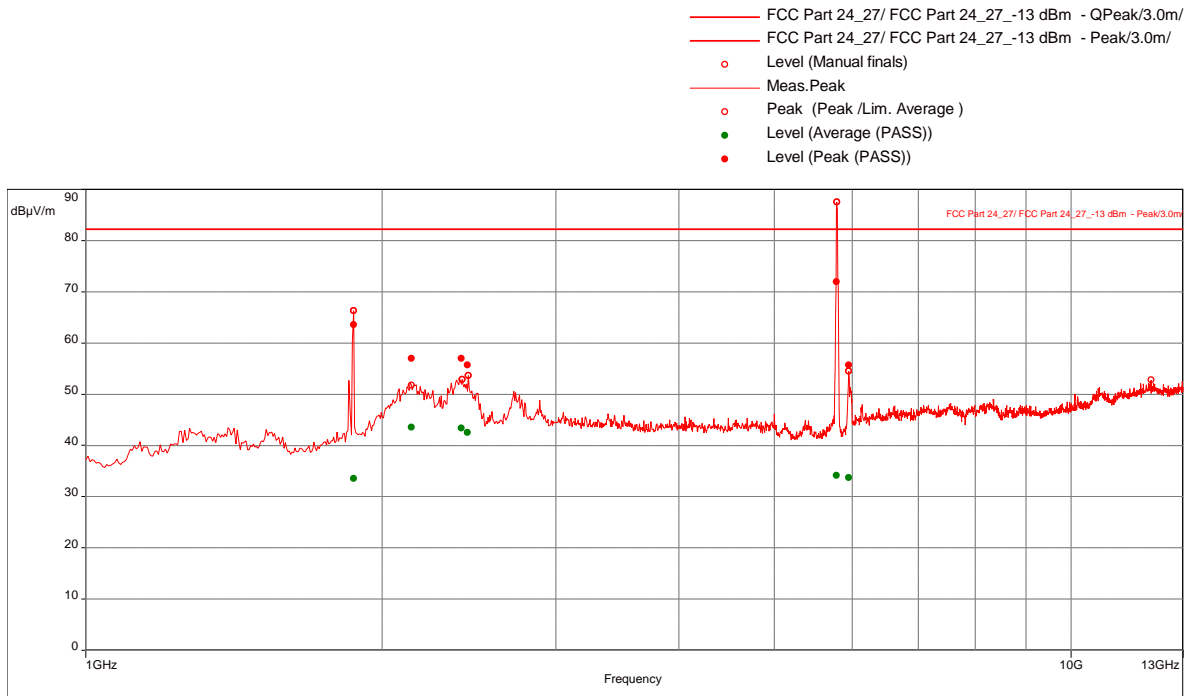

Results:

Peak (PASS) (6)

Frequency (MHz)	Level (dBµV/m)	Level (EIRP) (dBm)	Limit EIRP (dBm)	Margin (dB)	Azimuth (°)	Height (m)	Pol.	RBW (Hz)	Correction (dB)
1868.157895	63.59	-31.67	-13.0	-18.67	33.00	1.45	Vertical	1000000.00	-17.17
2138.684211	57.00	-38.26	-13.0	-25.26	16.00	2.10	Horizontal	1000000.00	-16.53
2406.578947	56.98	-39.28	-13.0	-25.28	39.00	2.05	Horizontal	1000000.00	-15.45
2441.052632	55.73	-39.53	-13.0	-26.53	39.00	2.10	Horizontal	1000000.00	-15.19
5781.842105	71.98	-23.28	-13.0	-10.28	0.00	1.10	Vertical	1000000.00	-8.78
5950	55.66	-39.60	-13.0	-26.60	333.00	1.85	Horizontal	1000000.00	-8.31

EIRP (dBm) = E (dBµ/m) + 20 * LOG (D) ; where D is the measurement distance (in the far field region) in m.

Peak (EIRP) = Peak (dBµ/m) – 95.20, where D = 3m

Scan from 13-18 GHz was performed manually and no emissions were detected above the measuring equipment noise floor.

Lower Band: High Channel 24.36 GHz, 160 MHz Bandwidth, MCS0 Modulation, 1-18 GHz

Test Information:

Date and Time	6/15/2021 7:37:53 PM
Client and Project Number	Starry_G104689248
Engineer	Vathana Ven
Temperature	24 deg C
Humidity	35%
Atmospheric Pressure	1008 mB
Comments	RE 1 to 13 GHz_Tantin 24_High CH 24.36 GHz (Low band)_Tx mode_160MHz BW_MCS0

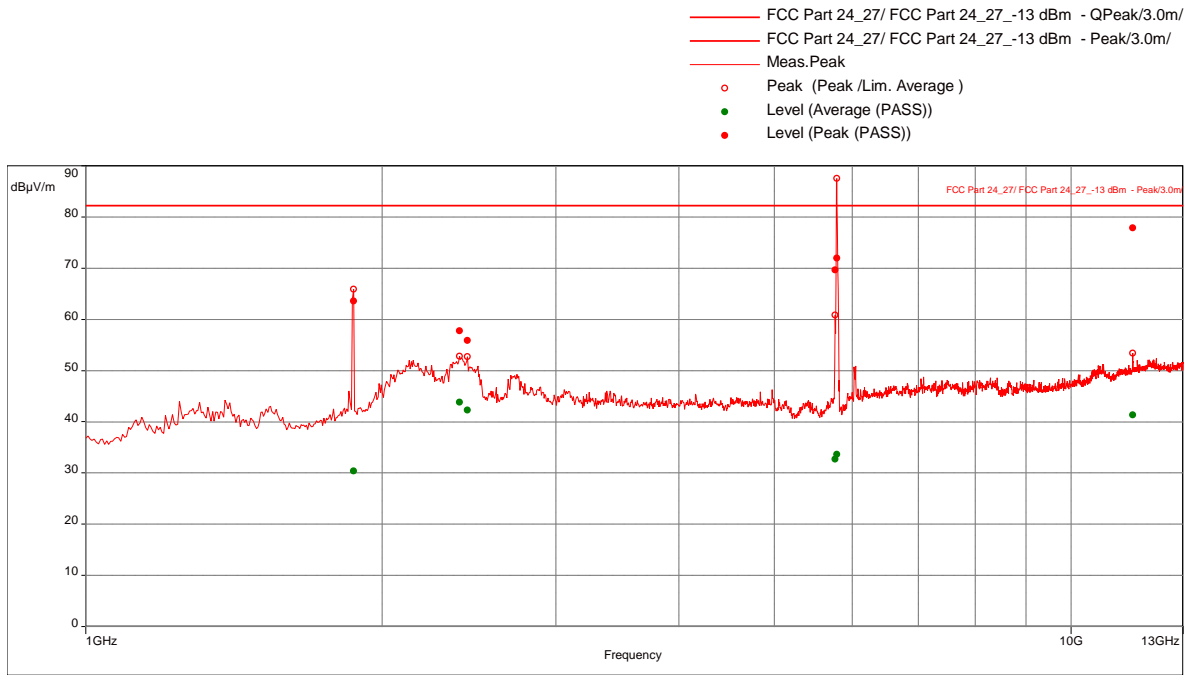
Graph:

Results:

Peak (PASS) (6)

Frequency (MHz)	Level (dBµV/m)	Level (EIRP) (dBm)	Limit EIRP (dBm)	Margin (dB)	Azimuth (°)	Height (m)	Pol.	RBW (Hz)	Correction (dB)
1867.894737	63.59	-31.67	-13.0	-18.67	91.00	1.01	Vertical	1000000.00	-17.17
2397.105263	57.72	-37.54	-13.0	-24.54	25.00	2.76	Horizontal	1000000.00	-15.51
2437.894737	55.86	-39.40	-13.0	-26.40	39.00	2.35	Horizontal	1000000.00	-15.21
5765	69.68	-25.58	-13.0	-12.58	1.00	2.40	Vertical	1000000.00	-8.84
5783.684211	71.99	-23.27	-13.0	-10.27	0.00	1.45	Vertical	1000000.00	-8.77
11556.05263	77.85	-17.41	-13.0	-4.41	0.00	2.00	Horizontal	1000000.00	0.04

EIRP (dBm) = E (dBµ/m) + 20 * LOG (D) ; where D is the measurement distance (in the far field region) in m.

Peak (EIRP) = Peak (dBµ/m) – 95.20, where D = 3m

Scan from 13-18 GHz was performed manually and no emissions were detected above the measuring equipment noise floor.

Upper Band: Low Channel 24.84 GHz, 160 MHz Bandwidth, MCS0 Modulation, 1-18 GHz

Test Information:

Date and Time	6/15/2021 8:14:32 PM
Client and Project Number	Starry_G104689248
Engineer	Vathana Ven
Temperature	24 deg C
Humidity	35%
Atmospheric Pressure	1008 mB
Comments	RE 1 to 13 GHz_Tantin 24_Low CH 24.84GHz (upper band)_Tx mode_160MHz BW_MCS0

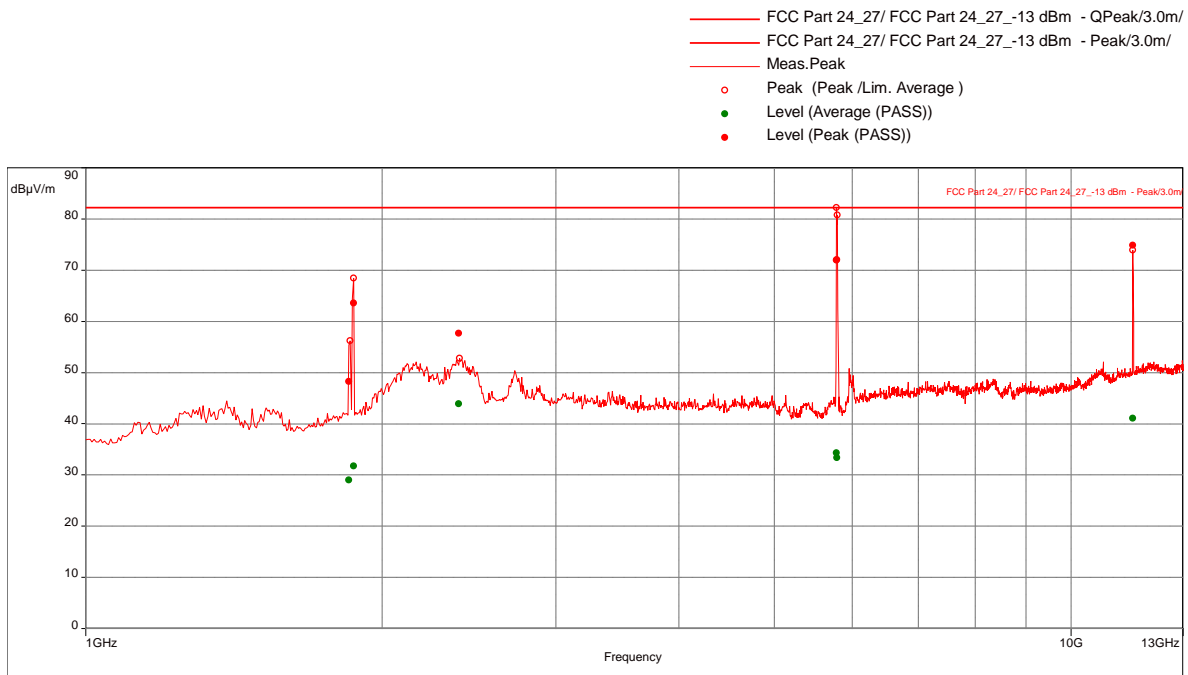
Graph:

Results:

Peak (PASS) (6)

Frequency (MHz)	Level (dBµV/m)	Level (EIRP) (dBm)	Limit EIRP (dBm)	Margin (dB)	Azimuth (°) (dB)	Height (m) (dB)	Pol. (dB)	RBW (dB)	Correction (dB)
1851.315789	48.22	-47.04	-13.0	-34.04	341.00	3.39	Horizontal	1000000.00	-17.22
1868.421053	63.59	-31.67	-13.0	-18.67	129.00	1.20	Vertical	1000000.00	-17.17
2392.105263	57.69	-37.57	-13.0	-24.57	32.00	2.45	Horizontal	1000000.00	-15.54
5777.631579	71.97	-23.29	-13.0	-10.29	0.00	1.00	Horizontal	1000000.00	-8.79
5792.368421	72.02	-23.24	-13.0	-10.24	1.00	1.00	Horizontal	1000000.00	-8.74
11558.68421	74.84	-20.42	-13.0	-7.42	2.00	3.44	Vertical	1000000.00	0.05

EIRP (dBm) = E (dBµV/m) + 20 * LOG (D) – 104.7; where D is the measurement distance (in the far field region) in m.

Peak (EIRP) = Peak (dBµV/m) – 95.20, where D = 3m

Scan from 13-18 GHz was performed manually and no emissions were detected above the measuring equipment noise floor.

Upper Band: Mid Channel 25.04 GHz, 160 MHz Bandwidth, MCS0 Modulation, 1-18 GHz

Test Information:

Date and Time	6/15/2021 8:48:17 PM
Client and Project Number	Starry_G104689248
Engineer	Vathana Ven
Temperature	24 deg C
Humidity	35%
Atmospheric Pressure	1008 mB
Comments	RE 1 to 13 GHz_Tantin 24_Mid CH 25.04GHz (upper band)_Tx mode_160MHz BW_MCS0

Graph:

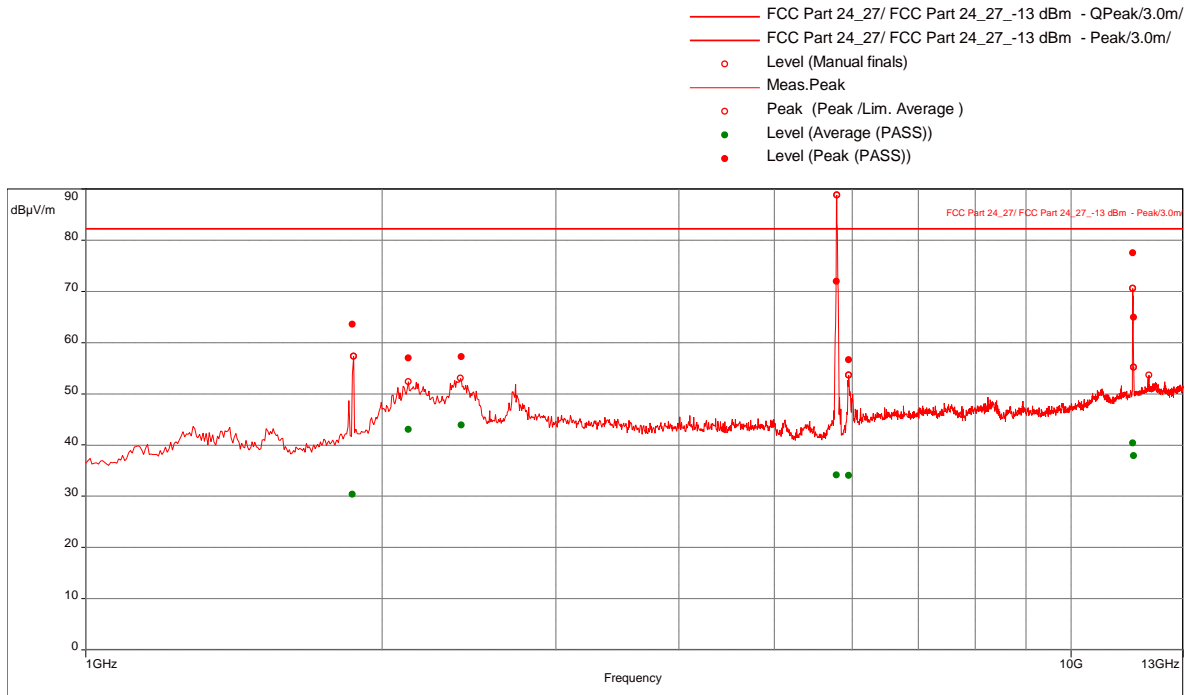

Results:

Peak (PASS) (7)

Frequency (MHz)	Level (dBµV/m)	Level (EIRP) (dBm)	Limit EIRP (dBm)	Margin (dB)	Azimuth (°)	Height (m)	Pol.	RBW (Hz)	Correction (dB)
1867.368421	63.59	-31.67	-13.0	-18.67	9.00	2.80	Vertical	1000000.00	-17.17
2122.894737	56.99	-38.27	-13.0	-25.27	9.00	2.50	Horizontal	1000000.00	-16.55
2403.947368	57.25	-38.01	-13.0	-25.01	38.00	2.10	Horizontal	1000000.00	-15.47
5782.368421	71.99	-23.27	-13.0	-10.27	0.00	1.20	Vertical	1000000.00	-8.78
5948.157895	56.61	-38.65	-13.0	-25.65	3.00	1.80	Vertical	1000000.00	-8.31
11556.57895	77.55	-17.71	-13.0	-4.71	0.00	1.30	Vertical	1000000.00	0.04
11583.42105	64.91	-30.35	-13.0	-17.35	46.00	2.50	Vertical	1000000.00	0.13

EIRP (dBm) = E (dBµ/m) + 20 * LOG (D) ; where D is the measurement distance (in the far field region) in m.

Peak (EIRP) = Peak (dBµ/m) – 95.20, where D = 3m

Scan from 13-18 GHz was performed manually and no emissions were detected above the measuring equipment noise floor.

Upper Band: High Channel 25.16 GHz, 160 MHz Bandwidth, MCS0 Modulation, 1-18 GHz

Test Information:

Date and Time	6/15/2021 9:24:42 PM
Client and Project Number	Starry_G104689248
Engineer	Vathana Ven
Temperature	24 deg C
Humidity	35%
Atmospheric Pressure	1008 mB
Comments	RE 1 to 13 GHz_Tantin 24_High CH 25.16GHz (upper band)_Tx mode_160MHz BW_MCS0

Graph:

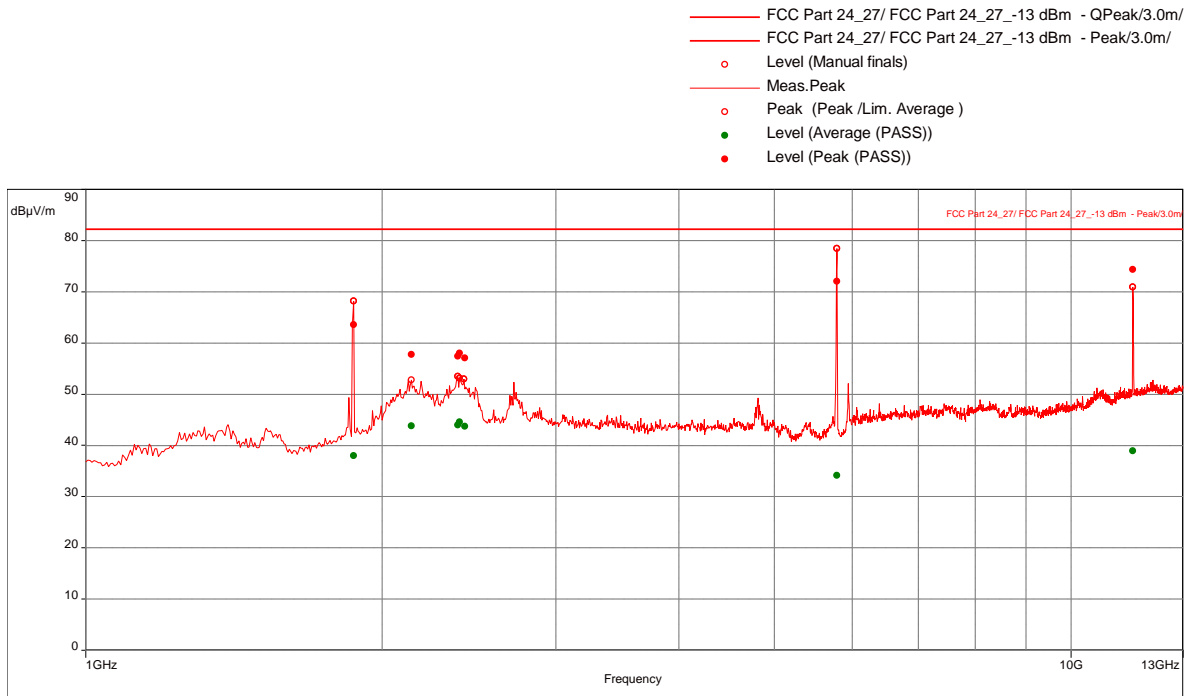

Results:

Peak (PASS) (7)

Frequency (MHz)	Level (dBµV/m)	Level (EIRP) (dBm)	Limit EIRP (dBm)	Margin (dB)	Azimuth (°)	Height (m)	Pol.	RBW (Hz)	Correction (dB)
1868.421053	63.59	-31.67	-13.0	-18.67	188.00	2.70	Vertical	1000000.00	-17.17
2140.789474	57.75	-24.51	-13.0	-24.51	11.00	2.40	Horizontal	1000000.00	-16.53
2386.052632	57.41	-24.85	-13.0	-24.85	24.00	2.85	Horizontal	1000000.00	-15.57
2396.052632	58.02	-24.24	-13.0	-24.24	24.00	2.40	Horizontal	1000000.00	-15.52
2422.894737	57.11	-25.15	-13.0	-25.15	32.00	2.40	Horizontal	1000000.00	-15.32
5786.052632	72.00	-10.26	-13.0	-10.26	0.00	2.00	Vertical	1000000.00	-8.77
11559.73684	74.33	-7.93	-13.0	-7.93	342.00	1.01	Horizontal	1000000.00	0.05

EIRP (dBm) = E (dBµ/m) + 20 * LOG (D) ; where D is the measurement distance (in the far field region) in m.

Peak (EIRP) = Peak (dBµ/m) – 95.20, where D = 3m

Scan from 13-18 GHz was performed manually and no emissions were detected above the measuring equipment noise floor.

Lower and Upper Bands at Low, Mid, and High channels: 160 MHz Bandwidth, MCS0 Modulation, 18-40 GHz

18-40 GHz Spurious Emissions

Company: Starry
 Model #: S01411
 Serial #: 2111000001
 Engineers: Vathana Ven
 Project #: G104689284
 Standard: FCC Part 30
 Receiver: ROS005-1_10-27-2021
 PreAmp: PRE8 Data 11-25-2021.txt
 PreAmp Used? (Y or N): Y
 Antenna & Cables: HF Bands: N, LF, HF, SHF
 Antenna: EMC04_3M-Vert__01-28-2022.txt EMC04_3M-Hor__01-28-2022.txt
 Cable(s): CBLHF2012-5M-Z_02-19-2022 cable factors.txt
 Location: 10m Ch. Barometer: DAV007 Filter: NONE
 Date(s): 06/11/21
 Temp/Humidity/Pressure: 24 deg C 38% 1004mbar
 Limit Distance (m): 3
 Test Distance (m): 3
 Voltage/Frequency: POE Frequency Range: 18-40GHz
 Net = Reading (dBuV/m) + Antenna Factor (dB1/m) + Cable Loss (dB) - Preamp Factor (dB) - Distance Factor (dB)

Peak: PK Quasi-Peak: QP Average: AVG RMS: RMS; NF = Noise Floor, RB = Restricted Band; Bandwidth denoted as RBW/VBW

Detector Type	Ant. Pol. (V/H)	Frequency MHz	Reading dB(uV)	Antenna Factor dB(1/m)	Cable Loss dB	Pre-amp Factor dB	Distance Factor dB	Net dB(m)	Limit dB(m)	Margin dB	Bandwidth
BW=160MHz, MCS0, Path 3, Tx @ Low, Mid, High Ch											
Low, Mid, High Channels 18-40GHz, no emissions were detected above the measuring equipment noise floor.											

Lower and Upper Bands at Low, Mid, and High channels: 160 MHz Bandwidth, MCS0 Modulation, 40-60 GHz

40-60 GHz Spurious Emissions

Company: Starry	Antenna & Cables: N	Bands: N, LF, HF, SHF
Model #: S01411	Antenna: WR19	NONE.
Serial #: 2111000001	Cable(s): CBLHF2012-5M-2	NONE.
Engineers: Vathana Ven	Location: 10m chamber	Barometer: DAV007
Project #: G104723800	Date(s): 06/17/21	Filter: NONE
Standard: FCC Part 30	Temp/Humidity/Pressure: 26 deg C	31% 1003 mB

Receiver: ROS005-1 (10-27-2021)	Limit Distance (m): 3
PreAmp: None	Test Distance (m): 3
PreAmp Used? (Y or N): N	Voltage/Frequency: 120VAC 60Hz
	Frequency Range: 40-60GHz
Net = Reading (dBuV/m) + Antenna Factor (dB1/m) + Cable Loss (dB) - Preamp Factor (dB) - Distance Factor (dB)	

Peak: PK Quasi-Peak: QP Average: AVG RMS: RMS; NF = Noise Floor, RB = Restricted Band; Bandwidth denoted as RBW/BW

Detector Type	Ant. Pol. (V/H)	Frequency GHz	Reading dB(uV)	Antenna Factor dB(1/m)	Cable Loss dB	Pre-amp Factor dB	Distance Factor dB	Net dB(uV/m)	Limit dB(uV/m)	Margin dB	Bandwidth	
Note: 40-60 GHz range using WR19, Tx mode, Low CH 24.34GHz (Lower band), MCS0 160MHz BW												
EIRP (dBm) = E (dBu/m) + 20 * LOG (D) – 104.7 ; where D is the measurement distance (in the far field region) in m												
PK	V	48680.000	16.49	41.43	2.96	0.00	0.00	-34.28	-13.00	-21.28	1/3 MHz	Noise floor
PK	H	60000.000	29.01	43.25	2.96	0.00	0.00	-19.94	-13.00	-6.94	1/3 MHz	RB
Note: 40-60 GHz range using WR19, Tx mode, Mid CH 24.35GHz (Lower band), MCS0 160MHz BW												
EIRP (dBm) = E (dBu/m) + 20 * LOG (D) – 104.7 ; where D is the measurement distance (in the far field region) in m												
PK	V	48700.000	16.67	41.43	2.96	0.00	0.00	-34.10	-13.00	-21.10	1/3 MHz	Noise floor
PK	H	60000.000	29.29	43.25	2.96	0.00	0.00	-19.66	-13.00	-6.66	1/3 MHz	
Note: 40-60 GHz range using WR19, Tx mode, High CH 24.36GHz (Lower band), MCS0 160MHz BW												
EIRP (dBm) = E (dBu/m) + 20 * LOG (D) – 104.7 ; where D is the measurement distance (in the far field region) in m												
PK	V	48720.000	16.72	41.44	2.96	0.00	0.00	-34.04	-13.00	-21.04	1/3 MHz	Noise floor
PK	H	60000.000	28.45	43.25	2.96	0.00	0.00	-20.50	-13.00	-7.50	1/3 MHz	
Note: 40-60 GHz range using WR19, Tx mode, Low CH 24.84GHz (Upper band), MCS0 160MHz BW												
EIRP (dBm) = E (dBu/m) + 20 * LOG (D) – 104.7 ; where D is the measurement distance (in the far field region) in m												
PK	V	49480.000	17.31	41.61	2.96	0.00	0.00	-33.28	-13.00	-20.28	1/3 MHz	Noise floor
PK	H	60000.000	29.60	43.25	2.96	0.00	0.00	-19.35	-13.00	-6.35	1/3 MHz	RB
Note: 40-60 GHz range using WR19, Tx mode, Mid CH 25.04GHz (Lower band), MCS0 160MHz BW												
EIRP (dBm) = E (dBu/m) + 20 * LOG (D) – 104.7 ; where D is the measurement distance (in the far field region) in m												
PK	V	50080.000	17.29	41.68	2.96	0.00	0.00	-33.23	-13.00	-20.23	1/3 MHz	Noise floor
PK	H	60000.000	28.69	43.25	2.96	0.00	0.00	-20.26	-13.00	-7.26	1/3 MHz	
Note: 40-60 GHz range using WR19, Tx mode, High CH 25.34GHz (Lower band), MCS0 160MHz BW												
EIRP (dBm) = E (dBu/m) + 20 * LOG (D) – 104.7 ; where D is the measurement distance (in the far field region) in m												
PK	V	50320.000	17.34	41.72	2.96	0.00	0.00	-33.14	-13.00	-20.14	1/3 MHz	Noise floor
PK	H	60000.000	28.42	43.25	2.96	0.00	0.00	-20.53	-13.00	-7.53	1/3 MHz	

Lower and Upper Bands at Low, Mid, and High channels: 160 MHz Bandwidth, MCS0 Modulation, 60-100 GHz

60-100 GHz Radiated Emissions

Company: Starry
 Model #: S01411
 Serial #: 2111000001
 Engineers: Kouma Sinn
 Project #: G104723800
 Standard: FCC Part 30
 Receiver: ROS005-1 (10-27-2021)
 PreAmp: None
 PreAmp Used? (Y or N): N
 Antenna & Cables: N
 Antenna: WR19
 Cable(s): CBLHF2012-5M-2
 Location: 10m chamber
 Barometer: DAV007
 Filter: NONE
 Temp/Humidity/Pressure: 23 C 32% 1005 mbar
 Limit Distance (m): 3
 Test Distance (m): 3
 Voltage/Frequency: 120VAC 60Hz
 Frequency Range: 60-100 GHz
 Net = Reading (dBuV/m) + Antenna Factor (dB1/m) + Cable Loss (dB) - Preamp Factor (dB) - Distance Factor (dB)

Peak: PK Quasi-Peak: QP Average: AVG RMS: RMS; NF = Noise Floor, RB = Restricted Band; Bandwidth denoted as RBW/VBW

Detector Type	Ant. Pol. (V/H)	Frequency GHz	Reading dB(uV)	Antenna Factor dB(1/m)	Cable Loss dB	Pre-amp Factor dB	Distance Factor dB	Net dB(uV/m)	Limit dB(uV/m)	Margin dB	Bandwidth	FCC
06/18/2021, 23C/32%/1005mbar - Titan24, 60-90 GHz range using WR12, MCS0 160MHz BW {Lower Band}												
EIRP (dBm) = E (dBu/m) + 20 * LOG (D) - 104.7 ; where D is the measurement distance (in the far field region) in m												
Low Channel, 24.34 GHz - No emission was detected at 3m. Reading at 3rd harmonic below is noise floor reading												
PK	V	73020.000	18.98	44.95	2.96	0.00	0.00	-28.27	-13.00	-15.27	1/3 MHz	NF
PK	H	73020.000	18.90	44.95	2.96	0.00	0.00	-28.35	-13.00	-15.35	1/3 MHz	NF
Mid Channel, 24.35 GHz - No emission was detected at 3m. Reading at 3rd harmonic below is noise floor reading												
PK	V	73050.000	19.55	44.96	2.96	0.00	0.00	-27.69	-13.00	-14.69	1/3 MHz	NF
PK	H	73050.000	19.43	44.96	2.96	0.00	0.00	-27.81	-13.00	-14.81	1/3 MHz	NF
High Channel, 24.36 GHz - No emission was detected at 3m. Reading at 3rd harmonic below is noise floor reading												
PK	V	73080.000	19.26	44.96	2.96	0.00	0.00	-27.98	-13.00	-14.98	1/3 MHz	
PK	H	73080.000	19.95	44.96	2.96	0.00	0.00	-27.29	-13.00	-14.29	1/3 MHz	
Titan24, 60-90 GHz range using WR12, MCS0 160MHz BW {Upper Band}												
Low Channel, 24.84 GHz - No emission was detected at 3m. Reading at 3rd harmonic below is noise floor reading												
PK	V	74520.000	19.13	45.13	2.96	0.00	0.00	-27.94	-13.00	-14.94	1/3 MHz	NF
PK	H	74520.000	18.98	45.13	2.96	0.00	0.00	-28.09	-13.00	-15.09	1/3 MHz	NF
Mid Channel, 25.04 GHz - No emission was detected at 3m. Reading at 3rd harmonic below is noise floor reading												
PK	V	75120.000	19.03	45.20	2.96	0.00	0.00	-27.97	-13.00	-14.97	1/3 MHz	NF
PK	H	75120.000	19.03	45.20	2.96	0.00	0.00	-27.97	-13.00	-14.97	1/3 MHz	NF
High Channel, 25.16 GHz - No emission was detected at 3m. Reading at 3rd harmonic below is noise floor reading												
PK	V	75480.000	18.34	45.24	2.96	0.00	0.00	-28.62	-13.00	-15.62	1/3 MHz	NF
PK	H	75480.000	19.07	45.24	2.96	0.00	0.00	-27.89	-13.00	-14.89	1/3 MHz	NF
06/18/2021, 23C/32%/1005mbar - Titan24, 90-100 GHz range using WR8, MCS0 160MHz BW {Lower Band}												
EIRP (dBm) = E (dBu/m) + 20 * LOG (D) - 104.7 ; where D is the measurement distance (in the far field region) in m												
Low Channel, 24.34 GHz - No emission was detected at 3m. Reading at 3rd harmonic below is noise floor reading												
PK	V	97360.000	20.27	47.45	2.96	0.00	0.00	-24.48	-13.00	-11.48	1/3 MHz	NF
PK	H	97360.000	19.68	47.45	2.96	0.00	0.00	-25.07	-13.00	-12.07	1/3 MHz	NF
Mid Channel, 24.35 GHz - No emission was detected at 3m. Reading at 3rd harmonic below is noise floor reading												
PK	V	97400.000	19.58	47.46	2.96	0.00	0.00	-25.16	-13.00	-12.16	1/3 MHz	NF
PK	H	97400.000	20.24	47.46	2.96	0.00	0.00	-24.50	-13.00	-11.50	1/3 MHz	NF
High Channel, 24.36 GHz - No emission was detected at 3m. Reading at 3rd harmonic below is noise floor reading												
PK	H	97440.000	19.70	47.46	2.96	0.00	0.00	-25.04	-13.00	-12.04	1/3 MHz	NF
PK	H	97440.000	19.21	47.46	2.96	0.00	0.00	-25.53	-13.00	-12.53	1/3 MHz	NF
06/18/2021, 23C/32%/1005mbar - Titan24, 90-100 GHz range using WR8, MCS0 160MHz BW {Upper Band}												
Low Channel, 24.84 GHz - No emission was detected at 3m. Reading at 3rd harmonic below is noise floor reading												
PK	V	99360.000	19.30	47.63	2.96	0.00	0.00	-25.27	-13.00	-12.27	1/3 MHz	NF
PK	H	99360.000	19.89	47.63	2.96	0.00	0.00	-24.68	-13.00	-11.68	1/3 MHz	NF
Mid Channel, 25.04 GHz - No emission was detected at 3m. Reading below is noise floor reading.												
PK	V	90125.000	23.30	46.78	2.96	0.00	0.00	-22.12	-13.00	-9.12	1/3 MHz	NF
PK	H	90125.000	23.09	46.78	2.96	0.00	0.00	-22.33	-13.00	-9.33	1/3 MHz	NF
High Channel, 25.16 GHz - No emission was detected at 3m. Reading below is noise floor reading.												
PK	V	91094.000	22.92	46.78	2.96	0.00	0.00	-22.50	-13.00	-9.50	1/3 MHz	NF
PK	H	91094.000	24.02	46.78	2.96	0.00	0.00	-21.40	-13.00	-8.40	1/3 MHz	NF

Intertek

Report Number: 104689284BOX-001

Issued: 08/02/2021
Last Revised: 10/12/2021

Test Personnel:	<u>Vathana F. Ven <i>VSV</i></u>	Test Date:	<u>06/11/2021, 06/15/2021, 06/16/2021, 09/10/2021</u>
	<u>Kouma Sinn <i>KPS</i></u>		<u>06/17/2021, 06/18/2021, 09/20/2021</u>
Supervising/Reviewing Engineer:			
(Where Applicable)	<u>N/A</u>		
Product Standard:	<u>FCC 47CFR Part 30 Subparts C</u>	Limit Applied:	<u>See Report Section 8.3</u>
Input Voltage:	<u>48 VDC Via External P/S</u>		
Pretest Verification w/ BB Source:	<u>Yes</u>	Ambient Temperature:	<u>24, 24, 26, 24, 23, 23, 22 °C</u>
		Relative Humidity:	<u>38, 35, 32, 35, 32, 39, 48 %</u>
		Atmospheric Pressure:	<u>1004, 1008, 999, 1004, 1005, 1004, 1019 mbars</u>

Deviations, Additions, or Exclusions: None

9 Occupied Bandwidths

9.1 Requirements

FCC §2.1049 Measurements required: Occupied bandwidth

The occupied bandwidth, that is the frequency bandwidth such that, below its lower and above its upper frequency limits, the mean powers radiated are each equal to 0.5 percent of the total mean power radiated by a given emission shall be measured...

9.2 Method

Tests are performed in accordance with KDB 842590 D01 v01r02 Subclause 4.3 and ANSI C63.26-2015 Subclause 5.4. The measurement was made on the maximum field strength in the same worst-case orientation as in Section 6.1 with the Spectrum Analyzer setting as specified in ANSI C63.26-2015 Subclause 5.4.

TEST SITE: 10m ALSE

The 10m ALSE is 13m (Length) x 21m (Depth) x 10m (Height) with the effective size in terms of space from the tips of the absorber is 12m (Length) x 20m (Depth) x 8.5m (Height). This chamber achieves broadband performance using a unique arrangement of hybrid and ferrite tile absorber. This chamber has a built in 3m diameter turntable (Embedded type). The metal structure of the table makes electrical connection around the entire circumference of the turntable to the ground plane with a metal brush type connection. The turntable is located on one end of the chamber and the antennas are mounted 3 and 10 meters away at the other end of the chamber on the adjustable an Antenna Mast. The antenna mast is a non-conductive bore sighted type with remote control of antenna height and polarization. The Antenna Mast and the turntable can be remotely controlled through the controller located in the adjacent Control room. A Styrofoam table 80 cm high is used for table-top equipment.

9.3 Test Equipment Used:

Asset	Description	Manufacturer	Model	Serial	Cal Date	Cal Due
DAV007'	Weather Station Vantage Vue	Davis	6250	MS191212003	03/20/2021	03/20/2022
EMC04'	ANTENNA, RIDGED GUIDE, 18-40 GHZ	EMCO	3116	2090	01/28/2021	01/28/2022
ROS005-1'	Signal and Spectrum Analyzer	R&S	FSW43	100646	10/27/2020	10/27/2021
CBLHF2012-5M-2'	5m 9kHz-40GHz Coaxial Cable - SET2	Huber & Suhner	SF102	252676002	02/19/2021	02/19/2022

Software Utilized:

Name	Manufacturer	Version
None	--	--

9.4 Results:

The sample tested was found to Comply. Occupied bandwidths are within the band.

Frequency (GHz)	Transmitting Polarity	Modulation	Bandwidth (MHz)	Transmitting Path	Occupied Bandwidth (MHz)
24.27	Vertical	MCS8	20	3	19.182
24.28	Vertical	MCS8	20	3	19.155
24.29	Vertical	MCS8	20	3	19.216
24.77	Vertical	MCS8	20	3	18.934
24.97	Vertical	MCS8	20	3	18.786
25.09	Vertical	MCS8	20	3	18.421
24.27	Horizontal	MCS8	20	3	18.743
24.28	Horizontal	MCS8	20	3	18.792
24.29	Horizontal	MCS8	20	3	18.598
24.77	Horizontal	MCS8	20	3	18.725
24.97	Horizontal	MCS8	20	3	18.815
25.09	Horizontal	MCS8	20	3	18.496
24.34	Vertical	MCS0	160	3	157.601
24.35	Vertical	MCS0	160	3	156.808
24.36	Vertical	MCS0	160	3	158.266
24.84	Vertical	MCS0	160	3	156.989
25.04	Vertical	MCS0	160	3	156.456
25.16	Vertical	MCS0	160	3	156.002
24.34	Horizontal	MCS0	160	3	156.388
24.35	Horizontal	MCS0	160	3	155.978
24.36	Horizontal	MCS0	160	3	155.118
24.84	Horizontal	MCS0	160	3	155.518
25.04	Horizontal	MCS0	160	3	155.022
25.16	Horizontal	MCS0	160	3	155.154

9.5 Setup Photographs:

Setup Photographs are included in a separate file.

9.6 Plots/Data:

Occupied Bandwidth (Vertical Polarity) – S01411_24.27GHz_BW20M_MCS8_Path 3

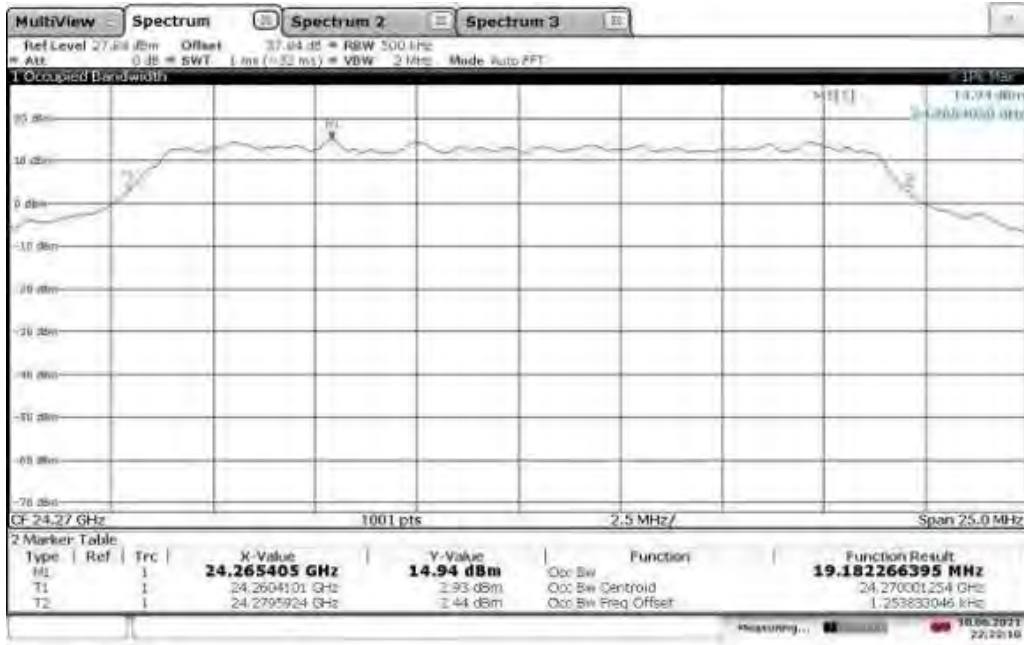

22:22:11 10.06.2021

Occupied Bandwidth (Vertical Polarity) – S01411_24.28GHz_BW20M_MCS8_Path 3

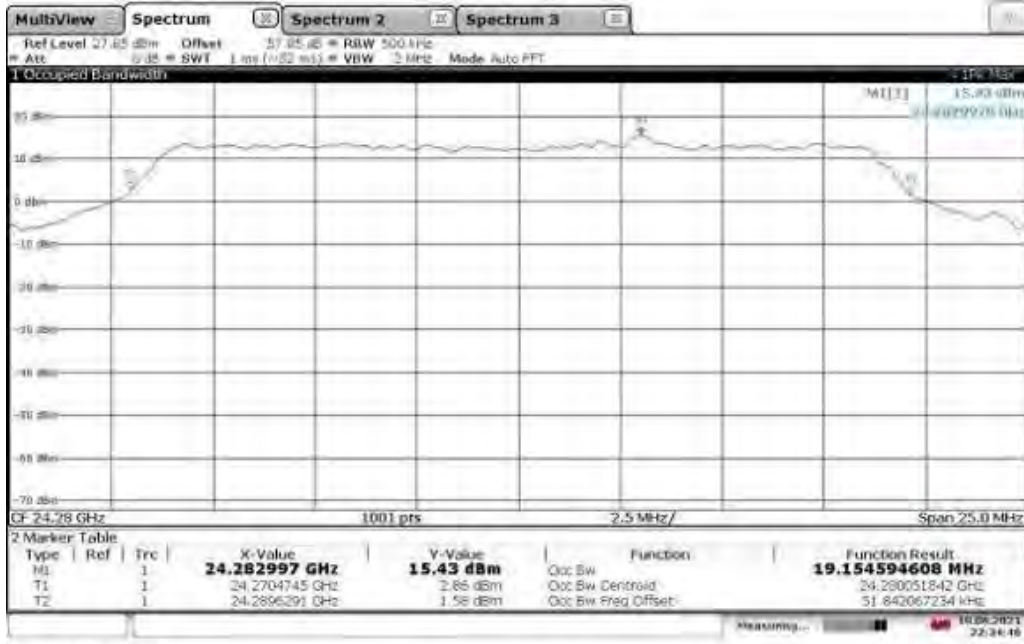

22:34:47 10.06.2021

Occupied Bandwidth (Vertical Polarity) – S01411_24.29GHz_BW20M_MCS8_Path 3

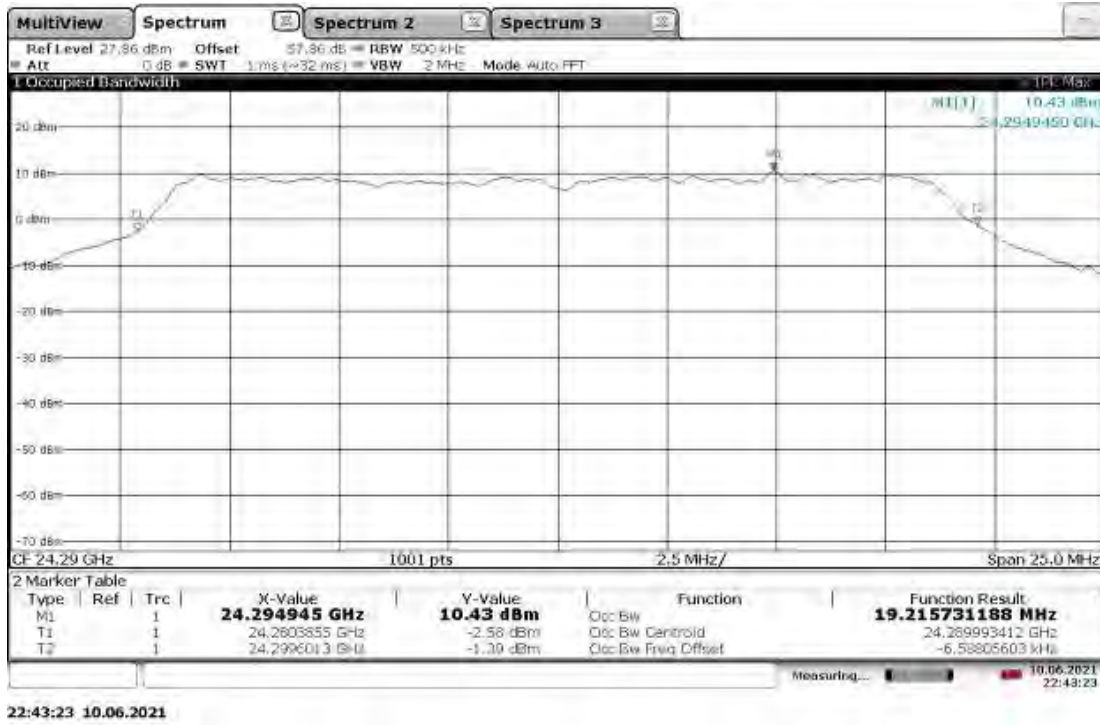

Occupied Bandwidth (Vertical Polarity) – S01411_24.77GHz_BW20M_MCS8_Path 3

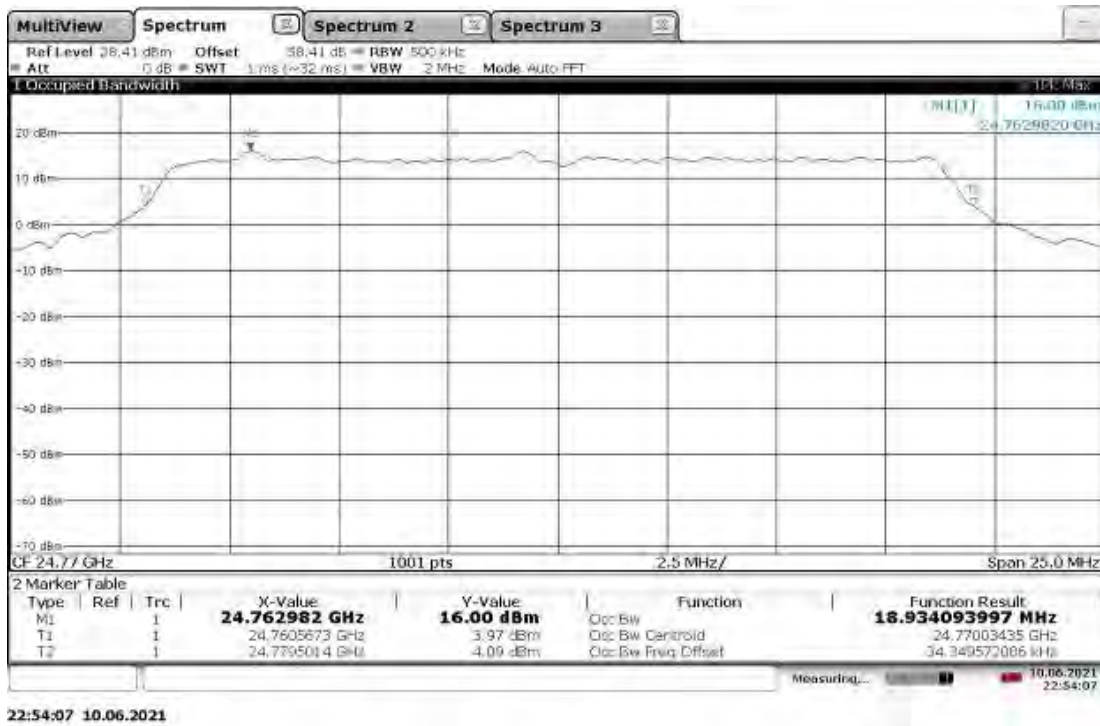

Occupied Bandwidth (Vertical Polarity) – S01411_24.97GHz_BW20M_MCS8_Path 3

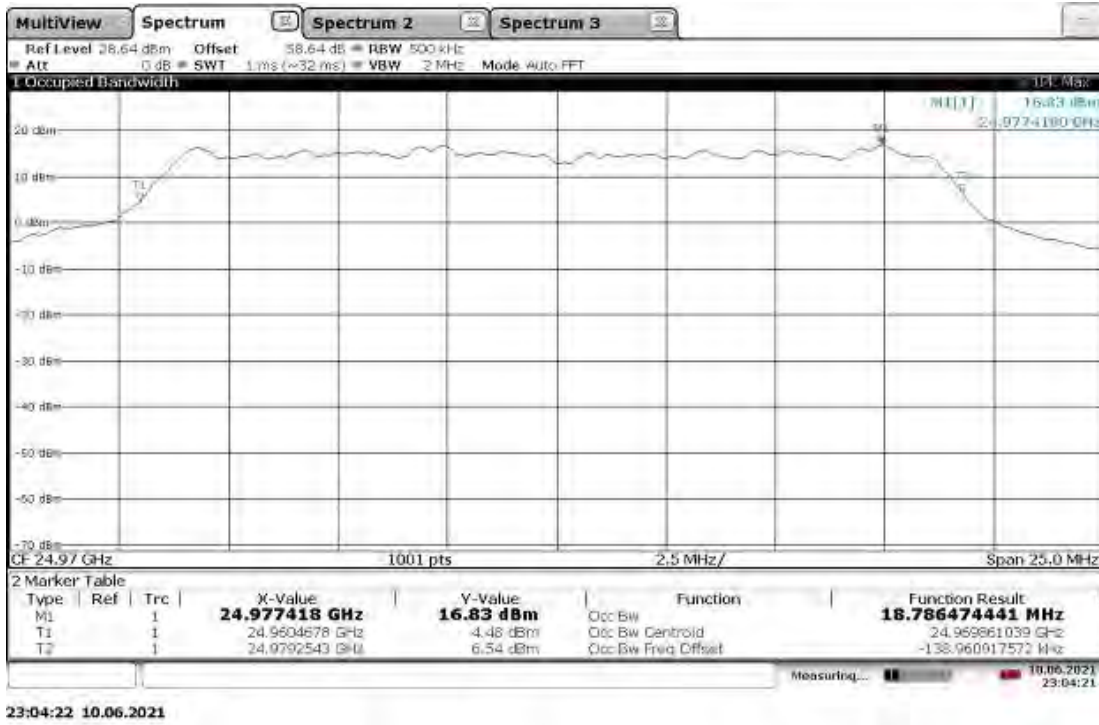

Occupied Bandwidth (Vertical Polarity) – S01411_25.09GHz_BW20M_MCS8_Path 3

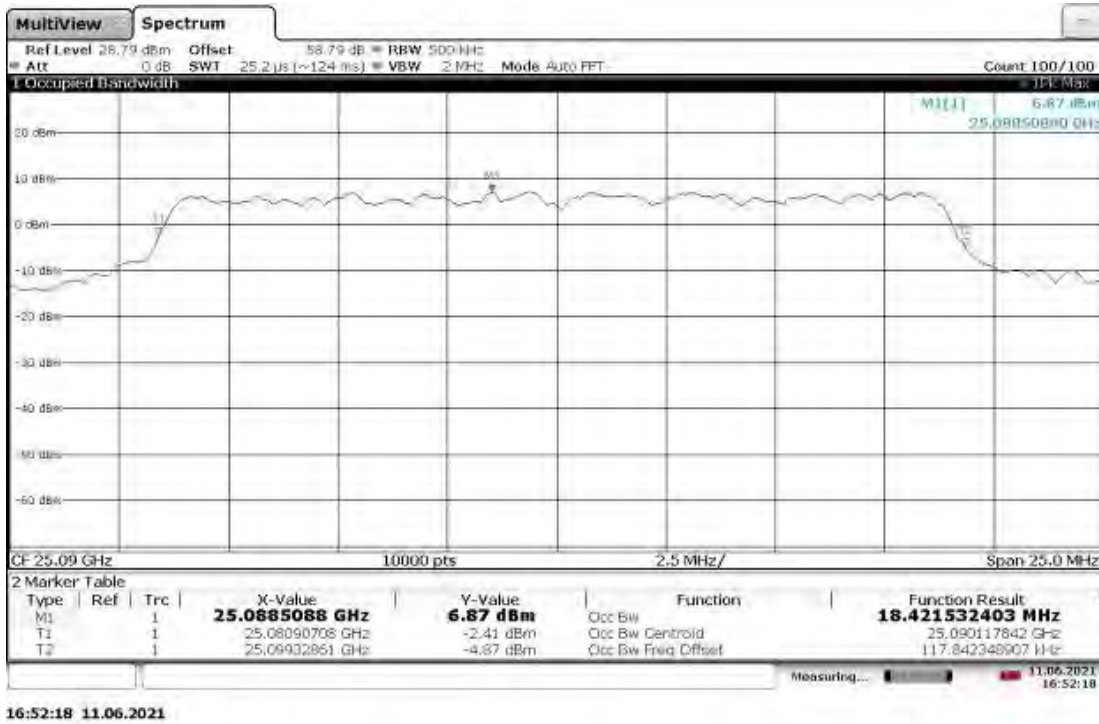

Occupied Bandwidth (Horizontal Polarity) – S01411_24.27GHz_BW20M_MCS8_Path 3

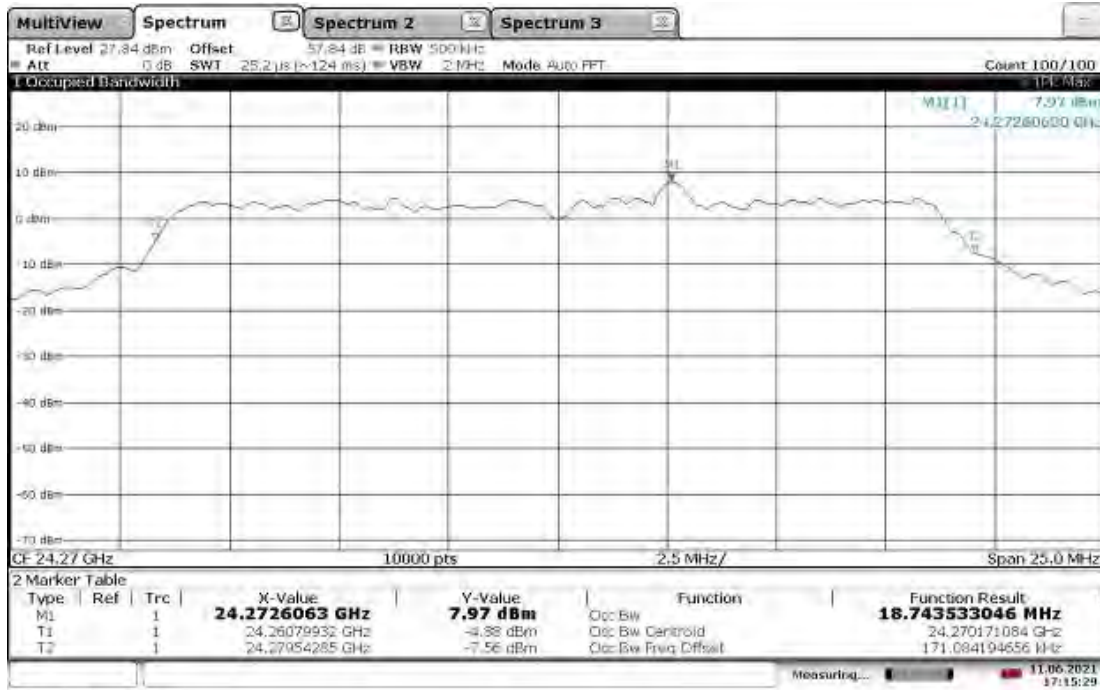

17:15:30 11.06.2021

Occupied Bandwidth (Horizontal Polarity) – S01411_24.28GHz_BW20M_MCS8_Path 3

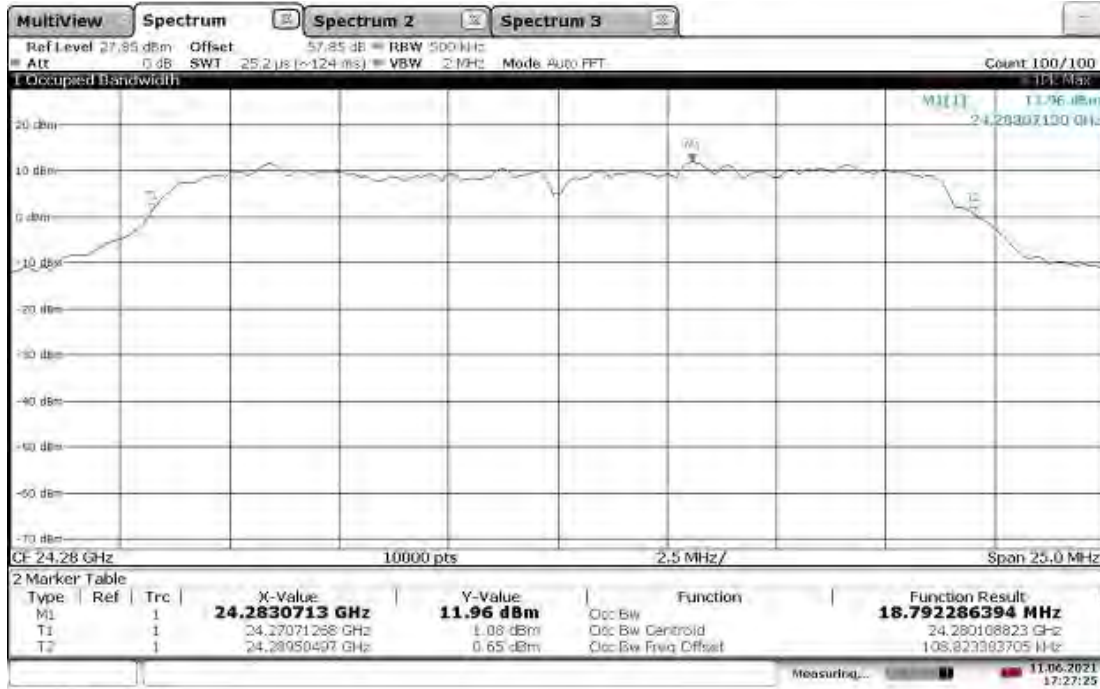

17:27:26 11.06.2021

Occupied Bandwidth (Horizontal Polarity) – S01411_24.29GHz_BW20M_MCS8_Path 3

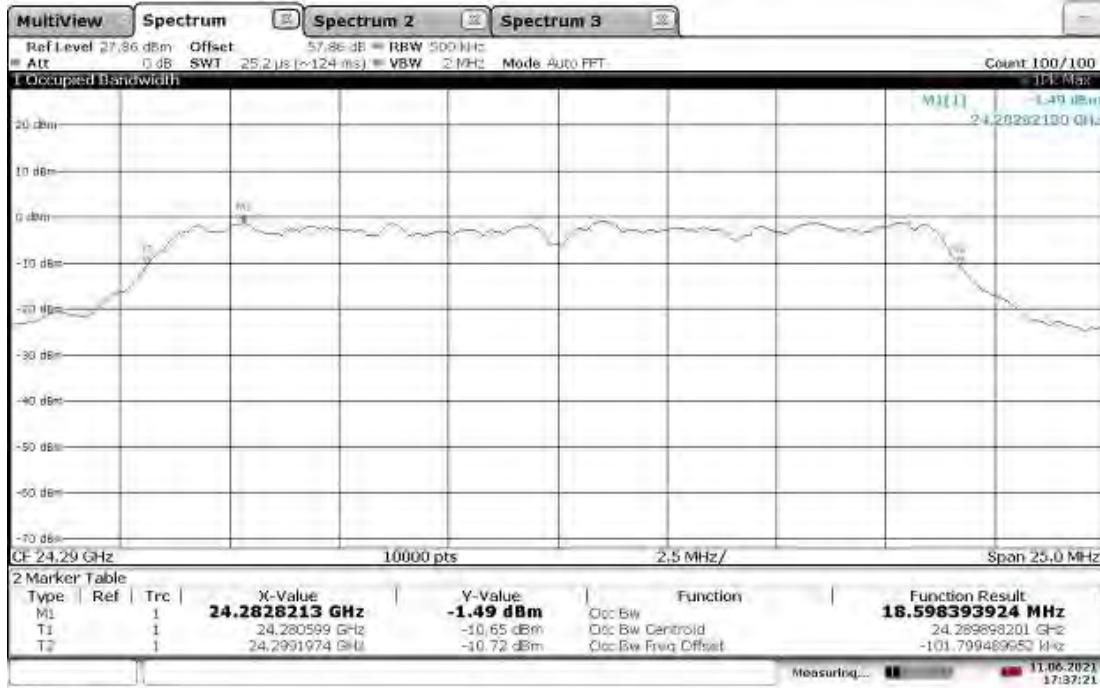

17:37:22 11.06.2021

Occupied Bandwidth (Horizontal Polarity) – S01411_24.77GHz_BW20M_MCS8_Path 3

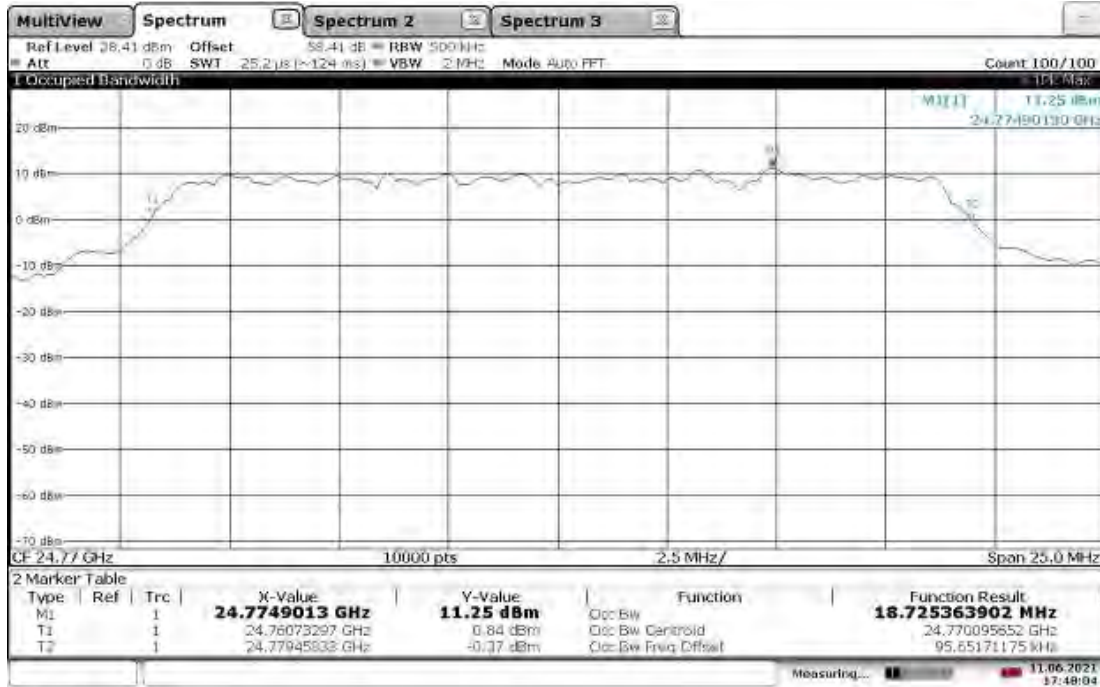

17:48:05 11.06.2021

Occupied Bandwidth (Horizontal Polarity) – S01411_24.97GHz_BW20M_MCS8_Path 3

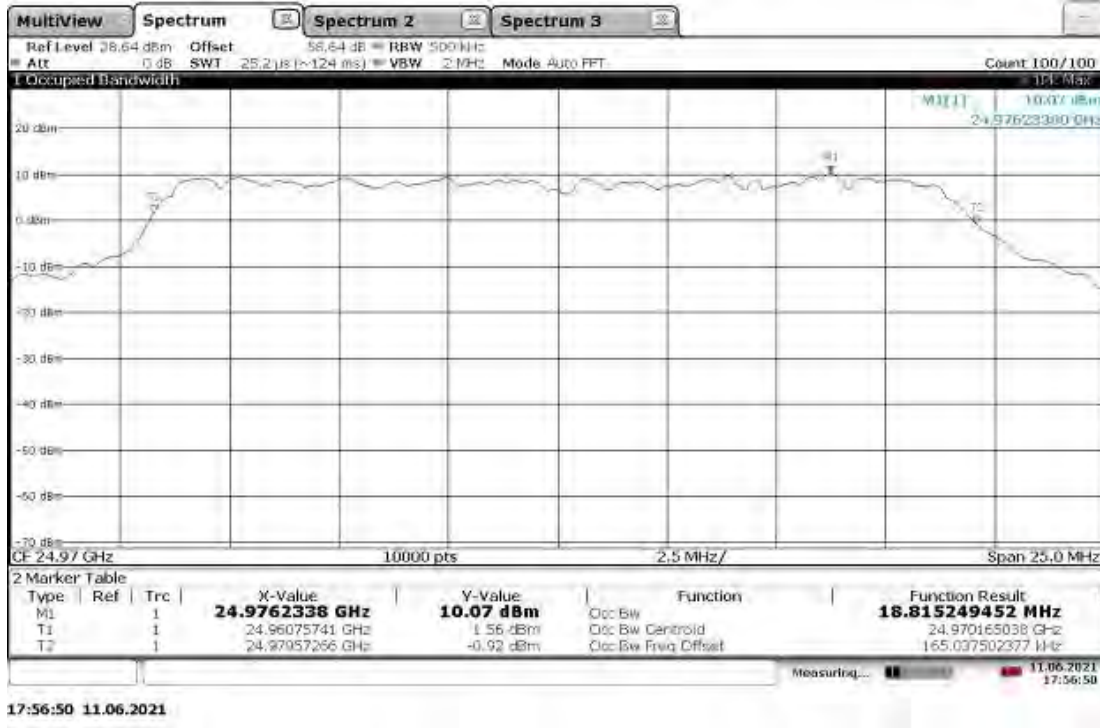

Occupied Bandwidth (Horizontal Polarity) – S01411_25.09GHz_BW20M_MCS8_Path 3

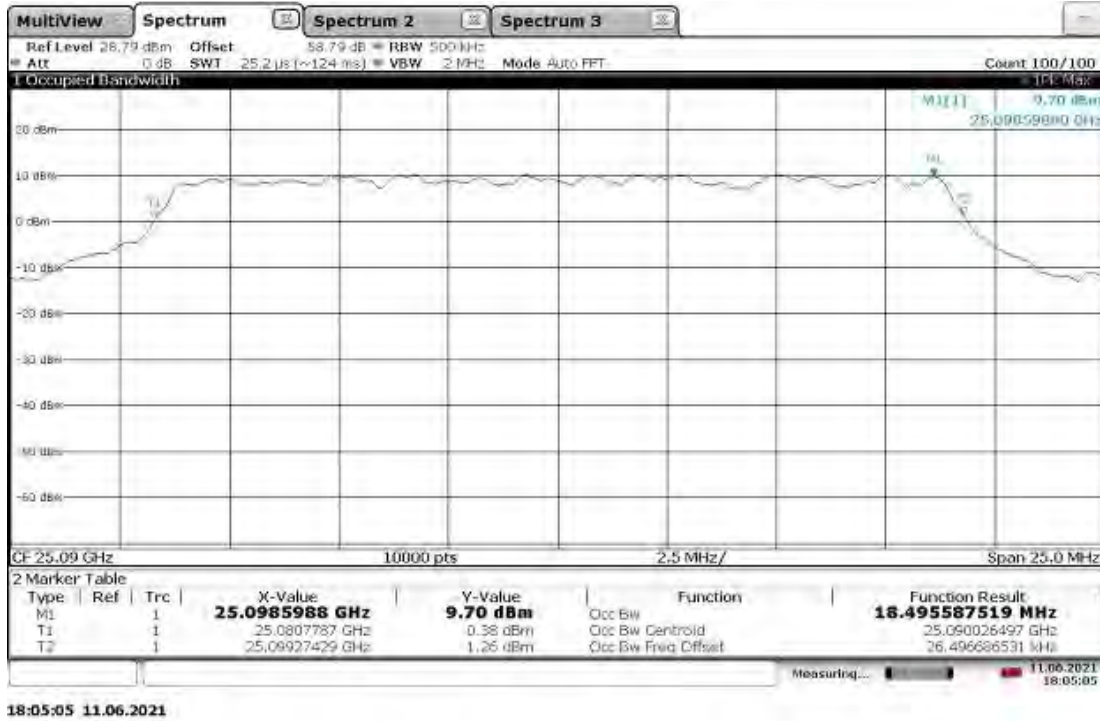

Occupied Bandwidth (Vertical Polarity) – S01411_24.34GHz_BW160M_MCS0_Path 3

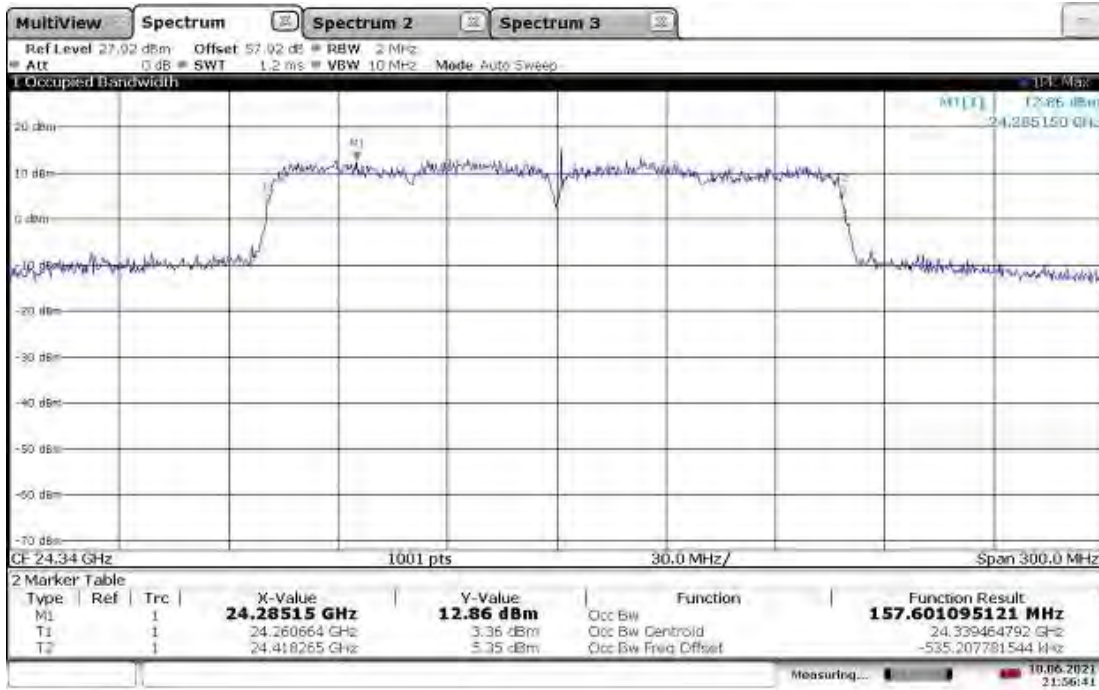

21:56:41 10.06.2021

Occupied Bandwidth (Vertical Polarity) – S01411_24.35GHz_BW160M_MCS0_Path 3

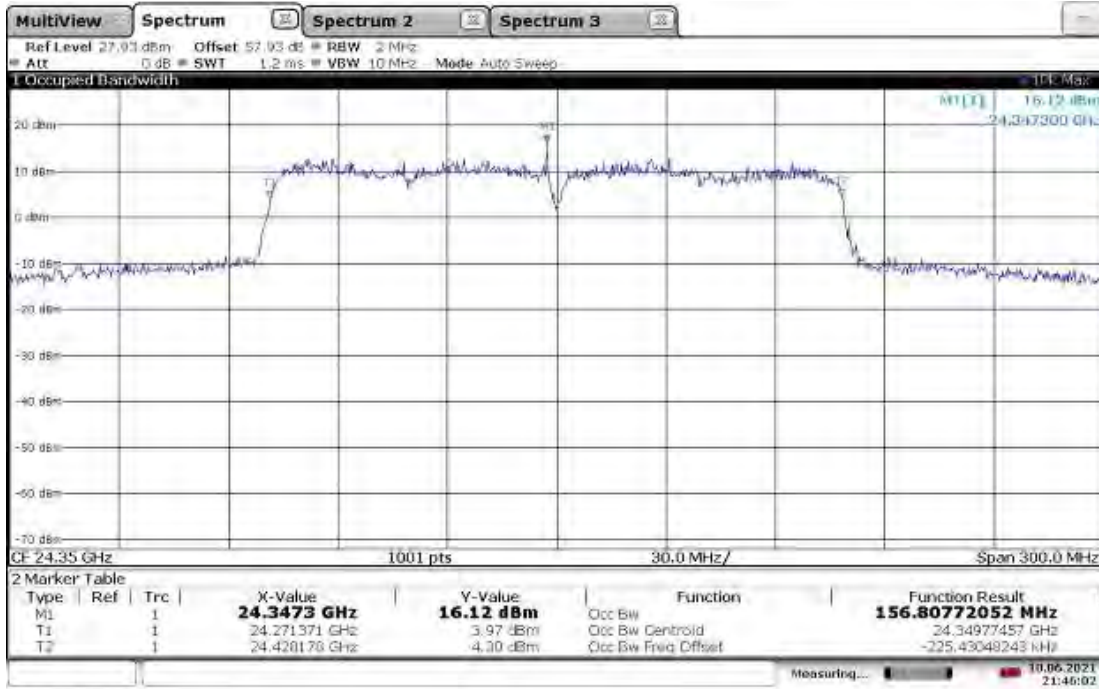

21:46:03 10.06.2021

Occupied Bandwidth (Vertical Polarity) – S01411_24.36GHz_BW160M_MCS0_Path 3

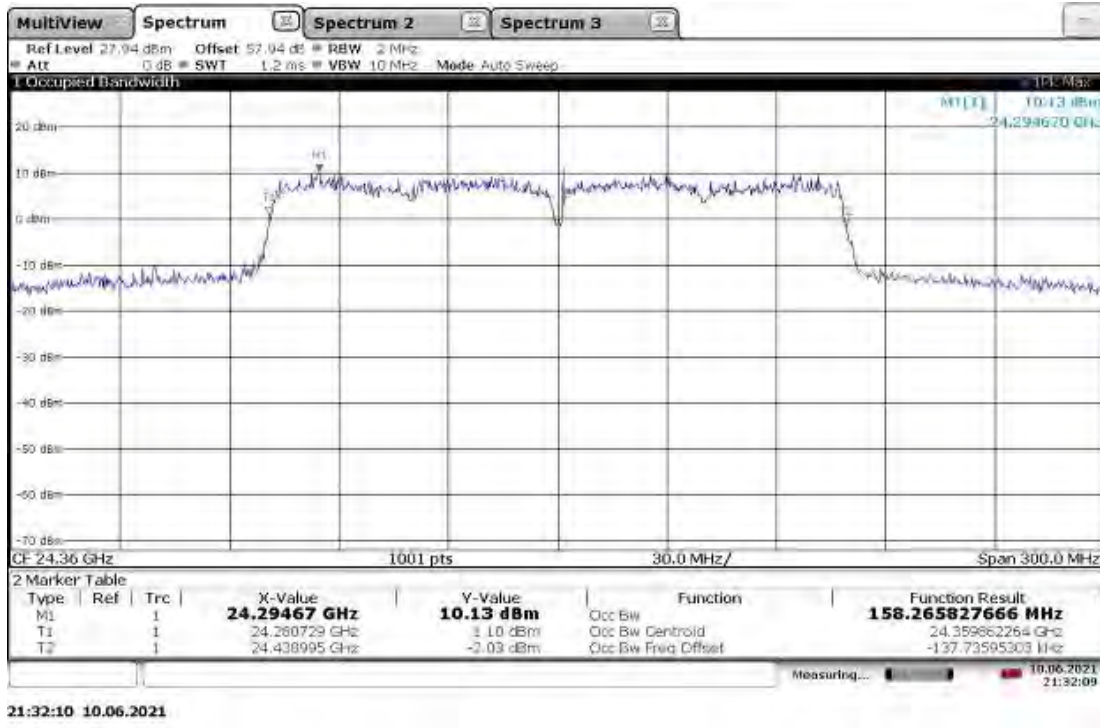

Occupied Bandwidth (Vertical Polarity) – S01411_24.84GHz_BW160M_MCS0_Path 3

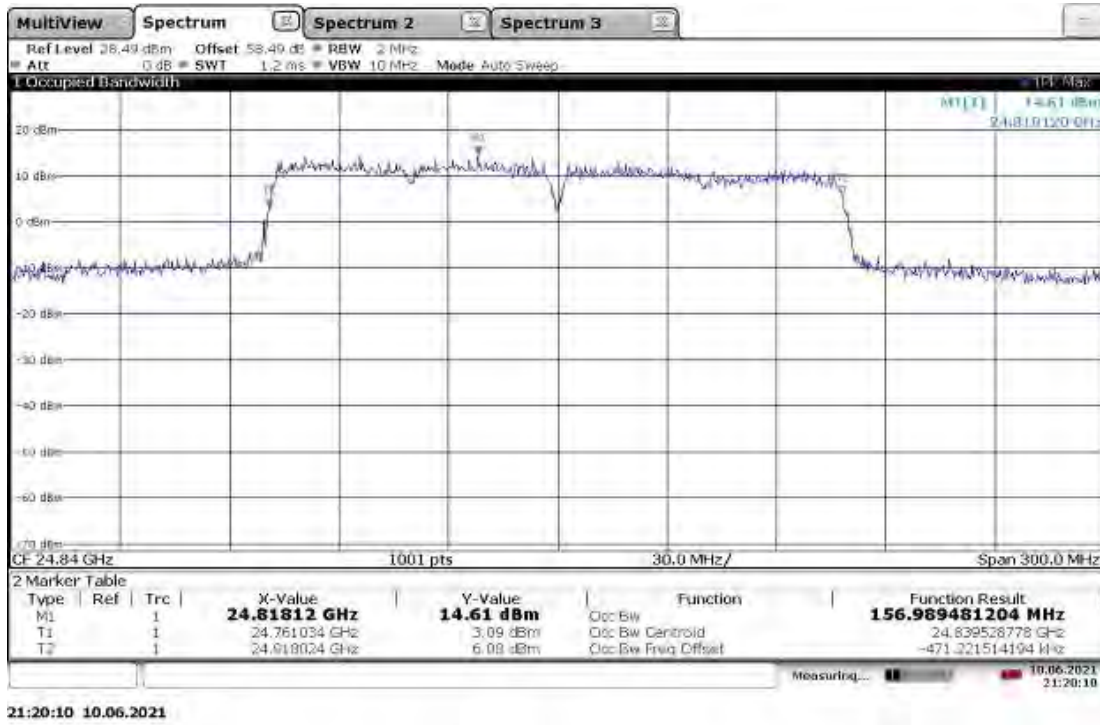

Occupied Bandwidth (Vertical Polarity) – S01411_25.04GHz_BW160M_MCS0_Path 3

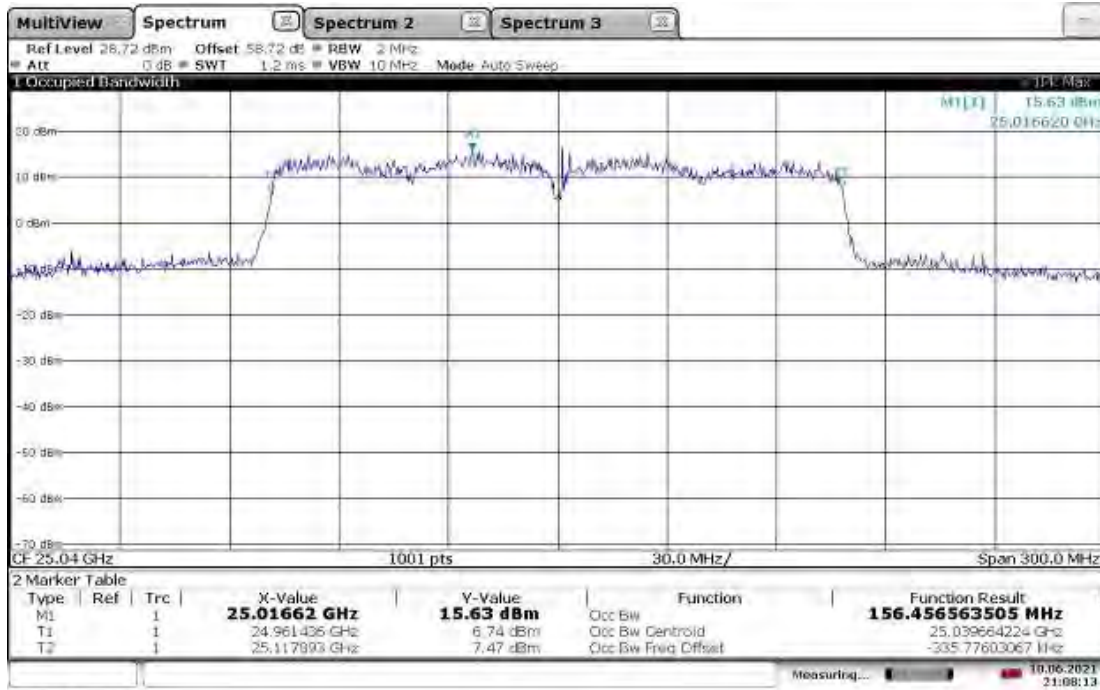

21:08:14 10.06.2021

Occupied Bandwidth (Vertical Polarity) – S01411_25.16GHz_BW160M_MCS0_Path 3

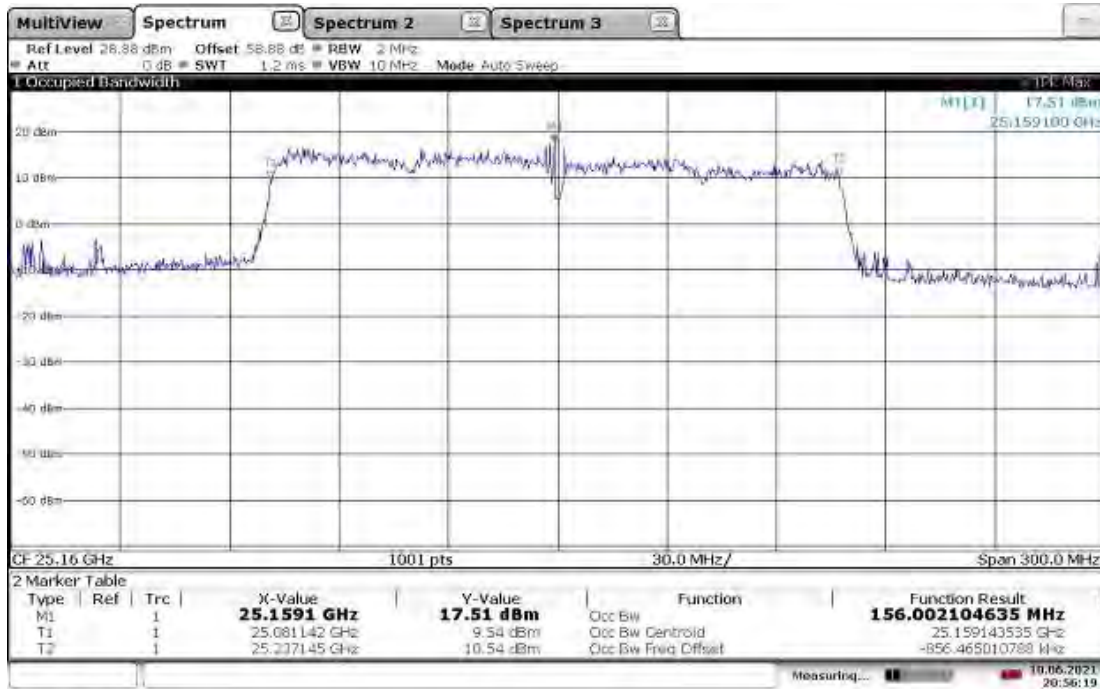

20:56:19 10.06.2021

Occupied Bandwidth (Horizontal Polarity) – S01411_24.34MHz_BW160M_MCS0_Path 3

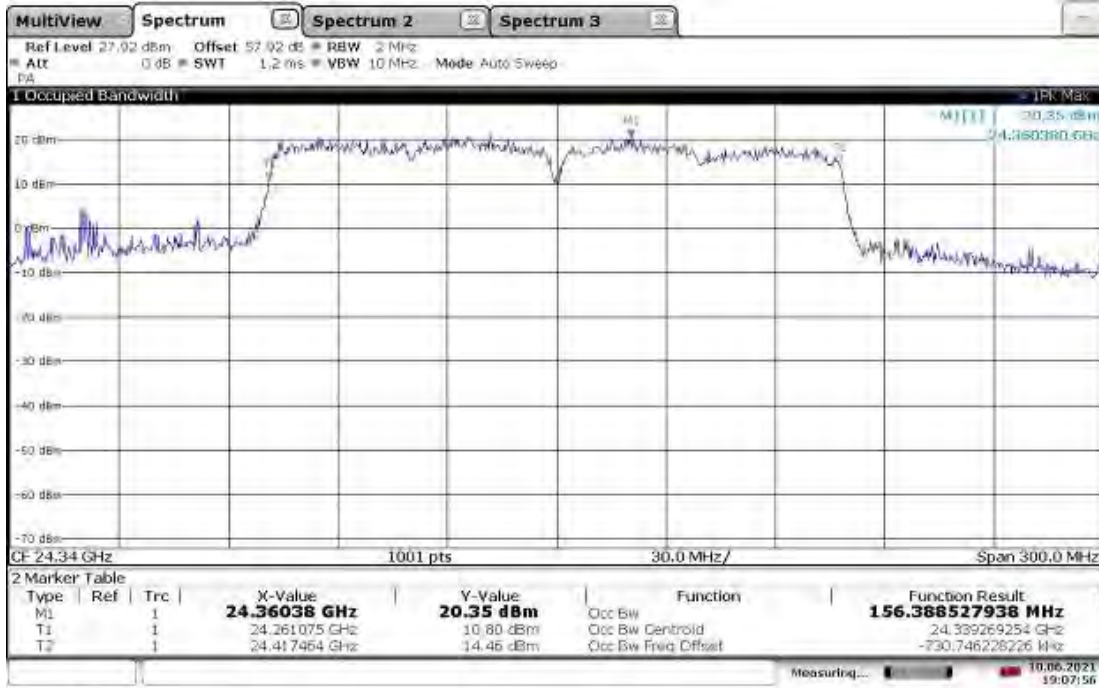

Occupied Bandwidth (Horizontal Polarity) – S01411_24.35MHz_BW160M_MCS0_Path 3

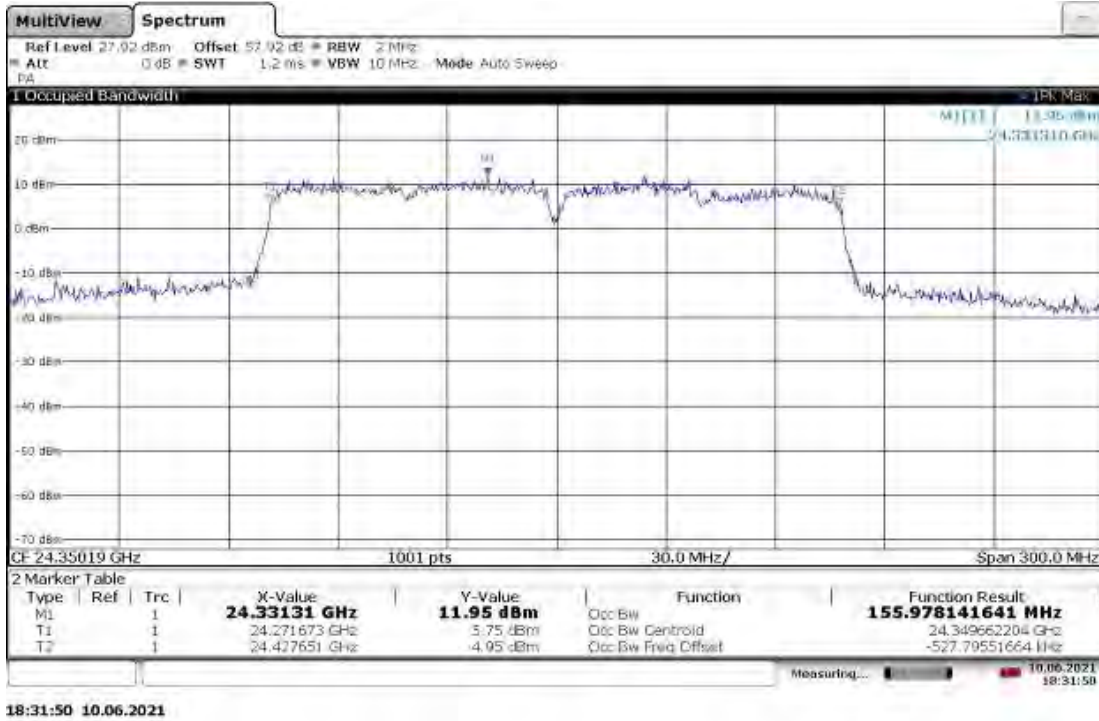

Occupied Bandwidth (Horizontal Polarity) – S01411_24.36GHz_BW160M_MCSO_Path 3

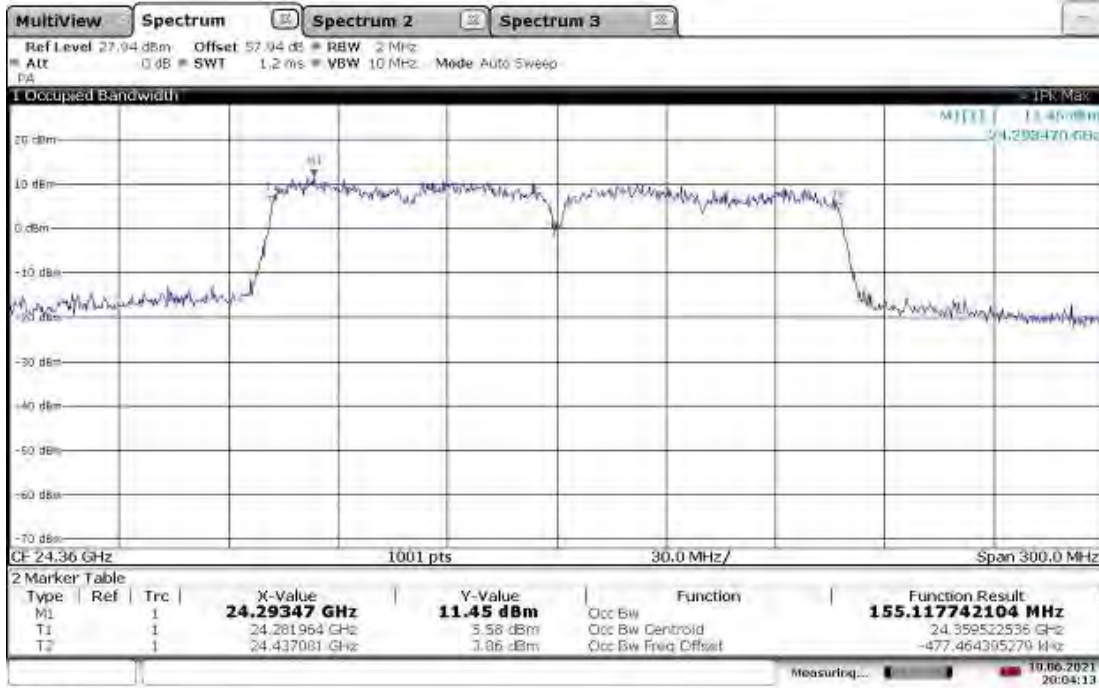

Occupied Bandwidth (Horizontal Polarity) – S01411_24.84GHz_BW160M_MCSO_Path 3

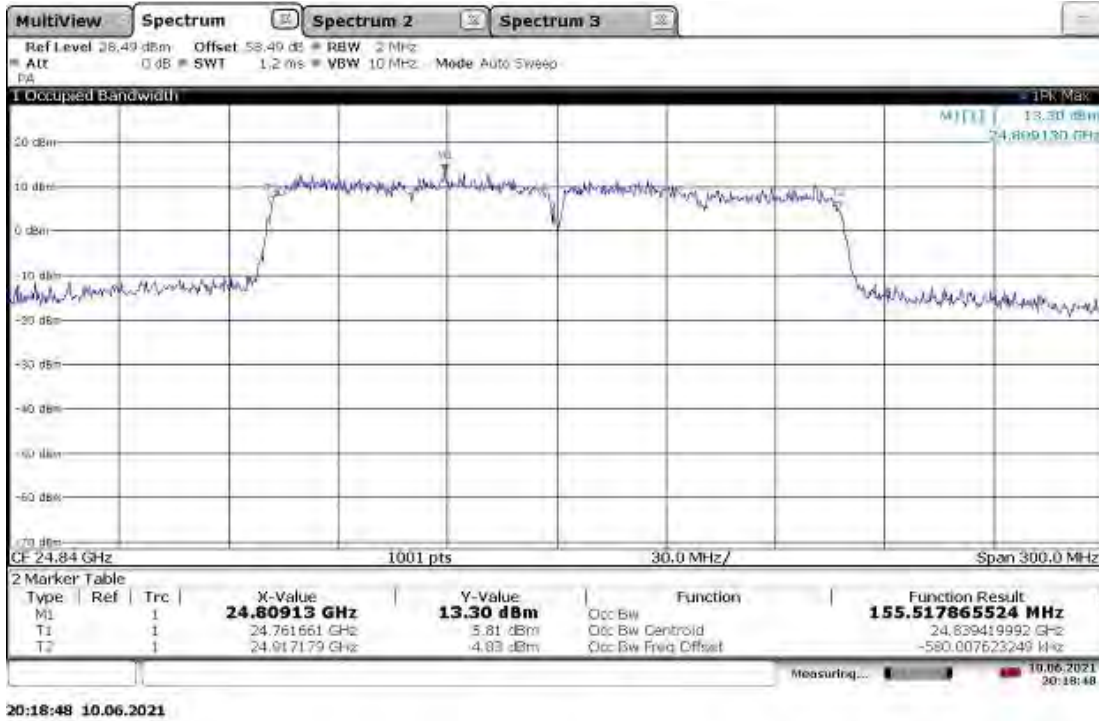

Occupied Bandwidth (Horizontal Polarity) – S01411_25.04GHz_BW160M_MCS0_Path 3

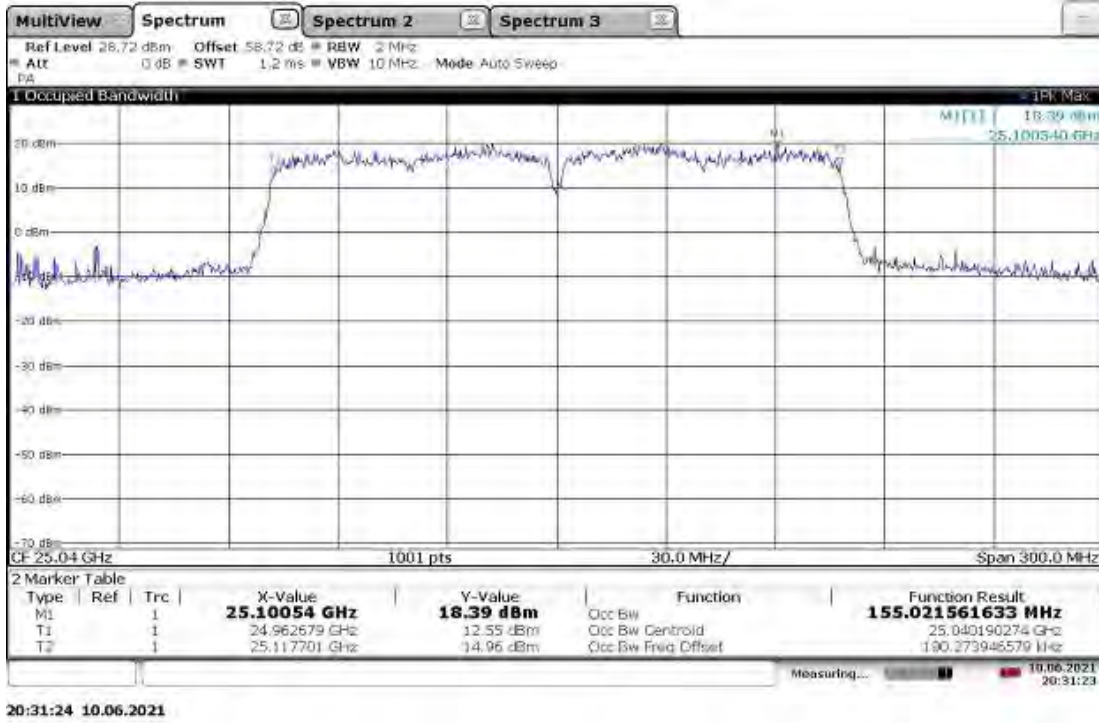

Occupied Bandwidth (Horizontal Polarity) – S01411_25.16GHz_BW160M_MCS0_Path 3

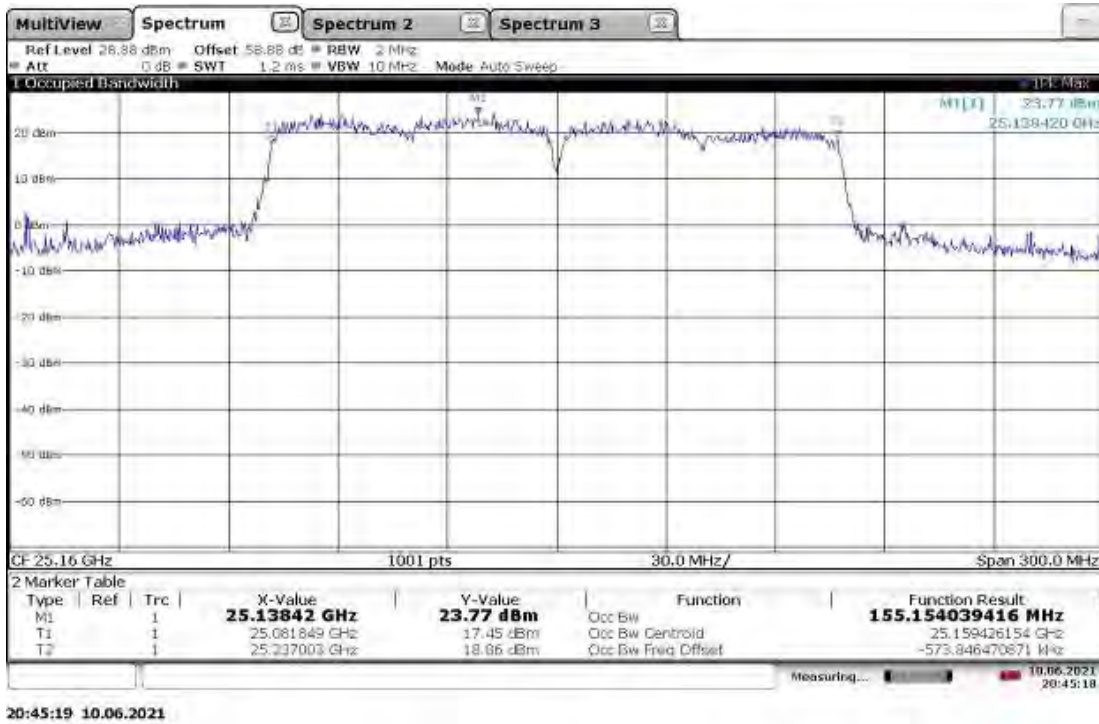

Intertek

Report Number: 104689284BOX-001

Issued: 08/02/2021
Last Revised: 10/12/2021

Test Personnel: Vathana Ven *VSV*
Supervising/Reviewing
Engineer:
(Where Applicable) Kouma Sinn *KPS*
Product Standard: FCC 47CFR Part 30 Subpart C
Input Voltage: 48 VDC Via External P/S
Pretest Verification w/
BB Source: Yes

Test Date: 06/10/2021, 06/11/2021
Limit Applied: See Report Section 9.3
Ambient Temperature: 24, 24 °C
Relative Humidity: 38, 37 %
Atmospheric Pressure: 1004, 999mbars

Deviations, Additions, or Exclusions: None

10 Frequency Stability

10.1 Requirements

FCC §2.1055 Measurements required: Frequency stability

The frequency stability shall be measured with variation of ambient temperature from -30° to + 50° centigrade. The frequency stability shall be measured with variation of primary supply voltage from 85 to 115 percent of the nominal value.

10.2 Method

Tests are performed in accordance with FCC 47CFR Part 2.1055, FCC 47CFR Part 2.1041, KDB 842590 D01 Upper Microwave Flexible Use Service v01r02 April 20, 2021 Subclause 4.5, and ANSI C63.26-2015 Subclause 5.6.

TEST SITE: Safety Lab

10.3 Test Equipment Used:

Asset	Description	Manufacturer	Model	Serial	Cal Date	Cal Due
SAF1153'	Environmental Test Chamber	Cincinnati Sub-Zero	CTH-(FR)64-6-6-SC/AC	12-CT15628	11/18/2020	11/18/2021
EMC04'	ANTENNA, RIDGED GUIDE, 18-40 GHZ	EMCO	3116	2090	01/28/2021	01/28/2022
ROS005-1'	Signal and Spectrum Analyzer	R&S	FSW43	100646	10/27/2020	10/27/2021
SAF1312'	Multi-Meter	Fluke	87V	30840221	12/04/2020	12/04/2021
CBLHF2012-5M-2'	5m 9kHz-40GHz Coaxial Cable - SET2	Huber & Suhner	SF102	252676002	02/19/2021	02/19/2022

Software Utilized:

Name	Manufacturer	Version
EMI Boxborough.xls	Intertek	08/27/2010

10.4 Results:

The sample tested was found to Comply. Frequency tolerance is not specified in FCC 47 CFR Part 30 Subpart C. Measurement was performed for reporting purpose. Limit in the data table is from FCC Part 30 Subpart E §30.402.

10.5 Setup Photographs:

Setup Photographs are included in a separate file.

10.6 Test Data:

24.34 GHz Frequency Stability

Company: Starry
Model #: S01411
Serial #: 2111000001
Engineer(s): Kouma Sinn
Project #: G104689284
Standard: FCC Part 30.402

Test Equipment Used:
SAF1153 EMC04
ROS005-1 SAF1312
CBLHF2012-5M-2
Location: Safety

Limit: 10 PPM 0.001%
Nominal
f: 24340 MHz

Voltage: 48 VDC

%	Voltage Volts	Frequency MHz	Deviation kHz	Limit kHz
-15%	40.8	24339.997840000	0.120	243.40
+0%	48	24339.997720000	0.000	243.40
+15%	55.2	24339.998080000	0.360	243.40

Temp Celsius	Frequency MHz	Deviation kHz	Limit kHz
-30	24339.998000000	0.280	243.40
-20	24339.997850000	0.130	243.40
-10	24339.998010000	0.290	243.40
0	24339.998150000	0.430	243.40
10	24339.998180000	0.460	243.40
20	24339.997720000	0.000	243.40
30	24339.997430000	-0.290	243.40
40	24339.997720000	0.000	243.40
50	24339.997930000	0.210	243.40

24.35 GHz Frequency Stability

Company: Starry
Model #: S01411
Serial #: 2111000001
Engineer(s): Kouma Sinn
Project #: G104689284
Standard: FCC Part 30.402

Test Equipment Used:
SAF1153 EMC04
ROS005-1 SAF1312
CBLHF2012-5M-2
Location: Safety

Limit: 10 PPM 0.001%
Nominal
f: 24350 MHz

Voltage: 48 VDC

%	Voltage Volts	Frequency MHz	Deviation kHz	Limit kHz
-15%	40.8	24349.998165000	0.090	243.50
+0%	48	24349.998075000	0.000	243.50
+15%	55.2	24349.998265000	0.190	243.50

Temp Celsius	Frequency MHz	Deviation kHz	Limit kHz
-30	24349.997750000	-0.325	243.50
-20	24349.997800000	-0.275	243.50
-10	24349.997910000	-0.165	243.50
0	24349.998140000	0.065	243.50
10	24349.998230000	0.155	243.50
20	24349.998075000	0.000	243.50
30	24349.997780000	-0.295	243.50
40	24349.997760000	-0.315	243.50
50	24349.997630000	-0.445	243.50

24.36 GHz Frequency Stability

Company: Starry
Model #: S01411
Serial #: 2111000001
Engineer(s): Kouma Sinn
Project #: G104689284
Standard: FCC Part 30.402

Location: Safety

Test Equipment Used:
SAF1153 EMC04
ROS005-1 SAF1312

CBLHF2012-5M-2

Date(s): 06/21/21

Limit: 10 PPM 0.001%
Nominal
f: 24360 MHz

Voltage: 48 VDC

%	Voltage Volts	Frequency MHz	Deviation kHz	Limit kHz
-15%	40.8	24359.998120000	0.060	243.60
+0%	48	24359.998060000	0.000	243.60
+15%	55.2	24359.998120000	0.060	243.60

Temp Celsius	Frequency MHz	Deviation kHz	Limit kHz
-30	24359.997810000	-0.250	243.60
-20	24359.997960000	-0.100	243.60
-10	24359.997970000	-0.090	243.60
0	24359.998050000	-0.010	243.60
10	24359.998000000	-0.060	243.60
20	24359.998060000	0.000	243.60
30	24359.997675000	-0.385	243.60
40	24359.997930000	-0.130	243.60
50	24359.997710000	-0.350	243.60

24.84 GHz Frequency Stability

Company: Starry
Model #: S01411
Serial #: 2111000001
Engineer(s): Kouma Sinn
Project #: G104689284
Standard: FCC Part 30.402

Location: Safety

Test Equipment Used:
SAF1153 EMC04
ROS005-1 SAF1312

CBLHF2012-5M-2

Date(s): 06/21/21

Limit: 10 PPM 0.001%
Nominal
f: 24840 MHz

Voltage: 48 VDC

%	Voltage Volts	Frequency MHz	Deviation kHz	Limit kHz
-15%	40.8	24839.998135000	-0.475	248.40
+0%	48	24839.998610000	0	248.40
+15%	55.2	24839.997795000	-0.8305	248.40

Temp Celsius	Frequency MHz	Deviation kHz	Limit kHz
-30	24839.997780000	-0.83	248.40
-20	24839.997920000	-0.69	248.40
-10	24839.998050000	-0.56	248.40
0	24839.998210000	-0.4	248.40
10	24839.998120000	-0.49	248.40
20	24839.998610000	0	248.40
30	24839.997800000	-0.81	248.40
40	24839.997900000	-0.71	248.40
50	24839.997630000	-0.98	248.40

25.04 GHz Frequency Stability

Company: Starry
Model #: S01411
Serial #: 2111000001
Engineer(s): Kouma Sinn
Project #: G104689284
Standard: FCC Part 30.402

Date(s): 06/21/21
Location: Safety

Test Equipment Used:
SAF1153 EMC04
ROS005-1 SAF1312
CBLHF2012-5M-2

Limit: 10 PPM 0.001%
Nominal
f: 25040 MHz

Voltage: 48 VDC

%	Voltage Volts	Frequency MHz	Deviation kHz	Limit kHz
-15%	40.8	25039.997890000	-0.22	250.40
+0%	48	25039.998110000	0	250.40
+15%	55.2	25039.997976000	-0.134	250.40

Temp Celsius	Frequency MHz	Deviation kHz	Limit kHz
-30	25039.997500000	-0.61	250.40
-20	25039.997770000	-0.34	250.40
-10	25039.998640000	0.53	250.40
0	25039.998170000	0.06	250.40
10	25039.998070000	-0.04	250.40
20	25039.998110000	0	250.40
30	25039.997800000	-0.31	250.40
40	25039.997980000	-0.13	250.40
50	25039.997480000	-0.63	250.40

48VDC

25.16 GHz Frequency Stability

Company: Starry
Model #: Titan24
Serial #: 2111000001
Engineer(s): Kouma Sinn
Project #: G104689284
Standard: FCC Part 30.402

Date(s): 06/21/21
Location: Safety

Test Equipment Used:
SAF1153 EMC04
ROS005-1 SAF1312
CBLHF2012-5M-2

Limit: 10 PPM 0.001%
Nominal
f: 25160 MHz

Voltage: 48 VDC

%	Voltage Volts	Frequency MHz	Deviation kHz	Limit kHz
-15%	40.8	25159.997559500	-2.291	251.60
+0%	48	25159.999850500	0	251.60
+15%	55.2	25159.997770000	-2.0805	251.60

Temp Celsius	Frequency MHz	Deviation kHz	Limit kHz
-30	25159.997595000	-2.2555	251.60
-20	25159.997680000	-2.1705	251.60
-10	25159.998235000	-1.6155	251.60
0	25159.998295000	-1.5555	251.60
10	25159.997740000	-2.1105	251.60
20	25159.999850500	0	251.60
30	25159.997700000	-2.1505	251.60
40	25159.997895000	-1.9555	251.60
50	25159.997420000	-2.4305	251.60

Test Personnel: Kouma Sinn *KPS*
Supervising/Reviewing Engineer:
(Where Applicable) N/A
Product Standard: FCC 47CFR Part 30 Subparts C and E
Input Voltage: 48VDC Via External P/S
Pretest Verification w/ Signal generator: N/A

Test Date: 06/21/2021

Limit Applied: See Report Section 10.3

Ambient Temperature: N/A
Relative Humidity: N/A
Atmospheric Pressure: N/A

Deviations, Additions, or Exclusions: None

11 AC Main Conducted Emissions

11.1 Method

Tests are performed in accordance with FCC Part 15 Subpart B and ANSI C63.4.

TEST SITE: EMC Lab

The EMC Lab has one Semi-anechoic Chamber and one Shielded Chamber. AC Mains Power is available at 120, 230, and 277 Single Phase; 208, 400, and 480 3-Phase. Large reference ground-planes are installed in the general lab area to facilitate EMC work not requiring a shielded environment.

Measurement Uncertainty

Measurement	Frequency Range	Expanded Uncertainty (k=2)	Ucisp
AC Line Conducted Emissions	150 kHz - 30 MHz	1.2 dB	3.4dB
Telco Port Emissions	150 kHz - 30 MHz	2.8 dB	5.0dB
AC Line Conducted Emissions	9 kHz - 150 MHz	2.2 dB	3.4 dB

Sample Calculations

The following is how net line-conducted readings were determined:

$$NF = RF + LF + CF + AF$$

- Where NF = Net Reading in dBμV
- RF = Reading from receiver in dBμV
- LF = LISN or ISN Correction Factor in dB
- CF = Cable Correction Factor in dB
- AF = Attenuator Loss Factor in dB

To convert from dBμV to μV or mV the following was used:

$$UF = 10^{(NF / 20)} \text{ where } UF = \text{Net Reading in } \mu\text{V}$$

$$NF = \text{Net Reading in dB}\mu\text{V}$$

Example:

$$NF = RF + LF + CF + AF = 28.5 + 0.2 + 0.4 + 20.0 = 49.1 \text{ dB}\mu\text{V}$$

$$UF = 10^{(49.1 \text{ dB}\mu\text{V} / 20)} = 285.1 \mu\text{V/m}$$

When BAT-EMC Emission Software is used, the “Level” includes all losses and gains and is compared directly in the “Margin” column to the “Limit”. The “Correction” includes LISN Factor, Attenuator, and Cable Loss. These are already accounted for in the “Level” column.

11.2 Test Equipment Used:

Asset	Description	Manufacturer	Model	Serial	Cal Date	Cal Due
ROS002'	EMI Test Receiver	R&S	ESCI3	100067	06/22/2020	06/22/2021
DS23'	Attenuator, 20dB	Mini Circuits	20dB, 50 ohm	DS23	10/30/2020	10/30/2021
CBL042'	3ft BNC to BNC cable	Hosiwell	Coax RG-58	CBL042	06/08/2021	06/08/2022
147275'	Signal Generator	R&S	SML01	100931	07/20/2020	07/20/2021
147239'	Digital Multimeter (Full Color)	Fluke	187	89300561	02/06/2021	02/06/2022
DAV005'	Weather Station	Davis	6250	MS191218083	02/07/2021	02/07/2022
LISN32'	LISN - CISPR16 Compliant 9kHz-30MHz	Com-Power	LI-215A	191955	05/11/2021	05/11/2022
FCCE4'	Capacitive Voltage Probe	Fischer Custom Commu	F-CVP-1	52	06/01/2021	06/01/2022
145100'	Current Probe (0.001 - 100 MHz)	Fischer Custom Comm.	F-33-4	43	08/12/2020	08/12/2021

Software Utilized:

Name	Manufacturer	Version
BAT-EMC	Nexio	3.20.0.21

11.3 Results:

The sample tested was found to Comply.

11.4 Setup Photograph:

Setup Photographs are included in a separate file.

11.5 Plots/Data:

Test Information:

Date and Time	6/18/2021 5:49:28 PM
Client and Project Number	Starry_G104689284
Engineer	Vathana Ven
Temperature	23 deg C
Humidity	41%
Atmospheric Pressure	1002mbars
Comments	Single Phase Under 15 Amp_150kHz to 30 MHz ESCI_120VAC 60Hz_S01411_Tx/Normal operation mode

Graph:

- Conducted Emissions Limit Lines/FCC Part 15 Subpart B CE Main Ports B - Average/
- Conducted Emissions Limit Lines/FCC Part 15 Subpart B CE Main Ports B - QPeak/
- × Peak (Manual finals) (RF Output Measure)
- Peak (RF Output Measure)
- Peak (Peak/Lim.Avg) (RF Output Measure)
- AVG Level (Average(Pass)) (RF Output Measure)
- QP Level (QuasiPeak(Pass)) (RF Output Measure)

Sub-range 1
Frequencies: 150 kHz - 30 MHz (Mode: Lin - Step: 4.5 kHz)
Settings: BBW: 9kHz, VBW: Auto, Sweep time: 5 ms/Pts, Attenuation: Auto, Sweep count 1, Preamp: Off, LN Preamp: Off, Preselector: On
Line:RF Output Measure

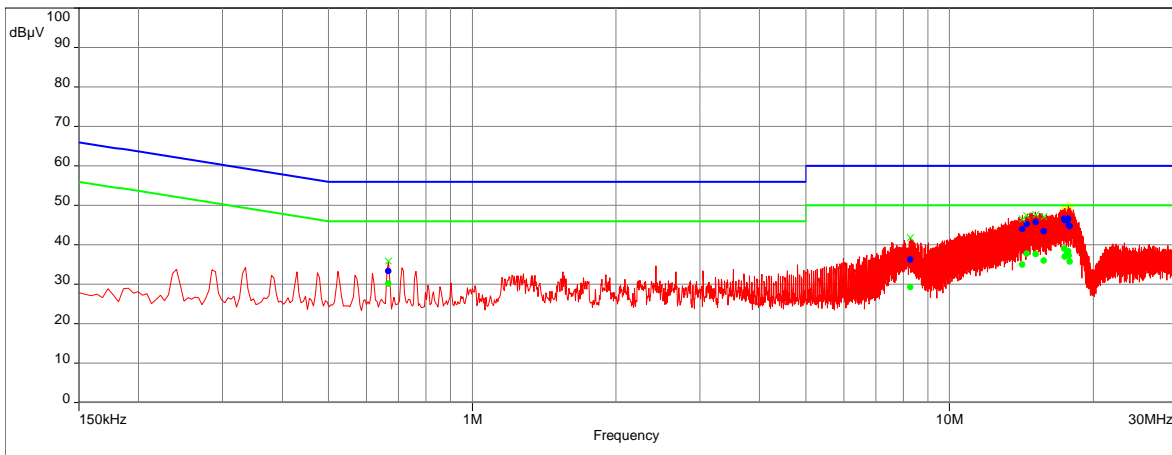

test name Single Phase Under 15 Amp_150kHz to 30 MHz ESCI_120VAC 60Hz_Titan 24_Tx/Normal operation mode Time ate 18/6/2021 18:1

Intertek

Report Number: 104689284BOX-001

Issued: 08/02/2021
Last Revised: 10/12/2021

Results:

QuasiPeak(Pass) (12)

Frequency (MHz)	QP Level (dBμV)	QP Limit (dBuV)	QP Margin (dB)	Line	RBW	Meas.Time	Correction (dB)
0.6675	33.27	56.00	-22.73	Phase 1	9k	0.01	20.11
8.273	36.26	60.00	-23.74	Neutral	9k	0.01	20.23
14.218	43.89	60.00	-16.11	Phase 1	9k	0.01	20.26
14.507	45.19	60.00	-14.81	Phase 1	9k	0.01	20.26
15.172	45.65	60.00	-14.35	Phase 1	9k	0.01	20.27
15.7445	43.39	60.00	-16.61	Neutral	9k	0.01	20.28
17.4085	46.58	60.00	-13.42	Phase 1	9k	0.01	20.29
17.4515	46.26	60.00	-13.74	Phase 1	9k	0.01	20.29
17.645	46.28	60.00	-13.72	Phase 1	9k	0.01	20.29
17.7405	46.56	60.00	-13.44	Phase 1	9k	0.01	20.29
17.7875	44.92	60.00	-15.08	Phase 1	9k	0.01	20.29
17.88	44.65	60.00	-15.35	Phase 1	9k	0.01	20.29

Average(Pass) (12)

Frequency (MHz)	AVG Level (dBμV)	AVG Limit (dBuV)	AVG Margin (dB)	Line	RBW	Meas.Time	Correction (dB)
0.6675	30.19	46.00	-15.81	Phase 1	9k	0.01	20.11
8.273	29.27	50.00	-20.73	Neutral	9k	0.01	20.23
14.218	34.91	50.00	-15.09	Phase 1	9k	0.01	20.26
14.507	37.69	50.00	-12.31	Phase 1	9k	0.01	20.26
15.172	37.62	50.00	-12.38	Phase 1	9k	0.01	20.27
15.7445	36.01	50.00	-13.99	Neutral	9k	0.01	20.28
17.4085	38.95	50.00	-11.05	Phase 1	9k	0.01	20.29
17.4515	36.93	50.00	-13.07	Phase 1	9k	0.01	20.29
17.645	38.11	50.00	-11.89	Phase 1	9k	0.01	20.29
17.7405	38.36	50.00	-11.64	Phase 1	9k	0.01	20.29
17.7875	37.17	50.00	-12.83	Phase 1	9k	0.01	20.29
17.88	35.70	50.00	-14.30	Phase 1	9k	0.01	20.29

Test Personnel: Vathana F. Ven *VSV*
 Supervising/Reviewing Engineer: _____
 (Where Applicable) N/A
 Product Standard: FCC Part 15 Subpart B
 Input Voltage: 120VAC 60Hz
 Pretest Verification w/ Signal generator: Yes

Test Date: 06/18/2021
 Limit Applied: Class B
 Ambient Temperature: 23 °C
 Relative Humidity: 41 %
 Atmospheric Pressure: 1002 mbars

Deviations, Additions, or Exclusions: None

12 Revision History

Revision Level	Date	Report Number	Prepared By	Reviewed By	Notes
0	08/02/2021	104689284BOX-001	KPS <i>KPS</i>	VFV <i>VFV</i>	Original Issue
1	08/06/2021	104689284BOX-001	KPS <i>KPS</i>	VFV <i>VFV</i>	Model number and typo corrections
2	08/23/2021	104689284BOX-001	KPS <i>KPS</i>	VFV <i>VFV</i>	Updated the KDB date and added test equipment from 40-100 GHz
3	09/28/2021	104689284BOX-001	KPS <i>KPS</i>	VFV <i>VFV</i>	Removed FCC Part 30
4	10/03/2021	104689284BOX-001	KPS <i>KPS</i>	VFV <i>VFV</i>	Typo correction in Section 6.3, 9.3, and changed "5G Radio" to " Proprietary upbanded and modified 802.11AC Radio" in Radio/Receiver Characteristics Table
5	10/12/2021	104689284BOX-001	KPS <i>KPS</i>	VFV <i>VFV</i>	Updated Output Power tables and editorial changes

13 Appendix A – Mixer Conversion Loss

40-60 GHz Mixer Conversion Loss

WR19.0SAX-F

1 Product Overview

Product List (Quantity)	Serial Number(s)	Order No.	Date / Initials
WR19.0SAX-F (1)	SAX 835	21108A	03/26/2021 SAB

Product Description: This VDI product includes one WR19.0 Frequency Extender, intended for use with Rohde & Schwarz FSW spectrum analyzers. This user guide details the operation of the Frequency Extension Module.

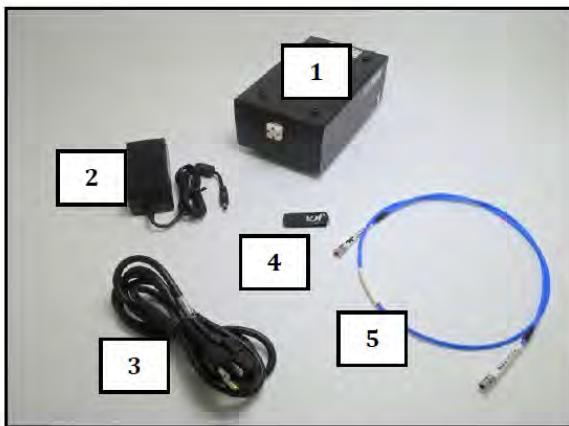

No.	Part Description
1	SAX 835
2	9V Power Supply
3	AC Power Cable
4	USB Drive
5	LO Cable (not included)

Figure 1: Photograph of typical configuration. All items may not be included.
Note: Photographs and specifications of accessories (horns, waveguide straights, etc.) are not included in this user guide.

2 Warning and Caution Statements

WARNING AND CAUTION STATEMENTS	
WARNING	This product can be permanently damaged by Electrostatic Discharge (ESD). It is recommended that engineers and technicians wear a special grounded wrist strap when handling this component. In addition, the work environment around the component should be well grounded.
WARNING	Opening the blocks, parts, or components will damage the internal components. VDI is not responsible for the warranty or guaranty of products damaged as a result of improper handling, testing, biasing, or use by customer.
CAUTION	VDI assumes the customer is familiar with microwave, millimeter wave, and VDI products. The user and customer are expected to understand all safety guidelines, health hazards, and general advisories that may exist and are associated with the use of this device. VDI is not responsible for any human hazards that may exist or may occur while using this device.

3 Product Specifications



USER GUIDE

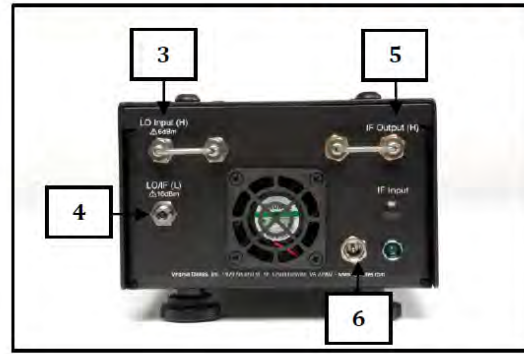
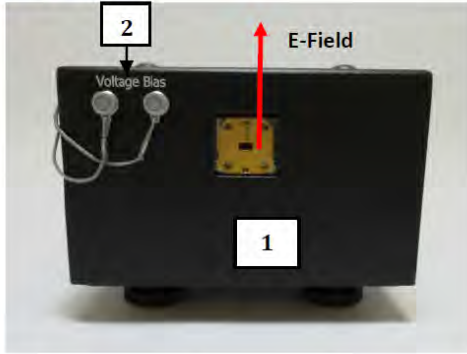

Description		Specification	Connector
RF Input [1]	Frequency Range	40-60GHz	WR19.0
	Power (Optimal / Damage)	<-20dBm / -10dBm	UG-599/UM
Voltage Bias Port [2]	External Component Bias Voltage	+9V Output 50mA Maximum	LEMO 00 (f)
LO Input High Freq. [3]	Frequency Range	20-30GHz	2.9mm(f)
	Power (Typical [†] / Damage)	0dBm / 16dBm	
	Multiplication Factor	2	
LO Input Standard Freq. [4]*	Frequency Range	10-15GHz	2.9mm(f)
	Power (Typical [†] / Damage)	13dBm / 20dBm	
	Multiplication Factor	4	
IF Output Standard Freq. [4]*	Frequency Range	100MHz-2.5GHz	2.9mm(f)
IF Output High Freq. [5]	Frequency Range	100MHz-6GHz	2.9mm(f)
DC Input [6]	DC Power Connection	9V Output, 5A Maximum	2.1mm I.D. x 5.5mm O.D. x 9.5mm Male
Intrinsic Mixer**	SSB Conversion Loss***	9dB	-
Displayed Average Noise Level***		-152dBm/Hz	-

Table 1: General product specifications are shown.
[†] System is operational within +/- 3dB of nominal input power.
 *Standard Freq. LO and IF share the same port.
 **Intrinsic mixer conversion loss is measured before any IF amplification and cannot be accessed by user.
 ***See Section 5 for actual performance.



USER GUIDE

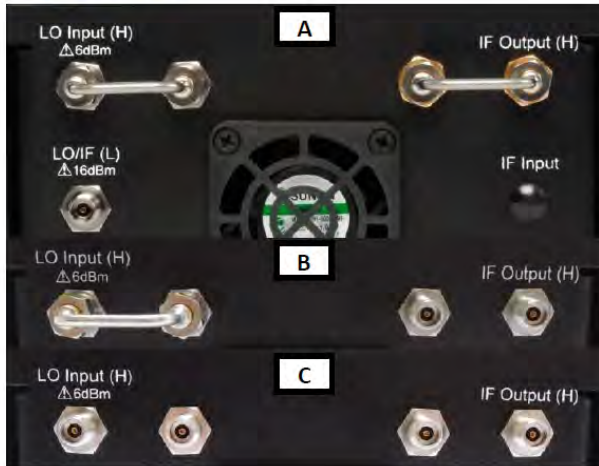

Configuration	LO Frequency	IF Frequency
A	Standard	Standard
B	Standard	High
C	High	High

Figure 2: Configuration details of dual LO input and dual IF output frequency modes are shown.

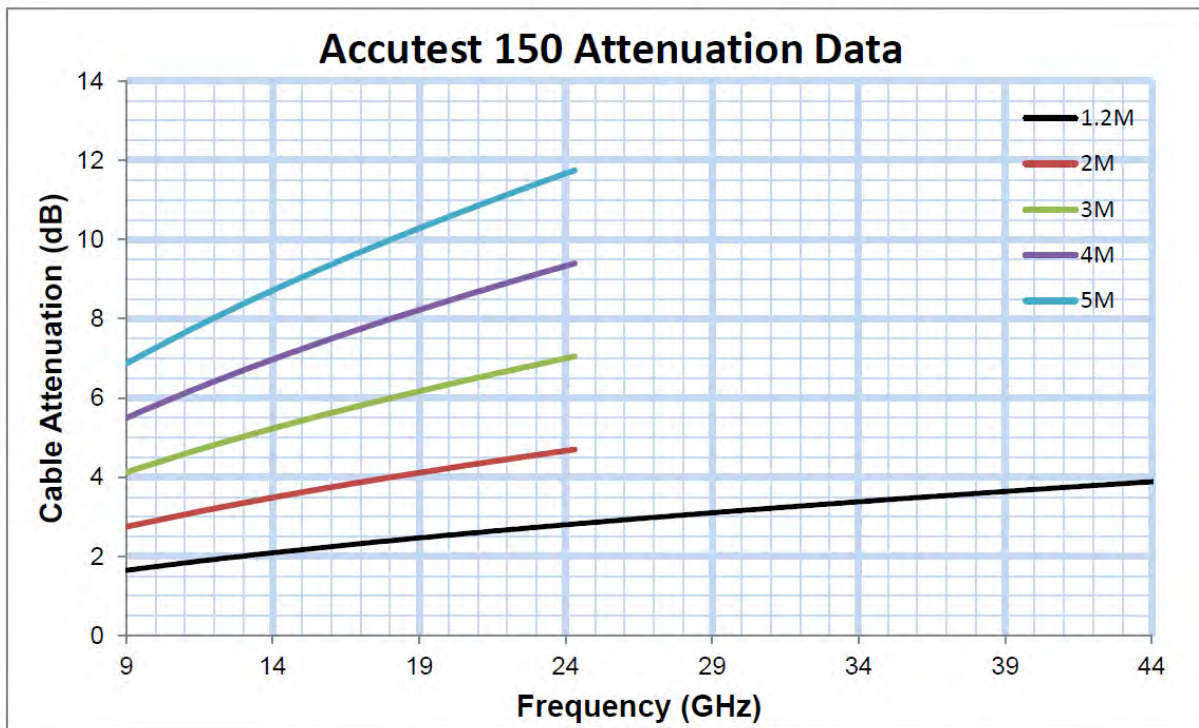

Figure 3: Insertion Loss of Accutest 150 (RF/LO Cable) with respect to frequency.



USER GUIDE

4 General Operating Procedures and Guidelines

VDI assumes the customer is familiar with VDI products, and VDI is not responsible for the warranty or guaranty of products damaged as a result of improper handling, testing, biasing, or use by customer. VDI offers the following general guidelines for using these products and recommends the customer contact VDI at (434) 297-3257 for assistance if needed. The following procedures are a quick guide for turning on and off the product. In each case the individual steps must be followed in the proper sequence to avoid damaging critical components.

4.1 Required Operating Procedures

- DO NOT exceed damage limits listed in Table 1.
- DO NOT apply any external biases to the system.
- Make proper RF connections depending on desired configuration (i.e. Standard/High LO and Standard/High IF operation). Refer to Figure 2A-C for more information.

Failure to follow these procedures will damage or destroy the device.

4.2 Additional Guidelines, Limitations, and Recommendations

- The SAX is shipped with a reusable dust cover attached. Remove dust cover before operation.

4.3 Turn-On Procedure

1. The user and test bench must be properly grounded and protected against ESD.
2. With the LO and RF input power turned off, make all necessary connections (i.e. LO cable, AC cable, DC cable). See Figure 2A-C for configuration details.
3. Turn on the LO input power.
4. Turn on the small signal RF input power and monitor the IF output.

4.4 Turn-Off Procedure

1. The user and test bench must be properly grounded and protected against ESD.
2. Turn off the RF input power.
3. Turn off the LO input power.
4. Disconnect the DC Power Supply.
5. After completing turn-off procedures described above, it is now safe to turn off all other equipment on user test bench.

Contact VDI with questions or concerns regarding operational procedures and limitations.



USER GUIDE

5 Product Performance

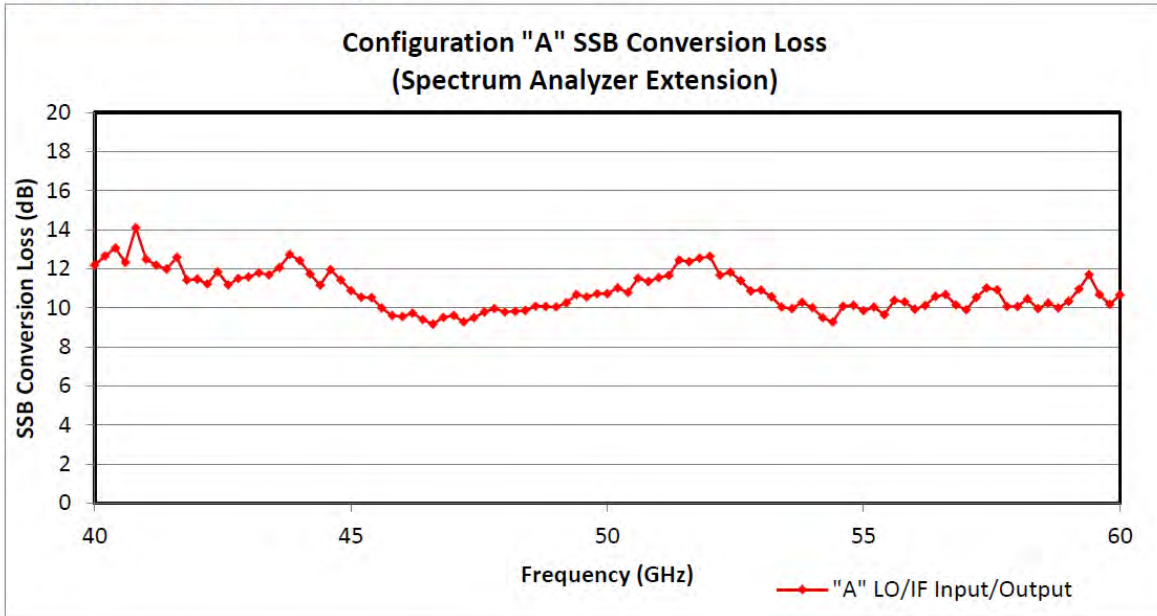

Figure 4: The product performance (SSB conversion loss vs. RF frequency) is shown for an LO input power of ~15dBm in Standard LO Frequency operation. IF power measured from "LO/IF" port with IF frequency fixed at 1.3GHz. CSV Data file included on USB Drive.

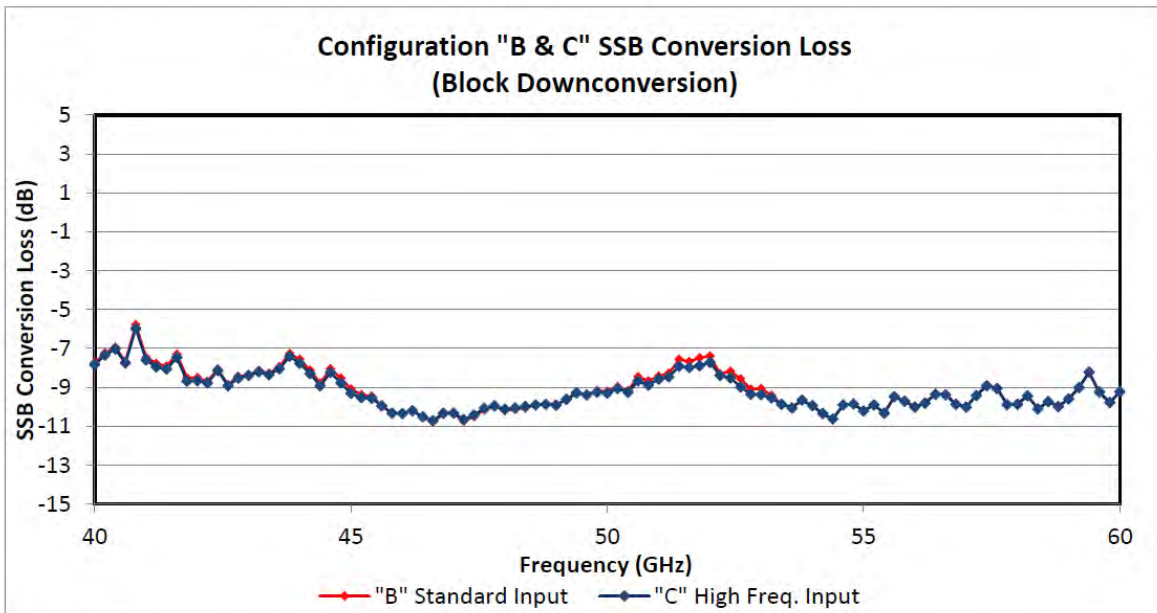

Figure 5: The product performance (SSB conversion loss vs. RF frequency) is shown for an LO input power of ~15dBm in Standard LO Frequency operation and LO input power of ~0dBm in High LO Frequency operation. IF power measured from "IF Output" port with IF frequency fixed at 1.3GHz. CSV Data file included on USB Drive.



USER GUIDE

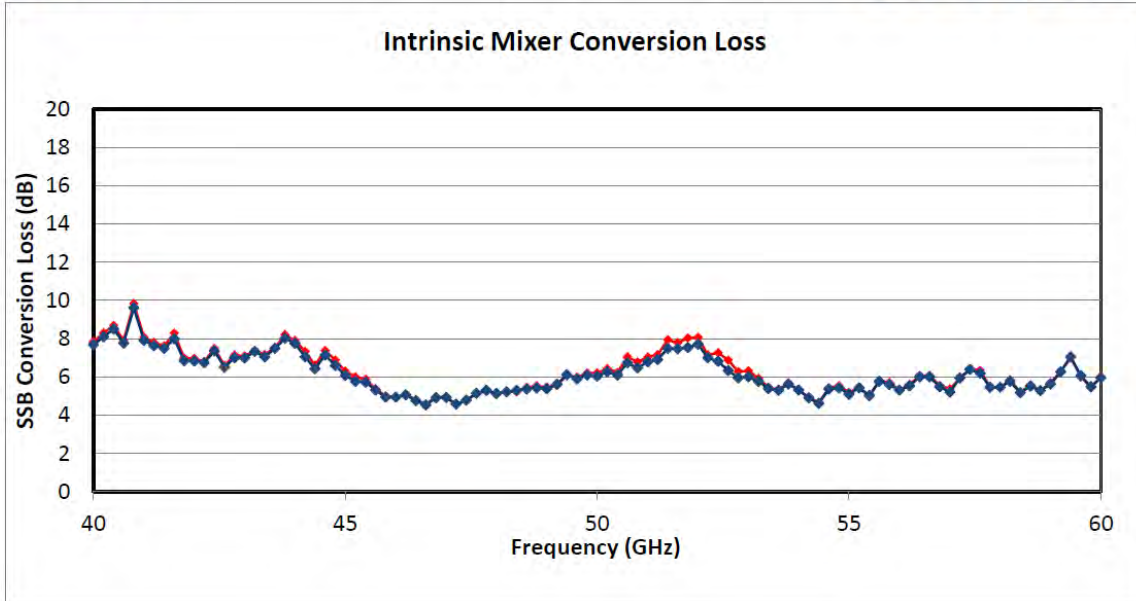

Figure 6: The product performance (SSB conversion loss vs. RF frequency) is shown for an LO input power of ~15dBm in Standard LO Frequency operation and LO input power of ~0dBm in High LO Frequency operation. IF power measured from mixer port with IF frequency fixed at 1.3GHz. Note: mixer port is not accessible for use by the user. CSV Data file included on USB Drive.

Measured Displayed Average Noise Level (dBm/Hz)	
Typical	-152.62

*Measured with a Keysight N9030A PXA Spectrum Analyzer.

Intertek

Report Number: 104689284BOX-001

Issued: 08/02/2021
Last Revised: 10/12/2021

SAX 835 Conversion Loss

Note: Out of band data is not guaranteed to be accurate

Freq(GHz)	"A" LO/IF Input/Output	"B" Standard Input	"C" High Freq. Input	High Freq. Intrinsic Mixer Loss	Standard Freq. Intrinsic Mixer Loss
40	12.18393	-7.73106531	-7.83106531	7.69093469	7.83793469
40.2	12.65257	-7.227428425	-7.346428425	8.089571575	8.295571575
40.4	13.04476	-6.935240346	-7.031240346	8.506759654	8.681759654
40.6	12.31643	-7.671565301	-7.756565301	7.763434699	7.913434699
40.8	14.09561	-5.784389207	-5.976389207	9.605610793	9.822610793
41	12.47222	-7.450776143	-7.586776143	7.911223857	8.075223857
41.2	12.17642	-7.766582166	-7.955582166	7.632417834	7.794417834
41.4	11.98468	-7.903316327	-8.068316327	7.491683673	7.628683673
41.6	12.58671	-7.300293808	-7.475293808	7.980706192	8.287706192
41.8	11.42126	-8.517743767	-8.682743767	6.840256233	6.992256233
42	11.46096	-8.504035139	-8.649035139	6.835964861	6.965964861
42.2	11.21847	-8.684527279	-8.781527279	6.735472721	6.799472721
42.4	11.83738	-8.055620485	-8.146620485	7.366379515	7.484379515
42.6	11.17569	-8.856309768	-8.917309768	6.502690232	6.599690232
42.8	11.49528	-8.435723496	-8.534723496	6.994276504	7.141276504
43	11.56904	-8.375963687	-8.395963687	6.987036313	7.103036313
43.2	11.79484	-8.120156119	-8.196156119	7.335843881	7.372843881
43.4	11.67951	-8.279490341	-8.364490341	7.050509659	7.176509659
43.6	12.05336	-7.943637944	-8.048637944	7.490362056	7.536362056
43.8	12.72018	-7.259817722	-7.400817722	8.024182278	8.205182278
44	12.40928	-7.555723107	-7.764723107	7.756276893	7.900276893
44.2	11.72591	-8.119091237	-8.296091237	7.052908763	7.335908763
44.4	11.15254	-8.774458098	-8.927458098	6.418541902	6.611541902
44.6	11.94911	-8.046893419	-8.235893419	7.146106581	7.381106581
44.8	11.41168	-8.535320915	-8.779320915	6.593679085	6.880679085
45	10.86545	-9.074546037	-9.315546037	6.077453963	6.296453963
45.2	10.52373	-9.371265586	-9.527265586	5.767734414	6.004734414
45.4	10.51426	-9.446741028	-9.563741028	5.714258972	5.882258972
45.6	9.986746	-9.939254477	-9.954254477	5.306745523	5.378745523
45.8	9.59202	-10.34998045	-10.33198045	4.939019546	4.994019546
46	9.54945	-10.34955021	-10.34255021	4.945449791	4.942449791
46.2	9.718601	-10.20139894	-10.20139894	5.06660106	5.08660106
46.4	9.4014	-10.51059989	-10.50859989	4.75540011	4.80640011
46.6	9.164813	-10.76618735	-10.72018735	4.525812655	4.559812655
46.8	9.49849	-10.37151002	-10.32451002	4.910489976	4.952489976
47	9.590663	-10.34933683	-10.32533683	4.919663167	4.930663167
47.2	9.264478	-10.73452184	-10.66252184	4.576478163	4.565478163

Intertek

Report Number: 104689284BOX-001

Issued: 08/02/2021
Last Revised: 10/12/2021

Freq(GHz)	"A" LO/IF Input/Output	"B" Standard Input	"C" High Freq. Input	High Freq. Intrinsic Mixer Loss	Standard Freq. Intrinsic Mixer Loss
47.4	9.487929	-10.49307072	-10.42707072	4.788929277	4.774929277
47.6	9.782794	-10.16320569	-10.07820569	5.142794307	5.116794307
47.8	9.95227	-9.987729761	-9.946729761	5.294270239	5.264270239
48	9.779821	-10.1941788	-10.1251788	5.128821195	5.129821195
48.2	9.817198	-10.11880169	-10.06180169	5.213198315	5.238198315
48.4	9.861049	-10.05895142	-9.99095142	5.29204858	5.22604858
48.6	10.07245	-9.889547923	-9.900547923	5.367452077	5.450452077
48.8	10.07077	-9.841233026	-9.876233026	5.424766974	5.527766974
49	10.02539	-9.862610661	-9.921610661	5.379389339	5.465389339
49.2	10.24586	-9.671136617	-9.615136617	5.606863383	5.561863383
49.4	10.6675	-9.289503278	-9.286503278	6.107496722	6.065496722
49.6	10.5412	-9.356800369	-9.393800369	5.891199631	5.991199631
49.8	10.71795	-9.170051536	-9.242051536	6.089948464	6.211948464
50	10.72015	-9.202846251	-9.294846251	6.036153749	6.207153749
50.2	11.01845	-8.967548981	-9.055548981	6.261451019	6.439451019
50.4	10.78694	-9.175059654	-9.246059654	6.097940346	6.231940346
50.6	11.51114	-8.446861426	-8.672861426	6.740138574	7.043138574
50.8	11.34446	-8.666536526	-8.891536526	6.471463474	6.789463474
51	11.54523	-8.420770486	-8.581770486	6.787229514	7.028229514
51.2	11.64424	-8.273764545	-8.461764545	6.912235455	7.159235455
51.4	12.45045	-7.554554578	-7.923554578	7.493445422	7.940445422
51.6	12.34762	-7.672378642	-7.986378642	7.465621358	7.783621358
51.8	12.53203	-7.48396897	-7.88396897	7.53103103	8.03103103
52	12.63471	-7.392294596	-7.710294596	7.710705404	8.068705404
52.2	11.66922	-8.296777367	-8.395777367	6.998222633	7.135222633
52.4	11.82163	-8.176370856	-8.512370856	6.820629144	7.266629144
52.6	11.38115	-8.567850502	-8.981850502	6.324149498	6.876149498
52.8	10.85834	-9.088660283	-9.362660283	5.949339717	6.282339717
53	10.90889	-9.054111321	-9.370111321	6.000888679	6.315888679
53.2	10.55653	-9.398471843	-9.553471843	5.768528157	5.922528157
53.4	10.02485	-9.857147743	-9.879147743	5.394852257	5.452852257
53.6	9.957231	-10.00976887	-10.05476887	5.300231127	5.343231127
53.8	10.28107	-9.656928444	-9.648928444	5.624071556	5.671071556
54	10.00557	-9.945426854	-9.944426854	5.313573147	5.316573147
54.2	9.483862	-10.38213777	-10.35113777	4.90986223	4.92486223
54.4	9.27475	-10.63425049	-10.62325049	4.602749509	4.658749509
54.6	10.07448	-9.899524203	-9.899524203	5.357475797	5.419475797
54.8	10.12309	-9.847914944	-9.861914944	5.428085056	5.530085056
55	9.843976	-10.19002385	-10.21402385	5.092976146	5.194976146
55.2	10.03561	-9.908389973	-9.910389973	5.416610027	5.438610027
55.4	9.643359	-10.31664094	-10.33464094	5.038359057	4.973359057

Intertek

Report Number: 104689284BOX-001

Issued: 08/02/2021
Last Revised: 10/12/2021

Freq(GHz)	"A" LO/IF Input/Output	"B" Standard Input	"C" High Freq. Input	High Freq. Intrinsic Mixer Loss	Standard Freq. Intrinsic Mixer Loss
55.6	10.37222	-9.49677748	-9.48777748	5.76322252	5.79722252
55.8	10.30295	-9.680049143	-9.713049143	5.588950857	5.707950857
56	9.930571	-10.00042911	-10.01842911	5.310570886	5.301570886
56.2	10.10271	-9.786290637	-9.816290637	5.528709363	5.602709363
56.4	10.57445	-9.318550175	-9.357550175	6.002449825	6.064449825
56.6	10.66912	-9.349881086	-9.393881086	6.004118914	6.076118914
56.8	10.14375	-9.840248304	-9.875248304	5.478751696	5.545751696
57	9.894501	-9.992499215	-10.01649921	5.211500785	5.371500785
57.2	10.52904	-9.407962195	-9.419962195	5.934037805	5.908037805
57.4	11.01629	-8.88670661	-8.91570661	6.39329339	6.41629339
57.6	10.9171	-9.033897975	-9.064897975	6.195102025	6.348102025
57.8	10.05695	-9.8670484	-9.8830484	5.4619516	5.4749516
58	10.06586	-9.834143573	-9.880143573	5.457856427	5.450856427
58.2	10.45513	-9.422873675	-9.434873675	5.770126325	5.841126325
58.4	9.959582	-10.09041812	-10.10741812	5.165581881	5.204581881
58.6	10.23535	-9.720652896	-9.738652896	5.511347104	5.584347104
58.8	9.987653	-9.967346763	-9.989346763	5.289653237	5.282653237
59	10.32975	-9.594251231	-9.600251231	5.624748769	5.691748769
59.2	10.94742	-9.004582916	-9.007582916	6.263417084	6.266417084
59.4	11.69635	-8.21964914	-8.21264914	7.04235086	7.01935086
59.6	10.67157	-9.294432287	-9.235432287	6.069567713	6.001567713
59.8	10.16657	-9.771428462	-9.783428462	5.485571538	5.447571538
60	10.64813	-9.237874856	-9.223874856	5.947125144	6.016125144

60-90 GHz Mixer Conversion Loss



USER GUIDE

WR12.0SAX-F

1 Product Overview

Product List (Quantity)	Serial Number(s)	Order No.	Date / Initials
WR12.0SAX-F (1)	SAX 836	21108B	04/06/2021 CXS

Product Description: This VDI product includes one WR12.0 Frequency Extender, intended for use with Rohde & Schwarz FSW spectrum analyzers. This user guide details the operation of the Frequency Extension Module.

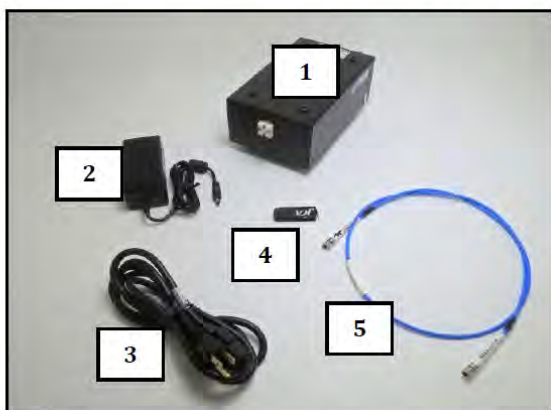

No.	Part Description
1	SAX 836
2	9V Power Supply
3	AC Power Cable
4	USB Drive
5	LO Cable (not included)

Figure 1: Photograph of typical configuration. All items may not be included.
Note: Photographs and specifications of accessories (horns, waveguide straights, etc.) are not included in this user guide.

2 Warning and Caution Statements

WARNING AND CAUTION STATEMENTS	
WARNING	This product can be permanently damaged by Electrostatic Discharge (ESD). It is recommended that engineers and technicians wear a special grounded wrist strap when handling this component. In addition, the work environment around the component should be well grounded.
WARNING	Opening the blocks, parts, or components will damage the internal components. VDI is not responsible for the warranty or guaranty of products damaged as a result of improper handling, testing, biasing, or use by customer.
CAUTION	VDI assumes the customer is familiar with microwave, millimeter wave, and VDI products. The user and customer are expected to understand all safety guidelines, health hazards, and general advisories that may exist and are associated with the use of this device. VDI is not responsible for any human hazards that may exist or may occur while using this device.

3 Product Specifications



USER GUIDE

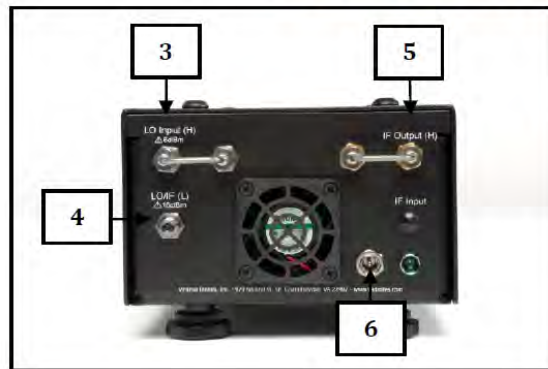
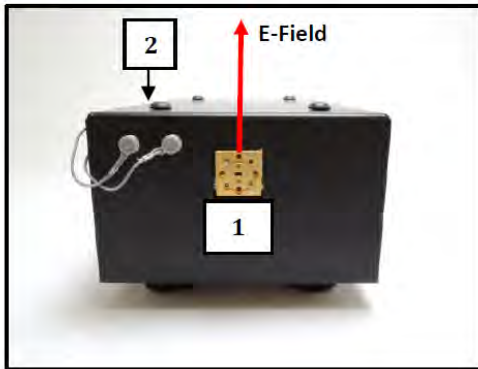

Description		Specification	Connector
RF Input [1]	Frequency Range	60-90GHz	WR12.0
	Power (Optimal / Damage)	<-20dBm / -10dBm	UG-599/UM
Voltage Bias Port [2]	External Component Bias Voltage	+9V Output 50mA Maximum	LEMO 00 (f)
LO Input High Freq. [3]	Frequency Range	10-15GHz	2.9mm(f)
	Power (Typical [†] / Damage)	0dBm / 16dBm	
	Multiplication Factor	6	
LO Input Standard Freq. [4]*	Frequency Range	10-15GHz	2.9mm(f)
	Power (Typical [†] / Damage)	13dBm / 20dBm	
	Multiplication Factor	6	
IF Output Standard Freq. [4]*	Frequency Range	100MHz-2.5GHz	2.9mm(f)
IF Output High Freq. [5]	Frequency Range	100MHz-9GHz	2.9mm(f)
DC Input [6]	DC Power Connection	9V Output, 5A Maximum	2.1mm I.D. x 5.5mm O.D. x 9.5mm Male
Intrinsic Mixer**	SSB Conversion Loss***	10dB	-
Displayed Average Noise Level***		-152dBm/Hz	-

Table 1: General product specifications are shown.

[†] System is operational within +/- 3dB of nominal input power.

*Standard Freq. LO and IF share the same port.

**Intrinsic mixer conversion loss is measured before any IF amplification and cannot be accessed by user.

***See Section 5 for actual performance.



USER GUIDE

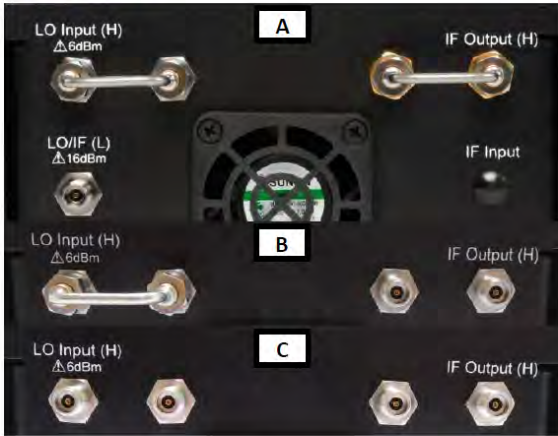

Configuration	LO Frequency	IF Frequency
A	Standard	Standard
B	Standard	High
C	High	High

Figure 2: Configuration details of dual LO input and dual IF output frequency modes are shown.

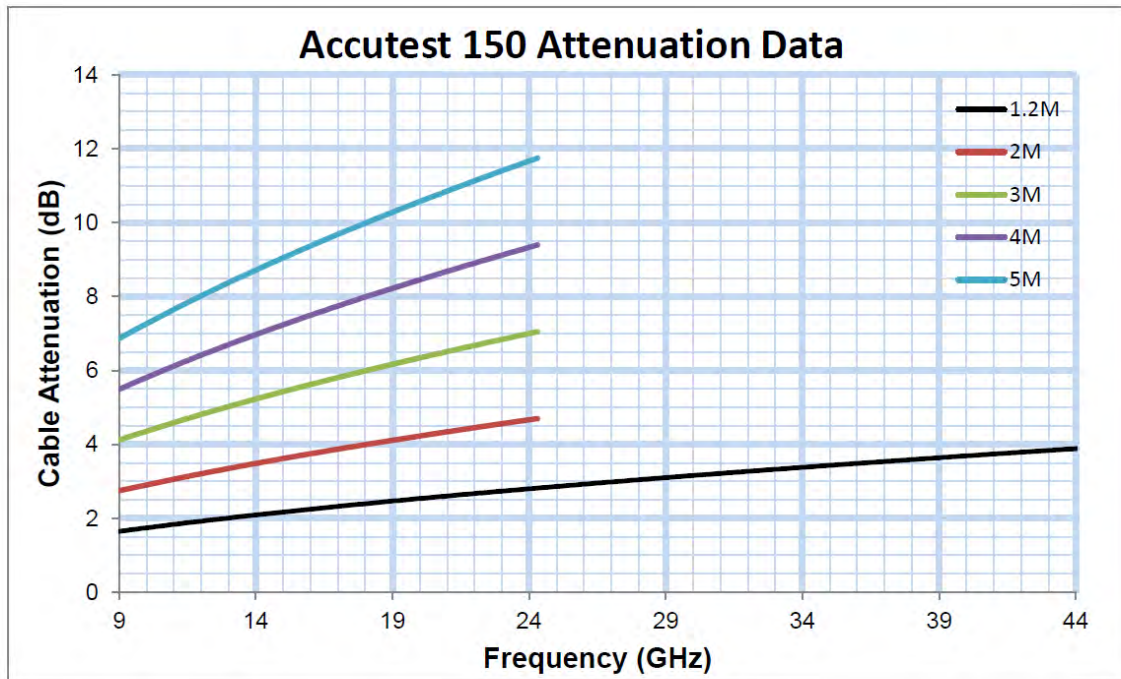

Figure 3: Insertion Loss of Accutest 150 (RF/LO Cable) with respect to frequency.



USER GUIDE

4 General Operating Procedures and Guidelines

VDI assumes the customer is familiar with VDI products, and VDI is not responsible for the warranty or guaranty of products damaged as a result of improper handling, testing, biasing, or use by customer. VDI offers the following general guidelines for using these products and recommends the customer contact VDI at (434) 297-3257 for assistance if needed. The following procedures are a quick guide for turning on and off the product. In each case the individual steps must be followed in the proper sequence to avoid damaging critical components.

4.1 Required Operating Procedures

- DO NOT exceed damage limits listed in Table 1.
- DO NOT apply any external biases to the system.
- Make proper RF connections depending on desired configuration (i.e. Standard/High LO and Standard/High IF operation). Refer to Figure 2A-C for more information.

Failure to follow these procedures will damage or destroy the device.

4.2 Additional Guidelines, Limitations, and Recommendations

- The SAX is shipped with a reusable dust cover attached. Remove dust cover before operation.

4.3 Turn-On Procedure

1. The user and test bench must be properly grounded and protected against ESD.
2. With the LO and RF input power turned off, make all necessary connections (i.e. LO cable, AC cable, DC cable). See Figure 2A-C for configuration details.
3. Turn on the LO input power.
4. Turn on the small signal RF input power and monitor the IF output.

4.4 Turn-Off Procedure

1. The user and test bench must be properly grounded and protected against ESD.
2. Turn off the RF input power.
3. Turn off the LO input power.
4. Disconnect the DC Power Supply.
5. After completing turn-off procedures described above, it is now safe to turn off all other equipment on user test bench.

Contact VDI with questions or concerns regarding operational procedures and limitations.



USER GUIDE

5 Product Performance

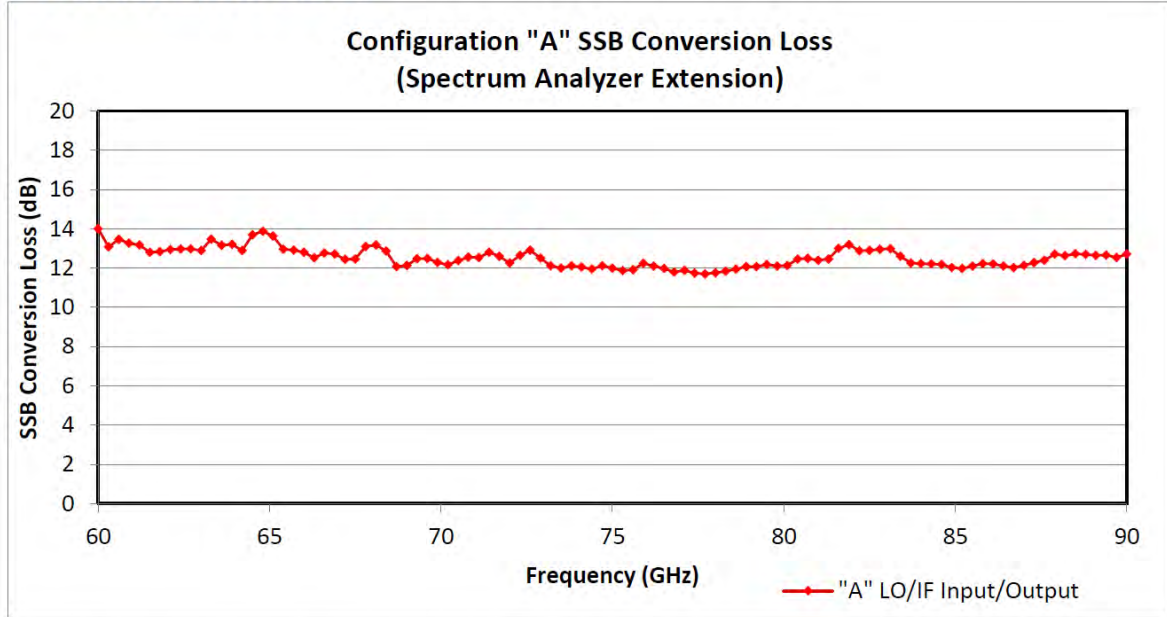

Figure 4: The product performance (SSB conversion loss vs. RF frequency) is shown for an LO input power of ~15dBm in Standard LO Frequency operation. IF power measured from "LO/IF" port with IF frequency fixed at 1.3GHz. CSV Data file included on USB Drive.

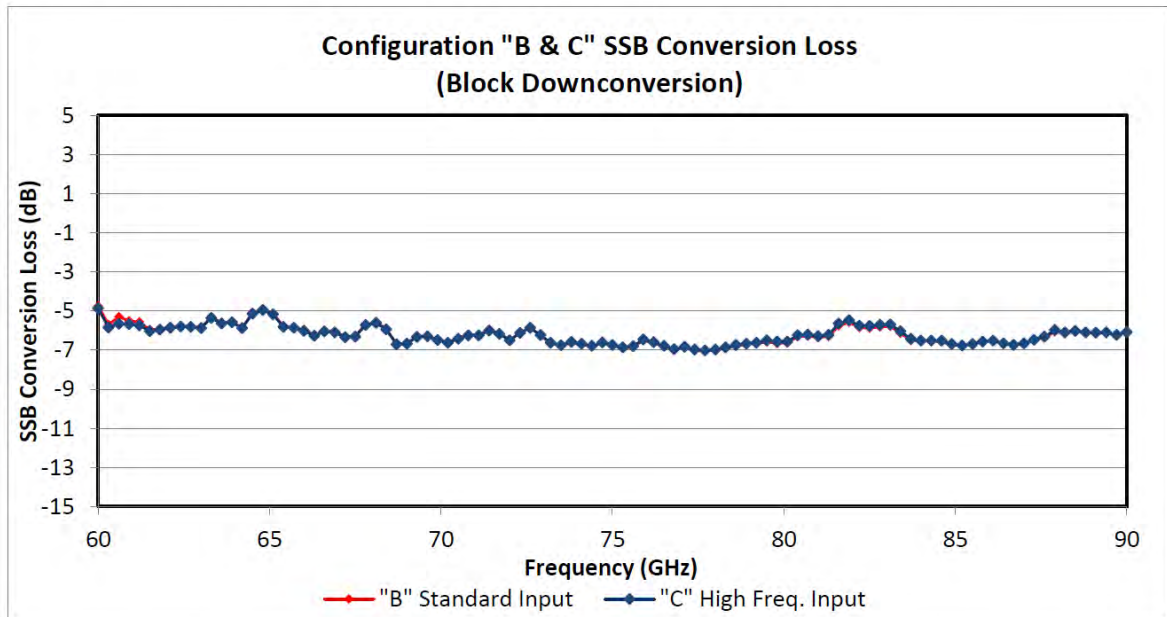

Figure 5: The product performance (SSB conversion loss vs. RF frequency) is shown for an LO input power of ~15dBm in Standard LO Frequency operation and LO input power of ~0dBm in High LO Frequency operation. IF power measured from "IF Output" port with IF frequency fixed at 1.3GHz. CSV Data file included on USB Drive.



USER GUIDE

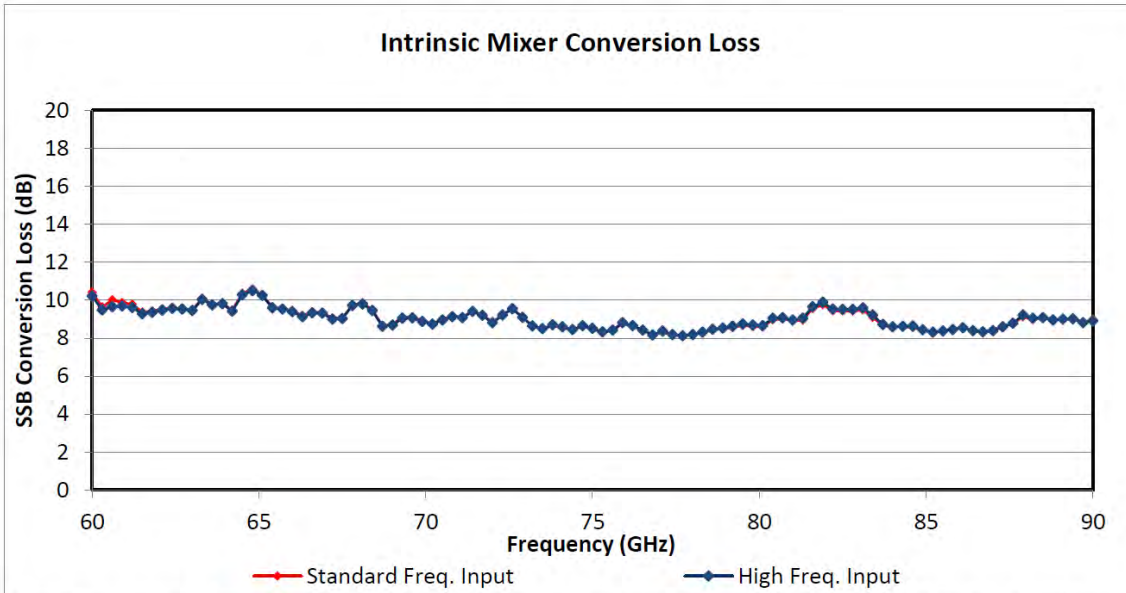

Figure 6: The product performance (SSB conversion loss vs. RF frequency) is shown for an LO input power of ~15dBm in Standard LO Frequency operation and LO input power of ~0dBm in High LO Frequency operation. IF power measured from mixer port with IF frequency fixed at 1.3GHz. Note: mixer port is not accessible for use by the user. CSV Data file included on USB Drive.

Measured Displayed Average Noise Level (dBm/Hz)	
Typical	-150.65

*Measured with a Keysight N9030A PXA Spectrum Analyzer.

Intertek

Report Number: 104689284BOX-001

Issued: 08/02/2021
Last Revised: 10/12/2021

SAX 836 Conversion Loss

Note: Out of band data is not guaranteed to be accurate

Freq(GHz)	"A" LO/IF Input/Output	"B" Standard Input	"C" High Freq. Input	High Freq. Intrinsic Mixer Loss	Standard Freq. Intrinsic Mixer Loss
60	14.00809673	-4.74690327	-4.86490327	10.22409673	10.40709673
60.3	13.08177247	-5.686227526	-5.842227526	9.482772474	9.645772474
60.6	13.44988267	-5.300117334	-5.655117334	9.656882666	10.01088267
60.9	13.26543128	-5.497568718	-5.666568718	9.689431282	9.877431282
61.2	13.17933468	-5.566665317	-5.739665317	9.610334683	9.782334683
61.5	12.80009579	-5.949904212	-6.025904212	9.275095788	9.380095788
61.8	12.82914386	-5.919856141	-5.953856141	9.363143859	9.427143859
62.1	12.94303505	-5.816964953	-5.851964953	9.468035047	9.537035047
62.4	12.97887686	-5.769123137	-5.797123137	9.562876863	9.595876863
62.7	12.96847511	-5.790524891	-5.806524891	9.521475109	9.549475109
63	12.90047744	-5.846522559	-5.880522559	9.443477441	9.500477441
63.3	13.47453136	-5.305468637	-5.358468637	10.03153136	10.09053136
63.6	13.16719015	-5.597809855	-5.631809855	9.743190145	9.784190145
63.9	13.21223698	-5.54176302	-5.57776302	9.80323698	9.83423698
64.2	12.89882197	-5.858178027	-5.877178027	9.423821973	9.472821973
64.5	13.68621534	-5.074784662	-5.137784662	10.27721534	10.35121534
64.8	13.87468986	-4.891310145	-4.952310145	10.50468986	10.58768986
65.1	13.63537185	-5.11962815	-5.16362815	10.24337185	10.29937185
65.4	12.96383529	-5.779164713	-5.809164713	9.594835287	9.641835287
65.7	12.90818146	-5.823818544	-5.864818544	9.523181456	9.563181456
66	12.79905144	-5.948948563	-6.018948563	9.387051437	9.445051437
66.3	12.52625358	-6.224746423	-6.264746423	9.128253577	9.178253577
66.6	12.77501349	-6.002986511	-6.044986511	9.332013489	9.386013489
66.9	12.70577709	-6.056222906	-6.098222906	9.304777094	9.340777094
67.2	12.44844547	-6.298554532	-6.348554532	8.999445468	9.058445468
67.5	12.45771307	-6.27928693	-6.30628693	9.03571307	9.05871307
67.8	13.09446348	-5.662536517	-5.710536517	9.711463483	9.745463483
68.1	13.18159215	-5.574407845	-5.614407845	9.789592155	9.842592155
68.4	12.86269872	-5.889301275	-5.932301275	9.452698725	9.498698725
68.7	12.06465654	-6.679343461	-6.704343461	8.624656539	8.651656539
69	12.12697909	-6.634020906	-6.663020906	8.681979094	8.730979094
69.3	12.47379099	-6.275209006	-6.320209006	9.048790994	9.109790994
69.6	12.49635632	-6.266643679	-6.302643679	9.061356321	9.119356321
69.9	12.29461412	-6.451385875	-6.487385875	8.877614125	8.913614125
70.2	12.15951216	-6.599487841	-6.628487841	8.725512159	8.760512159
70.5	12.38334399	-6.369656014	-6.416656014	8.946343986	8.999343986
70.8	12.55179008	-6.206209925	-6.243209925	9.126790075	9.154790075

Intertek

Report Number: 104689284BOX-001

Issued: 08/02/2021
Last Revised: 10/12/2021

Freq(GHz)	"A" LO/IF Input/Output	"B" Standard Input	"C" High Freq. Input	High Freq. Intrinsic Mixer Loss	Standard Freq. Intrinsic Mixer Loss
71.1	12.53542905	-6.22657095	-6.25057095	9.07142905	9.11942905
71.4	12.80331874	-5.95168126	-6.00068126	9.40331874	9.41931874
71.7	12.59441785	-6.142582148	-6.177582148	9.194417852	9.228417852
72	12.26506093	-6.485939069	-6.497939069	8.817060931	8.831060931
72.3	12.6529332	-6.105066802	-6.130066802	9.223933198	9.253933198
72.6	12.91123601	-5.84176399	-5.85376399	9.54023601	9.55323601
72.9	12.50543192	-6.253568082	-6.234568082	9.097431918	9.095431918
73.2	12.12384684	-6.638153158	-6.616153158	8.645846842	8.647846842
73.5	11.99820018	-6.767799823	-6.748799823	8.497200177	8.484200177
73.8	12.11430193	-6.643698071	-6.582698071	8.701301929	8.647301929
74.1	12.05944184	-6.710558164	-6.669558164	8.594441836	8.540441836
74.4	11.94565033	-6.811349671	-6.778349671	8.456650329	8.429650329
74.7	12.11754896	-6.642451036	-6.607451036	8.659548964	8.623548964
75	11.99113212	-6.768867875	-6.733867875	8.506132125	8.483132125
75.3	11.86630909	-6.900690911	-6.860690911	8.333309089	8.310309089
75.6	11.91810032	-6.838899678	-6.798899678	8.423100322	8.401100322
75.9	12.24548213	-6.500517867	-6.451517867	8.808482133	8.772482133
76.2	12.10239893	-6.643601074	-6.590601074	8.650398926	8.617398926
76.5	11.98551471	-6.789485292	-6.773485292	8.417514708	8.412514708
76.8	11.79713504	-6.968864956	-6.945864956	8.175135044	8.189135044
77.1	11.88064822	-6.869351775	-6.824351775	8.367648225	8.314648225
77.4	11.7419614	-7.018038601	-6.974038601	8.182961399	8.171961399
77.7	11.70070307	-7.05529693	-7.02129693	8.12070307	8.12070307
78	11.75970185	-6.99429815	-6.96829815	8.18070185	8.17970185
78.3	11.84442873	-6.900571271	-6.854571271	8.310428729	8.287428729
78.6	11.95018765	-6.799812349	-6.734812349	8.461187651	8.414187651
78.9	12.06854076	-6.706459237	-6.665459237	8.532540763	8.518540763
79.2	12.07851172	-6.674488276	-6.618488276	8.626511724	8.567511724
79.5	12.18083903	-6.574160969	-6.495160969	8.753839031	8.672839031
79.8	12.10740792	-6.654592085	-6.567592085	8.682407915	8.602407915
80.1	12.12624941	-6.617750592	-6.567750592	8.650249408	8.586249408
80.4	12.45676064	-6.305239365	-6.226239365	9.050760635	8.968760635
80.7	12.49277424	-6.273225761	-6.198225761	9.072774239	9.015774239
81	12.39938675	-6.35061325	-6.28161325	8.95738675	8.90238675
81.3	12.46230193	-6.292698068	-6.222698068	9.038301932	8.952301932
81.6	13.00393377	-5.757066234	-5.633066234	9.655933766	9.553933766
81.9	13.1857019	-5.5832981	-5.4612981	9.8847019	9.7637019
82.2	12.87742475	-5.848575252	-5.743575252	9.531424748	9.429424748
82.5	12.89518705	-5.867812949	-5.763812949	9.519187051	9.423187051
82.8	12.95150506	-5.81749494	-5.70349494	9.52050506	9.42650506
83.1	12.98575567	-5.77524433	-5.68224433	9.59075567	9.47675567

Intertek

Report Number: 104689284BOX-001

Issued: 08/02/2021
Last Revised: 10/12/2021

Freq(GHz)	"A" LO/IF Input/Output	"B" Standard Input	"C" High Freq. Input	High Freq. Intrinsic Mixer Loss	Standard Freq. Intrinsic Mixer Loss
83.4	12.59718822	-6.140811779	-6.029811779	9.215188221	9.091188221
83.7	12.25796009	-6.493039911	-6.419039911	8.712960089	8.670960089
84	12.23114021	-6.524859786	-6.506859786	8.586140214	8.569140214
84.3	12.20708834	-6.540911658	-6.506911658	8.629088342	8.584088342
84.6	12.18133493	-6.580665066	-6.515665066	8.645334934	8.565334934
84.9	12.01835551	-6.731644488	-6.691644488	8.437355512	8.409355512
85.2	11.97910956	-6.769890438	-6.757890438	8.310109562	8.331109562
85.5	12.09929486	-6.662705139	-6.685705139	8.368294861	8.384294861
85.8	12.22092835	-6.529071647	-6.559071647	8.449928353	8.487928353
86.1	12.21270567	-6.532294329	-6.513294329	8.549705671	8.545705671
86.4	12.10955656	-6.659443442	-6.661443442	8.391556558	8.413556558
86.7	12.01941635	-6.735583651	-6.734583651	8.320416349	8.351416349
87	12.12790597	-6.652094034	-6.659094034	8.388905966	8.431905966
87.3	12.2779043	-6.474095698	-6.469095698	8.598904302	8.628904302
87.6	12.39380025	-6.359199748	-6.316199748	8.776800252	8.773800252
87.9	12.70905543	-6.059944574	-5.963944574	9.212055426	9.121055426
88.2	12.63644451	-6.145555491	-6.093555491	9.051444509	8.987444509
88.5	12.72378687	-6.047213129	-6.017213129	9.075786871	9.078786871
88.8	12.69878056	-6.070219442	-6.093219442	8.943780558	8.993780558
89.1	12.64415049	-6.140849508	-6.113849508	8.990150492	8.997150492
89.4	12.66086495	-6.119135052	-6.096135052	9.011864948	9.040864948
89.7	12.54474949	-6.223250512	-6.212250512	8.804749488	8.861749488
90	12.70351072	-6.062489285	-6.075489285	8.899510715	8.976510715

90-140 GHz Mixer Conversion Loss



USER GUIDE

WR8.0SAX-F

1 Product Overview

Product List (Quantity)	Serial Number(s)	Order No.	Date / Initials
WR8.0SAX-F (1)	SAX 837	21108C	06/10/2021 DNS

Product Description: This VDI product includes one WR8.0 Frequency Extender, intended for use with Rohde & Schwarz FSW spectrum analyzers. This user guide details the operation of the Frequency Extension Module.

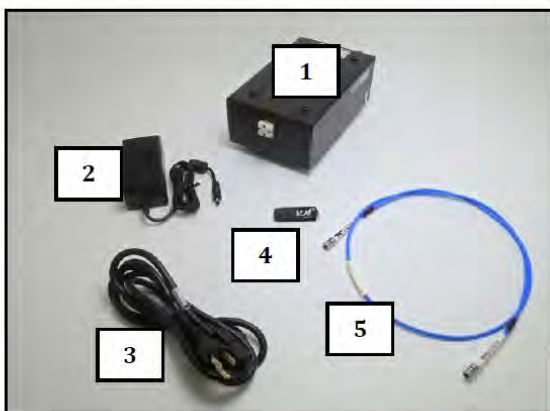

No.	Part Description
1	SAX 837
2	9V Power Supply
3	AC Power Cable
4	USB Drive
5	LO Cable (not included)

Figure 1: Photograph of typical configuration. All items may not be included.
Note: Photographs and specifications of accessories (horns, waveguide straights, etc.) are not included in this user guide.

2 Warning and Caution Statements

WARNING AND CAUTION STATEMENTS	
WARNING	This product can be permanently damaged by Electrostatic Discharge (ESD). It is recommended that engineers and technicians wear a special grounded wrist strap when handling this component. In addition, the work environment around the component should be well grounded.
WARNING	Opening the blocks, parts, or components will damage the internal components. VDI is not responsible for the warranty or guaranty of products damaged as a result of improper handling, testing, biasing, or use by customer.
CAUTION	VDI assumes the customer is familiar with microwave, millimeter wave, and VDI products. The user and customer are expected to understand all safety guidelines, health hazards, and general advisories that may exist and are associated with the use of this device. VDI is not responsible for any human hazards that may exist or may occur while using this device.

3 Product Specifications



USER GUIDE

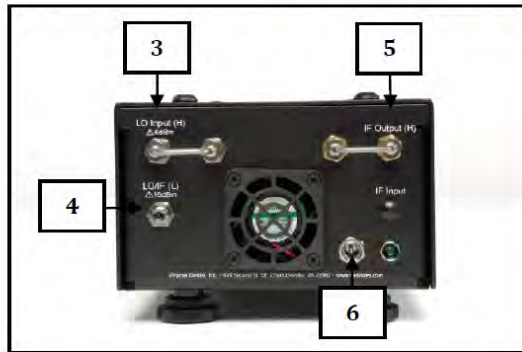
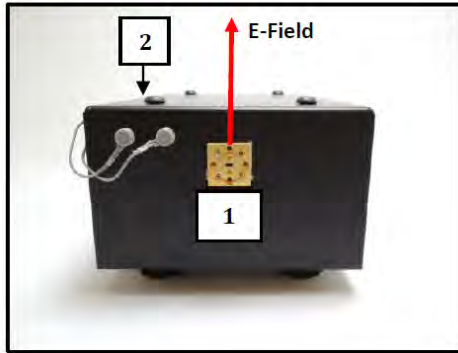

Description		Specification	Connector
RF Input [1]	Frequency Range	90-140GHz	WR8.0
	Power (Optimal / Damage)	<-20dBm / -10dBm	UG-599/UM
Voltage Bias Port [2]	External Component Bias Voltage	+9V Output 50mA Maximum	LEMO 00 (f)
LO Input High Freq. [3]	Frequency Range	30-46.67GHz	2.9mm(f)
	Power (Typical† / Damage)	0dBm / 6dBm	
	Multiplication Factor	3	
LO Input Standard Freq. [4]*	Frequency Range	10-15.56GHz	2.9mm(f)
	Power (Typical† / Damage)	13dBm / 20dBm	
	Multiplication Factor	9	
IF Output Standard Freq. [4]*	Frequency Range	100MHz-2.5GHz	2.9mm(f)
IF Output High Freq. [5]	Frequency Range	100MHz-14GHz	2.9mm(f)
DC Input [6]	DC Power Connection	9V Output, 5A Maximum	2.1mm I.D. x 5.5mm O.D. x 9.5mm Male
Intrinsic Mixer**	SSB Conversion Loss***	10dB	-
Displayed Average Noise Level***		-150dBm/Hz	-

Table 1: General product specifications are shown.
 † System is operational within +/- 3dB of nominal input power.
 *Standard Freq. LO and IF share the same port.
 **Intrinsic mixer conversion loss is measured before any IF amplification and cannot be accessed by user.
 ***See Section 5 for actual performance.



USER GUIDE

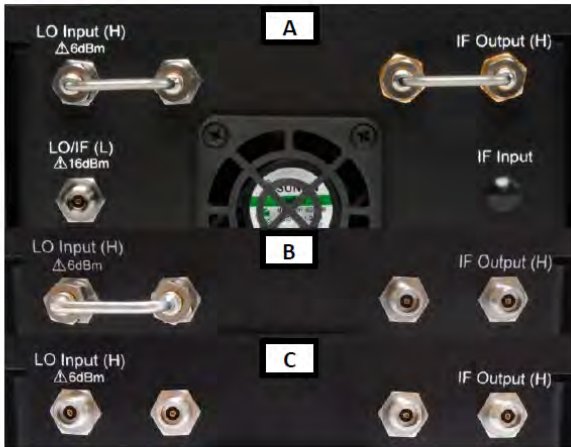

Configuration	LO Frequency	IF Frequency
A	Standard	Standard
B	Standard	High
C	High	High

Figure 2: Configuration details of dual LO input and dual IF output frequency modes are shown.

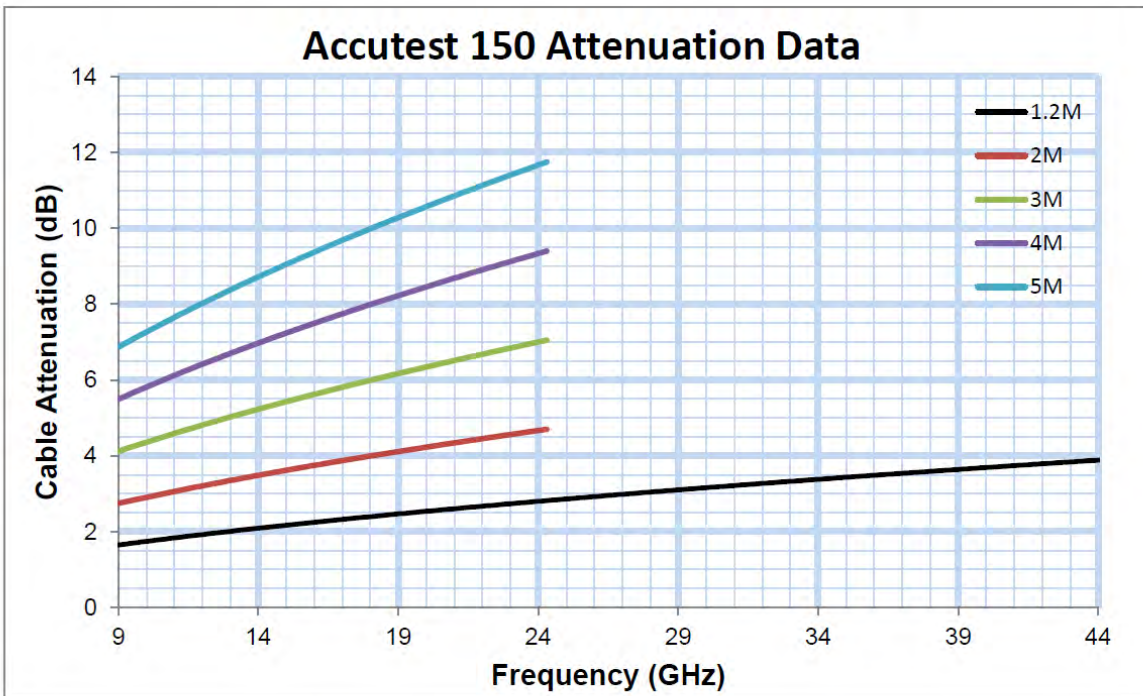

Figure 3: Insertion Loss of Accutest 150 (RF/LO Cable) with respect to frequency.



USER GUIDE

4 General Operating Procedures and Guidelines

VDI assumes the customer is familiar with VDI products, and VDI is not responsible for the warranty or guaranty of products damaged as a result of improper handling, testing, biasing, or use by customer. VDI offers the following general guidelines for using these products and recommends the customer contact VDI at (434) 297-3257 for assistance if needed. The following procedures are a quick guide for turning on and off the product. In each case the individual steps must be followed in the proper sequence to avoid damaging critical components.

4.1 Required Operating Procedures

- DO NOT exceed damage limits listed in Table 1.
- DO NOT apply any external biases to the system.
- Make proper RF connections depending on desired configuration (i.e. Standard/High LO and Standard/High IF operation). Refer to Figure 2A-C for more information.

Failure to follow these procedures will damage or destroy the device.

4.2 Additional Guidelines, Limitations, and Recommendations

- The SAX is shipped with a reusable dust cover attached. Remove dust cover before operation.

4.3 Turn-On Procedure

1. The user and test bench must be properly grounded and protected against ESD.
2. With the LO and RF input power turned off, make all necessary connections (i.e. LO cable, AC cable, DC cable). See Figure 2A-C for configuration details.
3. Turn on the LO input power.
4. Turn on the small signal RF input power and monitor the IF output.

4.4 Turn-Off Procedure

1. The user and test bench must be properly grounded and protected against ESD.
2. Turn off the RF input power.
3. Turn off the LO input power.
4. Disconnect the DC Power Supply.
5. After completing turn-off procedures described above, it is now safe to turn off all other equipment on user test bench.

Contact VDI with questions or concerns regarding operational procedures and limitations.



USER GUIDE

5 Product Performance

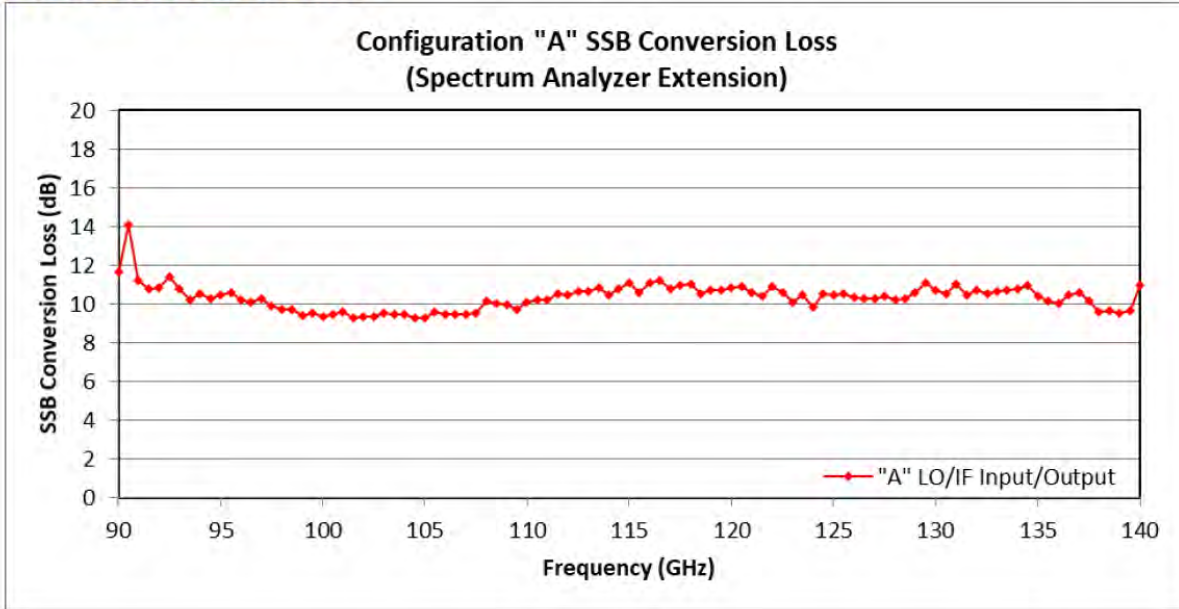

Figure 4: The product performance (SSB conversion loss vs. RF frequency) is shown for an LO input power of ~15dBm in Standard LO Frequency operation. IF power measured from "LO/IF" port with IF frequency fixed at 1.3GHz. CSV Data file included on USB Drive.

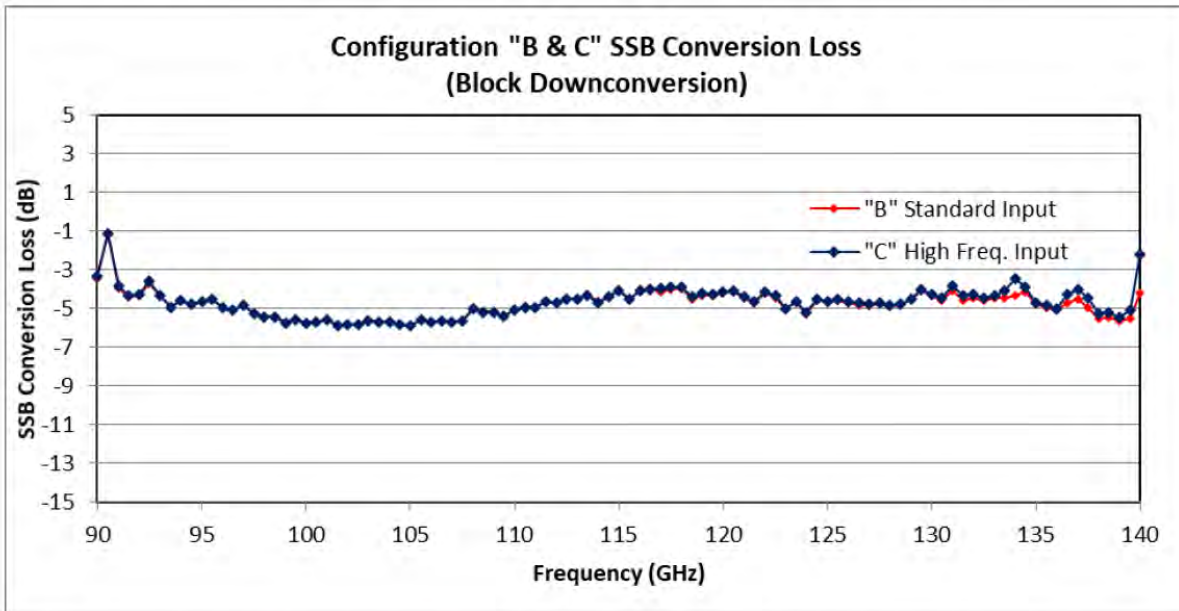

Figure 5: The product performance (SSB conversion loss vs. RF frequency) is shown for an LO input power of ~15dBm in Standard LO Frequency operation and LO input power of ~0dBm in High LO Frequency operation. IF power measured from "IF Output" port with IF frequency fixed at 1.3GHz. CSV Data file included on USB Drive.



USER GUIDE

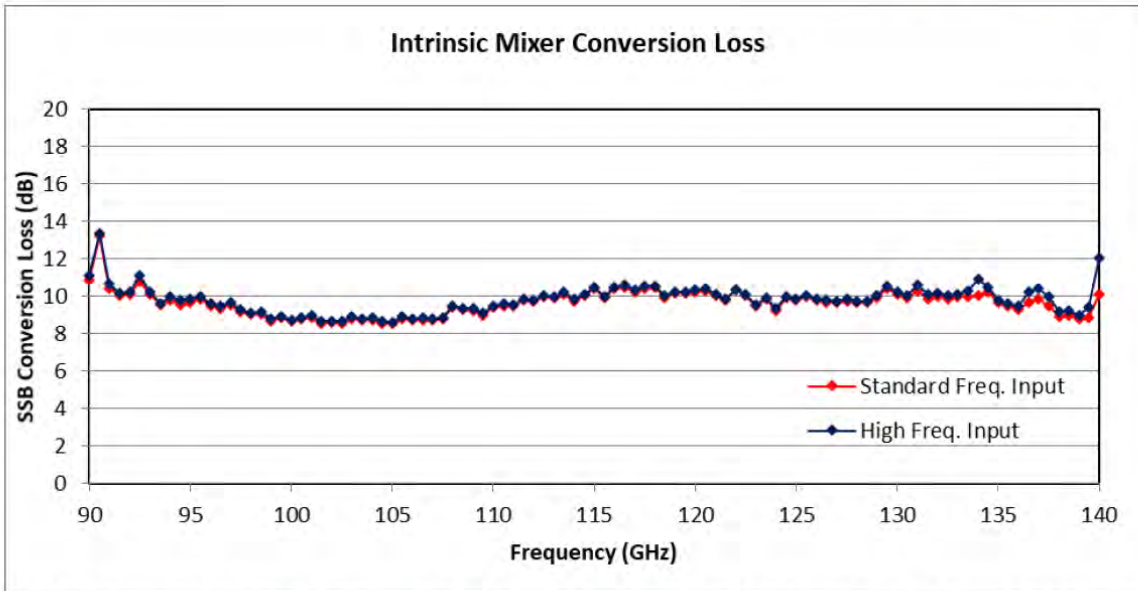

Figure 6: The product performance (SSB conversion loss vs. RF frequency) is shown for an LO input power of ~15dBm in Standard LO Frequency operation and LO input power of ~0dBm in High LO Frequency operation. IF power measured from mixer port with IF frequency fixed at 1.3GHz. Note: mixer port is not accessible for use by the user. CSV Data file included on USB Drive.

Measured Displayed Average Noise Level (dBm/Hz)	
Typical	-149.5

*Measured with a Keysight N9030A PXA Spectrum Analyzer.

Intertek

Report Number: 104689284BOX-001

Issued: 08/02/2021
Last Revised: 10/12/2021

SAX 837 Conversion Loss

Note: Out of band data is not guaranteed to be accurate.

Freq(GHz)	"A" LO/IF Input/Output	"B" Standard Input	"C" High Freq. Input	High Freq. Intrinsic Mixer Loss	Standard Freq. Intrinsic Mixer Loss
90	11.67514724	-3.451852763	-3.337852763	11.13014724	10.85114724
90.5	14.10568478	-1.079315219	-1.162315219	13.39768478	13.21768478
91	11.19284379	-3.952156213	-3.831156213	10.66284379	10.43484379
91.5	10.77353378	-4.372466216	-4.345466216	10.19653378	10.03853378
92	10.8156319	-4.3273681	-4.2933681	10.2776319	10.0966319
92.5	11.40549847	-3.724501532	-3.574501532	11.09249847	10.79149847
93	10.79724258	-4.331757419	-4.317757419	10.24124258	10.10624258
93.5	10.21914168	-4.91885832	-4.95285832	9.63014168	9.54914168
94	10.55024142	-4.587758581	-4.565758581	9.996241419	9.821241419
94.5	10.29788363	-4.822116373	-4.753116373	9.778883628	9.588883628
95	10.4741589	-4.669841103	-4.660841103	9.843158897	9.695158897
95.5	10.60265733	-4.50734267	-4.51534267	9.99665733	9.89265733
96	10.1907898	-4.953210203	-4.985210203	9.625789797	9.505789797
96.5	10.083555	-5.061445003	-5.079445003	9.479554997	9.372554997
97	10.30032929	-4.847670708	-4.859670708	9.661329292	9.553329292
97.5	9.894886965	-5.239113035	-5.255113035	9.296886965	9.162886965
98	9.696380637	-5.421619363	-5.441619363	9.135380637	9.034380637
98.5	9.728739538	-5.401260462	-5.427260462	9.168739538	9.038739538
99	9.401152675	-5.731847325	-5.746847325	8.803152675	8.707152675
99.5	9.542871349	-5.586128651	-5.600128651	8.951871349	8.840871349
100	9.367058164	-5.769941836	-5.782941836	8.777058164	8.658058164
100.5	9.496118475	-5.651881525	-5.678881525	8.901118475	8.787118475
101	9.563891248	-5.561108752	-5.575108752	8.981891248	8.875891248
101.5	9.294818879	-5.847181121	-5.869181121	8.686818879	8.578818879
102	9.32353949	-5.80946051	-5.83646051	8.70453949	8.60753949
102.5	9.312544107	-5.835455893	-5.854455893	8.691544107	8.586544107
103	9.538372928	-5.604627072	-5.619627072	8.933372928	8.824372928
103.5	9.440667741	-5.698332259	-5.705332259	8.834667741	8.727667741
104	9.473096285	-5.666903715	-5.678903715	8.866096285	8.770096285
104.5	9.295835708	-5.846164292	-5.856164292	8.670835708	8.571835708
105	9.26675987	-5.86924013	-5.87924013	8.63275987	8.53575987
105.5	9.587719809	-5.566280191	-5.585280191	8.920719809	8.823719809
106	9.447107698	-5.688892302	-5.696892302	8.806107698	8.722107698
106.5	9.47817723	-5.65582277	-5.66782277	8.86217723	8.77317723
107	9.445819292	-5.693180709	-5.715180709	8.831819292	8.718819292
107.5	9.506835045	-5.627164955	-5.646164955	8.896835045	8.804835045
108	10.15543137	-4.980568633	-5.021568633	9.515431367	9.429431367

Intertek

Report Number: 104689284BOX-001

Issued: 08/02/2021
Last Revised: 10/12/2021

Freq(GHz)	"A" LO/IF Input/Output	"B" Standard Input	"C" High Freq. Input	High Freq. Intrinsic Mixer Loss	Standard Freq. Intrinsic Mixer Loss
108.5	10.01501141	-5.139988586	-5.184988586	9.375011414	9.292011414
109	9.986943402	-5.163056598	-5.180056598	9.359943402	9.259943402
109.5	9.700311379	-5.427688621	-5.415688621	9.090311379	9.007311379
110	10.11440377	-5.034596231	-5.068596231	9.480403769	9.435403769
110.5	10.23931625	-4.896683751	-4.935683751	9.593316249	9.506316249
111	10.19914709	-4.941852911	-4.978852911	9.567147089	9.514147089
111.5	10.51961626	-4.630383737	-4.666383737	9.887616263	9.822616263
112	10.45156748	-4.687432519	-4.685432519	9.837567481	9.740567481
112.5	10.66102657	-4.482973427	-4.488973427	10.07402657	9.973026573
113	10.62316393	-4.517836074	-4.541836074	10.01716393	9.943163926
113.5	10.84547099	-4.287529014	-4.341529014	10.22647099	10.14647099
114	10.46605969	-4.667940312	-4.688940312	9.862059688	9.774059688
114.5	10.76937147	-4.369628526	-4.376628526	10.14637147	10.05437147
115	11.11837657	-4.04062343	-4.05262343	10.48737657	10.40737657
115.5	10.59959028	-4.534409721	-4.539409721	10.02759028	9.940590279
116	11.08255473	-4.042445266	-4.056445266	10.50855473	10.41955473
116.5	11.23473017	-3.950269828	-4.014269828	10.59973017	10.49673017
117	10.75491026	-4.152089736	-3.939089736	10.36291026	10.26991026
117.5	10.96623836	-4.013761637	-3.885761637	10.55123836	10.44823836
118	11.04450356	-3.973496442	-3.878496442	10.56050356	10.48550356
118.5	10.52617331	-4.502826691	-4.414826691	10.04817331	9.940173309
119	10.71214465	-4.310855347	-4.229855347	10.27714465	10.18914465
119.5	10.73550138	-4.318498616	-4.257498616	10.26750138	10.16450138
120	10.83361073	-4.226389267	-4.143389267	10.35961073	10.27661073
120.5	10.88819078	-4.15980922	-4.09380922	10.41419078	10.33619078
121	10.61391575	-4.435084247	-4.384084247	10.13691575	10.06591575
121.5	10.37585906	-4.697140936	-4.630140936	9.876859064	9.825859064
122	10.92118158	-4.177818422	-4.117818422	10.38918158	10.35018158
122.5	10.59706531	-4.452934691	-4.359934691	10.13506531	10.05606531
123	10.06564904	-5.02435096	-4.99135096	9.55564904	9.48764904
123.5	10.43854116	-4.643458841	-4.628458841	9.936541159	9.847541159
124	9.860132081	-5.249867919	-5.203867919	9.352132081	9.265132081
124.5	10.50591325	-4.589086747	-4.518086747	10.00491325	9.903913253
125	10.4479865	-4.673013497	-4.657013497	9.882986503	9.791986503
125.5	10.54246455	-4.560535451	-4.549535451	10.03846455	9.965464549
126	10.350356	-4.721644004	-4.674644004	9.874355996	9.804355996
126.5	10.27868628	-4.807313723	-4.735313723	9.805686277	9.713686277
127	10.26573962	-4.837260384	-4.798260384	9.773739616	9.685739616
127.5	10.39357186	-4.74042814	-4.71242814	9.85857186	9.76757186
128	10.2407497	-4.876250305	-4.819250305	9.737749695	9.661749695
128.5	10.27302715	-4.815972854	-4.774972854	9.753027146	9.666027146

Intertek

Report Number: 104689284BOX-001

Issued: 08/02/2021
Last Revised: 10/12/2021

Freq(GHz)	"A" LO/IF Input/Output	"B" Standard Input	"C" High Freq. Input	High Freq. Intrinsic Mixer Loss	Standard Freq. Intrinsic Mixer Loss
129	10.57790721	-4.539092789	-4.493092789	10.04490721	9.944907211
129.5	11.06294687	-4.055053128	-4.017053128	10.52894687	10.44894687
130	10.74665017	-4.351349831	-4.264349831	10.25565017	10.14965017
130.5	10.54234128	-4.571658716	-4.477658716	10.04334128	9.919341284
131	10.99784288	-4.095157118	-3.820157118	10.59784288	10.32284288
131.5	10.48624586	-4.582754137	-4.311754137	10.14424586	9.843245863
132	10.71127934	-4.428720663	-4.285720663	10.18227934	10.02627934
132.5	10.54574278	-4.587257219	-4.439257219	10.07174278	9.893742781
133	10.64369663	-4.477303375	-4.340303375	10.14769663	9.976696625
133.5	10.68664451	-4.43135549	-4.10535549	10.33764451	9.99364451
134	10.78700975	-4.313990247	-3.460990247	10.93500975	10.07700975
134.5	10.95997375	-4.161026252	-3.916026252	10.52797375	10.25597375
135	10.37279947	-4.751200533	-4.707200533	9.788799467	9.689799467
135.5	10.1724832	-4.934516804	-4.843516804	9.642483196	9.511483196
136	10.044754	-5.108245999	-4.999245999	9.512754001	9.332754001
136.5	10.45312533	-4.676874665	-4.252874665	10.25012533	9.695125335
137	10.61386016	-4.518139838	-3.994139838	10.42886016	9.852860162
137.5	10.14375506	-4.948244935	-4.476244935	9.965755065	9.481755065
138	9.604980629	-5.520019371	-5.270019371	9.185980629	8.939980629
138.5	9.663838852	-5.432161148	-5.190161148	9.272838852	9.004838852
139	9.512629562	-5.615370438	-5.452370438	9.013629562	8.813629562
139.5	9.644409056	-5.524590944	-5.063590944	9.413409056	8.893409056
140	10.95996759	-4.22003241	-2.22503241	12.05596759	10.15096759

Notes: The test equipment was provided by Starry, Inc. The vendor does not provide a calibration certificate.

14 Appendix B – Mixer Verification Certificates

VDIWR19.0SAX-F (40-60 GHz)



Virginia Diodes, Inc
979 2nd St. SE
Suite 309
Charlottesville, VA 22902
Phone: 434-297-3257
Fax: 434-297-3258

Certificate of Conformance

To: Starry, Inc.
38 Chauncy Street
2nd Floor
Boston, MA 02111
United States

From: Virginia Diodes, Inc
979 2nd St. SE
Suite 309
Charlottesville, VA 22902

Packing List No: 211085 Today's Date: 03/31/21
Shipping Date: 03/30/21 PO Number: PO20183

Quantity	Shipped	Unit	Description	Order-Job Number
1		EA	VDIWR19.0SAX-F S/N: SAX 835	21108A-01
1		EA	RCHO19R CONICAL HORN ANTENNA	21108A-02

The VDI product(s) in this shipment meet(s) the guidelines for performance specifications established in accordance with the corresponding Purchase Order. Data presented in the User Guide, where applicable, has been obtained in accordance with VDI's Quality Management System. All instruments, used to obtain data, which require calibration have been calibrated with equipment traceable to the National Institute of Standards and Technology (NIST) and through NIST to the International System of Units (SI).

Authorized Signature
Virginia Diodes, Inc

VDIWR12.0SAX-F (60-90 GHz)



Virginia Diodes, Inc
979 2nd St. SE
Suite 309
Charlottesville, VA 22902
Phone: 434-297-3257
Fax: 434-297-3258

Certificate of Conformance

To: Starry, Inc.
38 Chauncy Street
2nd Floor
Boston, MA 02111
United States

From: Virginia Diodes, Inc
979 2nd St. SE
Suite 309
Charlottesville, VA 22902

Packing List No: 211211 Today's Date: 04/12/21
Shipping Date: 04/08/21 PO Number: PO20183

Quantity	<u>Shipped</u>	<u>Unit</u>	<u>Description</u>	<u>Order-Job</u> <u>Number</u>
1		EA	VDIWR12.0SAX-F S/N: SAX 836	21108B-01
1		EA	RCHO12RL Conical Horn Antenna	21108B-02

The VDI product(s) in this shipment meet(s) the guidelines for performance specifications established in accordance with the corresponding Purchase Order. Data presented in the User Guide, where applicable, has been obtained in accordance with VDI's Quality Management System. All instruments, used to obtain data, which require calibration have been calibrated with equipment traceable to the National Institute of Standards and Technology (NIST) and through NIST to the International System of Units (SI).

Authorized Signature
Virginia Diodes, Inc

VDIWR8.0SAX-F (90-140 GHz)



Virginia Diodes, Inc
979 2nd St. SE
Suite 309
Charlottesville, VA 22902
Phone: 434-297-3257
Fax: 434-297-3258

Certificate of Conformance

To: Starry, Inc.
38 Chauncy Street
2nd Floor
Boston, MA 02111
United States

From: Virginia Diodes, Inc
979 2nd St. SE
Suite 309
Charlottesville, VA 22902

Packing List No: 212029	Today's Date: 06/11/21
Shipping Date: 06/11/21	PO Number: PO20183

Quantity	Shipped	Unit	Description	Order-Job Number
1		EA	VDIWR8.0SAX-F WR8.0SAX-F / SN: SAX 837	21108C-01
1		EA	RCHO8RL WR8.0CH - Conical Horn Antenna / RCHO8RL	21108C-02

The VDI product(s) in this shipment meet(s) the guidelines for performance specifications established in accordance with the corresponding Purchase Order. Data presented in the User Guide, where applicable, has been obtained in accordance with VDI's Quality Management System. All instruments, used to obtain data, which require calibration have been calibrated with equipment traceable to the National Institute of Standards and Technology (NIST) and through NIST to the International System of Units (SI).

Authorized Signature
Virginia Diodes, Inc

VDIWR5.1SAX-F (140-220 GHz)



Virginia Diodes, Inc
979 2nd St. SE
Suite 309
Charlottesville, VA 22902
Phone: 434-297-3257
Fax: 434-297-3258

Certificate of Conformance

To: Starry, Inc.
38 Chauncy Street
2nd Floor
Boston, MA 02111
United States

From: Virginia Diodes, Inc
979 2nd St. SE
Suite 309
Charlottesville, VA 22902

Packing List No: 211604 Today's Date: 05/11/21
Shipping Date: 05/11/21 PO Number: PO20183

Quantity	Unit	Description	Order-Job Number
1	EA	VDIWR5.1SAX-F WR5.1SAX-F / SN: SAX 838	21108D-01
1	EA	RCHO5RL WR5.1CH / SN: RCHO5RL	21108D-02

The VDI product(s) in this shipment meet(s) the guidelines for performance specifications established in accordance with the corresponding Purchase Order. Data presented in the User Guide, where applicable, has been obtained in accordance with VDI's Quality Management System. All instruments, used to obtain data, which require calibration have been calibrated with equipment traceable to the National Institute of Standards and Technology (NIST) and through NIST to the International System of Units (SI).

Authorized Signature
Virginia Diodes, Inc

15 Appendix C – Test Laboratory Accreditation Scope

OET Accredited Test firm scope List
Test Firm: **Intertek Testing Services NA Inc.**

Scope	FCC Rule Parts	Maximum Assessed Frequency in MHz	Status	Expiration Date	Recognition Date
Unintentional Radiators	FCC Part 15, Subpart B	260000.00	Approved	06-30-2022	09-29-2017
Industrial, Scientific, and Medical Equipment	FCC Part 18	260000.00	Approved	06-30-2022	09-29-2017
Intentional Radiators	FCC Part 15 Subpart C	260000.00	Approved	06-30-2022	09-29-2017
iPPCS	FCC Part 15, Subpart D	260000.00	Approved	06-30-2022	09-29-2017
U-NII without DFS	FCC Part 15, Subpart E	260000.00	Approved	06-30-2022	09-29-2017
Intentional Radiators	FCC Part 15, Subpart E	260000.00	Approved	06-30-2022	09-29-2017
U-NII with DFS Intentional Radiators	FCC Part 15, Subpart F	260000.00	Approved	06-30-2022	09-29-2017
UWB Intentional Radiators	FCC Part 15, Subpart G	260000.00	Approved	06-30-2022	09-29-2017
White Space Device	FCC Part 15, Subpart H	260000.00	Approved	06-30-2022	09-29-2017
Commercial Mobile Services	Part 22 (cellular), Part 24, Part 25 (below 3 GHz), Part 27	260000.00	Approved	06-30-2022	09-29-2017
General Mobile Radio Services	Part 22 (non-cellular), Part 90 (below 3 GHz), Part 95 (below 3 GHz), Part 97 (below 3 GHz), Part 101 (below 3 GHz)	260000.00	Approved	06-30-2022	09-29-2017
Maritime and Aviation Radio Services	Part 80, Part 87	260000.00	Approved	06-30-2022	09-29-2017
Microwave and Millimeter Bands Radio Services	Part 25 (above 3 GHz), Part 30, Part 74, Part 90 (above 3 GHz), Part 95 (above 3 GHz), Part 97 (above 3 GHz) Part 301	260000.00	Approved	06-30-2022	09-29-2017
Broadcast Radio Services	Part 73, Part 74 (below 3 GHz)	260000.00	Approved	06-30-2022	09-29-2017
Signal Boosters	Part 20, Part 90.219	260000.00	Approved	06-30-2022	09-29-2017