

Starry, Inc.

TEST REPORT

SCOPE OF WORK

Emissions Testing – 24 GHz Comet Radio, Model COMET 24

REPORT NUMBER

104723800BOX-001

ISSUE DATE

October 29, 2021

[REVISED DATE]

November 8, 2021

November 10, 2021

DOCUMENT CONTROL NUMBER

Non-Specific Radio Report Shell Rev. August 2020

© 2020 INTERTEK



EMISSIONS TEST REPORT

(FULL COMPLIANCE)

Report Number: 104723800BOX-001

Project Number: G104723800

Report Issue Date: 10/29/2021

Report Revision Date: 11/08/2021

Report Revision Date: 11/10/2021

Model(s) Tested: Comet 24

Model(s) Partially Tested: None

Model(s) Not Tested but declared equivalent by the client: None

Standards: FCC 47CFR Part 30 Subpart C: 2021

FCC 47CFR Part 2: 2021

KDB 842590 D01 Upper Microwave Flexible Use Service v01r02 April 20, 2021

Tested by:
Intertek
70 Codman Hill Road
Boxborough, MA 01719
USA

Client:
Starry, Inc.
38 Chauncy St. Suite 200
Boston, MA 02111
USA

Report prepared by

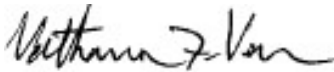

Vathana Ven / Engineering Supervisor

Report reviewed by



Kouma Sinn / Engineering Supervisor

This report is for the exclusive use of Intertek's Client and is provided pursuant to the agreement between Intertek and its Client. Intertek's responsibility and liability are limited to the terms and conditions of the agreement. Intertek assumes no liability to any party, other than to the Client in accordance with the agreement, for any loss, expense or damage occasioned by the use of this report. Only the Client is authorized to permit copying or distribution of this report and then only in its entirety. Any use of the Intertek name or one of its marks for the sale or advertisement of the tested material, product or service must first be approved in writing by Intertek. The observations and test results in this report are relevant only to the sample tested. This report by itself does not imply that the material, product, or service is or has ever been under an Intertek certification program.

Table of Contents

1 Introduction and Conclusion..... 4

2 Test Summary 4

3 Client Information 5

4 Description of Equipment Under Test and Variant Models 5

5 System Setup and Method 6

6 Output Power & Human RF Exposure 8

7 Out of Band (OOB) Domain 30

8 Radiated Spurious Emissions 45

9 Occupied Bandwidths 71

10 Frequency Stability 88

11 AC Main Conducted Emissions 93

12 Revision History 98

13 Appendix – Mixer Conversion Loss 99

14 Appendix B – Mixer Verification Certificates 129

15 Appendix C – Test Laboratory Accreditation Scope 133

1 Introduction and Conclusion

The tests indicated in section 2.0 were performed on the product constructed as described in section 4.0. The remaining test sections are the verbatim text from the actual data sheets used during the investigation. These test sections include the test name, the specified test Method, a list of the actual Test Equipment Used, documentation Photos, Results and raw Data. No additions, deviations, or exclusions have been made from the standard(s) unless specifically noted.

Based on the results of our investigation, we have concluded the product tested **complies** with the requirements of the standard(s) indicated. The results obtained in this test report pertain only to the item(s) tested. Intertek does not make any claims of compliance for samples or variants which were not tested.

2 Test Summary

Section	Test full name	Result
3	Client Information	--
4	Description of Equipment Under Test and Variant Models	--
5	System Setup and Method	--
6	Output Power & Human RF Exposure FCC §2.1046, FCC §30.202 (a), FCC §30.207	Pass
7	Out of Band (OOB) Domain FCC §30.203 (a) (b)	Pass
8	Radiated Spurious Emissions FCC §30.203 (a) (b)	Pass
9	Occupied Bandwidths FCC §2.1049	Pass
10	Frequency Stability* FCC §2.1055	Pass
11	AC Mains Conducted Emissions FCC 47 CFR Part 15 Subpart B (2021)	Pass
12	Revision History	--
13	Appendix – Mixer Conversion Loss	--

*Notes: Frequency tolerance is not specified in FCC 47 CFR Part 30 Subpart C. Measurement was performed for reporting purpose.

Intertek

Report Number: 104723800BOX-001

Issued: 10/29/2021

Revised: 11/08/2021

11/10/2021

3 Client Information

This EUT was tested at the request of:

Client: Starry, Inc.
38 Chauncy St Suite 200
Boston, MA 02111
USA

Contact: Robert White
Telephone: None
Fax: None
Email: rwhite@starry.com

4 Description of Equipment Under Test and Variant Models

Manufacturer: Starry, Inc.
38 Chauncy St Suite 200
Boston, MA 02111
USA

Equipment Under Test			
Description	Manufacturer	Model Number	Serial Number
24 GHz Comet Radio	Starry, Inc.	S01311	2123000009

Receive Date:	June 10, 2021
Received Condition:	Good
Type:	Production

Description of Equipment Under Test (provided by client)

The equipment under test (EUT) is a Comet 24 mmWave based station access point, operating between 24.25-25.25 GHz. It utilizes OFDM IEEE 802.11ac, MCS0-MCS9. Channel bandwidths are 160 MHz and 20 MHz unconverted and transmitted/received at mmWave frequencies between 24.25 GHz and 25.25 GHz. Signals are conveyed in two polarizations – horizontal and vertical through patch array. The antenna is a patch array (16x8) for each polarization. Comet 24 is a CPE radio typically pole mounted outdoors, to the side of a house.

Equipment Under Test Power Configuration			
Rated Voltage	Rated Current	Rated Frequency	Number of Phases
54 VDC	1.1 A	DC	N/A

Operating modes of the EUT:

No.	Descriptions of EUT Exercising
1	Continuous Transmitting

Software used by the EUT:

No.	Descriptions of EUT Exercising
1	Proprietary Software that controls the operation of the radio.

Intertek

Report Number: 104723800BOX-001	Issued: 10/29/2021 Revised: 11/08/2021 11/10/2021
---------------------------------	---

Radio/Receiver Characteristics	
Frequency Band(s)	24.27-24.29 GHz, 24.77-25.09 GHz, 24.34-24.36 GHz, 24.84-25.16 GHz
Modulation Type(s)	OFDM, MCS0-9 per 802.11ac
Maximum Output Power	39.53 dBm (8.97 W) EIRP, 24.25 – 24.45 GHz 40.92 dBm (12.36 W) EIRP, 24.75 – 25.25 GHz
Test Channels	24.27 GHz, 24.28 GHz, 24.29 GHz 24.77 GHz, 24.97 GHz, 25.09 GHz 24.34 GHz, 24.35 GHz, 24.36 GHz 24.84 GHz, 25.04 GHz, 25.16 GHz
Occupied Bandwidth	157.16 MHz
MIMO Information (# of Transmit and Receive antenna ports)	2 TX / 2 RX ports, one spatial stream per polarization, horizontal and vertical polarization, client-side radio
Equipment Type	Proprietary upbanded and modified 802.11AC Radio
Antenna Type and Gain	Antenna Type and Gain: 24.25 - 25.25 GHz Patch antenna array, 19 dBi

Variant Models:

The following variant models were not tested as part of this evaluation, but have been identified by the manufacturer as being electrically identical models, depopulated models, or with reasonable similarity to the model(s) tested. Intertek does not make any claims of compliance for samples or variants which were not tested.

None

5 System Setup and Method

Cables					
ID	Description	Length (m)	Shielding	Ferrites	Termination
--	AC Cord	1	None	None	AC Mains
--	AC Adapter	1	None	Yes	Power Supply
--	Ethernet	10	None	None	Support Equipment
--	TNC	10	Yes	None	Support Equipment

Support Equipment			
Description	Manufacturer	Model Number	Serial Number
Monitor	Dell	P2317H	CN-03GJ21-74261-6BP-3TKM-A00
Keyboard	Dell	KB216t	CN-ORKRON-71616-6CD-1FLE-A03
Mouse	Dell	MS116t	CN-0DVORH-LO300-81G-1GFC
5-Port Gigabit Ethernet Switch	Netgear	GS305v3	5U81095VA3835
FCC System Tester	Starry	JBC313U591W-31ACB	19CF319X002872
Labsat GNSS Simulator	Racelogic	LS03	082600
Wireless Router	Opengear	ACM7004	70041901043136
Starry Link	Starry	500812	MAC: 00B6F2098A
48VDC Power Supply	Meanwell	GST200A48	None

5.1 Method:

Configuration as required by FCC 47CFR Part 30 Subparts C:2021, FCC 47CFR Part 2: 2021, ANSI C63.26-2015, and KDB 842590 D01 Upper Microwave Flexible Use Service v01r02 April 20, 2021.

5.2 EUT Block Diagram:

Comet 24

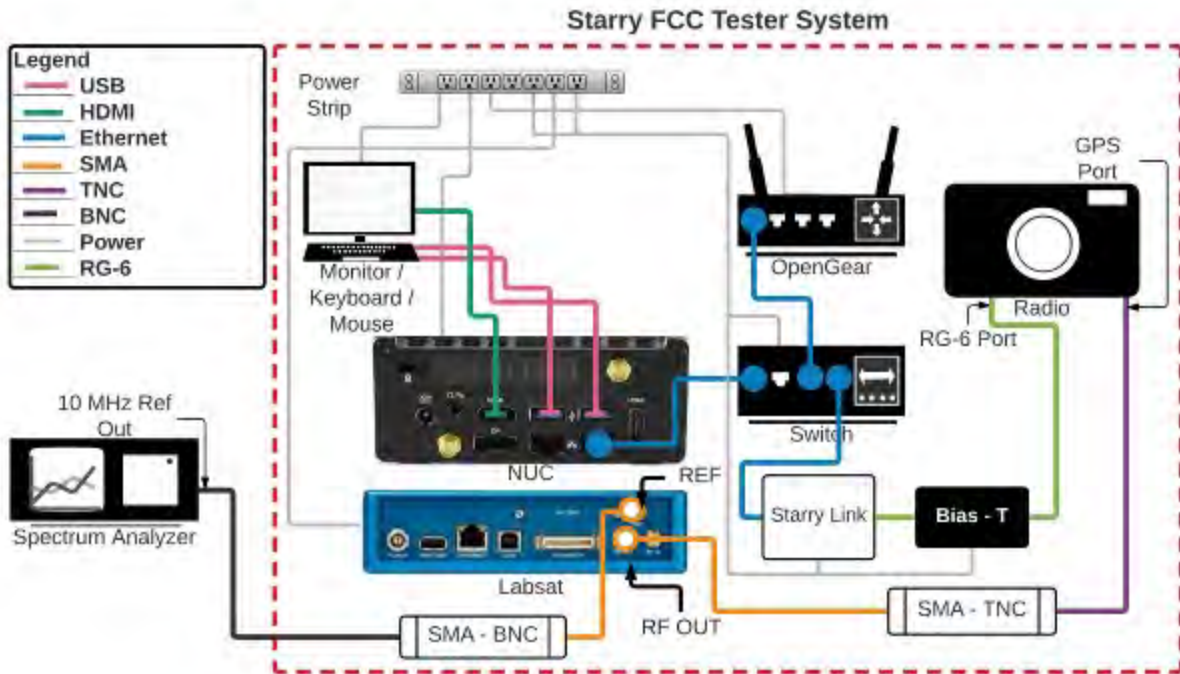

Report Number: 104723800BOX-001	Issued: 10/29/2021 Revised: 11/08/2021 11/10/2021
---------------------------------	---

6 Output Power & Human RF Exposure

6.1 Requirements

FCC §30.202(a) Power limits.

For fixed and base stations operating in connection with mobile systems, the average power of the sum of all antenna elements is limited to an equivalent isotropically radiated power (EIRP) density of +75dBm/100 MHz. For channel bandwidths less than 100 megahertz the EIRP must be reduced proportionally and linearly based on the bandwidth relative to 100 megahertz.

FCC §30.207 Radio frequency (RF) safety.

Licensees and manufacturers are subject to the radio frequency radiation exposure requirements specified in §§ 1.1307(b), 1.1310, 2.1091, and 2.1093 of this chapter, as appropriate. Applications for equipment authorization of mobile or portable devices operating under this section must contain a statement confirming compliance with these requirements. Technical information showing the basis for this statement must be submitted to the Commission upon request.

FCC §1.1310 Radiofrequency radiation exposure limits

Table 1 below sets forth limits for Maximum Permissible Exposure (MPE) to radiofrequency electromagnetic field.

Table 1 – Limits for Maximum Permissible Exposure (MPE)

Frequency range (MHz)	Electric field strength (V/m)	Magnetic field strength (A/m)	Power Density (mW/cm ²)	Averaging time (minutes)
(A) Limits for Occupational/Controlled Exposure				
0.3-3.0	614	1.63	*100	6
3.0-30	1842/f	4.89/f	*900/f ²	6
30-300	61.4	0.163	1.0	6
300-1,500			f/300	6
1,500-100,000			5	6
(B) Limits for General Population/Uncontrolled Exposure				
0.3-1.34	614	1.63	*100	30
1.34-30	842/f	2.19/f	*180/f ²	30
30-300	27.5	0.073	0.2	30
300-1,500			f/1500	30
1,500-100,000			1.0	30

F = frequency in MHz

* = Plane-wave equivalent power density

Report Number: 104723800BOX-001	Issued: 10/29/2021 Revised: 11/08/2021 11/10/2021
---------------------------------	---

6.2 Method

Tests are performed in accordance with FCC 47CFR Part 30 Subparts C: 2021, FCC 47CFR Part 2: 2021, FCC KDB 842590 D01 v01r02 Subclause 4.2, ANSI C63.26:2015 Subclause 5.5.4.

The procedure described in Subclause 5.5.4 (field strength method) of ANSI C63.26-2015 was utilized to determine maximum power. A field strength measurement was performed, and the field strength level was mathematically converted to an equivalent power level for comparison to the applicable limit. Subclause 4.2 of FCC KDB 842590 D01 v01r02 was utilized where radiated power spectral density (EIRP density) is subject to the limit.

The EUT was transmitting at its maximum data rate with MCS8 modulation. During measurement, EIRP radiated power was converted to conducted power by using antenna gain and distance factor. Power shown on the screenshots are conducted power.

- Connect the test antenna to a spectrum analyzer.
- Set spectrum analyzer’s RBW, VBW, detector, span, etc. to the proper values.
- Place the EUT 1.5 meters above the ground reference plane and the far field test distance of 3 meters from the edge of the EUT to the test antenna.
- Set the EUT to transmit continuously on a channel with modulation.
- As the surfaces of the EUT are scanned, keep the test antenna pointed toward the EUT and slowly vary the test antenna polarization to cover all possible polarizations and orientations of the emission. And vary the test antenna height from 1 to 4 meters to maximize the emission.
- Record the measured reading with the test antenna fixed at the maximized position, polarization, and orientation. Record the measurement distance.
- EIRP power is calculated by using the following equation:

$$EIRP = E_{Meas} + 20\log(d_{Meas}) - 104.7$$

where

- EIRP is the equivalent isotopically radiated power, in dBm
- E_{Meas} is the field strength of the emission at the measurement distance, in dBμV/m
- d_{Meas} is the measurement distance, in m

- Measurements was made at 3 meters distance. Far Field Distance (Rm) Calculation: $Rm = 2D^2 / \lambda$, where: D = largest dimension of the antenna aperture in meters, λ = wavelength of the emission under investigation $[300/f_{MHz}]$ in meters.

TEST SITE: 10m ALSE

The 10m ALSE is 13m (Length) x 21m (Depth) x 10m (Height) with the effective size in terms of space from the tips of the absorber is 12m (Length) x 20m (Depth) x 8.5m (Height). This chamber achieves broadband performance using a unique arrangement of hybrid and ferrite tile absorber. This chamber has a built in 3m diameter turntable (Embedded type). The metal structure of the table makes electrical connection around the entire circumference of the turntable to the ground plane with a metal brush type connection. The turntable is located on one end of the chamber and the antennas are mounted 3 and 10 meters away at the other end of the chamber on the adjustable an Antenna Mast. The antenna mast is a non-conductive bore sighted type with remote control of antenna height and polarization. The Antenna Mast and the turntable can be remotely controlled through the controller located in the adjacent Control room. A Styrofoam table 80 cm high is used for table-top equipment.

Intertek

Report Number: 104723800BOX-001	Issued: 10/29/2021 Revised: 11/08/2021 11/10/2021
---------------------------------	---

Measurement Uncertainty

Measurement	Frequency Range	Expanded Uncertainty (k=2)
Radiated Emissions, 10m	30-1000 MHz	5.0 dB
Radiated Emissions, 3m	30-1000 MHz	4.6 dB
Radiated Emissions, 3m	1-6 GHz	4.9 dB
Radiated Emissions, 3m	6-15 GHz	5.1 dB
Radiated Emissions, 3m	15-18 GHz	4.7 dB
Radiated Emissions, 3m	18-40 GHz	4.7 dB

Sample Calculation

The cable loss, antenna factor, and path loss at 3 meters were compensated in the Spectrum Analyzer as a dB offset without the EUT antenna factor. The EIRP power is calculated from field strength reading at 3 meters as below.

$EIRP (dBm) = E (dB\mu/m) + 20 * LOG (D) - 104.7$; where D is the measurement distance (in the far field region) in meters.

$EIRP (dBm) = E (dB\mu V/m) - 95.2$, where D = 3 m

Conducted Power (dBm) = EIRP (dBm) – EUT antenna gain (dBi)

6.3 Test Equipment Used:

Asset	Description	Manufacturer	Model	Serial	Cal Date	Cal Due
DAV007'	Weather Station Vantage Vue	Davis	6250	MS191212003	03/20/2021	03/20/2022
EMC04'	ANTENNA, RIDGED GUIDE, 18-40 GHZ	EMCO	3116	2090	01/28/2021	01/28/2022
ROS005-1'	Signal and Spectrum Analyzer	Rohde and Shwartz	FSW43	100646	10/27/2020	10/27/2021
CBLHF2012-5M-2'	5m 9kHz-40GHz Coaxial Cable - SET2	Huber & Suhner	SF102	252676002	02/19/2021	02/19/2022

Software Utilized:

Name	Manufacturer	Version
None	--	--

6.4 Results – Output Power:

The sample tested was found to Comply.

Modulation: MCS8

Measurement Distance: 3m

Frequency (GHz)	Antenna Polarity	Bandwidth (MHz)	EIRP From Plots (0 path) (dBm)	Total EIRP Power (dBm/100MHz)	Limit (dBm/100M Hz)	Margin (dBm)
24.27	V	20	39.53	46.52	75	-28.48
24.28	V	20	39.31	46.30	75	-28.70
24.29	V	20	39.51	46.50	75	-28.50
24.77	V	20	38.16	45.15	75	-29.85
24.97	V	20	38.35	45.34	75	-29.66
25.09	V	20	37.30	44.29	75	-30.71
24.27	H	20	35.07	42.06	75	-32.94
24.28	H	20	35.01	42.00	75	-33.00
24.29	H	20	38.62	45.61	75	-29.39
24.77	H	20	38.02	45.01	75	-29.99
24.97	H	20	38.41	45.40	75	-29.60
25.09	H	20	36.61	43.60	75	-31.40

Modulation: MCS8

Measurement Distance: 3m

Frequency (GHz)	Antenna Polarity	Bandwidth (MHz)	EIRP From Plots (0 path) (dBm)	Total EIRP Power (dBm/100MHz)	Limit (dBm/100M Hz)	Margin (dBm)
24.34	V	160	39.44	37.40	75	-37.60
24.35	V	160	39.08	37.04	75	-37.96
24.36	V	160	40.92	38.88	75	-36.12
24.84	V	160	39.04	37.00	75	-38.00
25.04	V	160	38.51	36.47	75	-38.53
25.16	V	160	38.98	36.94	75	-38.06
24.34	H	160	39.54	37.50	75	-37.50
24.35	H	160	39.14	37.10	75	-37.90
24.36	H	160	40.04	38.00	75	-37.00
24.84	H	160	40.80	38.76	75	-36.24
25.04	H	160	39.01	36.97	75	-38.03
25.16	H	160	38.56	36.52	75	-38.48

6.5 Results – Human RF Exposure

MPE Safe Distance Calculation

RF exposure for licensed transmitter is handled at the time of licensing, however, an MPE calculation was performed in order to show the distance at which the device is compliant with the limits of §1.1310. The highest measured EIRP output power was used.

FCC Limit for General Population/Uncontrolled Exposure at 24 GHz = 1 mW/cm²

Power Density = [EIRP] / [4π x (D_{cm})²], where EIRP is in milliwatts and D is in centimeters

Setting the power density equal to the limit of 1 mW/cm² and solving for D_{cm} yields the following results.

Results:

EUT EIRP = EIRP Output Power

Power Density Limit = [EIRP] / [4π x (D_{cm})²]

1 mW/cm² = [EIRP] / [4π x (D_{cm})²]

D_{cm} = ([EIRP] / [4π])^{1/2}, where maximum EIRP = 46.52 dBm or 44874.538993 mW

Safe Distance, D_{cm} = 56.77 cm

6.6 Setup Photographs:

Confidential – Photo not included in this report

6.7 Plots/Data:

EIRP Output Power (Vertical Polarity) – 24.27GHz_20MHz BW_MCS8_att0_Mixer28

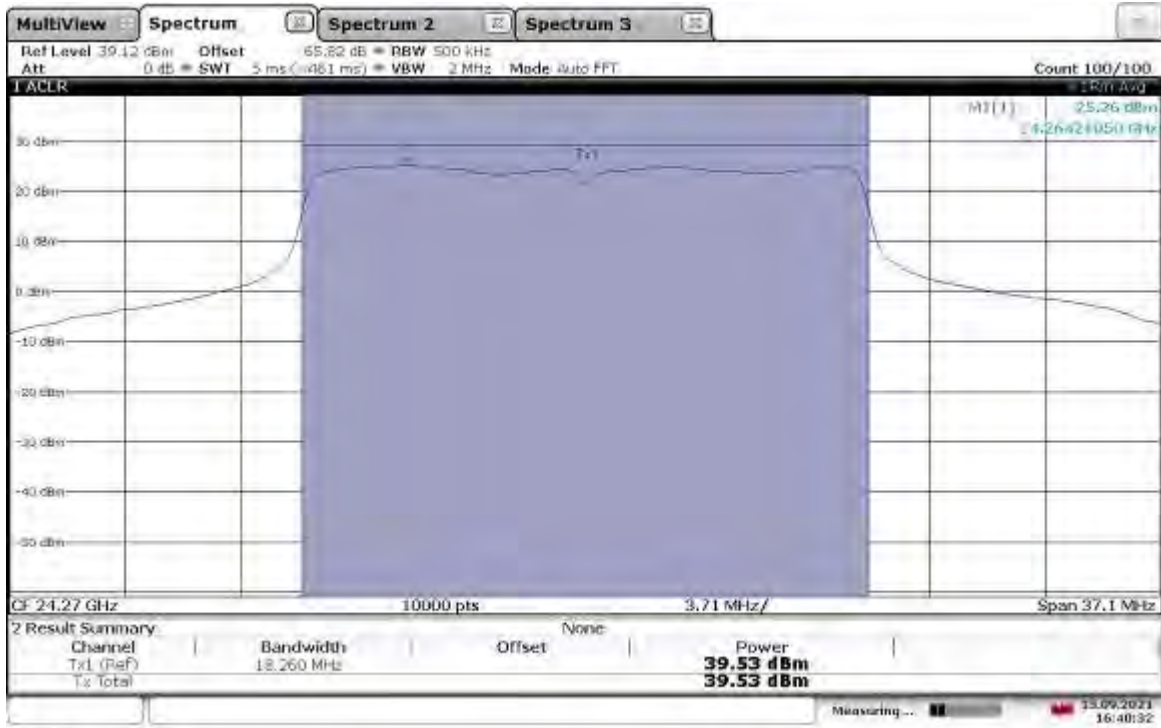

16:40:32 13.09.2021

EIRP Output Power (Vertical Polarity) – 24.28GHz_20MHz BW_MCS8_att0.25_Mixer28

Intertek

Report Number: 104723800BOX-001

Issued: 10/29/2021

Revised: 11/08/2021

11/10/2021

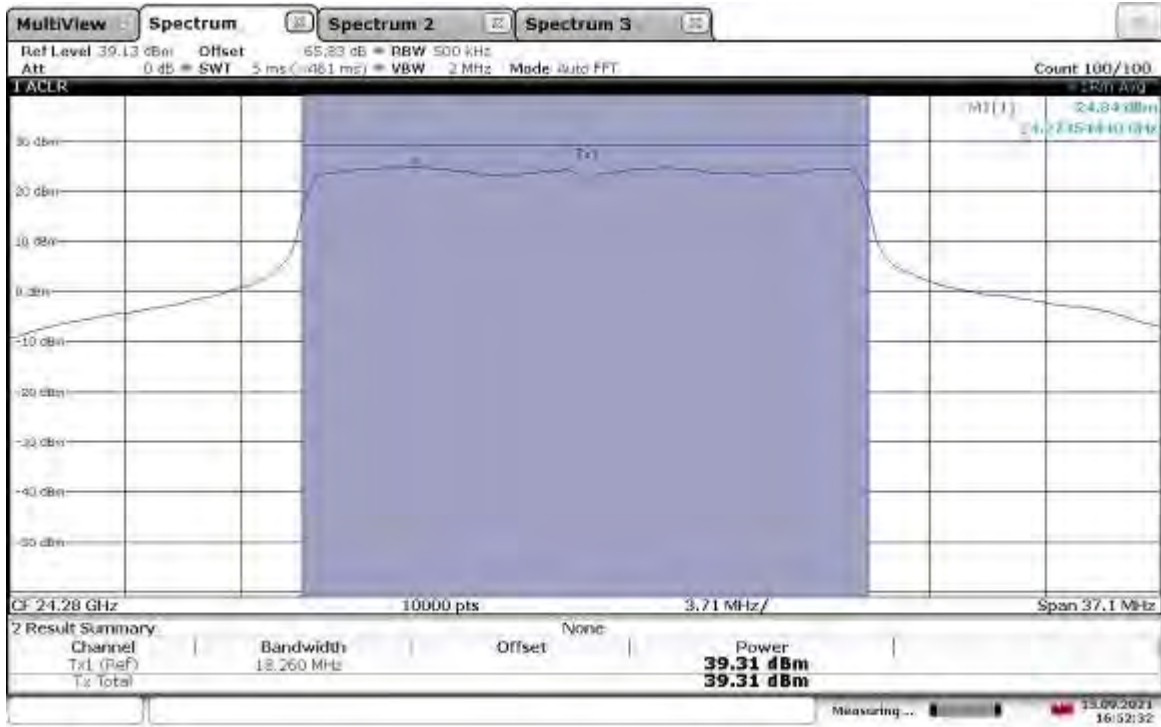

16:52:33 13.09.2021

EIRP Output Power (Vertical Polarity) – 24.29GHz_20MHz BW_MCS8_att0.75_Mixer27

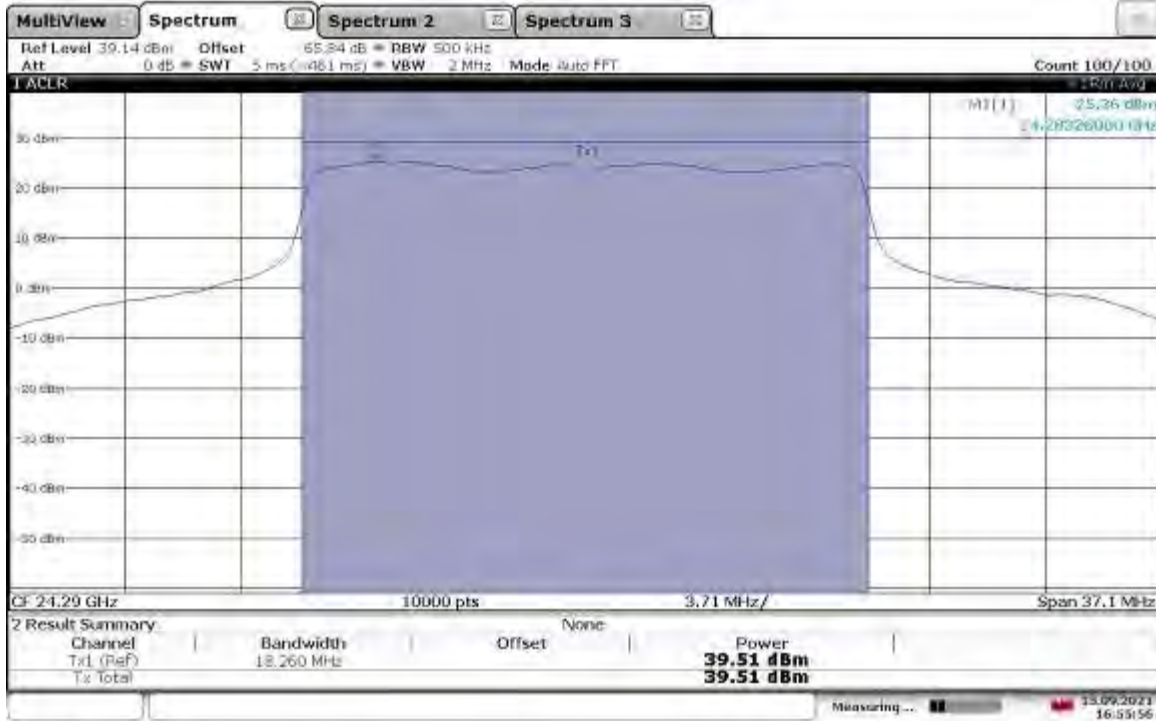

EIRP Output Power (Vertical Polarity) – 24.77GHz_20MHz BW_MCS8_att0_Mixer24

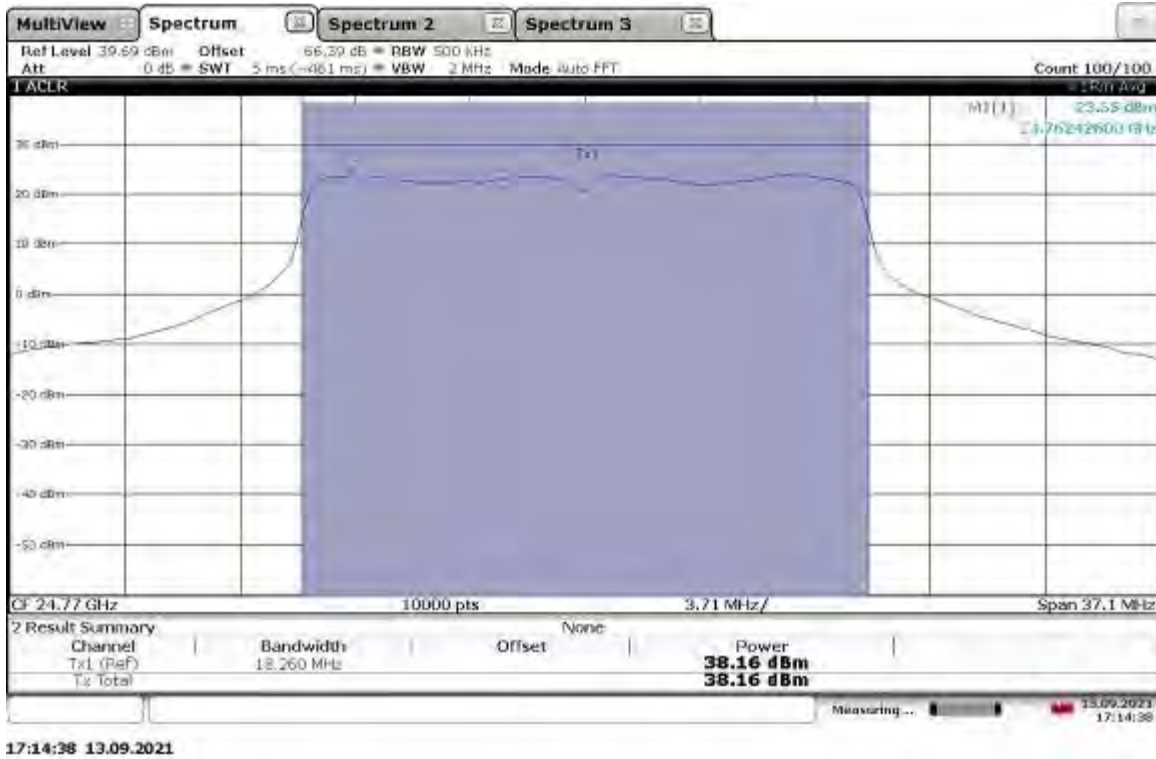

EIRP Output Power (Vertical Polarity) – 24.97GHz_20MHz BW_MCS8_att0.25_Mixer25

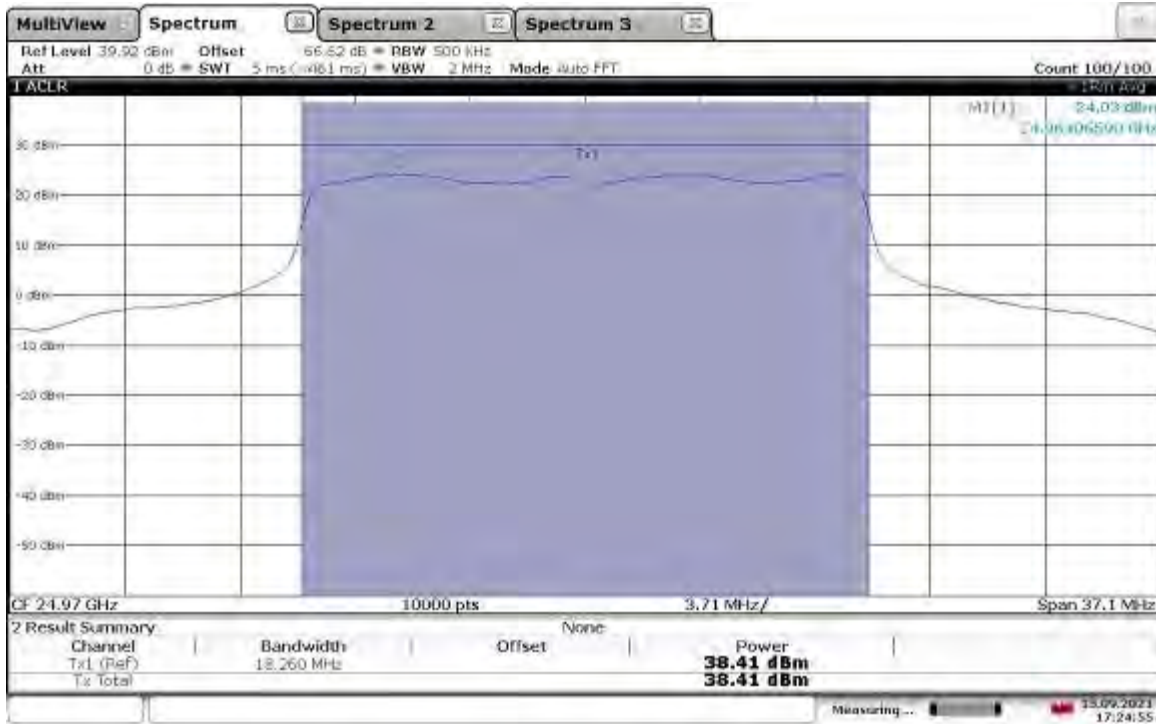

EIRP Output Power (Vertical Polarity) – 25.09 BW_MCS8_att0.75_Mixer23

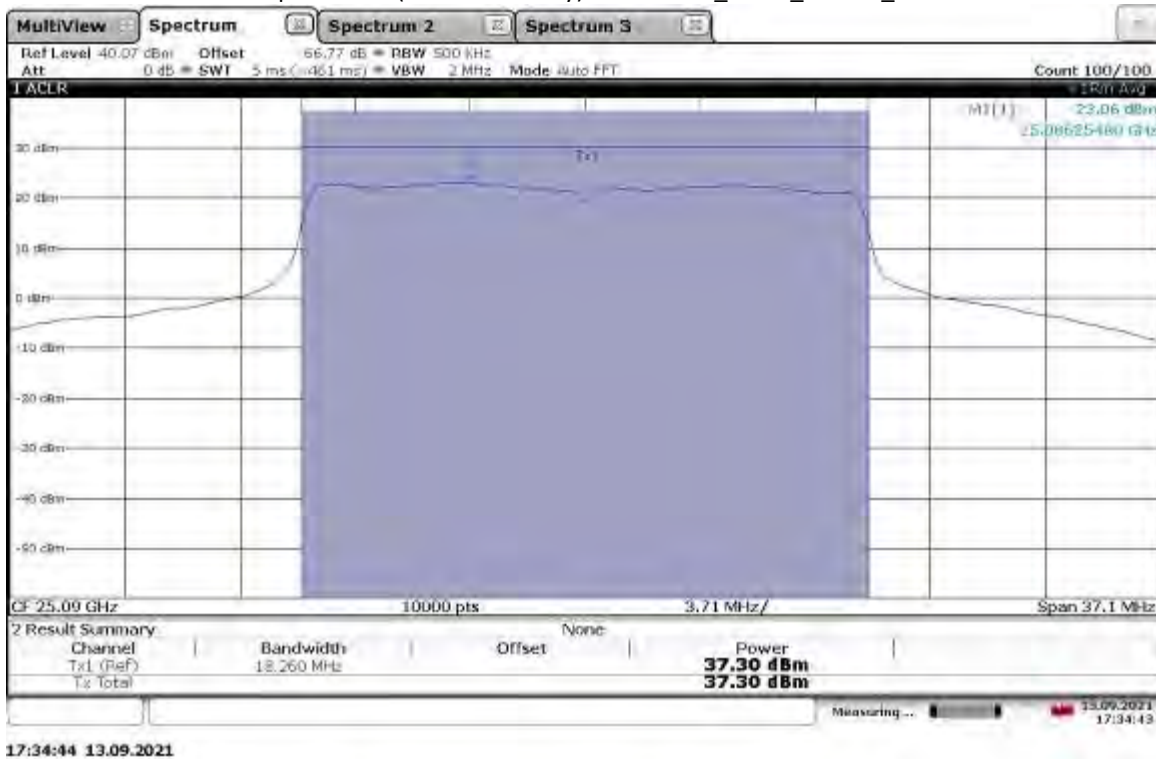

Intertek

Report Number: 104723800BOX-001

Issued: 10/29/2021

Revised: 11/08/2021

11/10/2021

EIRP Output Power (Horizontal Polarity) – 24.27GHz_20MHz BW_MCS8_att0_Mixer28

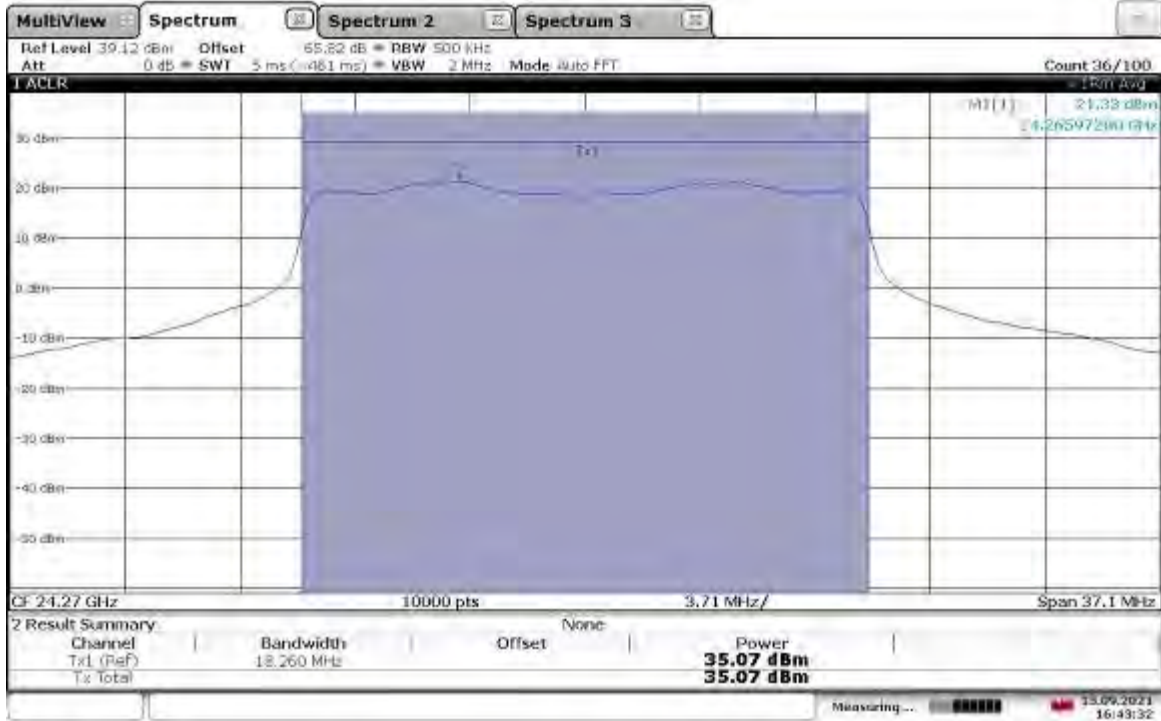

EIRP Output Power (Horizontal Polarity) – 24.28GHz_20MHz BW_MCS8_att0_Mixer28

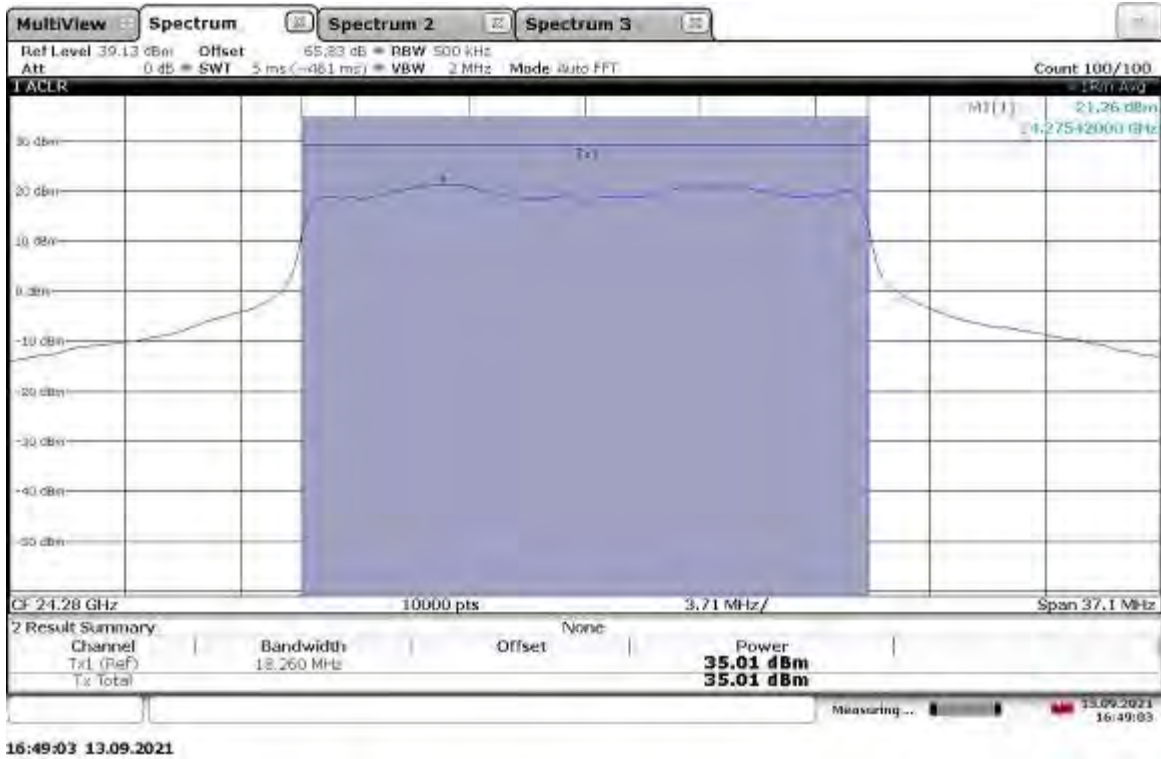

EIRP Output Power (Horizontal Polarity) – 24.29GHz_20MHz BW_MCS8_att0.25_Mixer28

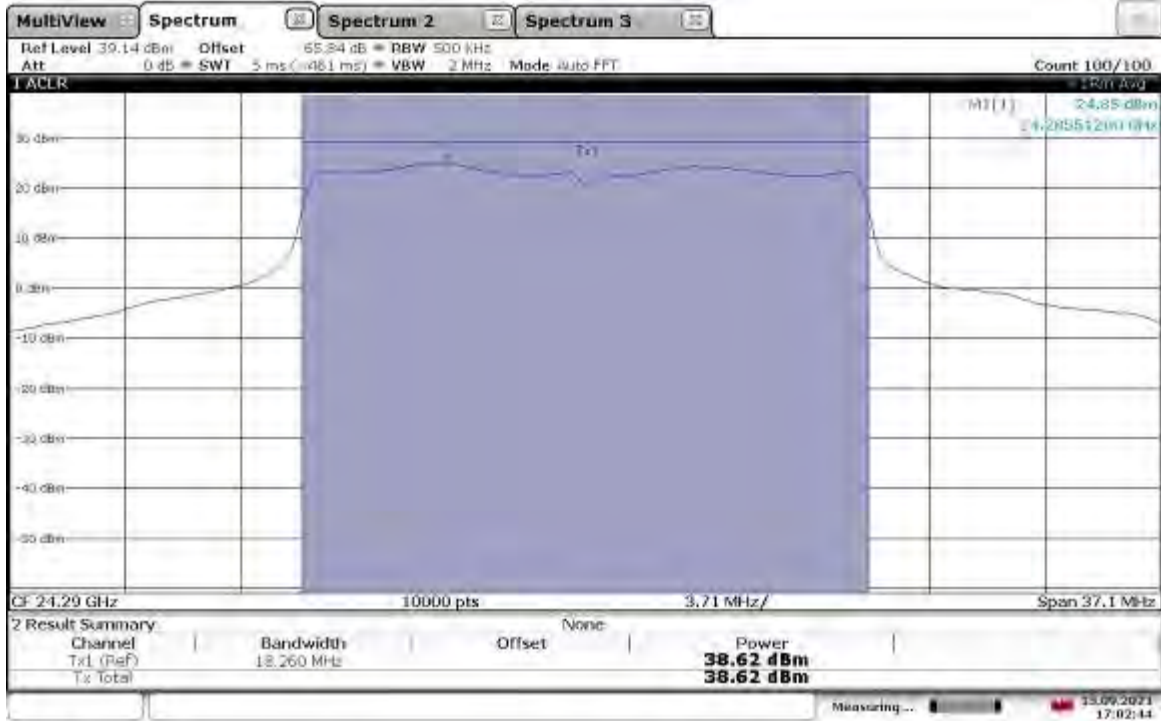

17:02:44 13.09.2021

EIRP Output Power (Horizontal Polarity) – 24.77GHz_20MHz BW_MCS8_att0_Mixer28

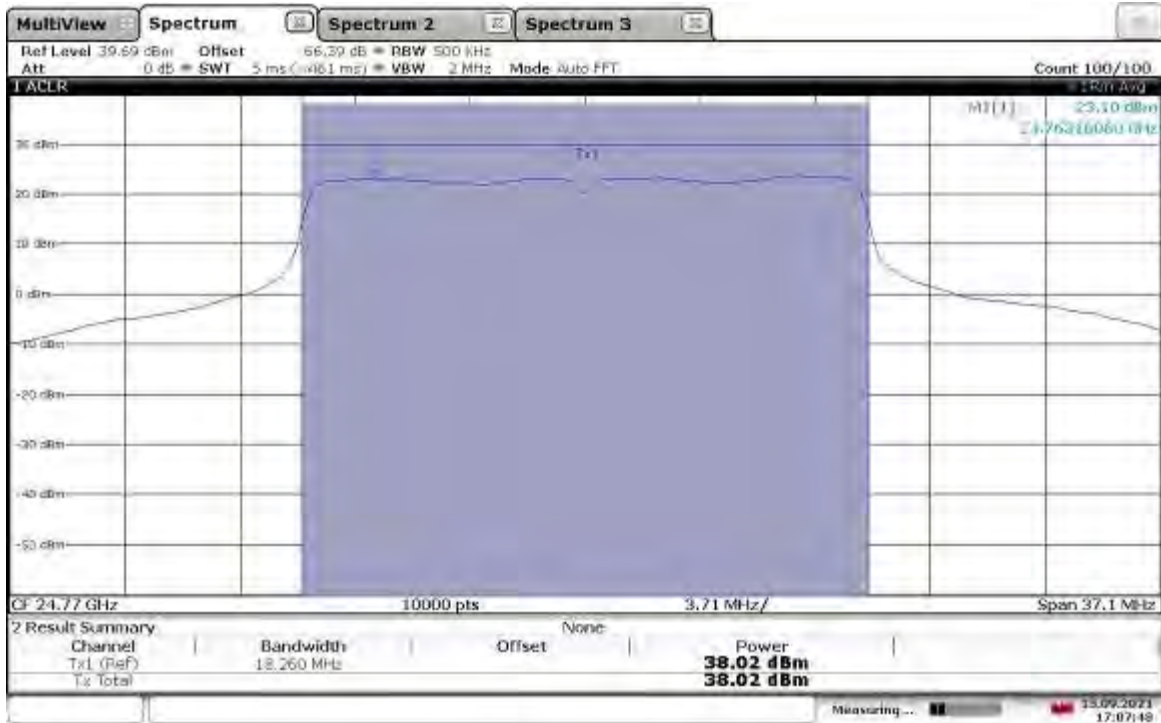

17:07:49 13.09.2021

EIRP Output Power (Horizontal Polarity) – 24.97GHz_20MHz BW_MCS8_att0_Mixer27

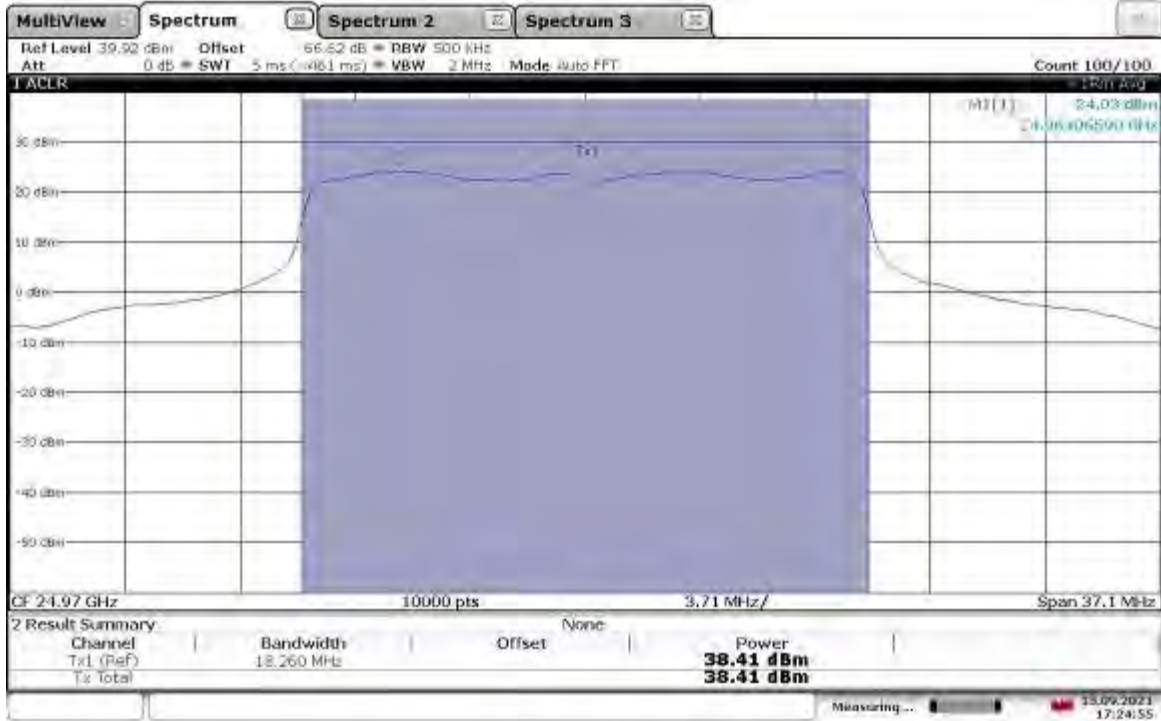

17:24:56 13.09.2021

EIRP Output Power (Horizontal Polarity) – 25.09GHz_20MHz BW_MCS8_att0.5_Mixer24

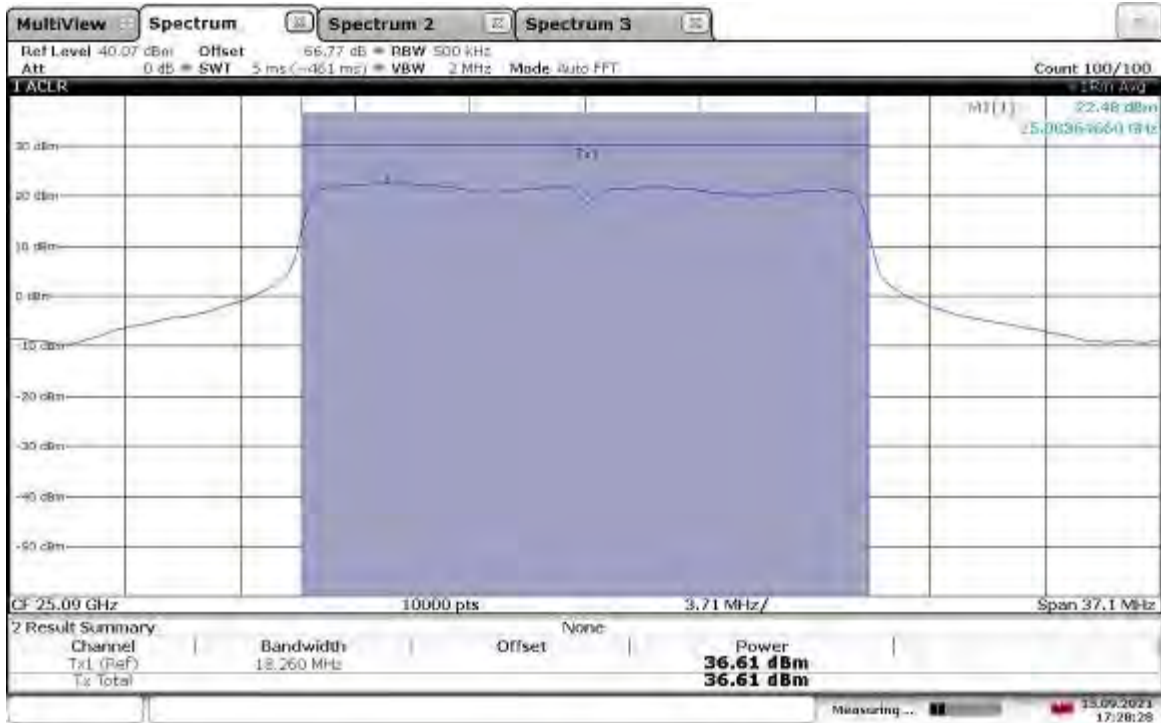

17:28:29 13.09.2021

EIRP Output Power (Vertical Polarity) – 24.34_160MHz BW_MCS0_att0.5_Mixer26

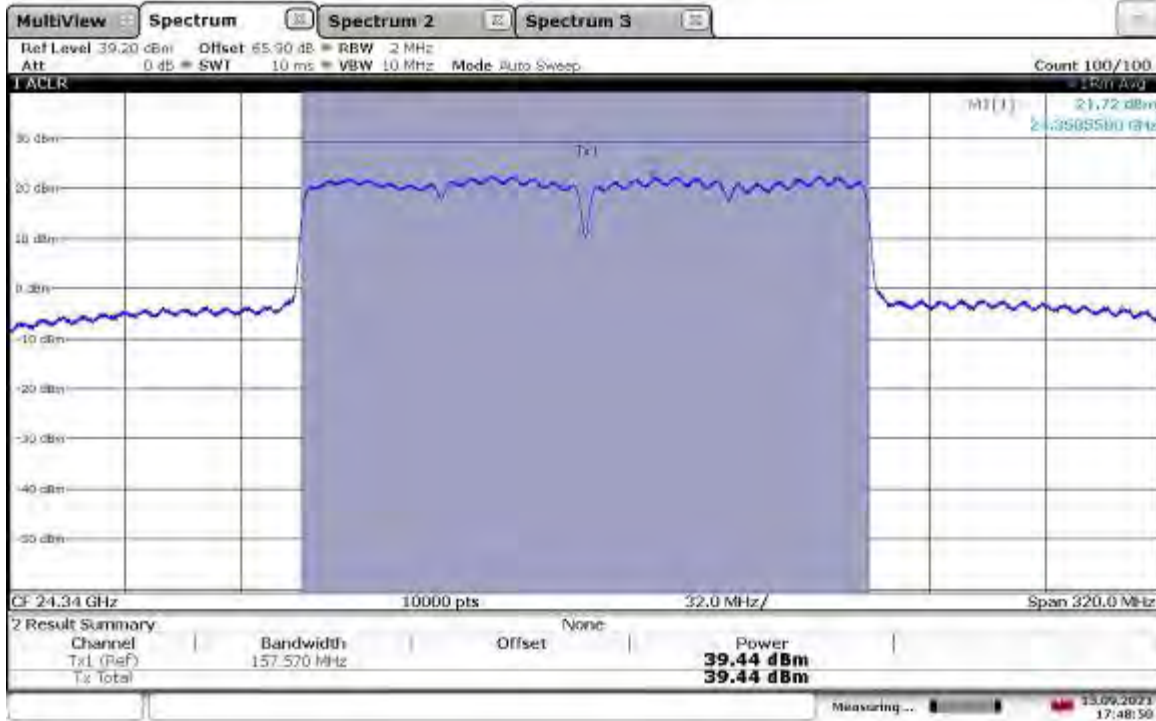

17:48:51 13.09.2021

EIRP Output Power (Vertical Polarity) – 24.35_160MHz BW_MCS0_att0.75_Mixer26

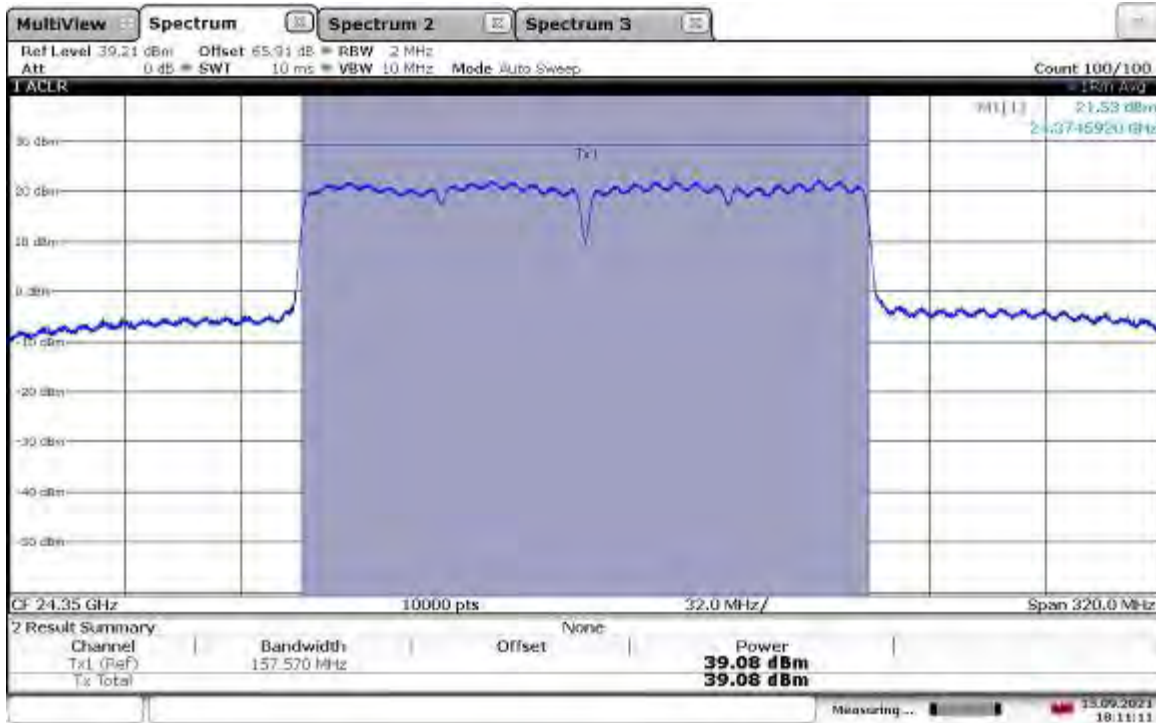

18:11:11 13.09.2021

EIRP Output Power (Vertical Polarity) – 24.36_160MHz BW_MCS0_att0.25_Mixer26

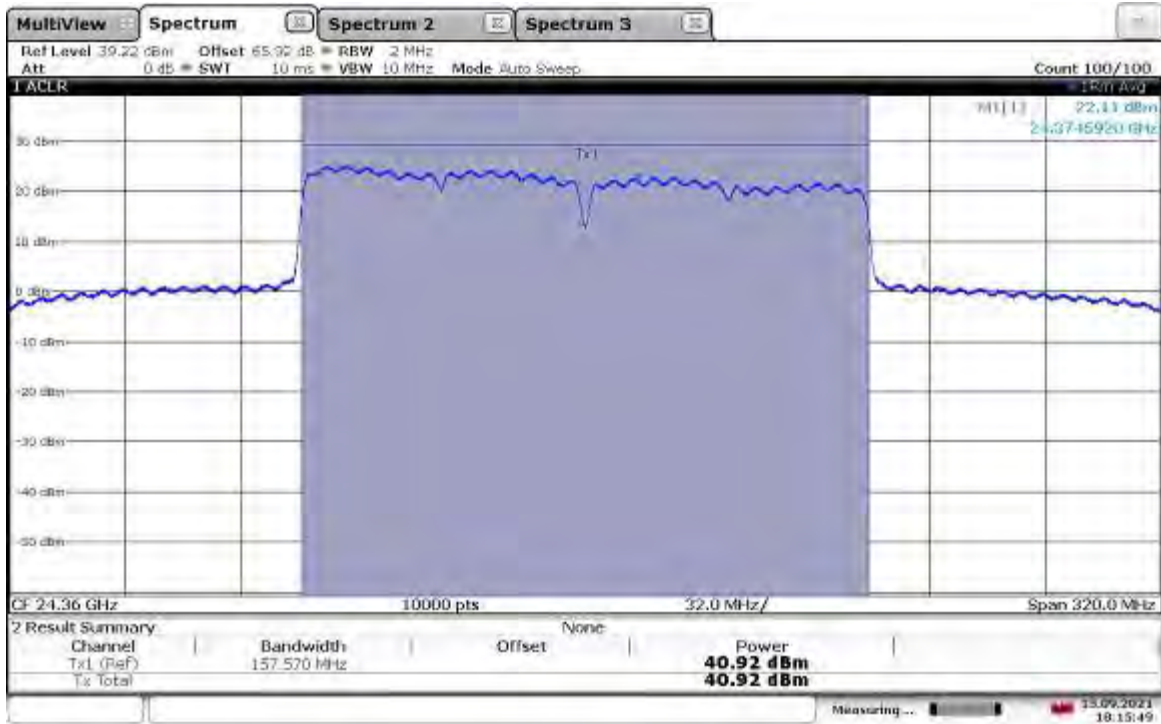

EIRP Output Power (Vertical Polarity) – 24_24.84_160MHz BW_MCS0_att0.25_Mixer23

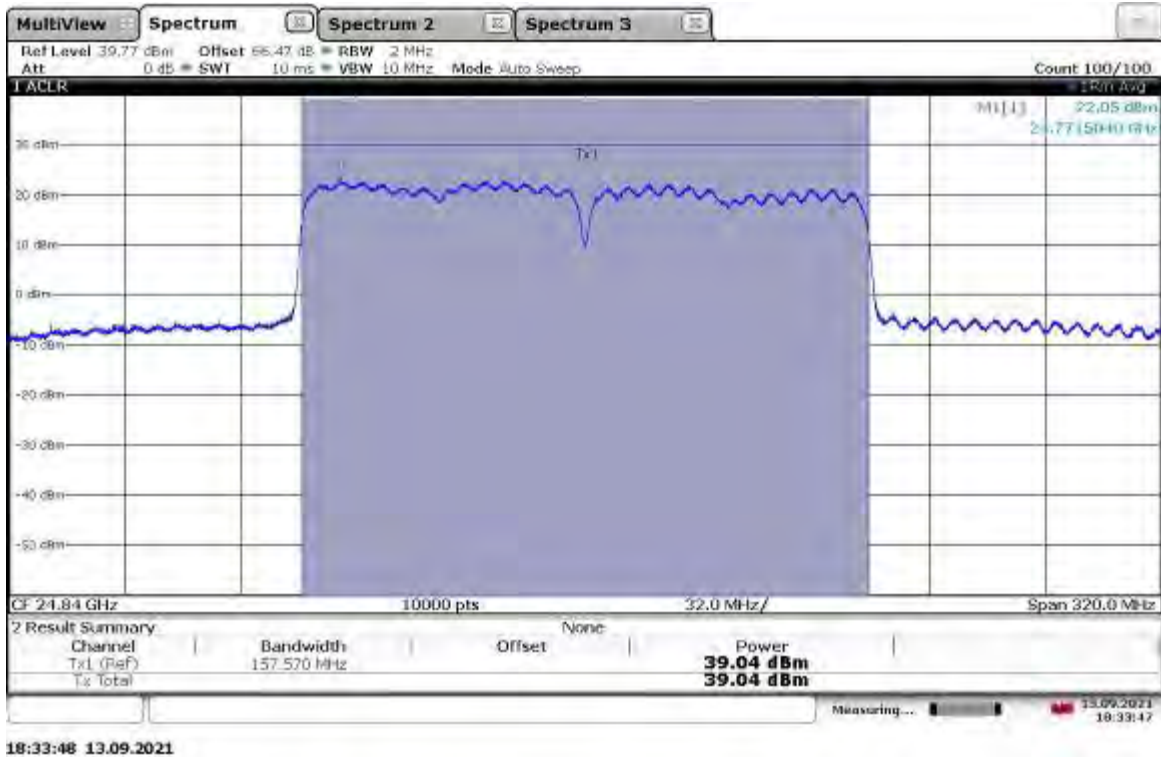

EIRP Output Power (Vertical Polarity) – 25.04_160MHz BW_MCS0_att0.5_Mixer23

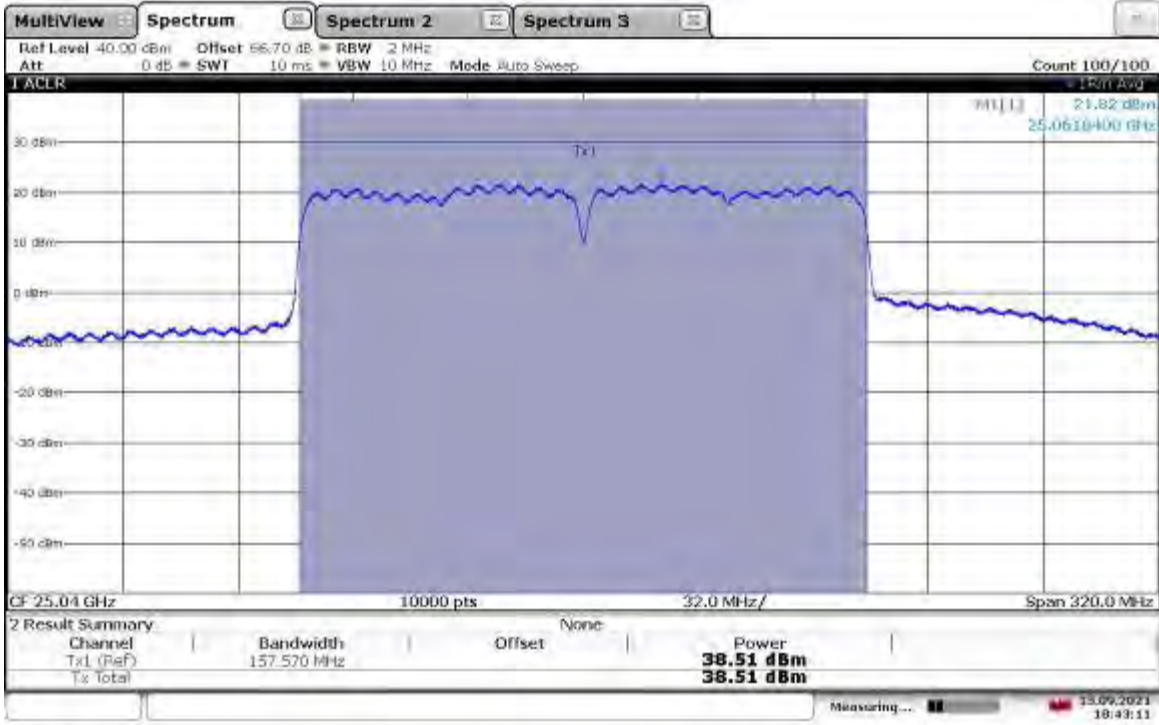

18:43:12 13.09.2021

EIRP Output Power (Vertical Polarity) – 25.16_160MHz BW_MCS0_att0.5_Mixer23

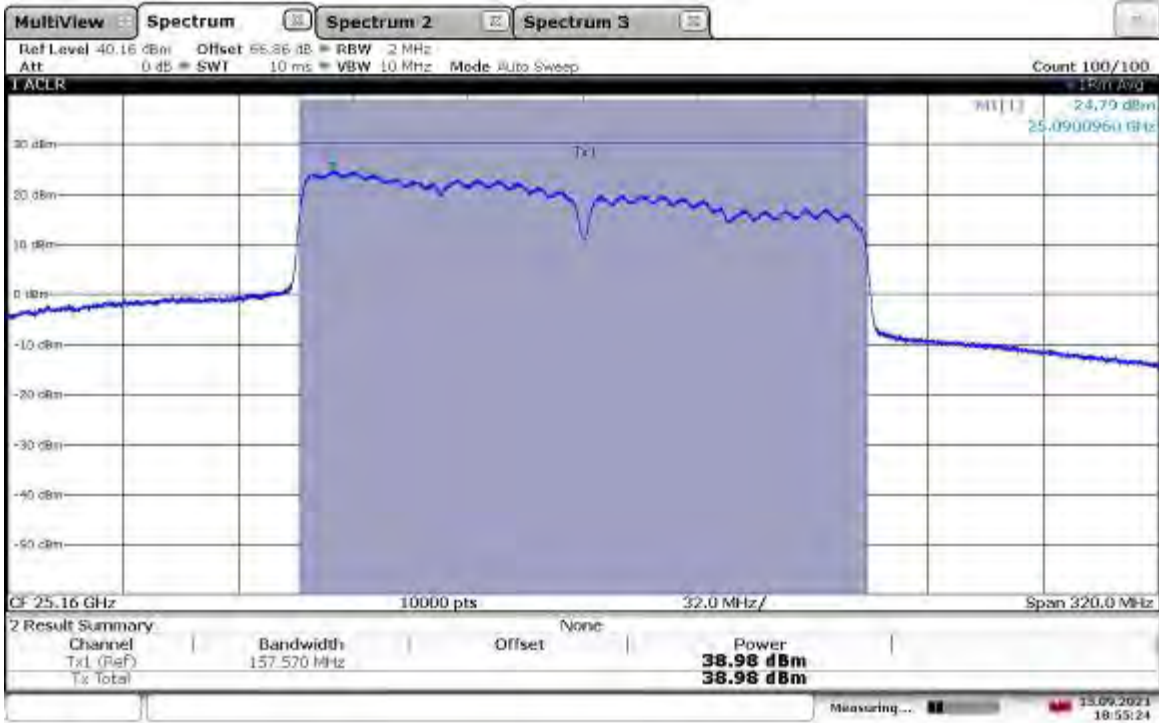

18:55:24 13.09.2021

EIRP Output Power (Horizontal Polarity) – 24.34_160MHz BW_MCS0_att0.25_Mixer27

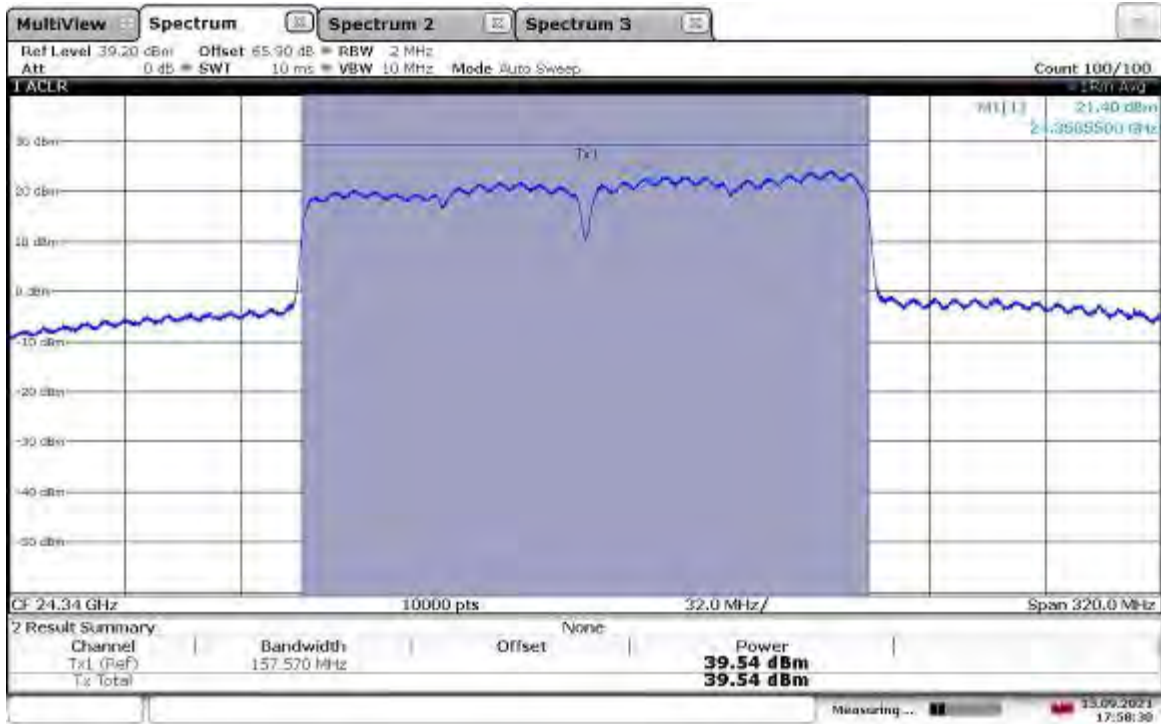

17:58:31 13.09.2021

EIRP Output Power (Horizontal Polarity) – 24.35_160MHz BW_MCS0_att0.75_Mixer27

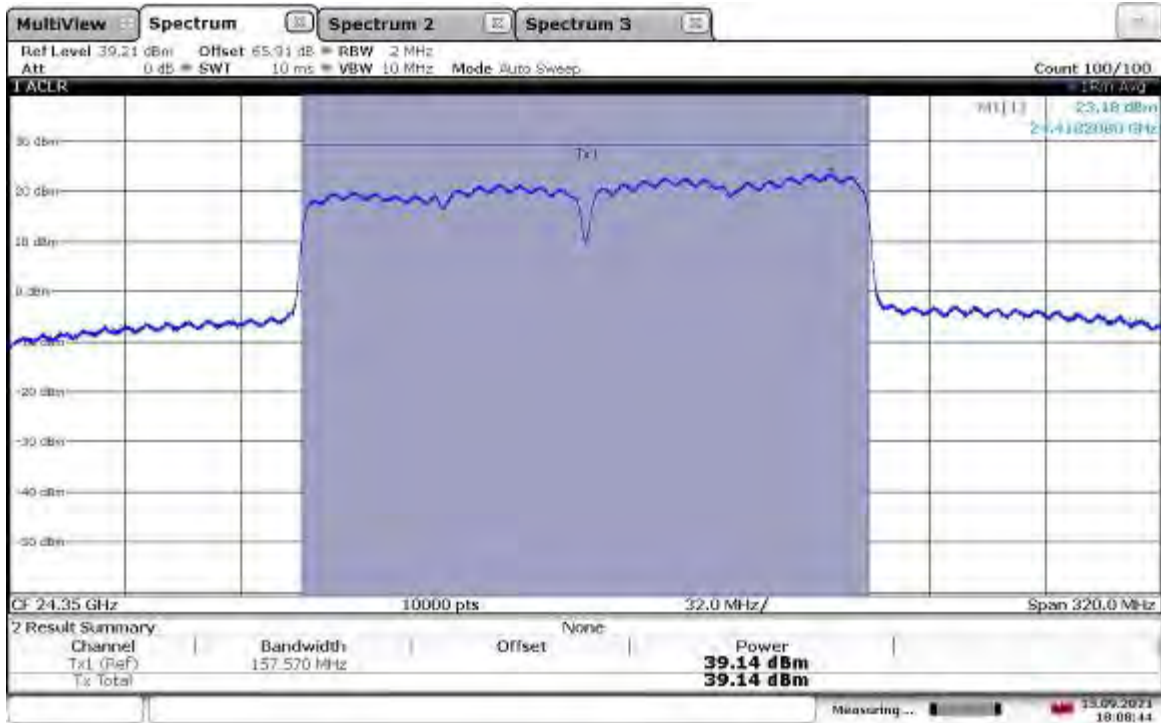

18:08:45 13.09.2021

EIRP Output Power (Horizontal Polarity) – 24.36_160MHz BW_MCS0_att0.5_Mixer27

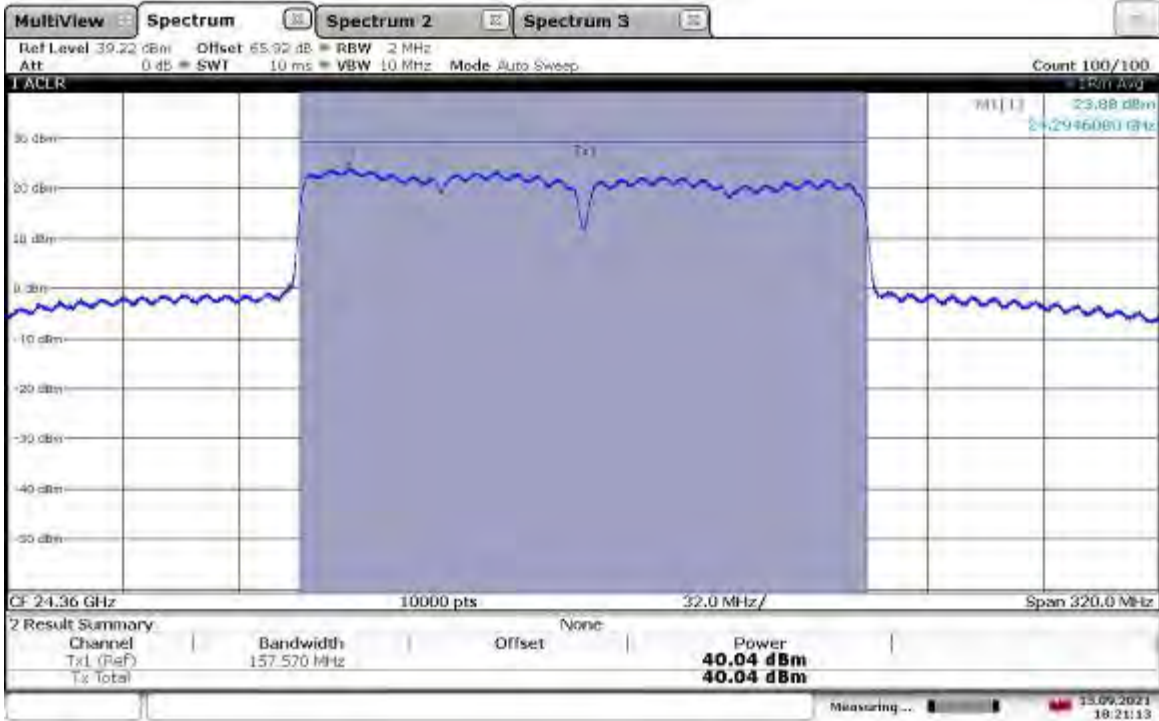

EIRP Output Power (Horizontal Polarity) – 24.84GHz_160BW_MCS0_att0.75_Mixer25

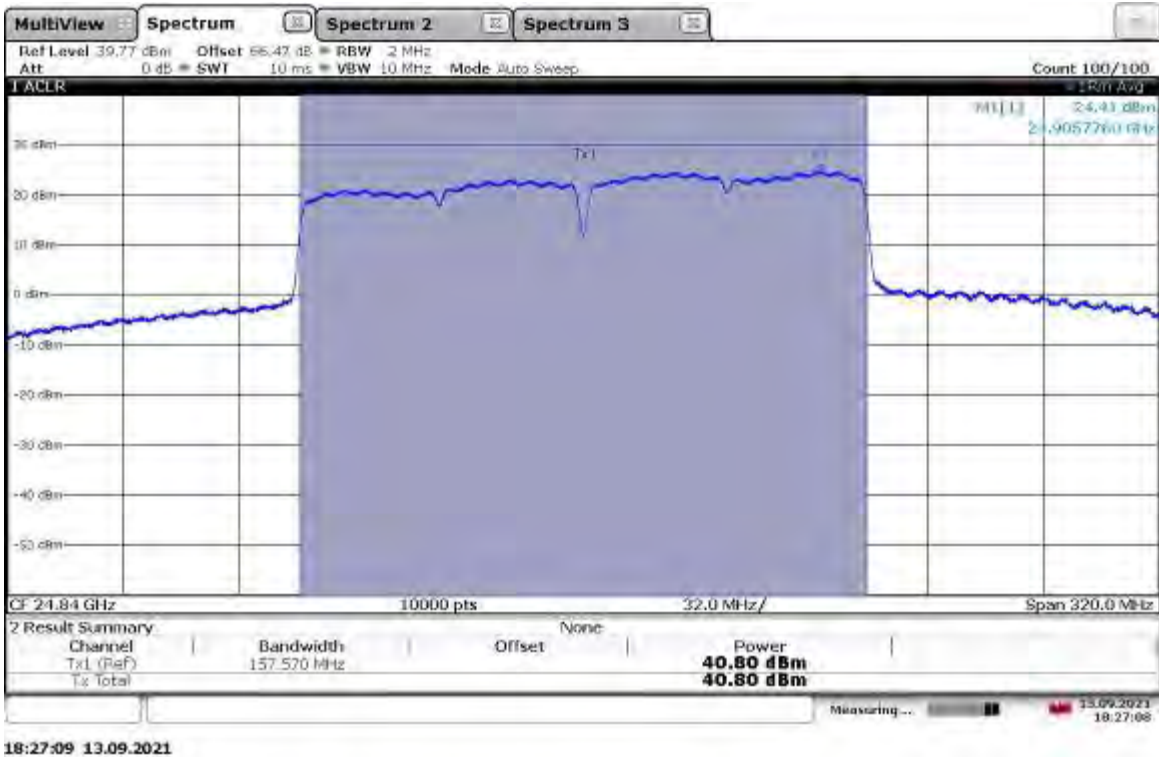

EIRP Output Power (Horizontal Polarity) – 25.04GHz_160MHz BW_MCS0_att0.5_Mixer24

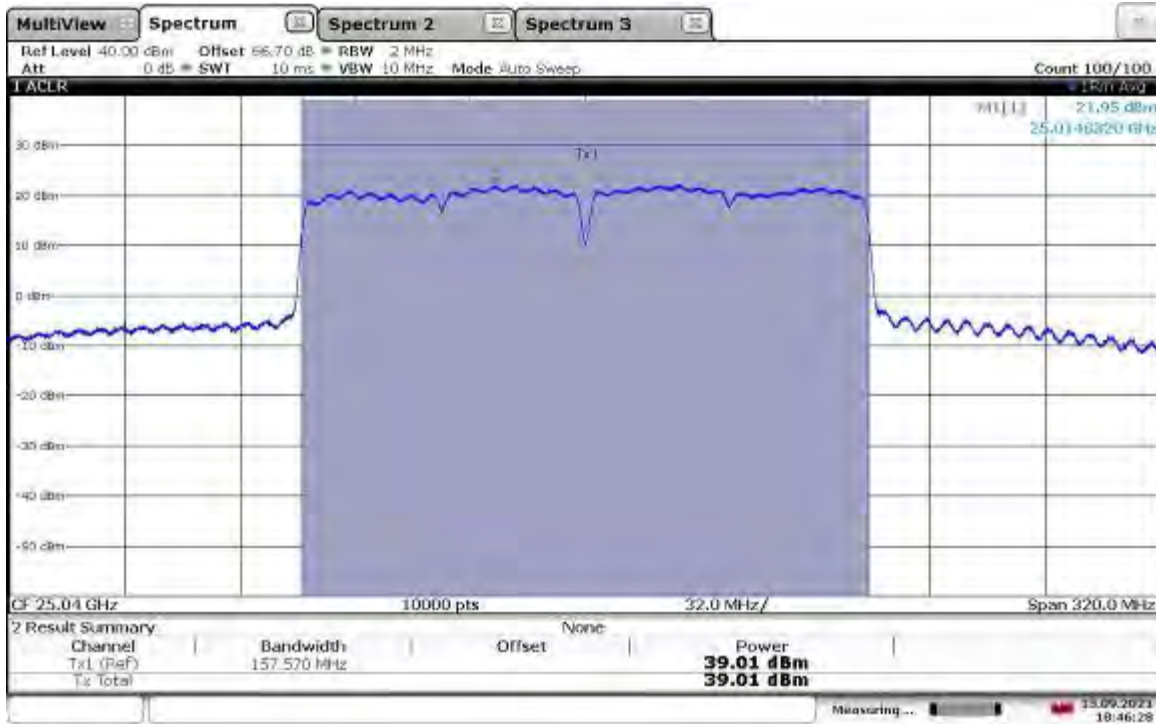

18:46:29 13.09.2021

EIRP Output Power (Horizontal Polarity) – 25.16GHz_160MHz BW_MCS0_att0_Mixer24

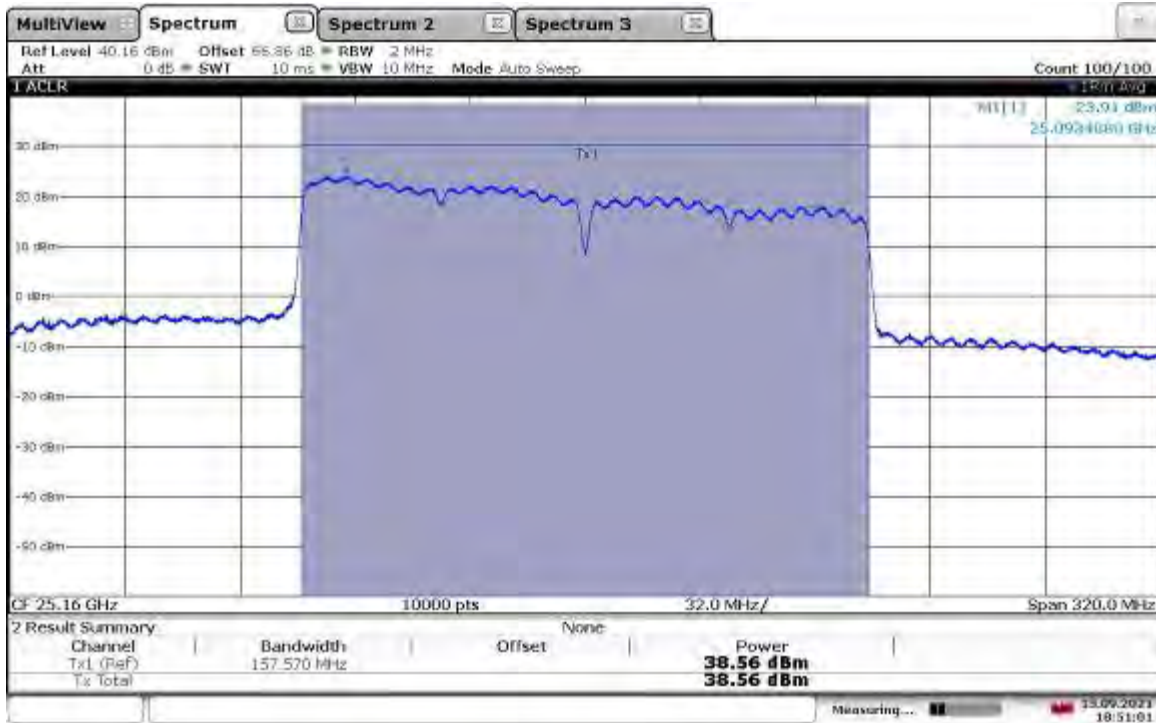

18:51:01 13.09.2021

Intertek

Report Number: 104723800BOX-001

Issued: 10/29/2021

Revised: 11/08/2021

11/10/2021

Intertek

Report Number: 104723800BOX-001	Issued: 10/29/2021 Revised: 11/08/2021 11/10/2021
---------------------------------	---

Test Personnel: <u>Vathana F. Ven <i>VFK</i></u> Supervising/Reviewing Engineer: (Where Applicable) <u>N/A</u> Product Standard: <u>FCC 47CFR Part 30 Subpart C</u> Input Voltage: <u>48 VDC Via External P/S</u> Pretest Verification w/ BB Source: <u>Yes</u>	Test Date: <u>09/13/2021</u> Limit Applied: <u>See Report Section 6.3</u> Ambient Temperature: <u>27 °C</u> Relative Humidity: <u>31 %</u> Atmospheric Pressure: <u>1008 mbars</u>
--	--

Deviations, Additions, or Exclusions: None

Report Number: 104723800BOX-001	Issued: 10/29/2021 Revised: 11/08/2021 11/10/2021
---------------------------------	---

7 Out of Band (OOB) Domain

7.1 Requirements

FCC §30.203 Emission limits.

- (a) The conductive power or the total radiated power of any emission outside a licensee's frequency block shall be -13 dBm/MHz or lower. However, in the bands immediately outside and adjacent to the licensee's frequency block, having a bandwidth equal to 10 percent of the channel bandwidth, the conductive power or the total radiated power of any emission shall be -5 dBm/MHz or lower.
- (b)
 - (1) Compliance with this provision is based on the use of measurement instrumentation employing a resolution bandwidth of 1 megahertz or greater.
 - (2) When measuring the emission limits, the nominal carrier frequency shall be adjusted as close to the licensee's frequency block edges as the design permits.
 - (3) The measurements of emission power can be expressed in peak or average values

7.2 Method

Tests are performed in accordance with FCC 47CFR Part 30 Subpart C and KDB 842590 D01 Upper Microwave Flexible Use Service v01r02 April 20, 2021 Subclause 4.4.2. The measurement was made on the maximum field strength in the same worst-case orientation as in report Section 6.1

TEST SITE: 10m ALSE

The 10m ALSE is 13m (Length) x 21m (Depth) x 10m (Height) with the effective size in terms of space from the tips of the absorber is 12m (Length) x 20m (Depth) x 8.5m (Height). This chamber achieves broadband performance using a unique arrangement of hybrid and ferrite tile absorber. This chamber has a built in 3m diameter turntable (Embedded type). The metal structure of the table makes electrical connection around the entire circumference of the turntable to the ground plane with a metal brush type connection. The turntable is located on one end of the chamber and the antennas are mounted 3 and 10 meters away at the other end of the chamber on the adjustable an Antenna Mast. The antenna mast is a non-conductive bore sighted type with remote control of antenna height and polarization. The Antenna Mast and the turntable can be remotely controlled through the controller located in the adjacent Control room. A Styrofoam table 80 cm high is used for table-top equipment.

Measurement Uncertainty

Measurement	Frequency Range	Expanded Uncertainty (k=2)
Radiated Emissions, 10m	30-1000 MHz	5.0 dB
Radiated Emissions, 3m	30-1000 MHz	4.6 dB
Radiated Emissions, 3m	1-6 GHz	4.9 dB
Radiated Emissions, 3m	6-15 GHz	5.1 dB
Radiated Emissions, 3m	15-18 GHz	4.7 dB
Radiated Emissions, 3m	18-40 GHz	4.7 dB

Sample Calculation

The field strength is calculated by adding the Antenna Factor and Cable Factor, and subtracting the Amplifier Gain (if any) from the measured reading. The basic equation with a sample calculation is as follows:

$$FS = RA + AF + CF - AG$$

Where

FS = Field Strength in dB μ V/m

RA = Receiver Amplitude (including preamplifier) in dB μ V

CF = Cable Attenuation Factor in dB

AF = Antenna Factor in dB

AG = Amplifier Gain in dB

In the following table(s), the reading shown on the data table reflects the preamplifier gain. An example for the calculations in the following table is as follows.

Assume a receiver reading of 52.0 dB μ V is obtained. The antenna factor of 7.4 dB and cable factor of 1.6 dB is added. The amplifier gain of 29 dB is subtracted, giving a field strength of 32 dB μ V/m. This value in dB μ V/m was converted to its corresponding level in μ V/m.

$$RA = 52.0 \text{ dB}\mu\text{V}$$

$$AF = 7.4 \text{ dB/m}$$

$$CF = 1.6 \text{ dB}$$

$$AG = 29.0 \text{ dB}$$

$$FS = 32 \text{ dB}\mu\text{V/m}$$

To convert from dB μ V to μ V or mV the following was used:

$$UF = 10^{(NF / 20)} \text{ where UF = Net Reading in } \mu\text{V}$$

$$NF = \text{Net Reading in dB}\mu\text{V}$$

Example:

$$FS = RA + AF + CF - AG = 52.0 + 7.4 + 1.6 - 29.0 = 32.0$$

$$UF = 10^{(32 \text{ dB}\mu\text{V} / 20)} = 39.8 \mu\text{V/m}$$

Alternately, when BAT-EMC Emission Software is used, the "Level" includes all losses and gains and is compared directly in the "Margin" column to the "Limit". The "Correction" includes Antenna Factor, Preamp, and Cable Loss. These are already accounted for in the "Level" column.

Intertek

Report Number: 104723800BOX-001

Issued: 10/29/2021

Revised: 11/08/2021

11/10/2021

7.3 Test Equipment Used:

Asset	Description	Manufacturer	Model	Serial	Cal Date	Cal Due
DAV007	Weather Station Vantage Vue	Davis	6250	MS191212003	03/20/2021	03/20/2022
EMC04	ANTENNA, RIDGED GUIDE, 18-40 GHZ	EMCO	3116	2090	01/28/2021	01/28/2022
ROS005-1	Signal and Spectrum Analyzer	Rohde and Shwartz	FSW43	100646	10/27/2020	10/27/2021
CBLHF2012-5M-2	5m 9kHz-40GHz Coaxial Cable - SET2	Huber & Suhner	SF102	252676002	02/19/2021	02/19/2022

Software Utilized:

Name	Manufacturer	Version
None	--	--

7.4 Results:

The sample tested was found to Comply.

Report Number: 104723800BOX-001	Issued: 10/29/2021 Revised: 11/08/2021 11/10/2021
---------------------------------	---

7.5 Setup Photographs:

Confidential – Photo not included in this report

7.6 Plots/Data:

Authorized Band 24.25-24.45 GHz, Emission Mask (Vertical Polarity) – 24.27GHz_20MHz BW_MCS8_att0_Mixer28
Lower Edge – From Mark 1 to Mark 2 the limit is -5 dBm and outside of Mark 1 to the left the limit is -13 dBm

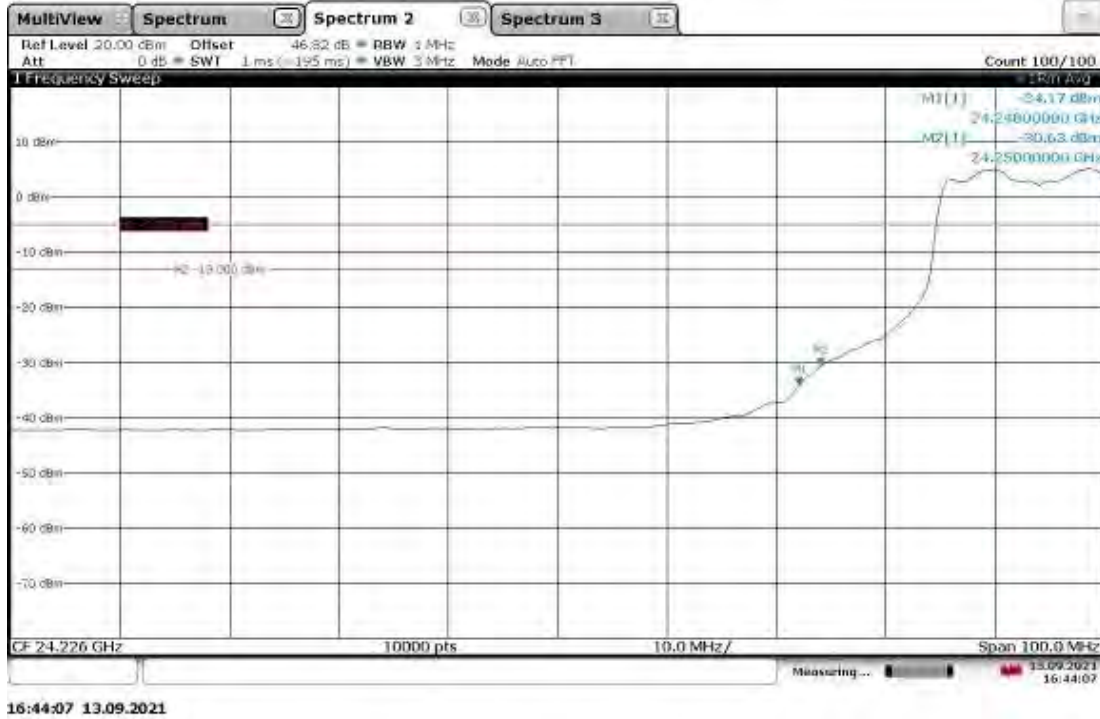

Authorized Band 24.25-24.45 GHz, Emission Mask (Horizontal Polarity) – 24.27GHz_20MHz
BW_MCS8_att0_Mixer28
Lower Edge – From Mark 1 to Mark 2 the limit is -5 dBm and outside of Mark 1 to the left the limit is -13 dBm

Intertek

Report Number: 104723800BOX-001

Issued: 10/29/2021

Revised: 11/08/2021

11/10/2021



16:44:07 13.09.2021

Intertek

Report Number: 104723800BOX-001

Issued: 10/29/2021

Revised: 11/08/2021

11/10/2021

Authorized Band 24.25-24.45 GHz, Emission Mask (Vertical Polarity) – 24.29GHz_20MHz

BW_MCS8_att0.75_Mixer27

Upper Edge – From Mark 1 to Mark 2 the limit is -5 dBm and outside of Mark 1 to the left the limit is -13 dBm



16:59:11 13.09.2021

Authorized Band 24.25-24.45 GHz, Emission Mask (Horizontal Polarity) – 24.29GHz_20MHz

BW_MCS8_att0.25_Mixer28

Upper Edge – From Mark 1 to Mark 2 the limit is -5 dBm and outside of Mark 1 to the left the limit is -13 dBm

Intertek

Report Number: 104723800BOX-001

Issued: 10/29/2021

Revised: 11/08/2021

11/10/2021

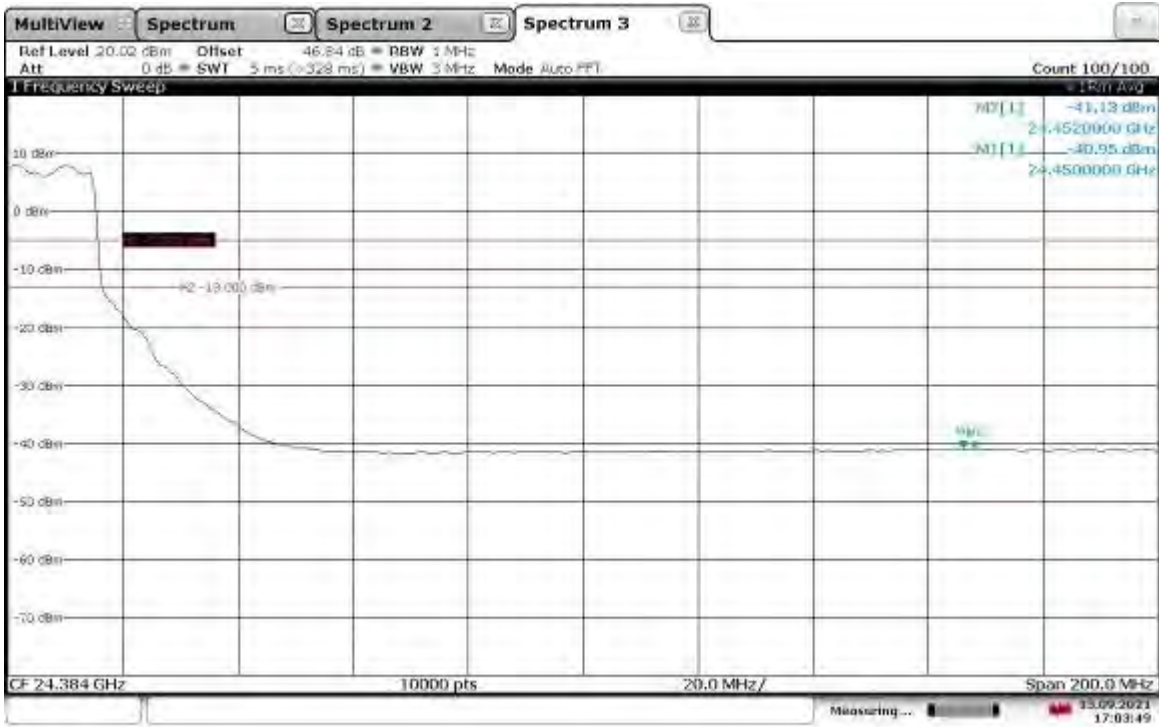

17:03:50 13.09.2021

Authorized Band 24.75-25.25 GHz, Emission Mask (Vertical Polarity) – 24.77GHz_20MHz BW_MCS8_att0_Mixer24
Lower Edge – From Mark 1 to Mark 2 the limit is -5 dBm and outside of Mark 1 to the left the limit is -13 dBm



17:15:31 13.09.2021

Authorized Band 24.75-25.25 GHz, Emission Mask (Horizontal Polarity) – 24.77GHz_20MHz
BW_MCS8_att0_Mixer28

Lower Edge – From Mark 1 to Mark 2 the limit is -5 dBm and outside of Mark 1 to the left the limit is -13 dBm

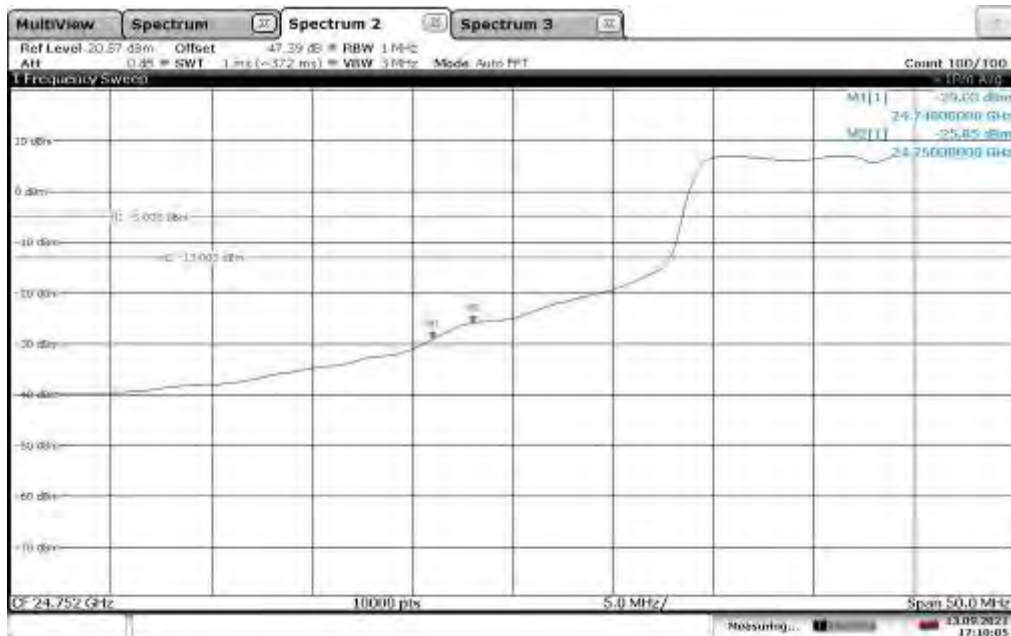

17:10:05 13.09.2021

Authorized Band 24.75-25.25 GHz, Emission Mask (Vertical Polarity) – 24.77GHz_20MHz

BW_MCS8_att0.75_Mixer23

Upper Edge – From Mark 1 to Mark 2 the limit is -5 dBm and outside of Mark 1 to the left the limit is -13 dBm

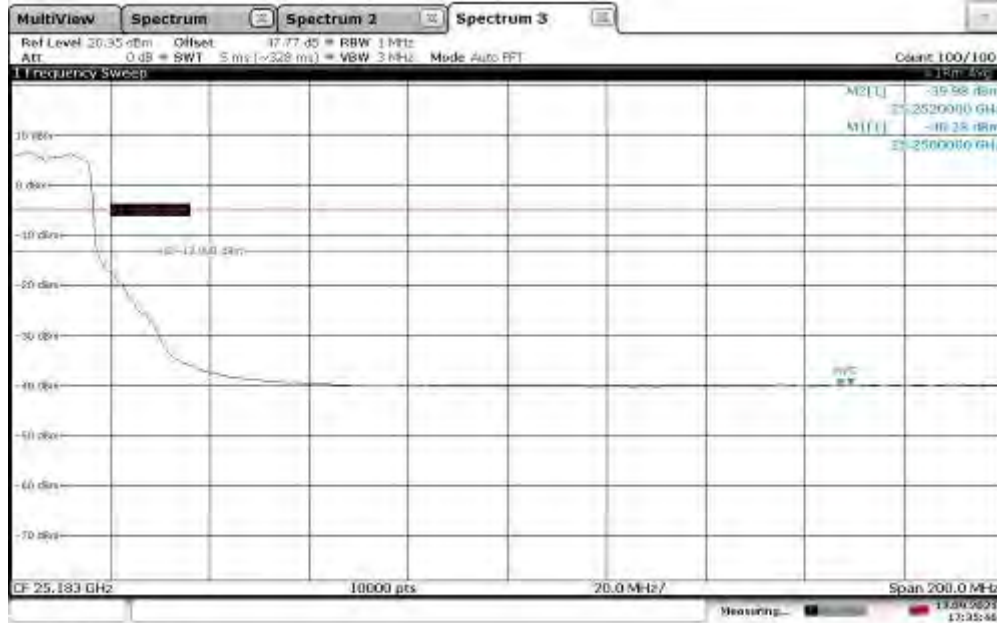

17:35:47 13.09.2021

Authorized Band 24.75-25.25 GHz, Emission Mask (Horizontal Polarity) – 24.77GHz_20MHz

BW_MCS8_att0.5_Mixer24

Upper Edge – From Mark 1 to Mark 2 the limit is -5 dBm and outside of Mark 1 to the left the limit is -13 dBm

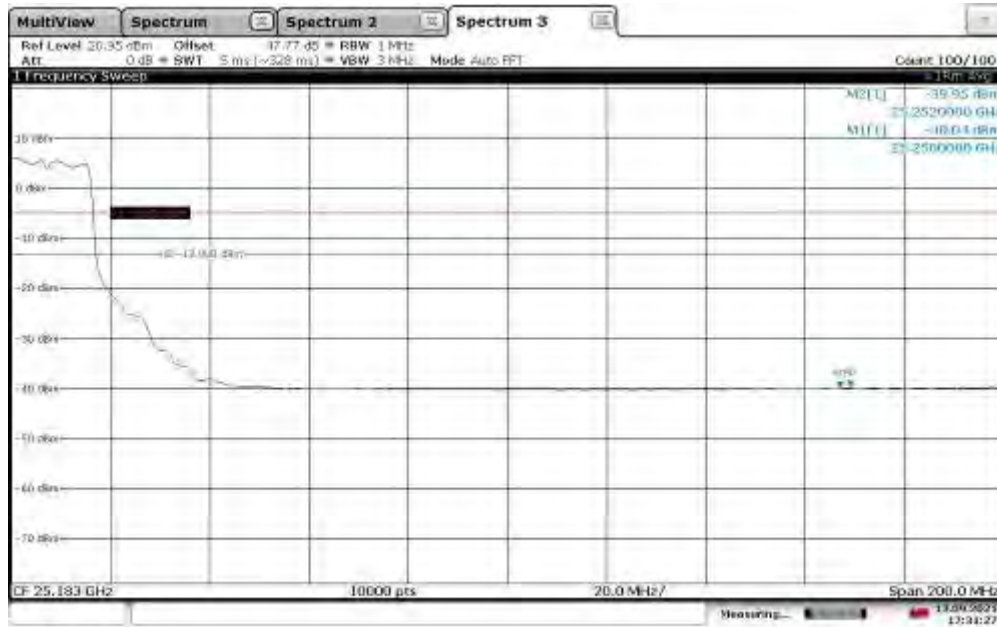

17:31:28 13.09.2021

Authorized Band 24.25-24.45 GHz, Emission Mask (Vertical Polarity) – 24.34GHz_160MHz
BW_MCS0_att0.5_Mixer26

Lower Edge – From Mark 1 to Mark 2 the limit is -5 dBm and outside of Mark 1 to the left the limit is -13 dBm

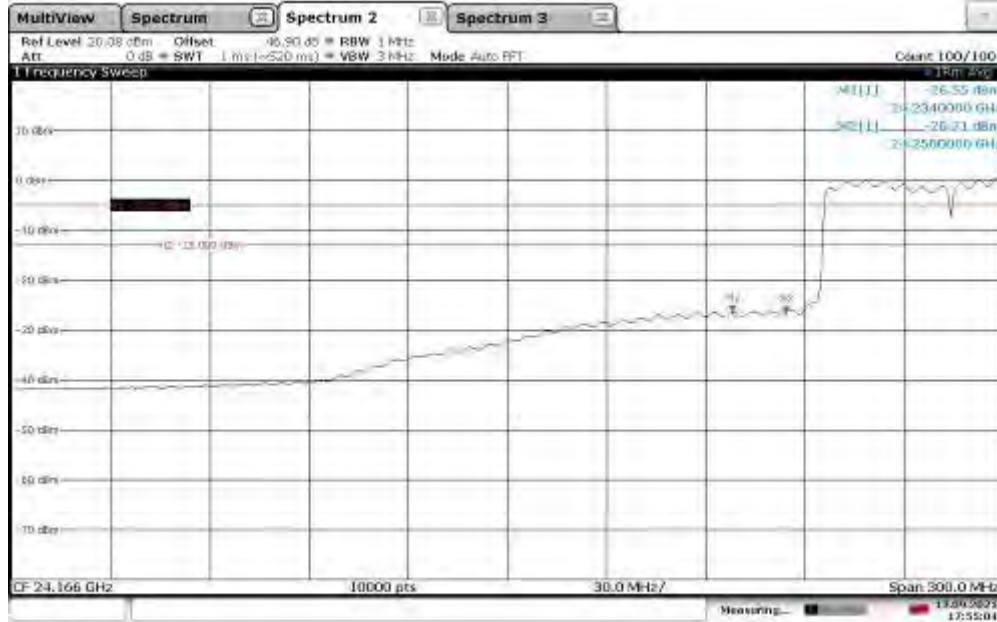

17:55:05 13.09.2021

Authorized Band 24.25-24.45 GHz, Emission Mask (Horizontal Polarity) – 24.34GHz_160MHz
BW_MCS0_att0.25_Mixer27

Lower Edge – From Mark 1 to Mark 2 the limit is -5 dBm and outside of Mark 1 to the left the limit is -13 dBm

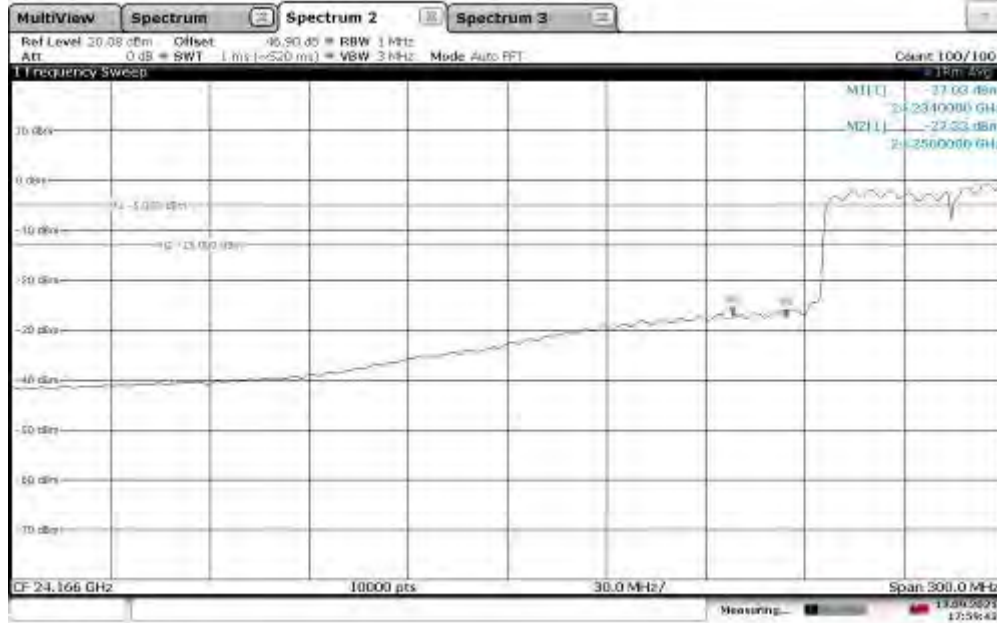

17:59:44 13.09.2021

Authorized Band 24.25-24.45 GHz, Emission Mask (Vertical Polarity) – 24.36GHz_160MHz
BW_MCS0_att0.25_Mixer26

Upper Edge – From Mark 1 to Mark 2 the limit is -5 dBm and outside of Mark 1 to the left the limit is -13 dBm

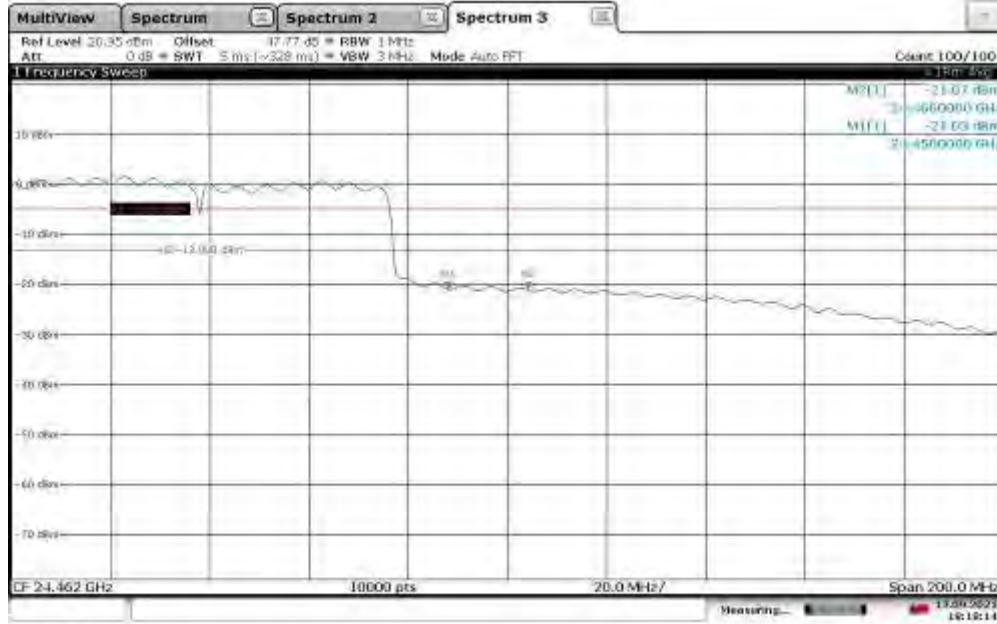

18:18:14 13.09.2021

Authorized Band 24.25-24.45 GHz, Emission Mask (Horizontal Polarity) – 24.36GHz_160MHz
BW_MCS0_att0.5_Mixer27

Upper Edge – From Mark 1 to Mark 2 the limit is -5 dBm and outside of Mark 1 to the left the limit is -13 dBm

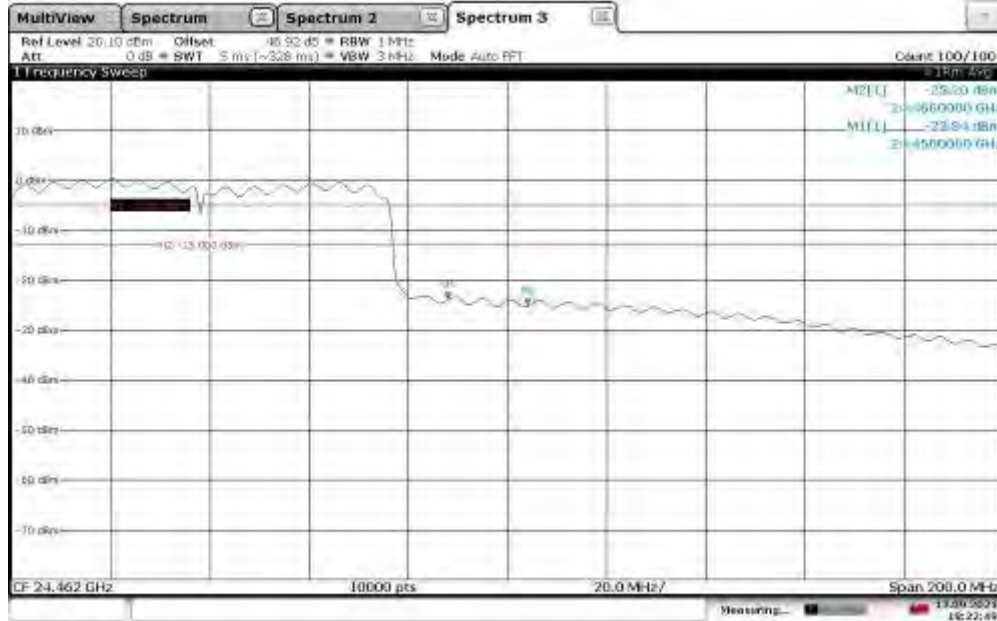

18:22:50 13.09.2021

Authorized Band 24.75-25.25 GHz, Emission Mask (Vertical Polarity) – 24.84GHz_160MHz
BW_MCS0_att0.25_Mixer23

Lower Edge – From Mark 1 to Mark 2 the limit is -5 dBm and outside of Mark 1 to the left the limit is -13 dBm

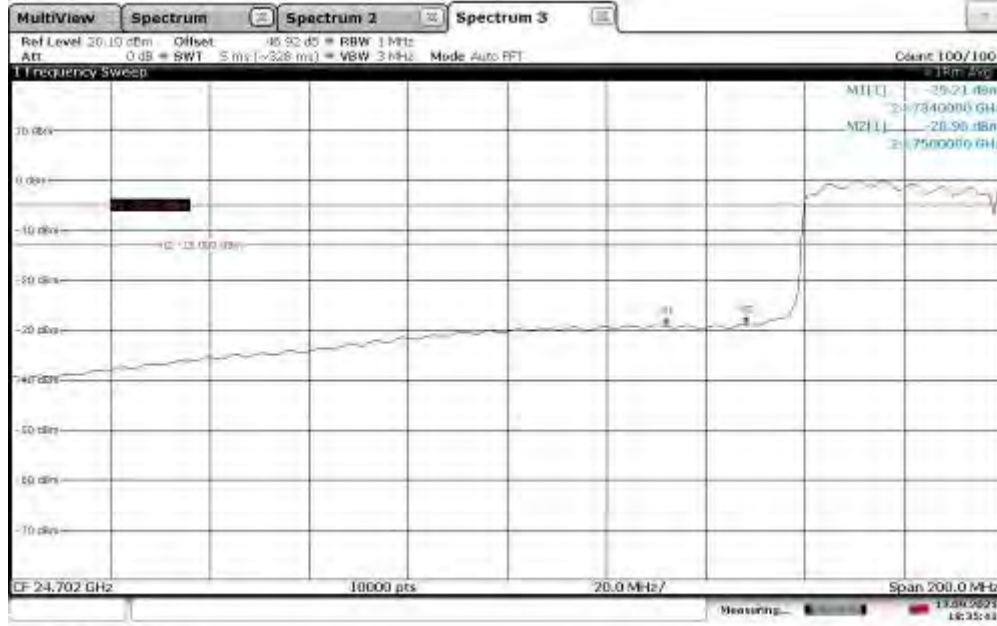

Authorized Band 24.75-25.25 GHz, Emission Mask (Horizontal Polarity) – 24.84GHz_160MHz
BW_MCS0_att0.75_Mixer25

Lower Edge – From Mark 1 to Mark 2 the limit is -5 dBm and outside of Mark 1 to the left the limit is -13 dBm

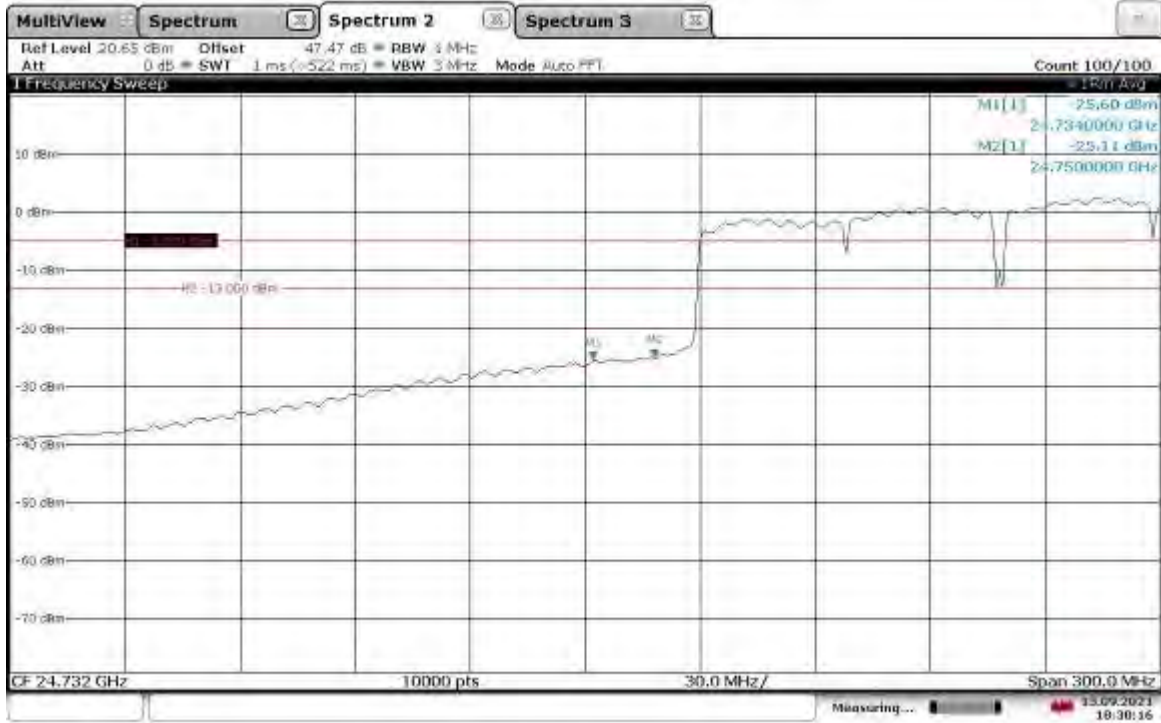

Authorized Band 24.75-25.25 GHz, Emission Mask (Vertical Polarity) – 25.16GHz_160MHz
BW_MCS0_att0.5_Mixer23

Upper Edge – From Mark 1 to Mark 2 the limit is -5 dBm and outside of Mark 1 to the left the limit is -13 dBm

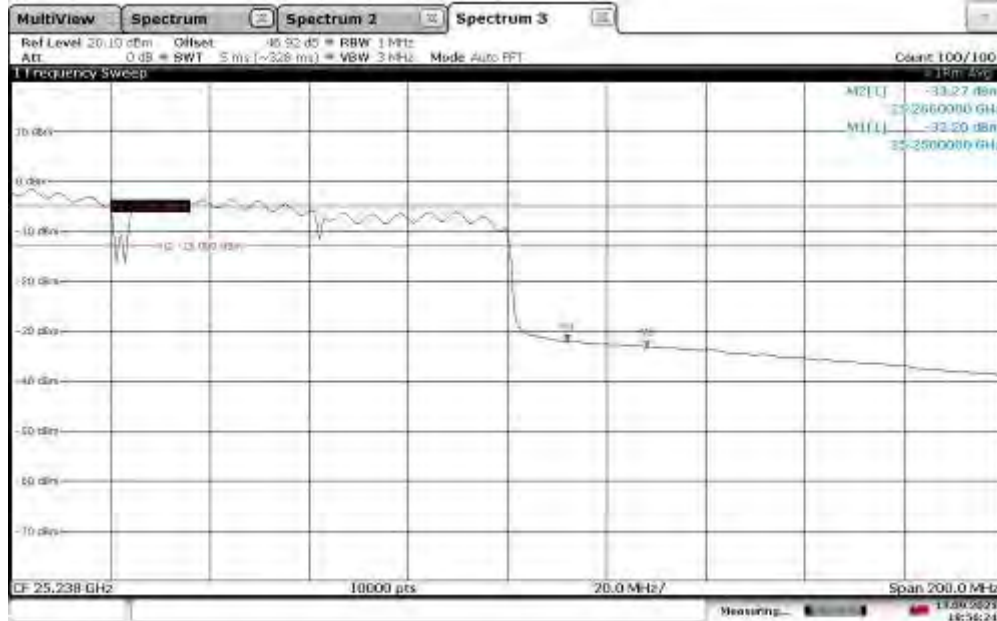

18:56:25 13.09.2021

Authorized Band 24.75-25.25 GHz, Emission Mask (Vertical Polarity) – 25.16GHz_160MHz
BW_MCS0_att0_Mixer24

Upper Edge – From Mark 1 to Mark 2 the limit is -5 dBm and outside of Mark 1 to the left the limit is -13 dBm

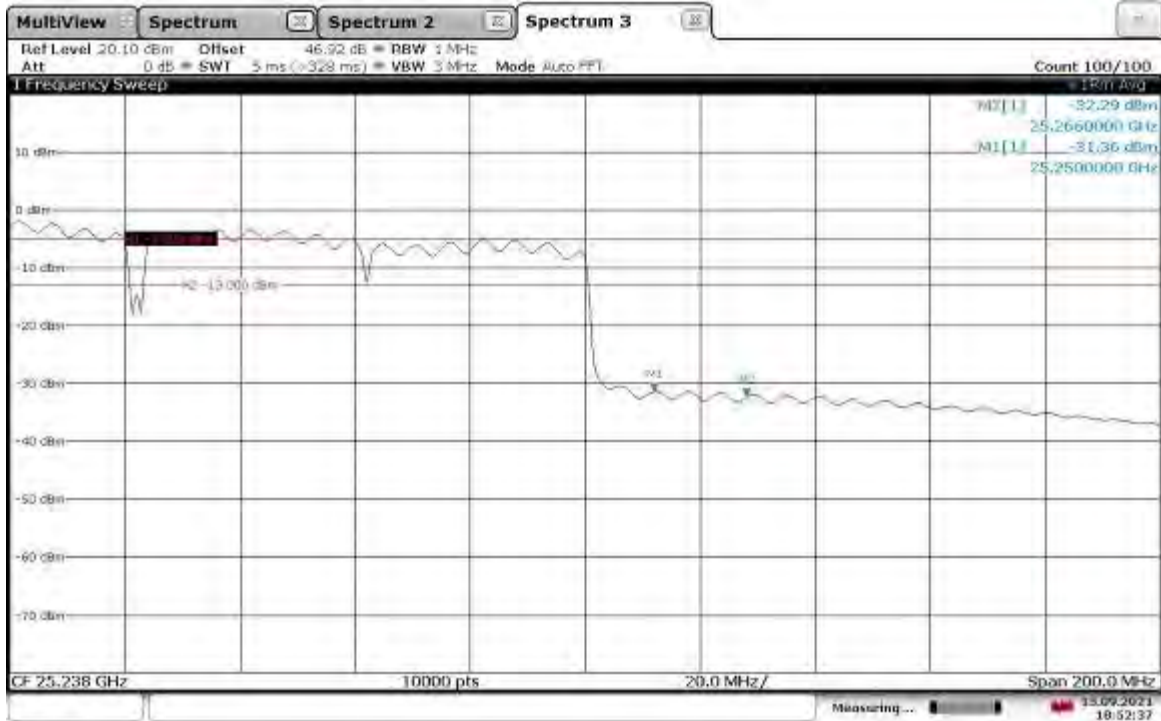

18:52:37 13.09.2021

Intertek

Report Number: 104723800BOX-001	Issued: 10/29/2021 Revised: 11/08/2021 11/10/2021
---------------------------------	---

Test Personnel: <u>Vathana F. Ven <i>VFK</i></u> Supervising/Reviewing Engineer: (Where Applicable) <u>N/A</u> Product Standard: <u>FCC 47CFR Part 30 Subpart C and E</u> Input Voltage: <u>48 VDC Via External P/S</u> Pretest Verification w/ BB Source: <u>Yes</u>	Test Date: <u>09/13/2021</u> Limit Applied: <u>See Report Section 7.3</u> Ambient Temperature: <u>27 °C</u> Relative Humidity: <u>31 %</u> Atmospheric Pressure: <u>1008 mbars</u>
--	--

Deviations, Additions, or Exclusions: None

Report Number: 104723800BOX-001	Issued: 10/29/2021 Revised: 11/08/2021 11/10/2021
---------------------------------	---

8 Radiated Spurious Emissions

8.1 Requirements

FCC §30.203 Emission limits.

- (a) The conductive power or the total radiated power of any emission outside a licensee's frequency block shall be -13 dBm/MHz or lower. However, in the bands immediately outside and adjacent to the licensee's frequency block, having a bandwidth equal to 10 percent of the channel bandwidth, the conductive power or the total radiated power of any emission shall be -5 dBm/MHz or lower.
- (b)
 - (1) Compliance with this provision is based on the use of measurement instrumentation employing a resolution bandwidth of 1 megahertz or greater.
 - (2) When measuring the emission limits, the nominal carrier frequency shall be adjusted as close to the licensee's frequency block edges as the design permits.
 - (3) The measurements of emission power can be expressed in peak or average values

8.2 Method

Tests are performed in accordance with FCC 47CFR Part 30 Subpart C and KDB 842590 D01 Upper Microwave Flexible Use Service v01r02 April 20, 2021 Subclause 4.4.3. From 9kHz-1000 MHz and 1-13 GHz the measurements were made at 10 meters using the BAT-EMC automated software. From 13-100 GHz measurement was made manually at 3 meters with test antenna and EUT fixed at 1.5 meters high. The EUT was rotated from 0 to 360 degrees to find the worst-case emissions.

TEST SITE: 10m ALSE

The 10m ALSE is 13m (Length) x 21m (Depth) x 10m (Height) with the effective size in terms of space from the tips of the absorber is 12m (Length) x 20m (Depth) x 8.5m (Height). This chamber achieves broadband performance using a unique arrangement of hybrid and ferrite tile absorber. This chamber has a built in 3m diameter turntable (Embedded type). The metal structure of the table makes electrical connection around the entire circumference of the turntable to the ground plane with a metal brush type connection. The turntable is located on one end of the chamber and the antennas are mounted 3 and 10 meters away at the other end of the chamber on the adjustable an Antenna Mast. The antenna mast is a non-conductive bore sighted type with remote control of antenna height and polarization. The Antenna Mast and the turntable can be remotely controlled through the controller located in the adjacent Control room. A Styrofoam table 80 cm high is used for table-top equipment.

Measurement Uncertainty

Measurement	Frequency Range	Expanded Uncertainty (k=2)
Radiated Emissions, 10m	30-1000 MHz	5.0 dB
Radiated Emissions, 3m	30-1000 MHz	4.6 dB
Radiated Emissions, 3m	1-6 GHz	4.9 dB
Radiated Emissions, 3m	6-15 GHz	5.1 dB
Radiated Emissions, 3m	15-18 GHz	4.7 dB
Radiated Emissions, 3m	18-40 GHz	4.7 dB

Sample Calculation

The field strength is calculated by adding the Antenna Factor and Cable Factor, and subtracting the Amplifier Gain (if any) from the measured reading. The basic equation with a sample calculation is as follows:

$$FS = RA + AF + CF - AG$$

Where

- FS = Field Strength in dB μ V/m
- RA = Receiver Amplitude (including preamplifier) in dB μ V
- CF = Cable Attenuation Factor in dB
- AF = Antenna Factor in dB
- AG = Amplifier Gain in dB

In the following table(s), the reading shown on the data table reflects the preamplifier gain. An example for the calculations in the following table is as follows.

Assume a receiver reading of 52.0 dB μ V is obtained. The antenna factor of 7.4 dB and cable factor of 1.6 dB is added. The amplifier gain of 29 dB is subtracted, giving a field strength of 32 dB μ V/m. This value in dB μ V/m was converted to its corresponding level in μ V/m.

RA = 52.0 dB μ V
AF = 7.4 dB/m
CF = 1.6 dB
AG = 29.0 dB
FS = 32 dB μ V/m

To convert from dB μ V to μ V or mV the following was used:

$$UF = 10^{(NF / 20)} \text{ where } UF = \text{Net Reading in } \mu\text{V}$$

NF = Net Reading in dB μ V

Example:

$$FS = RA + AF + CF - AG = 52.0 + 7.4 + 1.6 - 29.0 = 32.0$$
$$UF = 10^{(32 \text{ dB}\mu\text{V} / 20)} = 39.8 \mu\text{V/m}$$

Alternately, when BAT-EMC Emission Software is used, the "Level" includes all losses and gains and is compared directly in the "Margin" column to the "Limit". The "Correction" includes Antenna Factor, Preamp, and Cable Loss. These are already accounted for in the "Level" column.

Intertek

Report Number: 104723800BOX-001

Issued: 10/29/2021
Revised: 11/08/2021
11/10/2021

8.3 Test Equipment Used:

Asset	Description	Manufacturer	Model	Serial	Cal Date	Cal Due
DAV007'	Weather Station Vantage Vue	Davis	6250	MS191212003	03/20/2021	03/20/2022
145109'	DC Block	Coaxial Components	5985-9	none	VBU	Verified
PRE11'	50dB gain pre-amp	Pasternack	PRE11	PRE11	09/11/2020	09/11/2021
145108'	EMI Test Receiver (20Hz - 40GHz)	Rohde & Schwarz	ESIB40	100209	06/22/2021	06/22/2022
HS002'	DC-18GHz cable 1.5M long	Huber & Suhner	SucoFlex 106A	HS002	11/25/2020	11/25/2021
HS003'	10m under floor cable	Huber-Schuner	10m-1	HS003	02/17/2021	02/17/2022
IW001'	2 meter cable	Insulated Wire	2801-NPS	001	10/07/2020	10/07/2021
IW006'	DC-18GHz cable 8.4m long	Insulated Wire	2800-NPS	IW006	11/25/2020	11/25/2021
IW003'	8.4 meter cable	Insulated Wire	2800-NPS	003	10/08/2020	10/08/2021
PRE12'	Pre-amplifier	Com Power	PAM-118A	18040117	12/07/2020	12/07/2021
ETS002'	1-18GHz DRG Horn Antenna	ETS Lindgren	3117	00143260	08/03/2020	08/03/2021
145-414'	Cables 145-400 145-403 145-405 145-409	Huber + Suhner	3m Track A cables	multiple	07/09/2021	07/09/2022
IW002'	2 meter Armored cable	Insulated Wire	2800-NPS	002	09/23/2020	09/23/2021
DAV007'	Weather Station Vantage Vue	Davis	6250	MS191212003	03/20/2021	03/20/2022
EMC04'	ANTENNA, RIDGED GUIDE, 18-40 GHZ	EMCO	3116	2090	01/28/2021	01/28/2022
ROS005-1'	Signal and Spectrum Analyzer	Rohde and Shwartz	FSW43	100646	10/27/2020	10/27/2021
CBLHF2012-5M-2'	5m 9kHz-40GHz Coaxial Cable - SET2	Huber & Suhner	SF102	252676002	02/19/2021	02/19/2022
ETS003'	9kHz-30MHz Active Loop Antenna	ETS Lindgren	6502	00143396	07/28/2020	07/28/2021
---	40-60 GHz Spectrum Analyzer Extension Module	Virginia Diodes, Inc.	VDIWR19.OSAX-F	SAX835	03/31/2021	03/31/2023
---	60-90 GHz Spectrum Analyzer Extension Module	Virginia Diodes, Inc.	VDIWR12.OSAX-F	SAX836	04/12/2021	04/12/2023
---	90-140 GHz Spectrum Analyzer Extension Module	Virginia Diodes, Inc.	VDIWR8.OSAX-F	SAX837	06/11/2021	06/11/2023
---	140-220 GHz Spectrum Analyzer Extension Module	Virginia Diodes, Inc.	VDIWR5.1SAX-F	SAX838	05/11/2021	05/11/2023

Software Utilized:

Name	Manufacturer	Version
BAT-EMC	Nexio	3.18.0.16
EMI Boxborough.xls	Intertek	08/27/2010

Note: Your Laptop may use a different version of Excel. Record the version you actually used!

8.4 Results:

The sample tested was found to Comply.

Report Number: 104723800BOX-001	Issued: 10/29/2021 Revised: 11/08/2021 11/10/2021
---------------------------------	---

8.5 Setup Photographs:

Confidential – Photo not included in this report

Intertek

Report Number: 104723800BOX-001	Issued: 10/29/2021 Revised: 11/08/2021 11/10/2021
---------------------------------	---

8.6 Plots/Data:

Lower Band: All channels, 160 MHz Bandwidth, MCS0 Modulation, 9 kHz-30 MHz
Radiated Spurious Emissions

Company: Starry	Antenna & Cables: LF	Bands: N, LF, HF, SHF
Model #: Comet 24	Antenna: ETS003	ETS003
Serial #: 2123000009	Cable(s): IW01, IW02, IW03	NONE.
Engineers: Vathana Ven	Location: 10m Chamber	Barometer: DAV007
Project #: G104723800	Date(s): 09/13/21	Filter: NONE
Standard: FCC Part 30, Subpart C	Temp/Humidity/Pressure: 23c	39% 1007mB
Receiver: R&S ESE (145-128) 06-22-2022	Limit Distance (m): 10	
PreAmp: PRE11	Test Distance (m): 10	
PreAmp Used? (Y or N): N	Voltage/Frequency: POE	Frequency Range: 9kHz-30MHz
Net = Reading (dBuV/m) + Antenna Factor (dB1/m) + Cable Loss (dB) - Preamp Factor (dB) - Distance Factor (dB)		
Peak: PK Quasi-Peak: QP Average: AVG RMS: RMS; NF = Noise Floor, RB = Restricted Band; Bandwidth denoted as RBW/VBW		

Detector Type	Ant. Pol. (V/H)	Frequency MHz	Reading dB(uV)	Antenna Factor dB(1/m)	Cable Loss dB	Pre-amp Factor dB	Distance Factor dB	EIRP Net dBm	EIRP Limit dBm	Margin dB	Bandwidth
Note: All channels, no emissions were detected above the measuring equipment noise floor, readings below were all for noise floor											
Note: EIRP Obtained by applying the path loss correction for a 3m test distance, E(dBuV/m)@10m - 84.7 = dBm EIRP											
PK	V	5.000	35.88	12.30	0.34	0.00	0.00	-36.18	-13.00	-23.18	1/3 MHz
PK	V	10.000	31.64	11.50	0.34	0.00	0.00	-41.22	-13.00	-28.22	1/3 MHz
PK	V	15.000	30.06	11.00	0.34	0.00	0.00	-43.30	-13.00	-30.30	1/3 MHz
PK	V	20.000	29.67	10.30	0.34	0.00	0.00	-44.39	-13.00	-31.39	1/3 MHz
PK	V	25.000	29.35	9.70	0.34	0.00	0.00	-45.31	-13.00	-32.31	1/3 MHz
PK	V	30.000	37.07	9.80	0.34	0.00	0.00	-37.49	-13.00	-24.49	1/3 MHz

Intertek

Report Number: 104723800BOX-001	Issued: 10/29/2021 Revised: 11/08/2021 11/10/2021
---------------------------------	---

Lower Band: Low Channel 24.34 GHz, 160 MHz Bandwidth, MCS0 Modulation, 30-1000 MHz
Radiated Spurious Emissions, Tx at 24.34GHz

Company: Starry	Antenna & Cables: N	Bands: N, LF, HF, SHF
Model #: Comet 24	Antenna: 145-145	145-145
Serial #: 2123000009	Cable(s): IW01, HS002, HS003, 145-422	NONE.
Engineers: Vathana Ven	Location: 10m Chamber	Barometer: DAV007
Project #: G104723800	Date(s): 09/13/21	Filter: NONE
Standard: FCC Part 30, Subpart C	Temp/Humidity/Pressure: 23c	39% 1007mB
Receiver: R&S ESE (145-128) 06-22-2022	Limit Distance (m): 10	
PreAmp: PRE11	Test Distance (m): 10	
PreAmp Used? (Y or N): Y	Voltage/Frequency: POE	Frequency Range: 30MHz - 1GHz
Net = Reading (dBuV/m) + Antenna Factor (dB1/m) + Cable Loss (dB) - Preamp Factor (dB) - Distance Factor (dB)		

Peak: PK Quasi-Peak: QP Average: AVG RMS: RMS; NF = Noise Floor, RB = Restricted Band; Bandwidth denoted as RBW/VBW

Detector Type	Ant. Pol. (V/H)	Frequency MHz	Reading dB(uV)	Antenna Factor dB(1/m)	Cable Loss dB	Pre-amp Factor dB	Correction Factor dB	EIRP Net dBm	EIRP Limit dBm	Margin dB	Bandwidth
Note: Low CH 24.34GHz (Lower band)_Tx mode_MCS0_160MHz BW, BT CH1, 5G Radio on CH 157											
Note: EIRP Obtained by applying the path loss correction for a 10m test distance, E(dBuV/m)@10m - 84.7 = dBm EIRP											
PK	V	32.705	52.98	---	---	---	14.34	-46.06	-13.00	-33.06	1/3 MHz
PK	V	37.926	61.39	---	---	---	18.19	-41.50	-13.00	-28.50	1/3 MHz
PK	V	54.663	62.04	---	---	---	25.93	-48.59	-13.00	-35.59	1/3 MHz
PK	V	58.009	71.78	---	---	---	25.39	-38.31	-13.00	-25.31	1/3 MHz
PK	H	238.295	43.26	---	---	---	20.57	-62.01	-13.00	-49.01	1/3 MHz
PK	V	830.179	41.69	---	---	---	7.43	-50.44	-13.00	-37.44	1/3 MHz

Note: Correction Factor (dB) = Antenna Factor (dB) + Cable Loss (dB) - Pre-Amp Factor (dB)

Intertek

Report Number: 104723800BOX-001	Issued: 10/29/2021 Revised: 11/08/2021 11/10/2021
---------------------------------	---

Lower Band: Mid Channel 24.35 GHz, 160 MHz Bandwidth, MCS0 Modulation, 30-1000 MHz
Radiated Spurious Emissions, Tx at 24.35GHz

Company: Starry	Antenna & Cables: N	Bands: N, LF, HF, SHF
Model #: Comet 24	Antenna: 145-145	145-145
Serial #: 2123000009	Cable(s): IW01, HS002, HS003, 145-422	NONE.
Engineers: Vathana Ven	Location: 10m Chamber	Barometer: DAV007
Project #: G104723800	Date(s): 09/13/21	Filter: NONE
Standard: FCC Part 30, Subpart C	Temp/Humidity/Pressure: 23c	39% 1007mB
Receiver: R&S ESE (145-128) 06-22-2022	Limit Distance (m): 10	
PreAmp: PRE11	Test Distance (m): 10	
PreAmp Used? (Y or N): Y	Voltage/Frequency: POE	Frequency Range: 30MHz - 1GHz
Net = Reading (dBuV/m) + Antenna Factor (dB1/m) + Cable Loss (dB) - Preamp Factor (dB) - Distance Factor (dB)		
Peak: PK Quasi-Peak: QP Average: AVG RMS: RMS; NF = Noise Floor, RB = Restricted Band; Bandwidth denoted as RBW/VBW		

Detector Type	Ant. Pol. (V/H)	Frequency MHz	Reading dB(uV)	Antenna Factor dB(1/m)	Cable Loss dB	Pre-amp Factor dB	Correction Factor dB	EIRP Net dBm	EIRP Limit dBm	Margin dB	Bandwidth
Note: Mid CH 24.35GHz (Lower band)_Tx mode_ MCS0_160MHz BW, BT CH1, 5G Radio on CH 157											
Note: EIRP Obtained by applying the path loss correction for a 10m test distance, E(dBuV/m)@10m - 84.7 = dBm EIRP											
PK	V	30.863	55.48	---	---	---	14.01	-43.23	-13.00	-30.23	1/3 MHz
PK	V	37.874	58.14	---	---	---	18.16	-44.72	-13.00	-31.72	1/3 MHz
PK	V	53.316	67.54	---	---	---	25.88	-43.04	-13.00	-30.04	1/3 MHz
PK	V	61.474	71.04	---	---	---	25.55	-39.21	-13.00	-26.21	1/3 MHz
PK	V	66.800	67.60	---	---	---	25.11	-42.21	-13.00	-29.21	1/3 MHz
PK	V	785.600	42.37	---	---	---	8.28	-50.61	-13.00	-37.61	1/3 MHz

Note: Correction Factor (dB) = Antenna Factor (dB) + Cable Loss (dB) - Pre-Amp Factor (dB)

Intertek

Report Number: 104723800BOX-001	Issued: 10/29/2021 Revised: 11/08/2021 11/10/2021
---------------------------------	---

Lower Band: High Channel 24.36 GHz, 160 MHz Bandwidth, MCS0 Modulation, 30-1000 MHz
Radiated Spurious Emissions, Tx at 24.36GHz

Company: Starry Antenna & Cables: N Bands: N, LF, HF, SHF
 Model #: Comet 24 Antenna: 145-145 145-145
 Serial #: 2123000009 Cable(s): IW01, HS002, HS003, 145-422 NONE.
 Engineers: Vathana Ven Location: 10m Chamber Barometer: DAV007 Filter: NONE
 Project #: G104723800 Date(s): 09/13/21
 Standard: FCC Part 30, Subpart C Temp/Humidity/Pressure: 23c 39% 1007mB
 Receiver: R&S ESE (145-128) 06-22-2022 Limit Distance (m): 10
 PreAmp: PRE11 Test Distance (m): 10
 PreAmp Used? (Y or N): Y Voltage/Frequency: POE Frequency Range: 30MHz - 1GHz
 Net = Reading (dBuV/m) + Antenna Factor (dB1/m) + Cable Loss (dB) - Preamp Factor (dB) - Distance Factor (dB)
 Peak: PK Quasi-Peak: QP Average: AVG RMS: RMS; NF = Noise Floor, RB = Restricted Band; Bandwidth denoted as RBW/VBW

Detector Type	Ant. Pol. (V/H)	Frequency MHz	Reading dB(uV)	Antenna Factor dB(1/m)	Cable Loss dB	Pre-amp Factor dB	Correction Factor dB	EIRP Net dBm	EIRP Limit dBm	Margin dB	Bandwidth
Note: High CH 24.36GHz (Lower band) Tx mode MCS0 160MHz BW, BT CH1, 5G Radio on CH 157											
Note: EIRP Obtained by applying the path loss correction for a 10m test distance, E(dBuV/m)@10m - 84.7 = dBm EIRP											
PK	V	31.547	56.53	---	---	---	14.43	-42.60	-13.00	-29.60	1/3 MHz
PK	V	37.379	61.86	---	---	---	17.86	-40.70	-13.00	-27.70	1/3 MHz
PK	V	52.737	69.19	---	---	---	25.83	-41.34	-13.00	-28.34	1/3 MHz
PK	V	54.389	65.29	---	---	---	25.93	-45.34	-13.00	-32.34	1/3 MHz
PK	V	69.960	70.26	---	---	---	24.94	-39.38	-13.00	-26.38	1/3 MHz
PK	V	785.505	43.00	---	---	---	8.26	-49.96	-13.00	-36.96	1/3 MHz

Note: Correction Factor (dB) = Antenna Factor (dB) + Cable Loss (dB) - Pre-Amp Factor (dB)

Intertek

Report Number: 104723800BOX-001	Issued: 10/29/2021 Revised: 11/08/2021 11/10/2021
---------------------------------	---

Upper Band: Low Channel 24.84 GHz, 160 MHz Bandwidth, MCS0 Modulation, 30-1000 MHz
Radiated Spurious Emissions, Tx at 24.84GHz

Company: Starry	Antenna & Cables: N	Bands: N, LF, HF, SHF
Model #: Comet 24	Antenna: 145-145	145-145
Serial #: 2123000009	Cable(s): IW01, HS002, HS003, 145-422	NONE.
Engineers: Vathana Ven	Location: 10m Chamber	Barometer: DAV007
Project #: G104723800	Date(s): 09/13/21	Filter: NONE
Standard: FCC Part 30, Subpart C	Temp/Humidity/Pressure: 23c	39% 1007mB
Receiver: R&S ESE (145-128) 06-22-2022	Limit Distance (m): 10	
PreAmp: PRE11	Test Distance (m): 10	
PreAmp Used? (Y or N): Y	Voltage/Frequency: POE	Frequency Range: 30MHz - 1GHz
Net = Reading (dBuV/m) + Antenna Factor (dB1/m) + Cable Loss (dB) - Preamp Factor (dB) - Distance Factor (dB)		
Peak: PK Quasi-Peak: QP Average: AVG RMS: RMS; NF = Noise Floor, RB = Restricted Band; Bandwidth denoted as RBW/VBW		

Detector Type	Ant. Pol. (V/H)	Frequency MHz	Reading dB(uV)	Antenna Factor dB(1/m)	Cable Loss dB	Pre-amp Factor dB	Correction Factor dB	EIRP Net dBm	EIRP Limit dBm	Margin dB	Bandwidth
Note: Low CH 24.84GHz (Upper band)_Tx mode_MCS0_160MHz BW, BT CH1, 5G Radio on CH 157											
Note: EIRP Obtained by applying the path loss correction for a 10m test distance, E(dBuV/m)@10m - 84.7 = dBm EIRP											
PK	V	31.411	56.42	---	---	---	14.35	-42.63	-13.00	-29.63	1/3 MHz
PK	V	37.632	61.17	---	---	---	18.01	-41.54	-13.00	-28.54	1/3 MHz
PK	V	52.832	65.85	---	---	---	25.84	-44.69	-13.00	-31.69	1/3 MHz
PK	V	54.389	65.22	---	---	---	25.93	-45.41	-13.00	-32.41	1/3 MHz
PK	V	69.960	72.21	---	---	---	24.94	-37.43	-13.00	-24.43	1/3 MHz
PK	V	785.505	41.20	---	---	---	8.26	-51.76	-13.00	-38.76	1/3 MHz

Note: Correction Factor (dB) = Antenna Factor (dB) + Cable Loss (dB) - Pre-Amp Factor (dB)

Intertek

Report Number: 104723800BOX-001	Issued: 10/29/2021 Revised: 11/08/2021 11/10/2021
---------------------------------	---

Upper Band: Mid Channel 25.04 GHz, 160 MHz Bandwidth, MCS0 Modulation, 30-1000 MHz
Radiated Spurious Emissions, Tx at 25.04GHz

Company: Starry	Antenna & Cables: N	Bands: N, LF, HF, SHF
Model #: Comet 24	Antenna: 145-145	145-145
Serial #: 2123000009	Cable(s): IW01, HS002, HS003, 145-422	NONE.
Engineers: Vathana Ven	Location: 10m Chamber	Barometer: DAV007
Project #: G104723800	Date(s): 09/13/21	Filter: NONE
Standard: FCC Part 30, Subpart C	Temp/Humidity/Pressure: 23c	39% 1007mB
Receiver: R&S ESE (145-128) 06-22-2022	Limit Distance (m): 10	
PreAmp: PRE11	Test Distance (m): 10	
PreAmp Used? (Y or N): Y	Voltage/Frequency: POE	Frequency Range: 30MHz - 1GHz
Net = Reading (dBuV/m) + Antenna Factor (dB1/m) + Cable Loss (dB) - Preamp Factor (dB) - Distance Factor (dB)		
Peak: PK Quasi-Peak: QP Average: AVG RMS: RMS; NF = Noise Floor, RB = Restricted Band; Bandwidth denoted as RBW/VBW		

Detector Type	Ant. Pol. (V/H)	Frequency MHz	Reading dB(uV)	Antenna Factor dB(1/m)	Cable Loss dB	Pre-amp Factor dB	Correction Factor dB	EIRP Net dBm	EIRP Limit dBm	Margin dB	Bandwidth
Note: Mid CH 25.04GHz (Upper band)_Tx mode_MCS0_160MHz BW, BT CH1, 5G Radio on CH 157											
Note: EIRP Obtained by applying the path loss correction for a 10m test distance, E(dBuV/m)@10m - 84.7 = dBm EIRP											
PK	V	37.505	57.31	---	---	---	17.94	-45.33	-13.00	-32.33	1/3 MHz
PK	V	56.926	72.21	---	---	---	25.90	-38.39	-13.00	-25.39	1/3 MHz
PK	V	59.937	71.03	---	---	---	25.67	-39.34	-13.00	-26.34	1/3 MHz
PK	V	61.579	59.44	---	---	---	25.54	-50.80	-13.00	-37.80	1/3 MHz
PK	V	69.960	60.23	---	---	---	24.94	-49.41	-13.00	-36.41	1/3 MHz
PK	V	713.074	43.01	---	---	---	9.58	-51.27	-13.00	-38.27	1/3 MHz

Note: Correction Factor (dB) = Antenna Factor (dB) + Cable Loss (dB) - Pre-Amp Factor (dB)

Intertek

Report Number: 104723800BOX-001	Issued: 10/29/2021 Revised: 11/08/2021 11/10/2021
---------------------------------	---

Upper Band: High Channel 25.16 GHz, 160 MHz Bandwidth, MCS0 Modulation, 30-1000 MHz
Radiated Spurious Emissions, Tx at 25.16GHz

Company: Starry	Antenna & Cables: N	Bands: N, LF, HF, SHF
Model #: Comet 24	Antenna: 145-145	145-145
Serial #: 2123000009	Cable(s): IW01, HS002, HS003, 145-422	NONE.
Engineers: Vathana Ven	Location: 10m Chamber	Barometer: DAV007
Project #: G104723800	Date(s): 09/13/21	Filter: NONE
Standard: FCC Part 30, Subpart C	Temp/Humidity/Pressure: 23c	39% 1007mB
Receiver: R&S ESE (145-128) 06-22-2022	Limit Distance (m): 10	
PreAmp: PRE11	Test Distance (m): 10	
PreAmp Used? (Y or N): Y	Voltage/Frequency: POE	Frequency Range: 30MHz - 1GHz
Net = Reading (dBuV/m) + Antenna Factor (dB1/m) + Cable Loss (dB) - Preamp Factor (dB) - Distance Factor (dB)		
Peak: PK Quasi-Peak: QP Average: AVG RMS: RMS; NF = Noise Floor, RB = Restricted Band; Bandwidth denoted as RBW/VBW		

Detector Type	Ant. Pol. (V/H)	Frequency MHz	Reading dB(uV)	Antenna Factor dB(1/m)	Cable Loss dB	Pre-amp Factor dB	Correction Factor dB	EIRP Net dBm	EIRP Limit dBm	Margin dB	Bandwidth
Note: High CH 25.16GHz (Upper band) Tx mode MCS0 160MHz BW, BT CH1, 5G Radio on CH 157											
Note: EIRP Obtained by applying the path loss correction for a 10m test distance, E(dBuV/m)@10m - 84.7 = dBm EIRP											
PK	V	31.674	66.28	---	---	---	14.51	-32.93	-13.00	-19.93	1/3 MHz
PK	V	37.653	59.13	---	---	---	18.02	-43.59	-13.00	-30.59	1/3 MHz
PK	V	54.189	64.35	---	---	---	25.93	-46.28	-13.00	-33.28	1/3 MHz
PK	V	63.284	72.09	---	---	---	25.40	-38.01	-13.00	-25.01	1/3 MHz
PK	V	69.960	65.44	---	---	---	24.94	-44.20	-13.00	-31.20	1/3 MHz
PK	H	844.432	42.11	---	---	---	7.31	-49.90	-13.00	-36.90	1/3 MHz

Note: Correction Factor (dB) = Antenna Factor (dB) + Cable Loss (dB) - Pre-Amp Factor (dB)

Intertek

Report Number: 104723800BOX-001

Issued: 10/29/2021
Revised: 11/08/2021
11/10/2021

Lower Band: Low Channel 24.34 GHz, 160 MHz Bandwidth, MCS0 Modulation, 1-3 GHz

Test Information:

Date and Time	7/2/2021 10:58:26 PM
Client and Project Number	Starry
Engineer	Vathana Ven
Temperature	29 deg C
Humidity	41%
Atmospheric Pressure	1009mbar
Comments	Comet 24, Lower Band: Low Channel 24.34 GHz, 160 MHz BW, MCS0, att0.25mixer27, BT Tx Low CH_5GHz Tx CH157 80 MHz BW_1-3GHz Part 30

Graph:

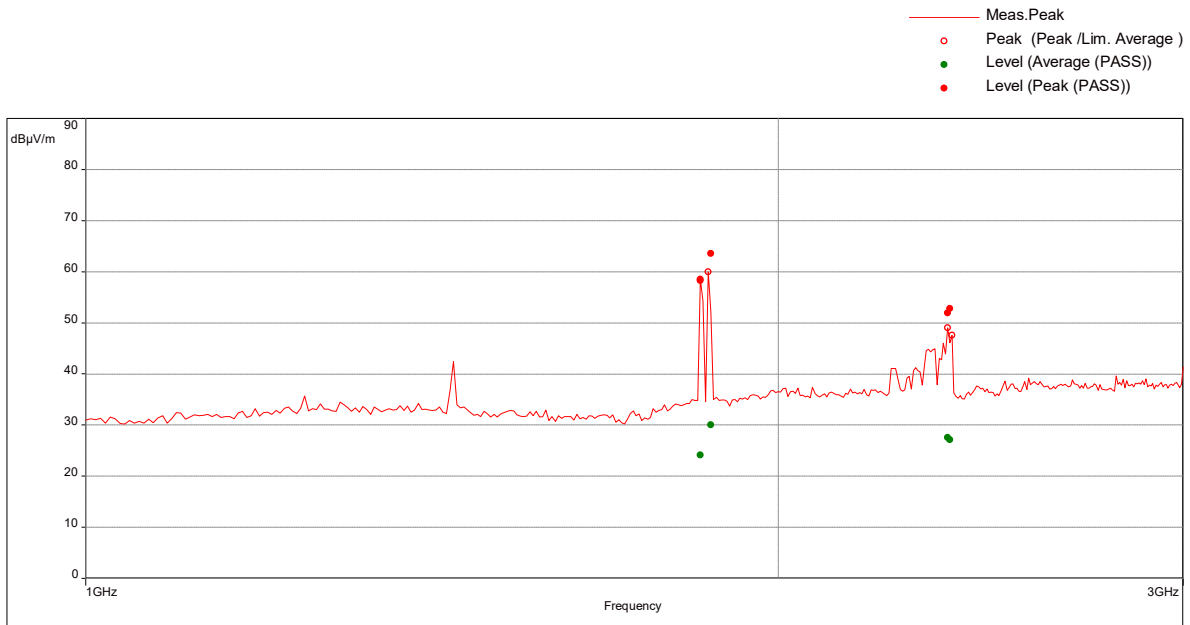

Results:

Peak (PASS) (4)

Frequency (MHz)	Level (dBµV/m)	EIRP Level (dBm)	Limit (dBm)	Margin (dB)	Azimuth (°)	Height (m)	Pol.	RBW (Hz)	Correction (dB)
1851.052632	58.27	-36.99	-13	-23.99	62.00	2.55	Vertical	1000000.00	-4.73
1867.894737	63.53	-31.73	-13	-18.73	76.00	3.55	Vertical	1000000.00	-4.72
2371.578947	51.95	-43.31	-13	-30.31	33.00	1.35	Horizontal	1000000.00	-3.77
2375.263158	52.79	-42.47	-13	-29.47	33.00	2.15	Horizontal	1000000.00	-3.75

EIRP (dBm) = E (dBµV/m) + 20 * Log (D) – 104.7, where D is the measurement distance (in the far field region) in meters.

Peak (EIRP) = Peak (dBµV/m) – 95.2, where D = 3 m.

Intertek

Report Number: 104723800BOX-001

Issued: 10/29/2021
Revised: 11/08/2021
11/10/2021

Lower Band: Low Channel 24.34 GHz, 160 MHz Bandwidth, MCS0 Modulation, 3-18 GHz

Test Information:

Date and Time	7/2/2021 10:37:07 PM
Client and Project Number	Starry
Engineer	Vathana Ven
Temperature	29 deg C
Humidity	41%
Atmospheric Pressure	1009mbar
Comments	Comet 24, Lower Band: Low Channel 24.34 GHz, 160 MHz BW, MCS0, att0.25mixer27, BT Tx Low CH_5GHz Tx CH157 80 MHz BW_3-13GHz Part 30

Graph:

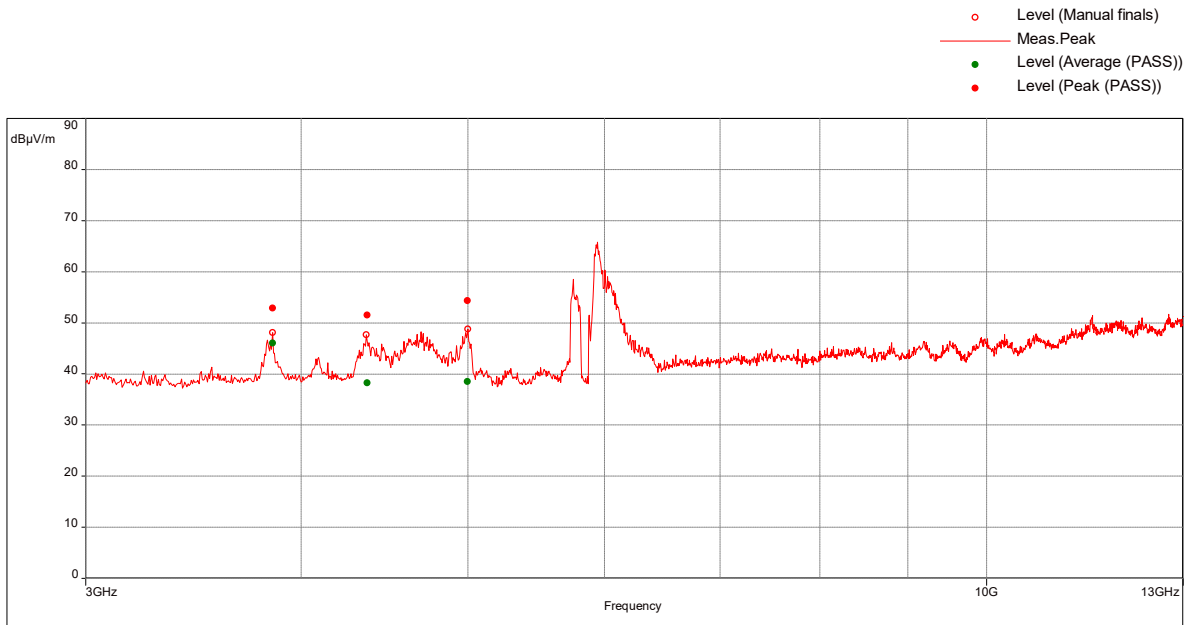

Results:

Peak (PASS) (3)

Frequency (MHz)	Level (dBuV/m)	EIRP Level (dBm)	Limit (dBm)	Margin (dB)	Azimuth (°)	Height (m)	Pol.	RBW (Hz)	Correction (dB)
3850	52.84	-42.42	-13	-29.42	359.00	2.30	Horizontal	1000000.00	-1.06
4368.947368	51.48	-43.78	-13	-30.78	314.00	1.25	Horizontal	1000000.00	-0.22
4996.842105	54.33	-40.93	-13	-27.93	343.00	1.85	Horizontal	1000000.00	1.14

EIRP (dBm) = E (dBuV/m) + 20 * Log (D) – 104.7, where D is the measurement distance (in the far field region) in meters.

Peak (EIRP) = Peak (dBuV/m) – 95.2, where D = 3 m.

Notes: The high peaks are the fundamental frequency signals.

Intertek

Report Number: 104723800BOX-001	Issued: 10/29/2021 Revised: 11/08/2021 11/10/2021
---------------------------------	---

Lower Band: Mid Channel 24.35 GHz, 160 MHz Bandwidth, MCS0 Modulation, 1-3 GHz

Test Information:

Date and Time	7/2/2021 9:54:06 PM
Client and Project Number	Starry
Engineer	Vathana Ven
Temperature	29 deg C
Humidity	41%
Atmospheric Pressure	1009mbar
Comments	Comet 24, Lower Band: Mid Channel 24.35 GHz, 160 MHz BW, MCS0, att0.75mixer27, BT Tx Mid CH_5GHz Tx CH157 80 MHz BW_1-3GHz Part 30

Graph:

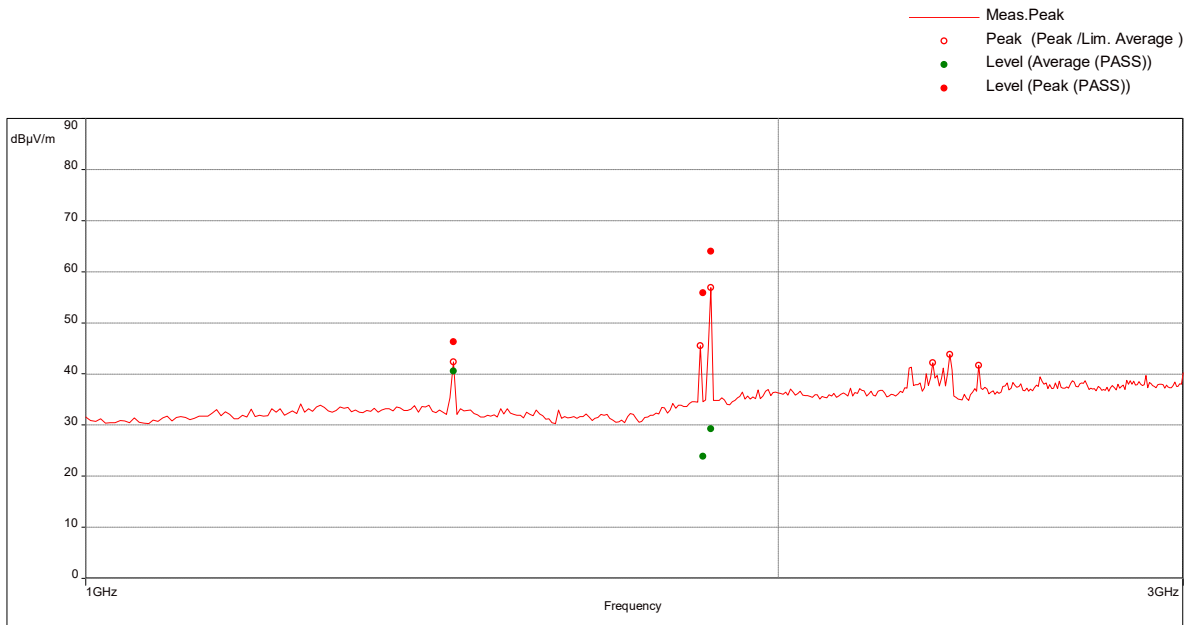

Results:

Peak (PASS) (3)

Frequency (MHz)	Level (dBµV/m)	EIRP Level (dBm)	Limit (dBm)	Margin (dB)	Azimuth (°)	Height (m)	Pol.	RBW (Hz)	Correction (dB)
1443.684211	46.33	-48.93	-13	-35.93	0.00	2.70	Horizontal	1000000.00	-7.57
1852.631579	55.87	-39.39	-13	-26.39	239.00	3.79	Horizontal	1000000.00	-4.73
1867.894737	64.01	-31.25	-13	-18.25	98.00	3.10	Vertical	1000000.00	-4.72

EIRP (dBm) = E (dBµV/m) + 20 * Log (D) – 104.7, where D is the measurement distance (in the far field region) in meters.

Peak (EIRP) = Peak (dBµV/m) – 95.2, where D = 3 m.

Intertek

Report Number: 104723800BOX-001	Issued: 10/29/2021 Revised: 11/08/2021 11/10/2021
---------------------------------	---

Lower Band: Mid Channel 24.35 GHz, 160 MHz Bandwidth, MCS0 Modulation, 3-18 GHz

Test Information:

Date and Time	7/2/2021 10:13:29 PM
Client and Project Number	Starry
Engineer	Vathana Ven
Temperature	29 deg C
Humidity	41%
Atmospheric Pressure	1009mbar
Comments	Comet 24, Lower Band: Mid Channel 24.35 GHz, 160 MHz BW, MCS0, att0.75mixer27, BT Tx Mid CH_5GHz Tx CH157 80 MHz BW_3-13GHz Part 30

Graph:

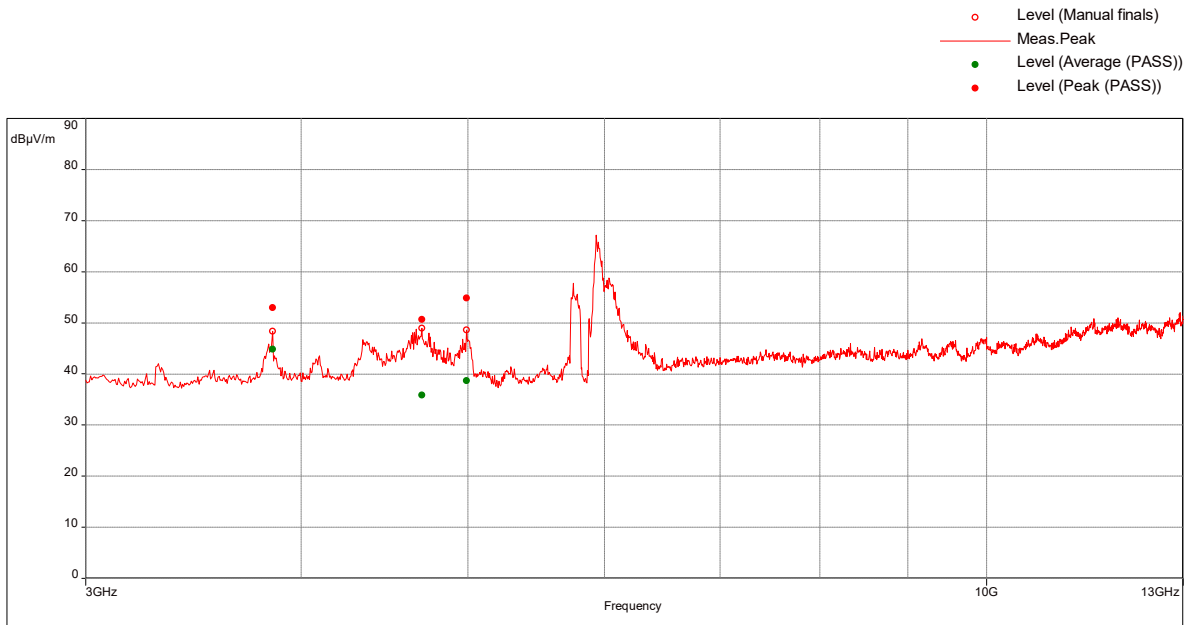

Results:

Peak (PASS) (3)

Frequency (MHz)	Level (dBuV/m)	EIRP Level (dBm)	Limit (dBm)	Margin (dB)	Azimuth (°)	Height (m)	Pol.	RBW (Hz)	Correction (dB)
3849.736842	52.98	-42.28	-13	-29.28	0.00	2.30	Horizontal	1000000.00	-1.06
4699.736842	50.61	-44.65	-13	-31.65	311.00	1.35	Horizontal	1000000.00	0.37
4990	54.86	-40.40	-13	-27.40	341.00	1.90	Horizontal	1000000.00	1.10

EIRP (dBm) = E (dBuV/m) + 20 * Log (D) – 104.7, where D is the measurement distance (in the far field region) in meters.

Peak (EIRP) = Peak (dBuV/m) – 95.2, where D = 3 m.

Notes: The high peaks are the fundamental frequency signals.

Intertek

Report Number: 104723800BOX-001	Issued: 10/29/2021 Revised: 11/08/2021 11/10/2021
---------------------------------	---

Lower Band: High Channel 24.36 GHz, 160 MHz Bandwidth, MCS0 Modulation, 1-3 GHz

Test Information:

Date and Time	7/2/2021 9:50:13 PM
Client and Project Number	Starry
Engineer	Vathana Ven
Temperature	29 deg C
Humidity	41%
Atmospheric Pressure	1009mbar
Comments	Comet 24, Lower Band: High Channel 24.36 GHz, 160 MHz BW, MCS0, att0.5mixer27, BT Tx High CH_5GHz Tx CH157 80 MHz BW_1-3GHz Part 30

Graph:

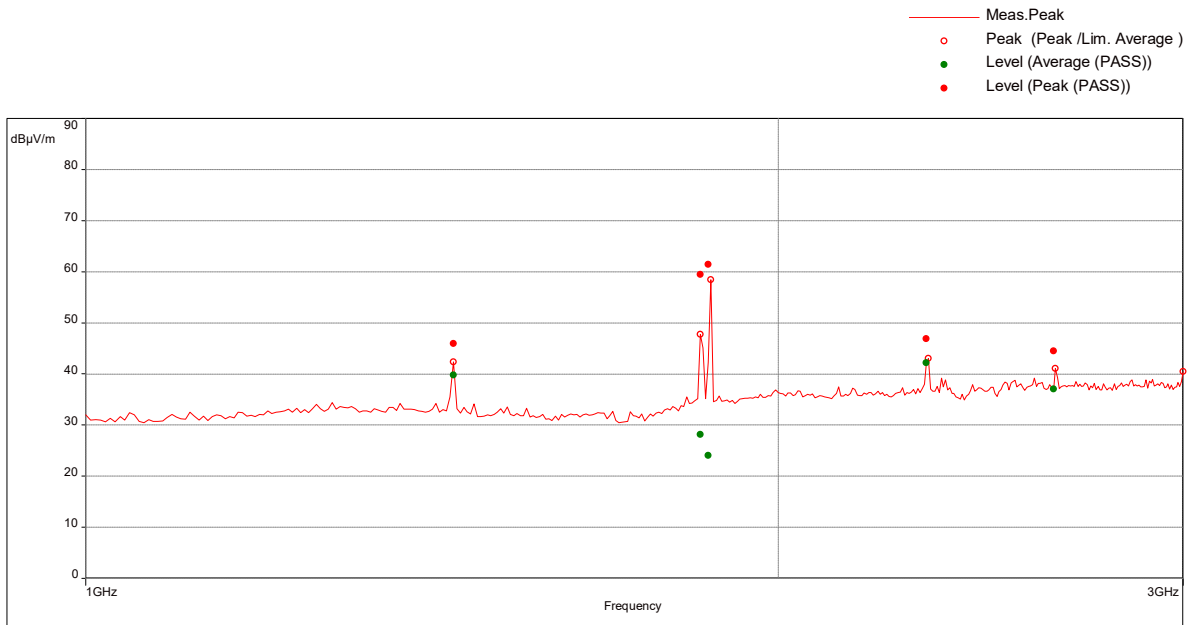

Results:

Peak (PASS) (5)

Frequency (MHz)	Level (dBµV/m)	EIRP Level (dBm)	Limit (dBm)	Margin (dB)	Azimuth (°)	Height (m)	Pol.	RBW (Hz)	Correction (dB)
1443.684211	45.91	-49.35	-13	-36.35	357.00	1.55	Horizontal	1000000.00	-7.57
1851.052632	59.45	-35.81	-13	-22.81	298.00	1.85	Horizontal	1000000.00	-4.73
1867.368421	61.47	-33.79	-13	-20.79	261.00	3.45	Vertical	1000000.00	-4.72
2322.368421	46.87	-48.39	-13	-35.39	25.00	1.55	Horizontal	1000000.00	-3.96
2637.368421	44.49	-50.77	-13	-37.77	333.00	1.85	Horizontal	1000000.00	-3.05

EIRP (dBm) = E (dBuV/m) + 20 * Log (D) – 104.7, where D is the measurement distance (in the far field region) in meters.

Peak (EIRP) = Peak (dBuV/m) – 95.2, where D = 3 m.

Intertek

Report Number: 104723800BOX-001	Issued: 10/29/2021 Revised: 11/08/2021 11/10/2021
---------------------------------	---

Lower Band: High Channel 24.36 GHz, 160 MHz Bandwidth, MCS0 Modulation, 3-18 GHz

Test Information:

Date and Time	7/2/2021 9:10:25 PM
Client and Project Number	Starry
Engineer	Vathana Ven
Temperature	29 deg C
Humidity	41%
Atmospheric Pressure	1009mbar
Comments	Comet 24, Lower Band: High Channel 24.36 GHz, 160 MHz BW, MCS0, att0.5mixer27, BT Tx High CH_5GHz Tx CH157 80 MHz BW_3-13GHz Part 30

Graph:

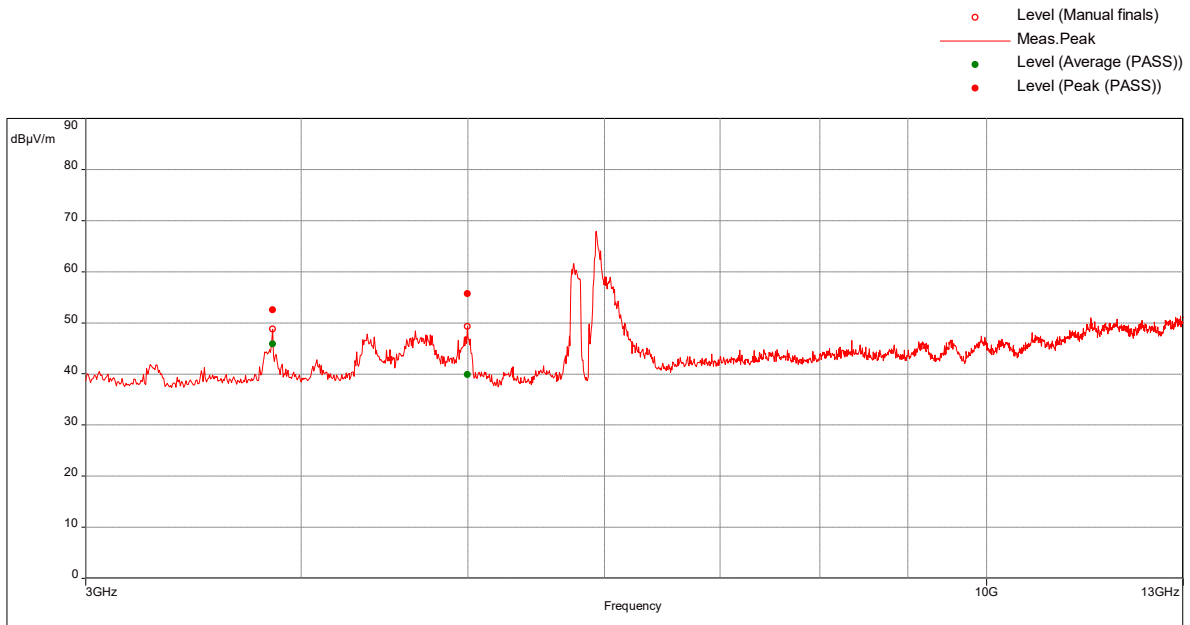

Results:

Peak (PASS) (2)

Frequency (MHz)	Level (dBuV/m)	EIRP Level (dBm)	Limit (dBm)	Margin (dB)	Azimuth (°)	Height (m)	Pol.	RBW (Hz)	Correction (dB)
3850	52.56	-42.7	-13	-29.70	0.00	1.75	Horizontal	1000000.00	-1.06
4995.526316	55.74	-39.52	-13	-26.52	341.00	1.95	Horizontal	1000000.00	1.13

EIRP (dBm) = E (dBuV/m) + 20 * Log (D) – 104.7, where D is the measurement distance (in the far field region) in meters.

Peak (EIRP) = Peak (dBuV/m) – 95.2, where D = 3 m.

Notes: The high peaks are the fundamental frequency signals.

Intertek

Report Number: 104723800BOX-001	Issued: 10/29/2021 Revised: 11/08/2021 11/10/2021
---------------------------------	---

Upper Band: Low Channel 24.84 GHz, 160 MHz Bandwidth, MCS0 Modulation, 1-3 GHz

Test Information:

Date and Time	7/2/2021 8:22:32 PM
Client and Project Number	Starry
Engineer	Vathana Ven
Temperature	29 deg C
Humidity	41%
Atmospheric Pressure	1009mbar
Comments	Comet 24, Upper Band: Low Channel 24.84 GHz, 160 MHz BW, MCS0, att0.75mixer25, BT Tx High CH_5GHz Tx CH157 80 MHz BW_1-3GHz Part 30

Graph:

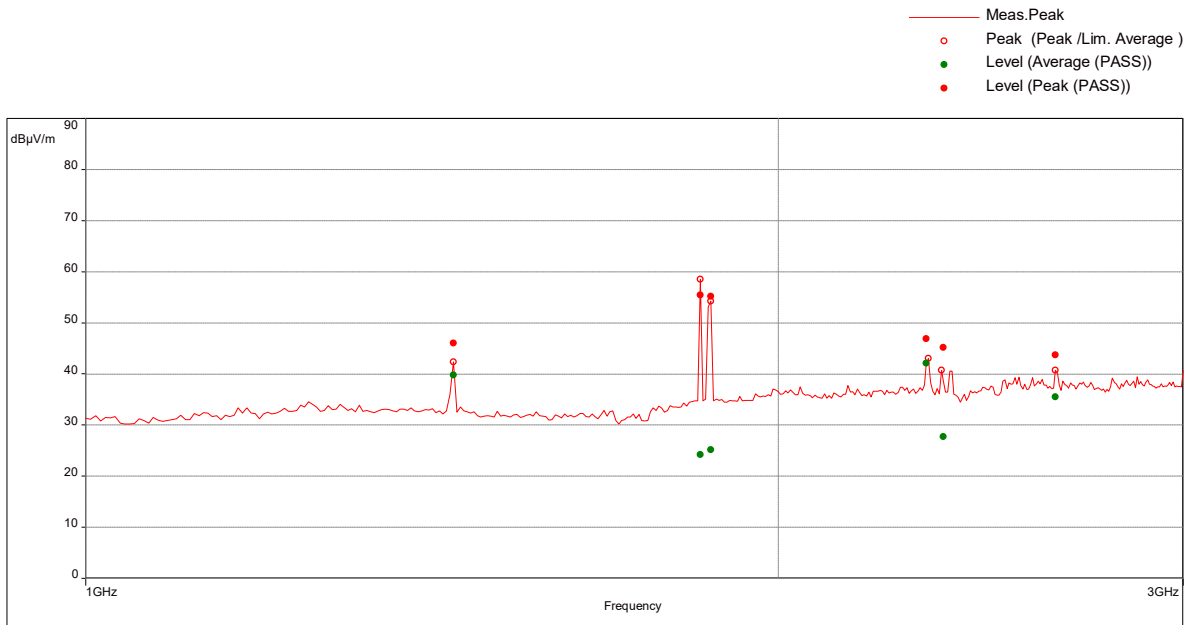

Results:

Peak (PASS) (6)

Frequency (MHz)	Level (dBµV/m)	EIRP Level (dBm)	Limit (dBm)	Margin (dB)	Azimuth (°)	Height (m)	Pol.	RBW (Hz)	Correction (dB)
1443.684211	46.05	-49.23	-13	-36.23	356.00	1.60	Horizontal	1000000.00	-7.57
1850.789474	55.46	-39.80	-13	-26.80	46.00	1.40	Vertical	1000000.00	-4.73
1868.421053	55.16	-40.10	-13	-27.10	47.00	1.00	Vertical	1000000.00	-4.72
2322.368421	46.87	-48.39	-13	-35.39	25.00	1.60	Horizontal	1000000.00	-3.96
2358.684211	45.19	-50.07	-13	-37.07	33.00	1.75	Horizontal	1000000.00	-3.83
2642.368421	43.69	-51.57	-13	-38.57	340.00	1.35	Horizontal	1000000.00	-3.02

EIRP (dBm) = E (dBµV/m) + 20 * Log (D) – 104.7, where D is the measurement distance (in the far field region) in meters.

Peak (EIRP) = Peak (dBµV/m) – 95.2, where D = 3 m.

Intertek

Report Number: 104723800BOX-001

Issued: 10/29/2021
Revised: 11/08/2021
11/10/2021

Upper Band: Low Channel 24.84 GHz, 160 MHz Bandwidth, MCS0 Modulation, 3-18 GHz

Test Information:

Date and Time	7/2/2021 8:48:23 PM
Client and Project Number	Starry
Engineer	Vathana Ven
Temperature	29 deg C
Humidity	41%
Atmospheric Pressure	1009mbar
Comments	Comet 24, Upper Band: Low Channel 24.84 GHz, 160 MHz BW, MCS0, att0.75mixer25, BT Tx High CH_5GHz Tx CH157 80 MHz BW_3-13GHz Part 30

Graph:

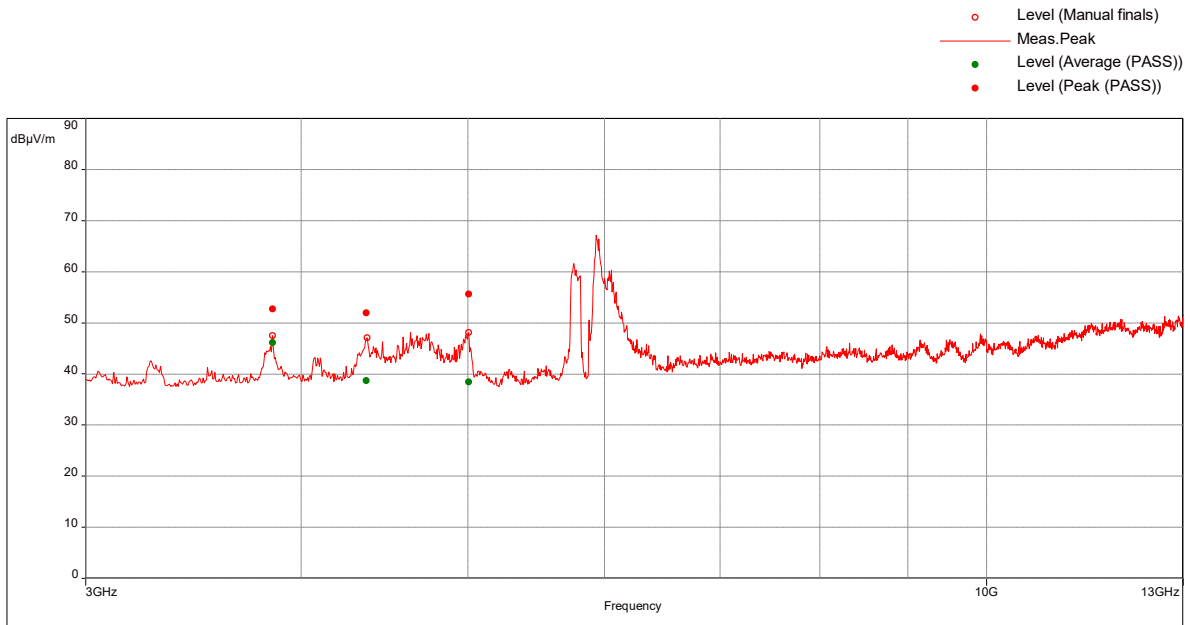

Results:

Peak (PASS) (3)

Frequency (MHz)	Level (dBuV/m)	EIRP Level (dBm)	Limit (dBm)	Margin (dB)	Azimuth (°)	Height (m)	Pol.	RBW (Hz)	Correction (dB)
3850	52.70	-42.56	-13	-29.56	333.00	2.55	Horizontal	1000000.00	-1.06
4366.578947	51.91	-43.35	-13	-30.35	312.00	1.65	Horizontal	1000000.00	-0.23
5003.421053	55.62	-39.64	-13	-26.64	342.00	1.90	Horizontal	1000000.00	1.15

EIRP (dBm) = E (dBuV/m) + 20 * Log (D) – 104.7, where D is the measurement distance (in the far field region) in meters.

Peak (EIRP) = Peak (dBuV/m) – 95.2, where D = 3 m.

Notes: The high peaks are the fundamental frequency signals.

Intertek

Report Number: 104723800BOX-001	Issued: 10/29/2021 Revised: 11/08/2021 11/10/2021
---------------------------------	---

Upper Band: Mid Channel 25.04 GHz, 160 MHz Bandwidth, MCS0 Modulation, 1-3 GHz

Test Information:

Date and Time	7/2/2021 7:53:17 PM
Client and Project Number	Starry
Engineer	Vathana Ven
Temperature	29 deg C
Humidity	41%
Atmospheric Pressure	1009mbar
Comments	Comet 24, Upper Band: Mid Channel 25.04 GHz, 160 MHz BW, MCS0, att0.5mixer24, BT Tx Mid CH_5GHz Tx CH157 80 MHz BW_1-3GHz Part 30

Graph:

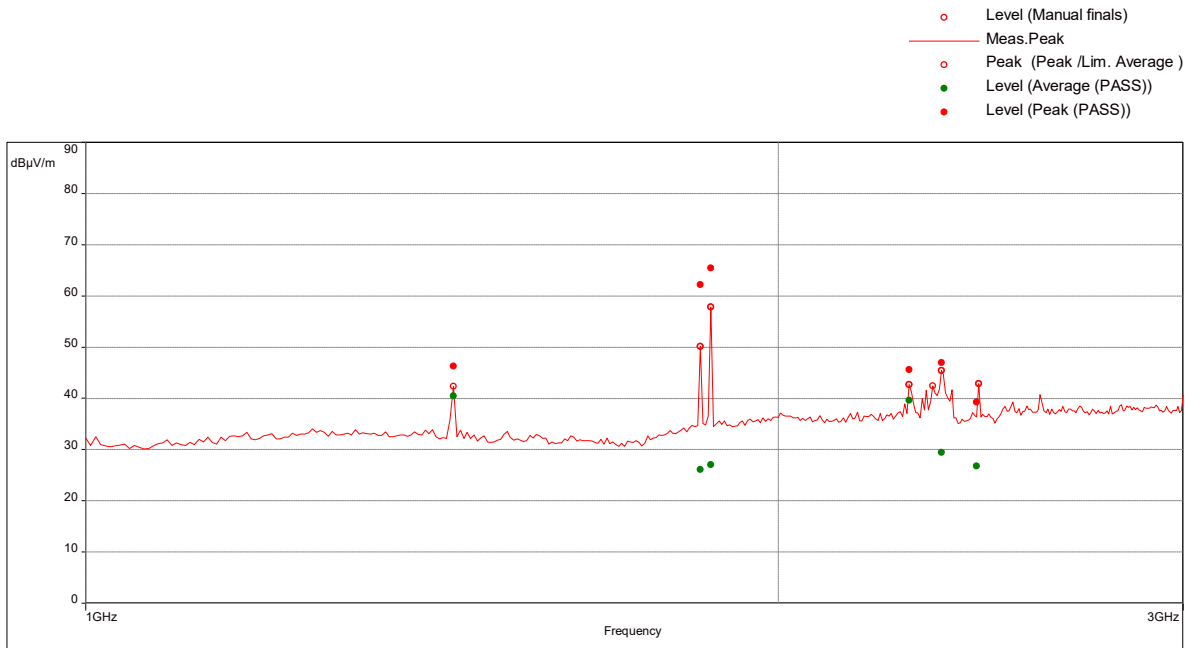

Results:

Peak (PASS) (6)

Frequency (MHz)	Level (dBµV/m)	EIRP Level (dBm)	Limit (dBm)	Margin (dB)	Azimuth (°)	Height (m)	Pol.	RBW (Hz)	Correction (dB)
1443.684211	46.33	-48.93	-13	-35.93	359.00	1.55	Horizontal	1000000.00	-7.57
1851.052632	62.18	-33.08	-13	-20.08	187.00	3.10	Horizontal	1000000.00	-4.73
1868.947368	65.49	-29.77	-13	-16.77	259.00	1.65	Vertical	1000000.00	-4.72
2279.473684	45.61	-49.65	-13	-36.65	18.00	1.65	Horizontal	1000000.00	-4.10
2354.210526	46.98	-48.28	-13	-35.28	25.00	1.75	Horizontal	1000000.00	-3.85
2442.368421	39.26	-56.00	-13	-43.00	119.00	2.65	Vertical	1000000.00	-3.34

EIRP (dBm) = E (dBuV/m) + 20 * Log (D) – 104.7, where D is the measurement distance (in the far field region) in meters.

Peak (EIRP) = Peak (dBuV/m) – 95.2, where D = 3 m.

Intertek

Report Number: 104723800BOX-001	Issued: 10/29/2021 Revised: 11/08/2021 11/10/2021
---------------------------------	---

Upper Band: Mid Channel 25.04 GHz, 160 MHz Bandwidth, MCS0 Modulation, 3-18 GHz

Test Information:

Date and Time	7/2/2021 7:21:44 PM
Client and Project Number	Starry
Engineer	Vathana Ven
Temperature	29 deg C
Humidity	41%
Atmospheric Pressure	1009mbar
Comments	Comet 24, Upper Band: Mid Channel 25.04 GHz, 160 MHz BW, MCS0, att0.5mixer24, BT Tx Mid CH_5GHz Tx CH157 80 MHz BW_3-13GHz Part 30

Graph:

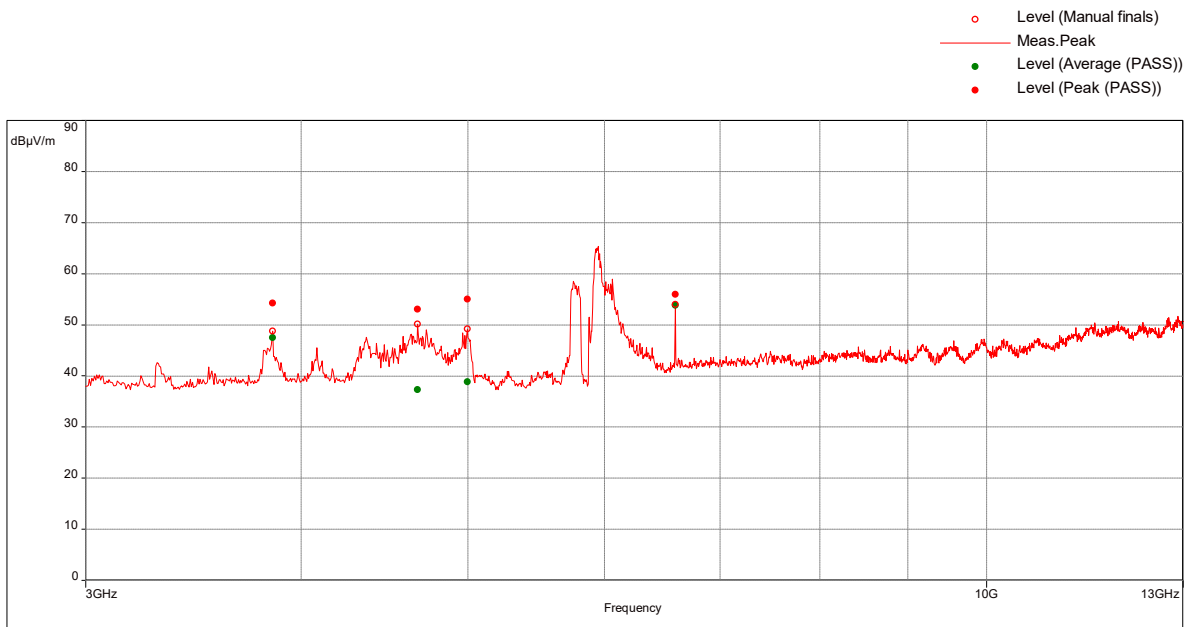

Results:

Peak (PASS) (4)

Frequency (MHz)	Level (dBµV/m)	EIRP Level (dBm)	Limit (dBm)	Margin (dB)	Azimuth (°)	Height (m)	Pol.	RBW (Hz)	Correction (dB)
3850	54.26	-41.00	-13	-28.00	356.00	2.40	Horizontal	1000000.00	-1.06
4676.578947	53.04	-42.22	-13	-29.22	319.00	1.90	Horizontal	1000000.00	0.45
4997.105263	55.03	-40.23	-13	-27.23	335.00	2.10	Horizontal	1000000.00	1.14
6596.578947	55.99	-39.27	-13	-26.27	312.00	1.00	Vertical	1000000.00	4.43

EIRP (dBm) = E (dBµV/m) + 20 * Log (D) – 104.7, where D is the measurement distance (in the far field region) in meters.

Peak (EIRP) = Peak (dBµV/m) – 95.2, where D = 3 m.

Notes: The high peaks are the fundamental frequency signals.

Intertek

Report Number: 104723800BOX-001

Issued: 10/29/2021
Revised: 11/08/2021
11/10/2021

Upper Band: High Channel 25.16 GHz, 160 MHz Bandwidth, MCS0 Modulation, 1-3 GHz

Test Information:

Date and Time	7/2/2021 6:30:29 PM
Client and Project Number	Starry
Engineer	Vathana Ven
Temperature	29 deg C
Humidity	41%
Atmospheric Pressure	1009mbar
Comments	Comet 24, Upper Band: High Channel 25.16 GHz, 160 MHz BW, MCS0, att0.5mixer24, BT Tx Low CH_5GHz Tx CH157 80 MHz BW_1-3GHz Part 30

Graph:

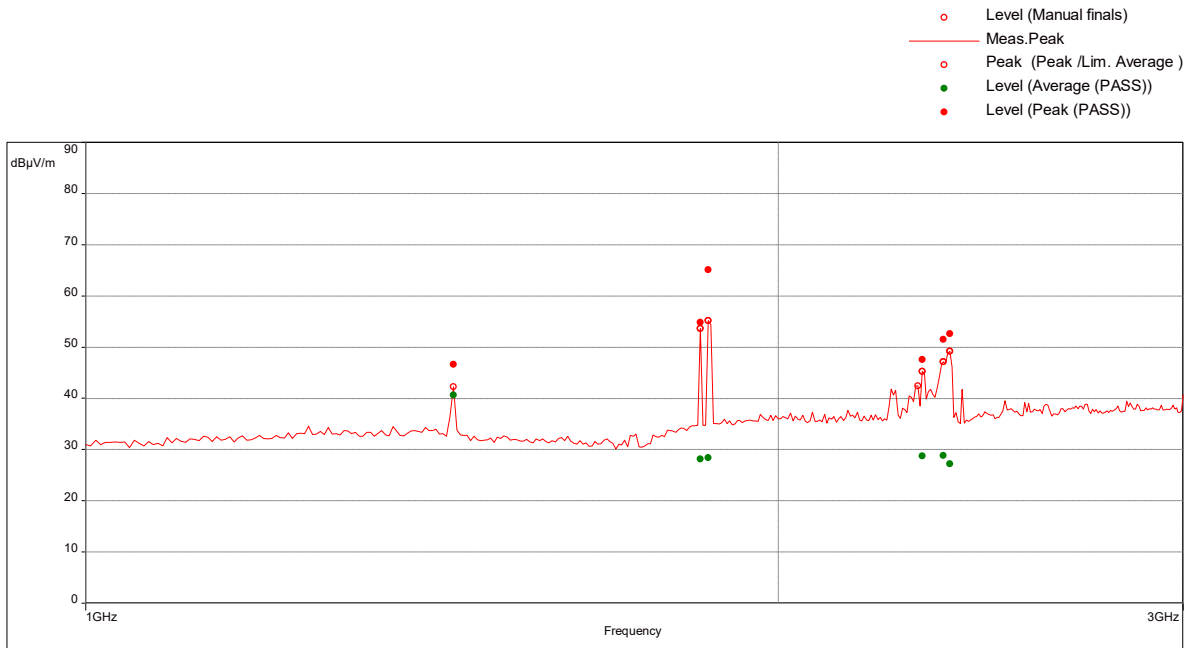

Results:

Peak (PASS) (6)

Frequency (MHz)	Level (dBµV/m)	EIRP Level (dBm)	Limit (dBm)	Margin (dB)	Azimuth (°)	Height (m)	Pol.	RBW (Hz)	Correction (dB)
1443.684211	46.61	-48.65	-13	-35.65	0.00	1.60	Horizontal	1000000.00	-7.57
1851.052632	54.87	-40.39	-13	-27.39	312.00	1.06	Vertical	1000000.00	-4.73
1866.578947	65.15	-30.11	-13	-17.11	135.00	1.00	Horizontal	1000000.00	-4.72
2311.842105	47.56	-47.70	-13	-34.70	32.00	2.05	Horizontal	1000000.00	-4.00
2361.052632	51.50	-43.76	-13	-30.76	24.00	1.95	Horizontal	1000000.00	-3.82
2373.684211	52.64	-42.62	-13	-29.62	32.00	1.55	Horizontal	1000000.00	-3.76

EIRP (dBm) = E (dBuV/m) + 20 * Log (D) – 104.7, where D is the measurement distance (in the far field region) in meters.

Peak (EIRP) = Peak (dBuV/m) – 95.2, where D = 3 m.

Intertek

Report Number: 104723800BOX-001	Issued: 10/29/2021 Revised: 11/08/2021 11/10/2021
---------------------------------	---

Upper Band: High Channel 25.16 GHz, 160 MHz Bandwidth, MCS0 Modulation, 3-18 GHz

Test Information:

Date and Time	7/2/2021 7:00:15 PM
Client and Project Number	Starry
Engineer	Vathana Ven
Temperature	29 deg C
Humidity	41%
Atmospheric Pressure	1009mbar
Comments	Comet 24, Upper Band: High Channel 25.16 GHz, 160 MHz BW, MCS0, att0.5mixer24, BT Tx Low CH_5GHz Tx CH157 80 MHz BW_3-13GHz Part 30

Graph:

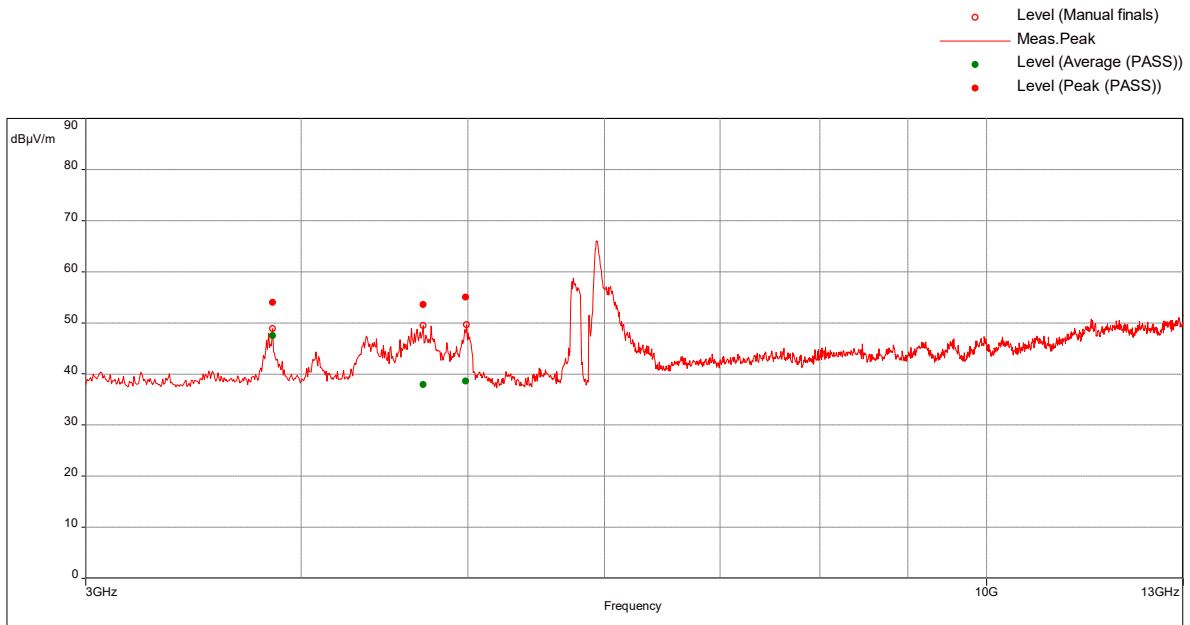

Results:

Peak (PASS) (3)

Frequency (MHz)	Level (dBuV/m)	EIRP Level (dBm)	Limit (dBm)	Margin (dB)	Azimuth (°)	Height (m)	Pol.	RBW (Hz)	Correction (dB)
3850	53.99	-41.27	-13	-28.27	355.00	2.10	Horizontal	1000000.00	-1.06
4708.684211	53.58	-41.68	-13	-28.68	325.00	2.40	Horizontal	1000000.00	0.38
4987.368421	54.99	-40.27	-13	-27.27	341.00	1.50	Horizontal	1000000.00	1.09

EIRP (dBm) = E (dBuV/m) + 20 * Log (D) – 104.7, where D is the measurement distance (in the far field region) in meters.

Peak (EIRP) = Peak (dBuV/m) – 95.2, where D = 3 m.

Notes: The high peaks are the fundamental frequency signals.

Intertek

Report Number: 104723800BOX-001	Issued: 10/29/2021 Revised: 11/08/2021 11/10/2021
---------------------------------	---

Lower and Upper Bands at Low, Mid, and High channels: 160 MHz Bandwidth, MCS0 Modulation, 18-40 GHz

Spurious Emissions												
Company: Starry						Antenna & Cables: HF		Bands: N, LF, HF, SHF				
Model #: Comet 24						Antenna: EMC04_3M-Vert_01-28-2022.txt		EMC04_3M-Hor_01-28-2022.txt				
Serial #: 2123000009						Cable(s): CBLHF2012-5M-2_02-19-2022 cable factors.txt						
Engineers: Vathana Ven				Location: 10m Ch.		Barometer: DAV007		Filter: NONE				
Project #: G104723800			Date(s): 08/12/21									
Standard: FCC Part 30						Temp/Humidity/Pressure: 24 deg C		38%		1004mbar		
Receiver: ROS005-1_10-27-2021				Limit Distance (m): 3								
PreAmp: PRE8 Data 11-25-2021.txt				Test Distance (m): 3								
PreAmp Used? (Y or N):		N		Voltage/Frequency:		POE		Frequency Range:		18-40GHz		
Net = Reading (dBuV/m) + Antenna Factor (dB1/m) + Cable Loss (dB) - Preamp Factor (dB) - Distance Factor (dB)												
Peak: PK Quasi-Peak: QP Average: AVG RMS: RMS; NF = Noise Floor, RB = Restricted Band; Bandwidth denoted as RBW/VBW												
Detector	Ant.	Pol.	Frequency	Reading	Antenna	Cable	Pre-amp	Distance	Net	Limit	Margin	Bandwidth
Type	(V/H)		MHz	dB(uV)	dB(1/m)	dB	dB	dB	dB(m)	dB(m)	dB	
24G radio, Lower Band and Upper Band, BW=160MHz, MCS0, Tx @ Low, Mid, High Ch; BT Tx at Low, Mid, High CH, 5G radio Tx on CH157												
Low, Mid, High Channels 18-40GHz, no emissions were detected above the measuring equipment noise floor.												

Intertek

Report Number: 104723800BOX-001

Issued: 10/29/2021
Revised: 11/08/2021
11/10/2021

Lower and Upper Bands at Low, Mid, and High channels: 160 MHz Bandwidth, MCS0 Modulation, 40-100 GHz

Intertek

Radiated Spurious Emissions

Company: Starry
 Model #: Comet 24
 Serial #: 2123000009
 Engineers: Vathana Ven
 Project #: G104723800
 Standard: FCC Part 30
 Receiver: ROS005-1 (10-27-2021)
 PreAmp: None

Antenna & Cables: N Bands: N, LF, HF, SHF
 Antenna: WR19, WR12, WR8 NONE.
 Cable(s): CBLHF2012-5M-2 NONE.
 Barometer: DAV007 Filter: NONE

Location: 10m chamber
 Date(s): 08/12/21 08/13/21
 Temp/Humidity/Pressure: 26, 30 deg C 31, 39% 1003, 1005 mB

Limit Distance (m): 3
 Test Distance (m): 3

PreAmp Used? (Y or N): N Voltage/Frequency: 120VAC 60Hz Frequency Range: 40-100GHz

Net = Reading (dBuV/m) + Antenna Factor (dB/m) + Cable Loss (dB) - Preamp Factor (dB) - Distance Factor (dB)

Peak: PK Quasi-Peak: QP Average: AVG RMS: RMS; NF = Noise Floor, RB = Restricted Band; Bandwidth denoted as RBW/VBW

Detector Type	Ant. Pol. (V/H)	Frequency GHz	Reading dB(uV/m)	Antenna Factor dB(1/m)	Cable Loss dB	Pre-amp Factor dB	Distance Factor dB	Net dB(uV/m)	Limit dB(uV/m)	Margin dB	Bandwidth	FCC
Note: 40-60 GHz range using WR19, Tx mode, Low CH 24.34GHz (Lower band), MCS0 160MHz BW												
EIRP (dBm) = E (dBuV/m) + 20 * LOG (D) - 104.7 ; where D is the measurement distance (in the far field region) in m												
PK	V	48680.000	19.22	41.43	2.96	0.00	0.00	-31.55	-13.00	-18.55	1/3 MHz	Noise floor
PK	H	48680.000	15.95	41.43	2.96	0.00	0.00	-34.82	-13.00	-21.82	1/3 MHz	Noise floor
Note: 40-60 GHz range using WR19, Tx mode, Mid CH 24.35GHz (Lower band), MCS0 160MHz BW												
EIRP (dBm) = E (dBuV/m) + 20 * LOG (D) - 104.7 ; where D is the measurement distance (in the far field region) in m												
PK	V	48700.000	18.59	41.43	2.96	0.00	0.00	-32.18	-13.00	-19.18	1/3 MHz	Noise floor
PK	H	48700.000	18.51	41.43	2.96	0.00	0.00	-32.26	-13.00	-19.26	1/3 MHz	Noise floor
Note: 40-60 GHz range using WR19, Tx mode, High CH 24.36GHz (Lower band), MCS0 160MHz BW												
EIRP (dBm) = E (dBuV/m) + 20 * LOG (D) - 104.7 ; where D is the measurement distance (in the far field region) in m												
PK	V	48720.000	17.80	41.44	2.96	0.00	0.00	-32.96	-13.00	-19.96	1/3 MHz	Noise floor
PK	H	48720.000	19.84	41.44	2.96	0.00	0.00	-30.92	-13.00	-17.92	1/3 MHz	Noise floor
Note: 40-60 GHz range using WR19, Tx mode, Low CH 24.84GHz (Upper band), MCS0 160MHz BW												
EIRP (dBm) = E (dBuV/m) + 20 * LOG (D) - 104.7 ; where D is the measurement distance (in the far field region) in m												
PK	V	49480.000	17.31	41.61	2.96	0.00	0.00	-33.28	-13.00	-20.28	1/3 MHz	Noise floor
PK	H	49480.000	19.80	41.61	2.96	0.00	0.00	-30.79	-13.00	-17.79	1/3 MHz	Noise floor
Note: 40-60 GHz range using WR19, Tx mode, Mid CH 25.04GHz (Upper band), MCS0 160MHz BW												
EIRP (dBm) = E (dBuV/m) + 20 * LOG (D) - 104.7 ; where D is the measurement distance (in the far field region) in m												
PK	V	50080.000	17.77	41.68	2.96	0.00	0.00	-32.75	-13.00	-19.75	1/3 MHz	Noise floor
PK	H	50080.000	19.54	41.68	2.96	0.00	0.00	-30.98	-13.00	-17.98	1/3 MHz	Noise floor
Note: 40-60 GHz range using WR19, Tx mode, High CH 25.16GHz (Upper band), MCS0 160MHz BW												
EIRP (dBm) = E (dBuV/m) + 20 * LOG (D) - 104.7 ; where D is the measurement distance (in the far field region) in m												
PK	V	50320.000	17.34	41.72	2.96	0.00	0.00	-33.14	-13.00	-20.14	1/3 MHz	Noise floor
PK	H	50320.000	18.33	41.72	2.96	0.00	0.00	-32.15	-13.00	-19.15	1/3 MHz	Noise floor
Note: 60-100 GHz range using WR8 and WR12, Tx mode, Low CH 24.34GHz (Lower band), MCS0 160MHz BW												
EIRP (dBm) = E (dBuV/m) + 20 * LOG (D) - 104.7 ; where D is the measurement distance (in the far field region) in m												
PK	V	73020.000	19.20	45.95	2.96	0.00	0.00	-27.04	-13.00	-14.04	1/3 MHz	Noise floor
PK	H	73020.000	24.12	45.95	2.96	0.00	0.00	-22.12	-13.00	-9.12	1/3 MHz	Noise floor
Note: 60-100 GHz range using WR8 and WR12, Tx mode, Mid CH 24.35GHz (Lower band), MCS0 160MHz BW												
EIRP (dBm) = E (dBuV/m) + 20 * LOG (D) - 104.7 ; where D is the measurement distance (in the far field region) in m												
PK	V	73050.000	20.91	45.96	2.96	0.00	0.00	-25.33	-13.00	-12.33	1/3 MHz	Noise floor
PK	H	73050.000	22.52	45.96	2.96	0.00	0.00	-23.72	-13.00	-10.72	1/3 MHz	Noise floor
Note: 60-100 GHz range using WR8 and WR12, Tx mode, High CH 24.36GHz (Lower band), MCS0 160MHz BW												
EIRP (dBm) = E (dBuV/m) + 20 * LOG (D) - 104.7 ; where D is the measurement distance (in the far field region) in m												
PK	V	73080.000	20.88	45.96	2.96	0.00	0.00	-25.36	-13.00	-12.36	1/3 MHz	Noise floor
PK	H	73080.000	23.49	45.96	2.96	0.00	0.00	-22.75	-13.00	-9.75	1/3 MHz	Noise floor
Note: 60-100 GHz range using WR8 and WR12, Tx mode, Low CH 24.84GHz (Upper band), MCS0 160MHz BW												
EIRP (dBm) = E (dBuV/m) + 20 * LOG (D) - 104.7 ; where D is the measurement distance (in the far field region) in m												
PK	V	74520.000	18.45	46.13	2.96	0.00	0.00	-27.62	-13.00	-14.62	1/3 MHz	Noise floor
PK	H	74520.000	21.93	46.13	2.96	0.00	0.00	-24.14	-13.00	-11.14	1/3 MHz	Noise floor
Note: 60-100 GHz range using WR8 and WR12, Tx mode, Mid CH 25.04GHz (Upper band), MCS0 160MHz BW												
EIRP (dBm) = E (dBuV/m) + 20 * LOG (D) - 104.7 ; where D is the measurement distance (in the far field region) in m												
PK	V	75120.000	18.97	46.20	2.96	0.00	0.00	-27.03	-13.00	-14.03	1/3 MHz	Noise floor
PK	H	75120.000	21.93	46.20	2.96	0.00	0.00	-24.07	-13.00	-11.07	1/3 MHz	Noise floor
Note: 60-100 GHz range using WR8 and WR12, Tx mode, High CH 25.16GHz (Upper band), MCS0 160MHz BW												
EIRP (dBm) = E (dBuV/m) + 20 * LOG (D) - 104.7 ; where D is the measurement distance (in the far field region) in m												
PK	V	75480.000	19.87	46.24	2.96	0.00	0.00	-26.09	-13.00	-13.09	1/3 MHz	Noise floor
PK	H	75480.000	20.66	46.24	2.96	0.00	0.00	-25.30	-13.00	-12.30	1/3 MHz	Noise floor

Intertek

Report Number: 104723800BOX-001

Issued: 10/29/2021

Revised: 11/08/2021

11/10/2021

Test Personnel: Vathana F. Ven *VFK*
Supervising/Reviewing
Engineer:
(Where Applicable) N/A
Product Standard: FCC 47CFR Part 30 Subparts C
Input Voltage: 48 VDC Via External P/S
Pretest Verification w/
BB Source: Yes

Test Date: 07/02/2021, 08/12/2021, 08/13/2021,
09/13/2021

Limit Applied: See Report Section 8.3

Ambient Temperature: 29, 26, 30, 23 °C

Relative Humidity: 41, 31, 39, 39 %

Atmospheric Pressure: 1009, 1003, 1005, 1007 mbars

Deviations, Additions, or Exclusions: None

Report Number: 104723800BOX-001	Issued: 10/29/2021 Revised: 11/08/2021 11/10/2021
---------------------------------	---

9 Occupied Bandwidths

9.1 Requirements

FCC §2.1049 Measurements required: Occupied bandwidth

The occupied bandwidth, that is the frequency bandwidth such that, below its lower and above its upper frequency limits, the mean powers radiated are each equal to 0.5 percent of the total mean power radiated by a given emission shall be measured.

9.2 Method

Tests are performed in accordance with FCC 47CFR Part 30 Subpart E, KDB 842590 D01 Upper Microwave Flexible Use Service v01r02 April 20, 2021 Subclause 4.3, and ANSI C63.26-2015 Subclause 5.4. The measurement was made on the maximum field strength in the same worst-case orientation as in report Section 6.1 with the Spectrum Analyzer setting as specified in ANSI C63.26-2015 Subclause 5.4.

TEST SITE: 10m ALSE

The 10m ALSE is 13m (Length) x 21m (Depth) x 10m (Height) with the effective size in terms of space from the tips of the absorber is 12m (Length) x 20m (Depth) x 8.5m (Height). This chamber achieves broadband performance using a unique arrangement of hybrid and ferrite tile absorber. This chamber has a built in 3m diameter turntable (Embedded type). The metal structure of the table makes electrical connection around the entire circumference of the turntable to the ground plane with a metal brush type connection. The turntable is located on one end of the chamber and the antennas are mounted 3 and 10 meters away at the other end of the chamber on the adjustable an Antenna Mast. The antenna mast is a non-conductive bore sighted type with remote control of antenna height and polarization. The Antenna Mast and the turntable can be remotely controlled through the controller located in the adjacent Control room. A Styrofoam table 80 cm high is used for table-top equipment.

9.3 Test Equipment Used:

Asset	Description	Manufacturer	Model	Serial	Cal Date	Cal Due
DAV007	Weather Station Vantage Vue	Davis	6250	MS191212003	03/20/2021	03/20/2022
EMC04	ANTENNA, RIDGED GUIDE, 18-40 GHZ	EMCO	3116	2090	01/28/2021	01/28/2022
ROS005-1'	Signal and Spectrum Analyzer	Rohde and Shwartz	FSW43	100646	10/27/2020	10/27/2021
CBLHF2012-5M-2'	5m 9kHz-40GHz Coaxial Cable - SET2	Huber & Suhner	SF102	252676002	02/19/2021	02/19/2022

Software Utilized:

Name	Manufacturer	Version
None	--	--

Intertek

Report Number: 104723800BOX-001

Issued: 10/29/2021

Revised: 11/08/2021

11/10/2021

9.4 Results:

The sample tested was found to Comply.

Limit – FCC 47CFR Part 30 Subparts E Section 30.403: The maximum bandwidth authorized per frequency to the stations under this part of the section is 200 MHz.

Frequency (GHz)	Transmitting Polarity	Modulation	Bandwidth (MHz)	Transmitting Path	Occupied Bandwidth (MHz)
24.27	Vertical	MCS8	20	0	18.50
24.28	Vertical	MCS8	20	0	18.51
24.29	Vertical	MCS8	20	0	18.41
24.77	Vertical	MCS8	20	0	18.73
24.97	Vertical	MCS8	20	0	18.45
25.09	Vertical	MCS8	20	0	18.38
24.27	Horizontal	MCS8	20	0	18.44
24.28	Horizontal	MCS8	20	0	18.18
24.29	Horizontal	MCS8	20	0	18.34
24.77	Horizontal	MCS8	20	0	18.48
24.97	Horizontal	MCS8	20	0	18.64
25.09	Horizontal	MCS8	20	0	18.54
24.34	Vertical	MCS0	160	0	157.16
24.35	Vertical	MCS0	160	0	155.04
24.36	Vertical	MCS0	160	0	154.83
24.84	Vertical	MCS0	160	0	154.21
25.04	Vertical	MCS0	160	0	154.38
25.16	Vertical	MCS0	160	0	152.97
24.34	Horizontal	MCS0	160	0	157.57
24.35	Horizontal	MCS0	160	0	154.20
24.36	Horizontal	MCS0	160	0	154.67
24.84	Horizontal	MCS0	160	0	154.26
25.04	Horizontal	MCS0	160	0	153.97
25.16	Horizontal	MCS0	160	0	153.67

Report Number: 104723800BOX-001	Issued: 10/29/2021 Revised: 11/08/2021 11/10/2021
---------------------------------	---

9.5 Setup Photographs:

Confidential – Photo not included in this report

9.6 Plots/Data:

Occupied Bandwidth (Vertical Polarity) – 24.27GHz_BW20M_MCS8_Path 0

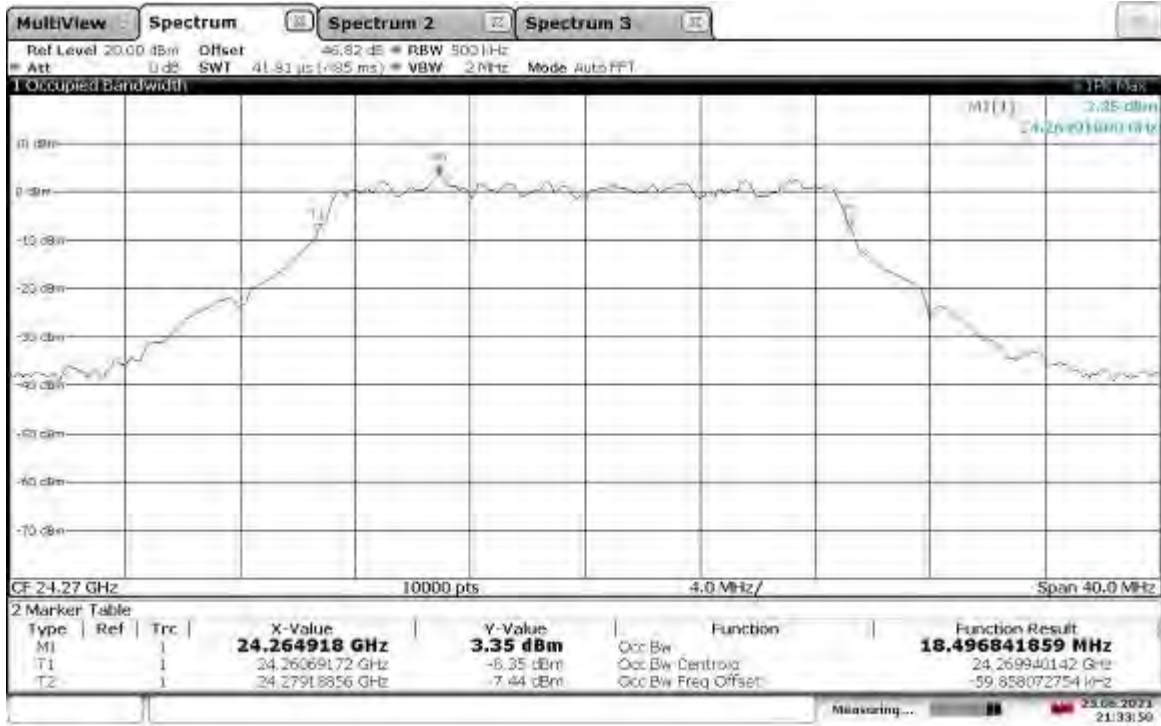

21:33:51 23.06.2021

Occupied Bandwidth (Vertical Polarity) – 24.28GHz_BW20M_MCS8_Path 0

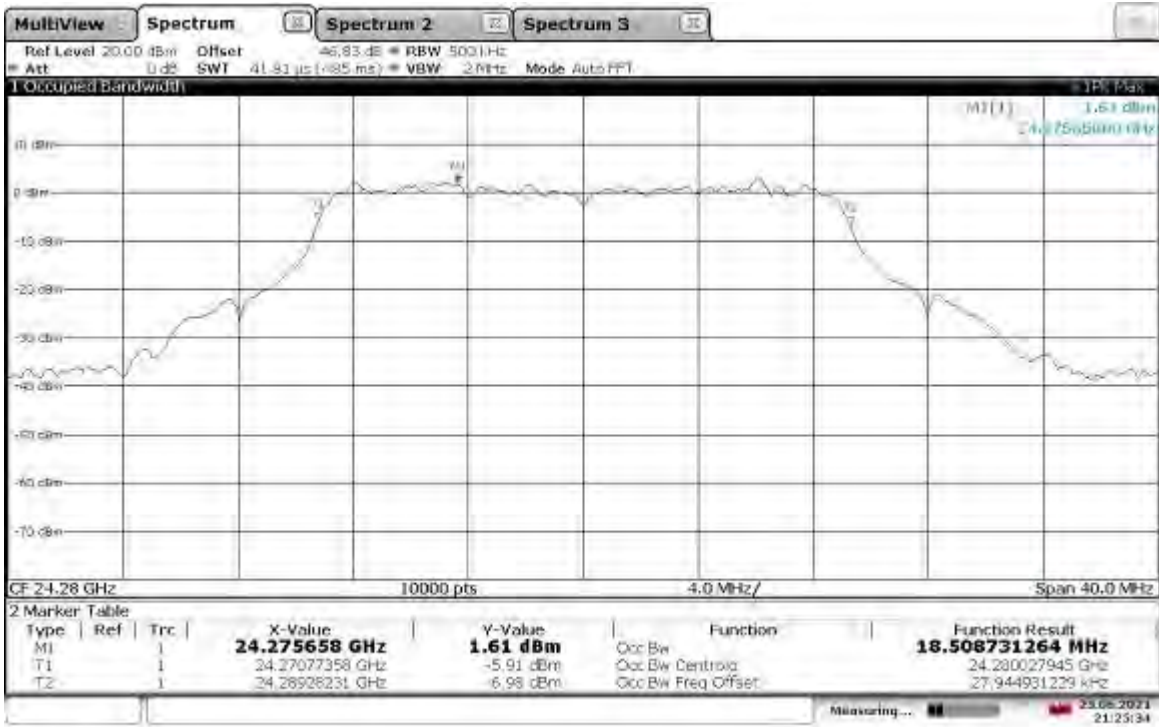

21:25:35 23.06.2021

Occupied Bandwidth (Vertical Polarity) – 24.29GHz_BW20M_MCS8_Path 0

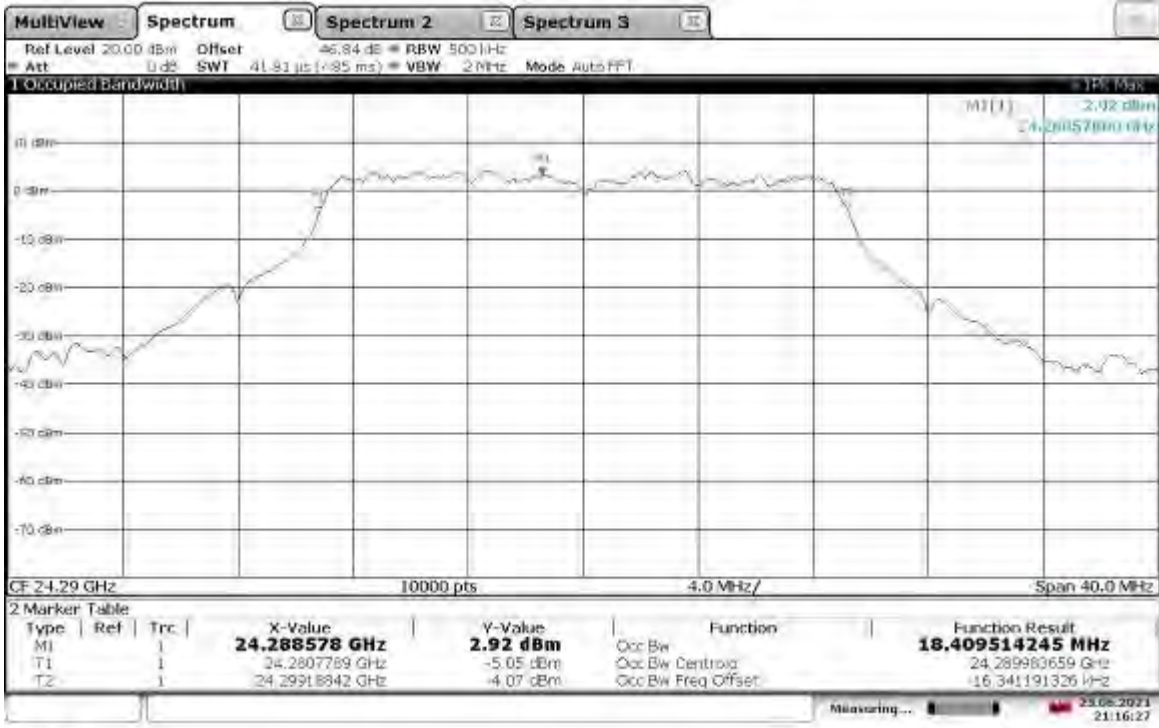

21:16:28 23.06.2021

Occupied Bandwidth (Vertical Polarity) – 24.77GHz_BW20M_MCS8_Path 0

Intertek

Report Number: 104723800BOX-001

Issued: 10/29/2021
Revised: 11/08/2021
11/10/2021

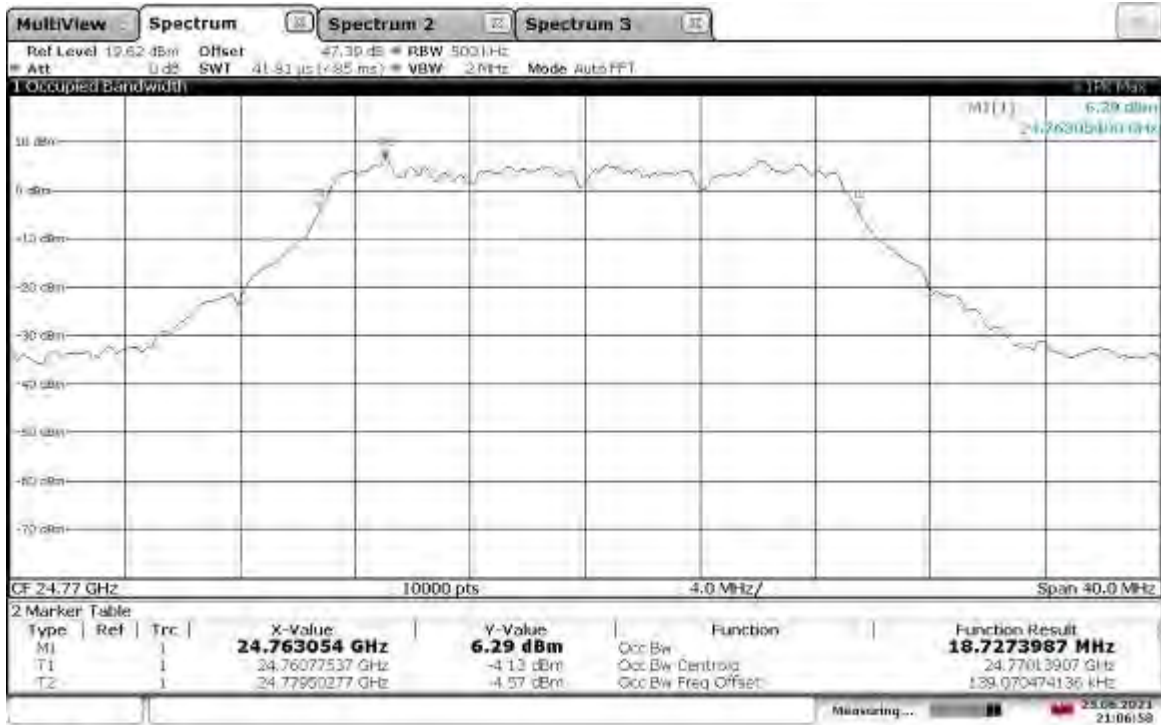

21:06:58 23.06.2021

Occupied Bandwidth (Vertical Polarity) – 24.97GHz_BW20M_MCS8_Path 0

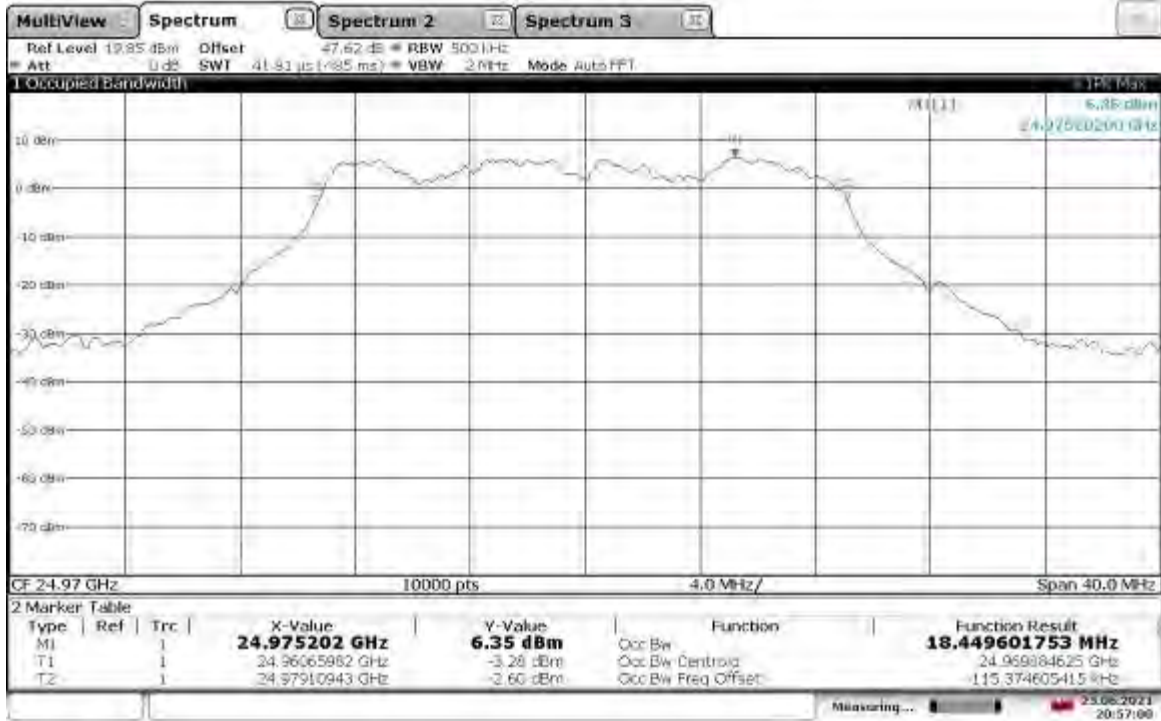

20:57:00 23.06.2021

Occupied Bandwidth (Vertical Polarity) – 25.09GHz_BW20M_MCS8_Path 0

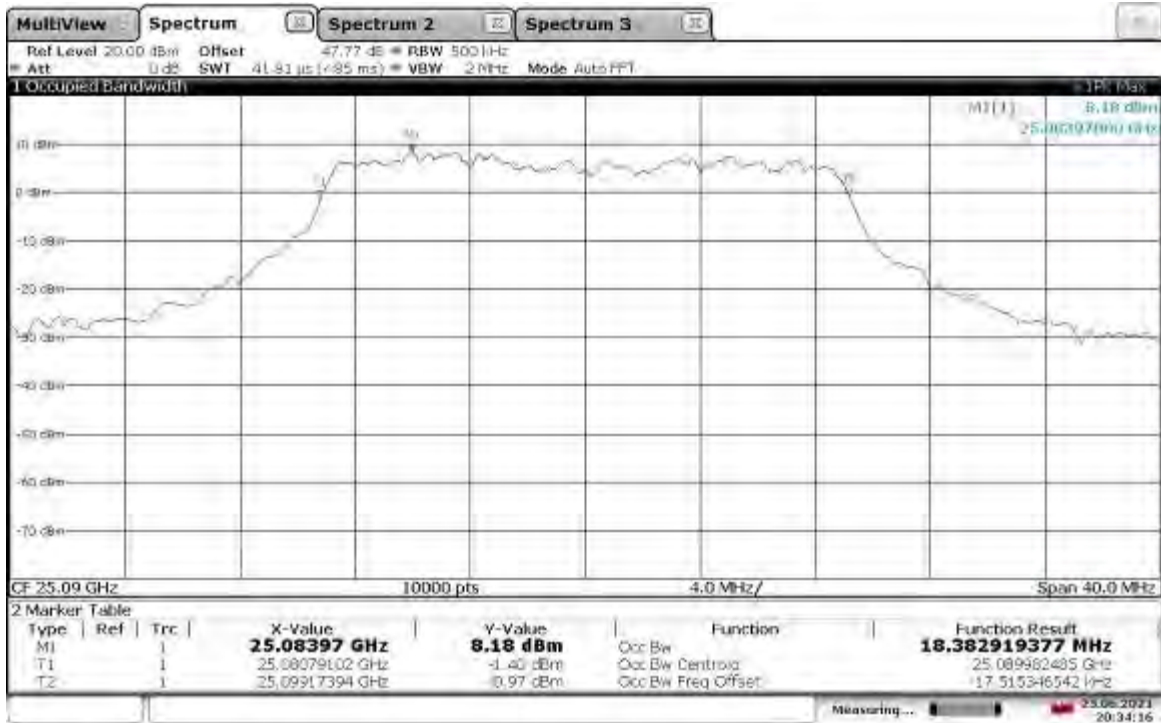

20:54:17 23.06.2021

Occupied Bandwidth (Horizontal Polarity) – 24.27GHz_BW20M_MCS8_Path 0



18:46:17 23.06.2021

Occupied Bandwidth (Horizontal Polarity) – 24.28GHz_BW20M_MCS8_Path 0

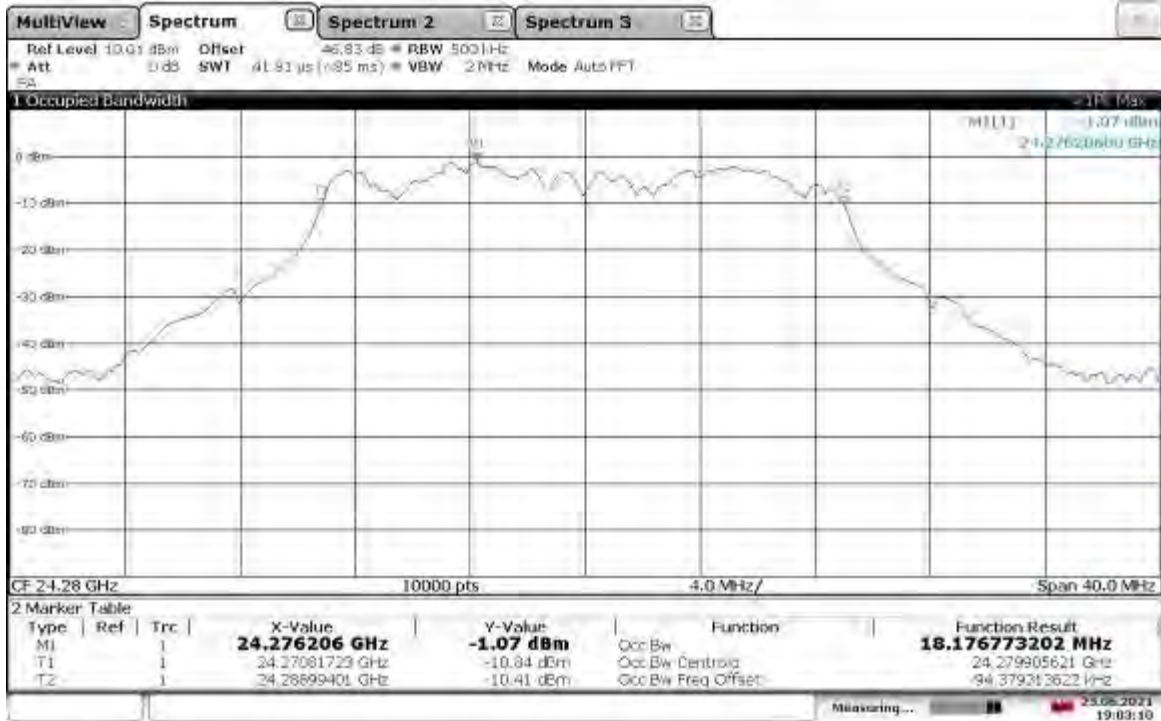

19:03:11 23.06.2021

Occupied Bandwidth (Horizontal Polarity) – 24.29GHz_BW20M_MCS8_Path 0



19:11:30 23.06.2021

Occupied Bandwidth (Horizontal Polarity) – 24.77GHz_BW20M_MCS8_Path 0



19:23:24 23.06.2021

Occupied Bandwidth (Horizontal Polarity) – 24.97GHz_BW20M_MCS8_Path 0

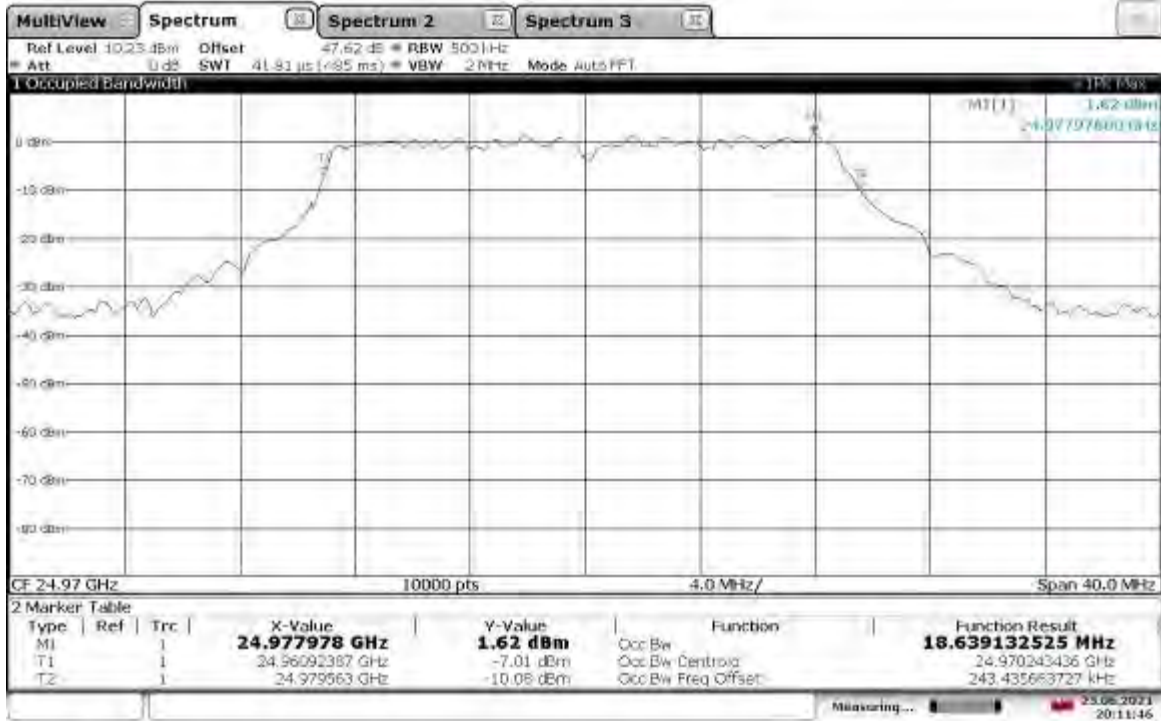

20:11:47 23.06.2021

Occupied Bandwidth (Horizontal Polarity) – 25.09GHz_BW20M_MCS8_Path 0

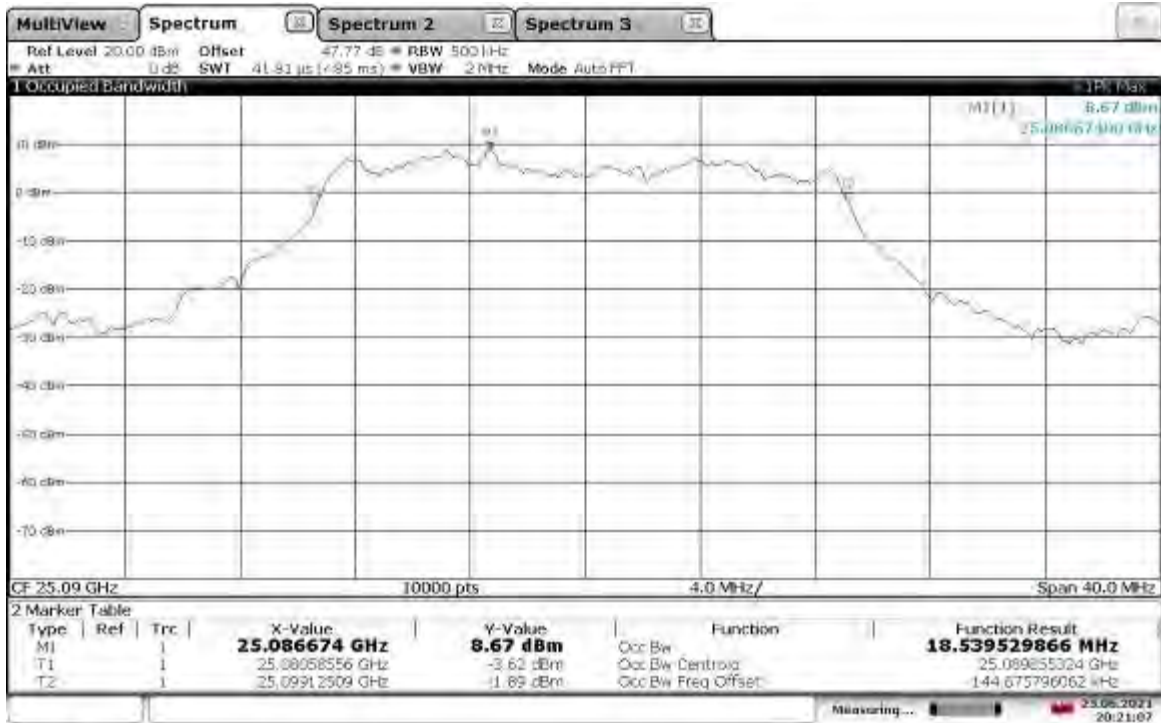

20:21:08 23.06.2021

Occupied Bandwidth (Vertical Polarity) – 24.34GHz_BW160M_MCS0_Path 0

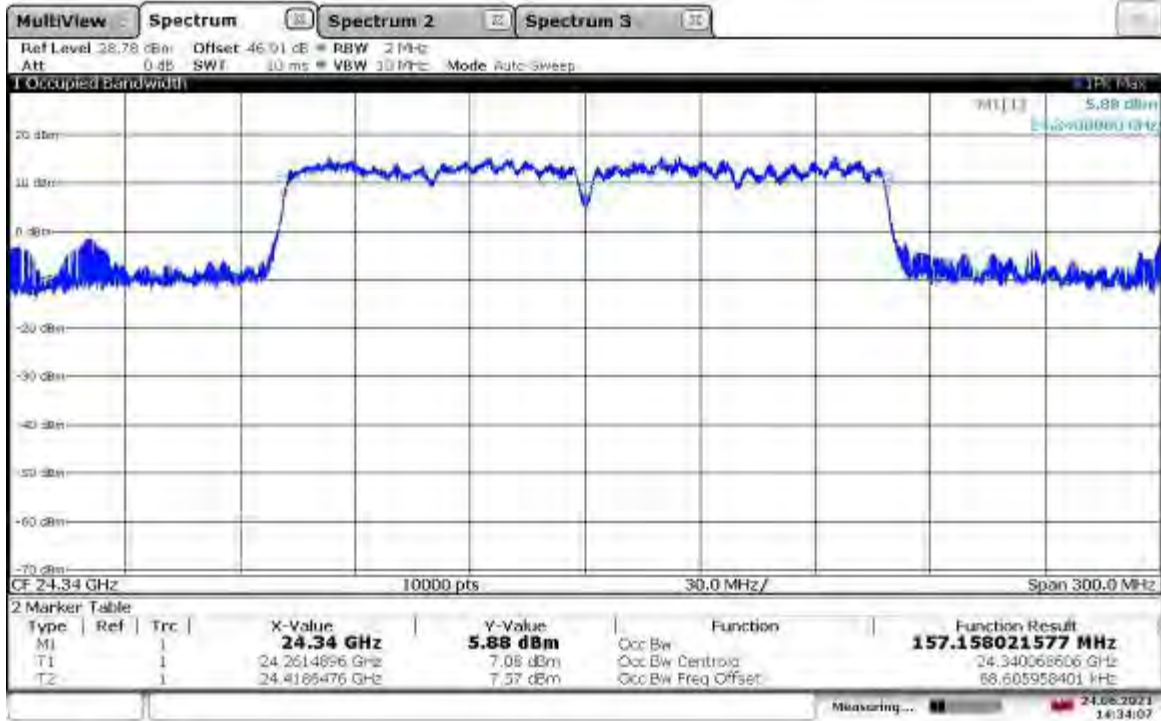

14:34:07 24.06.2021

Occupied Bandwidth (Vertical Polarity) – 24.35GHz_BW160M_MCS0_Path 0

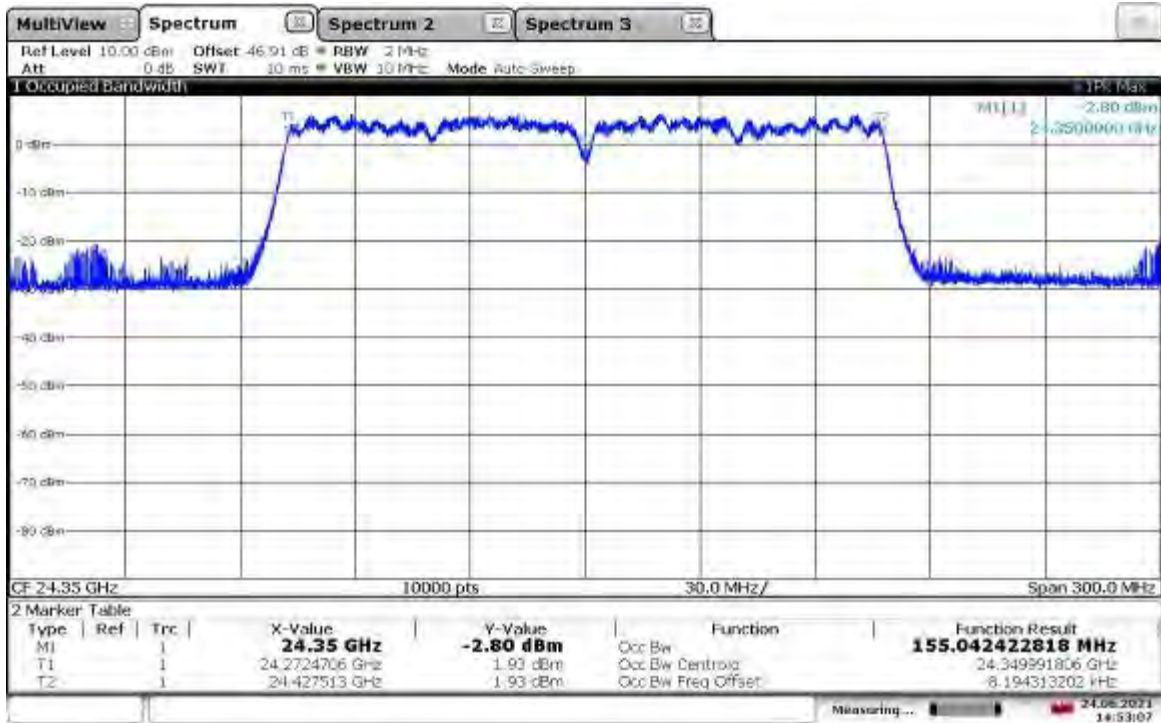

14:53:07 24.06.2021

Occupied Bandwidth (Vertical Polarity) – 24.36GHz_BW160M_MCS0_Path 0

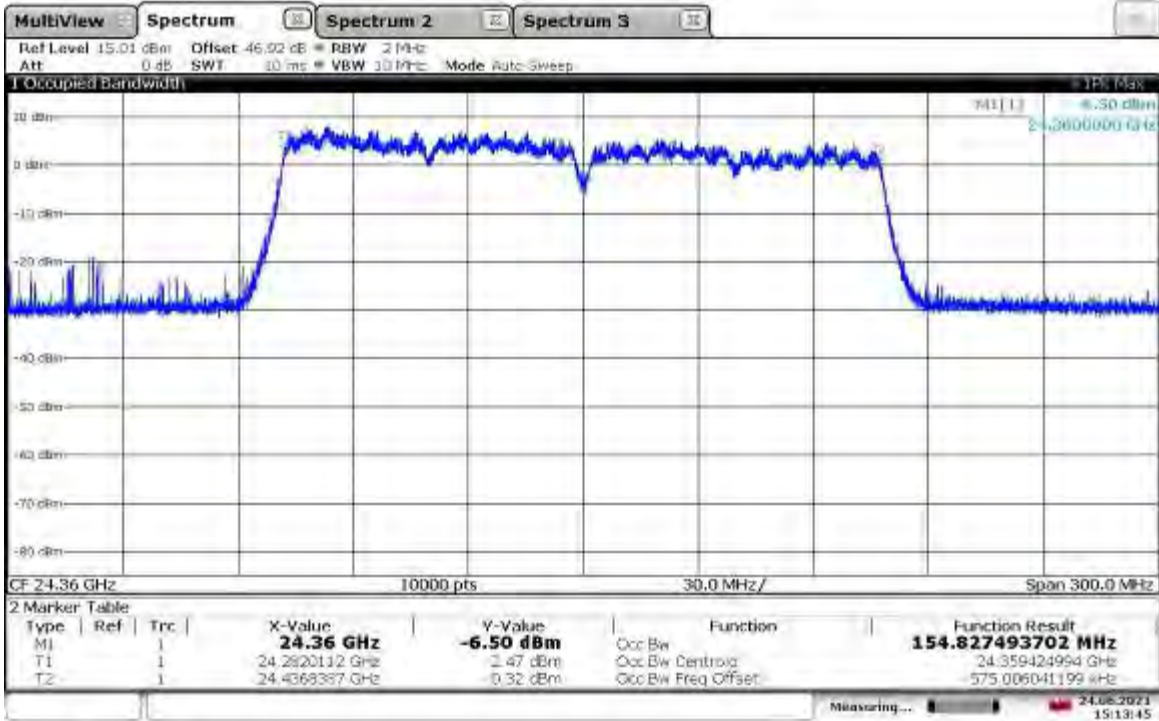

15:13:46 24.06.2021

Occupied Bandwidth (Vertical Polarity) – 24.84GHz_BW160M_MCS0_Path 0

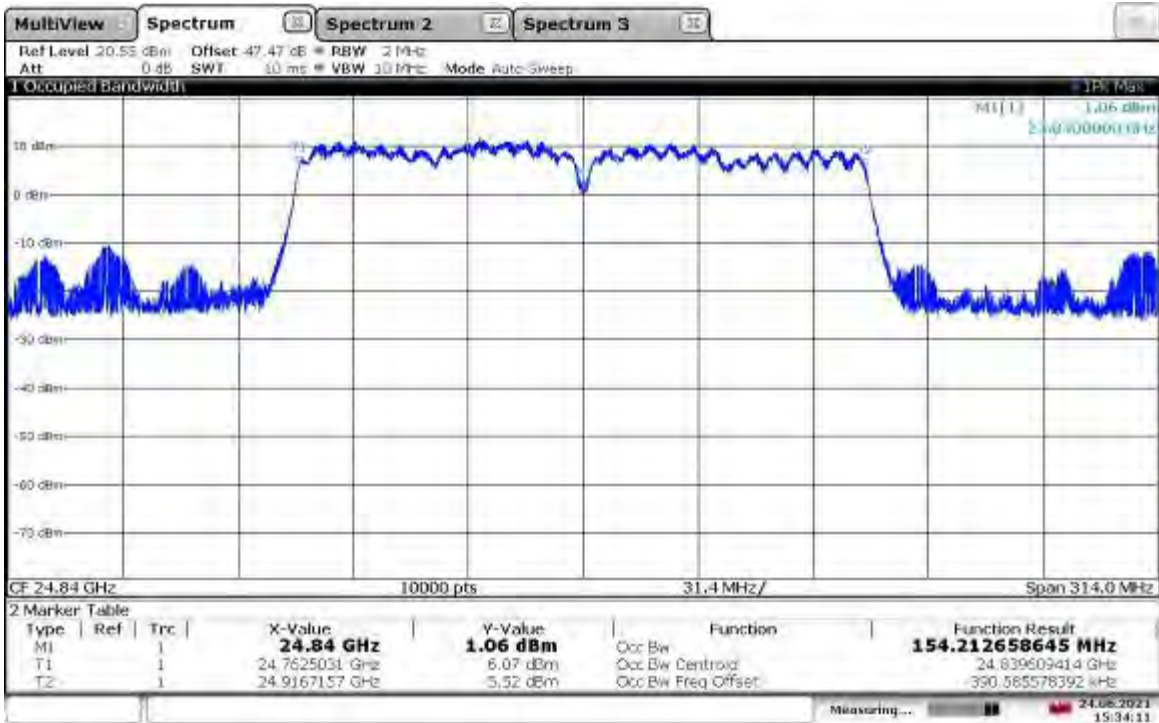

15:34:11 24.06.2021

Intertek

Report Number: 104723800BOX-001

Issued: 10/29/2021
Revised: 11/08/2021
11/10/2021

Occupied Bandwidth (Vertical Polarity) – 25.04GHz_BW160M_MCS0_Path 0

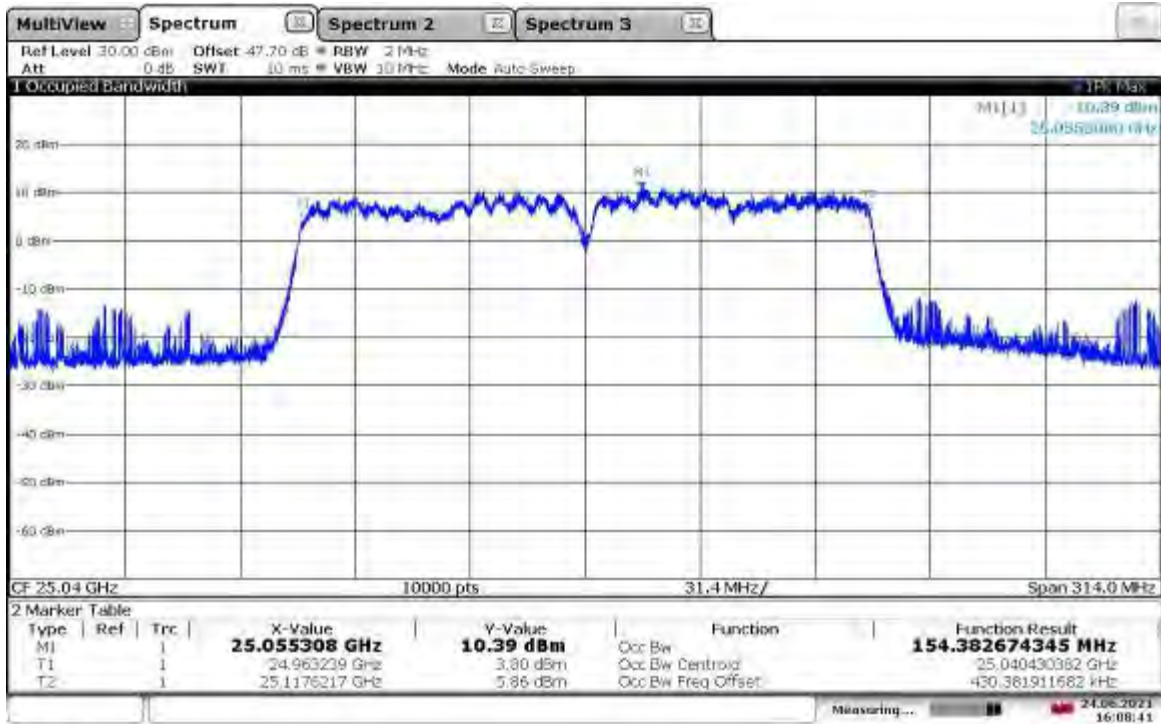

16:08:41 24.06.2021

Occupied Bandwidth (Vertical Polarity) – 25.16GHz_BW160M_MCS0_Path 0

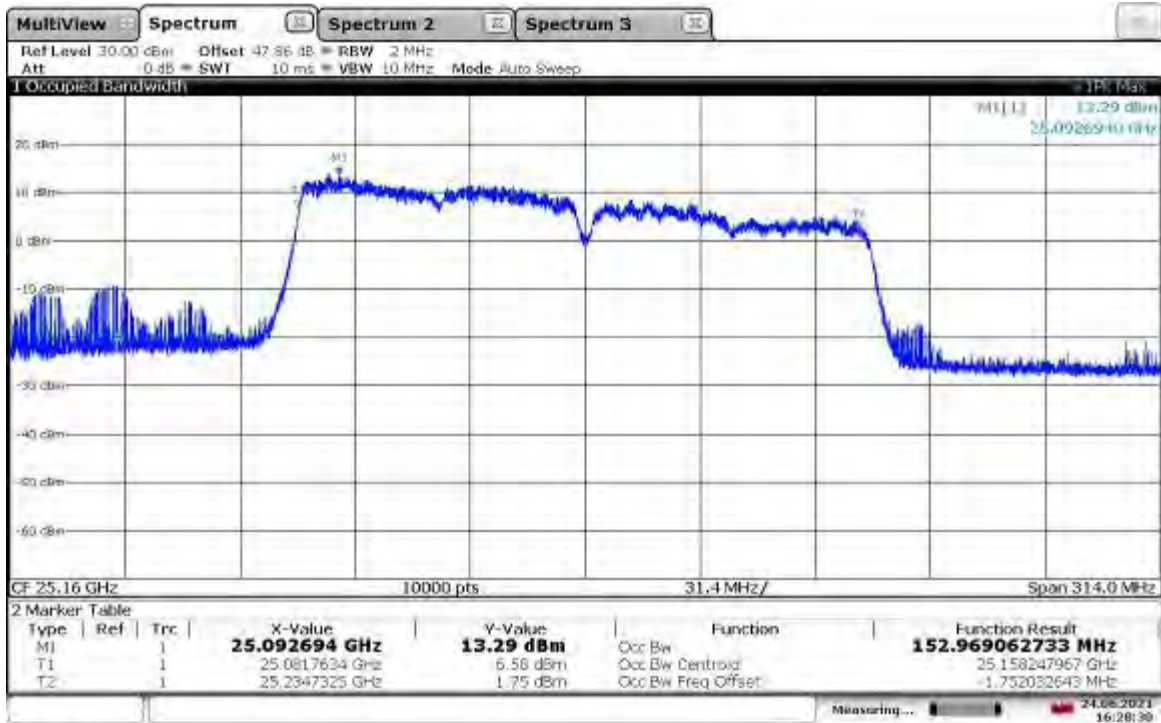

16:28:30 24.06.2021

Occupied Bandwidth (Horizontal Polarity) – 24.34MHz_BW160M_MCS0_Path 0

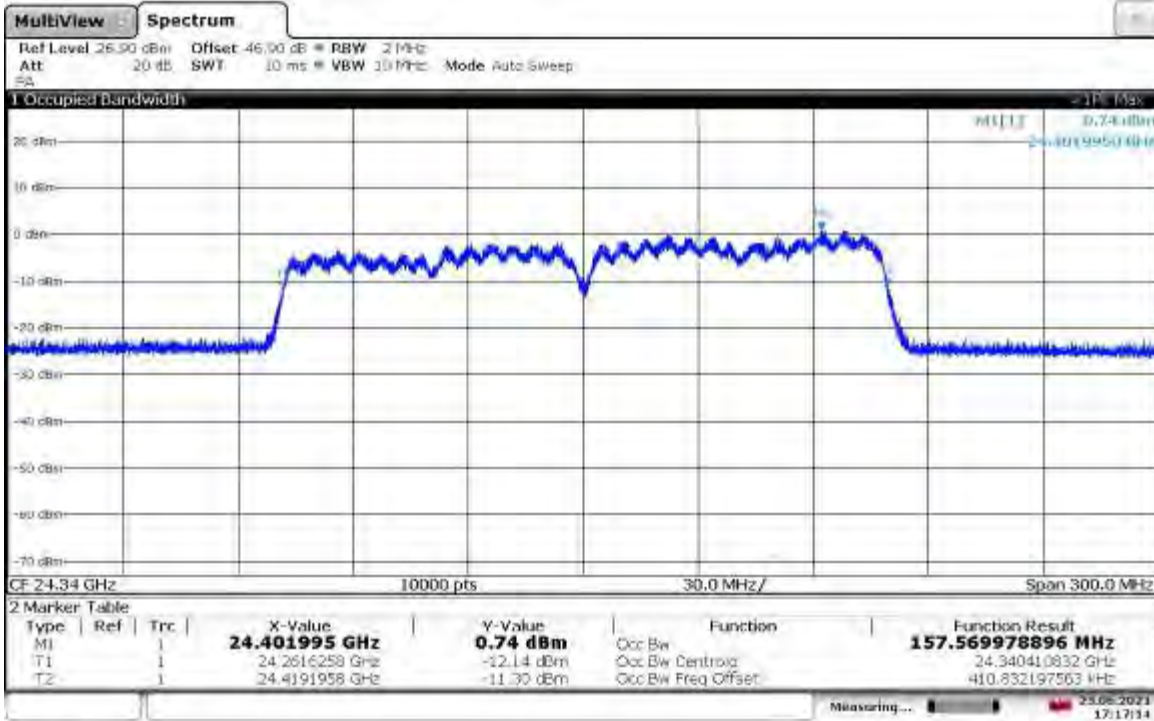

17:17:15 23.06.2021

Occupied Bandwidth (Horizontal Polarity) – 24.35MHz_BW160M_MCS0_Path 0

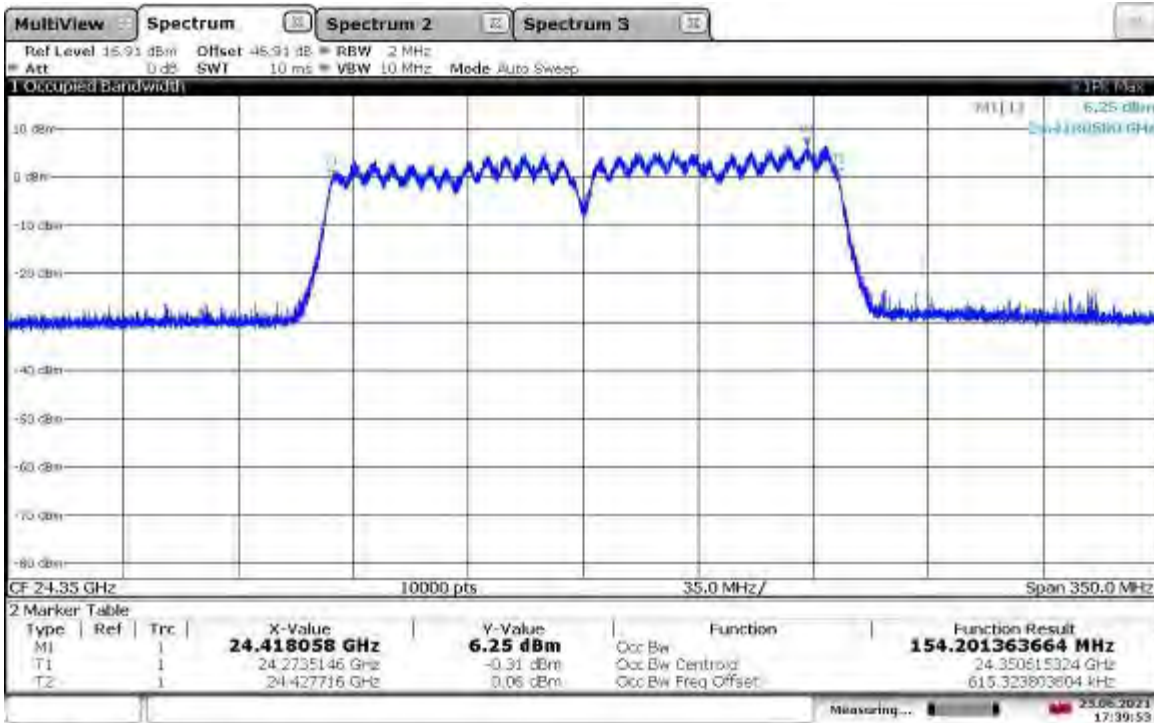

17:39:54 23.06.2021

Occupied Bandwidth (Horizontal Polarity) – 24.36GHz_BW160M_MCS0_Path 0

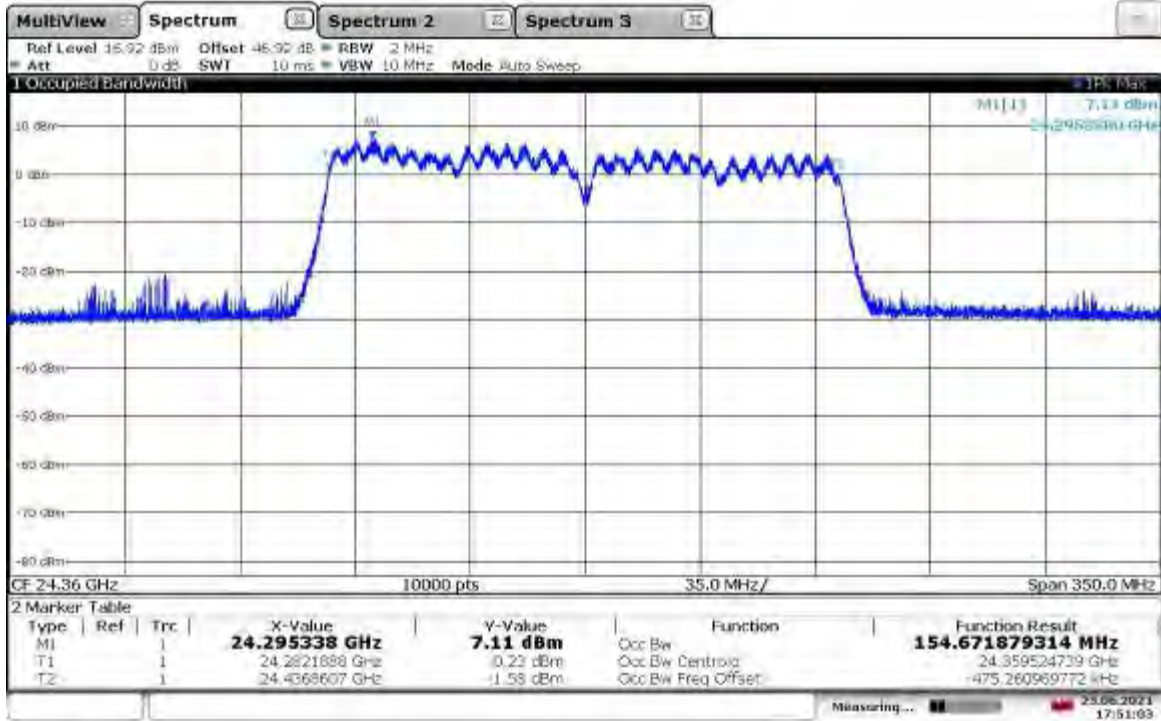

17:51:03 23.06.2021

Occupied Bandwidth (Horizontal Polarity) – 24.84GHz_BW160M_MCS0_Path 0

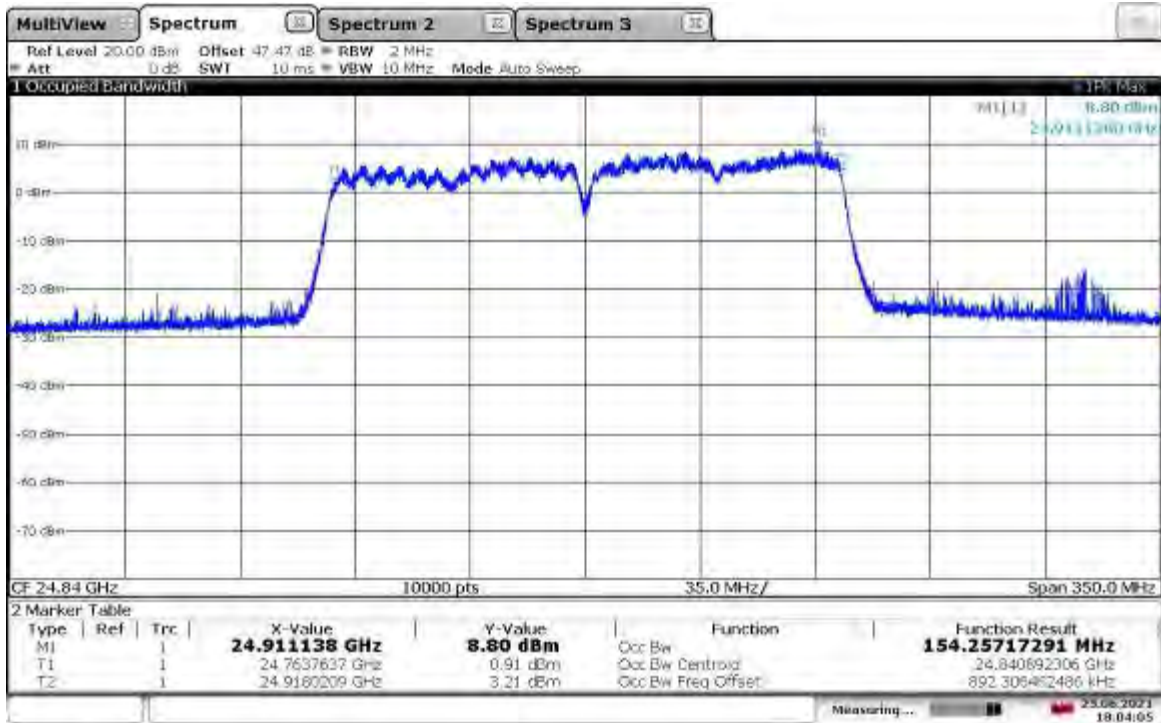

18:04:06 23.06.2021

Occupied Bandwidth (Horizontal Polarity) – 25.04GHz_BW160M_MCS0_Path 0

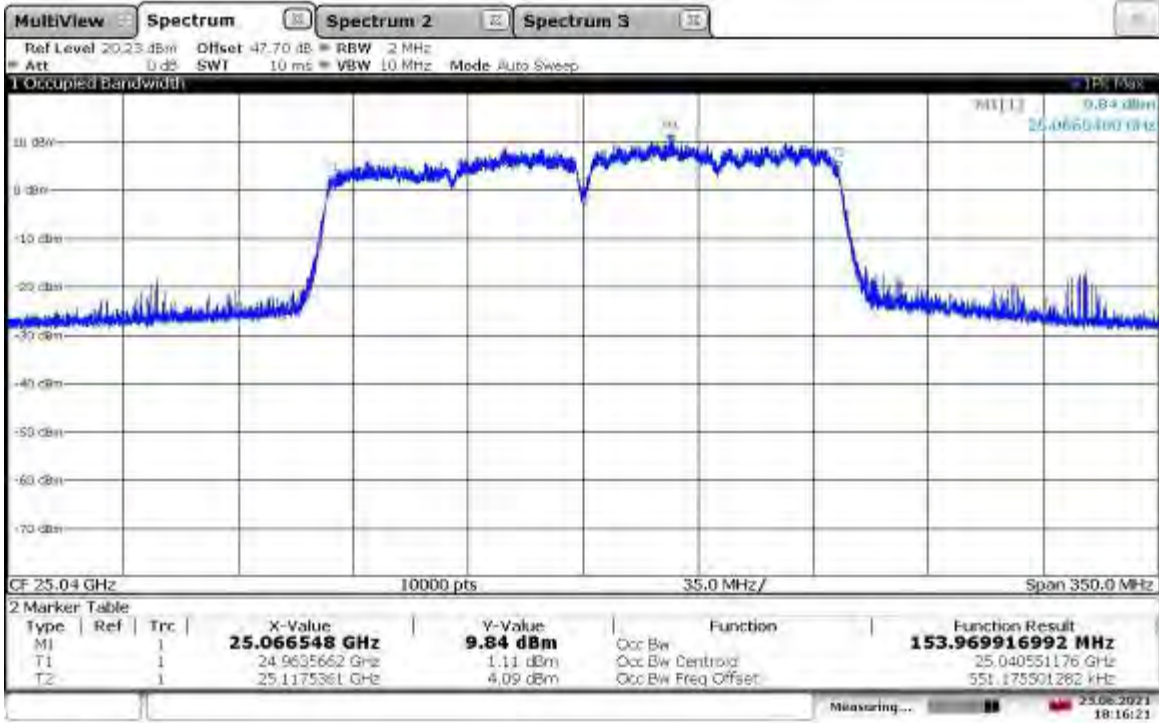

18:16:21 23.06.2021

Occupied Bandwidth (Horizontal Polarity) – 25.16GHz_BW160M_MCS0_Path 0

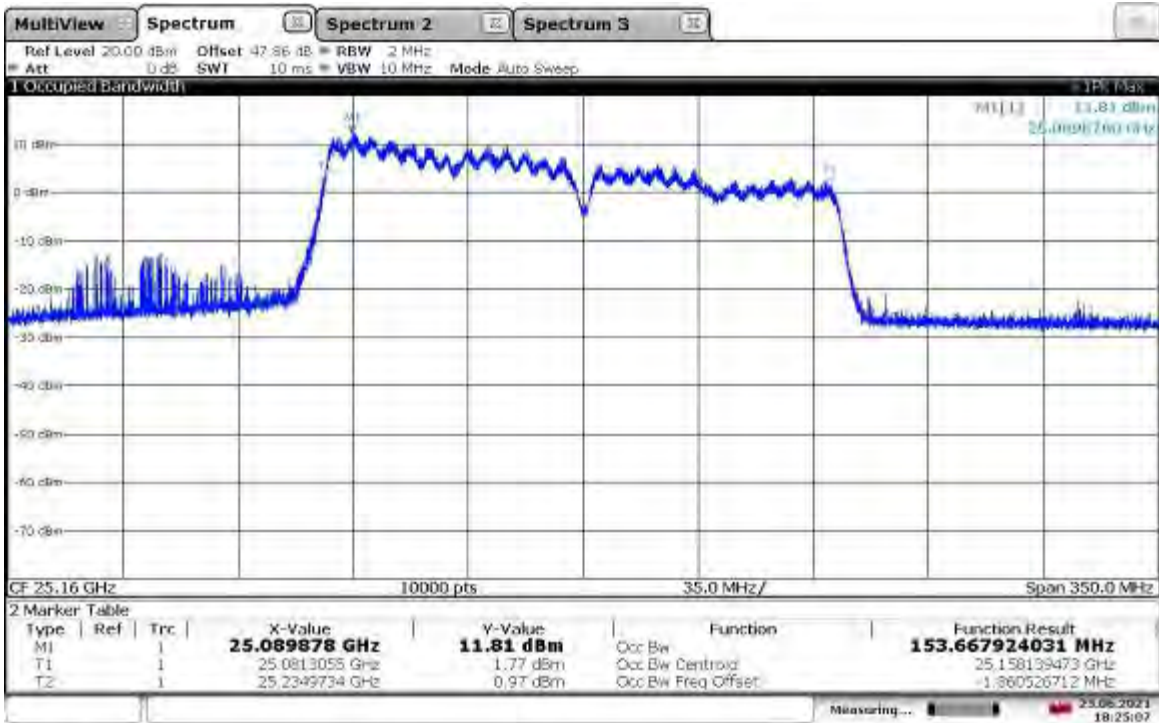

18:25:07 23.06.2021

Intertek

Report Number: 104723800BOX-001

Issued: 10/29/2021
Revised: 11/08/2021
11/10/2021

Test Personnel: Vathana Ven *VSV*
Supervising/Reviewing
Engineer:
(Where Applicable) N/A

Test Date: 06/23/2021, 06/24/2021

Product Standard: FCC 47CFR Part 30 Subparts C
Input Voltage: 48 VDC Via External P/S

Limit Applied: See Report Section 9.3

Pretest Verification w/
BB Source: Yes

Ambient Temperature: 27, 24 °C

Relative Humidity: 31, 38 %

Atmospheric Pressure: 1008, 1004 mbars

Deviations, Additions, or Exclusions: None

Intertek

Report Number: 104723800BOX-001

Issued: 10/29/2021

Revised: 11/08/2021

11/10/2021

10 Frequency Stability

10.1 Requirements

FCC §2.1055 Measurements required: Frequency stability

The frequency stability shall be measured with variation of ambient temperature from -30° to $+50^{\circ}$ centigrade. The frequency stability shall be measured with variation of primary supply voltage from 85 to 115 percent of the nominal value.

10.2 Method

Tests are performed in accordance with FCC 47CFR Part 30 Subparts E Section 30.402, FCC 47CFR Part 2.1055, FCC 47CFR Part 2.1041, KDB 842590 D01 Upper Microwave Flexible Use Service v01r02 April 20, 2021 Subclause 4.5, and ANSI C63.26-2015 Subclause 5.6.

TEST SITE: Safety Lab

10.3 Test Equipment Used:

Asset	Description	Manufacturer	Model	Serial	Cal Date	Cal Due
SAF1153'	Freezing Rain\Icing\Temp\Humidity\ -73deg C to +190deg C, 95% humidity, Ice Freezing Rain	Cincinnati Sub-Zero	CTH-(FR)64-6-6-SC/AC	12-CT15628	11/18/2020	11/18/2021
EMC04'	ANTENNA, RIDGED GUIDE, 18-40 GHZ	EMCO	3116	2090	01/28/2021	01/28/2022
ROS005-1'	Signal and Spectrum Analyzer	Rohde and Shwartz	FSW43	100646	10/27/2020	10/27/2021
SAF1312'	Multi-Meter	Fluke	87V	30840221	12/04/2020	12/04/2021
CBLHF2012-5M-2'	5m 9kHz-40GHz Coaxial Cable - SET2	Huber & Suhner	SF102	252676002	02/19/2021	02/19/2022

Software Utilized:

Name	Manufacturer	Version
EMI Boxborough.xls	Intertek	08/27/2010

10.4 Results:

The sample tested was found to Comply.

Frequency tolerance is not specified in FCC 47 CFR Part 30 Subpart C. Measurement was performed for reporting purpose. Limit in the data table is from FCC Part 30 Subpart E §30.402

Report Number: 104723800BOX-001	Issued: 10/29/2021 Revised: 11/08/2021 11/10/2021
---------------------------------	---

10.5 Setup Photographs:

Confidential – Photo not included in this report

10.6 Test Data:

24.34 GHz Frequency Stability																																																																					
Company: Starry					Test Equipment Used:																																																																
Model #: Comet 24					SAF1153 EMC04		SAF784																																																														
Serial #: 2123000009					ROS005-1 SAF1312		DAV005																																																														
Engineer(s): Vathana Ven			Date(s): 07/16/21		Location: Safety		CELHF2012-SM-2		21 deg C 59% 1005 mB																																																												
Project #: G104723800					Standard: FCC Part 30.402																																																																
Limit: 10 PPM					0.001%																																																																
Nominal f: 24340 MHz					Voltage: 54 VDC																																																																
<table border="1"> <thead> <tr> <th>%</th> <th>Voltage Volts</th> <th>Frequency MHz</th> <th>Deviation kHz</th> <th>Limit kHz</th> </tr> </thead> <tbody> <tr> <td>-15%</td> <td>45.9</td> <td>24339.992857000</td> <td>-0.143</td> <td>243.40</td> </tr> <tr> <td>+0%</td> <td>54</td> <td>24339.993000000</td> <td>0</td> <td>243.40</td> </tr> <tr> <td>+15%</td> <td>62.1</td> <td>24339.992507000</td> <td>-0.493</td> <td>243.40</td> </tr> </tbody> </table>					%	Voltage Volts	Frequency MHz	Deviation kHz	Limit kHz	-15%	45.9	24339.992857000	-0.143	243.40	+0%	54	24339.993000000	0	243.40	+15%	62.1	24339.992507000	-0.493	243.40	<table border="1"> <thead> <tr> <th>Temp Celsius</th> <th>Frequency MHz</th> <th>Deviation kHz</th> <th>Limit kHz</th> </tr> </thead> <tbody> <tr> <td>-30</td> <td>24339.992607000</td> <td>-0.393</td> <td>243.40</td> </tr> <tr> <td>-20</td> <td>24339.992607000</td> <td>-0.393</td> <td>243.40</td> </tr> <tr> <td>-10</td> <td>24340.001748000</td> <td>8.748</td> <td>243.40</td> </tr> <tr> <td>0</td> <td>24340.001449000</td> <td>8.449</td> <td>243.40</td> </tr> <tr> <td>10</td> <td>24339.999290000</td> <td>6.29</td> <td>243.40</td> </tr> <tr> <td>20</td> <td>24339.993000000</td> <td>0</td> <td>243.40</td> </tr> <tr> <td>30</td> <td>24339.992654000</td> <td>-0.346</td> <td>243.40</td> </tr> <tr> <td>40</td> <td>24339.993204000</td> <td>0.204</td> <td>243.40</td> </tr> <tr> <td>50</td> <td>24339.993503000</td> <td>0.503</td> <td>243.40</td> </tr> </tbody> </table>					Temp Celsius	Frequency MHz	Deviation kHz	Limit kHz	-30	24339.992607000	-0.393	243.40	-20	24339.992607000	-0.393	243.40	-10	24340.001748000	8.748	243.40	0	24340.001449000	8.449	243.40	10	24339.999290000	6.29	243.40	20	24339.993000000	0	243.40	30	24339.992654000	-0.346	243.40	40	24339.993204000	0.204	243.40	50	24339.993503000	0.503	243.40
%	Voltage Volts	Frequency MHz	Deviation kHz	Limit kHz																																																																	
-15%	45.9	24339.992857000	-0.143	243.40																																																																	
+0%	54	24339.993000000	0	243.40																																																																	
+15%	62.1	24339.992507000	-0.493	243.40																																																																	
Temp Celsius	Frequency MHz	Deviation kHz	Limit kHz																																																																		
-30	24339.992607000	-0.393	243.40																																																																		
-20	24339.992607000	-0.393	243.40																																																																		
-10	24340.001748000	8.748	243.40																																																																		
0	24340.001449000	8.449	243.40																																																																		
10	24339.999290000	6.29	243.40																																																																		
20	24339.993000000	0	243.40																																																																		
30	24339.992654000	-0.346	243.40																																																																		
40	24339.993204000	0.204	243.40																																																																		
50	24339.993503000	0.503	243.40																																																																		

24.35 GHz Frequency Stability																																																																					
Company: Starry					Test Equipment Used:																																																																
Model #: Comet 24					SAF1153 EMC04		SAF784																																																														
Serial #: 2123000009					ROS005-1 SAF1312		DAV005																																																														
Engineer(s): Vathana Ven			Date(s): 07/16/21		Location: Safety		CELHF2012-SM-2		21 deg C 59% 1005 mB																																																												
Project #: G104723800					Standard: FCC Part 30.402																																																																
Limit: 10 PPM					0.001%																																																																
Nominal f: 24350 MHz					Voltage: 54 VDC																																																																
<table border="1"> <thead> <tr> <th>%</th> <th>Voltage Volts</th> <th>Frequency MHz</th> <th>Deviation kHz</th> <th>Limit kHz</th> </tr> </thead> <tbody> <tr> <td>-15%</td> <td>45.9</td> <td>24349.993357000</td> <td>-6.0036</td> <td>243.50</td> </tr> <tr> <td>+0%</td> <td>54</td> <td>24349.999360600</td> <td>0</td> <td>243.50</td> </tr> <tr> <td>+15%</td> <td>62.1</td> <td>24350.001199000</td> <td>1.8384</td> <td>243.50</td> </tr> </tbody> </table>					%	Voltage Volts	Frequency MHz	Deviation kHz	Limit kHz	-15%	45.9	24349.993357000	-6.0036	243.50	+0%	54	24349.999360600	0	243.50	+15%	62.1	24350.001199000	1.8384	243.50	<table border="1"> <thead> <tr> <th>Temp Celsius</th> <th>Frequency MHz</th> <th>Deviation kHz</th> <th>Limit kHz</th> </tr> </thead> <tbody> <tr> <td>-30</td> <td>24349.993257000</td> <td>-6.1036</td> <td>243.50</td> </tr> <tr> <td>-20</td> <td>24349.992657000</td> <td>-6.7036</td> <td>243.50</td> </tr> <tr> <td>-10</td> <td>24349.992957000</td> <td>-6.4036</td> <td>243.50</td> </tr> <tr> <td>0</td> <td>24349.992657000</td> <td>-6.7036</td> <td>243.50</td> </tr> <tr> <td>10</td> <td>24350.001700000</td> <td>2.3394</td> <td>243.50</td> </tr> <tr> <td>20</td> <td>24349.999360600</td> <td>0</td> <td>243.50</td> </tr> <tr> <td>30</td> <td>24350.000749000</td> <td>1.3884</td> <td>243.50</td> </tr> <tr> <td>40</td> <td>24349.993057000</td> <td>-6.3036</td> <td>243.50</td> </tr> <tr> <td>50</td> <td>24349.993706000</td> <td>-5.6546</td> <td>243.50</td> </tr> </tbody> </table>					Temp Celsius	Frequency MHz	Deviation kHz	Limit kHz	-30	24349.993257000	-6.1036	243.50	-20	24349.992657000	-6.7036	243.50	-10	24349.992957000	-6.4036	243.50	0	24349.992657000	-6.7036	243.50	10	24350.001700000	2.3394	243.50	20	24349.999360600	0	243.50	30	24350.000749000	1.3884	243.50	40	24349.993057000	-6.3036	243.50	50	24349.993706000	-5.6546	243.50
%	Voltage Volts	Frequency MHz	Deviation kHz	Limit kHz																																																																	
-15%	45.9	24349.993357000	-6.0036	243.50																																																																	
+0%	54	24349.999360600	0	243.50																																																																	
+15%	62.1	24350.001199000	1.8384	243.50																																																																	
Temp Celsius	Frequency MHz	Deviation kHz	Limit kHz																																																																		
-30	24349.993257000	-6.1036	243.50																																																																		
-20	24349.992657000	-6.7036	243.50																																																																		
-10	24349.992957000	-6.4036	243.50																																																																		
0	24349.992657000	-6.7036	243.50																																																																		
10	24350.001700000	2.3394	243.50																																																																		
20	24349.999360600	0	243.50																																																																		
30	24350.000749000	1.3884	243.50																																																																		
40	24349.993057000	-6.3036	243.50																																																																		
50	24349.993706000	-5.6546	243.50																																																																		

Intertek

Report Number: 104723800BOX-001

Issued: 10/29/2021
Revised: 11/08/2021
11/10/2021

24.36 GHz Frequency Stability

Company: Starry					Test Equipment Used:				
Model #: Comet 24					SAF1153	EMC04	SAF784		
Serial #: 2123000009					ROS005-1	SAF1312	DAV005		
Engineer(s): Vathana Ven			Date(s): 07/16/21		Location: Safety		CELFHF2012-5M-2	21 deg C	59% 1005 mB
Project #: G104723800									
Standard: FCC Part 30.402									
Limit:		10 PPM		0.001%					
Nominal f:		24360 MHz		Voltage:		54 VDC			

%	Voltage Volts	Frequency MHz	Deviation kHz	Limit kHz	Temp Celsius	Frequency MHz	Deviation kHz	Limit kHz
-15%	45.9	24359.993357000	-5.9687	243.60	-30	24359.992957000	-6.369	243.60
+0%	54	24359.999325700	0	243.60	-20	24359.992458000	-6.868	243.60
+15%	62.1	24360.001299000	1.9733	243.60	-10	24359.992358000	-6.968	243.60
					0	24359.992807000	-6.519	243.60
					10	24359.993000000	-6.326	243.60
					20	24359.999325700	0.000	243.60
					30	24360.001499000	2.173	243.60
					40	24359.992757000	-6.569	243.60
					50	24360.001698000	2.372	243.60

24.84 GHz Frequency Stability

Company: Starry					Test Equipment Used:				
Model #: Comet 24					SAF1153	EMC04	SAF784		
Serial #: 2123000009					ROS005-1	SAF1312	DAV005		
Engineer(s): Vathana Ven			Date(s): 07/16/21		Location: Safety		CELFHF2012-5M-2	21 deg C	59% 1005 mB
Project #: G104723800									
Standard: FCC Part 30.402									
Limit:		10 PPM		0.001%					
Nominal f:		24840 MHz		Voltage:		54 VDC			

%	Voltage Volts	Frequency MHz	Deviation kHz	Limit kHz	Temp Celsius	Frequency MHz	Deviation kHz	Limit kHz
-15%	45.9	24840.001748000	0.1	248.40	-30	24839.992707000	-8.941	248.40
+0%	54	24840.001648000	0	248.40	-20	24840.001698000	0.05	248.40
+15%	62.1	24839.993007000	-8.641	248.40	-10	24840.002148000	0.5	248.40
					0	24839.992310000	-9.338	248.40
					10	24839.993200000	-8.448	248.40
					20	24840.001648000	0	248.40
					30	24839.992657000	-8.991	248.40
					40	24839.993357000	-8.291	248.40
					50	24840.001848000	0.2	248.40

Intertek

Report Number: 104723800BOX-001

Issued: 10/29/2021
Revised: 11/08/2021
11/10/2021

25.04 GHz Frequency Stability

Company: Starry					Test Equipment Used:				
Model #: Comet 24					SAF1153	EMC04	SAF784		
Serial #: 2123000009					ROS005-1	SAF1312	DAV005		
Engineer(s): Vathana Ven			Location: Safety		CBLHF2012-5M-2	21 deg C		59% 1005 mB	
Project #: G104723800			Date(s): 07/16/21						
Standard: FCC Part 30.402									
Limit: 10 PPM					0.001%				
Nominal f: 25040 MHz					Voltage: 54 VDC				
	%	Voltage Volts	Frequency MHz	Deviation kHz	Limit kHz	Temp Celsius	Frequency MHz	Deviation kHz	Limit kHz
	-15%	45.9	25040.000949000	0.8391	250.40	-30	25039.992458000	-7.6519	250.40
	+0%	54	25040.000109900	0	250.40	-20	25039.992308000	-7.8019	250.40
	+15%	62.1	25039.991708000	-8.4019	250.40	-10	25040.001598000	1.4881	250.40
						0	25039.992557000	-7.5529	250.40
						10	25039.993400000	-6.7099	250.40
						20	25040.000109900	0	250.40
						30	25039.993556000	-6.5539	250.40
						40	25039.999270700	-0.8392	250.40
						50	25039.993706000	-6.4039	250.40

25.16 GHz Frequency Stability

Company: Starry					Test Equipment Used:				
Model #: Comet 24					SAF1153	EMC04	SAF784		
Serial #: 2123000009					ROS005-1	SAF1312	DAV005		
Engineer(s): Vathana Ven			Location: Safety		CBLHF2012-5M-2	21 deg C		59% 1005 mB	
Project #: G104723800			Date(s): 07/16/21						
Standard: FCC Part 30.402									
Limit: 10 PPM					0.001%				
Nominal f: 25160 MHz					Voltage: 54 VDC				
	%	Voltage Volts	Frequency MHz	Deviation kHz	Limit kHz	Temp Celsius	Frequency MHz	Deviation kHz	Limit kHz
	-15%	45.9	25159.999270700	6.7137	251.60	-30	25160.000649000	8.092	251.60
	+0%	54	25159.992557000	0	251.60	-20	25160.001648000	9.091	251.60
	+15%	62.1	25159.992458000	-0.099	251.60	-10	25159.992408000	-0.149	251.60
						0	25159.993357000	0.8	251.60
						10	25159.993400000	0.843	251.60
						20	25159.992557000	0	251.60
						30	25159.993457000	0.9	251.60
						40	25160.001449000	8.892	251.60
						50	25159.993357000	0.8	251.60

Test Personnel: Vathana Ven *VSV*
 Supervising/Reviewing Engineer: _____
 (Where Applicable) N/A
 Product Standard: FCC 47CFR Part 30 Subpart C
 Input Voltage: 48VDC Via External P/S
 Pretest Verification w/ Signal generator: N/A

Test Date: 07/16/2021
 Limit Applied: See Report Section 10.3
 Ambient Temperature: 21 deg C
 Relative Humidity: 59 %
 Atmospheric Pressure: 1005 mB

Deviations, Additions, or Exclusions: None

Report Number: 104723800BOX-001	Issued: 10/29/2021 Revised: 11/08/2021 11/10/2021
---------------------------------	---

11 AC Main Conducted Emissions

11.1 Method

Tests are performed in accordance with FCC Part 15 Subpart B and ANSI C63.4.

TEST SITE: EMC Lab

The EMC Lab has one Semi-anechoic Chamber and one Shielded Chamber. AC Mains Power is available at 120, 230, and 277 Single Phase; 208, 400, and 480 3-Phase. Large reference ground-planes are installed in the general lab area to facilitate EMC work not requiring a shielded environment.

Measurement Uncertainty

Measurement	Frequency Range	Expanded Uncertainty (k=2)	Ucispr
AC Line Conducted Emissions	150 kHz - 30 MHz	1.2 dB	3.4dB
Telco Port Emissions	150 kHz - 30 MHz	2.8 dB	5.0dB
AC Line Conducted Emissions	9 kHz - 150 MHz	2.2 dB	3.4 dB

As shown in the table above our conducted emissions U_{lab} is less than the corresponding U_{CISPR} reference value in CISPR 16-4-2 Table 1, hence the compliance of the product is only based on the measured value, and no measurement uncertainty correction is required, based on CISPR 22 and CISPR 11 (for 2006 and later revisions) Clause 11.

Sample Calculations

The following is how net line-conducted readings were determined:

$$NF = RF + LF + CF + AF$$

- Where NF = Net Reading in dB μ V
- RF = Reading from receiver in dB μ V
- LF = LISN or ISN Correction Factor in dB
- CF = Cable Correction Factor in dB
- AF = Attenuator Loss Factor in dB

To convert from dB μ V to μ V or mV the following was used:

$$UF = 10^{(NF / 20)} \text{ where UF = Net Reading in } \mu\text{V}$$

$$NF = \text{Net Reading in dB}\mu\text{V}$$

Example:

$$NF = RF + LF + CF + AF = 28.5 + 0.2 + 0.4 + 20.0 = 49.1 \text{ dB}\mu\text{V}$$

$$UF = 10^{(49.1 \text{ dB}\mu\text{V} / 20)} = 285.1 \mu\text{V/m}$$

When BAT-EMC Emission Software is used, the "Level" includes all losses and gains and is compared directly in the "Margin" column to the "Limit". The "Correction" includes LISN Factor, Attenuator, and Cable Loss. These are already accounted for in the "Level" column.

Intertek

Report Number: 104723800BOX-001

Issued: 10/29/2021

Revised: 11/08/2021

11/10/2021

11.2 Test Equipment Used:

Asset	Description	Manufacturer	Model	Serial	Cal Date	Cal Due
ROS002'	9kHz to 3GHz EMI Test Receiver	Rohde & Schwartz	ESCI 1166.5950K03	100067	06/22/2020	06/22/2021
DS23'	Attenuator, 20dB	Mini Circuits	20dB, 50 ohm	DS23	10/30/2020	10/30/2021
CBL042'	3ft BNC to BNC cable	Hosiwell	Coax RG-58	CBL042	06/08/2021	06/08/2022
147275'	Signal Generator	Rohde & Schwarz	SML01	100931	07/20/2020	07/20/2021
147239'	Digital Multimeter (Full Color)	Fluke	187	89300561	02/06/2021	02/06/2022
DAV005'	Weather Station	Davis	6250	MS191218083	02/07/2021	02/07/2022
LISN32'	LISN - CISPR16 Compliant 9kHz-30MHz	Com-Power	LI-215A	191955	05/11/2021	05/11/2022

Software Utilized:

Name	Manufacturer	Version
BAT-EMC	Nexio	3.20.0.21

11.3 Results:

The sample tested was found to Comply.

Report Number: 104723800BOX-001	Issued: 10/29/2021 Revised: 11/08/2021 11/10/2021
---------------------------------	---

11.4 Setup Photographs:

Confidential – Photo not included in this report

11.5 Plots/Data:

Test Information:

Date and Time	7/16/2021 10:37:15 PM
Client and Project Number	Starry_G104723800_G104749253
Engineer	Vathana Ven
Temperature	21 deg C
Humidity	59%
Atmospheric Pressure	1005mbars
Comments	150kHz to 30 MHz_120VAC 60Hz

Graph:

- Conducted Emissions Limit Lines/FCC Part 15 Subpart B CE Main Ports B - Average/
- Conducted Emissions Limit Lines/FCC Part 15 Subpart B CE Main Ports B - QPeak/
- x Peak (Manual finals) (RF Output Measure)
- Peak (RF Output Measure)
- AVG Level (Average(Pass)) (RF Output Measure)
- QP Level (QuasiPeak(Pass)) (RF Output Measure)

Sub-range 1
Frequencies: 150 kHz - 30 MHz (Mode: Lin - Step: 4.5 kHz)
Settings: RBW: 9kHz, VBW: Auto, Sweep time: 5 ms/Pts, Attenuation: Auto, Sweep count 1, Preamp: Off, LN Preamp: Off, Preselector: On
Line: RF Output Measure

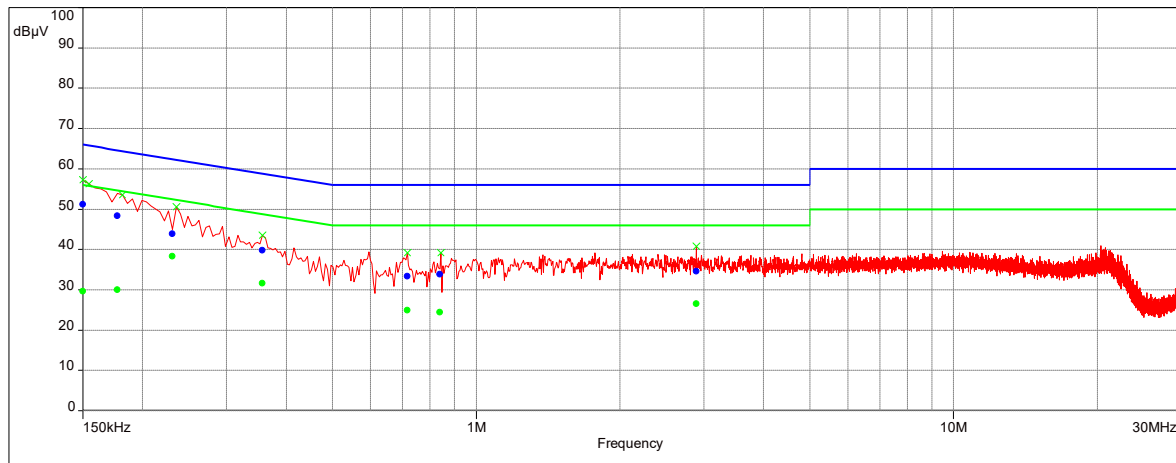

test name 150kHz to 30 MHz_120VAC 60Hz Time ate 16/7/2021 22:46

Results:

QuasiPeak(Pass) (7)

Frequency (MHz)	SR	QP Level (dBµV)	QP Limit (dBµV)	QP Margin (dB)	Line	RBW	Meas.Time	Correction (dB)
0.1515	1	51.19	66.00	-14.81	Neutral	9k	0.01	20.28
0.1785	1	48.33	64.63	-16.29	Phase 1	9k	0.01	20.19
0.232	1	43.90	62.41	-18.51	Phase 1	9k	0.01	20.18
0.3565	1	39.84	58.80	-18.96	Neutral	9k	0.01	20.21
0.7165	1	33.37	56.00	-22.63	Neutral	9k	0.01	20.20
0.838	1	33.88	56.00	-22.12	Neutral	9k	0.01	20.21
2.8885	1	34.56	56.00	-21.44	Neutral	9k	0.01	20.30

Average(Pass) (7)

Frequency (MHz)	SR	AVG Level (dBµV)	AVG Limit (dBµV)	AVG Margin (dB)	Line	RBW	Meas.Time	Correction (dB)
0.1515	1	29.57	56.00	-26.43	Neutral	9k	0.01	20.28
0.1785	1	29.96	54.63	-24.67	Phase 1	9k	0.01	20.19
0.232	1	38.30	52.41	-14.12	Phase 1	9k	0.01	20.18
0.3565	1	31.59	48.80	-17.21	Neutral	9k	0.01	20.21
0.7165	1	24.89	46.00	-21.11	Neutral	9k	0.01	20.20
0.838	1	24.36	46.00	-21.64	Neutral	9k	0.01	20.21

Intertek

Report Number: 104723800BOX-001	Issued: 10/29/2021 Revised: 11/08/2021 11/10/2021
---------------------------------	---

2.8885	1	26.52	46.00	-19.48	Neutral	9k	0.01	20.30
--------	---	-------	-------	--------	---------	----	------	-------

Test Personnel: Vathana F. Ven *VFK*
Supervising/Reviewing
Engineer:
(Where Applicable) N/A
Product Standard: FCC Part 15 Subpart B
Input Voltage: 120VAC 60Hz
Pretest Verification w/
Signal generator: Yes

Test Date: 07/16/2021
Limit Applied: Class B
Ambient Temperature: 21 °C
Relative Humidity: 59 %
Atmospheric Pressure: 1005 mbars

Deviations, Additions, or Exclusions: None

Intertek

Report Number: 104723800BOX-001	Issued: 10/29/2021 Revised: 11/08/2021 11/10/2021
---------------------------------	---

12 Revision History

Revision Level	Date	Report Number	Prepared By	Reviewed By	Notes
0	10/29/2021	104723800BOX-001	VFV <i>VFV</i>	KPS <i>KPS</i>	Original Issue
1	11/08/2021	104723800BOX-001	VFV <i>VFV</i>	KPS <i>KPS</i>	Removed test setup photos
2	11/11/2021	104723800BOX-001	VFV <i>VFV</i>	KPS <i>KPS</i>	Fixed model # and product description on page 5. Fixed modulation type and antenna description on page 6

13 Appendix – Mixer Conversion Loss

40-60 GHz Mixer Conversion Loss

Report Number: 104723800BOX-001	Issued: 10/29/2021 Revised: 11/08/2021 11/10/2021
---------------------------------	---

WR19.0SAX-F

1 Product Overview

Product List (Quantity)	Serial Number(s)	Order No.	Date / Initials
WR19.0SAX-F (1)	SAX 835	21108A	03/26/2021 SAB

Product Description: This VDI product includes one WR19.0 Frequency Extender, intended for use with Rohde & Schwarz FSW spectrum analyzers. This user guide details the operation of the Frequency Extension Module.

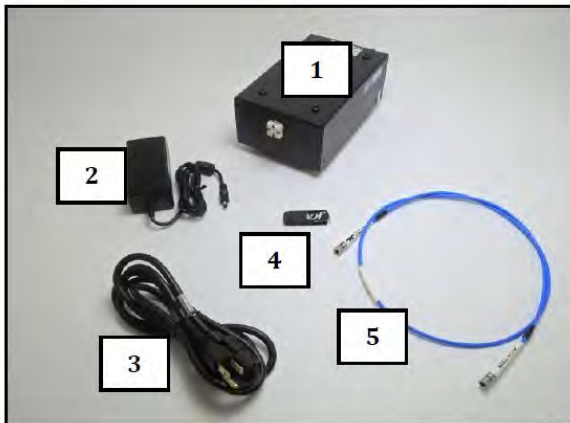

No.	Part Description
1	SAX 835
2	9V Power Supply
3	AC Power Cable
4	USB Drive
5	LO Cable (not included)

Figure 1: Photograph of typical configuration. All items may not be included.
Note: Photographs and specifications of accessories (horns, waveguide straights, etc.) are not included in this user guide.

2 Warning and Caution Statements

WARNING AND CAUTION STATEMENTS	
WARNING	This product can be permanently damaged by Electrostatic Discharge (ESD). It is recommended that engineers and technicians wear a special grounded wrist strap when handling this component. In addition, the work environment around the component should be well grounded.
WARNING	Opening the blocks, parts, or components will damage the internal components. VDI is not responsible for the warranty or guaranty of products damaged as a result of improper handling, testing, biasing, or use by customer.
CAUTION	VDI assumes the customer is familiar with microwave, millimeter wave, and VDI products. The user and customer are expected to understand all safety guidelines, health hazards, and general advisories that may exist and are associated with the use of this device. VDI is not responsible for any human hazards that may exist or may occur while using this device.

3 Product Specifications



USER GUIDE

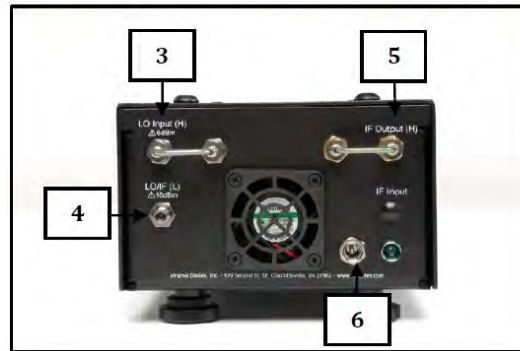
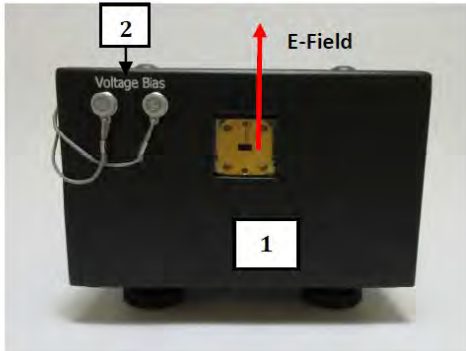

Description		Specification	Connector
RF Input [1]	Frequency Range	40-60GHz	WR19.0
	Power (Optimal / Damage)	<-20dBm / -10dBm	UG-599/UM
Voltage Bias Port [2]	External Component Bias Voltage	+9V Output 50mA Maximum	LEMO 00 (f)
LO Input High Freq. [3]	Frequency Range	20-30GHz	2.9mm(f)
	Power (Typical† / Damage)	0dBm / 16dBm	
	Multiplication Factor	2	
LO Input Standard Freq. [4]*	Frequency Range	10-15GHz	2.9mm(f)
	Power (Typical† / Damage)	13dBm / 20dBm	
	Multiplication Factor	4	
IF Output Standard Freq. [4]*	Frequency Range	100MHz-2.5GHz	2.9mm(f)
IF Output High Freq. [5]	Frequency Range	100MHz-6GHz	2.9mm(f)
DC Input [6]	DC Power Connection	9V Output, 5A Maximum	2.1mm I.D. x 5.5mm O.D. x 9.5mm Male
Intrinsic Mixer**	SSB Conversion Loss***	9dB	-
Displayed Average Noise Level***		-152dBm/Hz	-

Table 1: General product specifications are shown.
 † System is operational within +/- 3dB of nominal input power.
 *Standard Freq. LO and IF share the same port.
 **Intrinsic mixer conversion loss is measured before any IF amplification and cannot be accessed by user.
 ***See Section 5 for actual performance.



USER GUIDE

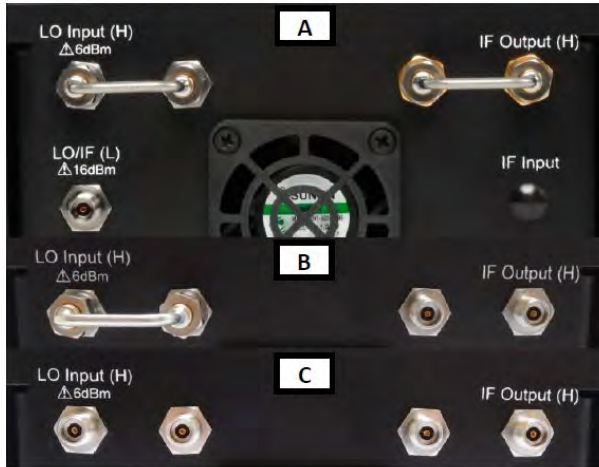

Configuration	LO Frequency	IF Frequency
A	Standard	Standard
B	Standard	High
C	High	High

Figure 2: Configuration details of dual LO input and dual IF output frequency modes are shown.

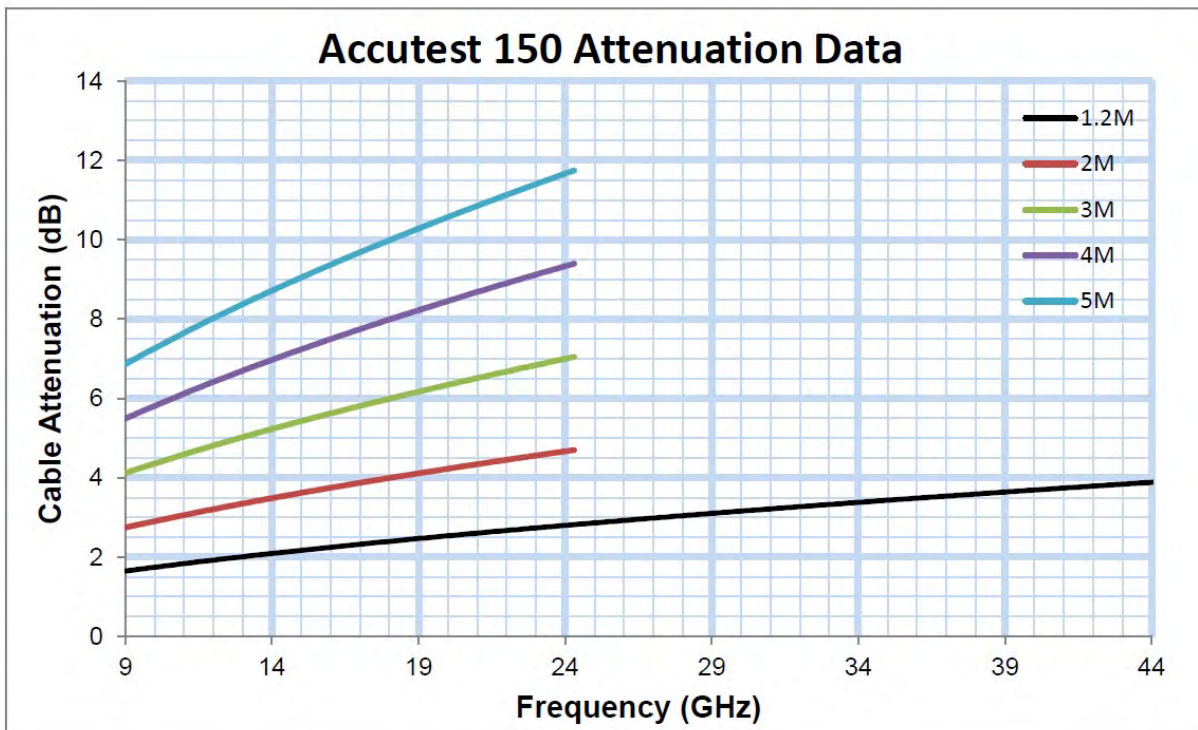

Figure 3: Insertion Loss of Accutest 150 (RF/LO Cable) with respect to frequency.



USER GUIDE

4 General Operating Procedures and Guidelines

VDI assumes the customer is familiar with VDI products, and VDI is not responsible for the warranty or guaranty of products damaged as a result of improper handling, testing, biasing, or use by customer. VDI offers the following general guidelines for using these products and recommends the customer contact VDI at (434) 297-3257 for assistance if needed. The following procedures are a quick guide for turning on and off the product. In each case the individual steps must be followed in the proper sequence to avoid damaging critical components.

4.1 Required Operating Procedures

- DO NOT exceed damage limits listed in Table 1.
- DO NOT apply any external biases to the system.
- Make proper RF connections depending on desired configuration (i.e. Standard/High LO and Standard/High IF operation). Refer to Figure 2A-C for more information.

Failure to follow these procedures will damage or destroy the device.

4.2 Additional Guidelines, Limitations, and Recommendations

- The SAX is shipped with a reusable dust cover attached. Remove dust cover before operation.

4.3 Turn-On Procedure

1. The user and test bench must be properly grounded and protected against ESD.
2. With the LO and RF input power turned off, make all necessary connections (i.e. LO cable, AC cable, DC cable). See Figure 2A-C for configuration details.
3. Turn on the LO input power.
4. Turn on the small signal RF input power and monitor the IF output.

4.4 Turn-Off Procedure

1. The user and test bench must be properly grounded and protected against ESD.
2. Turn off the RF input power.
3. Turn off the LO input power.
4. Disconnect the DC Power Supply.
5. After completing turn-off procedures described above, it is now safe to turn off all other equipment on user test bench.

Contact VDI with questions or concerns regarding operational procedures and limitations.



USER GUIDE

5 Product Performance

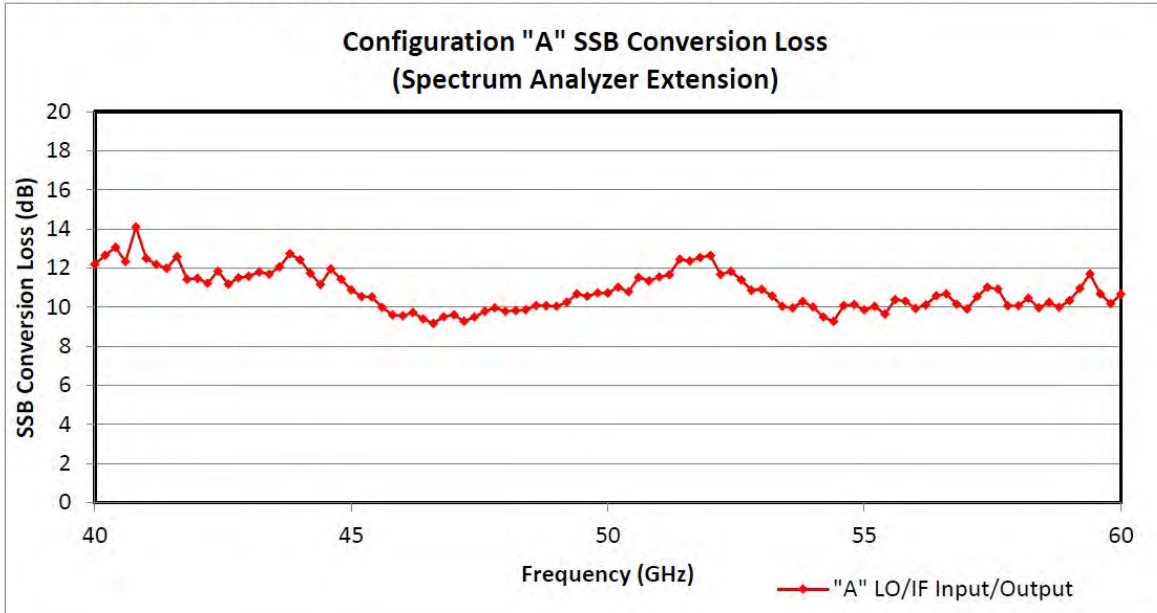

Figure 4: The product performance (SSB conversion loss vs. RF frequency) is shown for an LO input power of ~15dBm in Standard LO Frequency operation. IF power measured from "LO/IF" port with IF frequency fixed at 1.3GHz. CSV Data file included on USB Drive.

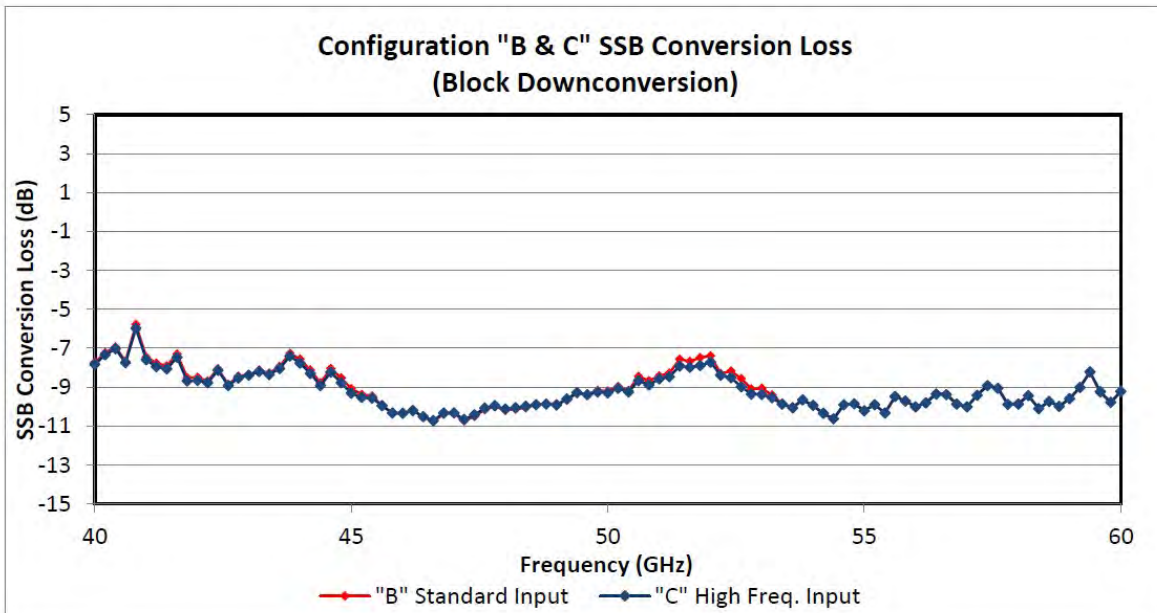

Figure 5: The product performance (SSB conversion loss vs. RF frequency) is shown for an LO input power of ~15dBm in Standard LO Frequency operation and LO input power of ~0dBm in High LO Frequency operation. IF power measured from "IF Output" port with IF frequency fixed at 1.3GHz. CSV Data file included on USB Drive.



USER GUIDE

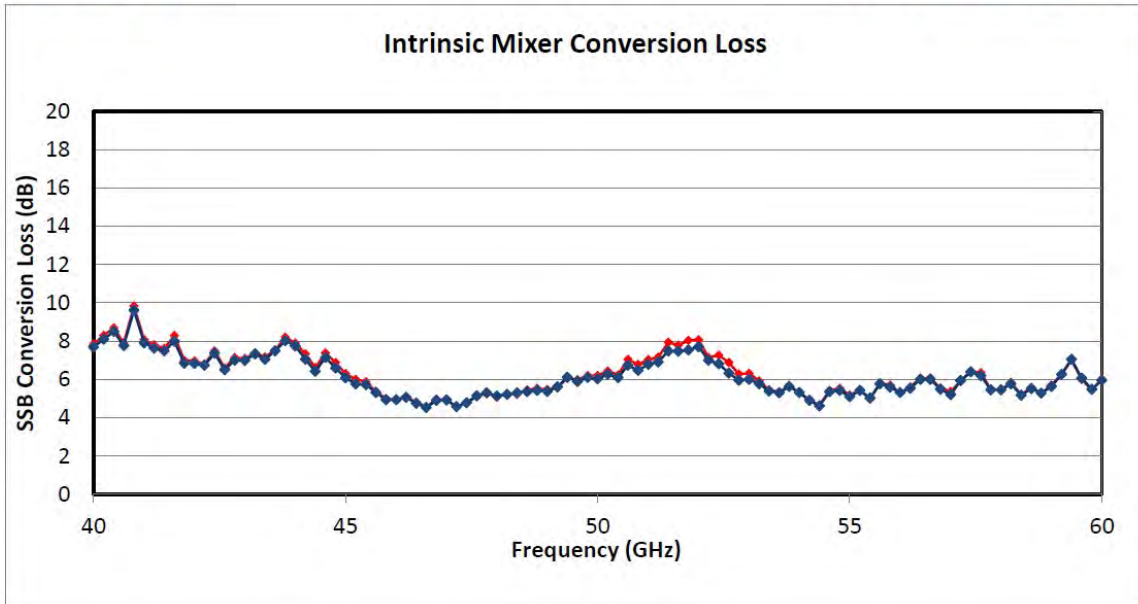

Figure 6: The product performance (SSB conversion loss vs. RF frequency) is shown for an LO input power of ~15dBm in Standard LO Frequency operation and LO input power of ~0dBm in High LO Frequency operation. IF power measured from mixer port with IF frequency fixed at 1.3GHz. Note: mixer port is not accessible for use by the user. CSV Data file included on USB Drive.

Measured Displayed Average Noise Level (dBm/Hz)	
Typical	-152.62

*Measured with a Keysight N9030A PXA Spectrum Analyzer.

Intertek

Report Number: 104723800BOX-001

Issued: 10/29/2021

Revised: 11/08/2021

11/10/2021

SAX 835 Conversion Loss

Note: Out of band data is not guaranteed to be accurate.

Freq(GHz)	"A" LO/IF Input/Output	"B" Standard Input	"C" High Freq. Input	High Freq. Intrinsic Mixer Loss	Standard Freq. Intrinsic Mixer Loss
40	12.18393	-7.73106531	-7.83106531	7.69093469	7.83793469
40.2	12.65257	-7.227428425	-7.346428425	8.089571575	8.295571575
40.4	13.04476	-6.935240346	-7.031240346	8.506759654	8.681759654
40.6	12.31643	-7.671565301	-7.756565301	7.763434699	7.913434699
40.8	14.09561	-5.784389207	-5.976389207	9.605610793	9.822610793
41	12.47222	-7.450776143	-7.586776143	7.911223857	8.075223857
41.2	12.17642	-7.766582166	-7.955582166	7.632417834	7.794417834
41.4	11.98468	-7.903316327	-8.068316327	7.491683673	7.628683673
41.6	12.58671	-7.300293808	-7.475293808	7.980706192	8.287706192
41.8	11.42126	-8.517743767	-8.682743767	6.840256233	6.992256233
42	11.46096	-8.504035139	-8.649035139	6.835964861	6.965964861
42.2	11.21847	-8.684527279	-8.781527279	6.735472721	6.799472721
42.4	11.83738	-8.055620485	-8.146620485	7.366379515	7.484379515
42.6	11.17569	-8.856309768	-8.917309768	6.502690232	6.599690232
42.8	11.49528	-8.435723496	-8.534723496	6.994276504	7.141276504
43	11.56904	-8.375963687	-8.395963687	6.987036313	7.103036313
43.2	11.79484	-8.120156119	-8.196156119	7.335843881	7.372843881
43.4	11.67951	-8.279490341	-8.364490341	7.050509659	7.176509659
43.6	12.05336	-7.943637944	-8.048637944	7.490362056	7.536362056
43.8	12.72018	-7.259817722	-7.400817722	8.024182278	8.205182278
44	12.40928	-7.555723107	-7.764723107	7.756276893	7.900276893
44.2	11.72591	-8.119091237	-8.296091237	7.052908763	7.335908763
44.4	11.15254	-8.774458098	-8.927458098	6.418541902	6.611541902
44.6	11.94911	-8.046893419	-8.235893419	7.146106581	7.381106581
44.8	11.41168	-8.535320915	-8.779320915	6.593679085	6.880679085
45	10.86545	-9.074546037	-9.315546037	6.077453963	6.296453963
45.2	10.52373	-9.371265586	-9.527265586	5.767734414	6.004734414
45.4	10.51426	-9.446741028	-9.563741028	5.714258972	5.882258972
45.6	9.986746	-9.939254477	-9.954254477	5.306745523	5.378745523
45.8	9.59202	-10.34998045	-10.33198045	4.939019546	4.994019546
46	9.54945	-10.34955021	-10.34255021	4.945449791	4.942449791
46.2	9.718601	-10.20139894	-10.20139894	5.06660106	5.08660106
46.4	9.4014	-10.51059989	-10.50859989	4.75540011	4.80640011
46.6	9.164813	-10.76618735	-10.72018735	4.525812655	4.559812655
46.8	9.49849	-10.37151002	-10.32451002	4.910489976	4.952489976
47	9.590663	-10.34933683	-10.32533683	4.919663167	4.930663167

Intertek

Report Number: 104723800BOX-001

Issued: 10/29/2021

Revised: 11/08/2021

11/10/2021

47.2	9.264478	-10.73452184	-10.66252184	4.576478163	4.565478163
47.4	9.487929	-10.49307072	-10.42707072	4.788929277	4.774929277
47.6	9.782794	-10.16320569	-10.07820569	5.142794307	5.116794307
47.8	9.95227	-9.987729761	-9.946729761	5.294270239	5.264270239
48	9.779821	-10.1941788	-10.1251788	5.128821195	5.129821195
48.2	9.817198	-10.11880169	-10.06180169	5.213198315	5.238198315
48.4	9.861049	-10.05895142	-9.99095142	5.29204858	5.22604858
48.6	10.07245	-9.889547923	-9.900547923	5.367452077	5.450452077
48.8	10.07077	-9.841233026	-9.876233026	5.424766974	5.527766974
49	10.02539	-9.862610661	-9.921610661	5.379389339	5.465389339
49.2	10.24586	-9.671136617	-9.615136617	5.606863383	5.561863383
49.4	10.6675	-9.289503278	-9.286503278	6.107496722	6.065496722
49.6	10.5412	-9.356800369	-9.393800369	5.891199631	5.991199631
49.8	10.71795	-9.170051536	-9.242051536	6.089948464	6.211948464
50	10.72015	-9.202846251	-9.294846251	6.036153749	6.207153749
50.2	11.01845	-8.967548981	-9.055548981	6.261451019	6.439451019
50.4	10.78694	-9.175059654	-9.246059654	6.097940346	6.231940346
50.6	11.51114	-8.446861426	-8.672861426	6.740138574	7.043138574
50.8	11.34446	-8.666536526	-8.891536526	6.471463474	6.789463474
51	11.54523	-8.420770486	-8.581770486	6.787229514	7.028229514
51.2	11.64424	-8.273764545	-8.461764545	6.912235455	7.159235455
51.4	12.45045	-7.554554578	-7.923554578	7.493445422	7.940445422
51.6	12.34762	-7.672378642	-7.986378642	7.465621358	7.783621358
51.8	12.53203	-7.48396897	-7.88396897	7.53103103	8.03103103
52	12.63471	-7.392294596	-7.710294596	7.710705404	8.068705404
52.2	11.66922	-8.296777367	-8.395777367	6.998222633	7.135222633
52.4	11.82163	-8.176370856	-8.512370856	6.820629144	7.266629144
52.6	11.38115	-8.567850502	-8.981850502	6.324149498	6.876149498
52.8	10.85834	-9.088660283	-9.362660283	5.949339717	6.282339717
53	10.90889	-9.054111321	-9.370111321	6.000888679	6.315888679
53.2	10.55653	-9.398471843	-9.553471843	5.768528157	5.922528157
53.4	10.02485	-9.857147743	-9.879147743	5.394852257	5.452852257
53.6	9.957231	-10.00976887	-10.05476887	5.300231127	5.343231127
53.8	10.28107	-9.656928444	-9.648928444	5.624071556	5.671071556
54	10.00557	-9.945426854	-9.944426854	5.313573147	5.316573147
54.2	9.483862	-10.38213777	-10.35113777	4.90986223	4.92486223
54.4	9.27475	-10.63425049	-10.62325049	4.602749509	4.658749509
54.6	10.07448	-9.899524203	-9.899524203	5.357475797	5.419475797
54.8	10.12309	-9.847914944	-9.861914944	5.428085056	5.530085056
55	9.843976	-10.19002385	-10.21402385	5.092976146	5.194976146
55.2	10.03561	-9.908389973	-9.910389973	5.416610027	5.438610027
55.4	9.643359	-10.31664094	-10.33464094	5.038359057	4.973359057

Intertek

Report Number: 104723800BOX-001

Issued: 10/29/2021

Revised: 11/08/2021

11/10/2021

55.6	10.37222	-9.49677748	-9.48777748	5.76322252	5.79722252
55.8	10.30295	-9.680049143	-9.713049143	5.588950857	5.707950857
56	9.930571	-10.00042911	-10.01842911	5.310570886	5.301570886
56.2	10.10271	-9.786290637	-9.816290637	5.528709363	5.602709363
56.4	10.57445	-9.318550175	-9.357550175	6.002449825	6.064449825
56.6	10.66912	-9.349881086	-9.393881086	6.004118914	6.076118914
56.8	10.14375	-9.840248304	-9.875248304	5.478751696	5.545751696
57	9.894501	-9.992499215	-10.01649921	5.211500785	5.371500785
57.2	10.52904	-9.407962195	-9.419962195	5.934037805	5.908037805
57.4	11.01629	-8.88670661	-8.91570661	6.39329339	6.41629339
57.6	10.9171	-9.033897975	-9.064897975	6.195102025	6.348102025
57.8	10.05695	-9.8670484	-9.8830484	5.4619516	5.4749516
58	10.06586	-9.834143573	-9.880143573	5.457856427	5.450856427
58.2	10.45513	-9.422873675	-9.434873675	5.770126325	5.841126325
58.4	9.959582	-10.09041812	-10.10741812	5.165581881	5.204581881
58.6	10.23535	-9.720652896	-9.738652896	5.511347104	5.584347104
58.8	9.987653	-9.967346763	-9.989346763	5.289653237	5.282653237
59	10.32975	-9.594251231	-9.600251231	5.624748769	5.691748769
59.2	10.94742	-9.004582916	-9.007582916	6.263417084	6.266417084
59.4	11.69635	-8.21964914	-8.21264914	7.04235086	7.01935086
59.6	10.67157	-9.294432287	-9.235432287	6.069567713	6.001567713
59.8	10.16657	-9.771428462	-9.783428462	5.485571538	5.447571538
60	10.64813	-9.237874856	-9.223874856	5.947125144	6.016125144

Intertek

Report Number: 104723800BOX-001

Issued: 10/29/2021

Revised: 11/08/2021

11/10/2021

60-90 GHz Mixer Conversion Loss

Report Number: 104723800BOX-001	Issued: 10/29/2021 Revised: 11/08/2021 11/10/2021
---------------------------------	---



USER GUIDE

WR12.0SAX-F

1 Product Overview

Product List (Quantity)	Serial Number(s)	Order No.	Date / Initials
WR12.0SAX-F (1)	SAX 836	21108B	04/06/2021 CXS

Product Description: This VDI product includes one WR12.0 Frequency Extender, intended for use with Rohde & Schwarz FSW spectrum analyzers. This user guide details the operation of the Frequency Extension Module.

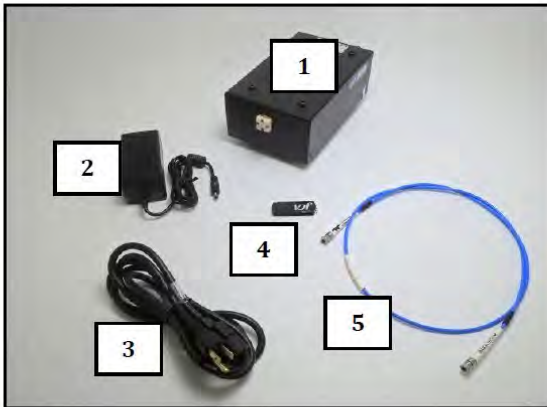

No.	Part Description
1	SAX 836
2	9V Power Supply
3	AC Power Cable
4	USB Drive
5	LO Cable (not included)

Figure 1: Photograph of typical configuration. All items may not be included.
 Note: Photographs and specifications of accessories (horns, waveguide straights, etc.) are not included in this user guide.

2 Warning and Caution Statements

WARNING AND CAUTION STATEMENTS	
WARNING	This product can be permanently damaged by Electrostatic Discharge (ESD). It is recommended that engineers and technicians wear a special grounded wrist strap when handling this component. In addition, the work environment around the component should be well grounded.
WARNING	Opening the blocks, parts, or components will damage the internal components. VDI is not responsible for the warranty or guaranty of products damaged as a result of improper handling, testing, biasing, or use by customer.
CAUTION	VDI assumes the customer is familiar with microwave, millimeter wave, and VDI products. The user and customer are expected to understand all safety guidelines, health hazards, and general advisories that may exist and are associated with the use of this device. VDI is not responsible for any human hazards that may exist or may occur while using this device.

3 Product Specifications



USER GUIDE

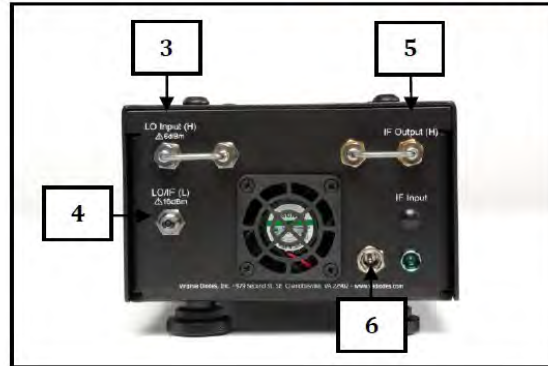
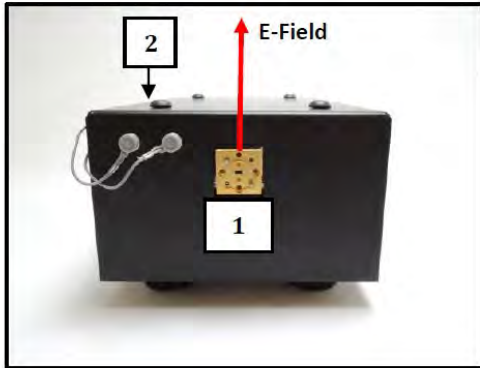

Description		Specification	Connector
RF Input [1]	Frequency Range	60-90GHz	WR12.0
	Power (Optimal / Damage)	<-20dBm / -10dBm	UG-599/UM
Voltage Bias Port [2]	External Component Bias Voltage	+9V Output 50mA Maximum	LEMO 00 (f)
LO Input High Freq. [3]	Frequency Range	10-15GHz	2.9mm(f)
	Power (Typical [†] / Damage)	0dBm / 16dBm	
	Multiplication Factor	6	
LO Input Standard Freq. [4]*	Frequency Range	10-15GHz	2.9mm(f)
	Power (Typical [†] / Damage)	13dBm / 20dBm	
	Multiplication Factor	6	
IF Output Standard Freq. [4]*	Frequency Range	100MHz-2.5GHz	2.9mm(f)
IF Output High Freq. [5]	Frequency Range	100MHz-9GHz	2.9mm(f)
DC Input [6]	DC Power Connection	9V Output, 5A Maximum	2.1mm I.D. x 5.5mm O.D. x 9.5mm Male
Intrinsic Mixer**	SSB Conversion Loss***	10dB	-
Displayed Average Noise Level***		-152dBm/Hz	-

Table 1: General product specifications are shown.

[†] System is operational within +/- 3dB of nominal input power.

*Standard Freq. LO and IF share the same port.

**Intrinsic mixer conversion loss is measured before any IF amplification and cannot be accessed by user.

***See Section 5 for actual performance.



USER GUIDE

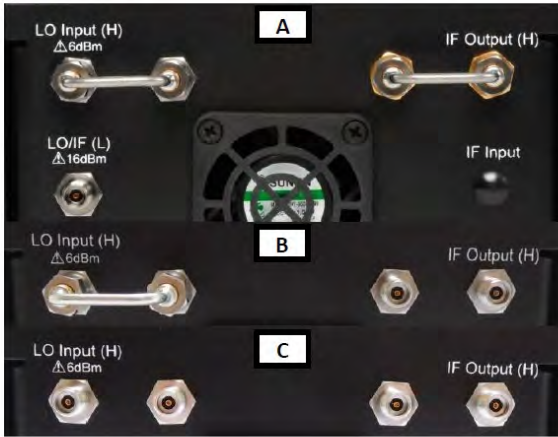

Configuration	LO Frequency	IF Frequency
A	Standard	Standard
B	Standard	High
C	High	High

Figure 2: Configuration details of dual LO input and dual IF output frequency modes are shown.

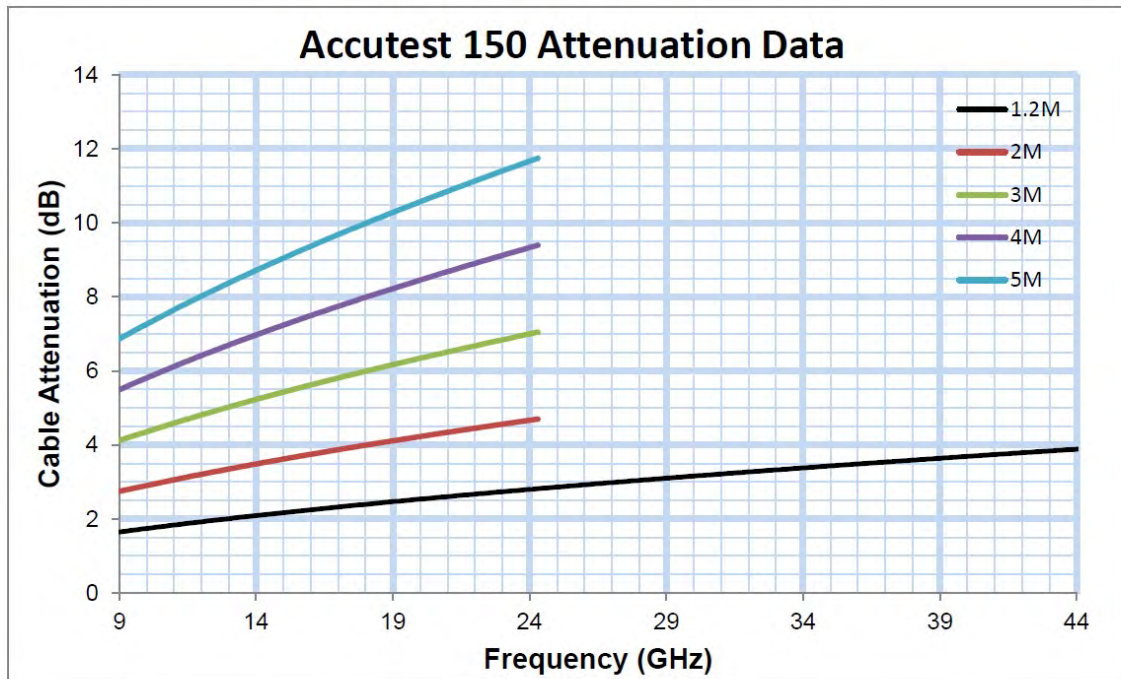

Figure 3: Insertion Loss of Accutest 150 (RF/LO Cable) with respect to frequency.



USER GUIDE

4 General Operating Procedures and Guidelines

VDI assumes the customer is familiar with VDI products, and VDI is not responsible for the warranty or guaranty of products damaged as a result of improper handling, testing, biasing, or use by customer. VDI offers the following general guidelines for using these products and recommends the customer contact VDI at (434) 297-3257 for assistance if needed. The following procedures are a quick guide for turning on and off the product. In each case the individual steps must be followed in the proper sequence to avoid damaging critical components.

4.1 Required Operating Procedures

- DO NOT exceed damage limits listed in Table 1.
- DO NOT apply any external biases to the system.
- Make proper RF connections depending on desired configuration (i.e. Standard/High LO and Standard/High IF operation). Refer to Figure 2A-C for more information.

Failure to follow these procedures will damage or destroy the device.

4.2 Additional Guidelines, Limitations, and Recommendations

- The SAX is shipped with a reusable dust cover attached. Remove dust cover before operation.

4.3 Turn-On Procedure

1. The user and test bench must be properly grounded and protected against ESD.
2. With the LO and RF input power turned off, make all necessary connections (i.e. LO cable, AC cable, DC cable). See Figure 2A-C for configuration details.
3. Turn on the LO input power.
4. Turn on the small signal RF input power and monitor the IF output.

4.4 Turn-Off Procedure

1. The user and test bench must be properly grounded and protected against ESD.
2. Turn off the RF input power.
3. Turn off the LO input power.
4. Disconnect the DC Power Supply.
5. After completing turn-off procedures described above, it is now safe to turn off all other equipment on user test bench.

Contact VDI with questions or concerns regarding operational procedures and limitations.



USER GUIDE

5 Product Performance

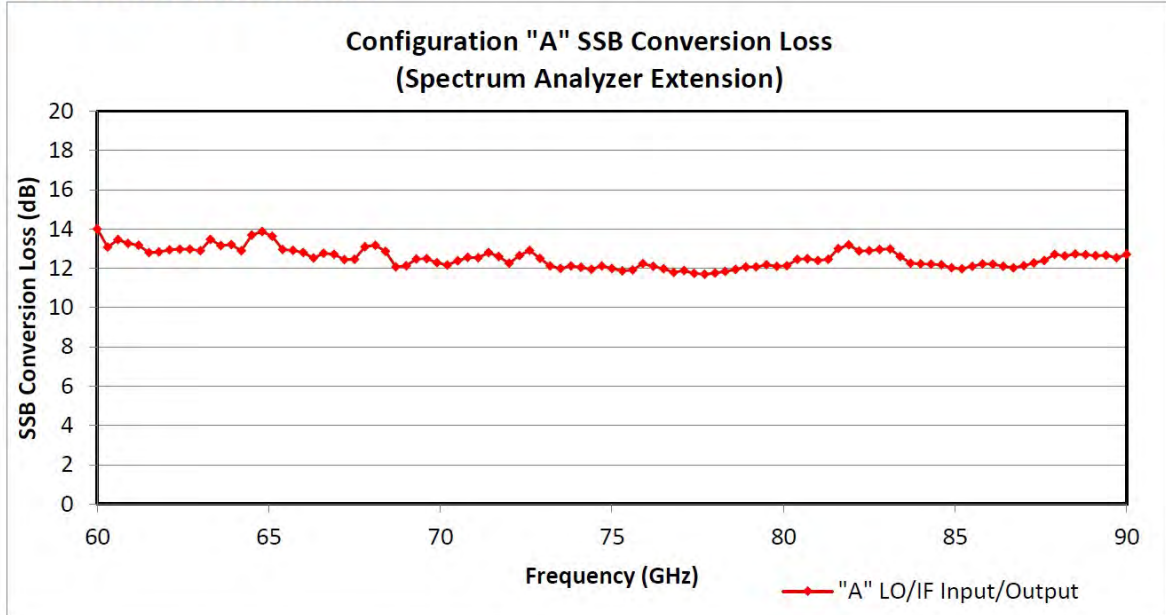

Figure 4: The product performance (SSB conversion loss vs. RF frequency) is shown for an LO input power of ~15dBm in Standard LO Frequency operation. IF power measured from "LO/IF" port with IF frequency fixed at 1.3GHz. CSV Data file included on USB Drive.

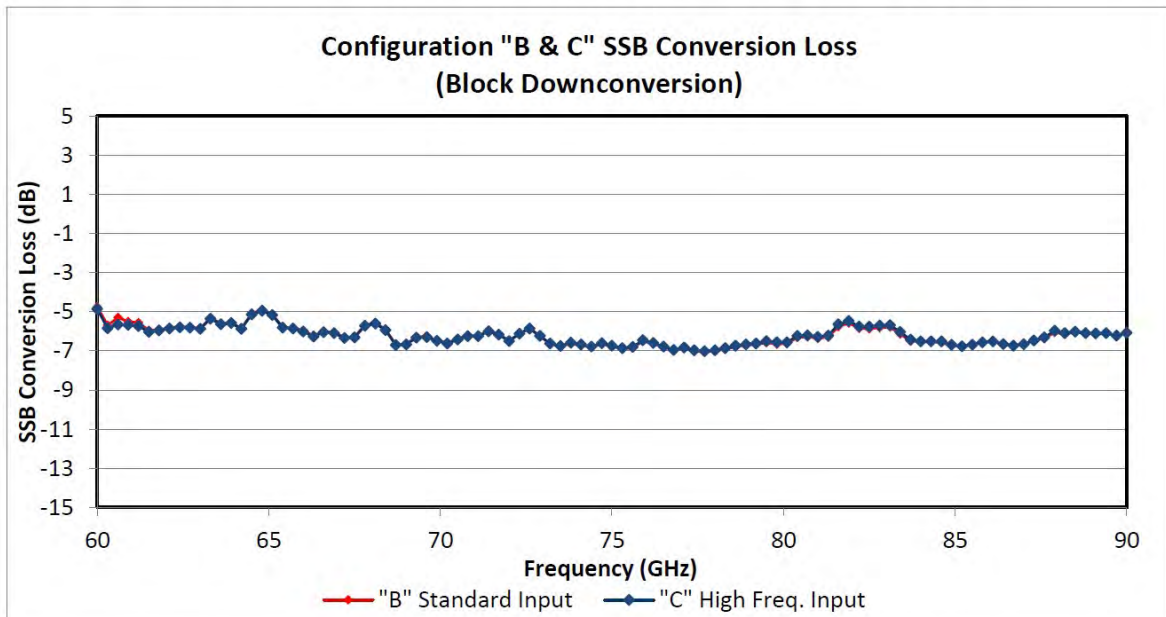

Figure 5: The product performance (SSB conversion loss vs. RF frequency) is shown for an LO input power of ~15dBm in Standard LO Frequency operation and LO input power of ~0dBm in High LO Frequency operation. IF power measured from "IF Output" port with IF frequency fixed at 1.3GHz. CSV Data file included on USB Drive.



USER GUIDE

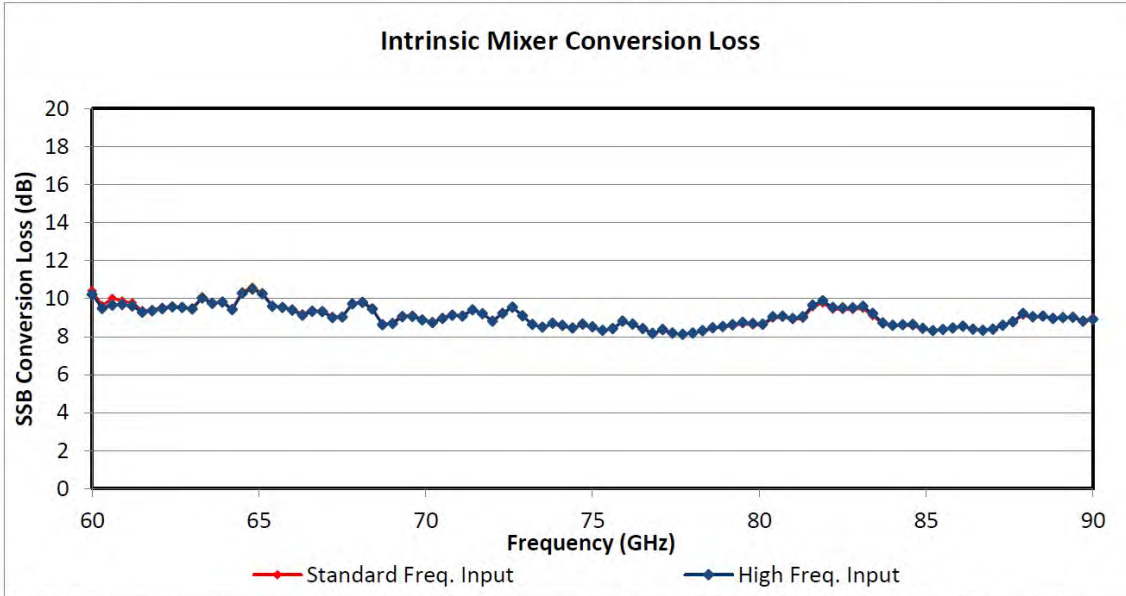

Figure 6: The product performance (SSB conversion loss vs. RF frequency) is shown for an LO input power of ~15dBm in Standard LO Frequency operation and LO input power of ~0dBm in High LO Frequency operation. IF power measured from mixer port with IF frequency fixed at 1.3GHz. Note: mixer port is not accessible for use by the user. CSV Data file included on USB Drive.

Measured Displayed Average Noise Level (dBm/Hz)	
Typical	-150.65

*Measured with a Keysight N9030A PXA Spectrum Analyzer.

Intertek

Report Number: 104723800BOX-001

Issued: 10/29/2021

Revised: 11/08/2021

11/10/2021

SAX 836 Conversion Loss Conversion Loss

Note: Out of band data is not guaranteed to be accurate.

Freq(GHz)	"A" LO/IF Input/Output	"B" Standard Input	"C" High Freq. Input	High Freq. Intrinsic Mixer Loss	Standard Freq. Intrinsic Mixer Loss
60	14.00809673	-4.74690327	-4.86490327	10.22409673	10.40709673
60.3	13.08177247	-5.686227526	-5.842227526	9.482772474	9.645772474
60.6	13.44988267	-5.300117334	-5.655117334	9.656882666	10.01088267
60.9	13.26543128	-5.497568718	-5.666568718	9.689431282	9.877431282
61.2	13.17933468	-5.566665317	-5.739665317	9.610334683	9.782334683
61.5	12.80009579	-5.949904212	-6.025904212	9.275095788	9.380095788
61.8	12.82914386	-5.919856141	-5.953856141	9.363143859	9.427143859
62.1	12.94303505	-5.816964953	-5.851964953	9.468035047	9.537035047
62.4	12.97887686	-5.769123137	-5.797123137	9.562876863	9.595876863
62.7	12.96847511	-5.790524891	-5.806524891	9.521475109	9.549475109
63	12.90047744	-5.846522559	-5.880522559	9.443477441	9.500477441
63.3	13.47453136	-5.305468637	-5.358468637	10.03153136	10.09053136
63.6	13.16719015	-5.597809855	-5.631809855	9.743190145	9.784190145
63.9	13.21223698	-5.54176302	-5.57776302	9.80323698	9.83423698
64.2	12.89882197	-5.858178027	-5.877178027	9.423821973	9.472821973
64.5	13.68621534	-5.074784662	-5.137784662	10.27721534	10.35121534
64.8	13.87468986	-4.891310145	-4.952310145	10.50468986	10.58768986
65.1	13.63537185	-5.11962815	-5.16362815	10.24337185	10.29937185
65.4	12.96383529	-5.779164713	-5.809164713	9.594835287	9.641835287
65.7	12.90818146	-5.823818544	-5.864818544	9.523181456	9.563181456
66	12.79905144	-5.948948563	-6.018948563	9.387051437	9.445051437
66.3	12.52625358	-6.224746423	-6.264746423	9.128253577	9.178253577
66.6	12.77501349	-6.002986511	-6.044986511	9.332013489	9.386013489
66.9	12.70577709	-6.056222906	-6.098222906	9.304777094	9.340777094
67.2	12.44844547	-6.298554532	-6.348554532	8.999445468	9.058445468
67.5	12.45771307	-6.27928693	-6.30628693	9.03571307	9.05871307
67.8	13.09446348	-5.662536517	-5.710536517	9.711463483	9.745463483
68.1	13.18159215	-5.574407845	-5.614407845	9.789592155	9.842592155
68.4	12.86269872	-5.889301275	-5.932301275	9.452698725	9.498698725
68.7	12.06465654	-6.679343461	-6.704343461	8.624656539	8.651656539
69	12.12697909	-6.634020906	-6.663020906	8.681979094	8.730979094
69.3	12.47379099	-6.275209006	-6.320209006	9.048790994	9.109790994
69.6	12.49635632	-6.266643679	-6.302643679	9.061356321	9.119356321
69.9	12.29461412	-6.451385875	-6.487385875	8.877614125	8.913614125
70.2	12.15951216	-6.599487841	-6.628487841	8.725512159	8.760512159
70.5	12.38334399	-6.369656014	-6.416656014	8.946343986	8.999343986

Intertek

Report Number: 104723800BOX-001

Issued: 10/29/2021

Revised: 11/08/2021

11/10/2021

70.8	12.55179008	-6.206209925	-6.243209925	9.126790075	9.154790075
71.1	12.53542905	-6.22657095	-6.25057095	9.07142905	9.11942905
71.4	12.80331874	-5.95168126	-6.00068126	9.40331874	9.41931874
71.7	12.59441785	-6.142582148	-6.177582148	9.194417852	9.228417852
72	12.26506093	-6.485939069	-6.497939069	8.817060931	8.831060931
72.3	12.6529332	-6.105066802	-6.130066802	9.223933198	9.253933198
72.6	12.91123601	-5.84176399	-5.85376399	9.54023601	9.55323601
72.9	12.50543192	-6.253568082	-6.234568082	9.097431918	9.095431918
73.2	12.12384684	-6.638153158	-6.616153158	8.645846842	8.647846842
73.5	11.99820018	-6.767799823	-6.748799823	8.497200177	8.484200177
73.8	12.11430193	-6.643698071	-6.582698071	8.701301929	8.647301929
74.1	12.05944184	-6.710558164	-6.669558164	8.594441836	8.540441836
74.4	11.94565033	-6.811349671	-6.778349671	8.456650329	8.429650329
74.7	12.11754896	-6.642451036	-6.607451036	8.659548964	8.623548964
75	11.99113212	-6.768867875	-6.733867875	8.506132125	8.483132125
75.3	11.86630909	-6.900690911	-6.860690911	8.333309089	8.310309089
75.6	11.91810032	-6.838899678	-6.798899678	8.423100322	8.401100322
75.9	12.24548213	-6.500517867	-6.451517867	8.808482133	8.772482133
76.2	12.10239893	-6.643601074	-6.590601074	8.650398926	8.617398926
76.5	11.98551471	-6.789485292	-6.773485292	8.417514708	8.412514708
76.8	11.79713504	-6.968864956	-6.945864956	8.175135044	8.189135044
77.1	11.88064822	-6.869351775	-6.824351775	8.367648225	8.314648225
77.4	11.7419614	-7.018038601	-6.974038601	8.182961399	8.171961399
77.7	11.70070307	-7.05529693	-7.02129693	8.12070307	8.12070307
78	11.75970185	-6.99429815	-6.96829815	8.18070185	8.17970185
78.3	11.84442873	-6.900571271	-6.854571271	8.310428729	8.287428729
78.6	11.95018765	-6.799812349	-6.734812349	8.461187651	8.414187651
78.9	12.06854076	-6.706459237	-6.665459237	8.532540763	8.518540763
79.2	12.07851172	-6.674488276	-6.618488276	8.626511724	8.567511724
79.5	12.18083903	-6.574160969	-6.495160969	8.753839031	8.672839031
79.8	12.10740792	-6.654592085	-6.567592085	8.682407915	8.602407915
80.1	12.12624941	-6.617750592	-6.567750592	8.650249408	8.586249408
80.4	12.45676064	-6.305239365	-6.226239365	9.050760635	8.968760635
80.7	12.49277424	-6.273225761	-6.198225761	9.072774239	9.015774239
81	12.39938675	-6.35061325	-6.28161325	8.95738675	8.90238675
81.3	12.46230193	-6.292698068	-6.222698068	9.038301932	8.952301932
81.6	13.00393377	-5.757066234	-5.633066234	9.655933766	9.553933766
81.9	13.1857019	-5.5832981	-5.4612981	9.8847019	9.7637019
82.2	12.87742475	-5.848575252	-5.743575252	9.531424748	9.429424748
82.5	12.89518705	-5.867812949	-5.763812949	9.519187051	9.423187051
82.8	12.95150506	-5.81749494	-5.70349494	9.52050506	9.42650506
83.1	12.98575567	-5.77524433	-5.68224433	9.59075567	9.47675567

Intertek

Report Number: 104723800BOX-001

Issued: 10/29/2021

Revised: 11/08/2021

11/10/2021

83.4	12.59718822	-6.140811779	-6.029811779	9.215188221	9.091188221
83.7	12.25796009	-6.493039911	-6.419039911	8.712960089	8.670960089
84	12.23114021	-6.524859786	-6.506859786	8.586140214	8.569140214
84.3	12.20708834	-6.540911658	-6.506911658	8.629088342	8.584088342
84.6	12.18133493	-6.580665066	-6.515665066	8.645334934	8.565334934
84.9	12.01835551	-6.731644488	-6.691644488	8.437355512	8.409355512
85.2	11.97910956	-6.769890438	-6.757890438	8.310109562	8.331109562
85.5	12.09929486	-6.662705139	-6.685705139	8.368294861	8.384294861
85.8	12.22092835	-6.529071647	-6.559071647	8.449928353	8.487928353
86.1	12.21270567	-6.532294329	-6.513294329	8.549705671	8.545705671
86.4	12.10955656	-6.659443442	-6.661443442	8.391556558	8.413556558
86.7	12.01941635	-6.735583651	-6.734583651	8.320416349	8.351416349
87	12.12790597	-6.652094034	-6.659094034	8.388905966	8.431905966
87.3	12.2779043	-6.474095698	-6.469095698	8.598904302	8.628904302
87.6	12.39380025	-6.359199748	-6.316199748	8.776800252	8.773800252
87.9	12.70905543	-6.059944574	-5.963944574	9.212055426	9.121055426
88.2	12.63644451	-6.145555491	-6.093555491	9.051444509	8.987444509
88.5	12.72378687	-6.047213129	-6.017213129	9.075786871	9.078786871
88.8	12.69878056	-6.070219442	-6.093219442	8.943780558	8.993780558
89.1	12.64415049	-6.140849508	-6.113849508	8.990150492	8.997150492
89.4	12.66086495	-6.119135052	-6.096135052	9.011864948	9.040864948
89.7	12.54474949	-6.223250512	-6.212250512	8.804749488	8.861749488
90	12.70351072	-6.062489285	-6.075489285	8.899510715	8.976510715

90-140 GHz Mixer Conversion Loss

Report Number: 104723800BOX-001	Issued: 10/29/2021 Revised: 11/08/2021 11/10/2021
---------------------------------	---



USER GUIDE

WR8.0SAX-F

1 Product Overview

Product List (Quantity)	Serial Number(s)	Order No.	Date / Initials
WR8.0SAX-F (1)	SAX 837	21108C	06/10/2021 DNS

Product Description: This VDI product includes one WR8.0 Frequency Extender, intended for use with Rohde & Schwarz FSW spectrum analyzers. This user guide details the operation of the Frequency Extension Module.

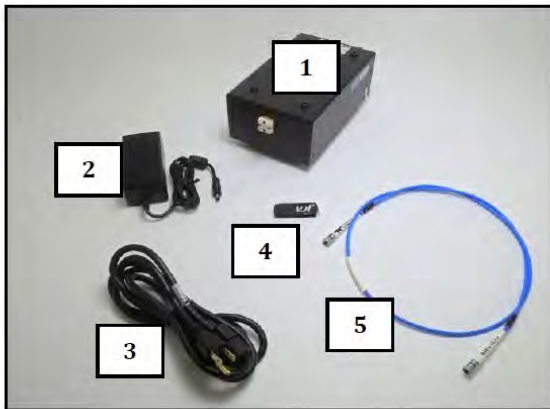

No.	Part Description
1	SAX 837
2	9V Power Supply
3	AC Power Cable
4	USB Drive
5	LO Cable (not included)

Figure 1: Photograph of typical configuration. All items may not be included.
Note: Photographs and specifications of accessories (horns, waveguide straights, etc.) are not included in this user guide.

2 Warning and Caution Statements

WARNING AND CAUTION STATEMENTS	
WARNING	This product can be permanently damaged by Electrostatic Discharge (ESD). It is recommended that engineers and technicians wear a special grounded wrist strap when handling this component. In addition, the work environment around the component should be well grounded.
WARNING	Opening the blocks, parts, or components will damage the internal components. VDI is not responsible for the warranty or guaranty of products damaged as a result of improper handling, testing, biasing, or use by customer.
CAUTION	VDI assumes the customer is familiar with microwave, millimeter wave, and VDI products. The user and customer are expected to understand all safety guidelines, health hazards, and general advisories that may exist and are associated with the use of this device. VDI is not responsible for any human hazards that may exist or may occur while using this device.

3 Product Specifications



USER GUIDE

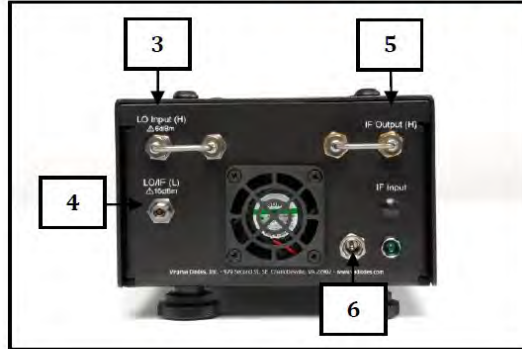
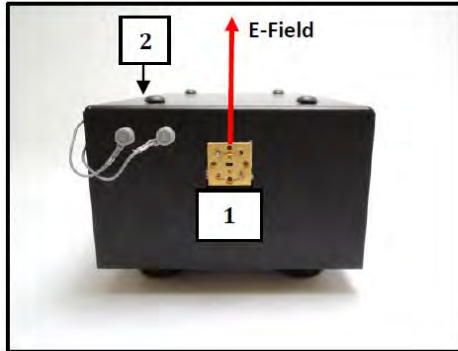

Description		Specification	Connector
RF Input [1]	Frequency Range	90-140GHz	WR8.0
	Power (Optimal / Damage)	<-20dBm / -10dBm	UG-599/UM
Voltage Bias Port [2]	External Component Bias Voltage	+9V Output 50mA Maximum	LEMO 00 (f)
LO Input High Freq. [3]	Frequency Range	30-46.67GHz	2.9mm(f)
	Power (Typical† / Damage)	0dBm / 6dBm	
	Multiplication Factor	3	
LO Input Standard Freq. [4]*	Frequency Range	10-15.56GHz	2.9mm(f)
	Power (Typical† / Damage)	13dBm / 20dBm	
	Multiplication Factor	9	
IF Output Standard Freq. [4]*	Frequency Range	100MHz-2.5GHz	2.9mm(f)
IF Output High Freq. [5]	Frequency Range	100MHz-14GHz	2.9mm(f)
DC Input [6]	DC Power Connection	9V Output, 5A Maximum	2.1mm I.D. x 5.5mm O.D. x 9.5mm Male
Intrinsic Mixer**	SSB Conversion Loss***	10dB	-
Displayed Average Noise Level***		-150dBm/Hz	-

Table 1: General product specifications are shown.

† System is operational within +/- 3dB of nominal input power.

*Standard Freq. LO and IF share the same port.

**Intrinsic mixer conversion loss is measured before any IF amplification and cannot be accessed by user.

***See Section 5 for actual performance.



USER GUIDE

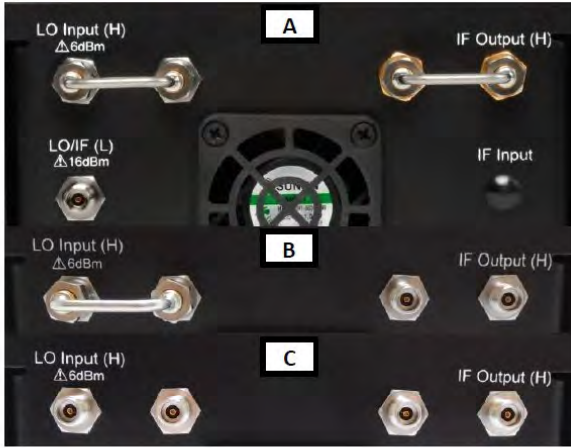

Configuration	LO Frequency	IF Frequency
A	Standard	Standard
B	Standard	High
C	High	High

Figure 2: Configuration details of dual LO input and dual IF output frequency modes are shown.

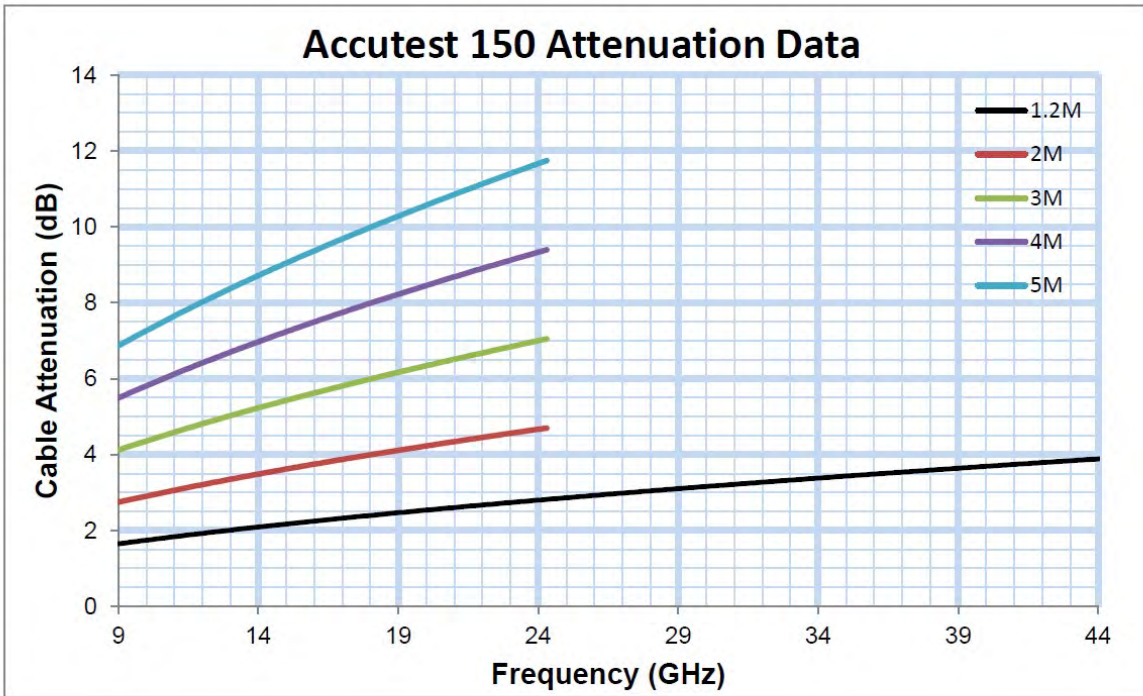

Figure 3: Insertion Loss of Accutest 150 (RF/LO Cable) with respect to frequency.



USER GUIDE

4 General Operating Procedures and Guidelines

VDI assumes the customer is familiar with VDI products, and VDI is not responsible for the warranty or guaranty of products damaged as a result of improper handling, testing, biasing, or use by customer. VDI offers the following general guidelines for using these products and recommends the customer contact VDI at (434) 297-3257 for assistance if needed. The following procedures are a quick guide for turning on and off the product. In each case the individual steps must be followed in the proper sequence to avoid damaging critical components.

4.1 Required Operating Procedures

- DO NOT exceed damage limits listed in Table 1.
- DO NOT apply any external biases to the system.
- Make proper RF connections depending on desired configuration (i.e. Standard/High LO and Standard/High IF operation). Refer to Figure 2A-C for more information.

Failure to follow these procedures will damage or destroy the device.

4.2 Additional Guidelines, Limitations, and Recommendations

- The SAX is shipped with a reusable dust cover attached. Remove dust cover before operation.

4.3 Turn-On Procedure

1. The user and test bench must be properly grounded and protected against ESD.
2. With the LO and RF input power turned off, make all necessary connections (i.e. LO cable, AC cable, DC cable). See Figure 2A-C for configuration details.
3. Turn on the LO input power.
4. Turn on the small signal RF input power and monitor the IF output.

4.4 Turn-Off Procedure

1. The user and test bench must be properly grounded and protected against ESD.
2. Turn off the RF input power.
3. Turn off the LO input power.
4. Disconnect the DC Power Supply.
5. After completing turn-off procedures described above, it is now safe to turn off all other equipment on user test bench.

Contact VDI with questions or concerns regarding operational procedures and limitations.



USER GUIDE

5 Product Performance

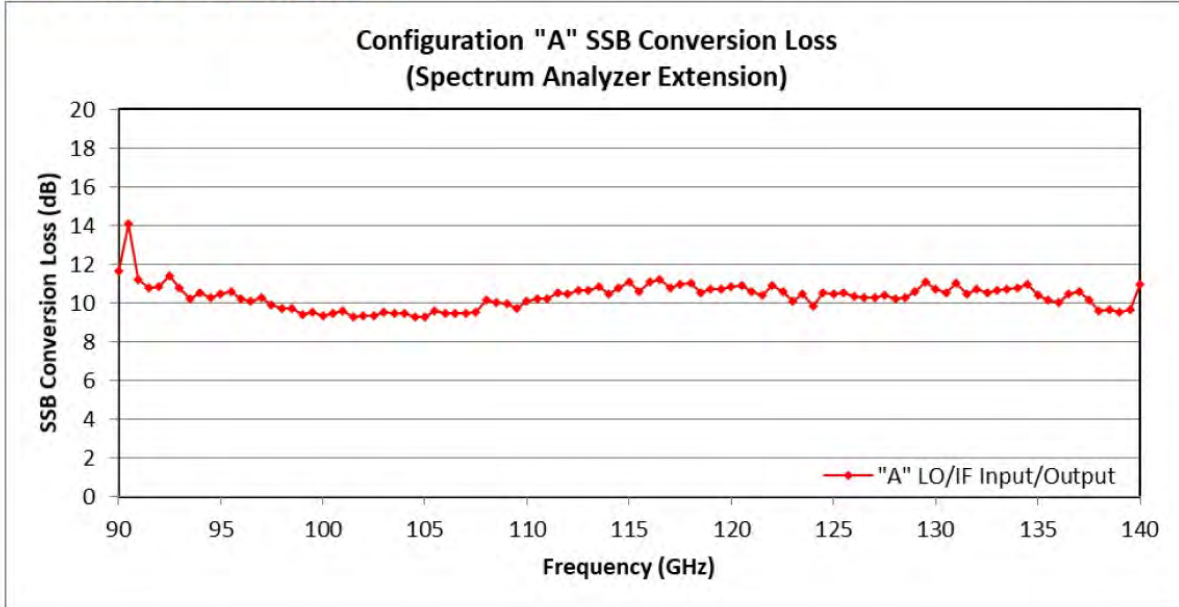

Figure 4: The product performance (SSB conversion loss vs. RF frequency) is shown for an LO input power of ~15dBm in Standard LO Frequency operation. IF power measured from "LO/IF" port with IF frequency fixed at 1.3GHz. CSV Data file included on USB Drive.

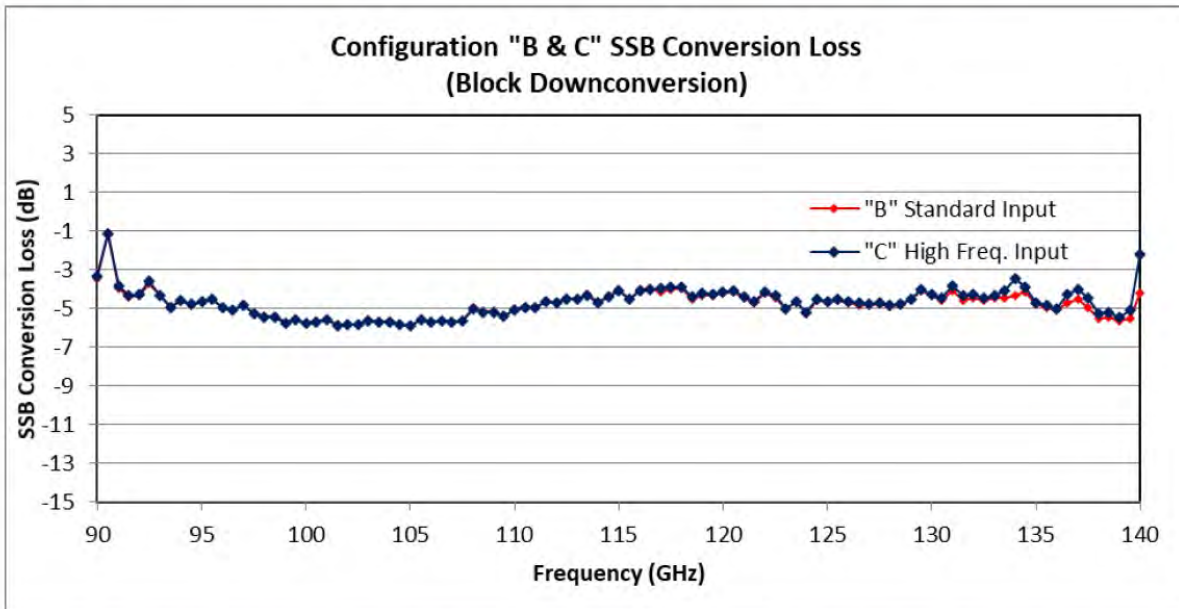

Figure 5: The product performance (SSB conversion loss vs. RF frequency) is shown for an LO input power of ~15dBm in Standard LO Frequency operation and LO input power of ~0dBm in High LO Frequency operation. IF power measured from "IF Output" port with IF frequency fixed at 1.3GHz. CSV Data file included on USB Drive.



USER GUIDE

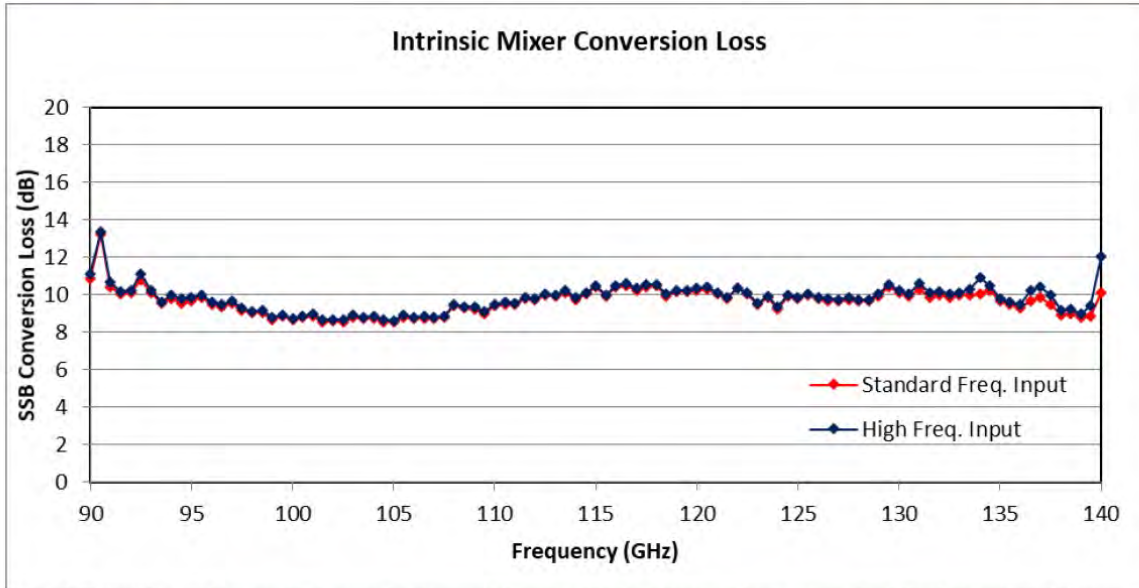

Figure 6: The product performance (SSB conversion loss vs. RF frequency) is shown for an LO input power of ~15dBm in Standard LO Frequency operation and LO input power of ~0dBm in High LO Frequency operation. IF power measured from mixer port with IF frequency fixed at 1.3GHz. Note: mixer port is not accessible for use by the user. CSV Data file included on USB Drive.

Measured Displayed Average Noise Level (dBm/Hz)	
Typical	-149.5

*Measured with a Keysight N9030A PXA Spectrum Analyzer.

Intertek

Report Number: 104723800BOX-001

Issued: 10/29/2021

Revised: 11/08/2021

11/10/2021

SAX 837 Conversion Loss Conversion Loss

Note: Out of band data is not guaranteed to be accurate.

Freq(GHz)	"A" LO/IF Input/Output	"B" Standard Input	"C" High Freq. Input	High Freq. Intrinsic Mixer Loss	Standard Freq. Intrinsic Mixer Loss
90	11.67514724	-3.451852763	-3.337852763	11.13014724	10.85114724
90.5	14.10568478	-1.079315219	-1.162315219	13.39768478	13.21768478
91	11.19284379	-3.952156213	-3.831156213	10.66284379	10.43484379
91.5	10.77353378	-4.372466216	-4.345466216	10.19653378	10.03853378
92	10.8156319	-4.3273681	-4.2933681	10.2776319	10.0966319
92.5	11.40549847	-3.724501532	-3.574501532	11.09249847	10.79149847
93	10.79724258	-4.331757419	-4.317757419	10.24124258	10.10624258
93.5	10.21914168	-4.91885832	-4.95285832	9.63014168	9.54914168
94	10.55024142	-4.587758581	-4.565758581	9.996241419	9.821241419
94.5	10.29788363	-4.822116373	-4.753116373	9.778883628	9.588883628
95	10.4741589	-4.669841103	-4.660841103	9.843158897	9.695158897
95.5	10.60265733	-4.50734267	-4.51534267	9.99665733	9.89265733
96	10.1907898	-4.953210203	-4.985210203	9.625789797	9.505789797
96.5	10.083555	-5.061445003	-5.079445003	9.479554997	9.372554997
97	10.30032929	-4.847670708	-4.859670708	9.661329292	9.553329292
97.5	9.894886965	-5.239113035	-5.255113035	9.296886965	9.162886965
98	9.696380637	-5.421619363	-5.441619363	9.135380637	9.034380637
98.5	9.728739538	-5.401260462	-5.427260462	9.168739538	9.038739538
99	9.401152675	-5.731847325	-5.746847325	8.803152675	8.707152675
99.5	9.542871349	-5.586128651	-5.600128651	8.951871349	8.840871349
100	9.367058164	-5.769941836	-5.782941836	8.777058164	8.658058164
100.5	9.496118475	-5.651881525	-5.678881525	8.901118475	8.787118475
101	9.563891248	-5.561108752	-5.575108752	8.981891248	8.875891248
101.5	9.294818879	-5.847181121	-5.869181121	8.686818879	8.578818879
102	9.32353949	-5.80946051	-5.83646051	8.70453949	8.60753949
102.5	9.312544107	-5.835455893	-5.854455893	8.691544107	8.586544107
103	9.538372928	-5.604627072	-5.619627072	8.933372928	8.824372928
103.5	9.440667741	-5.698332259	-5.705332259	8.834667741	8.727667741
104	9.473096285	-5.666903715	-5.678903715	8.866096285	8.770096285
104.5	9.295835708	-5.846164292	-5.856164292	8.670835708	8.571835708
105	9.26675987	-5.86924013	-5.87924013	8.63275987	8.53575987
105.5	9.587719809	-5.566280191	-5.585280191	8.920719809	8.823719809
106	9.447107698	-5.688892302	-5.6968892302	8.806107698	8.722107698
106.5	9.47817723	-5.65582277	-5.66782277	8.86217723	8.77317723
107	9.445819292	-5.693180709	-5.715180709	8.831819292	8.718819292
107.5	9.506835045	-5.627164955	-5.646164955	8.896835045	8.804835045

Intertek

Report Number: 104723800BOX-001

Issued: 10/29/2021

Revised: 11/08/2021

11/10/2021

108	10.15543137	-4.980568633	-5.021568633	9.515431367	9.429431367
108.5	10.01501141	-5.139988586	-5.184988586	9.375011414	9.292011414
109	9.986943402	-5.163056598	-5.180056598	9.359943402	9.259943402
109.5	9.700311379	-5.427688621	-5.415688621	9.090311379	9.007311379
110	10.11440377	-5.034596231	-5.068596231	9.480403769	9.435403769
110.5	10.23931625	-4.896683751	-4.935683751	9.593316249	9.506316249
111	10.19914709	-4.941852911	-4.978852911	9.567147089	9.514147089
111.5	10.51961626	-4.630383737	-4.666383737	9.887616263	9.822616263
112	10.45156748	-4.687432519	-4.685432519	9.837567481	9.740567481
112.5	10.66102657	-4.482973427	-4.488973427	10.07402657	9.973026573
113	10.62316393	-4.517836074	-4.541836074	10.01716393	9.943163926
113.5	10.84547099	-4.287529014	-4.341529014	10.22647099	10.14647099
114	10.46605969	-4.667940312	-4.688940312	9.862059688	9.774059688
114.5	10.76937147	-4.369628526	-4.376628526	10.14637147	10.05437147
115	11.11837657	-4.04062343	-4.05262343	10.48737657	10.40737657
115.5	10.59959028	-4.534409721	-4.539409721	10.02759028	9.940590279
116	11.08255473	-4.042445266	-4.056445266	10.50855473	10.41955473
116.5	11.23473017	-3.950269828	-4.014269828	10.59973017	10.49673017
117	10.75491026	-4.152089736	-3.939089736	10.36291026	10.26991026
117.5	10.96623836	-4.013761637	-3.885761637	10.55123836	10.44823836
118	11.04450356	-3.973496442	-3.878496442	10.56050356	10.48550356
118.5	10.52617331	-4.502826691	-4.414826691	10.04817331	9.940173309
119	10.71214465	-4.310855347	-4.229855347	10.27714465	10.18914465
119.5	10.73550138	-4.318498616	-4.257498616	10.26750138	10.16450138
120	10.83361073	-4.226389267	-4.143389267	10.35961073	10.27661073
120.5	10.88819078	-4.15980922	-4.09380922	10.41419078	10.33619078
121	10.61391575	-4.435084247	-4.384084247	10.13691575	10.06591575
121.5	10.37585906	-4.697140936	-4.630140936	9.876859064	9.825859064
122	10.92118158	-4.177818422	-4.117818422	10.38918158	10.35018158
122.5	10.59706531	-4.452934691	-4.359934691	10.13506531	10.05606531
123	10.06564904	-5.02435096	-4.99135096	9.55564904	9.48764904
123.5	10.43854116	-4.643458841	-4.628458841	9.936541159	9.847541159
124	9.860132081	-5.249867919	-5.203867919	9.352132081	9.265132081
124.5	10.50591325	-4.589086747	-4.518086747	10.00491325	9.903913253
125	10.4479865	-4.673013497	-4.657013497	9.882986503	9.791986503
125.5	10.54246455	-4.560535451	-4.549535451	10.03846455	9.965464549
126	10.350356	-4.721644004	-4.674644004	9.874355996	9.804355996
126.5	10.27868628	-4.807313723	-4.735313723	9.805686277	9.713686277
127	10.26573962	-4.837260384	-4.798260384	9.773739616	9.685739616
127.5	10.39357186	-4.74042814	-4.71242814	9.85857186	9.76757186
128	10.2407497	-4.876250305	-4.819250305	9.737749695	9.661749695
128.5	10.27302715	-4.815972854	-4.774972854	9.753027146	9.666027146

Intertek

Report Number: 104723800BOX-001

Issued: 10/29/2021

Revised: 11/08/2021

11/10/2021

129	10.57790721	-4.539092789	-4.493092789	10.04490721	9.944907211
129.5	11.06294687	-4.055053128	-4.017053128	10.52894687	10.44894687
130	10.74665017	-4.351349831	-4.264349831	10.25565017	10.14965017
130.5	10.54234128	-4.571658716	-4.477658716	10.04334128	9.919341284
131	10.99784288	-4.095157118	-3.820157118	10.59784288	10.32284288
131.5	10.48624586	-4.582754137	-4.311754137	10.14424586	9.843245863
132	10.711127934	-4.428720663	-4.285720663	10.18227934	10.02627934
132.5	10.54574278	-4.587257219	-4.439257219	10.07174278	9.893742781
133	10.64369663	-4.477303375	-4.340303375	10.14769663	9.976696625
133.5	10.68664451	-4.43135549	-4.10535549	10.33764451	9.99364451
134	10.78700975	-4.313990247	-3.460990247	10.93500975	10.07700975
134.5	10.95997375	-4.161026252	-3.916026252	10.52797375	10.25597375
135	10.37279947	-4.751200533	-4.707200533	9.788799467	9.689799467
135.5	10.1724832	-4.934516804	-4.843516804	9.642483196	9.511483196
136	10.044754	-5.108245999	-4.999245999	9.512754001	9.332754001
136.5	10.45312533	-4.676874665	-4.252874665	10.25012533	9.695125335
137	10.61386016	-4.518139838	-3.994139838	10.42886016	9.852860162
137.5	10.14375506	-4.948244935	-4.476244935	9.965755065	9.481755065
138	9.604980629	-5.520019371	-5.270019371	9.185980629	8.939980629
138.5	9.663838852	-5.432161148	-5.190161148	9.272838852	9.004838852
139	9.512629562	-5.615370438	-5.452370438	9.013629562	8.813629562
139.5	9.644409056	-5.524590944	-5.063590944	9.413409056	8.893409056
140	10.95996759	-4.22003241	-2.22503241	12.05596759	10.15096759

Notes: The test equipment was provided by Starry, Inc. The vendor does not provide a calibration certificate.

Intertek

Report Number: 104723800BOX-001

Issued: 10/29/2021

Revised: 11/08/2021

11/10/2021

14 Appendix B – Mixer Verification Certificates

VDIWR19.0SAX-F (40-60 GHz)



Virginia Diodes, Inc

979 2nd St. SE
Suite 309
Charlottesville, VA 22902
Phone: 434-297-3257
Fax: 434-297-3258

Certificate of Conformance

To: Starry, Inc.
38 Chauncy Street
2nd Floor
Boston, MA 02111
United States

From: Virginia Diodes, Inc
979 2nd St. SE
Suite 309
Charlottesville, VA 22902

Packing List No: 211085
Shipping Date: 03/30/21

Today's Date: 03/31/21
PO Number: PO20183

Quantity			
<u>Shipped</u>	<u>Unit</u>	<u>Description</u>	<u>Order-Job Number</u>
1	EA	VDIWR19.0SAX-F S/N: SAX 835	21108A-01
1	EA	RCHO19R CONICAL HORN ANTENNA	21108A-02

The VDI product(s) in this shipment meet(s) the guidelines for performance specifications established in accordance with the corresponding Purchase Order. Data presented in the User Guide, where applicable, has been obtained in accordance with VDI's Quality Management System. All instruments, used to obtain data, which require calibration have been calibrated with equipment traceable to the National Institute of Standards and Technology (NIST) and through NIST to the International System of Units (SI).

A handwritten signature in black ink, appearing to be 'C. A.', is written over a horizontal line.

Authorized Signature
Virginia Diodes, Inc

Intertek

Report Number: 104723800BOX-001

Issued: 10/29/2021
Revised: 11/08/2021
11/10/2021

VDIWR12.0SAX-F (60-90 GHz)



Virginia Diodes, Inc

979 2nd St. SE
Suite 309
Charlottesville, VA 22902
Phone: 434-297-3257
Fax: 434-297-3258

Certificate of Conformance

To: Starry, Inc.
38 Chauncy Street
2nd Floor
Boston, MA 02111
United States

From: Virginia Diodes, Inc
979 2nd St. SE
Suite 309
Charlottesville, VA 22902

Packing List No: 211211
Shipping Date: 04/08/21

Today's Date: 04/12/21
PO Number: PO20183

Quantity			
<u>Shipped</u>	<u>Unit</u>	<u>Description</u>	<u>Order-Job Number</u>
1	EA	VDIWR12.0SAX-F S/N: SAX 836	21108B-01
1	EA	RCHO12RL Conical Horn Antenna	21108B-02

The VDI product(s) in this shipment meet(s) the guidelines for performance specifications established in accordance with the corresponding Purchase Order. Data presented in the User Guide, where applicable, has been obtained in accordance with VDI's Quality Management System. All instruments, used to obtain data, which require calibration have been calibrated with equipment traceable to the National Institute of Standards and Technology (NIST) and through NIST to the International System of Units (SI).

Authorized Signature
Virginia Diodes, Inc

Page 1 of 1

Intertek

Report Number: 104723800BOX-001

Issued: 10/29/2021
Revised: 11/08/2021
11/10/2021

VDIWR8.0SAX-F (90-140 GHz)



Virginia Diodes, Inc

979 2nd St. SE
Suite 309
Charlottesville, VA 22902
Phone: 434-297-3257
Fax: 434-297-3258

Certificate of Conformance

To: Starry, Inc.
38 Chauncy Street
2nd Floor
Boston, MA 02111
United States

From: Virginia Diodes, Inc
979 2nd St. SE
Suite 309
Charlottesville, VA 22902

Packing List No: 212029
Shipping Date: 06/11/21

Today's Date: 06/11/21
PO Number: PO20183

Quantity	Shipped	Unit	Description	Order-Job Number
1		EA	VDIWR8.0SAX-F WR8.0SAX-F / SN: SAX 837	21108C-01
1		EA	RCHO8RL WR8.0CH - Conical Horn Antenna / RCHO8RL	21108C-02

The VDI product(s) in this shipment meet(s) the guidelines for performance specifications established in accordance with the corresponding Purchase Order. Data presented in the User Guide, where applicable, has been obtained in accordance with VDI's Quality Management System. All instruments, used to obtain data, which require calibration have been calibrated with equipment traceable to the National Institute of Standards and Technology (NIST) and through NIST to the International System of Units (SI).

Authorized Signature
Virginia Diodes, Inc

A handwritten signature in black ink, appearing to be 'AOM', is written over a horizontal line.

Page 1 of 1

Intertek

Report Number: 104723800BOX-001

Issued: 10/29/2021
Revised: 11/08/2021
11/10/2021

VDIWR5.1SAX-F (140-220 GHz)



Virginia Diodes, Inc

979 2nd St. SE
Suite 309
Charlottesville, VA 22902
Phone: 434-297-3257
Fax: 434-297-3258

Certificate of Conformance

To: Starry, Inc.
38 Chauncy Street
2nd Floor
Boston, MA 02111
United States

From: Virginia Diodes, Inc
979 2nd St. SE
Suite 309
Charlottesville, VA 22902

Packing List No: 211604
Shipping Date: 05/11/21

Today's Date: 05/11/21
PO Number: PO20183

Quantity			
<u>Shipped</u>	<u>Unit</u>	<u>Description</u>	<u>Order-Job</u> <u>Number</u>
1	EA	VDIWR5.1SAX-F WR5.1SAX-F / SN: SAX 838	21108D-01
1	EA	RCHO5RL WR5.1CH / SN: RCHO5RL	21108D-02

The VDI product(s) in this shipment meet(s) the guidelines for performance specifications established in accordance with the corresponding Purchase Order. Data presented in the User Guide, where applicable, has been obtained in accordance with VDI's Quality Management System. All instruments, used to obtain data, which require calibration have been calibrated with equipment traceable to the National Institute of Standards and Technology (NIST) and through NIST to the International System of Units (SI).

Authorized Signature
Virginia Diodes, Inc

Page 1 of 1

15 Appendix C – Test Laboratory Accreditation Scope

OET Accredited Test firm scope List
 Test Firm: **Intertek Testing Services NA Inc.**

Scope	FCC Rule Parts	Maximum Assessed Emergency Rate	Status	Expiration Date	Recognition Date
Unintentional Radiators	FCC Part 15, Subpart B	260000.00	Approved	06-30-2022	09-29-2017
Industrial, Scientific, and Medical Equipment	FCC Part 18	260000.00	Approved	06-30-2022	09-29-2017
Intentional Radiators	FCC Part 15 Subpart C	260000.00	Approved	06-30-2022	09-29-2017
IPCS	FCC Part 15, Subpart D	260000.00	Approved	06-30-2022	09-29-2017
U-NII without DFS	FCC Part 15, Subpart E	260000.00	Approved	06-30-2022	09-29-2017
Intentional Radiators					
U-NII with DFS Intentional Radiators	FCC Part 15, Subpart E	260000.00	Approved	06-30-2022	09-29-2017
UWB Intentional Radiators	FCC Part 15, Subpart F	260000.00	Approved	06-30-2022	09-29-2017
IRL Intentional Radiators	FCC Part 15, Subpart G	260000.00	Approved	06-30-2022	09-29-2017
White Space Device	FCC Part 15, Subpart H	260000.00	Approved	06-30-2022	09-29-2017
Intentional Radiators					
Commercial Mobile Services	Part 22 (cellular), Part 24, Part 25 (below 3 GHz), Part 27	260000.00	Approved	06-30-2022	09-29-2017
General Mobile Radio Services	Part 22 (non-cellular), Part 90 (below 3 GHz), Part 95 (below 3 GHz), Part 97 (below 3 GHz), Part 101 (below 3 GHz)	260000.00	Approved	06-30-2022	09-29-2017
Maritime and Aviation Radio Services	Part 80, Part 87	260000.00	Approved	06-30-2022	09-29-2017
Microwave and Millimeter Bands Radio Services	Part 25 (above 3 GHz), Part 30, Part 74, Part 90 (above 3 GHz), Part 95 (above 3 GHz), Part 97 (above 3 GHz) Part 301	3260000.00	Approved	06-30-2022	09-29-2017
Broadcast Radio Services	Part 73, Part 74 (below 3 GHz)	260000.00	Approved	06-30-2022	09-29-2017
Signal Boosters	Part 20, Part 90.219	260000.00	Approved	06-30-2022	09-29-2017