



# EMC TEST REPORT

<b>Applicant</b>	Starry, Inc.
<b>FCC ID</b>	2AGZ3S00111
<b>Product</b>	Starry Station
<b>Model</b>	S00111
<b>Report No.</b>	RXA1602-0024EMC
<b>Issue Date</b>	March 25, 2016

TA Technology (Shanghai) Co., Ltd. tested the above equipment in accordance with the requirements in **FCC Code CFR47 Part15B (2014)/ ANSI C63.4 (2014)**. The test results show that the equipment tested is capable of demonstrating compliance with the requirements as documented in this report.

*Wei Liu*

*Reviewed by: Wei Liu*

*Guangchang Fan*

*Approved by: Guangchang Fan*



## TA Technology (Shanghai) Co., Ltd.

No.145, Jintang Rd, Tangzhen Industry Park, Pudong Shanghai, China

TEL: +86-021-50791141/2/3

FAX: +86-021-50791141/2/3-8000



## Table of Contents

1	Test Laboratory.....	4
1.1	Notes of the Test Report.....	4
1.2	Test facility.....	4
1.3	Testing Location.....	5
2	General Description of Equipment under Test.....	6
2.1	Client Information.....	6
2.2	General information.....	6
2.3	Applied Standards.....	7
3	Test Case Results.....	8
3.1	Radiated Emission.....	8
3.2	Conducted Emission.....	15
4	Main Test Equipment.....	18
	ANNEX A: The EUT Appearance and Test Configuration.....	19
	A.1 EUT Appearance.....	19
	A.2 Test Setup.....	21
	A.3 Host Product.....	23



### Summary of measurement results

Number	Test Case	Clause in FCC Rules	Conclusion
1	Radiated Emission	15.109, ANSI C63.4-2014	PASS
2	Conducted Emission	15.107, ANSI C63.4-2014	PASS
Test Date: December 28, 2015~ January 20, 2016			

# 1 Test Laboratory

## 1.1 Notes of the Test Report

This report shall not be reproduced in full or partial, without the written approval of TA technology (shanghai) co., Ltd).The results documented in this report apply only to the tested sample, under the conditions and modes of operation as described herein .Measurement Uncertainties were not taken into account and are published for informational purposes only. This report is written to support regulatory compliance of the applicable standards stated above. This report must not be used by the client to claim product certification, approval, or endorsement by CNAS or any government agencies.

## 1.2 Test facility

### **CNAS (accreditation number: L2264)**

TA Technology (Shanghai) Co., Ltd. has obtained the accreditation of China National Accreditation Service for Conformity Assessment (CNAS).

### **FCC (recognition number is 428261)**

TA Technology (Shanghai) Co., Ltd. has been listed on the US Federal Communications Commission list of test facilities recognized to perform electromagnetic emissions measurements.

### **IC (recognition number is 8510A)**

TA Technology (Shanghai) Co., Ltd. has been listed by industry Canada to perform electromagnetic emission measurement.

### **VCCI (recognition number is C-4595, T-2154, R-4113, G-766)**

TA Technology (Shanghai) Co., Ltd. has been listed by industry Japan to perform electromagnetic emission measurement.

### **A2LA (Certificate Number: 3857.01)**

TA Technology (Shanghai) Co., Ltd. has been listed by American Association for Laboratory Accreditation to perform electromagnetic emission measurement.



### 1.3 Testing Location

Company: TA Technology (Shanghai) Co., Ltd.  
Address: No.145, Jintang Rd, Tangzhen Industry Park, Pudong Shanghai, China  
City: Shanghai  
Post code: 201201  
Country: P. R. China  
Contact: Xu Kai  
Telephone: +86-021-50791141/2/3  
Fax: +86-021-50791141/2/3-8000  
Website: <http://www.ta-shanghai.com>  
E-mail: [xukai@ta-shanghai.com](mailto:xukai@ta-shanghai.com)

## 2 General Description of Equipment under Test

### 2.1 Client Information

<b>Applicant</b>	Starry, Inc.
<b>Applicant address</b>	745 Atlantic Ave Fl 8, Boston, MA, United States
<b>Manufacturer</b>	Flextronics Manufacturing(Zhuhai) Co. Ltd
<b>Manufacturer address</b>	XinQing Science&Technology Industrial Park, Doumen County.Zhuhai

### 2.2 General information

EUT Description	
Device Type:	Portable Device
Product Name:	Starry Station
Model Number:	S00111
HW Version:	1.9
SW Version:	1.0
S/N:	0010000997
Antenna Type:	Internal Antenna
Used Host Product:	PC: Model: DELL E6430(SN : 32RKWW1) printer: Model:HP BOSIB-0605-00 (SN: VNF4k35328) power line: BIZLINK 2m USB line: shield line 2m
Test Mode:	Transfer Data Mode
EUT Accessory	
power cable	185cm Cable, Manufacturer: Flextronics Manufacturing(Zhuhai) Co. Ltd
Lan cable	150cm Cable, unshielded, Manufacturer: Flextronics Manufacturing(Zhuhai) Co. Ltd
Remark: The information of the EUT is declared by the manufacturer. Please refer to the specifications or user manual for details.	



## 2.3 Applied Standards

According to the specifications of the manufacturer, it must comply with the requirements of the following standards:

### Test standards

**FCC Code CFR47 Part15B (2014)**

**ANSI C63.4 (2014)**

### 3 Test Case Results

#### 3.1 Radiated Emission

##### Ambient condition

Temperature	Relative humidity	Pressure
24°C~26°C	45%~50%	102.5kPa

##### Methods of Measurement

The EUT is placed on a non-metallic table 0.8m above the horizontal metal reference ground plane. The distance between EUT and receive antenna should be 3 meters. During the test, the EUT was operating in its typical mode. The test method is according to ANSI C63.4-2014. Sweep the whole frequency band through the range from 30MHz to the 5th harmonic of the carrier. During the test, the height of receive antenna shall be moved from 1 to 4 meters, and the antenna shall be performed under horizontal and vertical polarization. The turn table shall be rotated from 0 to 360 degrees for detecting the maximum of radiated signal level.

The data of cable loss and antenna factor has been calibrated in full testing frequency range before the testing. During the test, the EUT is worked at maximum output power.

Set the spectrum analyzer in the following:

Below 1GHz:

RBW=100 kHz / VBW=300 kHz / Sweep=AUTO

Above 1GHz:

(a) PEAK: RBW=1MHz VBW=3MHz/ Sweep=AUTO

(b) AVERAGE: RBW=1MHz / VBW=3MHz / Sweep=AUTO

During the test, EUT is connected to a laptop via a Ethernet cable in the case of Transfer Data mode. The data is transferred from EUT to PC; PC is connected to server via a long LAN cable.



## Test Setup

### Below 1GHz

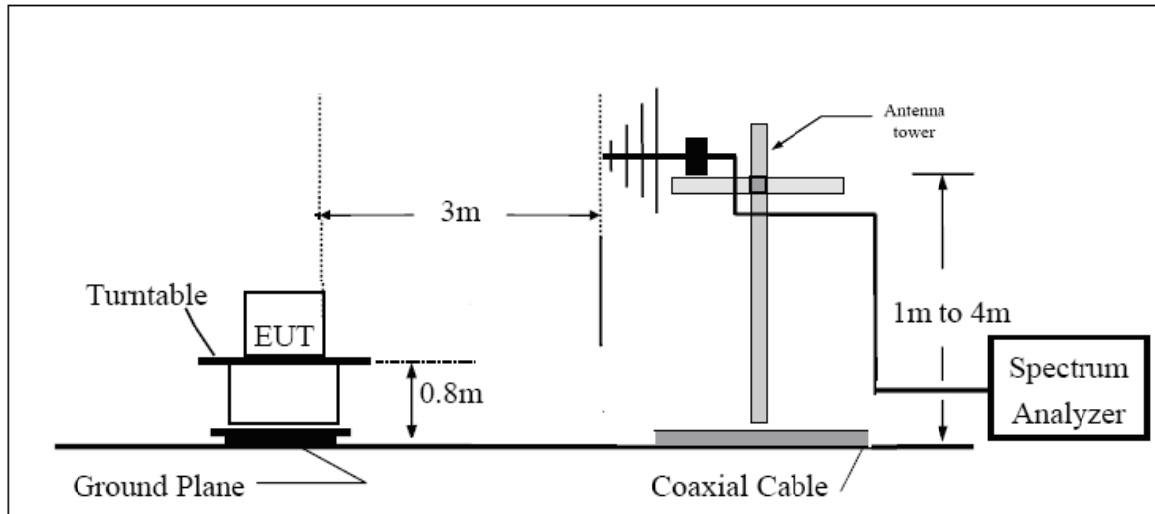

### Above 1GHz

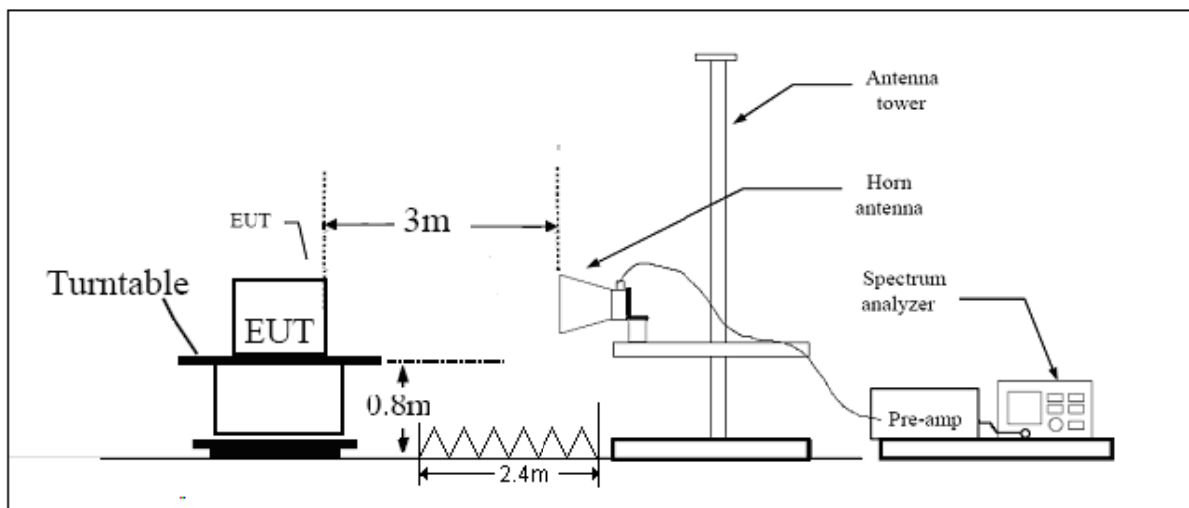

Note: Area side:2.4mX3.6m

**Limits**

Frequency (MHz)	Field Strength (dB $\mu$ V/m)	Detector
30 -88	40.0	Quasi-peak
88-216	43.5	Quasi-peak
216 – 960	46.0	Quasi-peak
960-1000	54.0	Quasi-peak
1000-5 <sup>th</sup> harmonic of the highest frequency or 40GHz, which is lower	54 74	Average Peak

**Measurement Uncertainty**

The assessed measurement uncertainty to ensure 95% confidence level for the normal distribution is with the coverage factor  $k = 1.96$ .  $U = 3.92$  dB.

**Test Results**

The messy code ( dB $\mu$ V/m ) including in the following plots mean dBuV/m.  
 The following graphs display the maximum values of horizontal and vertical by software.  
 For above 1GHz, Blue trace uses the peak detection, Green trace uses the average detection.

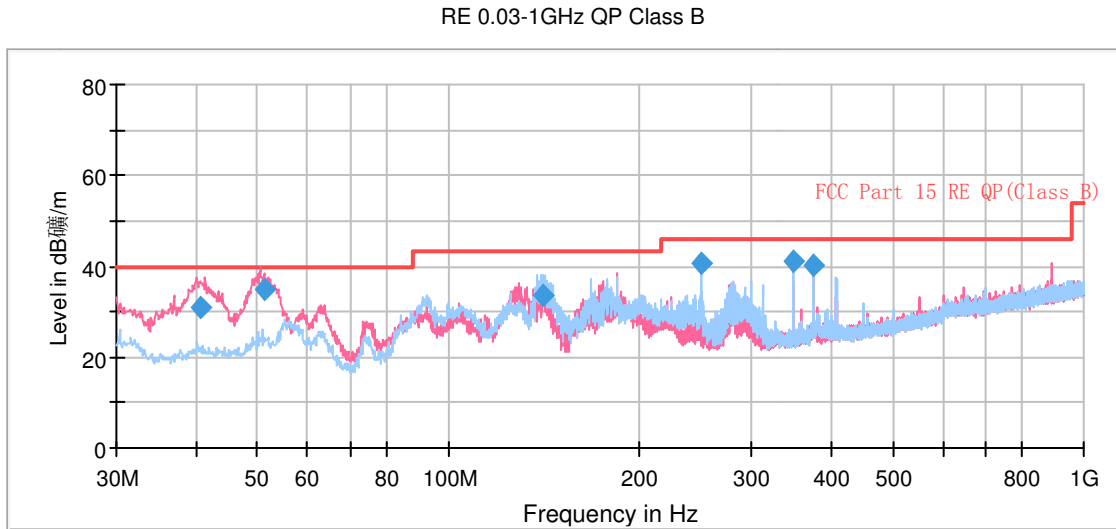

Radiated Emission from 30MHz to 1GHz

Frequency (MHz)	Quasi-Peak (dBuV/m)	Reading value (dBuV/m)	Height (cm)	Polarization	Azimuth (deg)	Correct Factor (dB)	Margin (dB)	Limit (dBuV/m)
40.585000	31.0	44.2	100.0	V	0.0	-13.2	9.0	40.0
51.172500	34.7	47.6	100.0	V	299.0	-12.9	5.3	40.0
140.381250	33.7	42.6	200.0	H	68.0	-8.9	9.8	43.5
249.987500	40.8	54.9	100.0	H	231.0	-14.1	5.2	46.0
349.978750	41.1	57.8	100.0	H	28.0	-16.7	4.9	46.0
374.996250	40.1	57.5	200.0	H	0.0	-17.4	5.9	46.0

- Remark:**
1. Quasi-Peak = Reading value + Correction factor
  2. Correction Factor = Antenna factor+ Insertion loss(cable loss+amplifier gain)
  3. Margin = Limit – Quasi-Peak

RE 1G-3GHz PK+AV

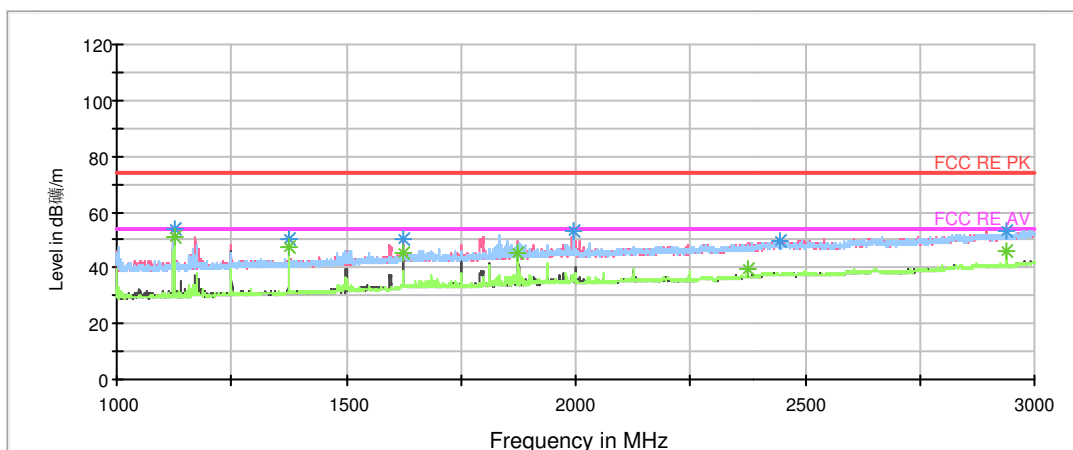

- FCC RE PK
- FCC RE AV
- Preview Result 1V-PK+
- Preview Result 2V-AVG
- Preview Result 1H-PK+
- Preview Result 2H-AVG
- \* Data Reduction Result 1 [2]-PK+
- \* Data Reduction Result 2 [2]-AVG

Radiated Emission from 1GHz to 3GHz

Frequency (MHz)	Peak (dBuV/m)	Reading value (dBuV/m)	Height (cm)	Polarization	Azimuth (deg)	Correct Factor (dB)	Margin (dB)	Limit (dBuV/m)
1124.750000	53.7	62.1	101.0	V	156.0	-8.4	20.3	74
1375.000000	50.5	57.6	101.0	V	347.0	-7.1	23.5	74
1625.000000	50.5	55.3	101.0	V	0.0	-4.8	23.5	74
1994.250000	53.2	56.4	201.0	H	0.0	-3.2	20.8	74
2444.500000	49.8	50.3	201.0	V	347.0	-0.5	24.2	74
2937.750000	53.3	55.2	201.0	H	109.0	-1.9	20.7	74

Frequency (MHz)	Average (dBuV/m)	Reading value (dBuV/m)	Height (cm)	Polarization	Azimuth (deg)	Correct Factor (dB)	Margin (dB)	Limit (dBuV/m)
1124.750000	51.0	59.4	101.0	V	156.0	-8.4	3.0	54
1374.750000	47.3	54.4	101.0	V	352.0	-7.1	6.7	54
1625.000000	45.6	50.4	101.0	V	0.0	-4.8	8.4	54
1875.000000	45.4	49.4	101.0	V	358.0	-4.0	8.6	54
2375.500000	39.7	41.2	100.0	H	327.0	-1.5	14.3	54
2937.500000	46.0	47.9	201.0	H	133.0	-1.9	8.0	54

RE 3-18GHz PK+AV

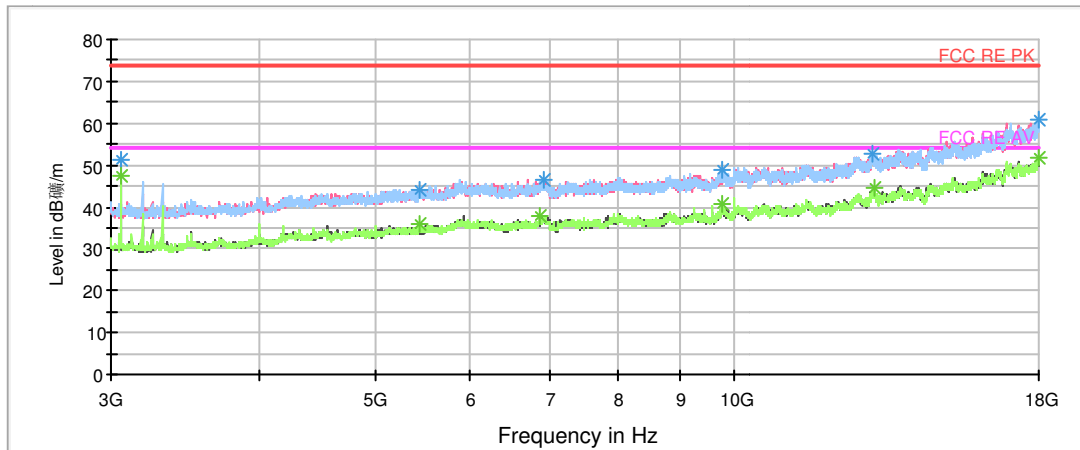

- FCC RE PK
- FCC RE AV
- Preview Result 1V-PK+
- Preview Result 2V-AVG
- Preview Result 1H-PK+
- Preview Result 2H-AVG
- \* Data Reduction Result 1 [1]-PK+
- \* Data Reduction Result 2 [1]-AVG

Radiated Emission from 3GHz to 18GHz

Frequency (MHz)	Peak (dBuV/m)	Reading value (dBuV/m)	Height (cm)	Polarization	Azimuth (deg)	Correct Factor (dB)	Margin (dB)	Limit (dBuV/m)
3061.875000	51.2	52.8	101.0	H	0.0	-1.6	22.8	74
5437.500000	44.3	48.1	200.0	H	223.0	-3.8	29.7	74
6915.000000	46.4	53.3	100.0	V	122.0	-6.9	27.6	74
9748.125000	49.0	60.6	101.0	H	100.0	-11.6	25.0	74
13076.250000	52.5	68.7	100.0	V	189.0	-16.2	21.5	74
17971.875000	60.8	85.9	200.0	V	6.0	-25.1	13.2	74

Frequency (MHz)	Average (dBuV/m)	Reading value (dBuV/m)	Height (cm)	Polarization	Azimuth (deg)	Correct Factor (dB)	Margin (dB)	Limit (dBuV/m)
3061.875000	47.2	48.8	101.0	H	0.0	-1.6	6.8	54
5437.500000	36.0	39.8	200.0	H	223.0	-3.8	18.0	54
6873.750000	37.9	44.7	200.0	V	63.0	-6.8	16.1	54
9748.125000	40.9	52.5	101.0	H	100.0	-11.6	13.1	54
13087.500000	44.4	60.6	200.0	H	291.0	-16.2	9.6	54
17998.125000	51.9	77.3	200.0	H	223.0	-25.4	2.1	54

RE 18-26.5GHz PK+AV

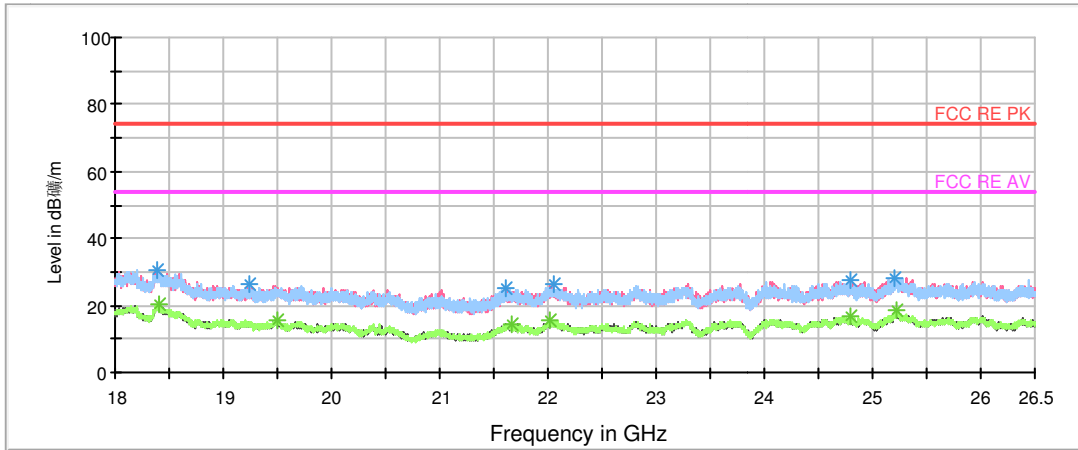

- FCC RE PK
- FCC RE AV
- Preview Result 1V-PK+
- Preview Result 2V-AVG
- Preview Result 1H-PK+
- Preview Result 2H-AVG
- \* Data Reduction Result 1 [1]-PK+
- \* Data Reduction Result 2 [1]-AVG

Radiated Emission from 18GHz to 26.5GHz

Frequency (MHz)	Peak (dBuV/m)	Reading value (dBuV/m)	Polarization	Azimuth (deg)	Correct Factor (dB)	Margin (dB)	Limit (dBuV/m)
18401.625000	27.8	32.7	V	0.0	-4.9	46.2	74
19497.062500	23.6	31.1	H	0.0	-7.5	50.4	74
21658.187500	23.7	32.9	H	0.0	-9.2	50.3	74
22022.625000	24.1	32.1	H	0.0	-8.0	49.9	74
24789.375000	27.6	34.4	H	0.0	-6.8	46.4	74
25218.625000	27.5	33.5	H	0.0	-6.0	46.5	74

Frequency (MHz)	Average (dBuV/m)	Reading value (dBuV/m)	Polarization	Azimuth (deg)	Correct Factor (dB)	Margin (dB)	Limit (dBuV/m)
18401.625000	20.3	25.2	V	0.0	-4.9	33.7	54
19497.062500	15.6	23.1	H	0.0	-7.5	38.4	54
21658.187500	14.3	23.5	H	0.0	-9.2	39.7	54
22022.625000	15.3	23.3	H	0.0	-8.0	38.7	54
24789.375000	16.4	23.2	H	0.0	-6.8	37.6	54
25218.625000	18.3	24.3	H	0.0	-6.0	35.7	54

### 3.2 Conducted Emission

#### Ambient condition

Temperature	Relative humidity	Pressure
24°C ~26°C	50%~55%	102.5kPa

#### Methods of Measurement

The EUT is placed on a non-metallic table of 80cm height above the horizontal metal reference ground plane. During the test, the EUT was operating in its typical mode. The test method is according to ANSI C63.4-2014. Connect the AC power line of the EUT to the L.I.S.N. Use EMI receiver to detect the average and Quasi-peak value. RBW is set to 9 kHz, VBW is set to 30kHz. The measurement result should include both L line and N line.

During the test, EUT is connected to a laptop via a Ethernet cable in the case of Transfer Data mode. The data is transferred from EUT to PC; PC is connected to server via a long LAN cable.

#### Test Setup

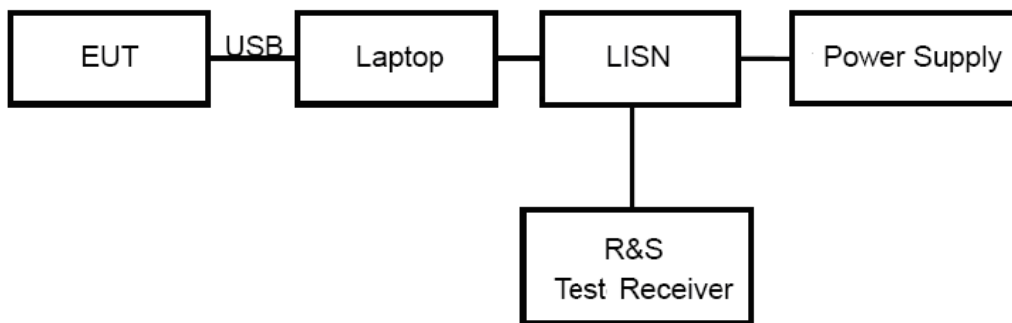

Note: Power Supply is AC Power source and it is used to change the voltage 120V/60Hz.

#### Limits

Frequency (MHz)	Conducted Limits(dBµV)	
	Quasi-peak	Average
0.15 - 0.5	66 to 56 *	56 to 46 *
0.5 - 5	56	46
5 - 30	60	50

\*: Decreases with the logarithm of the frequency.

#### Measurement Uncertainty

The assessed measurement uncertainty to ensure 95% confidence level for the normal distribution is with the coverage factor  $k = 1.96$ .  $U = 2.69$  dB.

### Test Results

Following plots, Blue trace uses the peak detection; Green trace uses the average detection.

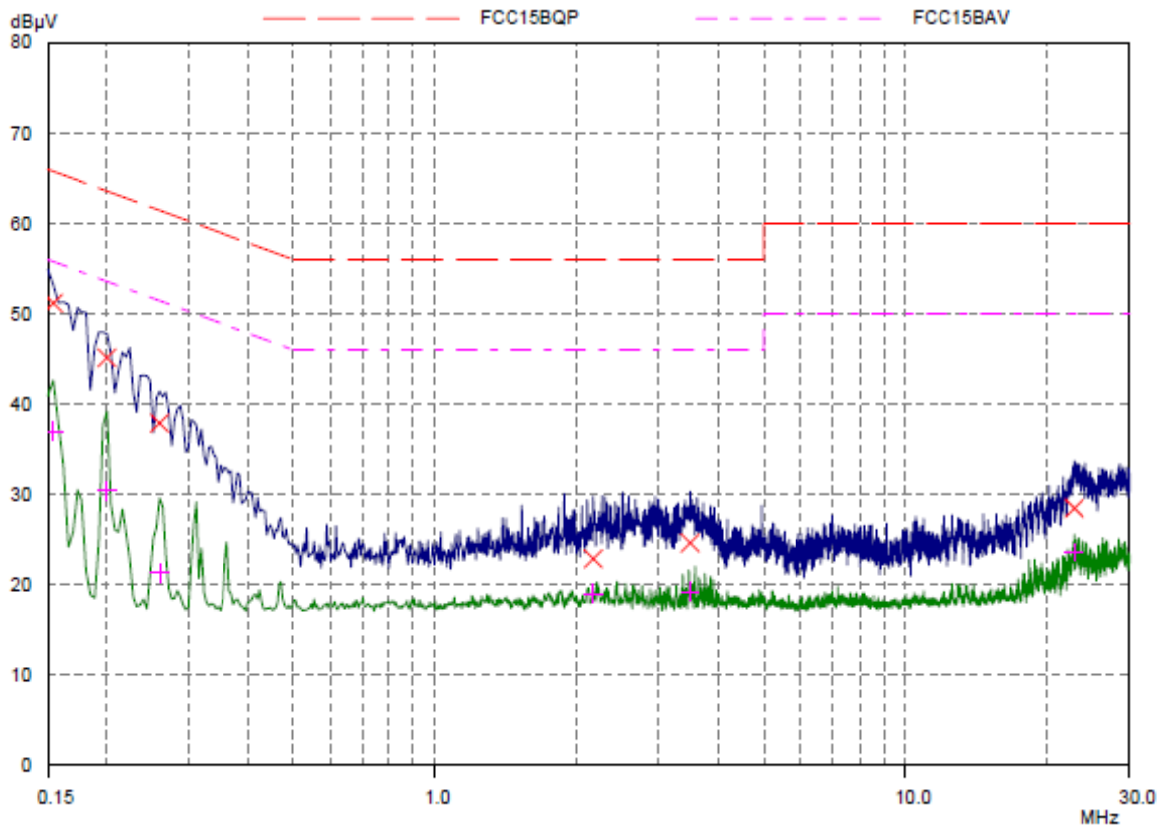

Final Measurement Results

Frequency MHz	QP Level dBµV	QP Limit dBµV	QP Delta dB	Phase	PE
0.1539	51.18	65.79	14.61	L1	gnd
0.20078	45.12	63.58	18.46	L1	gnd
0.25937	37.89	61.45	23.56	L1	gnd
2.18953	22.88	56.00	33.12	L1	gnd
3.49375	24.61	56.00	31.39	L1	gnd
22.89218	28.46	60.00	31.54	L1	gnd

Frequency MHz	AV Level dBµV	AV Limit dBµV	AV Delta dB	Phase	PE
0.1539	36.95	55.79	18.84	L1	gnd
0.20078	30.43	53.58	23.15	L1	gnd
0.25937	21.30	51.45	30.15	L1	gnd
2.18953	19.00	46.00	27.00	L1	gnd
3.49375	19.25	46.00	26.75	L1	gnd
22.89218	23.60	50.00	26.40	L1	gnd

L line

Conducted Emission from 150 KHz to 30 MHz



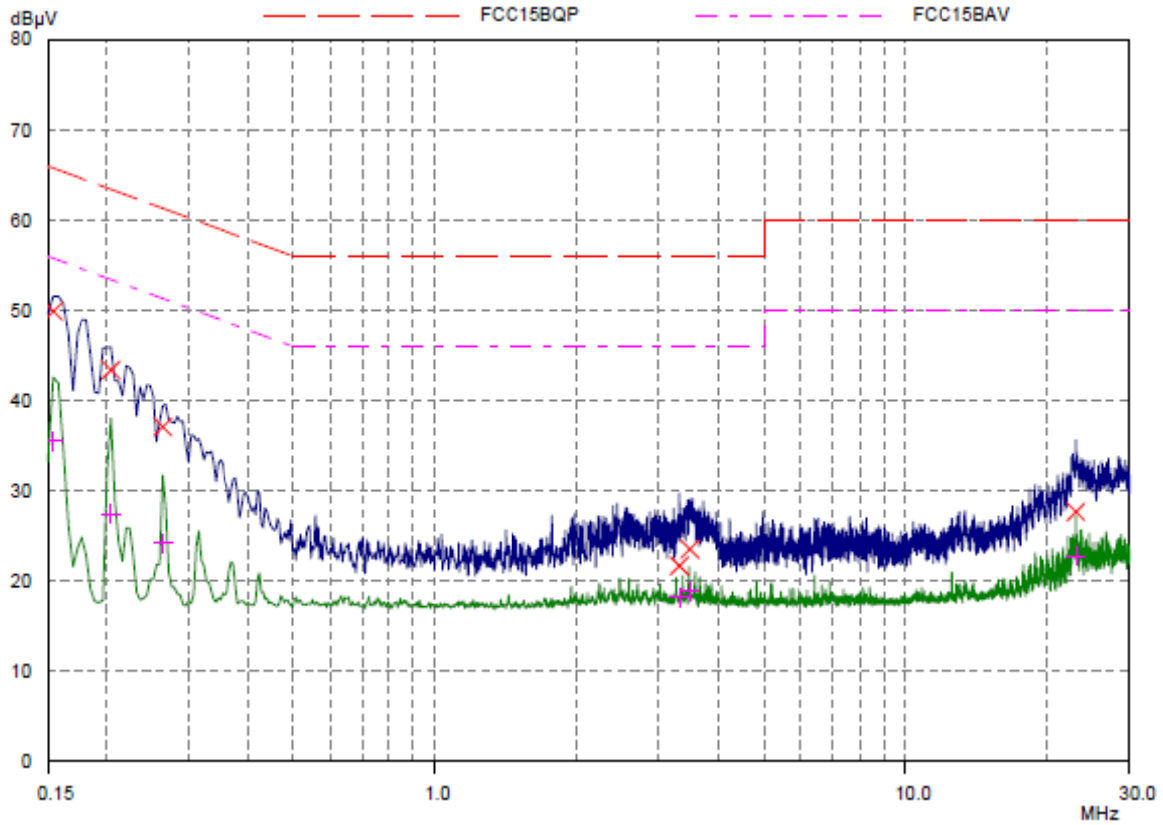

Final Measurement Results

Frequency MHz	QP Level dBµV	QP Limit dBµV	QP Delta dB	Phase	PE
0.1539	49.90	65.79	15.89	N	gnd
0.20468	43.38	63.42	20.04	N	gnd
0.26328	37.09	61.33	24.24	N	gnd
3.31406	21.68	56.00	34.32	N	gnd
3.48984	23.53	56.00	32.47	N	gnd
23.06015	27.66	60.00	32.34	N	gnd

Frequency MHz	AV Level dBµV	AV Limit dBµV	AV Delta dB	Phase	PE
0.1539	35.52	55.79	20.27	N	gnd
0.20468	27.47	53.42	25.95	N	gnd
0.26328	24.22	51.33	27.11	N	gnd
3.31406	18.17	46.00	27.83	N	gnd
3.48984	18.88	46.00	27.12	N	gnd
23.06015	22.75	50.00	27.25	N	gnd

N line  
 Conducted Emission from 150 KHz to 30 MHz

## 4 Main Test Equipment

Name	Type	Manufacturer	Serial Number	Last Cal.	Cal. Due Date
EMI Test Receiver	ESCI	R&S	100948	2015-05-22	2016-05-21
Signal Analyzer	FSV30	R&S	100815	2015-12-17	2016-12-16
Trilog Antenna	VULB 9163	SCHWARZBECK	9163-201	2014-12-06	2017-12-05
Horn Antenna	HF907	R&S	100126	2014-12-06	2017-12-05
Horn Antenna	3160-09	ETS-Lindgren	00102643	2015-01-30	2018-01-29
EMI Test Receiver	ESCS30	R&S	100138	2015-12-17	2016-12-16
LISN	ENV216	R&S	101171	2013-12-18	2016-12-17

## ANNEX A: The EUT Appearance and Test Configuration

### A.1 EUT Appearance

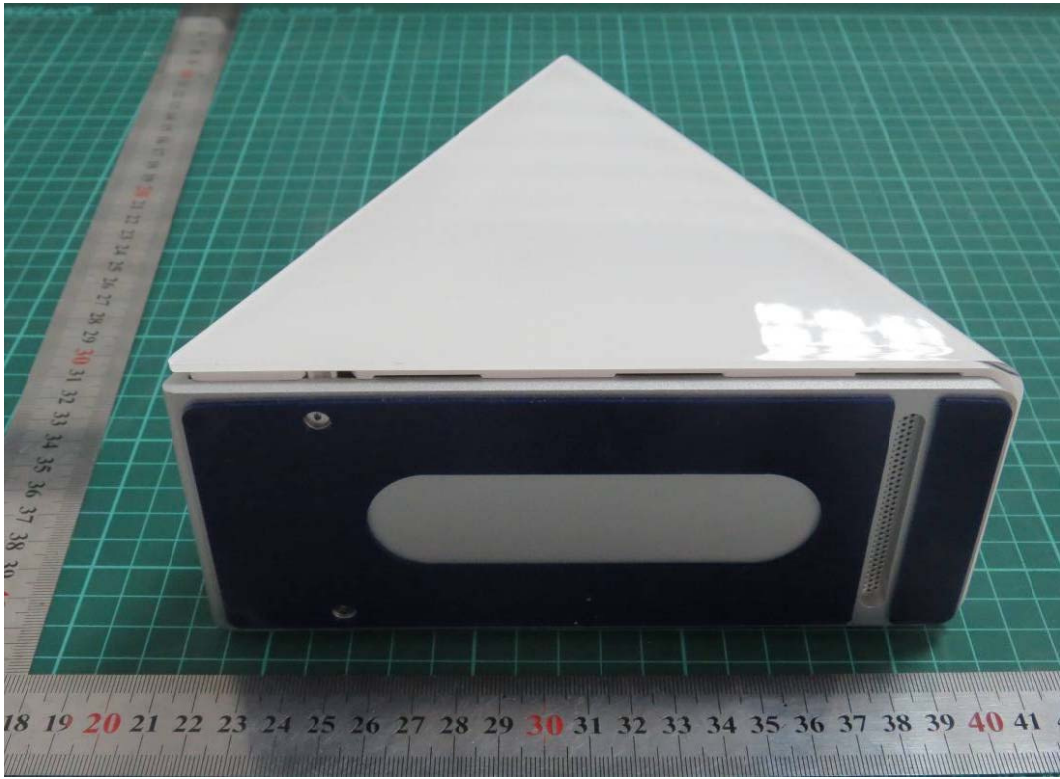

Front Side



Left Side & Right Side  
a: EUT



b: power cable



c: Lan cable

Picture 1 EUT



## A.2 Test Setup



a: Below 1GHz



b: Above 1GHz

**Picture 2 Radiated Emission Test Setup**



**Picture 3 Conducted Emission Test Setup**

### A.3 Host Product

