



# TEST REPORT

**Report Reference No.**..... : **TRE1707019301** R/C.....: 51182

**FCC ID**..... : **2AGY3BHS950**

**Applicant's name**..... : **DAGUI TECHNOLOGY (SHENZHEN) CO.,LTD.**

**Address**..... : 28h,1unit,5th period,Xinghai Building, the intersection of Shennan Road and Qianhai Road,Nanshan District,Shenzhen, Guangdong, China

**Manufacturer**..... : DAGUI TECHNOLOGY (SHENZHEN) CO.,LTD.

**Address**..... : 28h,1unit,5th period,Xinghai Building, the intersection of Shennan Road and Qianhai Road,Nanshan District,Shenzhen, Guangdong, China

**Test item description** ..... : **Bluetooth Headset**

**Trade Mark** ..... : Phaiser

**Model/Type reference**..... : BHS-950

**Listed Model(s)** ..... : -

**Standard** ..... : **FCC CFR Title 47 Part 15 Subpart C Section 15.247**

**Date of receipt of test sample**..... : Jul. 21, 2017

**Date of testing**..... : Jul. 22, 2017 - Aug. 08, 2017

**Date of issue**..... : Aug. 09, 2017

**Result**..... : **PASS**

Compiled by  
( position+printedname+signature)....: File administrators Becky Liang

Supervised by  
(position+printedname+signature)....: Project Engineer Jeff Sun

Approved by  
(position+printedname+signature)....: RF Manager Hans Hu

**Testing Laboratory Name** ..... : **Shenzhen Huatongwei International Inspection Co., Ltd.**

**Address**..... : 1/F, Bldg 3, Hongfa Hi-tech Industrial Park, Genyu Road, Tianliao, Gongming, Shenzhen, China

**Shenzhen Huatongwei International Inspection Co., Ltd. All rights reserved.**

This publication may be reproduced in whole or in part for non-commercial purposes as long as the Shenzhen Huatongwei International Inspection Co., Ltd. is acknowledged as copyright owner and source of the material. Shenzhen Huatongwei International Inspection Co., Ltd. takes no responsibility for and will not assume liability for damages resulting from the reader's interpretation of the reproduced material due to its placement and context.

## Contents

<b>1.</b>	<b><u>TEST STANDARDS AND REPORT VERSION</u></b>	<b>3</b>
1.1.	Test Standards	3
1.2.	Report version	3
<b>2.</b>	<b><u>TEST DESCRIPTION</u></b>	<b>4</b>
<b>3.</b>	<b><u>SUMMARY</u></b>	<b>5</b>
3.1.	Client Information	5
3.2.	Product Description	5
3.3.	Operation state	6
3.4.	EUT configuration	6
3.5.	Modifications	6
<b>4.</b>	<b><u>TEST ENVIRONMENT</u></b>	<b>7</b>
4.1.	Address of the test laboratory	7
4.2.	Test Facility	7
4.3.	Environmental conditions	8
4.4.	Statement of the measurement uncertainty	8
4.5.	Equipments Used during the Test	9
<b>5.</b>	<b><u>TEST CONDITIONS AND RESULTS</u></b>	<b>10</b>
5.1.	Antenna requirement	10
5.2.	Conducted Emission (AC Main)	11
5.3.	Conducted Peak Output Power	14
5.4.	20dB Emission Bandwidth	17
5.5.	Carrier Frequencies Separation	20
5.6.	Hopping Channel Number	22
5.7.	Dwell Time	24
5.8.	Pseudorandom Frequency Hopping Sequence	27
5.9.	Restricted band (radiated)	28
5.10.	Bandedge and Spurious Emission (conducted)	30
5.11.	Spurious Emissions (radiated)	34
<b>6.</b>	<b><u>TEST SETUP PHOTOS OF THE EUT</u></b>	<b>38</b>
<b>7.</b>	<b><u>EXTERNAL AND INTERNAL PHOTOS OF THE EUT</u></b>	<b>40</b>

## 1. TEST STANDARDS AND REPORT VERSION

### 1.1. Test Standards

The tests were performed according to following standards:

[FCC Rules Part 15.247](#): Frequency Hopping, Direct Spread Spectrum and Hybrid Systems that are in operation within the bands of 902-928 MHz, 2400-2483.5 MHz, and 5725-5850 MHz.

[ANSI C63.10-2013](#): American National Standard for Testing Unlicensed Wireless Devices

### 1.2. Report version

Version No.	Date of issue	Description
00	Aug. 09, 2017	Original

## 2. TEST DESCRIPTION

Test Item	Section in CFR 47	Result
Antenna Requirement	15.203/15.247 (c)	Pass
AC Power Line Conducted Emissions	15.207	Pass
Conducted Peak Output Power	15.247 (b)(1)	Pass
20dB Occupied Bandwidth	15.247 (a)(1)	Pass
Carrier Frequencies Separation	15.247 (a)(1)	Pass
Hopping Channel Number	15.247 (a)(1)	Pass
Dwell Time	15.247 (a)(1)	Pass
Pseudorandom Frequency Hopping Sequence	15.247(b)(4)&TCB Exclusion List (7 July 2002)	Pass
Restricted band	15.247(d)/15.205	Pass
Radiated Emissions	15.247(d)/15.209	Pass

Note: The measurement uncertainty is not included in the test result.

### 3. SUMMARY

#### 3.1. Client Information

Applicant:	DAGUI TECHNOLOGY (SHENZHEN) CO.,LTD.
Address:	28h,1unit,5th period,Xinghai Building, the intersection of Shennan Road and Qianhai Road,Nanshan District,Shenzhen, Guangdong, China
Manufacturer:	DAGUI TECHNOLOGY (SHENZHEN) CO.,LTD.
Address:	28h,1unit,5th period,Xinghai Building, the intersection of Shennan Road and Qianhai Road,Nanshan District,Shenzhen, Guangdong, China

#### 3.2. Product Description

Name of EUT:	Bluetooth Headset
Trade Mark:	Phaiser
Model/Type reference:	BHS-950
Listed Model(s):	-
Power supply:	3.7Vd.c. from internal battery & charging input 5.0Vd.c. from USB port
Adapter information:	-
Hardware version:	2.0
Software version:	1.0
<b>Bluetooth</b>	
Version:	Supported BT4.1+EDR
Modulation:	GFSK, $\pi/4$ DQPSK, 8DPSK
Operation frequency:	2402MHz~2480MHz
Channel number:	79
Channel separation:	1MHz
Antenna type:	Integral Antenna
Antenna gain:	1.20 dBi

### 3.3. Operation state

#### ➤ Test frequency list

According to section 15.31(m), regards to the operating frequency range over 10 MHz, must select three channel which were tested. the Lowest frequency, the middle frequency, and the highest frequency of channel were selected to perform the test, please see the above gray bottom.

Channel	Frequency (MHz)
0	2402
1	2403
:	:
39	2441
:	:
77	2479
78	2480

#### ➤ Test mode

For RF test items
The engineering test program was provided and enabled to make EUT continuous transmit.
For AC power line conducted emissions:
The EUT was set to connect with the Bluetooth under large package sizes transmission.
For RF test axis
EUT in each of three orthogonal axis emissions had been tested ,but only the worst case (X axis) data Recorded in the report.

### 3.4. EUT configuration

The following peripheral devices and interface cables were connected during the measurement:

- - supplied by the manufacturer
- - supplied by the lab

○	Adapter	Manufacturer :	lenovo
		Model No. :	C-P30
		Manufacturer :	/
		Model No. :	/

### 3.5. Modifications

No modifications were implemented to meet testing criteria.

## **4. Test Environment**

### **4.1. Address of the test laboratory**

Laboratory: Shenzhen Huatongwei International Inspection Co., Ltd.

Address: 1/F, Bldg 3, Hongfa Hi-tech Industrial Park, Genyu Road, Tianliao, Gongming, Shenzhen, China

Phone: 86-755-26748019 Fax: 86-755-26748089

### **4.2. Test Facility**

The test facility is recognized, certified, or accredited by the following organizations:

#### **CNAS-Lab Code: L1225**

Shenzhen Huatongwei International Inspection Co., Ltd. has been assessed and proved to be in compliance with CNAS-CL01 Accreditation Criteria for Testing and Calibration Laboratories (identical to ISO/IEC17025: 2005 General Requirements) for the Competence of Testing and Calibration Laboratories.

#### **A2LA-Lab Cert. No. 3902.01**

Shenzhen Huatongwei International Inspection Co., Ltd. EMC Laboratory has been accredited by A2LA for technical competence in the field of electrical testing, and proved to be in compliance with ISO/IEC 17025: 2005 General Requirements for the Competence of Testing and Calibration Laboratories and any additional program requirements in the identified field of testing.

#### **FCC-Registration No.: 762235**

Shenzhen Huatongwei International Inspection Co., Ltd. EMC Laboratory has been registered and fully described in a report filed with the FCC (Federal Communications Commission). The acceptance letter from the FCC is maintained in our files. Registration 762235.

#### **IC-Registration No.: 5377B-1**

Two 3m Alternate Test Site of Shenzhen Huatongwei International Inspection Co., Ltd. has been registered by Certification and Engineering Bureau of Industry Canada for the performance of radiated measurements with Registration No. 5377B-1.

#### **ACA**

Shenzhen Huatongwei International Inspection Co., Ltd. EMC Laboratory can also perform testing for the Australian C-Tick mark as a result of our A2LA accreditation.

### 4.3. Environmental conditions

During the measurement the environmental conditions were within the listed ranges:

Temperature:	15~35°C
Relative Humidity:	30~60 %
Air Pressure:	950~1050mbar

### 4.4. Statement of the measurement uncertainty

The data and results referenced in this document are true and accurate. The reader is cautioned that there may be errors in calibration limits of the equipment and facilities. The measurement uncertainty was calculated for all measurements listed in this test report according to TR-100028-01 "Electromagnetic compatibility and Radio spectrum Matters (ERM); Uncertainties in the measurement of mobile radio equipment characteristics; Part 1" and TR-100028-02 "Electromagnetic compatibility and Radio spectrum Matters (ERM); Uncertainties in the measurement of mobile radio equipment characteristics; Part 2" and is documented in the Shenzhen Huatongwei International Inspection Co., Ltd quality system according to ISO/IEC 17025. Further more, component and process variability of devices similar to that tested may result in additional deviation. The manufacturer has the sole responsibility of continued compliance of the device.

Here after the best measurement capability for Shenzhen Huatongwei is reported:

Test Items	Measurement Uncertainty	Notes
Transmitter power conducted	0.57 dB	(1)
Transmitter power Radiated	2.20 dB	(1)
Conducted spurious emissions 9KHz-40 GHz	1.60 dB	(1)
Radiated spurious emissions 9KHz-40 GHz	2.20 dB	(1)
Conducted Emissions 9KHz-30MHz	3.39 dB	(1)
Radiated Emissions 30~1000MHz	4.24 dB	(1)
Radiated Emissions 1~18GHz	5.16 dB	(1)
Radiated Emissions 18-40GHz	5.54 dB	(1)
Occupied Bandwidth	-----	(1)

(1) This uncertainty represents an expanded uncertainty expressed at approximately the 95% confidence level using a coverage factor of k=1.96.



#### 4.5. Equipments Used during the Test

Line Conducted Emissions (AC Main)					
Item	Test Equipment	Manufacturer	Model No.	Serial No.	Last Cal.
1	EMI Test Receiver	R&S	ESCI	101247	2016/11/13
2	Artificial Mains	Shwarzbeck	NNLK 8121	573	2016/11/13
3	Pulse Limiter	R&S	ESH3-Z2	101488	2016/11/13
4	Test Software	R&S	ES-K1	N/A	N/A
5	Test cable	ENVIROFLEX	3651	1101902	2016/11/13

Maximum Peak Output Power / Power Spectral Density / 6dB Bandwidth / Band Edge Compliance of RF Emissions / Spurious RF Conducted Emissions					
Item	Test Equipment	Manufacturer	Model No.	Serial No.	Last Cal
1	Spectrum Analyzer	Rohde&Schwarz	FSP	1164.4391.40	2016/11/13
2	Power Meter	Anritsu	ML2480B	100798	2016/11/13
3	Power Sensor	Anritsu	MA2411B	100258	2016/11/13
4	Test cable	FARPU	MCX-J	N/A	2016/11/13
5	Temporary antenna connector	D-LENP	NJ-SMAK	N/A	2016/11/13

NOTE: The temporary antenna connector is soldered on the PCB board in order to perform conducted tests and this temporary antenna connector is listed in the equipment list.

Radiated Emissions					
Item	Test Equipment	Manufacturer	Model No.	Serial No.	Last Cal.
1	EMI Test Receiver	Rohde&Schwarz	ESI 26	100009	2016/11/13
2	RF Test Panel	Rohde&Schwarz	TS / RSP	335015/ 0017	N/A
3	EMI Test Software	Rohde&Schwarz	ESK1	N/A	N/A
4	Loop Antenna	Rohde&Schwarz	HZ-9	838622\013	2016/11/13
5	Ultra-Broadband Antenna	ShwarzBeck	VULB9163	538	2016/11/13
6	Horn Antenna	ShwarzBeck	9120D	1011	2016/11/13
7	Broadband Horn Antenna	Shwarzbeck	BBHA9170	BBHA917047 2	2016/11/13
8	Preamplifier	Shwarzbeck	BBV9742	9742-196	2016/11/13
9	Broadband Preamplifier	Shwarzbeck	BBV 9721	9721-102	2016/11/13
10	Broadband Preamplifier	Shwarzbeck	BBV 9718	9718-247	2016/11/13
11	Turn Table	MATURO	TT2.0	/	N/A
12	Antenna Mast	MATURO	TAM-4.0-P	/	N/A
13	EMI Test Software	Audix	E3	N/A	N/A
14	Test Software	R&S	ES-K1	N/A	N/A
15	Test cable	Siva Cables Italy	RG 58A/U	W14.02	2016/11/13

The Cal.Interval was one year.

## 5. TEST CONDITIONS AND RESULTS

### 5.1. Antenna requirement

#### Requirement

##### **FCC CFR Title 47 Part 15 Subpart C Section 15.203:**

An intentional radiator shall be designed to ensure that no antenna other than that furnished by the responsible party shall be used with the device. The use of a permanently attached antenna or of an antenna that uses a unique coupling to the intentional radiator, the manufacturer may design the unit so that a broken antenna can be replaced by the user, but the use of a standard antenna jack or electrical connector is prohibited.

##### **FCC CFR Title 47 Part 15 Subpart C Section 15.247(c) (1)(i):**

(i) Systems operating in the 2400-2483.5 MHz band that is used exclusively for fixed. Point-to-point operations may employ transmitting antennas with directional gain greater than 6dBi provided the maximum conducted output power of the intentional radiator is reduced by 1 dB for every 3 dB that the directional gain of the antenna exceeds 6dBi.

#### TEST RESULTS

**Passed**       **Not Applicable**

The directional gain of the antenna less than 6 dBi, please refer to the below antenna photo.

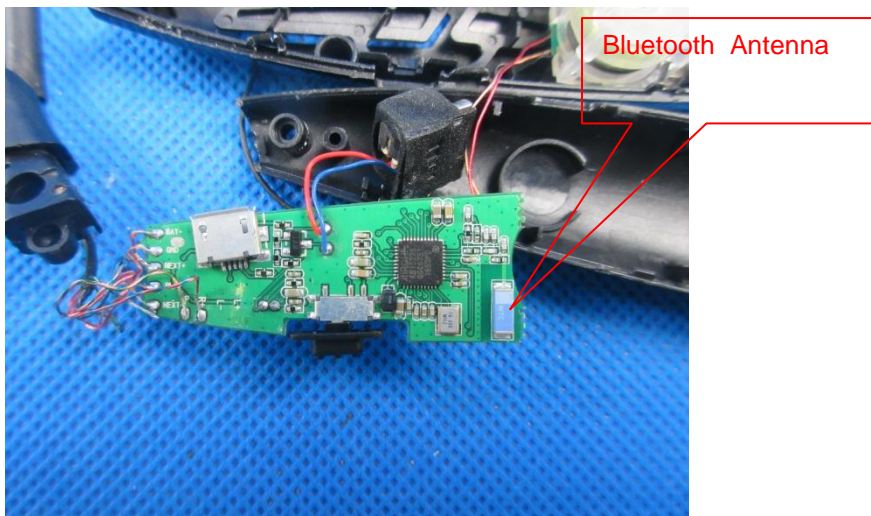

## 5.2. Conducted Emission (AC Main)

### LIMIT

FCC CFR Title 47 Part 15 Subpart C Section 15.207:

Frequency range (MHz)	Limit (dBuV)	
	Quasi-peak	Average
0.15-0.5	66 to 56*	56 to 46*
0.5-5	56	46
5-30	60	50

\* Decreases with the logarithm of the frequency.

### TEST CONFIGURATION

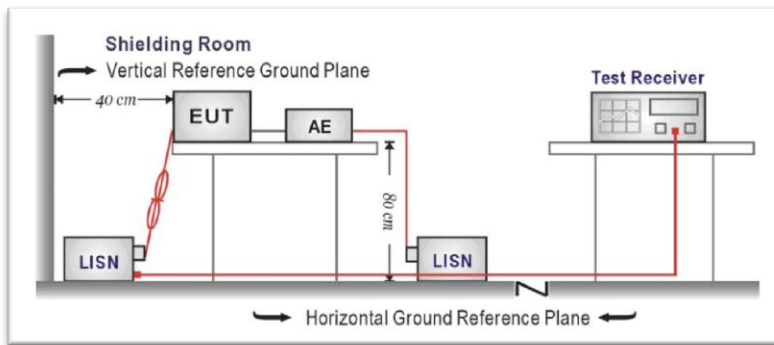

### TEST PROCEDURE

1. The EUT was setup according to ANSI C63.10:2013 for compliance to FCC 47CFR 15.247 requirements.
2. The EUT was placed on a platform of nominal size, 1 m by 1.5 m, raised 80 cm above the conducting ground plane. The vertical conducting plane was located 40 cm to the rear of the EUT. All other surfaces of EUT were at least 80 cm from any other grounded conducting surface.
3. The EUT and simulators are connected to the main power through a line impedances tabilization network (LISN). The LISN provides a 50 ohm /50uH coupling impedance for the measuring equipment.
4. The peripheral devices are also connected to the main power through a LISN. (Please refer to the block diagram of the test setup and photographs)
5. Each current-carrying conductor of the EUT power cord, except the ground (safety) conductor, was individually connected through a LISN to the input power source.
6. The excess length of the power cord between the EUT and the LISN receptacle were folded back and forth at the center of the lead to form a bundle not exceeding 40 cm in length.
7. Conducted emissions were investigated over the frequency range from 0.15MHz to 30MHz using a receiver bandwidth of 9 kHz.
8. During the above scans, the emissions were maximized by cable manipulation.
- 9.

### TEST MODE:

Please refer to the clause 3.3

### TEST RESULTS

Passed       Not Applicable

Note:

- 1) Transd=Cable lose+Pulse Limiter Factor + Artificial Mains Factor
- 2) Margin= Limit -Level

Test Line:

L

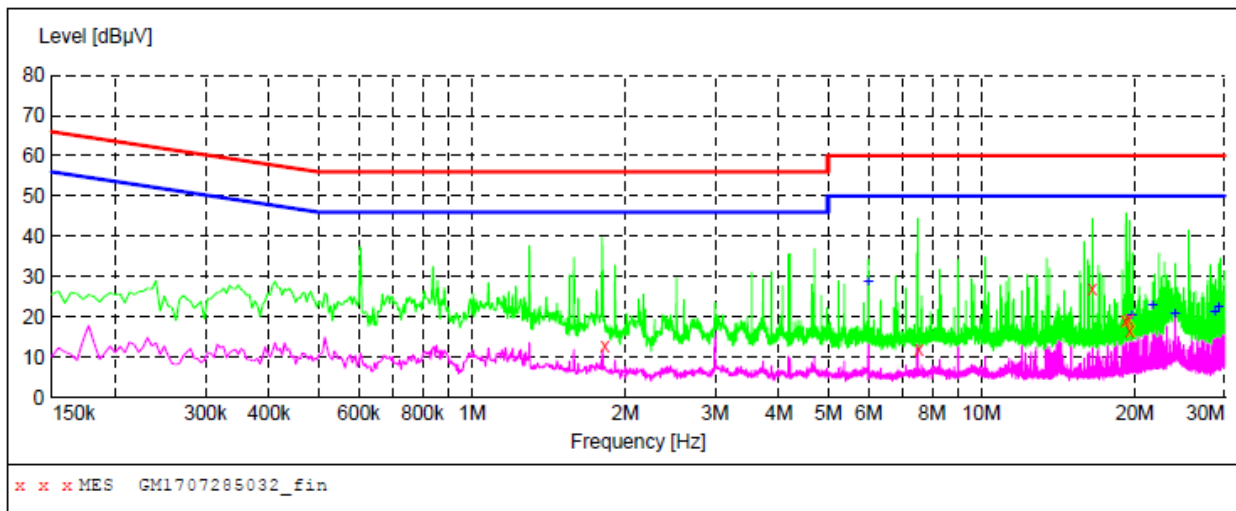

Frequency MHz	Level dBµV	Transd dB	Limit dBµV	Margin dB	Detector	Line	PE
1.824000	12.90	10.2	56	43.1	QP	L1	GND
7.543500	11.80	10.4	60	48.2	QP	L1	GND
16.498500	27.10	10.5	60	32.9	QP	L1	GND
19.158000	19.20	10.5	60	40.8	QP	L1	GND
19.464000	19.40	10.5	60	40.6	QP	L1	GND
19.554000	16.70	10.5	60	43.3	QP	L1	GND

Frequency MHz	Level dBµV	Transd dB	Limit dBµV	Margin dB	Detector	Line	PE
6.000000	28.60	10.3	50	21.4	AV	L1	GND
19.707000	20.40	10.5	50	29.6	AV	L1	GND
21.660000	22.70	10.6	50	27.3	AV	L1	GND
24.000000	20.70	10.7	50	29.3	AV	L1	GND
28.684500	21.10	10.8	50	28.9	AV	L1	GND
29.233500	22.30	10.8	50	27.7	AV	L1	GND

Test Line:

N

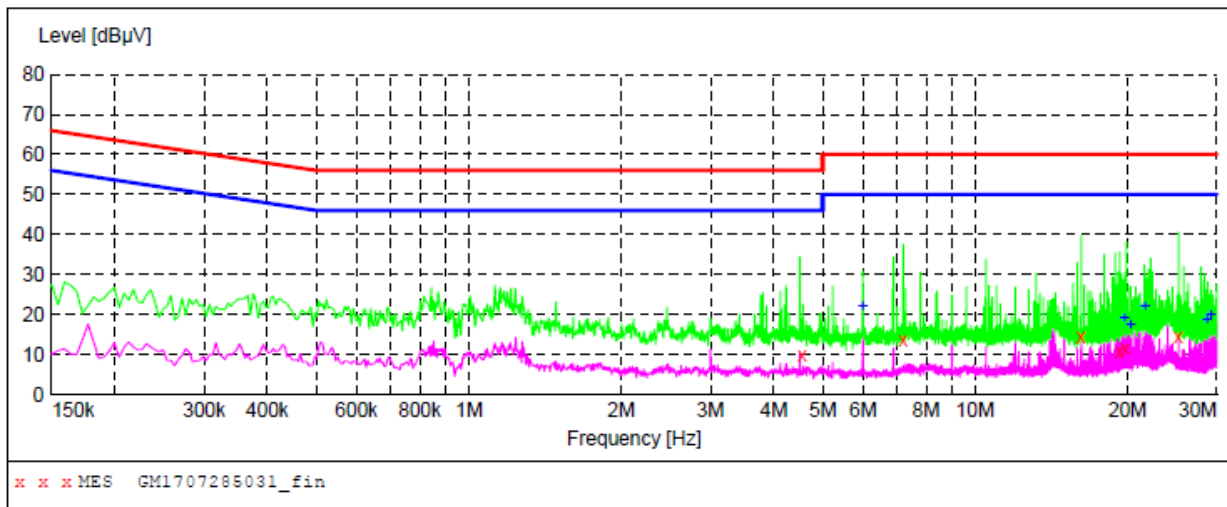

Frequency MHz	Level dBµV	Transd dB	Limit dBµV	Margin dB	Detector	Line	PE
4.551000	9.90	10.3	56	46.1	QP	N	GND
7.206000	13.50	10.3	60	46.5	QP	N	GND
16.170000	14.30	10.5	60	45.7	QP	N	GND
19.306500	10.80	10.5	60	49.2	QP	N	GND
19.873500	11.40	10.5	60	48.6	QP	N	GND
25.170000	14.40	10.7	60	45.6	QP	N	GND

Frequency MHz	Level dBµV	Transd dB	Limit dBµV	Margin dB	Detector	Line	PE
6.000000	22.10	10.3	50	27.9	AV	N	GND
19.707000	18.90	10.5	50	31.1	AV	N	GND
20.256000	17.30	10.6	50	32.7	AV	N	GND
21.660000	21.90	10.6	50	28.1	AV	N	GND
28.684500	18.70	10.8	50	31.3	AV	N	GND
29.233500	19.70	10.8	50	30.3	AV	N	GND

### 5.3. Conducted Peak Output Power

**LIMIT**

FCC CFR Title 47 Part 15 Subpart C Section 15.247 (b)(3): **30dBm**

**TEST CONFIGURATION**

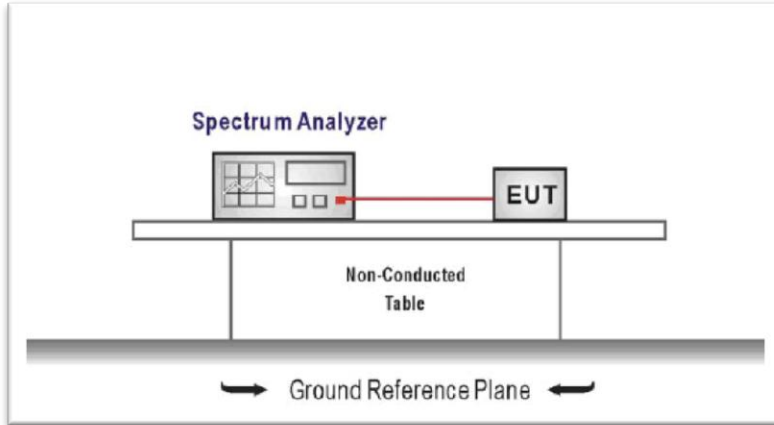

**TEST PROCEDURE**

1. The transmitter output was connected to the spectrum analyzer through an attenuator, the pathloss was compensated to the results for each measurement.
2. Set to the maximum power setting and enable the EUT transmit continuously
3. Use the following spectrum analyzer settings:  
 Span = approximately 5 times the 20 dB bandwidth, centered on a hopping channel  
 RBW ≥ the 20 dB bandwidth of the emission being measured, VBW ≥ RBW  
 Sweep = auto, Detector function = peak, Trace = max hold
4. Measure and record the results in the test report.

**TEST MODE:**

Please refer to the clause 3.3

**TEST RESULTS**

**Passed**       **Not Applicable**

Modulation type	Channel	Output power (dBm)	Limit (dBm)	Result
GFSK	00	-4.55	30.00	Pass
	39	-2.95		
	78	-1.26		
π/4DQPSK	00	-5.03	21.00	Pass
	39	-3.35		
	78	-1.70		
8DPSK	00	-4.93	21.00	Pass
	39	-4.20		
	78	-3.18		

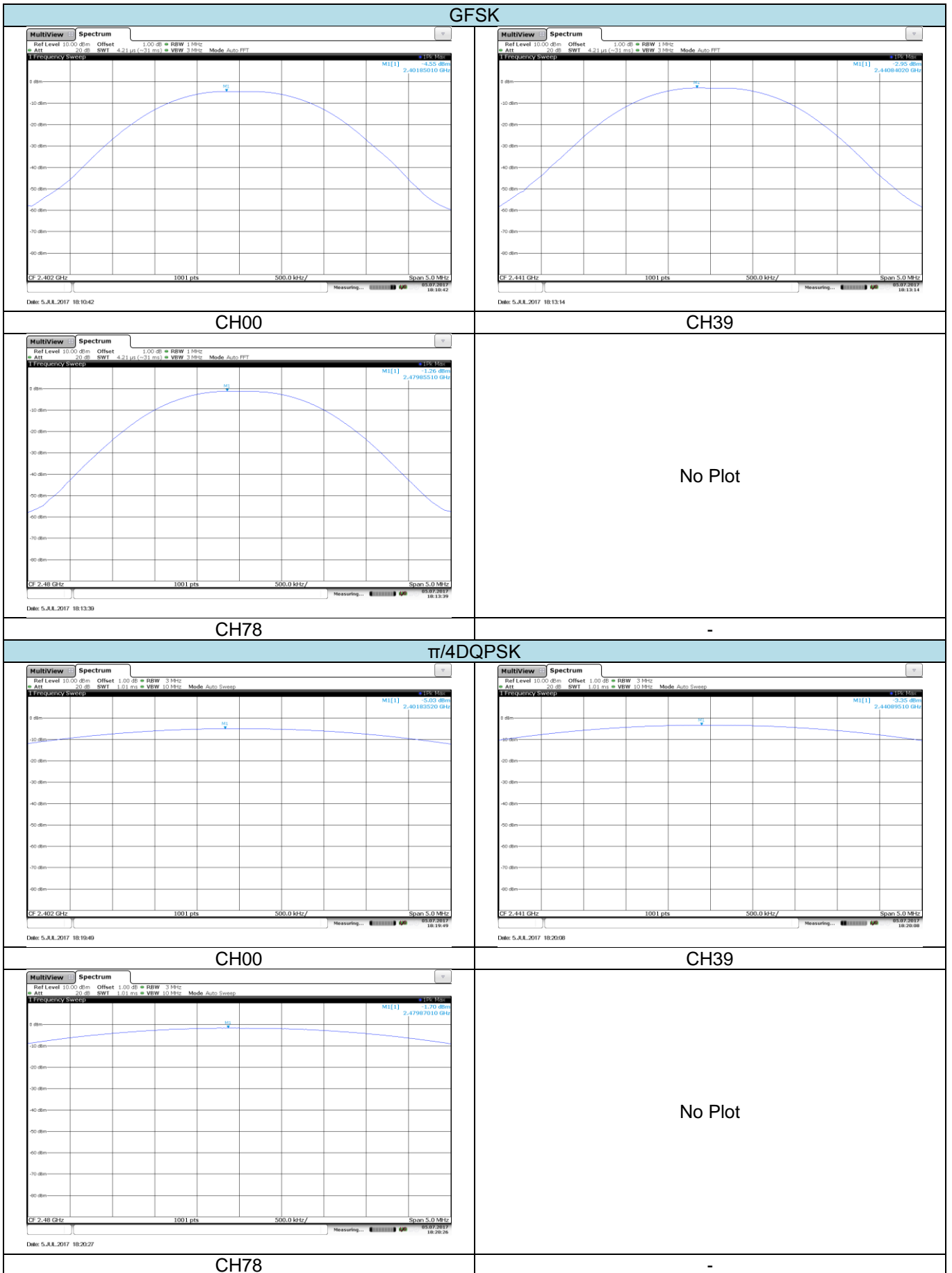

### 8DPSK

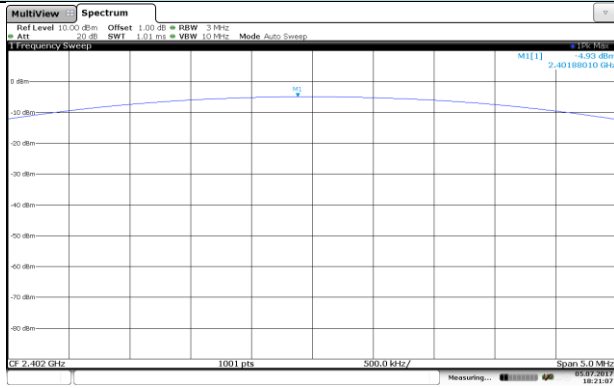

CH00

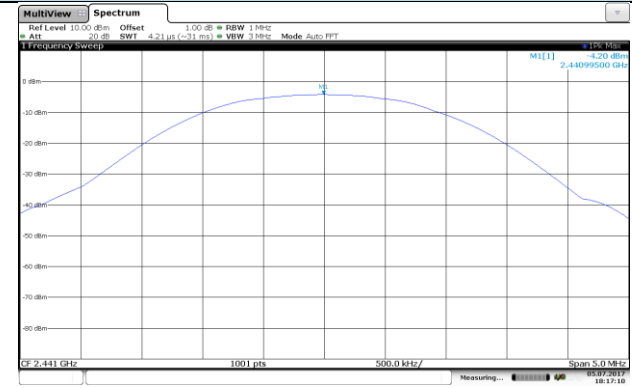

CH39

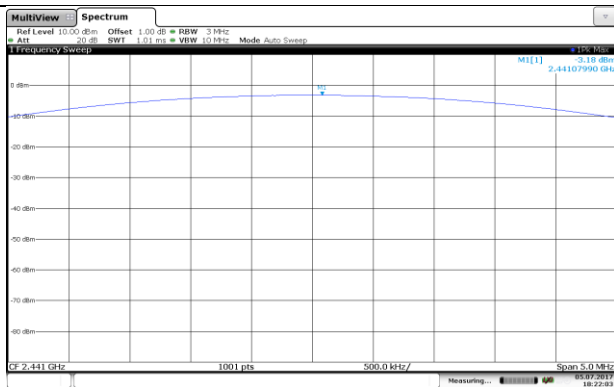

CH78

No Plot



## 5.4. 20dB Emission Bandwidth

### LIMIT

N/A

### TEST CONFIGURATION

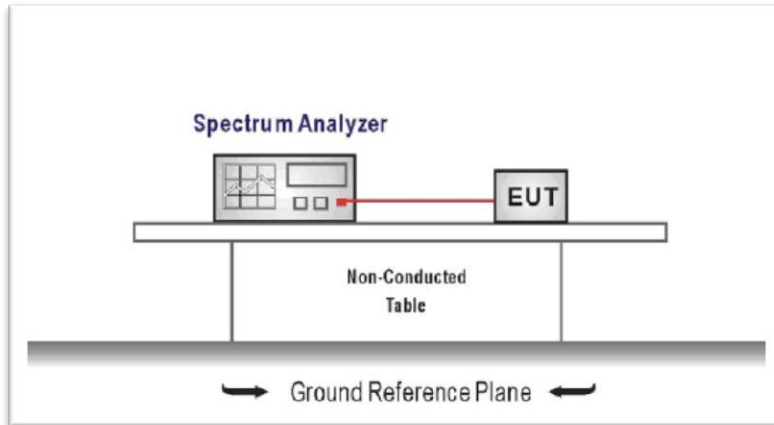

### TEST PROCEDURE

1. The transmitter output was connected to the spectrum analyzer through an attenuator, the pathloss was compensated to the results for each measurement.
2. Set to the maximum power setting and enable the EUT transmit continuously
3. Use the following spectrum analyzer settings:  
Span = approximately 2 to 3 times the 20 dB bandwidth, centered on a hopping channel  
RBW $\geq$ 1% of the 20 dB bandwidth, VBW $\geq$ RBW  
Sweep = auto, Detector function = peak, Trace = max hold
4. Measure and record the results in the test report.

### TEST MODE:

Please refer to the clause 3.3

### TEST RESULTS

 Passed       Not Applicable

Modulation type	Channel	20dB Bandwidth (MHz)	Limit (MHz)	Result
GFSK	00	0.924	-	Pass
	39	0.924		
	78	0.925		
$\pi/4$ DQPSK	00	1.314	-	Pass
	39	1.317		
	78	1.309		
8DPSK	00	1.292	-	Pass
	39	1.294		
	78	1.294		

GFSK

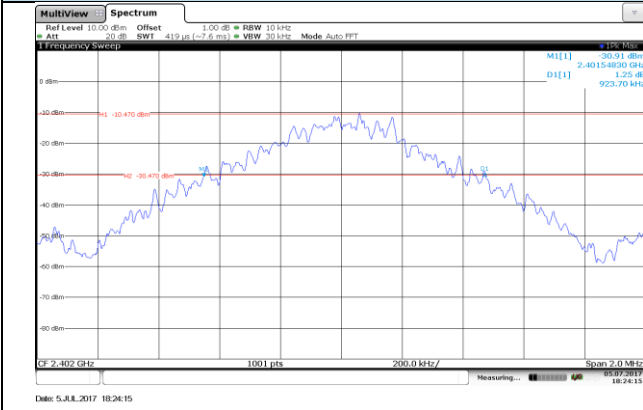

CH00

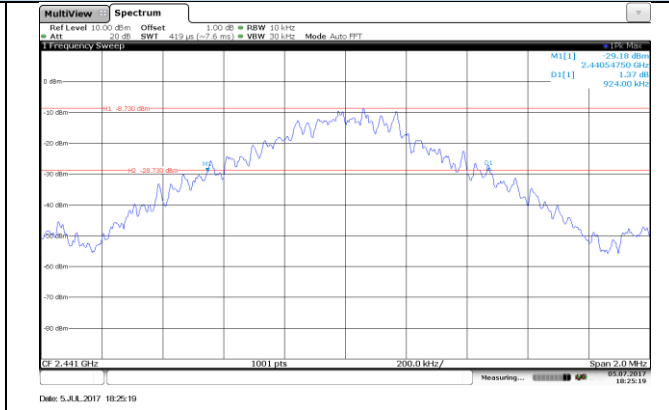

CH39

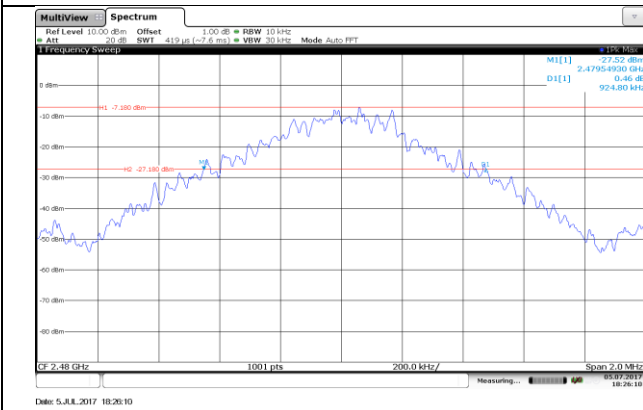

CH78

No Plot

$\pi$ /4DQPSK

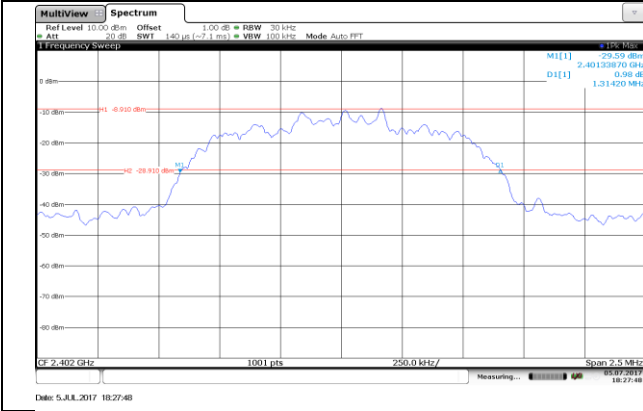

CH00

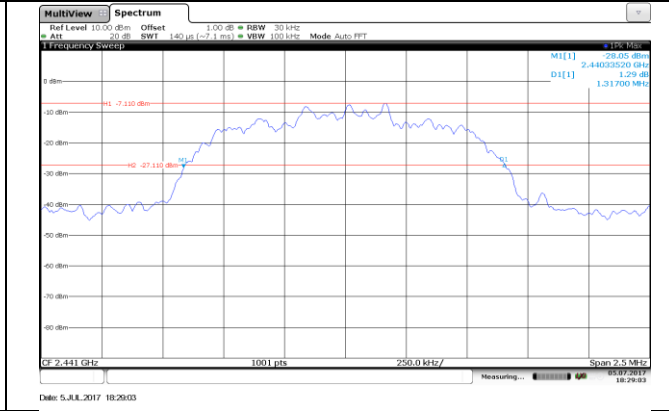

CH39

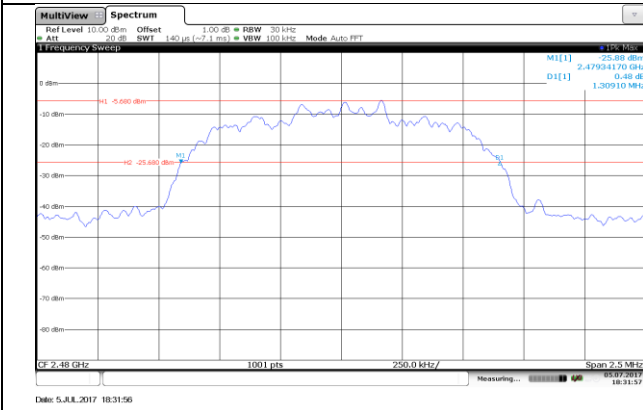

CH78

No Plot

8DPSK

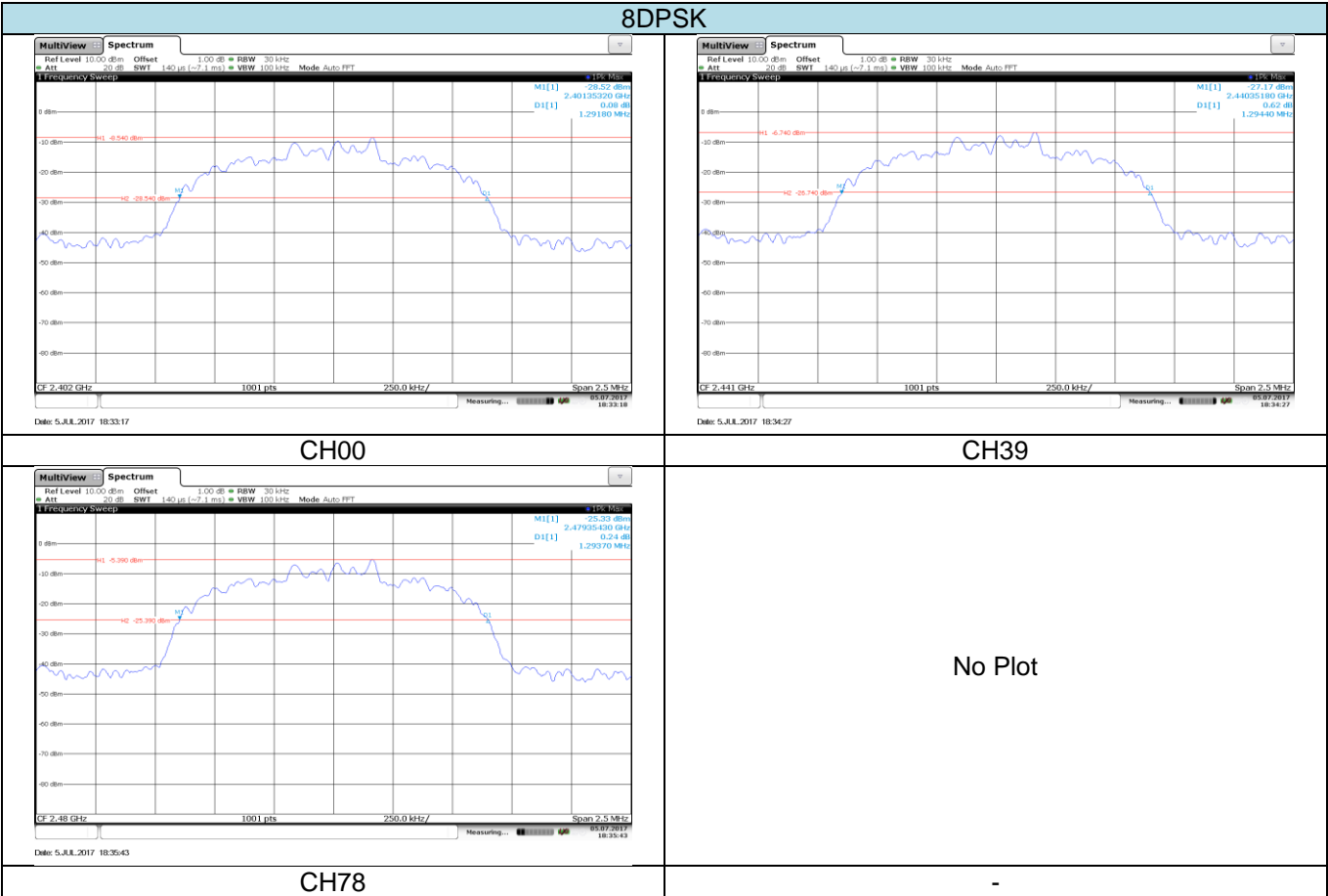

### 5.5. Carrier Frequencies Separation

#### LIMIT

FCC CFR Title 47 Part 15 Subpart C Section 15.247 (a)(1):

frequency hopping systems shall have hopping channel carrier frequencies separated by minimum of 25KHz or the  $\frac{2}{3} \times 20\text{dB}$  bandwidth of the hopping channel, whichever is greater.

#### TEST CONFIGURATION

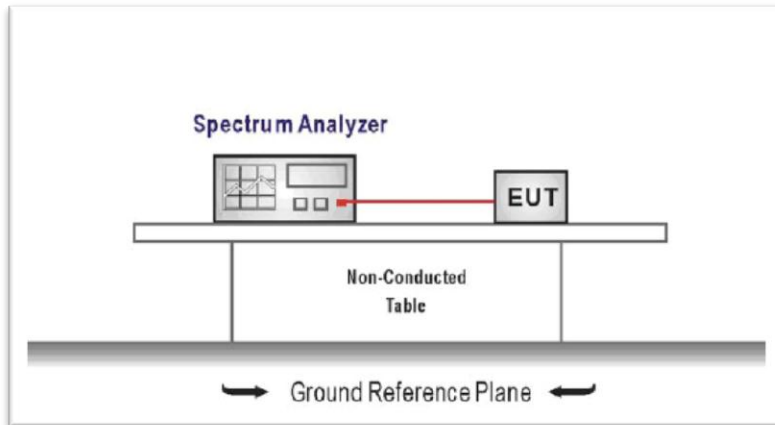

#### TEST PROCEDURE

1. The transmitter output was connected to the spectrum analyzer through an attenuator, the pathloss was compensated to the results for each measurement.
2. Set to the maximum power setting and enable the EUT transmit continuously
3. Use the following spectrum analyzer settings:  
 Span = wide enough to capture the peaks of two adjacent channels  
 RBW  $\geq 1\%$  of the span, VBW  $\geq$  RBW  
 Sweep = auto, Detector function = peak, Trace = max hold
4. Measure and record the results in the test report.

#### TEST MODE:

Please refer to the clause 3.3

#### TEST RESULTS

Passed       Not Applicable

Modulation type	Channel	Carrier Frequencies Separation (MHz)	Limit (MHz)	Result
GFSK	39	0.998	0.925	Pass
$\pi/4$ DQPSK	39	1.001	0.878	Pass
8DPSK	39	1.003	0.863	Pass

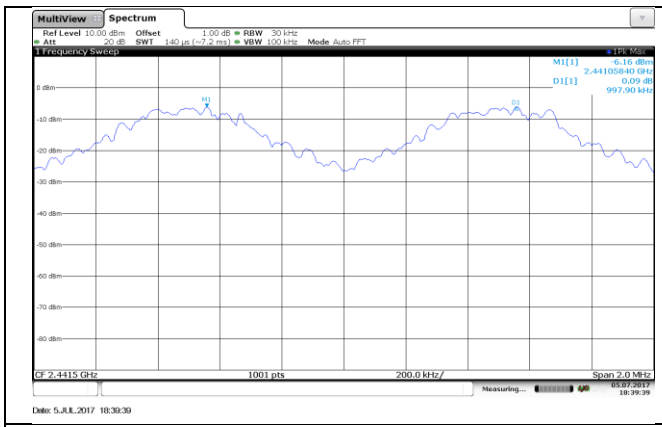

GFSK

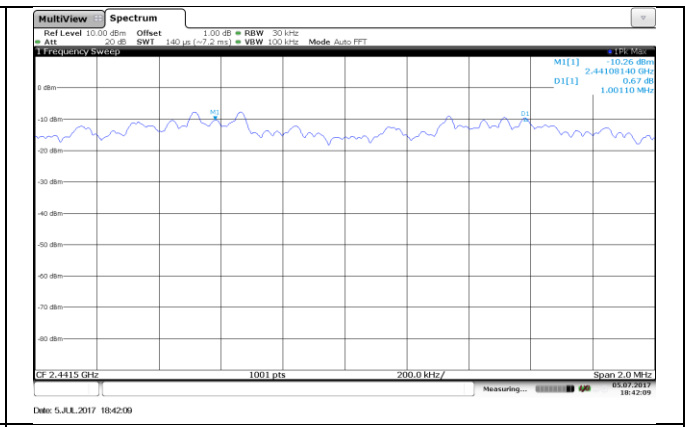

$\pi/4$ DQPSK

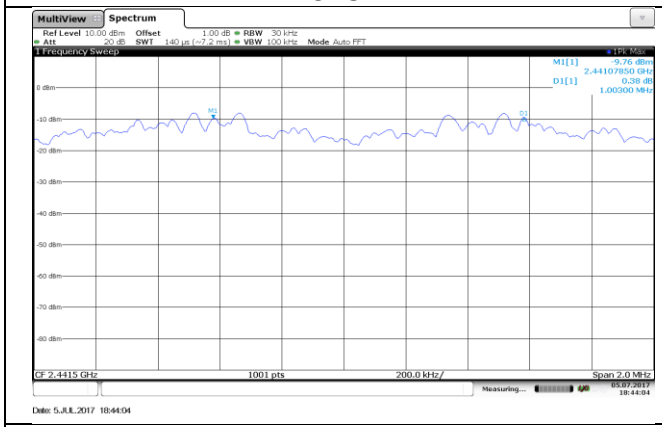

8DPSK

No Plot

## 5.6. Hopping Channel Number

### LIMIT

FCC CFR Title 47 Part 15 Subpart C Section 15.247 (a)(1):

Frequency hopping systems in the 2400–2483.5 MHz band shall use at least **15** channels.

### TEST CONFIGURATION

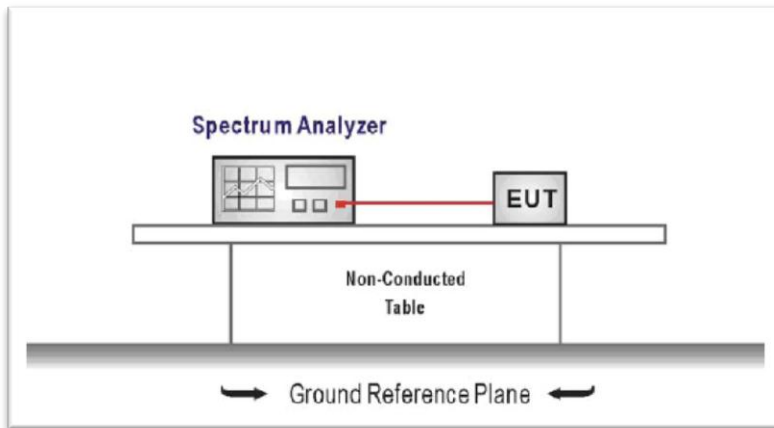

### TEST PROCEDURE

1. The transmitter output was connected to the spectrum analyzer through an attenuator, the pathloss was compensated to the results for each measurement.
2. Set to the maximum power setting and enable the EUT transmit continuously
3. Use the following spectrum analyzer settings:  
 Span = the frequency band of operation  
 RBW  $\geq$  1% of the span, VBW  $\geq$  RBW  
 Sweep = auto, Detector function = peak, Trace = max hold
4. Measure and record the results in the test report.

### TEST MODE:

Please refer to the clause 3.3

### TEST RESULTS

Passed       Not Applicable

Modulation type	Channel number	Limit	Result
GFSK	79	15.00	Pass
$\pi/4$ DQPSK	79		
8DPSK	79		

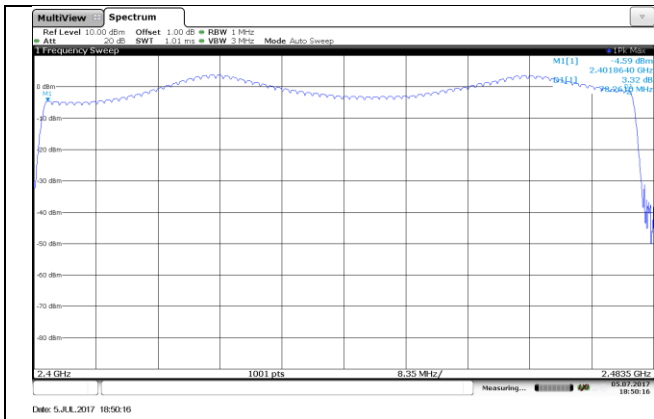

GFSK

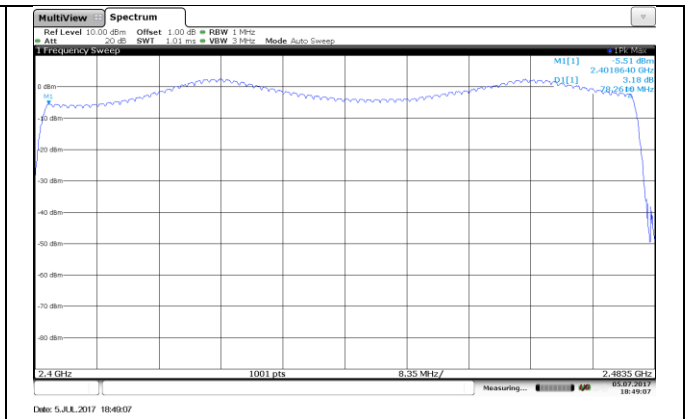

$\pi/4$ DQPSK

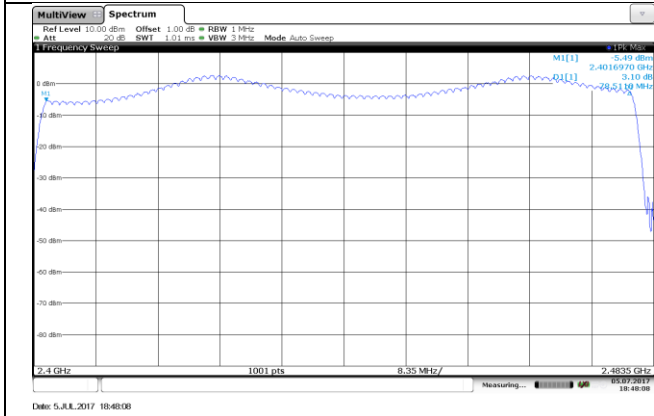

8DPSK

No Plot

### 5.7. Dwell Time

#### LIMIT

FCC CFR Title 47 Part 15 Subpart C Section 15.247 (a)(1):

The average time of occupancy on any channel shall not be greater than 0.4 seconds within a pe-riod of 0.4 seconds multiplied by the number of hopping channels employed.

#### TEST CONFIGURATION

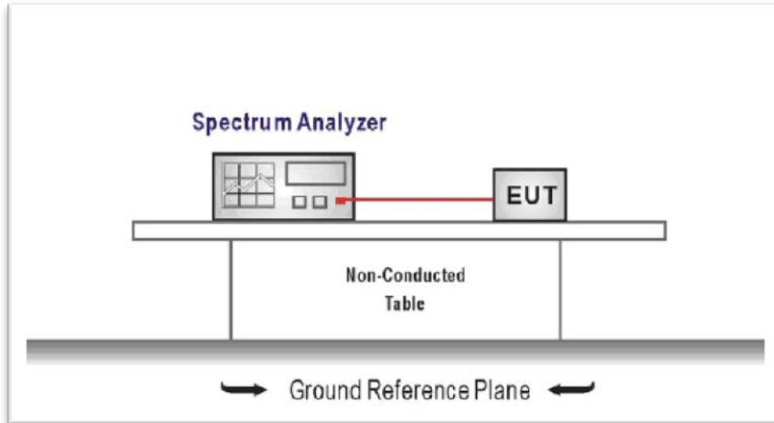

#### TEST PROCEDURE

1. The transmitter output was connected to the spectrum analyzer through an attenuator, the pathloss was compensated to the results for each measurement.
2. Set to the maximum power setting and enable the EUT transmit continuously
3. Use the following spectrum analyzer settings:  
Span = zero span, centered on a hopping channel, RBW= 1 MHz, VBW≥RBW  
Sweep = as necessary to capture the entire dwell time per hopping channel,  
Detector function = peak, Trace = max hold
4. Measure and record the results in the test report.

#### TEST MODE:

Please refer to the clause 3.3

#### TEST RESULTS

Passed       Not Applicable

Modulation type	Channel	Dwell time (Second)	Limit (Second)	Result
GFSK	DH1	0.119	0.40	Pass
	DH3	0.259		
	DH5	0.307		
π/4DQPSK	2-DH1	0.120	0.40	Pass
	2-DH3	0.261		
	2-DH5	0.306		
8DPSK	3-DH1	0.119	0.40	Pass
	3-DH3	0.262		
	3-DH5	0.306		

Note:

1. We have tested all mode at high,middle and low channel,and recoreded worst case at middle channel.
2. Dwell time=Pulse time (ms) × (1600 ÷ 2 ÷ 79) ×31.6 Second for DH1, 2-DH1, 3-DH1  
Dwell time=Pulse time (ms) × (1600 ÷ 4 ÷ 79) ×31.6 Second for DH3, 2-DH3, 3-DH3  
Dwell time=Pulse time (ms) × (1600 ÷ 6 ÷ 79) ×31.6 Second for DH5, 2-DH5, 3-DH5



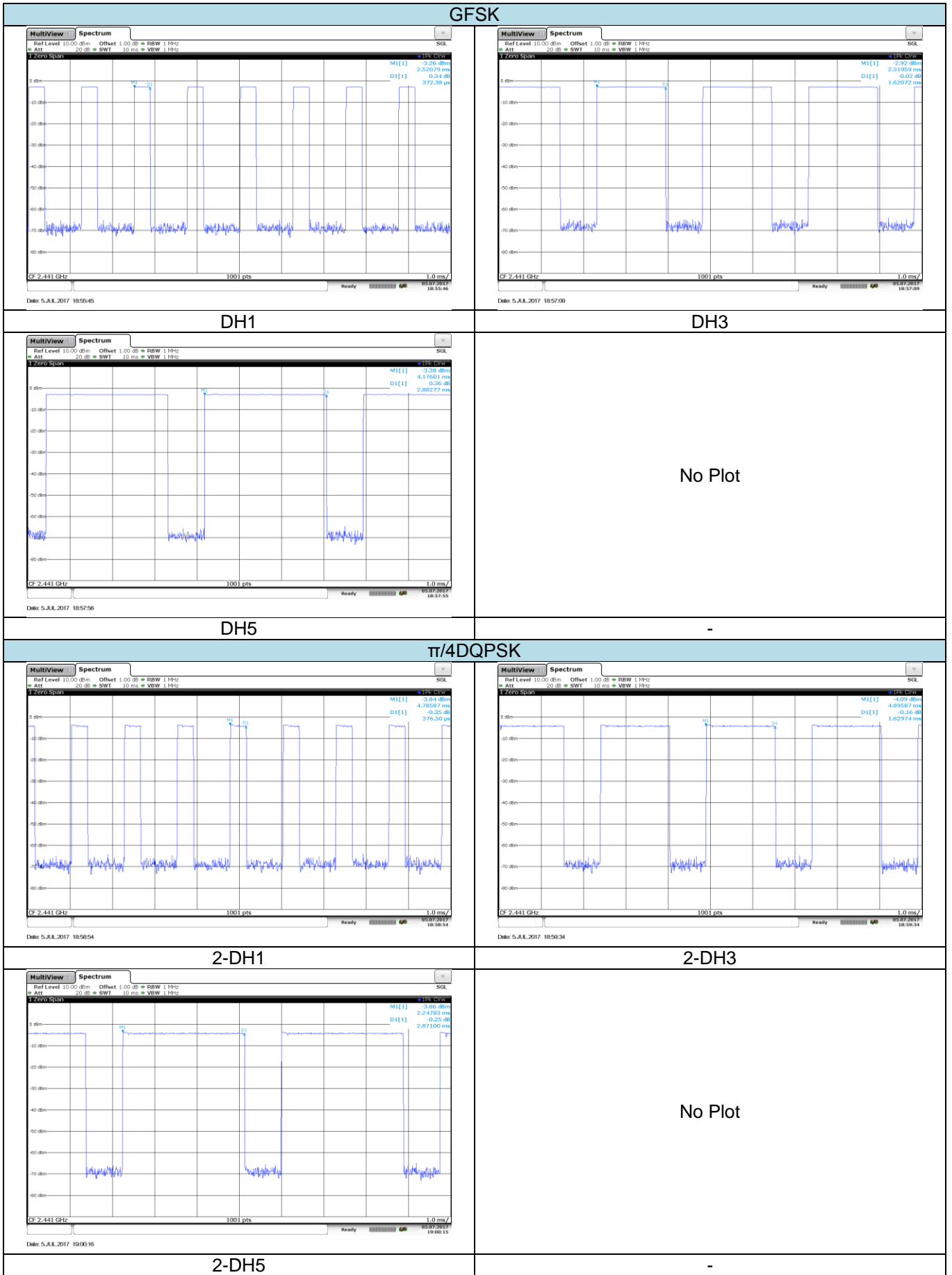

8DPSK

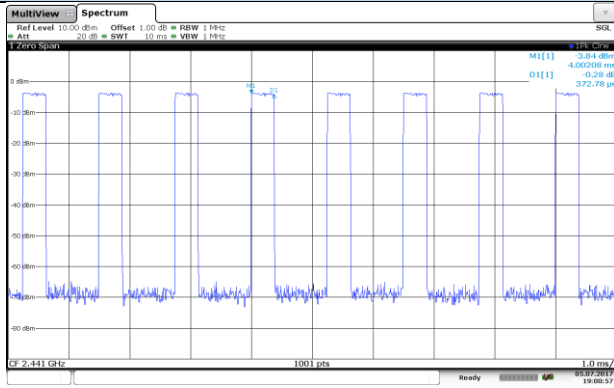

3-DH1

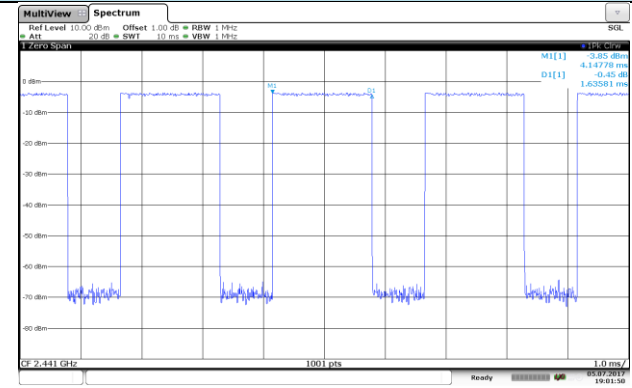

3-DH3

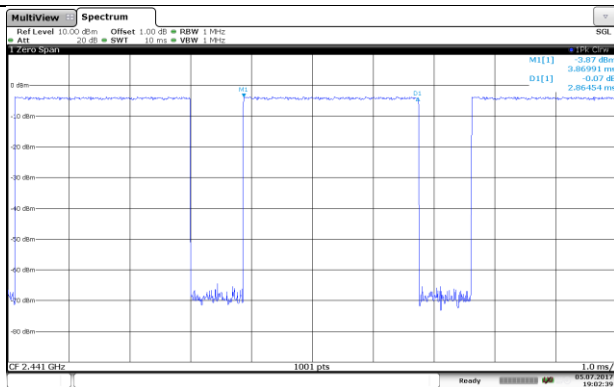

3-DH5

No Plot

-

### 5.8. Pseudorandom Frequency Hopping Sequence

#### LIMIT

FCC CFR Title 47 Part 15 Subpart C Section 15.247 (a)(1):

Frequency hopping systems shall have hopping channel carrier frequencies separated by a minimum of 25 kHz or the 20 dB bandwidth of the hop-ping channel, whichever is greater. Alternatively, frequency hopping systems operating in the 2400–2483.5 MHz band may have hopping channel carrier frequencies that are separated by 25 kHz or two-thirds of the 20 dB bandwidth of the hopping channel, whichever is greater, provided the systems operate with an output power no greater than 125 mW. The system shall hop to channel frequencies that are selected at the system hopping rate from a pseudo randomly ordered list of hopping frequencies. Each frequency must be used equally on the average by each transmitter. The system receivers shall have input bandwidths that match the hop-ping channel bandwidths of their corresponding transmitters and shall shift frequencies in synchronization with the transmitted signals.

#### TEST RESULTS

The pseudorandom frequency hopping sequence may be generated in a nine-stage shift register whose 5<sup>th</sup> and 9<sup>th</sup> stage outputs are added in a modulo-two addition stage. And the result is fed back to the input of the first stage. The sequence begins with the first one of 9 consecutive ones, for example: the shift register is initialized with nine ones.

- Number of shift register stages:9
- Length of pseudo-random sequence:29-1=511 bits
- Longest sequence of zeros:8(non-inverted signal)

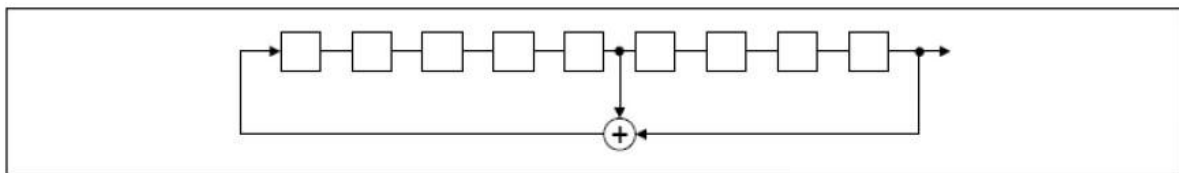

*Linear Feedback Shift Register for Generation of the PRBS sequence*

An example of pseudorandom frequency hopping sequence as follows:

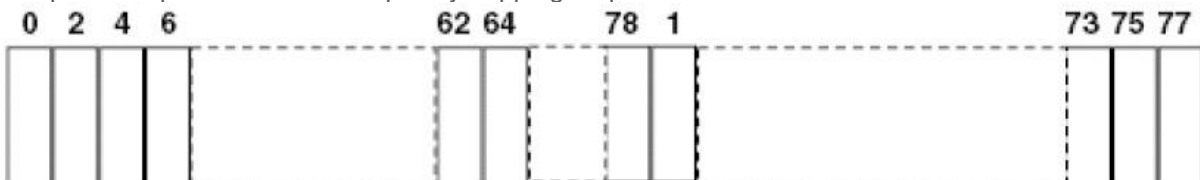

Each frequency used equally on the average by each transmitter. The system receiver has input bandwidths that match the hopping channel bandwidths of their corresponding transmitter and shift frequencies in synchronization with the transmitted signals.

## 5.9. Restricted band (radiated)

### LIMIT

#### **FCC CFR Title 47 Part 15 Subpart C Section 15.247 (d):**

In any 100 kHz bandwidth outside the frequency band in which the spread spectrum or digitally modulated intentional radiator is operating, radiated emissions which fall in the restricted bands, as defined in §15.205(a), must also comply with the radiated emission limits specified in §15.209(a) (see §15.205(c)).

### TEST CONFIGURATION

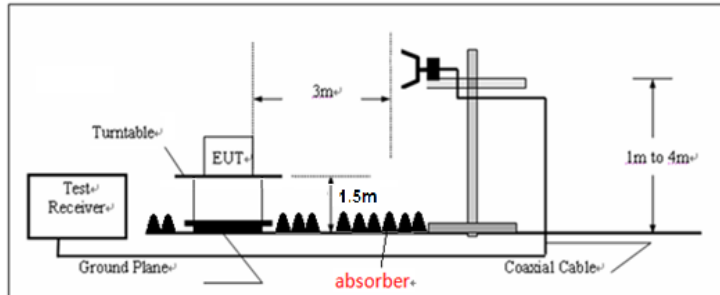

### TEST PROCEDURE

1. The EUT was setup and tested according to ANSI C63.10:2013 for compliance to FCC 47CFR 15.247 requirements.
2. The EUT is placed on a turn table which is 1.5 meter above ground. The turn table is rotated 360 degrees to determine the position of the maximum emission level.
3. The EUT was positioned such that the distance from antenna to the EUT was 3 meters.
4. The antenna is scanned from 1 meter to 4 meters to find out the maximum emission level. This is repeated for both horizontal and vertical polarization of the antenna. In order to find the maximum emission, all of the interface cables were manipulated according to ANSI C63.10:2013 on radiated measurement.
5. The receiver set as follow:  
 RBW=1MHz, VBW=3MHz Peak detector for Peak value  
 RBW=1MHz, VBW=10Hz Peak detector for Average value.

### TEST MODE:

Please refer to the clause 3.3

### TEST RESULTS

**Passed**       **Not Applicable**

Note:

- 1) Final level= Read level + Antenna Factor+ Cable Loss- Preamp Factor
- 2) Have pre-scan all modulation mode, found the GFSK modulation which it was worst case, so only the worst case's data on the test report.

BT-EDR						CH00			
Frequency (MHz)	Read Level (dBuV)	Antenna Factor (dB/m)	Cable Loss (dB)	Preamp Factor (dB)	Level (dBuV/m)	Limit Line (dBuV/m)	Margin Limit (dB)	Polarization	Test value
2310.00	36.04	28.05	6.62	37.65	33.06	74.00	-40.94	Horizontal	Peak
2390.03	38.64	27.65	6.75	37.87	35.17	74.00	-38.83	Horizontal	Peak
2310.00	36.21	28.05	6.62	37.65	33.23	74.00	-40.77	Vertical	Peak
2390.03	38.54	27.65	6.75	37.87	35.07	74.00	-38.93	Vertical	Peak
2310.00	23.48	28.05	6.62	37.65	20.50	54.00	-33.50	Horizontal	Average
2390.03	23.84	27.65	6.75	37.87	20.37	54.00	-33.63	Horizontal	Average
2310.00	23.46	28.05	6.62	37.65	20.48	54.00	-33.52	Vertical	Average
2390.03	23.42	27.65	6.75	37.87	19.95	54.00	-34.05	Vertical	Average

BT-EDR						CH78			
Frequency (MHz)	Read Level (dBuV)	Antenna Factor (dB/m)	Cable Loss (dB)	Preamp Factor (dB)	Level (dBuV/m)	Limit Line (dBuV/m)	Margin Limit (dB)	Polarization	Test value
2483.50	58.19	27.26	6.83	37.87	54.41	74.00	-19.59	Horizontal	Peak
2500.00	34.69	27.20	6.84	37.87	30.86	74.00	-43.14	Horizontal	Peak
2483.50	55.38	27.26	6.83	37.87	51.60	74.00	-22.40	Vertical	Peak
2500.00	35.57	27.20	6.84	37.87	31.74	74.00	-42.26	Vertical	Peak
2483.50	33.57	27.26	6.83	37.87	29.79	54.00	-24.21	Horizontal	Average
2500.00	23.53	27.20	6.84	37.87	19.70	54.00	-34.30	Horizontal	Average
2483.50	31.63	27.26	6.83	37.87	27.85	54.00	-26.15	Vertical	Average
2500.00	22.99	27.20	6.84	37.87	19.16	54.00	-34.84	Vertical	Average

## 5.10. Bandedge and Spurious Emission (conducted)

### LIMIT

FCC CFR Title 47 Part 15 Subpart C Section 15.247 (d):

In any 100 kHz bandwidth outside the frequency band in which the spread spectrum intentional radiator is operating, the radio frequency power that is produced by the intentional radiator shall be at least 20 dB below that in the 100 kHz bandwidth within the band that contains the highest level of the desired power, based on either an RF conducted or a radiated measurement.

### TEST CONFIGURATION

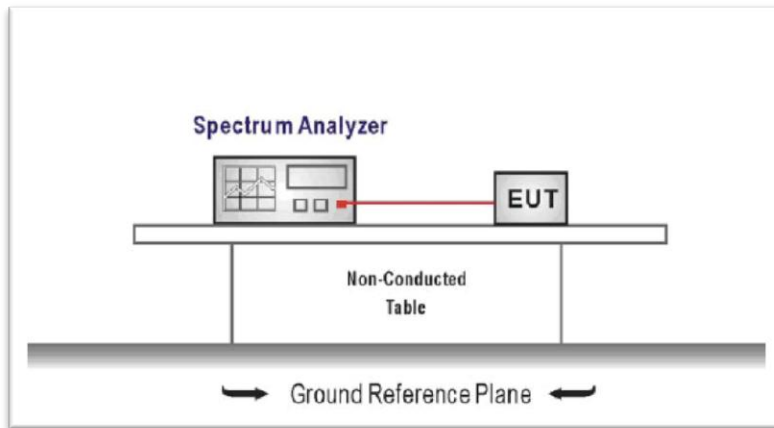

### TEST PROCEDURE

1. The transmitter output was connected to the spectrum analyzer through an attenuator, the pathloss was compensated to the results for each measurement.
2. Set to the maximum power setting and enable the EUT transmit continuously
3. Use the following spectrum analyzer settings:  
RBW= 100 KHz, VBW $\geq$ RBW  
Sweep = auto, Detector function = peak, Trace = max hold
4. Measure and record the results in the test report.

### TEST MODE:

Please refer to the clause 3.3

### TEST RESULTS

Passed       Not Applicable

GFSK

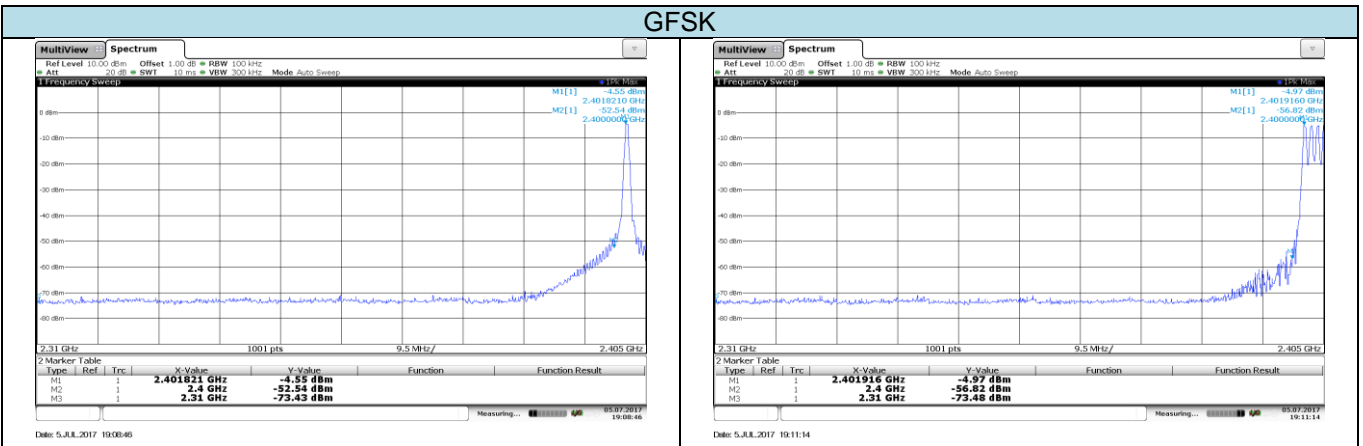

CH00 Bandedge (no hopping mode)

CH00 Bandedge (hopping mode)

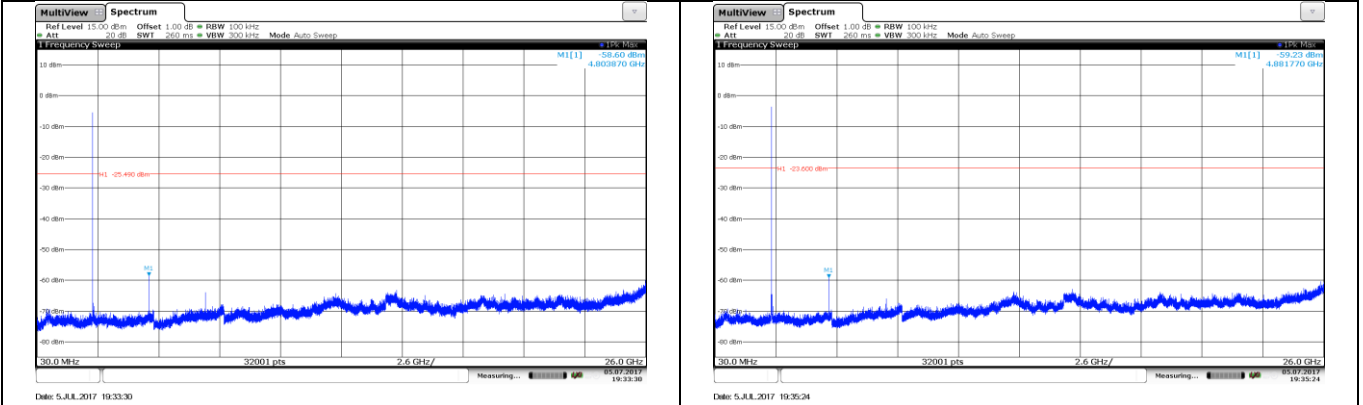

CH00 SE

CH39 SE

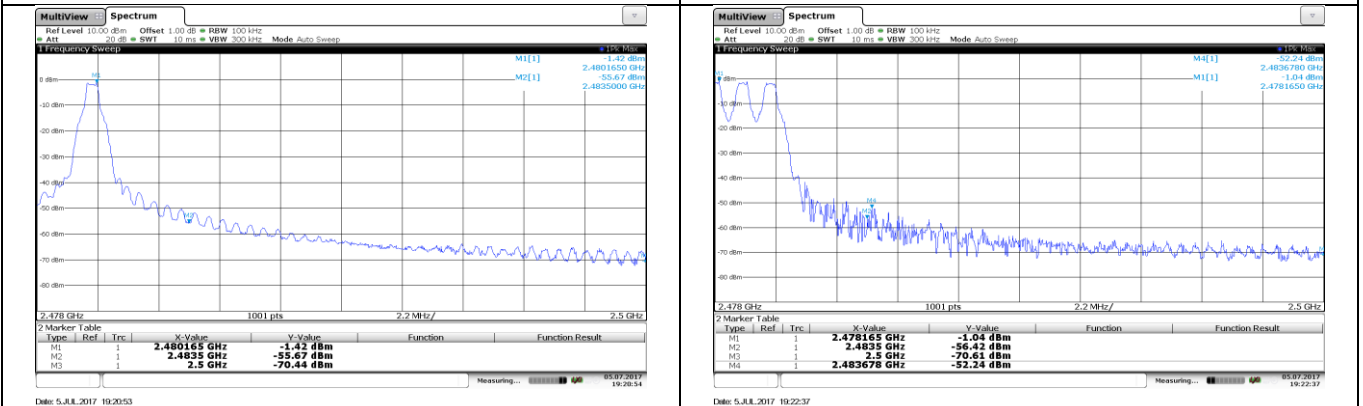

CH78 Bandedge (no hopping mode)

CH78 Bandedge (hopping mode)

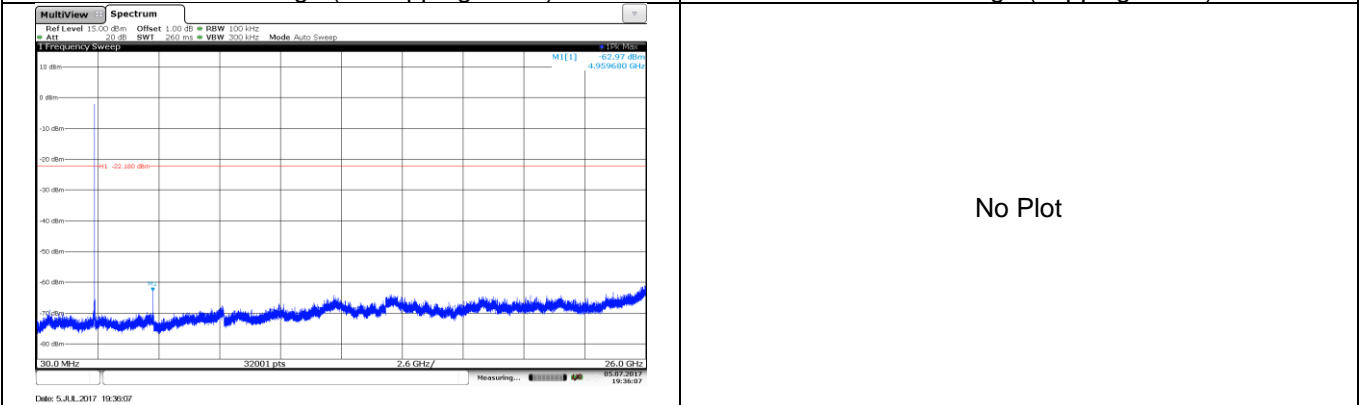

CH78 SE

$\pi/4$ DQPSK

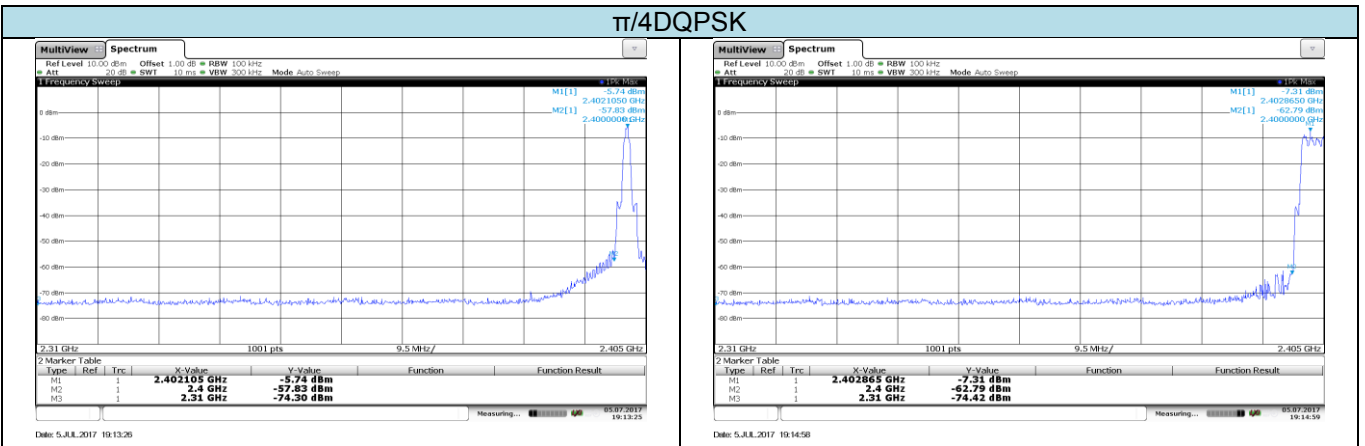

CH00 Bandedge (no hopping mode)

CH00 Bandedge (hopping mode)

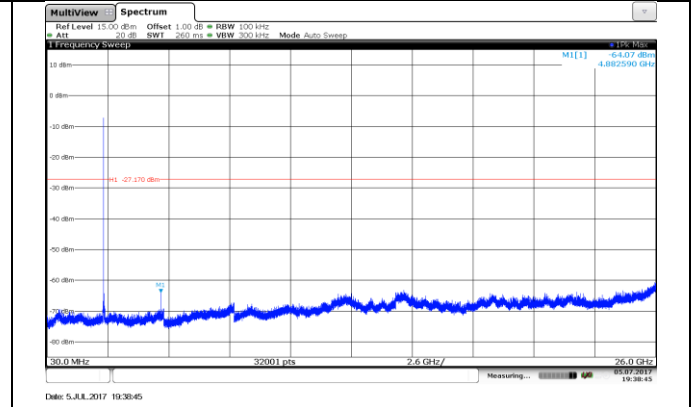
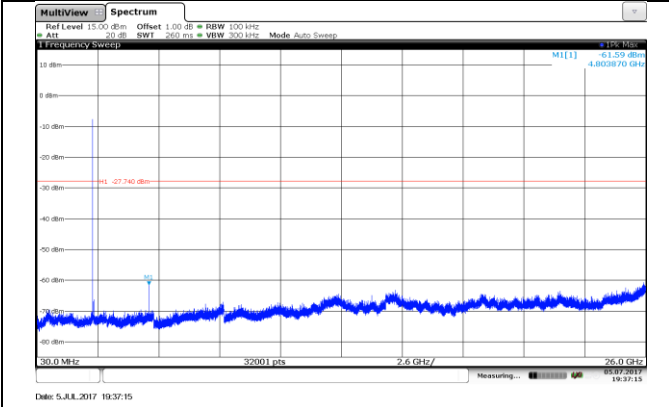

CH00 SE

CH39 SE

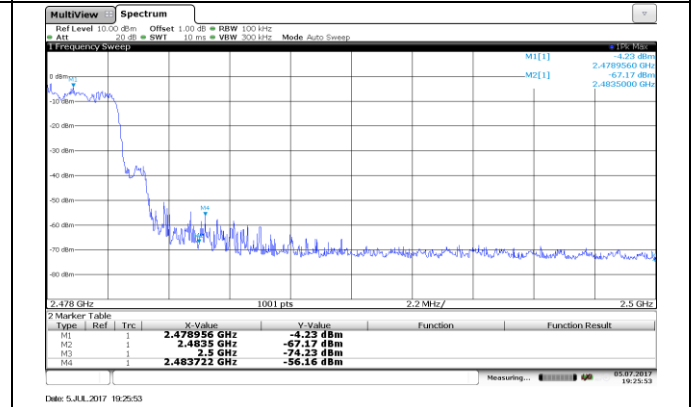
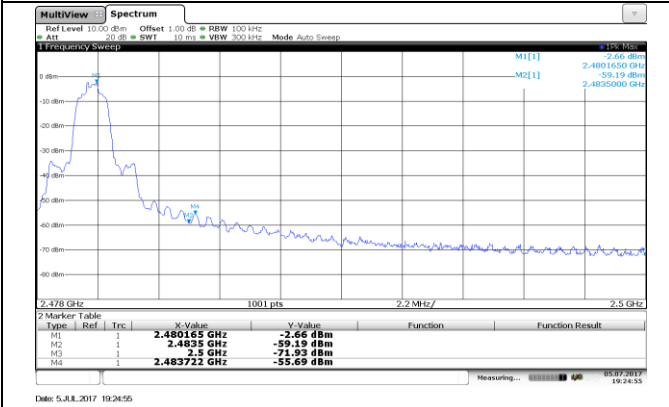

CH78 Bandedge (no hopping mode)

CH78 Bandedge (hopping mode)

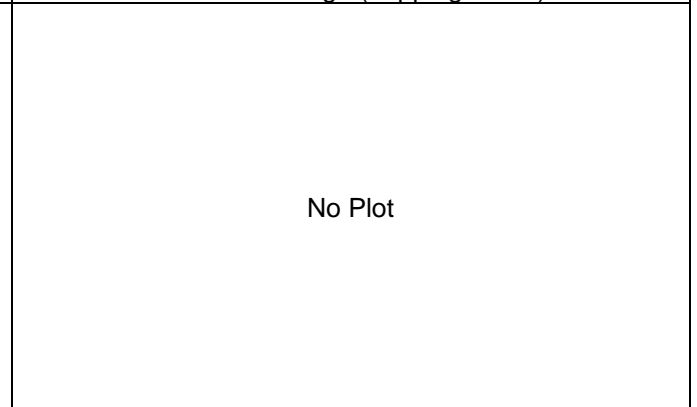
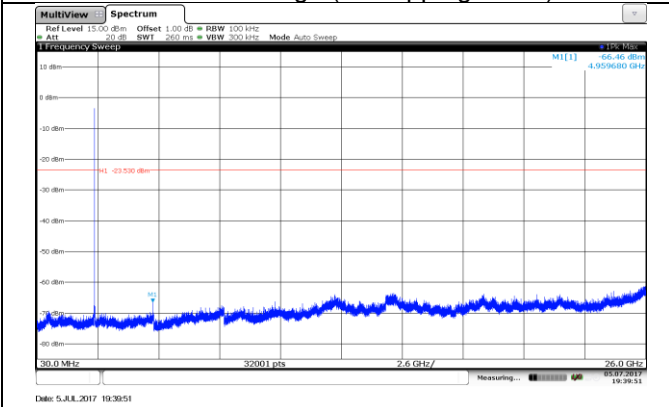

CH78 SE



### 8DPSK

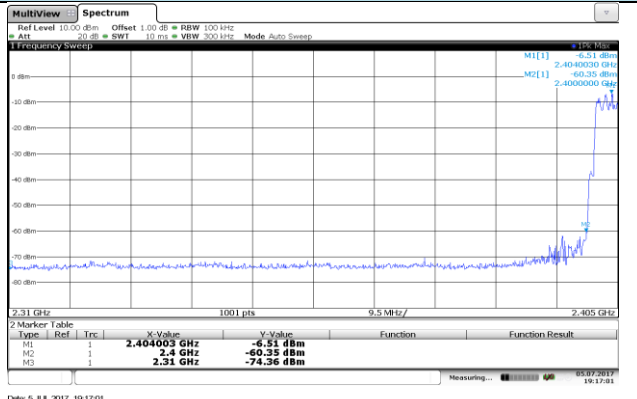
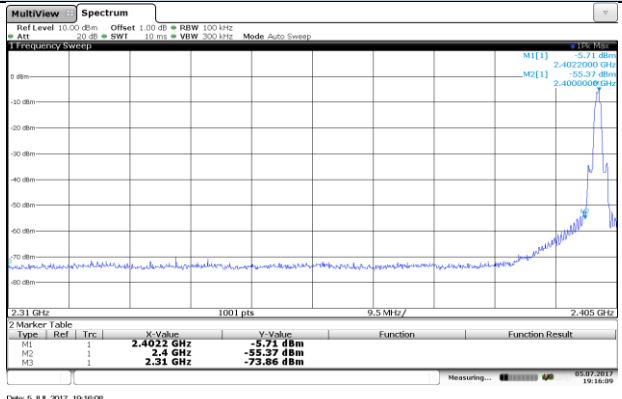

CH00 Bandedge (no hopping mode)

CH00 Bandedge (hopping mode)

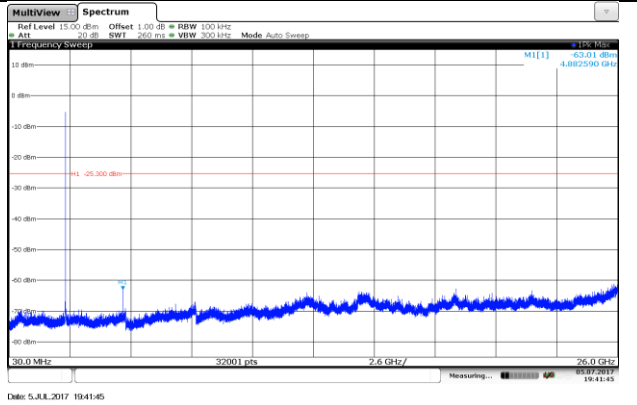
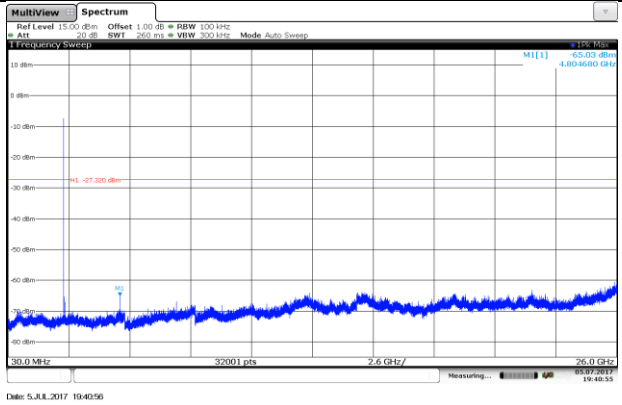

CH00 SE

CH39 SE

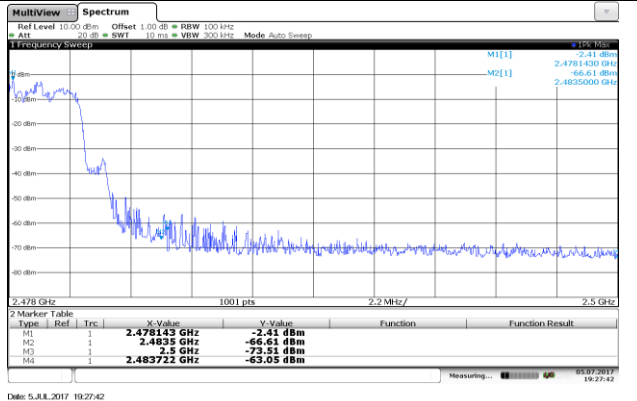
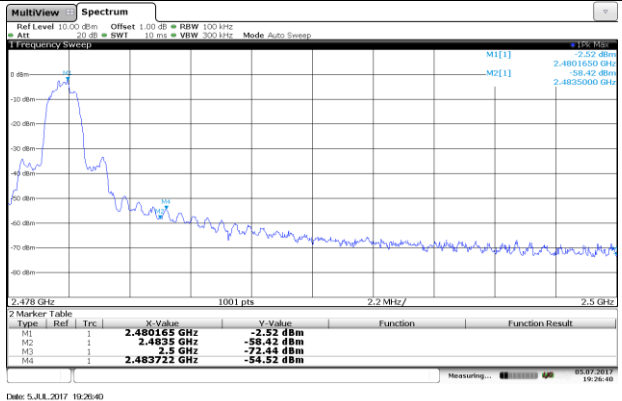

CH78 Bandedge (no hopping mode)

CH78 Bandedge (hopping mode)

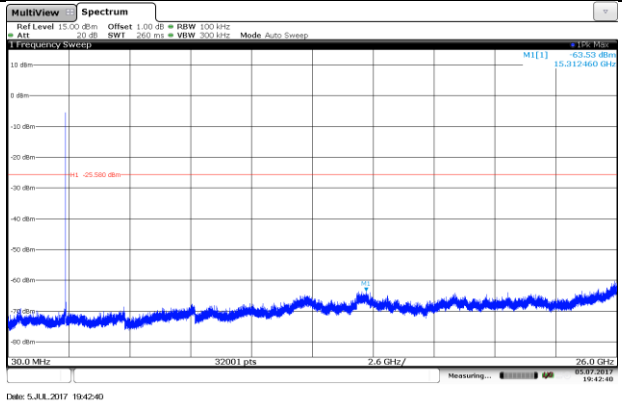

No Plot

CH78 SE

### 5.11. Spurious Emissions (radiated)

#### LIMIT

#### FCC CFR Title 47 Part 15 Subpart C Section 15.209

Frequency	Limit (dBuV/m @3m)	Value
30MHz-88MHz	40.00	Quasi-peak
88MHz-216MHz	43.50	Quasi-peak
216MHz-960MHz	46.00	Quasi-peak
960MHz-1GHz	54.00	Quasi-peak
Above 1GHz	54.00	Average
	74.00	Peak

#### TEST CONFIGURATION

➤ 9KHz ~30MHz

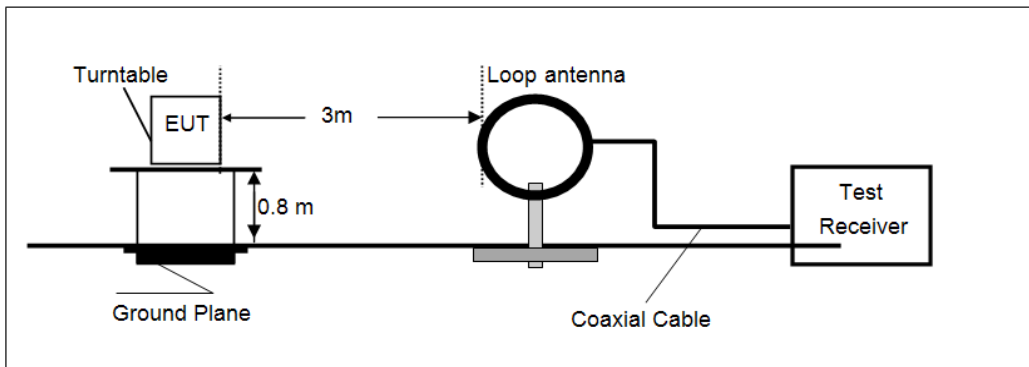

➤ 30MHz ~ 1GHz

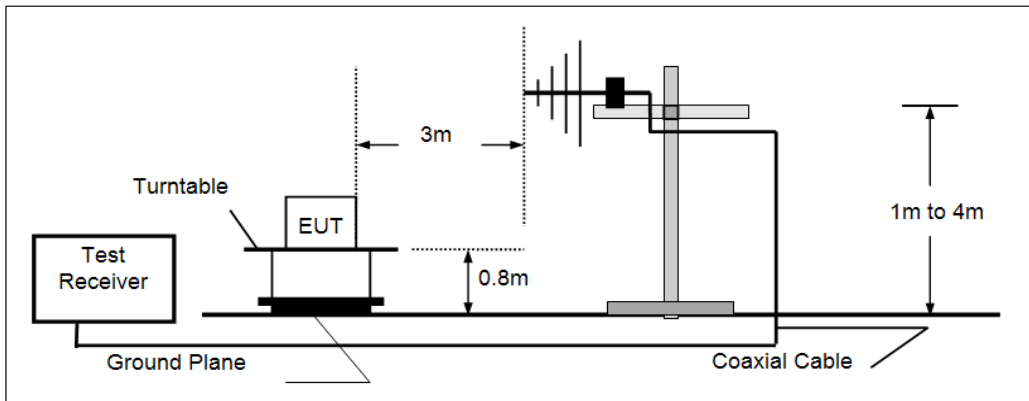

➤ Above 1GHz

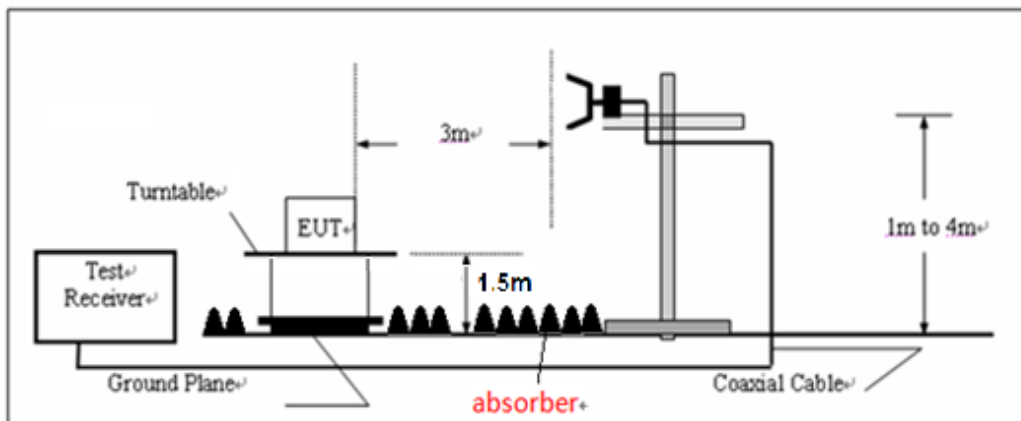

## TEST PROCEDURE

1. The EUT was tested according to ANSI C63.10:2013 for compliance to FCC 47CFR 15.247 requirements.
2. The EUT is placed on a turn table which is 0.8/1.5 meter above ground plane. The turn table is rotated 360 degrees to determine the position of the maximum emission level.
3. The EUT was positioned such that the distance from antenna to the EUT was 3 meters.
4. The antenna is scanned from 1 meter to 4 meters to find out the maximum emission level. This is repeated for both horizontal and vertical polarization of the antenna.
5. Use the following spectrum analyzer settings
  - (1) Span shall wide enough to fully capture the emission being measured;
  - (2) Below 1GHz, RBW=120KHz, VBW=300KHz, Sweep=auto, Detector function=peak, Trace=max hold; If the emission level of the EUT measured by the peak detector is 3 dB lower than the applicable limit, the peak emission level will be reported. Otherwise, the emission measurement will be repeated using the quasi-peak detector and reported.
  - (3) Above 1GHz, RBW=1MHz, VBW=3MHz Peak detector for Peak value  
RBW=1MHz, VBW=10Hz Peak detector for Average value.

Remark: "floor-standing equipment" Where possible, the antenna(s) of the EUT shall be located at a height of 1.5 m above the floor, and the intentional radiator circuitry shall be located within the system at a height of at least 0.8 m above the floor.

## TEST MODE:

Please refer to the clause 3.3

## TEST RESULTS

**Passed**       **Not Applicable**

Note:

- 1) Final Level = Receiver Read level + Antenna Factor + Cable Loss – Preamplifier Factor
- 2) "\*", means this data is too weak instrument of signal is unable to test.
- 3) The emission levels of other frequencies are very lower than the limit and not show in test report.
- 4) Have pre-scan all modulation mode, found the GFSK modulation which it was worst case, so only the worst case's data on the test report.

### ➤ **9kHz ~ 30MHz**

The EUT was pre-scanned the frequency band (9KHz~30MHz), found the radiated level lower than the limit, so don't show on the report.

➤ 30MHz ~ 1GHz

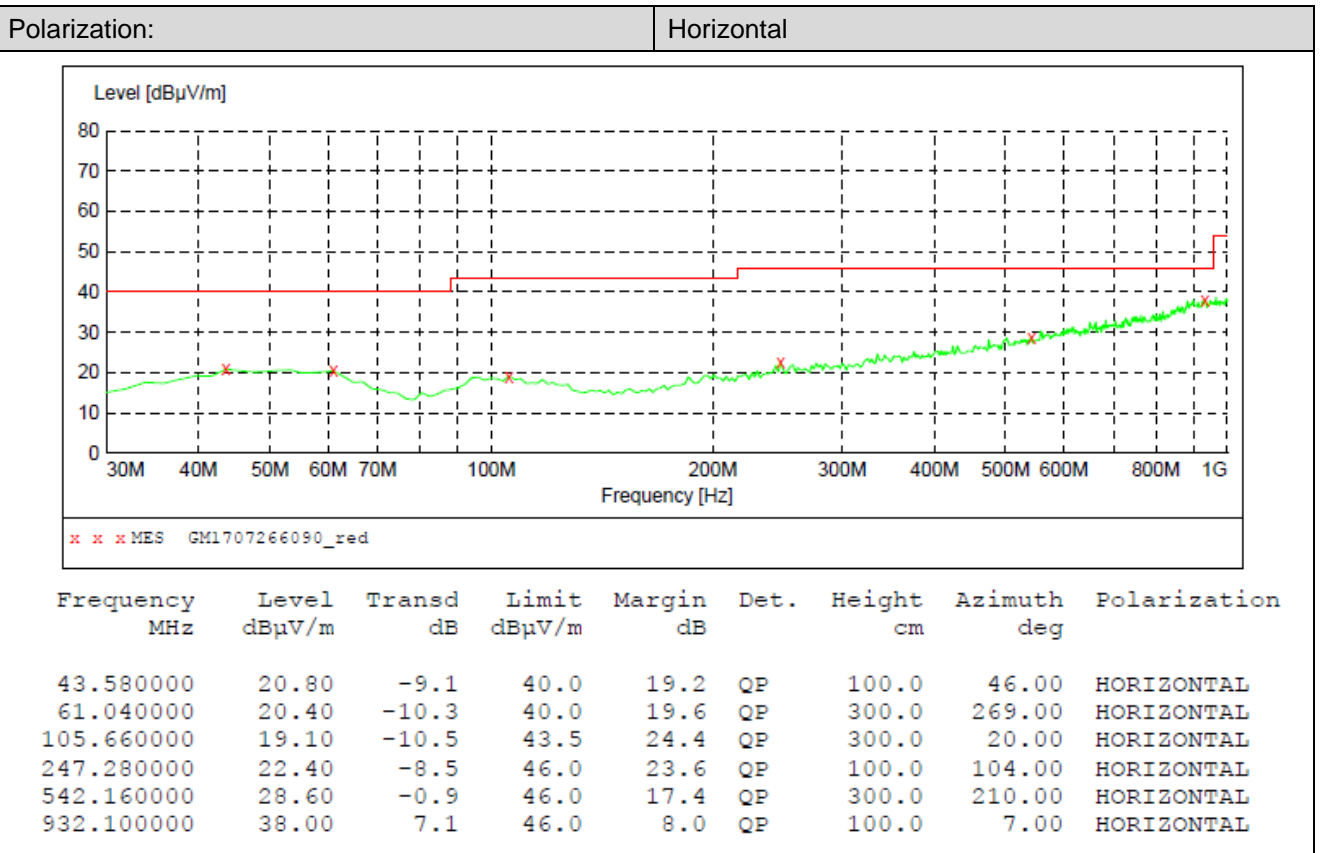
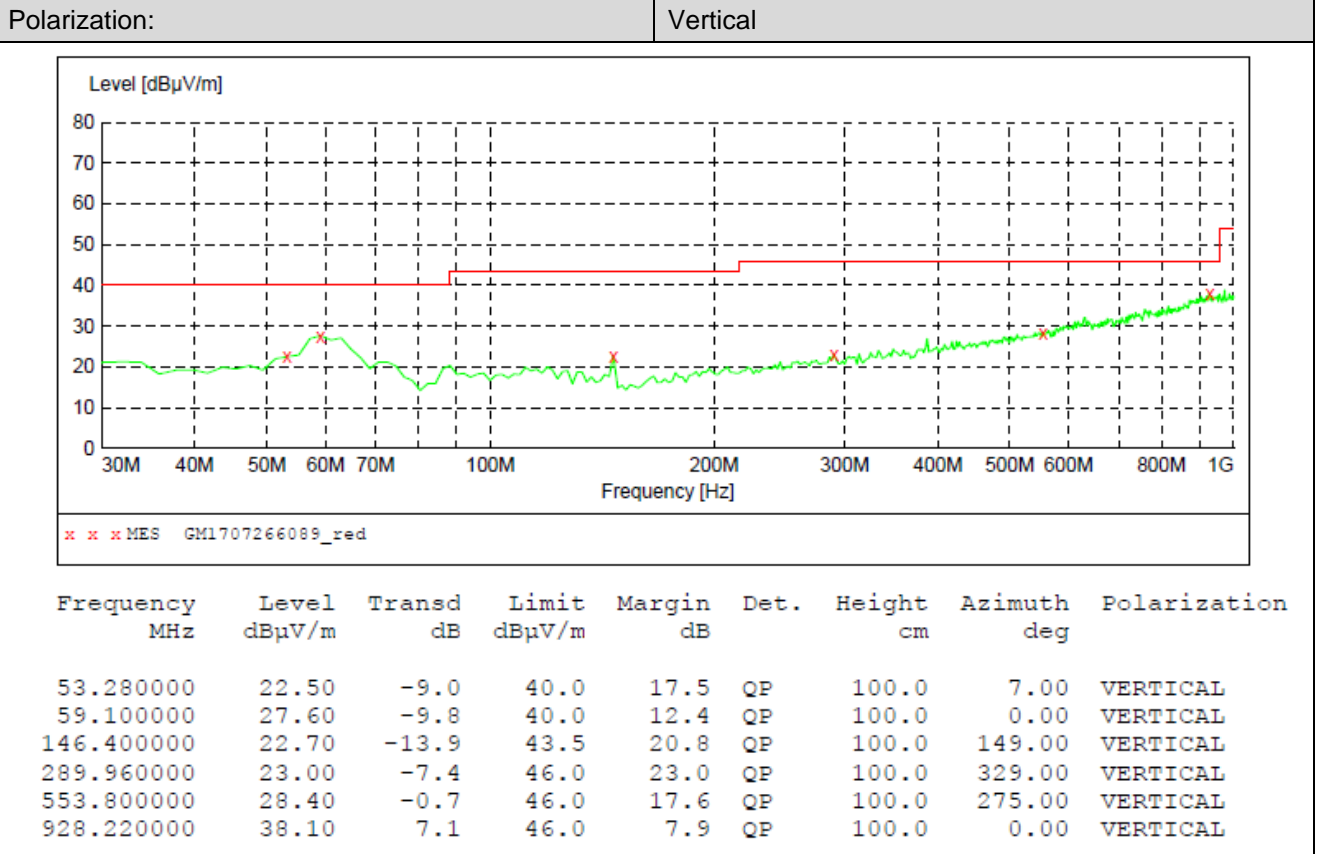

## ➤ Above 1GHz

CH00									
Frequency (MHz)	Read Level (dBuV)	Antenna Factor (dB/m)	Cable Loss (dB)	Preamp Factor (dB)	Level (dBuV/m)	Limit Line (dBuV/m)	Margin Limit (dB)	Polarization	Test value
1464.96	37.60	25.83	5.19	36.54	32.08	74.00	-41.92	Vertical	Peak
3200.50	37.68	28.80	7.72	38.20	36.00	74.00	-38.00	Vertical	
4809.50	47.83	31.58	9.55	36.93	52.03	74.00	-21.97	Vertical	
6645.07	33.60	34.20	11.41	35.28	43.93	74.00	-30.07	Vertical	
1617.86	38.50	24.95	5.60	36.76	32.29	74.00	-41.71	Horizontal	
3844.28	37.11	29.64	8.56	38.20	37.11	74.00	-36.89	Horizontal	
4809.50	44.33	31.58	9.55	36.93	48.53	74.00	-25.47	Horizontal	
6577.75	33.34	34.16	11.32	35.35	43.47	74.00	-30.53	Horizontal	

CH39									
Frequency (MHz)	Read Level (dBuV)	Antenna Factor (dB/m)	Cable Loss (dB)	Preamp Factor (dB)	Level (dBuV/m)	Limit Line (dBuV/m)	Margin Limit (dB)	Polarization	Test value
1392.25	38.17	25.92	4.99	36.46	32.62	74.00	-41.38	Vertical	Peak
3883.62	37.12	29.68	8.62	38.18	37.24	74.00	-36.76	Vertical	
4883.52	47.92	31.43	9.59	36.73	52.21	74.00	-21.79	Vertical	
6203.70	33.36	32.91	11.01	35.29	41.99	74.00	-32.01	Vertical	
1254.27	37.50	26.24	4.75	36.54	31.95	74.00	-42.05	Horizontal	
3184.25	36.34	28.80	7.70	38.20	34.64	74.00	-39.36	Horizontal	
4883.52	44.95	31.43	9.59	36.73	49.24	74.00	-24.76	Horizontal	
6544.35	33.67	34.09	11.26	35.35	43.67	74.00	-30.33	Horizontal	

CH78									
Frequency (MHz)	Read Level (dBuV)	Antenna Factor (dB/m)	Cable Loss (dB)	Preamp Factor (dB)	Level (dBuV/m)	Limit Line (dBuV/m)	Margin Limit (dB)	Polarization	Test value
1378.14	36.94	25.96	4.96	36.47	31.39	74.00	-42.61	Vertical	Peak
3815.03	36.12	29.62	8.52	38.22	36.04	74.00	-37.96	Vertical	
4958.68	42.83	31.46	9.64	36.52	47.41	74.00	-26.59	Vertical	
7508.69	33.20	36.11	12.42	34.91	46.82	74.00	-27.18	Vertical	
1732.97	37.72	25.27	5.83	37.00	31.82	74.00	-42.18	Horizontal	
3933.37	36.26	29.70	8.69	38.15	36.50	74.00	-37.50	Horizontal	
4958.68	43.34	31.46	9.64	36.52	47.92	74.00	-26.08	Horizontal	
6974.36	32.99	35.15	11.82	34.82	45.14	74.00	-28.86	Horizontal	

Remark:

1. Final Level = Receiver Read level + Antenna Factor + Cable Loss – Preamplifier Factor
2. The peak level is lower than average limit(54 dBuV/m), this data is the too weak instrument of signal is unable to test.
3. The emission levels of other frequencies are very lower than the limit and not show in test report.

## 6. Test Setup Photos of the EUT

### Conducted Emissions (AC Mains)



### Radiated Emissions



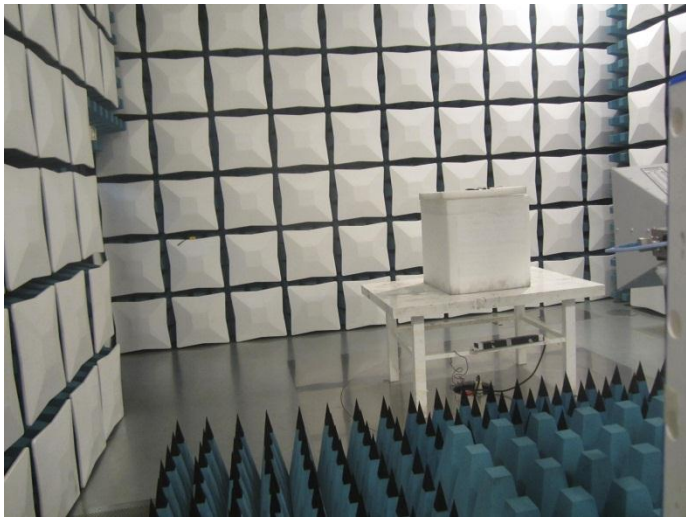



## 7. External and Internal Photos of the EUT

### External Photos of the EUT





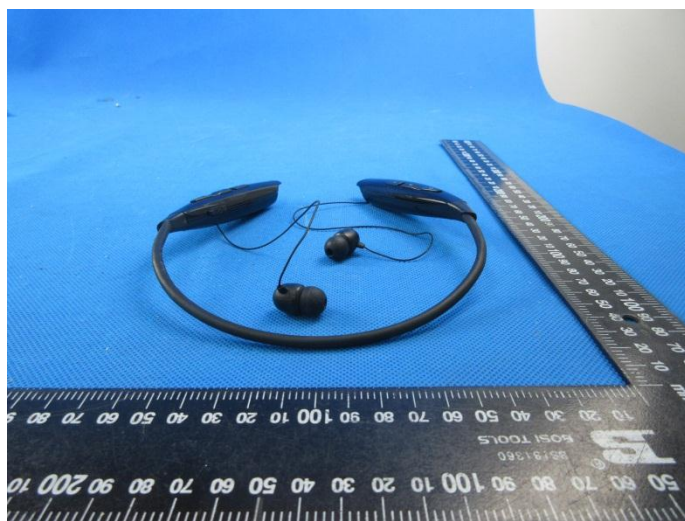
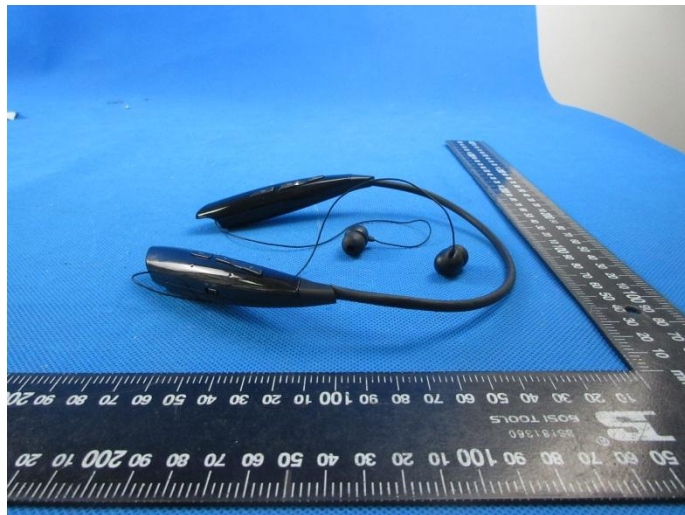

### Internal Photos of the EUT

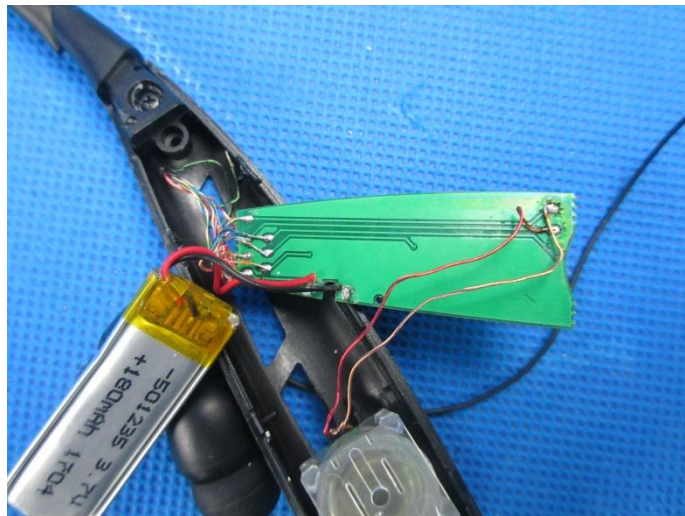
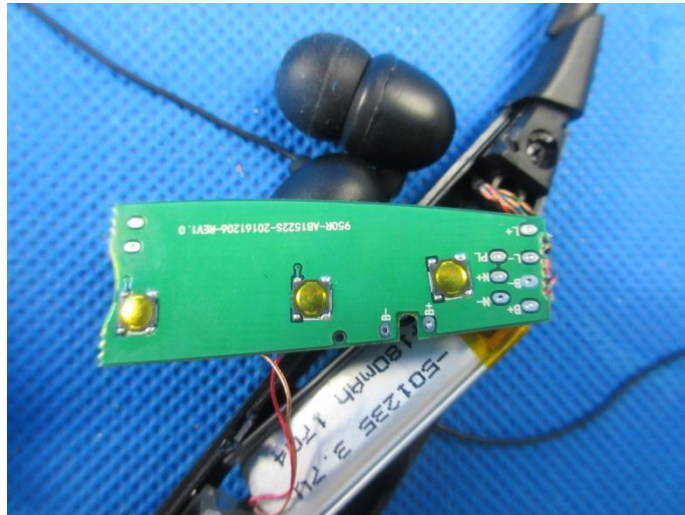



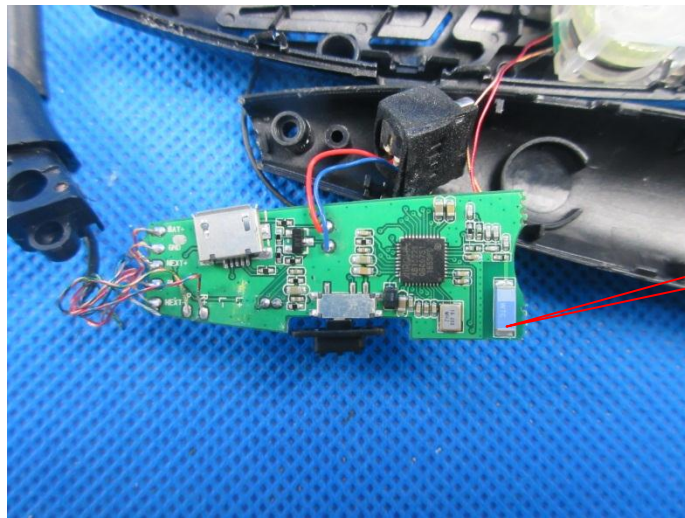

Bluetooth Antenna

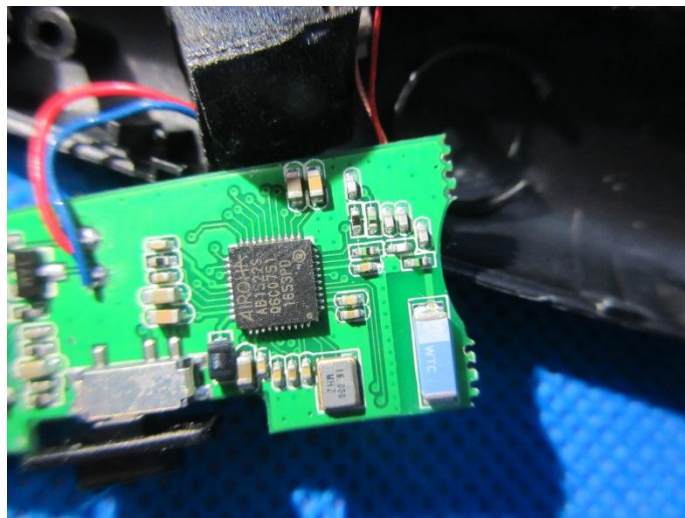

.....End of Report.....